

Stainless One-touch Fittings

Series KG

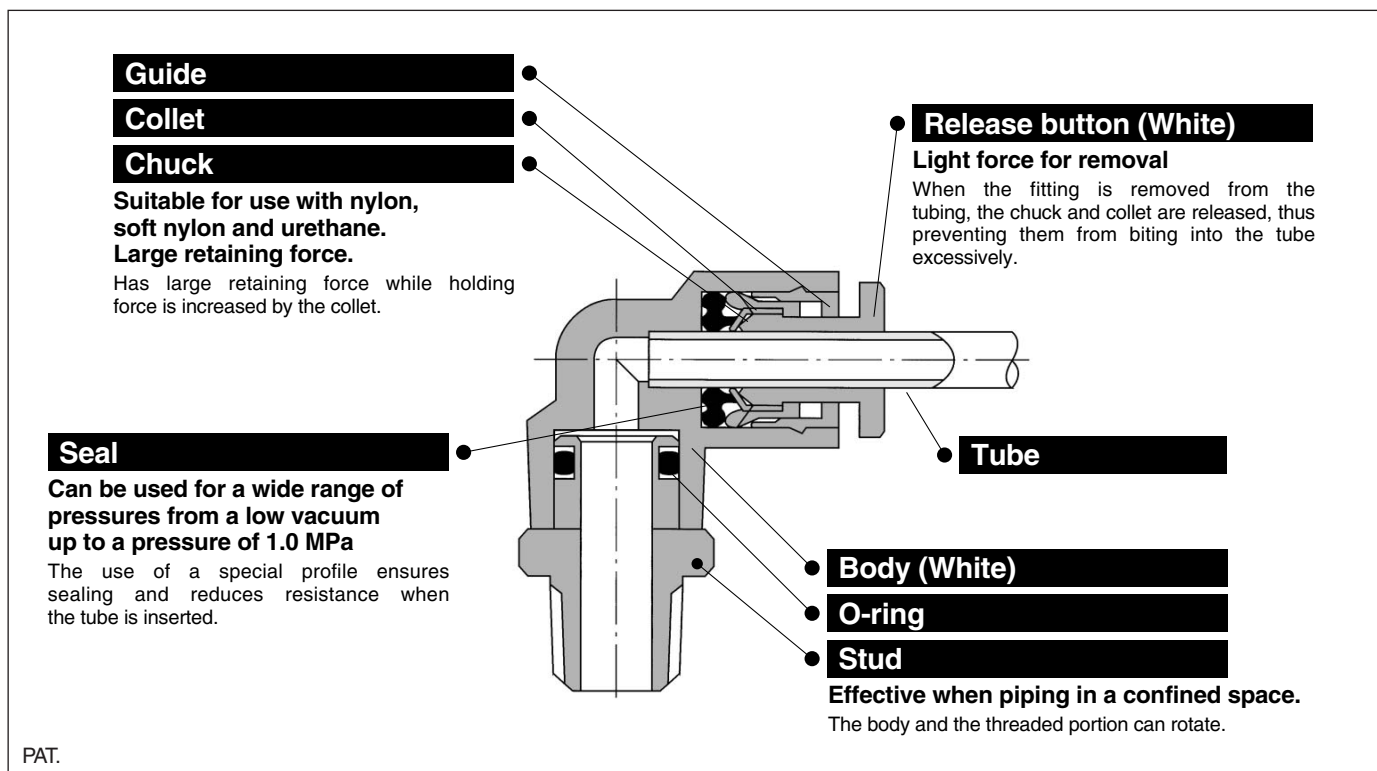

Stainless specifications applicable to corrosive environments

Stainless steel 303 adopted for metal elements

Suitable for use in CRT production lines where contact with copper must be avoided, food processing machines where water or salt water splashes and clean room where discoloration of copper material and corrosion must be avoided.



Applicable Tubing

Tubing material	Nylon, Soft nylon, Polyurethane
Tubing O.D.	ø4, ø6, ø8, ø10, ø12, ø16











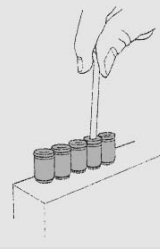

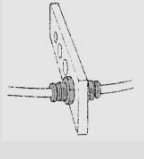
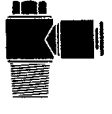
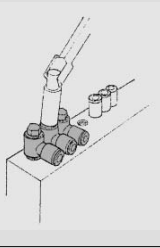

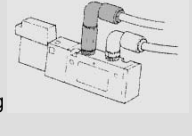

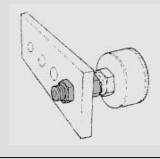



Specifications

Fluid	Air/Water ⁽¹⁾	
Maximum operating pressure	1.0 MPa	
Operating vacuum pressure	-100 kPa	
Proof pressure	3.0 MPa	
Ambient and fluid temperature	-5 to 60°C (Water: 0 to 40°C) (No freezing)	
Thread	Mounting section	JIS B 0203 (Taper thread for piping)
	Nut section	JIS B 0211 Class 2 (Metric fine thread)
Seal (Thread portion)	With seal or none ⁽²⁾	

Note 1) Applicable for general industrial water. Please consult with SMC if using for other kinds of fluid. Also, the surge pressure must be under the maximum operating pressure.
Note 2) Suffix "S" to the part number, if w/ seal is desired.

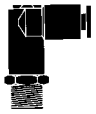
Principal Parts Material

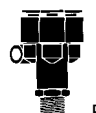
Body	Stainless steel 303, PBT
Stud	Stainless steel 303
Chuck	Stainless steel 304
Guide	Stainless steel 304, Stainless steel 303, POM
Collet, Release button	POM
Seal, O-ring	NBR

Model			
Hex. socket head male connector			
KGS	P. 10	 <p>Internal hex. allows thread connection by using an allen wrench for confined spaces.</p> 	Bulkhead union KGE P. 18  <p>Use to connect tubes through a panel.</p> 
Universal male elbow			
KGV	P. 12	 <p>Universal male elbow allows thread connection by using a socket wrench for confined spaces.</p> 	Extended male elbow KGW P. 14  <p>Basically, it is used together with male elbow. Different point is that it is used for fittings to avoid from interfering with each other by making the piping two-level.</p> 
Male connector			
KGH	P. 10	 <p>Use to pipe in the same direction from female thread. Most general style.</p>	Bulkhead connector KGE P. 18  <p>Use to connect male thread and tube through a panel.</p> 
Male elbow			
KGL	P. 11	 <p>Use to pipe at right angles to female thread. Most general style.</p>	Male branch tee KGT P. 14  <p>Use to branch line from female thread in both 90° directions.</p>
Female connector			
KGF	P. 11	 <p>Use to pipe from male thread such as pressure gauge.</p>	Union tee KGT P. 14  <p>Use to connect tubes in both 90° directions.</p>
Union elbow			
KGL	P. 13	 <p>Use to connect tubes at right angles.</p>	Different diameter tee KGT P. 15  <p>Use to connect tubes with size down in both 90° directions.</p>
Plug-in elbow			
KGL	P. 13	 <p>Use to change by 90° in a tube fetching direction from One-touch fittings.</p>	Male run tee KGY P. 15  <p>Use to branch line in the same direction from female thread and in 90° direction.</p>
Different diameter straight			
KGH	P. 11	 <p>Use to connect different sized tubes.</p>	Different dia. double union "Y" KGUD P. 17  <p>Use to four-branch line in the same direction.</p>
Male branch connector			
KGLU	P. 12	 <p>Use to branch line at right angles to female thread.</p>	Union "Y" KGU P. 17  <p>Use to branch line in the same direction.</p>
Delta union			
KGD	P. 16	 <p>Use to branch line in tripple 90° direction.</p>	Delta branch KGUD P. 16  <p>Use to four-branch line in the same direction from female thread.</p>
Branch union elbow			
KGLU	P. 13	 <p>Use to branch line at right angles.</p>	

- K
- M
- H
- D
- MS
- T
- VMG

Series KG

Model

Different dia. union "Y"



P. 17

Use to connect tubes in the same direction, reducing the size of tubes.

Plug-in reducer



P. 17

Use to change size of One-touch fittings.

Tube cap



P. 18

Use to plug unused tubing.

Branch



P. 16

Use to branch line in the same direction from the female thread.

Male Connector: KGH

<M5>

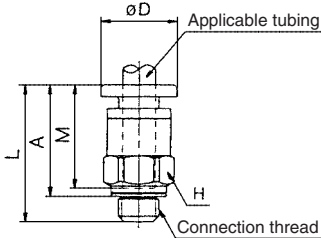

<R>

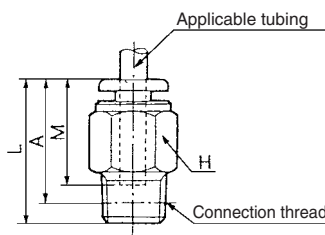

Applicable tubing O.D. (mm)	Connection thread R	Model	H (width across flats)	øD ⁽¹⁾	L	A*	M	Effective area ⁽²⁾ (mm ²)		Weight (g)
								Nylon	Urethane	
4	M5 x 0.8	KGH04-M5	8	8	17	14	13	4	4	2.4
	1/8	KGH04-01	10	—	22	18	16	5.6	4	9
	1/4	KGH04-02	14	—	19.5	13.5				16
6	M5 x 0.8	KGH06-M5	10	10	18.5	15	14	4	4	3.4
	1/8	KGH06-01	12	—	22.5	18.5	17	13.1	10.4	16
	1/4	KGH06-02	14	—	23	17				14
	3/8	KGH06-03	17	—	22	15.5				27
8	1/8	KGH08-01	14	—	28	24	18.5	26.1	18.0	21
	1/4	KGH08-02			26.5	20.5				19
	3/8	KGH08-03	17		—	22				15.5
10	1/8	KGH10-01	17	—	30	26	21	41.5	29.5	19
	1/4	KGH10-02			33.5	27.5				30
	3/8	KGH10-03	29		22.5	30				
	1/2	KGH10-04	22		—	27				19
12	1/4	KGH12-02	19	—	34.5	28.5	22	58.3	46.1	42
	3/8	KGH12-03			—	23.5				34
	1/2	KGH12-04	22		—	30				22
16	3/8	KGH16-03	24	—	39.5	32	24	81	(81)	61
	1/2	KGH16-04			35.5	26.5				113

* Reference dimensions after R thread installation.
 Note 1) øD: Max. diameter
 Note 2) (): Values for nylon.

Hexagon Socket Head Male Connector: KGS

<M5>

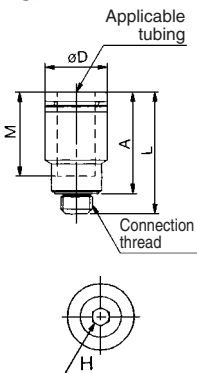

<R>

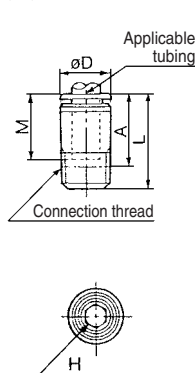

Applicable tubing O.D. (mm)	Connection thread R	Model	H (width across flats)	øD ^{Note)}	L	A*	M	Effective area (mm ²)		Weight (g)
								Nylon	Urethane	
4	M5 x 0.8	KGS04-M5	2.5	9.5	19	15.5	13	4	4	2.6
	1/8	KGS04-01	3	9.8	23	19	16	4.1	3.6	8
6	M5 x 0.8	KGS06-M5	2.5	11.5	20	16.5	14	4	4	3.2
	1/8	KGS06-01	4	11.8	24	20	17	10.0	9.9	9
	1/4	KGS06-02								13.8
8	1/8	KGS08-01	5	14	28	24	18.5	23.3	16.2	12
	1/4	KGS08-02	6		25.5	19.5				11
	3/8	KGS08-03			17	27.5				21
10	1/8	KGS10-01	5	17	30	26	21	39.0	26.6	18
	1/4	KGS10-02			8	27.5				21.5
	3/8	KGS10-03	8			21				21
	1/2	KGS10-04			22	—				28
12	1/4	KGS12-02	8	19	33.5	27.5	22	60.0	44.5	23
	3/8	KGS12-03			10	29				22.5
	1/2	KGS12-04	22			—				28

* Reference dimensions after R thread installation.
 Note) øD: Max. diameter



Female Connector: KGF

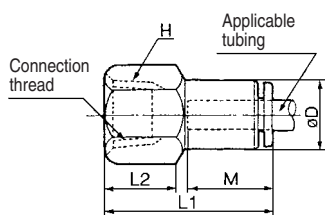

Applicable tubing O.D. (mm)	Connection thread Rc	Model	H (width across flats)	Note) ϕD	L1	L2	M	Effective area (mm ²)		Weight (g)
								Nylon	Urethane	
4	1/8	KGF04-01	14	10	27	11	16	5.6	4	15
	1/4	KGF04-02	17		31	14				23
6	1/8	KGF06-01	14	12	27.5	11	17	13.1	10.4	15
	1/4	KGF06-02	17		31	13				22
	3/8	KGF06-03	19		33.5	15				25
8	1/8	KGF08-01	14	14	29	11	18.5	26.1	18.0	17
	1/4	KGF08-02	17		32.5	13				24
	3/8	KGF08-03	19		33.5	14				24
10	1/4	KGF10-02	17	17	34.5	14	21	41.5	29.5	27
	3/8	KGF10-03	19		36.5	15				30
12	1/4	KGF12-02	19	19	35	14	22	58.3	46.1	36
	3/8	KGF12-03			37					31
	1/2	KGF12-04	24		41	18				52

Note) ϕD : Max. diameter

Straight Union: KGH

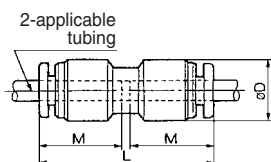

Applicable tubing O.D. (mm)	Model	Note) ϕD	L	M	Effective area (mm ²)		Weight (g)
					Nylon	Urethane	
4	KGH04-00	10.4	32.5	16	5.6	4	3
6	KGH06-00	12.8	34.5	17	13.1	10.4	4
8	KGH08-00	15.2	38.5	18.5	26.1	18.0	6
10	KGH10-00	18.5	42.5	21	41.5	29.5	11
12	KGH12-00	20.9	44.5	22	58.3	46.1	14

Note) ϕD : Max. diameter

Different Diameter Straight: KGH

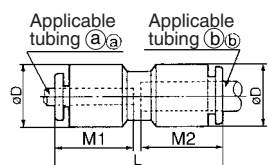

Applicable tubing O.D. (mm)		Model	Note) ϕD	L	M1	M2	Effective area (mm ²)		Weight (g)
(a)	(b)						Nylon	Urethane	
4	6	KGH04-06	12.8	34.5	16	17	5.6	4	5
6	8	KGH06-08	15.2	38.5	17	18.5	13.1	10.4	6
8	10	KGH08-10	18.5	42	18.5	21	26.1	18.0	11
10	12	KGH10-12	20.9	44.5	21	22	41.5	29.5	14

Note) ϕD : Max. diameter

Male Elbow: KGL

<M5>

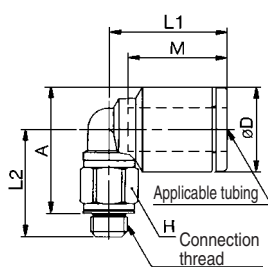

<R>

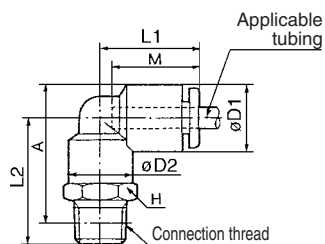

Applicable tubing O.D. (mm)	Connection thread R	Model	H (width across flats)	(1) $\phi D1$	$\phi D2$	L1	L2	A*	M	Effective area (2) mm ²		Weight (g)
										Nylon	Urethane	
4	M5 x 0.8	KGL04-M5	7	9.5	—	16	13.5	15	13	3.5	3.5	2.7
		KGL04-01	10	10.4	10	18	22	23	16	4.2	4.2	10
		KGL04-02	14			26	25	19				
6	M5 x 0.8	KGL06-M5	7	11.5	—	16	14.5	17	14	3.5	3.5	3.1
		KGL06-01	10	12.8	10	20	23	25.5	17	11.4	9.0	12
		KGL06-02	14			27	27.5	10				
		KGL06-03	17			29	29	33				
KGL06-04	19	31	31			33						
8	1/8	KGL08-01	12	15.2	12	23	24.5	28	18.5	21.6	14.9	13
		KGL08-02	14				28.5	30				21
		KGL08-03	17				30.5	31.5				35
10	1/8	KGL10-01	14	17	18.5	17	27	32	21	21.6	14.9	25
		KGL10-02	17				30	33				26
		KGL10-03	19				32	34.5				36
		KGL10-04	22				36	37				63
12	1/4	KGL12-02	17	20.9	17	28.5	31	35.5	22	50.2	39.7	28
		KGL12-03	19				33	37				38
		KGL12-04	22				37	39.5				65
16	3/8	KGL16-03	22	26.5	20.9	34	38	44.5	24	71	(71)	101
		KGL16-04	24				41	46		100	(84)	105

* Reference dimensions after R thread installation.
 Note 1) $\phi D1$: Max. diameter
 Note 2) (): Values for nylon.

Series KG

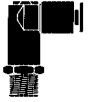

Male Branch Connector: KGLU

<M5>

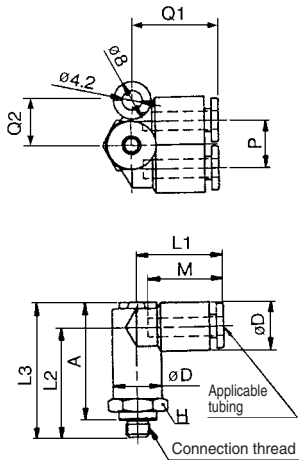

Applicable tubing O.D. (mm)	Connection thread R	Model	H (width across flats)	Note) ϕD	L1	L2	L3	A*	M	P	Q1	Q2	Effective area (mm ²)		Weight (g)
													Nylon	Urethane	
4	M5 x 0.8	KGLU04-M5	11	10.4	18.5	24	29.5	25.5	16	10.4	18.5	10	4.3	4.1	10
	1/8	KGLU04-01	14			26.5	32	27.5					6.0	4.1	12
	1/4	KGLU04-02	14			30.5	36	30					21		
6	M5 x 0.8	KGLU06-M5	13	12.8	21	26.5	33	29.5	17	12.8	20.5	12	4.3	4.3	13
	1/8	KGLU06-01	14			29.5	36	32					15		
	1/4	KGLU06-02	14			33	39.5	33.5					22		
	3/8	KGLU06-03	17			35	41.5	35						35	
8	1/8	KGLU08-01	17	15.2	24	34	41.5	38	18.5	15.2	24.5	14	26.3	18.2	27
	1/4	KGLU08-02	17			37	44.5	38.5					35		
	3/8	KGLU08-03	17			38	45.5	39					35		
10	1/4	KGLU10-02	19	18.5	27	40	49.5	43.5	21	18.5	28	16	40.8	29.0	41
	3/8	KGLU10-03	22			41	50.5	44					42		
	1/2	KGLU10-04	22			44.5	54	45.5					64		
12	1/4	KGLU12-02	22	20.9	29	42.5	53	47	22	20.9	30	18	57.2	45.2	57
	3/8	KGLU12-03	22			43.5	54	47.5					58		
	1/2	KGLU12-04	22			46.5	57	49					65		

* Reference dimensions after R thread installation.
Note) ϕD : Max. diameter

<R>

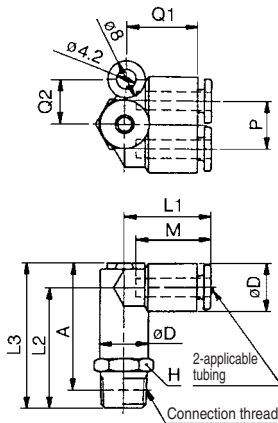

Universal Male Elbow: KGV

<M5>

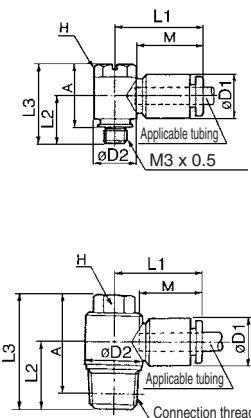

Applicable tubing O.D. (mm)	Connection thread R	Model	H (width across flats)	Note) $\phi D1$	$\phi D2$	L1	L2	L3	A*	M	Effective area (mm ²)		Weight (g)
											Nylon	Urethane	
4	M5 x 0.8	KGV04-M5	8	10.4	9.8	20.5	11	18.5	15	16	2.9	2.9	6
	1/8	KGV04-01			13.4	22	14.5	26.5	22.5		14		
6	M5 x 0.8	KGV06-M5	8	12.8	9.8	23.5	12	18.5	15	17	3.8	3.8	7
	1/8	KGV06-01			10	13.4	24	14.5	26.5		22.5	15	
	1/4	KGV06-02			10	15.3	23.5	18.5	31		25	26	
8	1/8	KGV08-01	12	15.2	17.6	28.5	15.5	28.5	24.5	18.5	16	11.2	24
	1/4	KGV08-02			14	18.5	31.5	25.5	30		30		
	3/8	KGV08-03			14	20.6	27.5	20.5	36.5		30	47	
10	1/4	KGV10-02	14	18.5	19.5	35.5	29.5	21	27	20.3	40		
	3/8	KGV10-03			20.5	36.5	30				49		
12	3/8	KGV12-03	17	20.9	22	38.5	32	22	39	30.8	63		
	1/2	KGV12-04			25	41.5	33.5				80		

* Reference dimensions after R thread installation.
Note) $\phi D1$: Max. diameter



Union Elbow: KGL

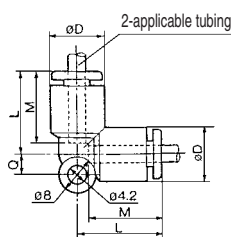

Applicable tubing O.D. (mm)	Model	$\phi D^{(1)}$	L	Q	M2	Effective area (mm ²) ⁽²⁾		Weight (g)
						Nylon	Urethane	
4	KGL04-00	10.4	18	4.5	16	4.2	4.2	6
6	KGL06-00	12.8	20	5.3	17	11.4	9.0	6
8	KGL08-00	15.2	23	6	18.5	21.6	14.9	10
10	KGL10-00	18.2	26.5	6.8	21	35.2	25.0	17
12	KGL12-00	20.9	28.5	7.5	22	50.2	39.7	21
16	KGL16-00	26.5	34	10	25	100	(84)	29

Note 1) ϕD : Max. diameter
 Note 2) (): Values for nylon.

K

M

H

D

MS

T

VMG

Branch Union Elbow: KGLU

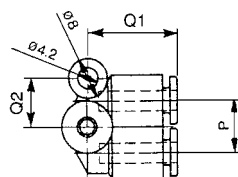

Applicable tubing O.D. (mm)	Model	Note) ϕD	L1	L2	Q1	Q2	M	P	Effective area (mm ²)		Weight (g)
									Nylon	Urethane	
4	KGLU04-00	10.4	18.5	24	18.5	10	16	10.4	6.0	4.1	6
6	KGLU06-00	12.8	21	27.5	20.5	12	17	12.8	13.9	11.0	8
8	KGLU08-00	15.2	24	32	24.5	14	18.5	15.2	26.3	18.2	15
10	KGLU10-00	18.5	27	36.5	28	16	21	18.5	40.8	29.0	25
12	KGLU12-00	20.9	29	40	30	18	22	20.9	57.2	45.2	32

Note) ϕD : Max. diameter

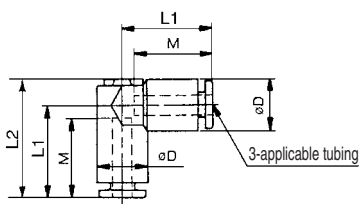

Plug-in Elbow: KGL

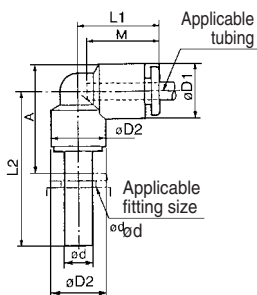

Applicable tube O.D. mm	Applicable fitting size ϕd	Model	Note) $\phi D1$	$\phi D2$	L1	L2	A	M	Effective area (mm ²)		Weight (g)
									Nylon	Urethane	
4	4	KGL04-99	10.4	8	18	25	14.5	16	4.2	4.2	8
6	6	KGL06-99	12.8	10	20	27.5	17	17	11.4	9.0	10
8	8	KGL08-99	15.2	12	22.5	31.5	21	18.5	21.6	14.9	14
10	10	KGL10-99	18.5	14	25.5	35.5	23.5	21	35.2	25.0	25
12	12	KGL12-99	20.9	16	27	37.5	26	22	50.2	39.7	28

Note) $\phi D1$: Max. diameter

Series KG



Extended Male Elbow: KGW

<M5>

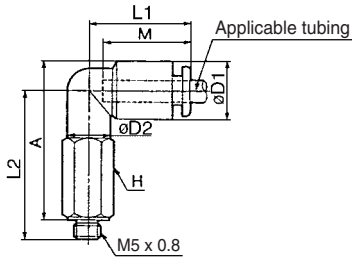

<R>

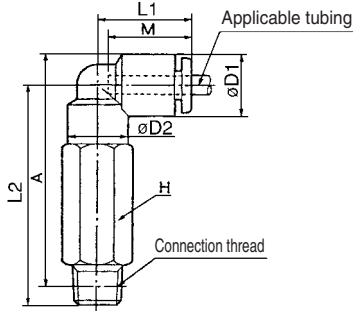

Applicable tubing O.D. (mm)	Connection thread R	Model	H (width across flats)	Note) $\phi D1$	$\phi D2$	L1	L2	A*	M	Effective area (mm ²)		Weight (g)		
										Nylon	Urethane			
4	M5 x 0.8	KGW04-M5	8	10.4	8	18	30	32	16	3.0	3.0	11		
	1/8	KGW04-01	10							4.0	4.0	23		
	1/4	KGW04-02	14							43.5	42.5	38		
6	M5 x 0.8	KGW06-M5	8	12.8	8	20	30.5	33.5	17	3.0	3.0	11		
	1/8	KGW06-01	10							4.0	4.0	26		
	1/4	KGW06-02	14							46	46.5	41		
	3/8	KGW06-03	17							48	48	67		
8	1/8	KGW08-01	12	15.2	12	23	43.5	47	18.5	20.5	14.2	30		
	1/4	KGW08-02	14									49.5	51	47
	3/8	KGW08-03	17									51.5	52.5	74
10	1/4	KGW10-02	17	18.5	17	26.5	56.5	59.5	21	33.5	23.8	66		
	3/8	KGW10-03	17									58.5	61	76
	1/2	KGW10-04	22									65	66	145
12	1/4	KGW12-02	17	20.9	17	28.5	57.5	62	22	47.7	37.7	68		
	3/8	KGW12-03	17									59.5	63.5	78
	1/2	KGW12-04	22									66	68.5	147

* Reference dimensions after R thread installation.
Note) $\phi D1$: Max. diameter



Male Branch Tee: KGT

<M5>

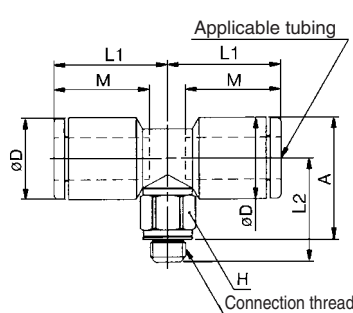

<R>

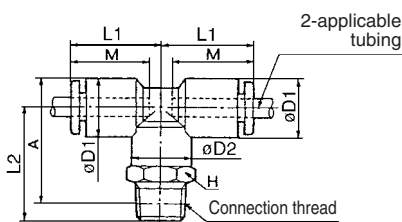

Applicable tubing O.D. (mm)	Connection thread R	Model	H (width across flats)	Note 1) $\phi D1$	$\phi D2$	L1	L2	A*	M	Effective area (2) (mm ²)		Weight (g)
										Nylon	Urethane	
4	M5 x 0.8	KGT04-M5	7	9.5	—	15.5	14	15.5	13	4.3	4.3	3.5
	1/8	KGT04-01	10	10.4	10	18	22	23	16	6.0	4.1	13
	1/4	KGT04-02	14	—	—	—	26	25	—	—	—	19
6	M5 x 0.8	KGT06-M5	7	11.5	—	16	15	17.5	14	4.3	4.3	4.2
	1/8	KGT06-01	10	12.8	10	20	23	25.5	17	13.9	11.0	12
	1/4	KGT06-02	14				27	27.5				20
	3/8	KGT06-03	17				29	29				34
1/8	KGT08-01	12	24.5				28	14				
8	1/4	KGT08-02	14	15.2	12	23	28.5	30	18.5	26.3	18.2	22
	3/8	KGT08-03	17				30.5	31.5				36
	1/8	KGT10-01	12				27	32				31
10	1/4	KGT10-02	17	18.5	17	26.5	30	33	21	40.8	29.0	29
	3/8	KGT10-03	17				32	34.5				39
	1/2	KGT10-04	22				36	37				66
12	1/4	KGT12-02	17	20.9	17	28.5	31	35.5	22	57.2	45.2	31
	3/8	KGT12-03	17				33	37				41
	1/2	KGT12-04	22				37	39.5				68
16	3/8	KGT16-03	22	26.5	20.9	34	38	44.5	25	71	(71)	112
	1/2	KGT16-04	22				40.5	46		100	(100)	116

* Reference dimensions after R thread installation.
Note 1) $\phi D1$: Max. diameter
Note 2) (): Values for soft nylon



Union Tee: KGT

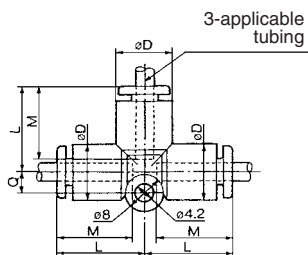

Applicable tubing O.D. (mm)	Model	ϕD (1)	L	Q	M	Effective area (2) (mm ²)		Weight (g)
						Nylon	Urethane	
4	KGT04-00	10.4	18	4.5	16	6.4	4.4	7
6	KGT06-00	12.8	20	5.3	17	13.4	10.6	10
8	KGT08-00	15.2	23	6	18.5	25.6	17.7	15
10	KGT10-00	18.5	26.5	6.8	21	40	28.4	25
12	KGT12-00	20.9	28.5	7.5	22	57.4	45.4	29
16	KGT16-00	26.5	34	10	25	100	(84)	40

Note 1) ϕD : Max. diameter
Note 2) (): Values for nylon.



Different Diameter Tee: KGT

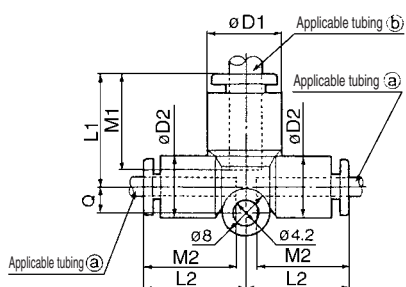

Applicable tubing O.D. (mm)		Model	Note)	$\phi D1$	$\phi D2$	L1	L2	Q	M1	M2	Effective area (mm ²)		Weight (g)
(a)	(b)		$\phi D1$								Nylon	Urethane	
4	6	KGT04-06	12.8	10.4	19.5	18	4.5	17	16	7.1	6.5	5	
6	8	KGT06-08	15.2	12.8	22.5	20	5.3	18.5	17	16.4	16.4	8	
8	10	KGT08-10	18.5	15.2	26.5	23	6	21	18.5	36	27.2	14	
10	12	KGT10-12	20.9	18.5	28.5	26.5	6.8	22	21	56	44.5	21	

Note) $\phi D1$: Max. diameter

Male Run Tee: KGY

<M5>

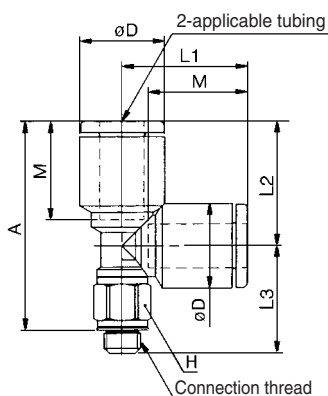

<R>

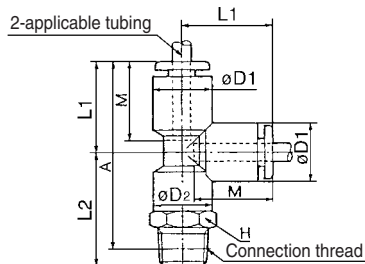

Applicable tubing O.D. (mm)	Connection thread R	Model	H (width across flats)	Note) $\phi D1$	$\phi D2$	L1	L2	L3	A*	M	Effective area (mm ²)		Weight (g)
											Nylon	Urethane	
4	M5 x 0.8	KGY04-M5	7	9.5	—	16	13.5	15	25.5	13	4.6	4.6	3.5
	1/8	KGY04-01	10	10.4	10	18	22	—	36	16	6.4	4.4	13
	1/4	KGY04-02	14	—	—	—	26	—	38	—	—	—	19
6	M5 x 0.8	KGY06-M5	7	11.5	—	17.5	14.5	17.5	29	14	4.6	4.6	4.3
	1/8	KGY06-01	10	—	—	—	23	—	39	—	—	—	12
	1/4	KGY06-02	14	12.8	10	20	27	—	41	17	13.4	10.6	20
8	3/8	KGY06-03	17	—	—	—	29	—	42.5	—	—	—	34
	1/8	KGY08-01	12	—	—	—	24.5	—	43.5	17	13.4	10.6	14
	1/4	KGY08-02	14	15.2	12	23	28.5	—	45.5	18.5	25.6	17.7	22
10	3/8	KGY08-03	17	—	—	—	30.5	—	47	—	—	—	36
	1/8	KGY10-01	17	—	—	—	27	—	49.5	—	—	—	31
	1/4	KGY10-02	17	18.5	17	26.5	30	—	50.5	21	40.0	28.4	29
12	3/8	KGY10-03	22	—	—	—	32	—	52	—	—	—	39
	1/2	KGY10-04	22	—	—	—	36	—	54.5	—	—	—	66
	1/4	KGY12-02	17	—	—	—	31	—	53.5	—	—	—	31
16	3/8	KGY12-03	22	20.9	17	28.5	33	—	55	22	57.4	45.4	41
	1/2	KGY12-04	22	—	—	—	37	—	57.5	—	—	—	68
	3/8	KGY16-03	22	26.5	20.9	34	38	—	65.5	25	81	(81)	112
	1/2	KGY16-04	22	—	—	—	41	—	67	—	113	(113)	116

* Reference dimensions after R thread installation.
 Note 1) $\phi D1$: Max. diameter
 Note 2) (): Values for nylon.

Male Delta Union: KGD

<M5>

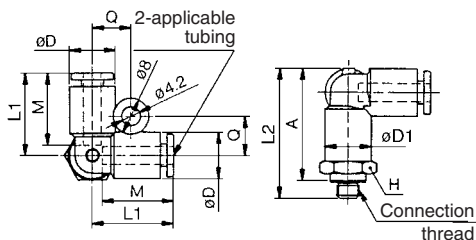

<R>

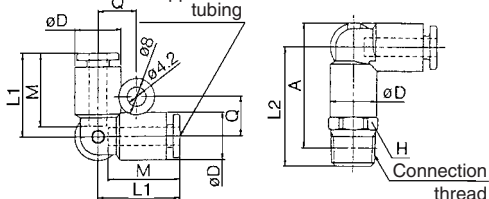

Applicable tubing O.D. (mm)	Connection thread R	Model	H (width across flats)	Note) ϕD	L1	L2	A*	M	Q	Effective area (mm ²)		Weight (g)
										Nylon	Urethane	
4	M5 x 0.8	KGD04-M5	11	10.4	18.5	24	25.5	16	8.7	4.3	4.3	10
	1/8	KGD04-01	14	—	—	26.5	27.5	—	—	6.0	6.0	12
	1/4	KGD04-02	14	—	—	30.5	30	—	—	—	—	21
6	M5 x 0.8	KGD06-M5	13	12.8	20.5	26	28.5	17	9.9	4.3	4.3	12
	1/8	KGD06-01	14	—	—	29	31.5	—	—	13.9	11.0	14
	1/4	KGD06-02	14	—	—	32.5	33	—	—	—	—	21
8	3/8	KGD06-03	17	—	—	34.5	34.5	—	—	—	—	34
	1/8	KGD08-01	17	15.2	23.5	33.5	37	18.5	11.1	26.3	18.2	26
	1/4	KGD08-02	17	—	—	36.5	38	—	—	—	—	35
10	3/8	KGD08-03	17	—	—	37.5	38.5	—	—	—	—	39
	1/8	KGD10-01	19	18.5	26.5	39.5	43	21	12.8	40.8	29.0	40
	1/4	KGD10-02	22	—	—	44	45	—	—	—	—	62
12	3/8	KGD10-03	22	—	—	40.5	43.5	—	—	—	—	40
	1/2	KGD10-04	22	—	—	44	45	—	—	—	—	62
	1/4	KGD12-02	22	20.9	28.5	42	46.5	22	13.9	57.2	45.2	56
	3/8	KGD12-03	22	—	—	43	47	—	—	—	—	56
	1/2	KGD12-04	22	—	—	46	48.5	—	—	—	—	63

* Reference dimensions after R thread installation.
 Note) ϕD : Max. diameter

Series KG



Delta Union: KGD

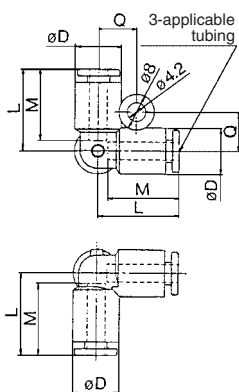

Applicable tubing O.D. (mm)	Model	Note) øD	L	Q	M	Effective area (mm ²)		Weight (g)
						Nylon	Urethane	
4	KGD04-00	10.4	18.5	8.7	16	6.0	4.1	5
6	KGD06-00	12.8	20.5	9.9	17	13.9	11.0	7
8	KGD08-00	15.2	23.5	11.1	18.5	26.3	18.2	11
10	KGD10-00	18.5	26.5	12.8	21	40.8	29.0	19
12	KGD12-00	20.9	28.5	13.9	22	57.2	45.2	24



Note) øD: Max. diameter



Branch "Y": KGU

<M5>

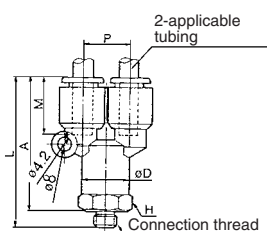

<R>

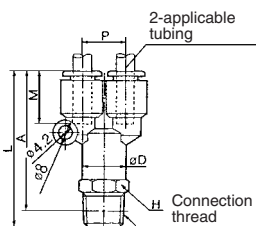

Applicable tubing O.D. (mm)	Connection thread R	Model	H (width across flats)	Note) øD	L	P	A*	M	Effective area (mm ²)		Weight (g)	
									Nylon	Urethane		
4	M5 x 0.8	KGU04-M5	11	10.4	39.5	10.4	36	16	2.2	2.2	4	
	1/8	KGU04-01							4.2	4.2	11	
	1/4	KGU04-02							14	46	40	20
6	M5 x 0.8	KGU06-M5	13	12.8	42.5	12.8	39	17	2.2	2.2	12	
	1/8	KGU06-01							11			
	1/4	KGU06-02							14	49	43	21
	3/8	KGU06-03							17	51	44.5	34
8	1/8	KGU08-01	17	15.2	52.5	15.2	48.5	18.5	25.6	17.7	15	
	1/4	KGU08-02									23	
	3/8	KGU08-03									35	
10	1/4	KGU10-02	19	18.5	61	18.5	55	21	40	28.4	30	
	3/8	KGU10-03									40	
	1/2	KGU10-04									22	65
12	1/4	KGU12-02	22	20.9	64.5	20.9	58.5	22	57.4	45.4	32	
	3/8	KGU12-03									40	
	1/2	KGU12-04									65	



* Reference dimensions after R thread installation.
Note) øD: Max. diameter



Delta Branch: KGUD

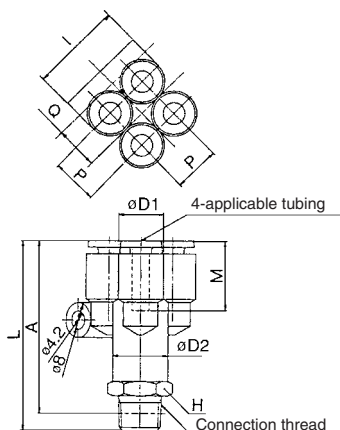

Applicable tubing O.D. (mm)	Connection thread R	Model	H (width across flats)	Note) øD1	øD2	L	I	A*	Q	M	P	Effective area (mm ²)		Weight (g)
												Nylon	Urethane	
4	1/8	KGUD04-01	13	10.4	12.8	43.5	21	39.5	9.7	16	10.4	4.2	4.2	17
	1/4	KGUD04-02	14											47
6	1/8	KGUD06-01	17	12.8	15.2	50.5	26	46.5	11.7	17	12.8	13.4	10.6	29
	1/4	KGUD06-02												



* Reference dimensions after R thread installation.
Note) øD1: Max. diameter



Union "Y": KGU

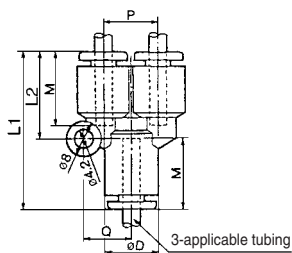

Applicable tubing O.D. (mm)	Model	Note) ϕD	L1	L2	P	Q	M	Effective area (mm ²)		Weight (g)
								Nylon	Urethane	
4	KGU04-00	10.4	34	18	10.4	9.7	16	4.2	4.2	7
6	KGU06-00	12.8	37	20	12.8	11.7	17	13.4	10.6	9
8	KGU08-00	15.2	42.5	24.5	15.2	13.7	18.5	25.6	17.7	11
10	KGU10-00	18.5	48	27.5	18.5	16.1	21	40	28.4	16
12	KGU12-00	20.9	51	30	20.9	18.1	22	57.4	45.4	23

Note) ϕD : Max. diameter

Different Diameter Union "Y": KGU

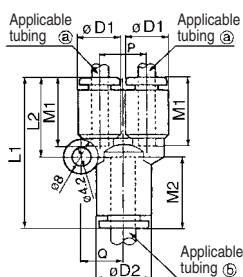

Applicable tubing O.D. (mm)		Model	Note) $\phi D1$	Note) $\phi D2$	L1	L2	P	Q	M1	M2	Effective area (mm ²)		Weight (g)
a	b										Nylon	Urethane	
4	6	KGU04-06	10.4	12.8	35	18	10.4	9.7	16	17	4.2	4.2	6
6	8	KGU06-08	12.8	15.2	39.5	20	12.8	11.7	17	18.5	13.4	10.6	11
8	10	KGU08-10	15.2	18.5	45	24.5	15.2	13.7	18.5	21	25.6	17.7	18
10	12	KGU10-12	18.5	20.9	49	27.5	18.5	16.1	21	22	40	28.4	27

Note) $\phi D1, \phi D2$: Max. diameter

Different Diameter Double Union "Y": KGUD

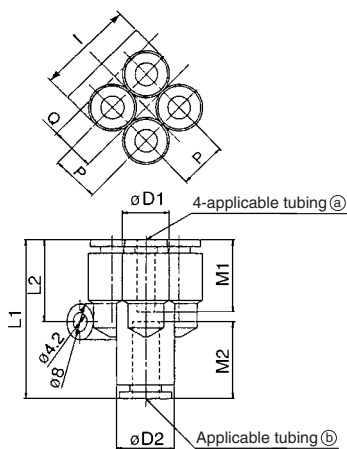

Applicable tubing O.D. (mm)		Model	Note) $\phi D1$	Note) $\phi D2$	L1	L2	P	I	Q	M1	M2	Effective area (mm ²)		Weight (g)
a	b											Nylon	Urethane	
4	6	KGUD04-06	10.4	12.8	35.5	18.2	10.4	21	9.7	16	17	4.2	4.2	10
6	8	KGUD06-08	12.8	15.2	40.5	20.3	12.8	26	11.7	17	18.5	13.4	10.6	17

Note) $\phi D1, \phi D2$: Max. diameter

Plug-in Reducer: KGR

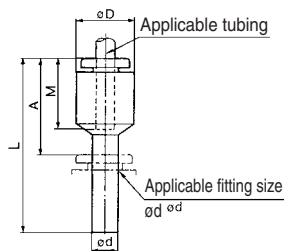

Applicable tubing O.D. (mm)	Applicable fitting size ϕd	Model	ϕD ⁽¹⁾	L	A	M	Effective area ⁽²⁾ (mm ²)		Weight (g)
							Nylon	Urethane	
4	6	KGR04-06	10.4	34.5	17.5	16	5.6	4	1.8
	8	KGR04-08		36.5	18				2.0
	10	KGR04-10		39.5	18.5				3.3
6	4	KGR06-04	12.8	37	21	17	13.1	10.4	3
	8	KGR06-08		37	18.5				2.5
	10	KGR06-10		39.5	20				3
8	10	KGR08-10	15.2	41	20	18.5	26.1	18.0	4.0
	12	KGR08-12		42	20				4.6
10	12	KGR10-12	18.5	44.5	23	21	41.5	(29.5)	33
	16	KGR10-16	20.9	50.5	25.5				42
12	16	KGR12-16	20.9	50.5	25.5	22	58.3	(46.1)	37

Note 1) ϕD : Max. diameter
Note 2) (): Values for nylon.

Series KG



Bulkhead Union: KGE

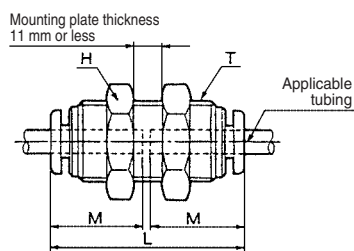

Applicable tubing O.D. (mm)	Model	T (M)	H (width across flats)	L	Mounting hole	M	Effective area ⁽¹⁾ (mm ²)		Weight (g)
							Nylon	Urethane	
4	KGE04-00	M12 x 1	14	32.5	13	16	5.6	4	26
6	KGE06-00	M14 x 1	17	34.5	15	17	13.1	10.4	33
8	KGE08-00	M16 x 1	19	38	17	18.5	26.1	18.0	52
10	KGE10-00	M20 x 1	24	42.5	21	21	41.5	29.5	70
12	KGE12-00	M22 x 1	27	44	23	22	58.3	46.1	90
16	KGE16-00	M28 x 1.5	32	51	29	25	113	(96)	115

Note) Dimensions in () are the case of soft nylon tube.



Bulkhead Connector: KGE

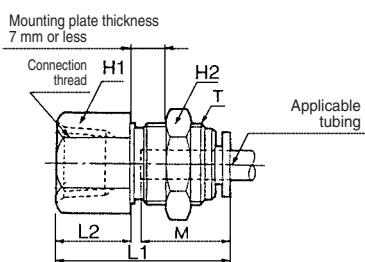

Applicable tubing O.D. (mm)	Connection thread Rc	Model	T (M)	H1 (width across flats)	H2 (width across flats)	L1	L2	Mounting hole	M	Effective area ⁽¹⁾ (mm ²)		Weight (g)			
										Nylon	Urethane				
4	1/8	KGE04-01	M12 x 1	14	14	27.5	11	13	16	5.6	4	16			
	1/4	KGE04-02		17		31	15					35			
6	1/8	KGE06-01	M14 x 1	17	17	31.5	15	15	17	13.1	10.4	30			
	3/8	KGE06-03										19	33.5	17	29
	1/8	KGE08-01										M16 x 1	17	27.5	7.5
1/4	KGE08-02	19	33	13	27										
8	3/8	KGE08-03	M16 x 1	19	19	35	15	17	18.5	26.1	18.0	48			
	1/8	KGE10-02										22	24	34.5	12.5
10	1/4	KGE10-03	M20 x 1	22	24	36.5	14	21	21	41.5	29.5	67			
	3/8	KGE12-03										M22 x 1	24	27	37
12	1/2	KGE12-04	M22 x 1	24	27	41	18	23	22	58.3	46.1		59		
	3/8	KGE16-03										M28 x 1.5	30	32	40
16	1/2	KGE16-04	M28 x 1.5	30	32	44	18	29	25	96	(96)		132		
	3/8											113			

Note) Dimensions in () are the case of soft nylon tube.

Tube Cap: KGC

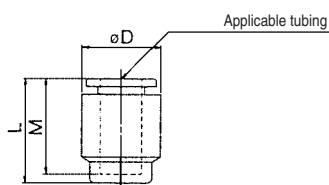

Applicable tubing O.D. (mm)	Model	Note) øD	L	M	Weight (g)
4	KGC04-00	10.4	17	16	3
6	KGC06-00	12.8	18.5	17	3
8	KGC08-00	15.2	20.5	18.5	4
10	KGC10-00	18.5	23	21	6
12	KGC12-00	20.9	24	22	8
16	KGC16-00	26.5	28	25	13

Note) øD: Max. diameter



Safety Instructions

These safety instructions are intended to prevent a hazardous situation and/or equipment damage. These instructions indicate the level of potential hazard by labels of "Caution", "Warning" or "Danger". To ensure safety, be sure to observe ISO 4414 ^{Note 1)}, JIS B 8370 ^{Note 2)} and other safety practices.

 **Caution** : Operator error could result in injury or equipment damage.

 **Warning** : Operator error could result in serious injury or loss of life.

 **Danger** : In extreme conditions, there is a possible result of serious injury or loss of life.

Note 1) ISO 4414: Pneumatic fluid power--General rules relating to systems.

Note 2) JIS B 8370: General Rules for Pneumatic Equipment

Warning

1. The compatibility of pneumatic equipment is the responsibility of the person who designs the pneumatic system or decides its specifications.

Since the products specified here are used in various operating conditions, their compatibility for the specific pneumatic system must be based on specifications or after analysis and/or tests to meet your specific requirements. The expected performance and safety assurance will be the responsibility of the person who has determined the compatibility of the system. This person should continuously review the suitability of all items specified, referring to the latest catalog information with a view to giving due consideration to any possibility of equipment failure when configuring a system.

2. Only trained personnel should operate pneumatically operated machinery and equipment.

Compressed air can be dangerous if an operator is unfamiliar with it. Assembly, handling or repair of pneumatic systems should be performed by trained and experienced operators.

3. Do not service machinery/equipment or attempt to remove components until safety is confirmed.

1. Inspection and maintenance of machinery/equipment should only be performed once measures to prevent falling or runaway of the driver objects have been confirmed.
2. When equipment is to be removed, confirm the safety process as mentioned above. Cut the supply pressure for this equipment and exhaust all residual compressed air in the system.
3. Before machinery/equipment is restarted, take measures to prevent shooting-out of cylinder piston rod, etc.

4. Contact SMC if the product is to be used in any of the following conditions:

1. Conditions and environments beyond the given specifications, or if product is used outdoors.
2. Installation on equipment in conjunction with atomic energy, railway, air navigation, vehicles, medical equipment, food and beverages, recreation equipment, emergency stop circuits, clutch and brake circuits in press applications, or safety equipment.
3. An application which has the possibility of having negative effects on people, property, or animals, requiring special safety analysis.



Common Precautions

Be sure to read before handling.

For detailed precautions on every series, refer to main text.

Selection

Warning

1. Confirm the specifications.

Products represented in this catalog are designed for use in compressed air applications only (including vacuum), unless otherwise indicated.

Do not use the product outside their design parameters.

Please contact SMC when using the products in applications other than compressed air (including vacuum).

Mounting

Warning

1. Instruction manual

Install the products and operate them only after reading the instruction manual carefully and understanding its contents. Also keep the manual where it can be referred to as necessary.

2. Securing the space for maintenance

When installing the products, please allow access for maintenance.

3. Tightening torque

When installing the products, please follow the listed torque specifications.

Piping

Caution

1. Before piping

Make sure that all debris, cutting oil, dust, etc. are removed from the piping.

2. Wrapping of pipe tape

When screwing piping or fittings into ports, ensure that chips from the pipe threads or sealing material do not get inside the piping. Also, when the pipe tape is used, leave 1.5 to 2 thread ridges exposed at the end of the threads.

Air Supply

Warning

1. Operating fluid

Please consult with SMC when using the product in applications other than compressed air (including vacuum).

Regarding products for general fluid, please ask SMC about applicable fluids.

2. Install an air dryer, aftercooler, etc.

Excessive condensate in a compressed air system may cause valves and other pneumatic equipment to malfunction.

Installation of an air dryer, after cooler etc. is recommended.

3. Drain flushing

If condensate in the drain bowl is not emptied on a regular basis, the bowl will over flow and allow the condensate to enter the compressed air lines.

If the drain bowl is difficult to check and remove, it is recommended that a drain bowl with the auto-drain option be installed.

For compressed air quality, refer to "Air Preparation Equipment" catalog.

4. Use clean air

If the compressed air supply is contaminated with chemicals, synthetic materials, corrosive gas, etc., it may lead to break down or malfunction.

Operating Environment

Warning

1. Do not use in environments where the product is directly exposed to corrosive gases, chemicals, salt water, water or steam.

2. Do not expose the product to direct sunlight for an extended period of time.

3. Do not use in a place subject to heavy vibrations and/or shocks.

4. Do not mount the product in locations where it is exposed to radiant heat.

Maintenance

Warning

1. Maintenance procedures are outlined in the operation manual.

Not following proper procedures could cause the product to malfunction and could lead to damage to the equipment or machine.

2. Maintenance work

If handled improperly, compressed air can be dangerous.

Assembly, handling and repair of pneumatic systems should be performed by qualified personnel only.

3. Drain flushing

Remove drainage from air filters regularly. (Refer to the specifications.)

4. Shut-down before maintenance

Before attempting any kind of maintenance make sure the supply pressure is shut of and all residual air pressure is released from the system to be worked on.

5. Start-up after maintenance and inspection

Apply operating pressure and power to the equipment and check for proper operation and possible air leaks. If operation is abnormal, please verify product set-up parameters.

6. Do not make any modifications to be product.

Do not take the product apart.

Quality Assurance Information (ISO 9001, ISO 14001)

Reliable quality of products in the global market

To enable our customers throughout the world to use our products with even greater confidence, SMC has obtained certification for international standards “ISO 9001” and “ISO 14001”, and created a complete structure for quality assurance and environmental controls. SMC products pursue to meet its customers’ expectations while also considering company’s contribution in society.

Quality management system ISO 9001

This is an international standard for quality control and quality assurance. SMC has obtained a large number of certifications in Japan and overseas, providing assurance to our customers throughout the world.



Environmental management system ISO 14001

This is an international standard related to environmental management systems and environmental inspections. While promoting environmentally friendly automation technology, SMC is also making diligent efforts to preserve the environment.



SMC’s quality control system



Quality policies

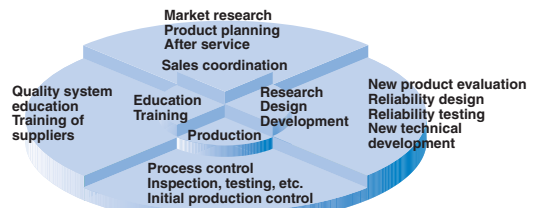

Quality control activities

SMC Product Conforming to Inter

SMC products complying with EN/ISO, CSA/UL standards are supporting



The CE mark indicates that machines and components meet essential requirements of all the EC Directives applied.

It has been obligatory to apply CE marks indicating conformity with EC Directives when machines and components are exported to the member Nations of the EU.

Once "A manufacturer himself" declares a product to be safe by means of CE marking (declaration of conformity by manufacturer), free distribution inside the member Nations of the EU is permissible.

■ CE Mark

SMC provides CE marking to products to which EMC and Low Voltage Directives have been applied, in accordance with CETOP (European hydraulics and pneumatics committee) guide lines.

■ As of February 1998, the following 18 countries will be obliged to conform to CE mark legislation

Iceland, Ireland, United Kingdom, Italy, Austria, Netherlands, Greece, Liechtenstein, Sweden, Spain, Denmark, Germany, Norway, Finland, France, Belgium, Portugal, Luxembourg

■ EC Directives and Pneumatic Components

• Machinery Directive

The Machinery Directive contains essential health and safety requirements for machinery, as applied to industrial machines e.g. machine tools, injection molding machines and automatic machines. Pneumatic equipment is not specified in Machinery Directive. However, the use of SMC products that are certified as conforming to EN Standards, allows customers to simplify preparation work of the Technical Construction File required for a Declaration of Conformity.

• Electromagnetic Compatibility (EMC) Directive

The EMC Directive specifies electromagnetic compatibility. Equipment which may generate electromagnetic interference or whose function may be compromised by electromagnetic interference is required to be immune to electromagnetic affects (EMS/immunity) without emitting excessive electromagnetic affects (EMI/emission).

• Low Voltage Directive

This directive is applied to products, which operate above 50 VAC to 1000 VAC and 75 VDC to 1500 VDC operating voltage, and require electrical safety measures to be introduced.

• Simple Pressure Vessels Directive

This directive is applied to welded vessels whose maximum operating pressure (PS) and volume of vessel (V) exceed 50 bar/L. Such vessels require EC type examination and then CE marking.

national Standards

you to comply with EC directives and CSA/UL standards.



■ CSA Standards & UL Standards

UL and CSA standards have been applied in North America (U.S.A. and Canada) symbolizing safety of electric products, and are defined to mainly prevent danger from electric shock or fire, resulting from trouble with electric products. Both UL and CSA standards are acknowledged in North America as the first class certifying body. They have a long experience and ability for issuing product safety certificate. Products approved by CSA or UL standards are accepted in most states and governments beyond question.

Since CSA is a test certifying body as the National Recognized Testing Laboratory (NRTL) within the jurisdiction of Occupational Safety and Health Administration (OSHA), SMC was tested for compliance with CSA Standards and UL Standards at the same time and was approved for compliance with the two Standards. The above CSA NRTL/C logo is described on a product label in order to indicate that the product is approved by CSA and UL Standards.

■ TSSA (MCCR) Registration Products

TSSA is the regulation in Ontario State, Canada. The products that the operating pressure is more than 5 psi (0.03 MPa) and the piping size is bigger than 1 inch. fall into the scope of TSSA regulation.

Products conforming to CE Standard



With CE symbol for simple visual recognition

In this catalog each accredited product series is indicated with a CE mark symbol. However, in some cases, every available models may not meet CE compliance. Please visit our web site for the latest selection of available models with CE mark.

<http://www.smcworld.com>

SMC's Global Service Network

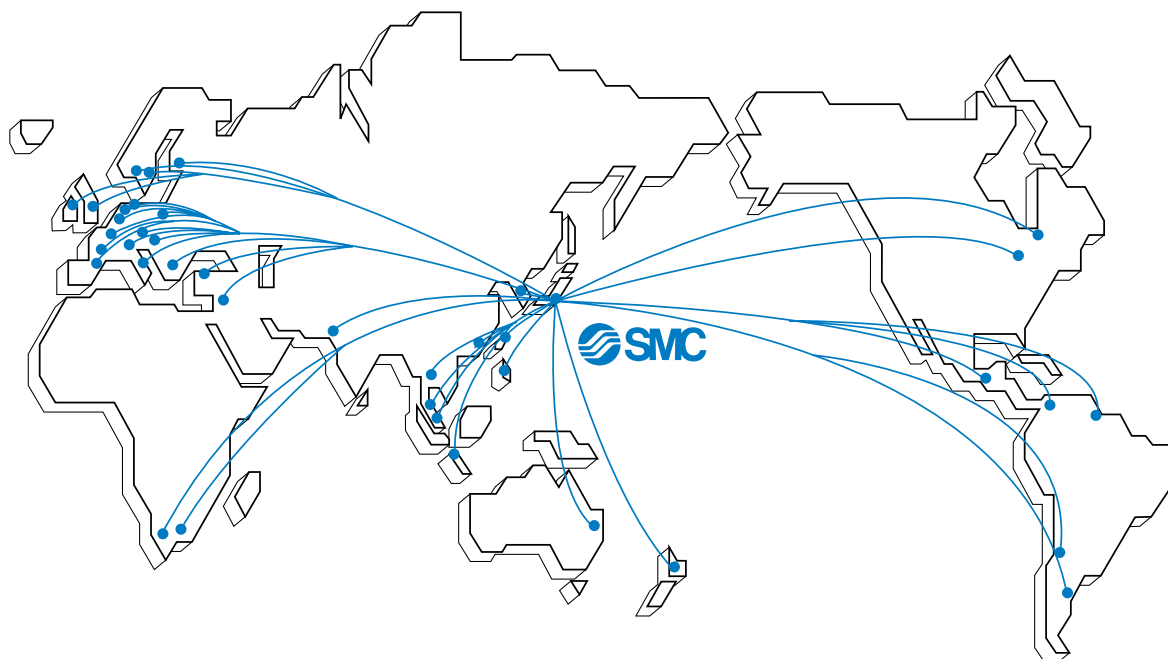

America

U.S.A. **SMC Corporation of America**

3011 North Franklin Road Indianapolis, IN 46226, U.S.A.
TEL: 317-899-4440 FAX: 317-899-3102

CANADA **SMC Pneumatics (Canada) Ltd.**

6768 Financial Drive Mississauga, Ontario, L5N 7J6 Canada
TEL: 905-812-0400 FAX: 905-812-8686

MEXICO **SMC Corporation (Mexico), S.A. DE C.V.**

Carr. Silao-Trejo K.M. 2.5 S/N, Predio San Jose del Duranzo
C.P. 36100, Silao, Gto., Mexico
TEL: 472-72-2-55-00 FAX: 472-72-2-59-44/2-59-46

CHILE **SMC Pneumatics (Chile) S.A.**

Av. La Montaña 1,115 km. 16,5 P. Norte Parque
Industrial Valle Grande, Lampa Santiago, Chile
TEL: 02-270-8600 FAX: 02-270-8601

ARGENTINA **SMC Argentina S.A.**

Teodoro Garcia 3860 (1427) Buenos Aires, Argentina
TEL: 011-4555-5762 FAX: 011-4555-5762

BOLIVIA **SMC Pneumatics Bolivia S.R.L.**

Avenida Beni Numero 4665
Santa Cruz de la Sierra-Casilla de Correo 2281, Bolivia
TEL: 591-3-3428383 FAX: 591-3-3449900

VENEZUELA **SMC Neumatica Venezuela S.A.**

Apartado 40152, Avenida Nueva Granada, Edificio Wanlac,
Local 5, Caracas 1040-A, Venezuela
TEL: 2-632-1310 FAX: 2-632-3871

PERU (Distributor) **IMPECO Automatizacion Industrial S.A.**

AV. Canevaro 752, Lince, Lima, Peru
TEL: 1-471-6002 FAX: 1-471-0935

URUGUAY (Distributor) **BAKO S.A.**

Galicia 1650 esq. Gaboto C.P. 11200, Montevideo, Uruguay
TEL: 2-401-6603 FAX: 2-409-4306

BRAZIL **SMC Pneumaticos Do Brasil Ltda.**

Rua. Dra. Maria Fidelis, nr. 130, Jardim Piraporinha-Diadema-S.P.
CEP: 09950-350, Brasil
TEL: 11-4051-1177 FAX: 11-4071-6636

COLOMBIA (Distributor) **Airmatic Ltda.**

Calle 18 69-05 Apart. Aereo 081045 Santa Fe de Bogotá, Colombia
TEL: 1-424-9240 FAX: 1-424-9260

Europe

U.K. **SMC Pneumatics (U.K.) Ltd.**

Vincent Avenue, Crownhill, Milton Keynes, MK8 0AN, Buckinghamshire, U.K.
TEL: 01908-563888 FAX: 01908-561185

GERMANY **SMC Pneumatik GmbH**

Boschring 13-15 D-63329 Egelsbach, Germany
TEL: 06103-4020 FAX: 06103-402139

ITALY **SMC Italia S.p.A.**

Via Garibaldi 62 I-20061 Carugate Milano, Italy
TEL: 02-9271365 FAX: 02-9271365

FRANCE **SMC Pneumatique S.A.**

1 Boulevard de Strasbourg, Parc Gustave Eiffel, Bussy Saint Georges, F-77600
Marne La Vallee Cedex 3 France
TEL: 01-64-76-10-00 FAX: 01-64-76-10-10

SWEDEN **SMC Pneumatics Sweden AB**

Ekhagsvägen 29-31, S-141 05 Huddinge, Sweden
TEL: 08-603-07-00 FAX: 08-603-07-10

SWITZERLAND **SMC Pneumatik AG**

Dorfstrasse 7, Postfach 117, CH-8484 Weisslingen, Switzerland
TEL: 052-396-3131 FAX: 052-396-3191

AUSTRIA **SMC Pneumatik GmbH (Austria)**

Girakstrasse 8, A-2100 Korneuburg, Austria
TEL: 0-2262-6228-0 FAX: 0-2262-62285

SPAIN **SMC España, S.A.**

Zuazobidea 14 Pol. Ind. Júndiz 01015 Vitoria, Spain
TEL: 945-184-100 FAX: 945-184-510

IRELAND **SMC Pneumatics (Ireland) Ltd.**

2002 Citywest Business Campus, Naas Road, Saggart, Co. Dublin, Ireland
TEL: 01-403-9000 FAX: 01-466-0385

NETHERLANDS (Associated company) **SMC Pneumatics BV**

De Ruyterkade 120, NL-1011 AB Amsterdam, Netherlands
TEL: 020-5318888 FAX: 020-5318880

GREECE (Distributor) **S.Parianopoulos S.A.**

7, Konstantinoupoleos Street 11855 Athens, Greece
TEL: 01-3426076 FAX: 01-3455578

DENMARK **SMC Pneumatik A/S**

Knudsminde 4 B DK-8300
Odder, Denmark
TEL: 70252900 FAX: 70252901

Europe

FINLAND **SMC Pneumatics Finland OY**

PL72, Tiistinniityntie 4, SF-02231 ESP00, Finland
TEL: 09-8595-80 FAX: 09-8595-8595

NORWAY **SMC Pneumatics Norway A/S**

Vollsveien 13C, Granfoss Næringspark N-1366 LYSAKER, Norway
TEL: 67-12-90-20 FAX: 67-12-90-21

BELGIUM (Distributor) **SMC Pneumatics N.V./S.A.**

Nijverheidsstraat 20 B-2160 Wommelgem Belguim
TEL: 03-355-1464 FAX: 03-355-1466

POLAND **SMC Industrial Automation Polska Sp.z.o.o.**

ul. Konstruktorska 11A, PL-02-673 Warszawa, Poland
TEL: 022-548-5085 FAX: 022-548-5087

TURKEY (Distributor) **Entek Pnömatik San.ve Tic. Ltd. Sti**

Perpa Tic. Merkezi Kat:11 No.1625 80270 Okmeydani Istanbul, Türkiye
TEL: 0212-221-1512 FAX: 0212-221-1519

RUSSIA **SMC Pneumatik LLC.**

36/40 Sredny prospect V.O. St. Petersburg 199004, Russia
TEL: 812-118-5445 FAX: 812-118-5449

CZECH **SMC Industrial Automation CZ s.r.o.**

Hudcova 78a, CZ-61200 Brno, Czech Republic
TEL: 05-4121-8034 FAX: 05-4121-8034

HUNGARY **SMC Hungary Ipari Automatizálási kft.**

Budafoki ut 107-113 1117 Budapest
TEL: 01-371-1343 FAX: 01-371-1344

ROMANIA **SMC Romania S.r.l.**

Str. Frunzei, Nr. 29, Sector 2, Bucharest, Romania
TEL: 01-3205111 FAX: 01-3261489

SLOVAKIA **SMC Priemyselná automatizácia, s.r.o.**

Nova 3, SK-83103 Bratislava
TEL: 02-4445-6725 FAX: 02-4445-6028

SLOVENIA **SMC Industrijska Avtomatila d.o.o.**

Grajski trg 15, SLO- 8360 Zuzemberk, Slovenia
TEL: 07388-5240 FAX: 07388-5249

LATVIA **SMC Pneumatics Latvia SIA**

Šmerļa ielā 1-705, Rīga LV-1006
TEL: 777 94 74 FAX: 777 94 75

SOUTH AFRICA (Distributor) **Hyflo Southern Africa (Pty.) Ltd.**

P.O.Box 240 Paardeneiland 7420 South Africa
TEL: 021-511-7021 FAX: 021-511-4456

EGYPT (Distributor) **Saadani Trading & Ind. Services**

15 Sebaai Street, Miami 21411 Alexandria, Egypt
TEL: 3-548-50-34 FAX: 3-548-50-34

Oceania/Asia

AUSTRALIA **SMC Pneumatics (Australia) Pty.Ltd.**

14-18 Hudson Avenue Castle Hill NSW 2154, Australia
TEL: 02-9354-8222 FAX: 02-9894-5719

NEW ZEALAND **SMC Pneumatics (New Zealand) Ltd.**

8C Sylvia Park Road Mt.Wellington Auckland, New Zealand
TEL: 09-573-7007 FAX: 09-573-7002

TAIWAN **SMC Pneumatics (Taiwan) Co.,Ltd.**

17, Lane 205, Nansan Rd., Sec.2, Luzhu-Hsiang, Taoyuan-Hsien, TAIWAN
TEL: 03-322-3443 FAX: 03-322-3387

HONG KONG **SMC Pneumatics (Hong Kong) Ltd.**

29/F, Clifford Centre, 778-784 Cheung, Sha Wan Road, Lai Chi Kok, Kowloon, Hong Kong
TEL: 2744-0121 FAX: 2785-1314

SINGAPORE **SMC Pneumatics (S.E.A.) Pte. Ltd.**

89 Tuas Avenue 1, Jurong Singapore 639520
TEL: 6861-0888 FAX: 6861-1889

PHILIPPINES **SHOKETSU SMC Corporation**

Unit 201 Common Goal Tower, Madrigal Business Park, Ayala Alabang Muntinlupa, Philippines
TEL: 02-8090565 FAX: 02-8090586

MALAYSIA **SMC Pneumatics (S.E.A.) Sdn. Bhd.**

Lot 36 Jalan Delima1/1, Subang Hi-Tech Industrial Park, Batu 3 40000 Shah Alam Selangor, Malaysia
TEL: 03-56350590 FAX: 03-56350602

SOUTH KOREA **SMC Pneumatics Korea Co., Ltd.**

Woolim e-BIZ Center (Room 1008), 170-5, Guro-Dong, Guro-Gu, Seoul, 152-050, South Korea
TEL: 02-3219-0700 FAX: 02-3219-0702

CHINA **SMC (China) Co., Ltd.**

7 Wan Yuan St. Beijing Economic & Technological Development Zone 100176, China
TEL: 010-67882111 FAX: 010-67881837

THAILAND **SMC Thailand Ltd.**

134/6 Moo 5, Tiwanon Road, Bangkadi, Amphur Muang, Patumthani 12000, Thailand
TEL: 02-963-7099 FAX: 02-501-2937

INDIA **SMC Pneumatics (India) Pvt. Ltd.**

D-107 to 112, Phase-2, Extension, Noida, Dist. Gautaim Budh Nagar, U.P. 201 305, India
TEL: (0120)-4568730 FAX: 0120-4568933

INDONESIA (Distributor) **P.T. Riyadi Putera Makmur**

Jalan Hayam Wuruk Komplek Glodok Jaya No. 27-28 Jakarta 11180 Indonesia
TEL: 021-625 5548 FAX: 021-625 5888

PAKISTAN (Distributor) **Jubilee Corporation**

First Floor Mercantile Centre, Newton Road Near Boulton Market P.O. Box 6165 Karachi 74000 Pakistan
TEL: 021-243-9070/8449 FAX: 021-241-4589

ISRAEL (Distributor) **Baccara Automation Control**

Kvutza Geva 18915 Israel
TEL: 04-653-5960 FAX: 04-653-1445

SAUDI ARABIA (Distributor) **Assaggaff Trading Est.**

P.O. Box 3385 Al-Amir Majed Street, Jeddah-21471, Saudi Arabia
TEL: 02-6761574 FAX: 02-6708173