

Ex-plugs and receptacles 16 A 3/4/5-pole up to 690 V

1



Wall socket



Flange socket



Coupler



Plug

Technical data

Ex-plugs and receptacles acc. to IEC 60309-1/2 16A

Marking accd. to 2014/34/EU	Wall socket, plug and coupler: $\text{II 2 G Ex ed IIC T6} / \text{II 2 D Ex tD A21 IP66 T80 } ^\circ\text{C}$ Flange socket: $\text{II 2 G Ex db eb IIC/IIB Gb} / \text{II 2 D Ex tb IIIC Db}$
EC-Type Examination Certificate	Wall socket, plug and coupler: PTB 99 ATEX 1039 / Flange socket: BVS 15 ATEX E 101 U
IECEX Certificate of Conformity	Wall socket, plug and coupler: IECEX BKI 04.0002 / Flange socket: IECEX BVS 15.0088U
Marking accd. to IECEx	Wall socket, plug and coupler: IEx ed [ia] IIC T6/T5 / Flange socket: Ex db eb IIC/IIB Gb / Ex tb IIIC Db
Permissible ambient temperature	-20°C up to +40°C ¹⁾
Rated voltage	up to 400 V, (3-pole) / 690 V, (4-pole) / 500 V, (5-pole) AC
Rated current	16 A
Frequency	up to 400 Hz
Rated making / Rated breaking capacity AC-3 accd. EN 60947-3	U _e 250 V / I _e 16 A (3-pole) U _e 690 V / I _e 16 A (4-pole) U _e 500 V / I _e 16 A (5-pole)
External back-up fuse, max.	without therm. protection: 16 A with therm. protection: 35 A gG (rated current 16 A set to)
Protection class	I
Degree of protection accd. to EN 60529	IP66

Wall socket

Cable entry	1 x M25 cable gland, 1 x M25 plastic Ex-screw plug or 2 x metal thread M20 with plastic Ex-screw plug
Connecting terminals	2 x 1 - 4 mm ²
Enclosure material	glass-fibre reinforced polyester

Plug

Cable entry	Ø 8 - 19 mm (3-pole) / Ø 8 - 21 mm (4-pole) / 12 - 21 mm (5-pole)
Connecting terminals	1 x 1.0 - 2.5 mm ²
Enclosure material	Polyamide

Coupler

Cable entry	Ø 8 - 19 mm (3-pole) / Ø 8 - 21 mm (4-pole) / 12 - 21 mm (5-pole)
Connecting terminals	2 x 1 - 4 mm ²
Enclosure material	Polyamide

Flange socket

Connecting terminals	2 x 1 - 4 mm ²
Enclosure material	Polyamide

¹⁾ extended temperature range on request.

Details for used cable glands see pages 2.3.ff

Ordering details

Voltage	h	Type	Aux. contact	Cable entry	Weight approx.	Order No.
110-130 V		Wall socket	–	M25 KU	1.2 kg	GHG 511 4304 R0001
		Wall socket	–	M20 GE	1.2 kg	GHG 511 4304 R0002
		Wall socket	–	M20 ME	1.3 kg	GHG 511 4304 R3001
		Wall socket	–	M20 GM	1.3 kg	GHG 511 4304 R3003
		Flange socket	–		0.4 kg	GHG 511 8304 R0001
		Coupler	–		0.7 kg	GHG 511 3304 R0001
		Plug	–		0.35 kg	GHG 511 7304 R0001

Ex-plugs and receptacles 16 A 3/4/5-pole up to 690 V



Plug



Coupler





Flange socket

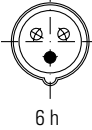
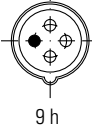
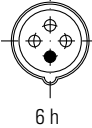

Wall socket

Ordering details

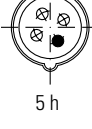
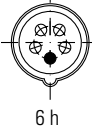
Voltage	h	Type	Aux. contact	Cable entry	Weight approx.	Order No.
Type 16 A 3-pole						
200-250 V		Wall socket	–	KU	1.2 kg	GHG 511 4306 R0001
		Wall socket	–	GE	1.2 kg	GHG 511 4306 R0002
		Wall socket	–	ME	1.3 kg	GHG 511 4306 R3001
		Wall socket	–	GM	1.3 kg	GHG 511 4306 R3003
		Flange socket			0.4 kg	GHG 511 8306 R0001
		Coupler			0.7 kg	GHG 511 3306 R0001
		Plug			0.35 kg	GHG 511 7306 R0001
Type 16 A 4-pole						
200-250 V		Wall socket	–	KU	1.4 kg	GHG 511 4409 R0001
		Wall socket	–	ME	1.5 kg	GHG 511 4409 R3001
		Wall socket	–	GM	1.6 kg	GHG 511 4409 R3003
		Flange socket			1.0 kg	GHG 511 8409 R0001
		Coupler			0.9 kg	GHG 511 3409 R0001
		Plug			0.38 kg	GHG 511 7409 R0001
		380-415 V		Wall socket	–	KU
Wall socket	–			ME	1.5 kg	GHG 511 4406 R3001
Wall socket	–			GM	1.6 kg	GHG 511 4406 R3003
Wall socket	yes			KH	1.4 kg	GHG 511 4406 R0501
Flange socket					1.0 kg	GHG 511 8406 R0001
Coupler					0.9 kg	GHG 511 3406 R0001
Plug					0.38 kg	GHG 511 7406 R0001
480-500 V		Wall socket	–	KU	1.4 kg	GHG 511 4407 R0001
		Wall socket	–	ME	1.5 kg	GHG 511 4407 R3001
		Wall socket	yes	KH	1.4 kg	GHG 511 4407 R0501
		Flange socket			1.0 kg	GHG 511 8407 R0001
		Coupler			0.9 kg	GHG 511 3407 R0001
		Plug			0.38 kg	GHG 511 7407 R0001
		600-690 V		Wall socket	–	KU
Wall socket	–			ME	1.5 kg	GHG 511 4405 R3001
Wall socket	yes			KH	1.4 kg	GHG 511 4405 R0501
Flange socket					1.0 kg	GHG 511 8405 R0001
Coupler					0.9 kg	GHG 511 3405 R0001
Plug					0.38 kg	GHG 511 7405 R0001
Type 16 A 5-pole						
200-250 V 380-415 V		Wall socket	–	KU	1.4 kg	GHG 511 4506 R0001
		Wall socket	–	ME	1.5 kg	GHG 511 4506 R3001
		Wall socket	yes	KH	1.4 kg	GHG 511 4506 R0501
		Wall socket	–	GM	1.6 kg	GHG 511 4506 R3003
		Flange socket			1.0 kg	GHG 511 8506 R0001
		Coupler			0.95 kg	GHG 511 3506 R0001
		Plug			0.42 kg	GHG 511 7506 R0001

Other voltage ranges and versions available on request

KU = 1 x plastic cable glands M25, 1 x M25 plastic Ex-screw plug

ME = 2 x metal thread M20

GM = 2 x metal thread M20 with screw plug, with external earth bolt M6

KH = 2 x plastic cable glands M25, aux. contact, 1 NO

GE = 2x plastic thread M20 without gland/screw plug

Ex-plugs and receptacles 16 A 3/4/5-pole up to 690 V

1



Wall socket



flange socket



Coupler



Plug

Dimension drawing | Wiring diagram

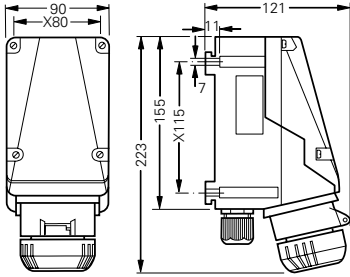

Wall socket 3-pole

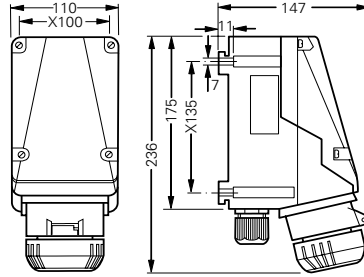

Wall socket 4/5-pole

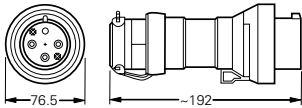

Plug 3-pole

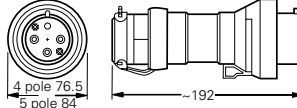

Plug 4/5-pole

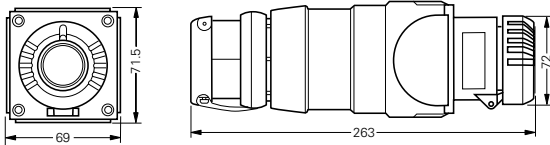

Coupler 3-pole

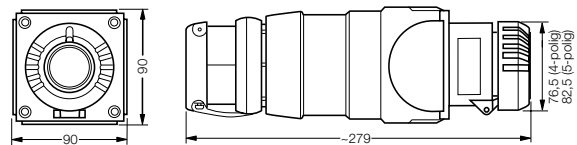

Coupler 4/5-pole

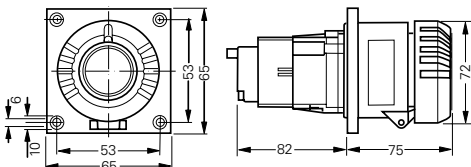

Flange socket 3-pole

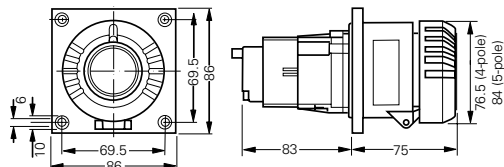

Flange socket 4/5-pole

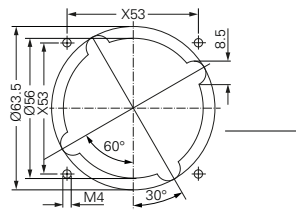

Assembly dimensions flange socket

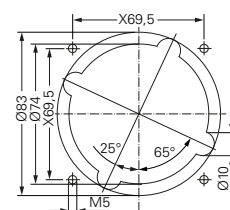

Assembly dimensions flange socket X = fixing dimensions

without aux. contact

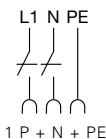

without aux. contact

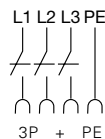

with aux. contact

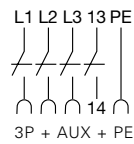

without aux. contact

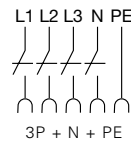

with aux. contact

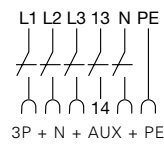

Dimensions in mm



Protective canopy



Plug cap



GHG 610 1901 R0126

Accessories

Type	Application	Fixing method	Order No.
Mounting plates for wall sockets 16 A			
Size 4	for wall mounting	snap on	GHG 610 1953 R0126
Size 4	for trellis mounting	snap on	GHG 610 1953 R0126
Size 4	for pipe clamp	snap on	GHG 610 1953 R0130

Type	Order No.
Plug cap for plugs 16 A	
Plug 16 A 3-pole	GHG 510 1901 R0001
Plug 16 A 4-pole	GHG 510 1901 R0002
Plug 16 A 5-pole	GHG 510 1901 R0003

Type	OU	Order No.
Accessories for mounting plates		
Mounting set for pipes 1" (Ø 27 - 30 mm) for mounting plates with pipe fixing	10	GHG 610 1953 R0020

Please pay attention that only order units (OU) according to the ordering details can be delivered.

Type	Application	Order No.
Protective canopy for mounting plate		
Size 4	for mounting plate size 4, snap on	GHG 610 1955 R0107

Dimension drawing

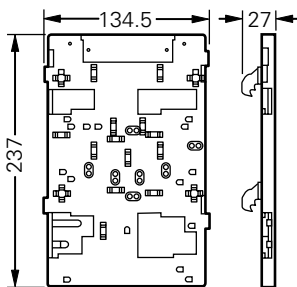

Mounting plate size 4 for wall/trellis mounting

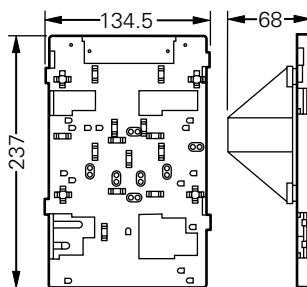

Mounting plate size 4 for pipe clamp

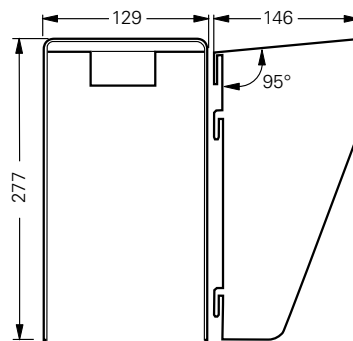

Protective canopy size 4