

## Pressure Relief 3 Port Valve: (V)

With the use of a 3-port valve for residual pressure release, pressure left in the line can be easily exhausted.

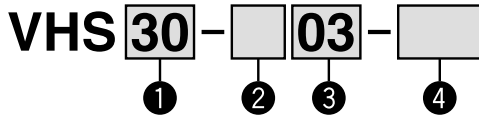

- Semi-standard: Select one each for a to b.
- Semi-standard symbol: When more than one specification is required, indicate in alphabetic order.  
Example) VHS30-03-RZ

		Symbol	Description	① Body size				
				20	30	40	50	
②	Thread type	Nil	Rc	●	●	●	●	
		N (Note)	NPT	●	●	●	●	
		F (Note)	G	●	●	●	●	
+								
③	Port size	01	1/8	●	—	—	—	
		02	1/4	●	●	—	—	
		03	3/8	—	●	●	—	
		04	1/2	—	—	●	—	
		06	3/4	—	—	●	●	
		10	1	—	—	—	●	
+								
④	a	Flow direction	Nil	Flow direction: Left to right	●	●	●	●
		R	Flow direction: Right to left	●	●	●	●	
	+							
	b	Pressure unit	Nil	Name plate in imperial units: MPa	●	●	●	●
Z (Note)			Name plate in imperial units: psi	●	●	●	●	

### JIS Symbol

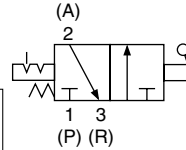

3-port valve for residual pressure release

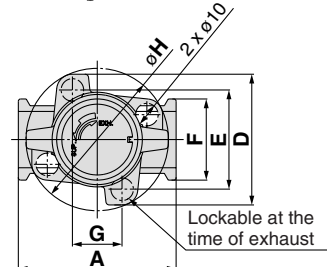
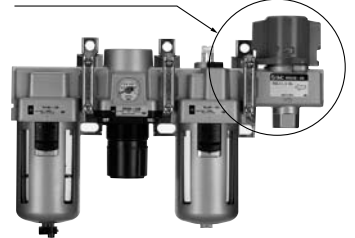

Note) For thread type: NPT only. This product is for overseas use only according to the new Measurement Law. (The SI unit type is provided for use in Japan.)

### Specifications

Model	Port size		Effective area (mm <sup>2</sup> ) ( ) : Cv factor	
	IN, OUT	EXH	IN→OUT	OUT→EXH
VHS20	1/8	1/8	10 (0.54)	11 (0.60)
	1/4		14 (0.76)	16 (0.87)
VHS30	1/4	1/4	16 (0.87)	14 (0.76)
	3/8		31 (1.68)	29 (1.57)
VHS40	1/4	3/8	27 (1.46)	36 (1.95)
	3/8		38 (2.06)	40 (2.17)
	1/2		55 (2.98)	42 (2.28)
VHS40-06	3/4	1/2	77 (1.73)	49 (2.66)
VHS50	3/4	1/2	82 (4.44)	50 (2.71)
	1		125 (6.78)	53 (2.87)

Note) Use an air filter on the IN side for operating protection.

### Caution on Mounting

- If a tube, stop valve or silencer is connected to the exhaust port of the VHS20/30, the effective sectional area should be larger than the figure indicated in the following table, to prevent malfunction caused by back pressure. (This is not applicable to the VHS40/50.)

Model	Effective area (mm <sup>2</sup> )
VHS20	5
VHS30	5

### Cross Spacer: M5 x 0.8, 1/8, 1/4, 3/8, 1/2

Pipings are possible in all 4 directions.  
IN/OUT ports are not machined for threads.  
Please contact SMC if threaded (machined) ports are required.

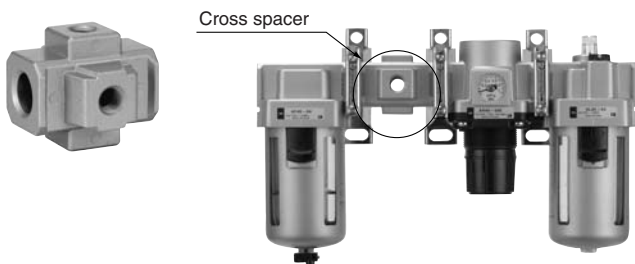

### Caution on Mounting

- When mounting a cross interface directly on the IN side of the lubricator, be sure to use the AKM series check valve between the lubricator and cross interface.
- Factory mounting of a cross interface on the AC model is available as a special order.

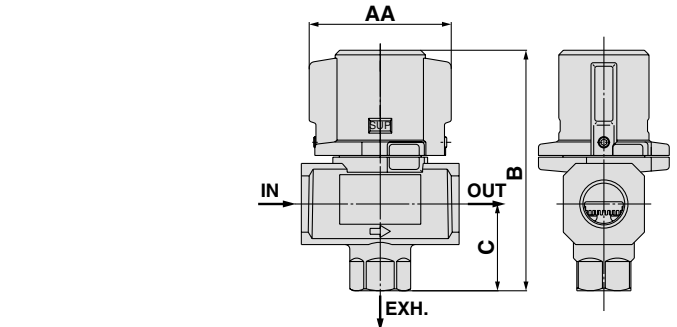

Model	A	AA	B	C	D	E	F	G	H
VHS20	40	34	59	20	45	33	28	—	45
VHS30	53	46	78	29	55	42	30	—	55
VHS40	70	63	107	39	58	44	36	22	63
VHS40-06	75	67	110	42	65	50	44	21	69
VHS50	90	78	134	53	76	61	54	26	81

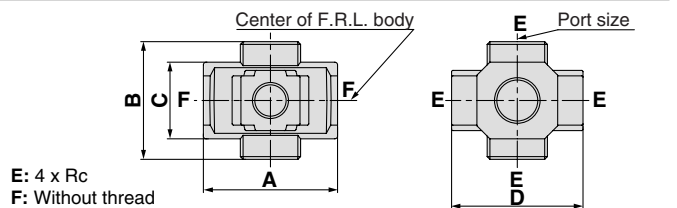

E: 4 x Rc  
F: Without thread

Model	Port size	A	B	C	D	Applicable model
Y14-M5	M5	23	16	14	25	AC10□
Y24-□01	1/8	40	40	22	40	AC20□
Y24-□02	1/4					
Y34-□01	1/8	49	43	28	48	AC25□, AC30□
Y34-□02	1/4					
Y44-□02	1/4	60	48	36	54	AC40□
Y44-□03	3/8					
Y54-□03	3/8	72	62	40	62	AC40□-06
Y54-□04	1/2					

Note 1) □ in model numbers indicates a thread type. No indication is necessary for Rc; however, indicate N for NPT, and F for G.

Note 2) If threaded IN/OUT ports are required, they are available as a special order. Please contact SMC.