

Sintered Metal Element

Series **EB**□/**ES**□

Bronze/Stainless Steel

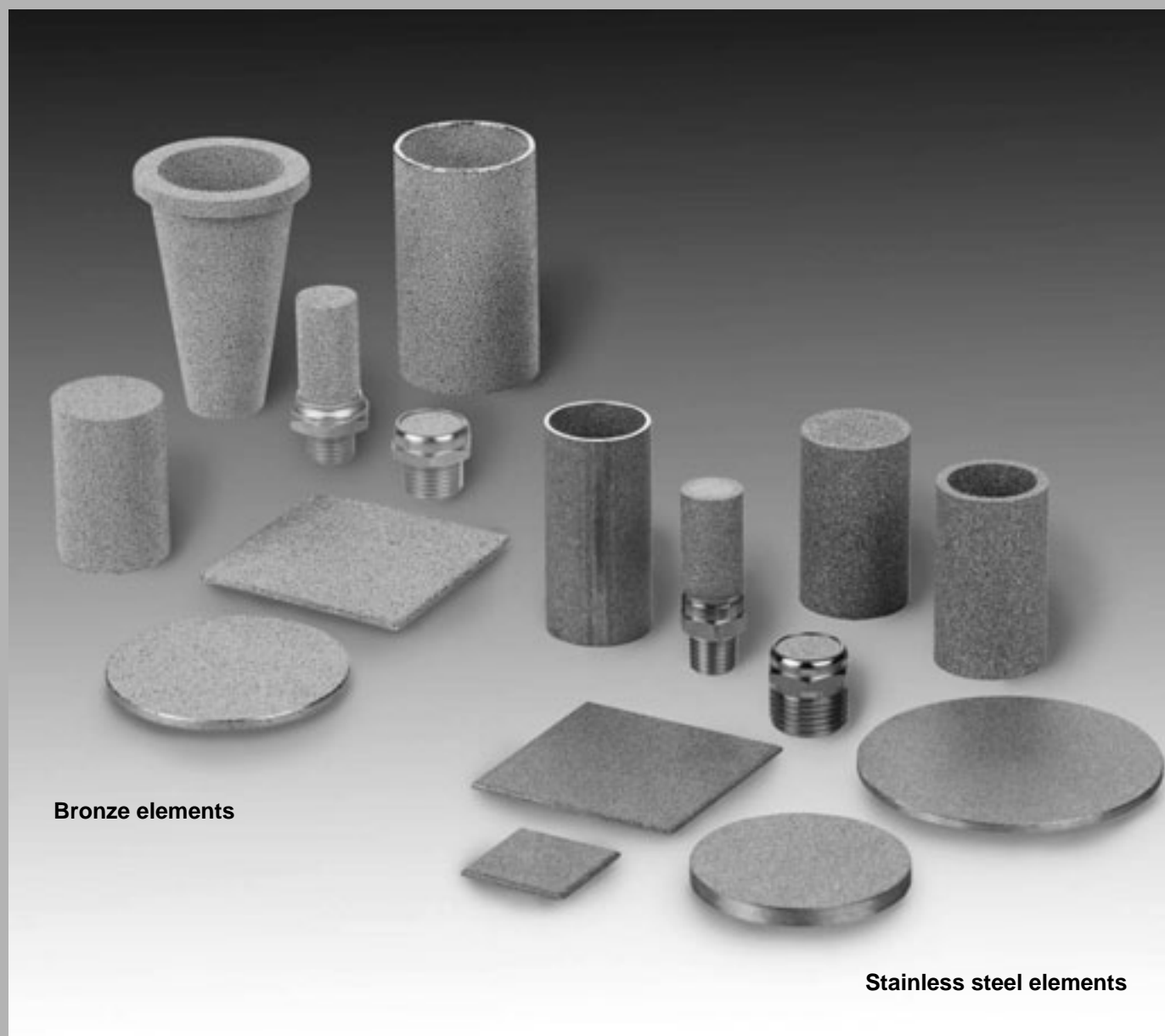

- FGD
- FGE
- FGG
- FGA
- FGB
- FGC
- FGF
- FGH
- EJ
- ED
- FQ1
- FN
- EB□
- ES□

Product Configurations of Sintered Metal Elements

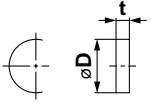
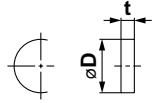
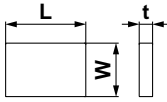
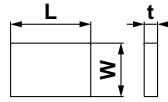
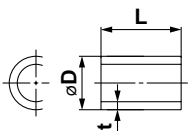
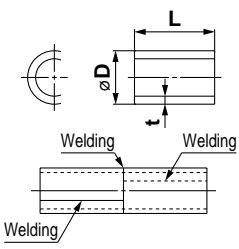
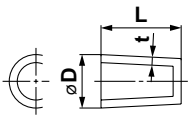
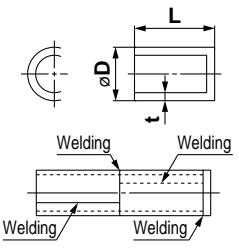
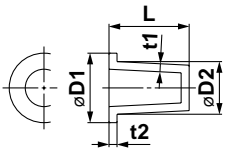
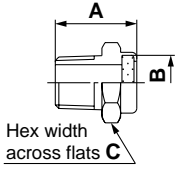
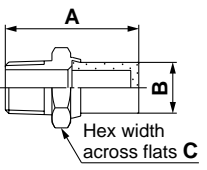
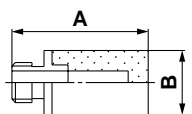
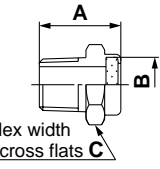
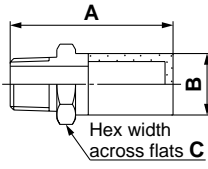
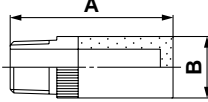
Configuration	Bronze elements (BC)			Stainless steel elements (SUS)		
Disc		Series EBD (P.844)	<ul style="list-style-type: none"> With outside diameter cutting finish Without outside diameter cutting finish 		Series ESD (P.847)	<ul style="list-style-type: none"> With outside diameter cutting finish Without outside diameter cutting finish
Square sheet		Series EBS (P.844)	<ul style="list-style-type: none"> With external shearing finish With external machining finish 		Series ESS (P.848)	<ul style="list-style-type: none"> With external shearing finish With external machining finish
Cylinder		Series EBP (P.845)	—		Series ESP (P.849)	<ul style="list-style-type: none"> Seamless finish (molded product) With seams (welded product)
Cylinder with bottom		Series EBW (P.845)	—		Series ESW (P.850)	<ul style="list-style-type: none"> Seamless finish (molded product) With seams (welded product)
Cone with flange		Series EBF (P.846)	—	—	—	—
Element with fitting	 <p>Hex width across flats C</p>  <p>Hex width across flats C</p>	P.846	<ul style="list-style-type: none"> With fitting (M3, M5, R1/8, R1/4, R3/8, R1/2) 	  <p>Hex width across flats C</p>  <p>Hex width across flats C</p> 	P.851	<ul style="list-style-type: none"> With fitting (M3, M5, R1/8, R1/4, R3/8, R1/2)
Features	Sintered material: CAC403 equivalent (Metal material of elements with fitting: brass) • Produces $2CuCO_3 \cdot Cu(OH)_2$ (patina) in the atmosphere, providing good corrosion resistance.			Sintered material: SUS316L equivalent (Metal material of elements with fitting: stainless steel) • Austenite stainless steel with good corrosion resistance to acids, alkaline substances, and other chemicals		

- FGD
- FGE
- FGG
- FGA
- FGB
- FGC
- FGF
- FGH
- EJ
- ED
- FQ1
- FN



SMC sintered metal elements are suitable

for a wide range of industrial applications.

- High mechanical strength and withstand pressure
- Anti-corrosion
- Suitable for high-accuracy filtration
- Suitable for machining, crimping, brazing, welding, and simultaneous sintering
- Washing allows repeated use

Specifications

Item	Bronze	Stainless steel
Material	CAC403 equivalent	SUS316L equivalent
Sintering density (g/cm ³)	5.0 to 6.5	4.2 to 5.2
Void ratio (%)	25 to 43	36 to 48
Operating temperature range (°C)	-160 to 200	-250 to 550
Thermal expansion coefficient (1/°C)	1.8 x 10 ⁻⁵	1.6 x 10 ⁻⁵
Tensile strength (MPa)	9.8 to 83.4	
Nominal filtration accuracy (μm)	(1), 2, 5, 10, 20	
Abbreviated/Nominal (μm)	40, 70, 100, 120	
Typical configurations	Disc, square sheet, cylinder, cylinder with bottom, cone with flange, element with fitting, etc.	

Note 1) Sintering density, void ratio, and tensile strength differ according to nominal filtration accuracy.
 Note 2) Thermal expansion coefficient applies to stainless steel or bronze material, not to sintered metal elements.
 Note 3) Nominal filtration accuracy of 1 μm is an optional value.

Raw material categories and nominal filtration accuracy (μm)

Sieve (mesh)	20	24	32	42	60	80	120	200	250
Opening (μm)	850	710	500	355	250	180	125	75	63
Nominal filtration accuracy (μm)	120	100	70	40	20	10	5	2	

Note 1) Sieve (mesh) and opening values apply to metal mesh separating raw material, not to elements.
 Note 2) Nominal filtration accuracy: Refers to value used to categorize raw material, not to filtration rating.
 (Refer to the page 854 for "11 Nominal filtration accuracy".)

Raw Material Powder and Sintered Metal Element

<Bronze powder>

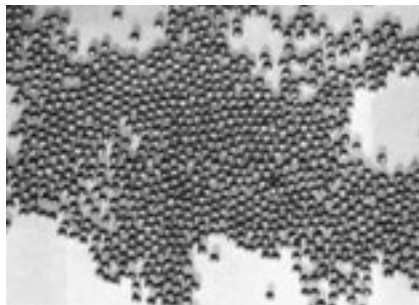

<Stainless steel powder>

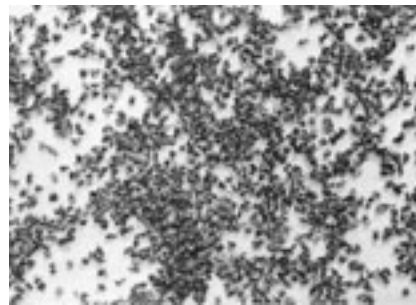

<Sintered bronze>

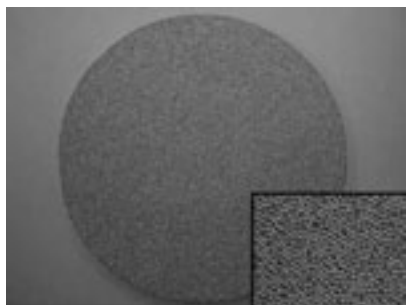

<Sintered stainless steel>

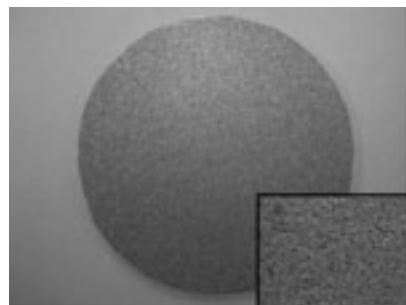

Applications

A sintered metal element consists of countless interconnected capillary tubes, making it suitable for a wide range of uses. For detailed information on purpose-specific applications, please contact SMC.

1. Filtration

Sintered metal elements are widely used for removing foreign particles from many different kinds of flow media.

Major application fields: General gases, water, various kinds of oils

Normally, filtration makes use of the so-called bridge effect where foreign particles are blocked because they form a bridge-like accumulation. The size and distribution of particles to be filtered can be controlled through parameters such as the diameter of the capillary tubes. Particles may be blocked completely or selectively.

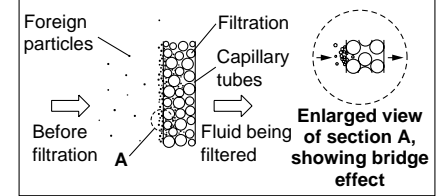

2. High-viscosity filtration

This is used to remove foreign matter or gel from raw materials for fibers or films.

3. Sound absorption

The porous quality of sintered metal elements allows them to absorb sound energy, providing a muffling or silencing effect.

4. Gas removal

Sintered metal elements are used for degassing purposes in forming and molding processes.

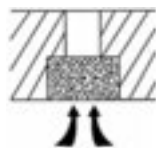

5. Foaming

Sintered metal elements positioned in various kinds of fluids are used to introduce gases, for stirring and other purposes.

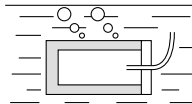

6. Flow control

Because a sintered metal element consists of countless interconnected capillary tubes, it can be used to control the flow of fluids. Cylindrical bronze elements are especially suited for this type of application.

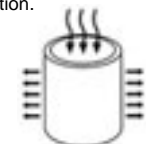

7. Other applications

Various other applications make use of the fluid-passing functionality of sintered metal elements.

Flow Rate Characteristics

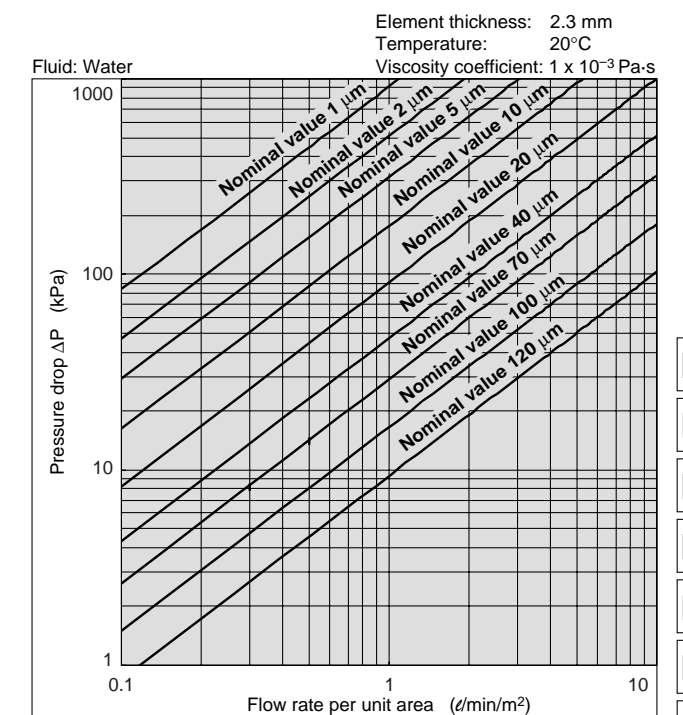
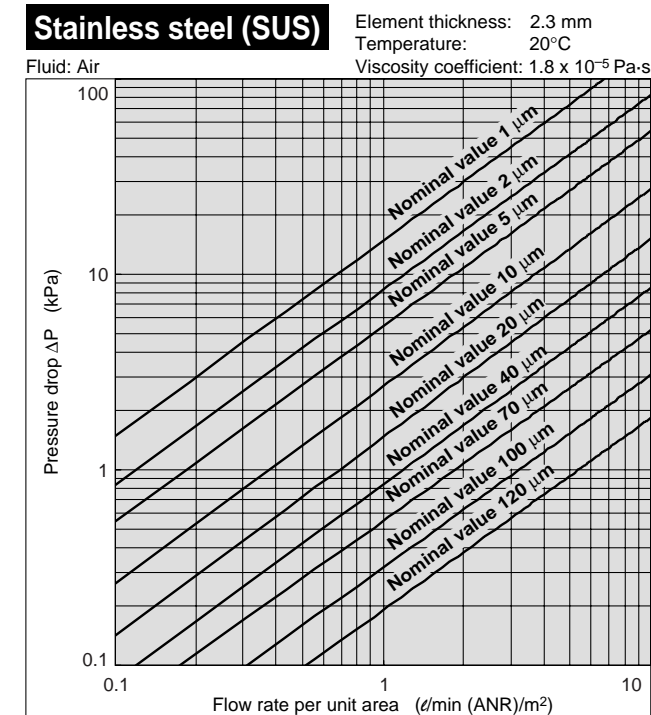
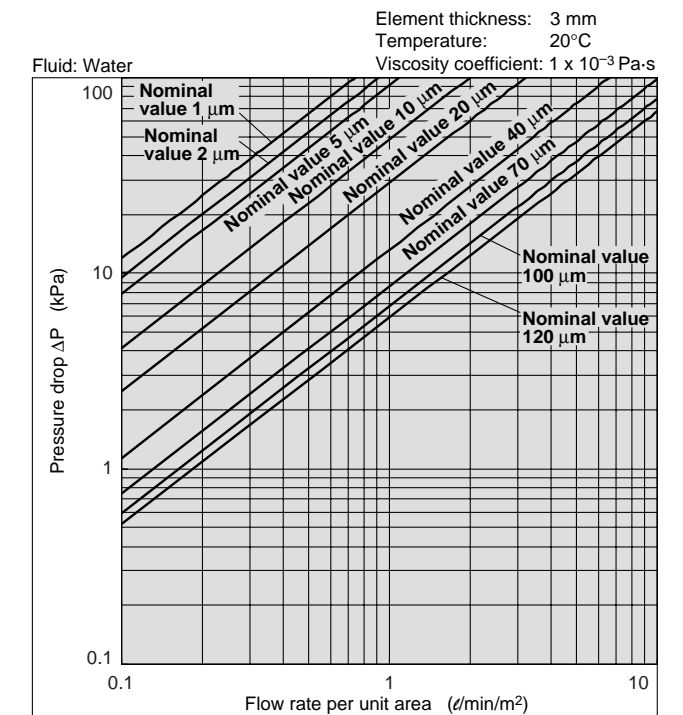
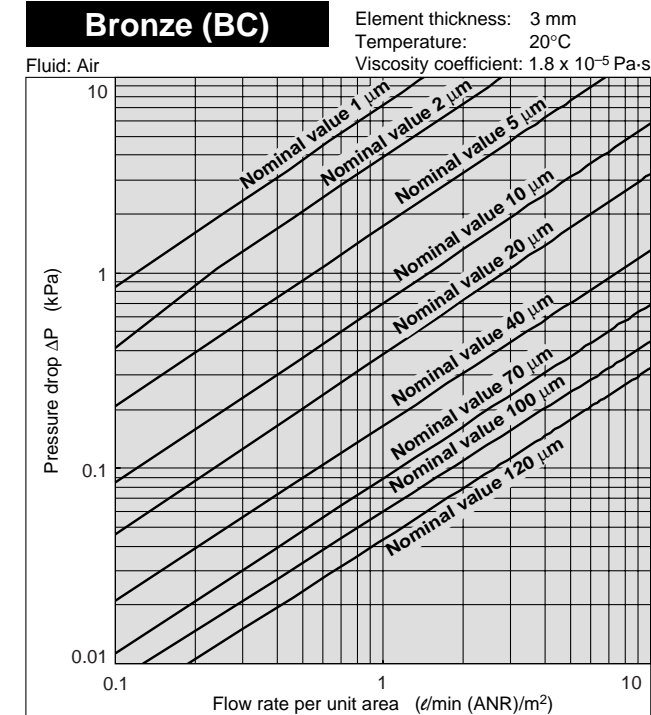

Note) Flow rate characteristics for stainless steel elements ESP-ESW (diameter 120 mm or less, no ESD seams) are different.

<Simplified formula for calculating pressure drop>

The state equation of an ideal gas (PV/T = constant) and the pressure drop are proportional to element thickness and viscosity. Based on this, the pressure drop under conditions that are different from those used in the flow rate characteristics chart can be calculated roughly for reference, using the following simplified procedure.

- Pressure drop ΔP kPa when flow medium is air, temperature T₁°C, pressurization P₁ kPa:

$$\Delta P = \frac{101.3 \times \Delta P_0 \times (273 + T_1)}{293 \times (P_1 + 101.3)}$$
 ΔP₀: Pressure drop kPa obtained from flow rate characteristics chart
- Element thickness dependent pressure drop ΔP kPa when flow medium is air and water, element thickness t₁ mm, and element thickness in flow rate characteristics chart differs:

$$\Delta P = \Delta P_0 \times \frac{t_1}{t_0^{(2.3 \text{ or } 3)}}$$
 ΔP₀: Pressure drop kPa obtained from flow rate characteristics chart or from (1)
 t₀: Element thickness in flow rate characteristics chart (BC element = 3 mm/ SUS element = 2.3 mm)
- Pressure drop ΔP kPa when viscosity η₁ of flow medium differs from that of air or water:

$$\Delta P = \Delta P_0 \times \frac{\eta_1}{\eta_0}$$
 ΔP₀: Pressure drop kPa obtained from flow rate characteristics chart
 η₁: Viscosity of flow medium Pa·s
 η₀: Viscosity of flow rate characteristics chart (air = 1.8 x 10⁻⁵ Pa·s, water = 1 x 10⁻³ Pa·s)

- FGD
- FGE
- FGG
- FGA
- FGB
- FGC
- FGF
- FGH
- EJ
- ED
- FQ1
- FN
- EB
- ES

Sintered Metal Element

Standard Configurations and Dimensions (Unit: mm)

Bronze (BC)

1. Disc

How to Order

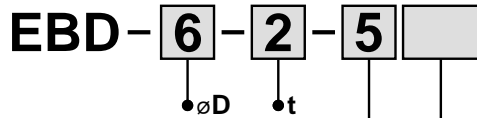

Nominal filtration accuracy (μm)

2
5
10
20
40
70
100
120

Outside diameter finish category

Nil	Without cutting finish
M	With cutting finish

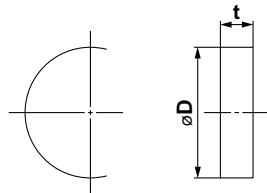
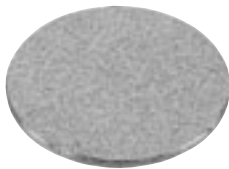

Standard dimensions product (no cutting finish)

ϕD	6	8	10	12	15	20
t	2	2	2	3	3	3
μm	2 to 120					

Note) For products with non-standard dimensions, sintering mold is required. Please contact SMC.

Manufacturing range for product without cutting finish

ϕD	2 to 30		
t	1	1.5	2 to 10
μm	2 to 20	2 to 40	2 to 120

Tolerance

ϕD	± 0.3
t	± 0.3

Note) Smallest unit for specifying diameter D values is 1 mm, and 0.5 mm for t values.

Manufacturing range for product with cutting finish

ϕD	30 to 200	30 to 300	30 to 400
t	1	1.5	2 to 10
μm	2 to 20	2 to 40	2 to 120

Tolerance

ϕD	± 0.3	$30 \leq D \leq 120$
	± 0.5	$120 < D \leq 315$
	± 0.8	$315 < D \leq 400$
t	± 0.3	
	± 0.5	$t: 5 \text{ to } 10$ (exceeds 300)

Note 1) Smallest unit for specifying diameter D and t values is 0.5 mm.

Note 2) Edge sections of products with a nominal filtration accuracy of 70 μm and higher may exhibit particle chipping and other machining problems.

* Minimum order quantity for products with diameter D < 100 is 10 pieces.

2. Square Sheet

How to Order

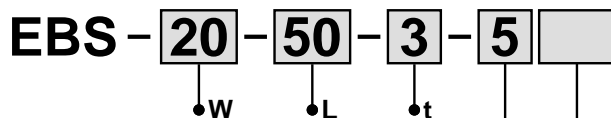

Nominal filtration accuracy (μm)

2
5
10
20
40
70
100
120

Circumference finish category

Nil	Product with shirring finish
M	Product with machining finish

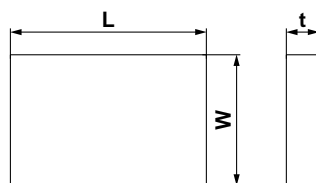
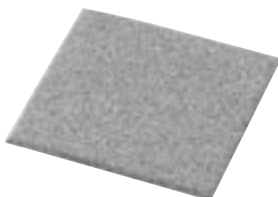

Manufacturing range for product with shearing finish

W (Width)	10 to 200	10 to 300	10 to 300
L (Length)	20 to 200	20 to 300	20 to 500
t	1	1.5	2 to 3
μm	2 to 20	2 to 40	2 to 120

Tolerance

W, L	± 1	$10 \leq W, L \leq 120$
	± 2	$120 < W, L \leq 500$
t	± 0.3	

Note 1) Smallest unit for specifying W and L values is 1 mm, and 0.5 mm for t values.

Note 2) When shearing is used, the cut section is a break surface which will have shear drops and cracks. To remove these, process at least 5 mm on one side.

Note 3) Edge sections of products with a nominal filtration accuracy of 70 μm and higher may exhibit particle chipping and other machining problems.

Manufacturing range for product with machining finish

W (Width)	5 to 200	5 to 30	30 to 300	5 to 30	30 to 300
L (Length)	5 to 200	5 to 200	30 to 300	5 to 200	30 to 500
t	1	1.5		2 to 10	
μm	2 to 20	2 to 40		2 to 120	

Tolerance

W, L	± 0.3	$5 \leq W, L \leq 30$
	± 0.5	$30 < W, L \leq 120$
	± 1	$120 < W, L \leq 315$
	± 1.5	$315 < W, L \leq 500$
t	± 0.3	
	± 0.5	$t: 5 \text{ to } 10$ (exceeds L300)

Note 1) Smallest unit for specifying W, L, and t values is 0.5 mm.

Note 2) Edge sections of products with a nominal filtration accuracy of 70 μm and higher may exhibit particle chipping and other machining problems.

* Minimum order quantity for products with either a W or L value below 150 is 10 pieces.

Sintered Metal Element

Standard Configurations and Dimensions (Unit: mm)



Bronze (BC)

3. Cylinder

How to Order

EBP - 10 - 200 - 3 - 5

$\varnothing D$ L t
 Nominal filtration accuracy (μm)

- 2
- 5
- 10
- 20
- 40
- 70
- 100
- 120

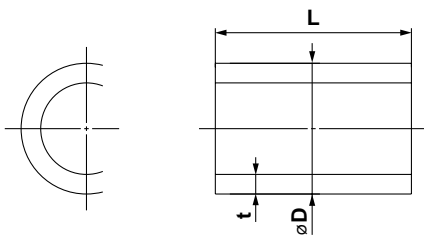

Standard dimensions product

$\varnothing D$	10	20	30	40	45	50	65	
L	200	200	200	200	200	250	250	500
t	2	2	2	2	2.5	3	3	
μm	2 to 120							

Manufacturing range

$\varnothing D$	L							
$10 \leq D \leq 20$	10 to 50	10 to 200						
$20 < D \leq 35$	20 to 80	20 to 200	20 to 300					
$35 < D \leq 45$		35 to 200	35 to 400					
$45 < D \leq 65$			45 to 500					
$65 < D \leq 130$				65 to 500				
$130 < D \leq 200$				130 to 500	130 to 300			
$200 < D \leq 250$					200 to 300			
t	1.5	2	2.5	3	4	5	6	
μm	2 to 40		2 to 120					

Tolerance (for standard and custom products)

$\varnothing D$	± 0.3	$10 \leq D \leq 30$
	± 0.5	$30 < D \leq 120$
	± 1	$120 < D \leq 250$
L	± 0.3	$10 \leq L \leq 30$
	± 0.5	$30 < L \leq 120$
	± 1	$120 < L \leq 315$
	± 1.5	$315 < L \leq 500$
t	± 0.3	

- Note 1) For a 200 mm length, there is a draft taper of 1 mm across. Therefore the diameter D tolerance refers to the value at the center of L.
- Note 2) End surfaces are created by cutting. Edge sections of products with a nominal filtration accuracy of 70 μm and higher may exhibit particle chipping and other machining problems.
- Note 3) Smallest unit for specifying diameter D and L values is 0.5 mm. Smallest unit for specifying t values is as noted in the table.
- Note 4) For products with non-standard dimensions, sintering mold is required. Please contact SMC.
- * Minimum order quantity for products with either diameter D < 65 or L < 100 is 10 pieces.

4. Cylinder with Bottom

How to Order

EBW - 8 - 20 - 2 - 5

$\varnothing D$ L t
 Nominal filtration accuracy (μm)

- 2
- 5
- 10
- 20
- 40
- 70
- 100
- 120

Opening side finish category

Nil	Without cutting finish
M	With cutting finish

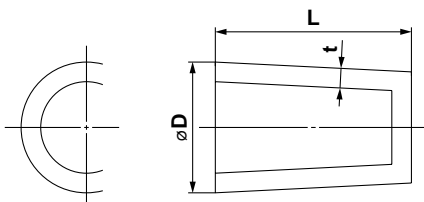

Standard dimensions product (no cutting finish)

$\varnothing D$	8	10	20	30
L	20		40	80
t	2			
μm	2 to 120			

Manufacturing range for product without cutting finish

$\varnothing D$	$7 \leq D \leq 10$		$10 < D \leq 20$			
L	7 to 10		10 to 50			
t	1.5	2	1.5	2	2.5	3
μm	2 to 40	2 to 120	2 to 40	2 to 120		

Manufacturing range for product with cutting finish

$\varnothing D$	$20 < D \leq 30$			$30 < D \leq 40$		
L	20 to 80			30 to 80		
t	1.5	2	2.5	3	2	3
μm	2 to 40	2 to 120		2 to 120		

Tolerance (for standard and custom products)

$\varnothing D$	± 0.3	$7 \leq D \leq 30$
	± 0.5	$30 < D \leq 40$
L	± 0.3	$10 \leq L \leq 30$
	± 0.5	$30 < L \leq 120$
	± 0.3	

- Note 1) There is a draft taper of 1 mm across.
- Note 2) Opening side end surface is created by cutting. Edge sections of products with a nominal filtration accuracy of 70 μm and higher may exhibit particle chipping and other machining problems.
- Note 3) Smallest unit for specifying diameter D and L values is 0.5 mm. Smallest unit for specifying t values is as noted in the table.
- Note 4) For products with non-standard dimensions, sintering mold is required. Please contact SMC.
- * Minimum order quantity is 10 pieces.

FGD

FGE

FGG

FGA

FGB

FGC

FGF

FGH

EJ

ED

FQ1

FN

EB

ES

Sintered Metal Element

Standard Configurations and Dimensions (Unit: mm)

Bronze (BC)

5. Cone with Flange

How to Order

EBF - 9 - 10 - 1 - 5

$\phi D1$ L t1 Nominal filtration accuracy (μm)

2
5
10
20
40
70
100
120

Standard dimensions product

$\phi D1$ (± 0.5)	9	10	12	15	20
$\phi D2$ (± 0.5)	7	8	9	11	15
L (± 0.5)	10		11	13	14
t1 (± 0.3)	1	1.5		2	3
t2 (± 0.3)	2	2	2	2	3
μm	2 to 20	2 to 40	2 to 120		

Note) Figures in brackets indicate tolerance.
 * Minimum order quantity is 10 pieces.

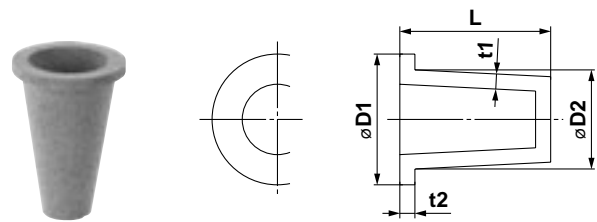

6. Element with Fitting (Standard product)

EBKX model number

Connection thread	Model number	Dimensions			Configuration
		A	B	C	
M3	EBKX-X9007-□	9.7	8	12	①
M5	EBKX-X9008-□	9.7	8	12	①
R1/8	EBKX-L7004-□	13.5	8	11	①
R1/4	EBKX-J2001-□	47.3	17	21	②
	EBKX-L7005-□	19	19	21	①
R3/8	EBKX-J2002-□	48.3	17	21	②
	EBKX-L7006-□	20	19	21	①
R1/2	EBKX-J2003-□	51.3	17	21	②
	EBKX-L7007-□	23	19	21	①



Model number suffix □ (nominal filtration accuracy) definition

symbol	Nominal filtration accuracy
002	2 μm
005	5 μm
010	10 μm
020	20 μm
040	40 μm
070	70 μm
100	100 μm
120	120 μm

Example: Nominal filtration accuracy 2 μm
 EBKX-J2001-002

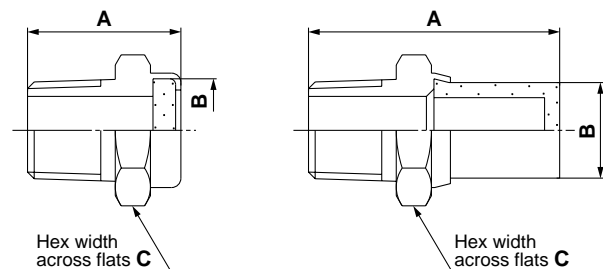

① Crimping

② Crimping

* Minimum order quantity is 10 pieces.

Sintered Metal Element

Standard Configurations and Dimensions (Unit: mm)

Stainless steel (SUS)

1. Disc

How to Order

ESD - **4** - **2** - **5**

∅D

t

Nominal filtration accuracy (μm)

2
5
10
20
40
70
100
120

Outside diameter finish category

No symbol	Without cutting finish
M	With cutting finish

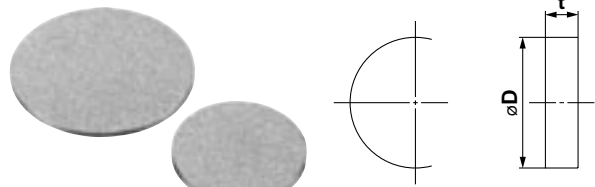

Standard dimensions product (no cutting finish)

∅D	4	5	6	8	10	12	15	20
t	2	2	2	2	3	3	3	3

Manufacturing range for product without cutting finish

∅D	2 ≤ D < 4	4 ≤ D ≤ 30
t	1 to 4	1 to 10

Tolerance

∅D	± 0.3
t	± 0.2

Note 1) For products with non-standard dimensions, sintering mold is required. Please contact SMC.

Note 2) Smallest unit for specifying diameter D values is 1 mm, and 0.5 mm for t values.

Manufacturing range for product with cutting finish (no welding)

∅D	20 to 220	220.5 to 350
t	1 to 3, 4, 5	(3), 4, 5

Tolerance

∅D	± 0.3	20 ≤ D ≤ 120
	± 0.5	120 < D ≤ 315
	± 0.8	315 < D ≤ 350
t	± 0.2	

Note 1) Smallest unit for specifying diameter D values is 0.5 mm, and 0.5 mm for t values of 3 mm or less.

Note 2) Figures in brackets manufacturing range for nominal filtration accuracy 2 μm.

Manufacturing range for product with cutting finish (with welding)

∅D	Welding pattern	t
221 ≤ D ≤ 440	①	2 to 3
440 < D ≤ 500	②	2 to 3
500 < D ≤ 660	④	3
660 < D ≤ 880	⑤	3
880 < D ≤ 1000	⑥	3
350 < D ≤ 700	③	(3), 4, 5

Tolerance

∅D	± 0.5	221 ≤ D ≤ 315
	± 0.8	315 < D ≤ 800
	± 2	800 < D ≤ 1000
t	± 0.2 (excluding welded sections)	

Note 1) Smallest unit for specifying diameter D values is 0.5 mm, and 0.5 mm for t values of 3 mm or less.

Note 2) Products with t = 2 to 3 and D ≥ 221, or t = (3), 4, 5 and D ≥ 350 have welded seams.

Products with t ≥ 3 have dual-sided welding. Figures in brackets indicate manufacturing range for nominal filtration accuracy 2 μm.

Note 3) Products with outside diameter D ≥ 800 are finished by manual grinding.

Welded sections are wire brushed to remove oxide scales. (Oxide bath cleaning is not performed.)

(Welding patterns)

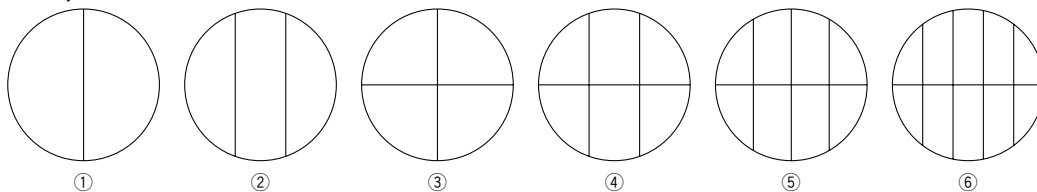

* Minimum order quantity for products with diameter D < 100 is 10 pieces.

FGD

FGE

FGG

FGA

FGB

FGC

FGF

FGH

EJ

ED

FQ1

FN

EB

ES

Sintered Metal Element

Standard Configurations and Dimensions (Unit: mm)

Stainless steel (SUS)

2. Square Sheet

How to Order

ESS - **20** - **50** - **3** - **5**

• **W** • **L** • **t**

Nominal filtration accuracy (μm) •

2
5
10
20
40
70
100
120

• **Outside finish category**

No symbol	Product with shearing finish
M	Product with machining finish

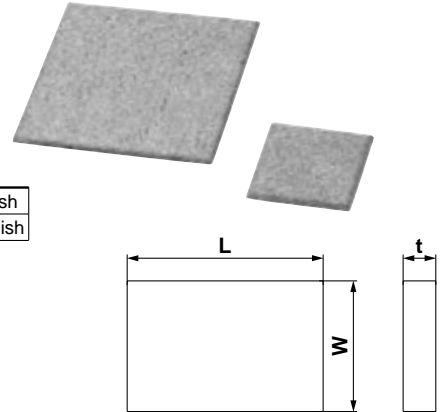

Manufacturing range for product with shearing finish (no welding)

W (Width)	10 to 220	10 to 220
L (Length)	20 to 220	20 to 500
t	1, 1.5	2 to 3

Welded product

W (Width)	221 to 500	20 to 1000
L (Length)	221 to 500	501 to 1000
t	2 to 3	3

Tolerance

W, L	± 1	20 ≤ W, L ≤ 120
	± 2	120 < W, L ≤ 1000
t	± 0.2 (excluding welded sections)	

Note 1) Smallest unit for specifying W and L values is 1 mm, and 0.5 mm for t values.

Note 2) When shearing is used, the cut section is a break surface which will have shear drops and cracks. To remove these, process at least 5 mm on one side.

Manufacturing range for product with machining finish (no welding)

W (Width)	5 ≤ W < 221	5 ≤ W ≤ 30	30 ≤ W < 221	5 ≤ W ≤ 30	30 ≤ W ≤ 350
L (Length)	5 ≤ L < 221	5 ≤ L ≤ 200	30 ≤ L < 501	5 ≤ L ≤ 200	30 ≤ L ≤ 350
t	1, 1.5	2 to 3		(3), 4, 5	

Tolerance

W, L	± 0.3	5 ≤ W, L ≤ 30
	± 0.5	30 < W, L ≤ 120
	± 1	120 < W, L ≤ 315
	± 1.5	315 < W, L < 501
t	± 0.2	

Note 1) Smallest unit for specifying W and L values is 0.5 mm, and 0.5 mm for t values of 3 mm or less.

Note 2) Figures in brackets indicate manufacturing range for nominal filtration accuracy 2 μm.

Manufacturing range for product with machining finish (with welding)

W (Width)	221 ≤ W ≤ 450	40 ≤ W ≤ 450	40 ≤ W ≤ 1000
L (Length)	221 ≤ L < 501	501 ≤ L ≤ 1000	351 ≤ L ≤ 1000
t	2 to 3	3	(3), 4, 5

Tolerance

W, L	± 0.5	40 < W, L ≤ 120
	± 1	120 < W, L ≤ 315
	± 1.5	315 < W, L < 1000
	± 5	t ≥ 4 (W > 450)
t	± 0.2 (excluding welded sections)	

Note 1) Smallest unit for specifying W and L values is 0.5 mm, and 0.5 mm for t values of 3 mm or less.

Note 2) Products with W > 450 are cut sheets welded together which may have a slight shift or uneven height.

Note 3) Figures in brackets indicate manufacturing range for nominal filtration accuracy 2 μm.

Welding pattern (t = 2 to 3)

W (Width)	L (Length)	Configuration	Number of sheets	
			W	L
20 ≤ W < 221	501 ≤ L ≤ 1000	①	1	2
221 ≤ W < 441	221 ≤ L < 442	①	1	2
	442 ≤ L < 501		2	1
441 ≤ W < 501	501 ≤ L ≤ 1000	③	2	2
	442 ≤ L < 501	①	2	1
	501 ≤ L < 661	②	1	3
501 ≤ W < 661	661 ≤ L ≤ 1000	③	2	2
	501 ≤ L ≤ 1000	④	2	3
661 ≤ W < 801	661 ≤ L ≤ 1000	⑥	4	2
801 ≤ W ≤ 1000	801 ≤ L ≤ 1000	⑦	5	2

Welding pattern (t = (3), 4, 5)

W (Width)	L (Length)	Configuration	Number of sheets	
			W	L
40 ≤ W < 351	351 ≤ L < 701	①	1	2
	701 ≤ L ≤ 1000	②	1	3
351 ≤ W < 701	351 ≤ L < 701	③	2	2
	701 ≤ L ≤ 1000	④	2	3
701 ≤ W ≤ 1000		⑤	3	3

Note 1) Products with t = 2 to 3 and W ≥ 221, L ≥ 501 or t = (3), 4, 5 and W, L ≥ 350 have welded seams. Products with t ≥ 3 have dual-sided welding.

Note 2) Welded sections of products with W, L ≥ 800 are wire brushed to remove oxide scales. (Oxide bath cleaning is not performed.)

(Welding patterns)

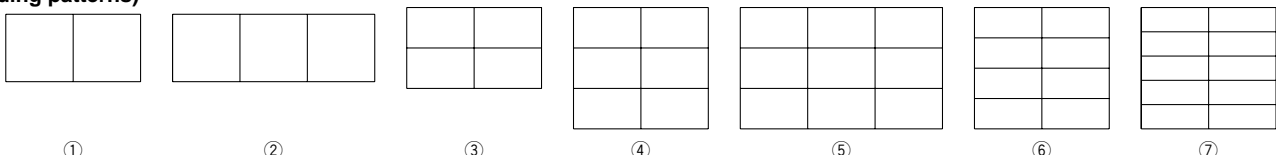

* Minimum order quantity for products with W or L below 150 is 10 pieces.

Sintered Metal Element

Standard Configurations and Dimensions (Unit: mm)

Stainless steel (SUS)

3. Cylinder

How to Order

ESP - **20** - **50** - **3** - **5**

Nominal filtration accuracy (μm)

2
5
10
20
40
70
100
120

Cylinder outside diameter finish category

No symbol	Seamless finish (molded product)
W	With seams (welded product)

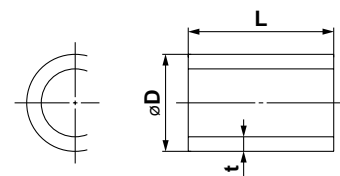

Standard dimensions product (seamless)

ϕD	4	5	6	8	10	12	15	20	30
L	16	20	20	30	40	40	40	50	60
t	1, 1.5		1.5, 2			2, 3		3	

Manufacturing range for seamless product

ϕD	L (*: 2 weld seams dimensions)								
$4 \leq D < 5$	5 to 16								
$5 \leq D < 8$	5 to 20								
$8 \leq D < 11$	5 to 30								
$11 \leq D < 15$	5 to 40								
$15 \leq D < 18$		5 to 40							
$18 \leq D < 21$		5 to 50							
$21 \leq D < 26$		5 to 50 (100 *)							
$26 \leq D \leq 30$		10 to 60 (120 *)							
t	1	1.5	2	2.5	3	3.5	4	4.5	5

Tolerance

ϕD	± 0.3	$4 \leq D \leq 20$
	± 0.5	$20 < D \leq 30$
	± 1	*: 2 weld seams
L	± 0.3	$5 \leq L \leq 30$
	± 0.5	$30 < L \leq 60$
	± 2	*: 2 weld seams
t	± 0.2	

Note 1) For products with non-standard dimensions, sintering mold is required. Please contact SMC.

Note 2) Smallest unit for specifying diameter D and L values is 0.5 mm. Smallest unit for specifying t values is as noted in the table. Products with 2 weld seams are only available in the dimensions indicated in the table.

Note 3) Products with 2 weld seams may have some curvature or uneven height.

Note 4) End finish: no cutting (for 2 μm or less, and $L > 40$, cutting finish is provided)

Standard dimensions product (with seams)

ϕD	30		40		50		65	
L	250	500	250	500	250	500	250	500
t	2						2.3	

Manufacturing range for product with seams

ϕD	10 to 14	15 to 19	20 to 29	30 to 39	40 to 49	50 to 73	74 to 150
L (*: 2 weld seams dimensions)	10 to 500		10 to 500 (1000 *)				50 to 500 (1000 *)
t	1	1 to 1.5	1 to 2	1.5 to 2	1.5 to 2.5	1.5 to 3	2 to 3

Tolerance

ϕD	± 1.5	10 to 73
	± 2	74 to 150
L	± 0.3	$10 \leq L \leq 30$
	± 0.5	$30 < L \leq 120$
	± 1	$120 < L \leq 315$
	± 1.5	$315 < L \leq 500$
	± 3	$500 < L \leq 1000$
t	± 0.2	

Note 1) Smallest unit for specifying diameter D and L values is 1mm, and 0.5mm for t values. Dimension in brackets for 2-seam products refer to maximum length.

Note 2) Products with $D \geq 74$ have 2 seams in length-wise direction.

Note 3) End finish: with cutting.

* Minimum order quantity for products with either diameter $D < 65$ or $L < 100$ is 10 pieces.

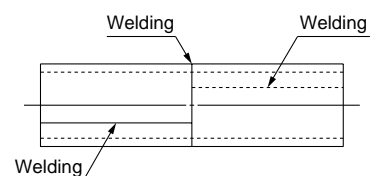
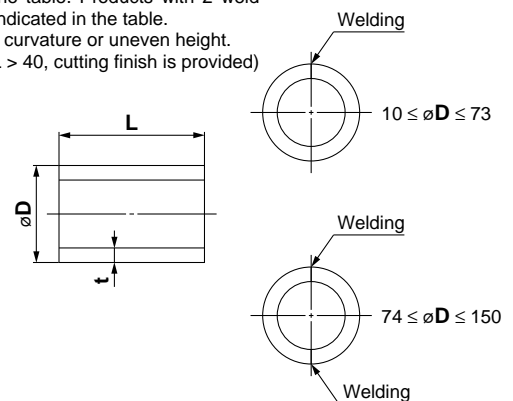

FGD

FGE

FGG

FGA

FGB

FGC

FGF

FGH

EJ

ED

FQ1

FN

EB

ES

Sintered Metal Element

Standard Configurations and Dimensions (Unit: mm)



Stainless steel (SUS)

4. Cylinder with Bottom

How to Order

ESW- 8 - 10 - 2 - 5

∅D

L

t

Nominal filtration accuracy (μm)

2
5
10
20
40
70
100
120

Cylinder outside diameter finish category

No symbol	Seamless finish (molded product)
M	With seams (welded product)

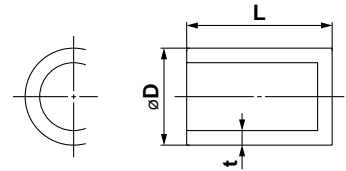

Standard dimensions product (seamless)

∅D	8	10	12	15	20	30
L	10	20	20	20	40	50
t	2		3			

Manufacturing range for seamless product

∅D	L									
5 ≤ D < 8	5 to 20									
8 ≤ D < 11	5 to 30									
11 ≤ D < 15	5 to 40									
15 ≤ D < 18		5 to 40								
18 ≤ D < 21		5 to 50								
21 ≤ D < 26			5 to 50							
26 ≤ D ≤ 30			10 to 60							
t	1	1.5	2	2.5	3	3.5	4	4.5	5	

Tolerance

∅D	± 0.3	4 ≤ D ≤ 20
	± 0.5	20 < D ≤ 30
L	± 0.3	5 ≤ L ≤ 30
	± 0.5	30 < L ≤ 60
t	± 0.2	

Note 1) For products with non-standard dimensions, sintering mold is required. Please contact SMC.

Note 2) Smallest unit for specifying diameter D and L values is 0.5 mm. Smallest unit for specifying t values is as noted in the table.

Note 3) End finish: no cutting (For 2 μm or less, and L > 40, cutting finish is provided.)

Standard dimensions product (with seams)

∅D	30		40		50		65	
L	250	500	250	500	250	500	250	500
t	2						2.3	

Manufacturing range for product with seams

∅D	10 to 14	15 to 19	20 to 29	30 to 39	40 to 49	50 to 73	74 to 150
L	10 to 500		10 to 500 (1000 *)				50 to 500 (1000 *)
t	1	1 to 1.5	1 to 2	1.5 to 2	1.5 to 2.5	1.5 to 3	2 to 3

Tolerance

∅D	± 1.5	10 to 73
	± 2	74 to 150
L	± 0.3	10 ≤ L ≤ 30
	± 0.5	30 < L ≤ 120
	± 1	120 < L ≤ 315
	± 1.5	315 < L ≤ 500
	± 3	500 < L ≤ 1000
t	± 0.2	

Note 1) Smallest unit for specifying diameter D and L values is 1 mm, and 0.5 mm for t values. Dimensions in brackets for 2-seam products refer to maximum length.

Note 2) Products with D ≥ 74 have 2 seams in length-wise direction.

Note 3) End finish: with cutting.

* Minimum order quantity for products with either diameter D < 65 or L < 100 is 10 pieces.

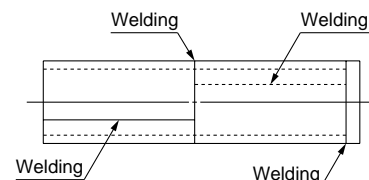
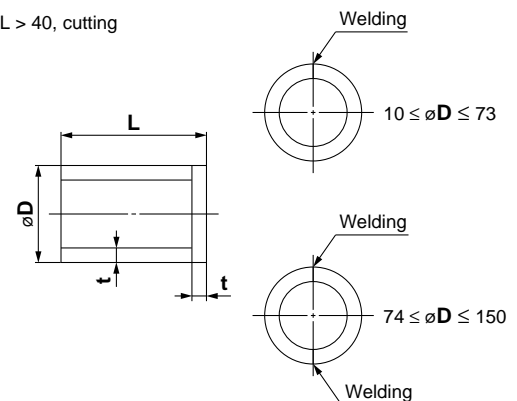

Sintered Metal Element

Standard Configurations and Dimensions (Unit: mm)

Stainless steel (SUS)

5. Element with Fitting (Standard product)

ESKA model number

Connection thread	Model number	Dimensions			Configuration
		A	B	C	
M3	ESKA-Z2701-□	9	6	N/A *1	①
	ESKA-Z2711-□	9.7	8	14	②
M5	ESKA-Z2702-□	17	8	N/A *1	①
	ESKA-Z2712-□	9.7	8	14	②
R1/8	ESKA-Z2801-□	38	13	N/A *2	③
	ESKA-Z2811-□	13.5	8	14	②
R1/4	ESKA-Z2802-□	52	17	17	③
	ESKA-Z2812-□	19	19	21	②
R3/8	ESKA-Z2803-□	53	17	17	③
	ESKA-Z2813-□	20	19	21	②
R1/2	ESKA-Z2804-□	58	17	22	③
	ESKA-Z2814-□	19.3	19	21	②



Model number suffix □ (nominal filtration accuracy) definition

symbol	Nominal filtration accuracy
002	2 μm
005	5 μm
010	10 μm
020	20 μm
040	40 μm
070	70 μm
100	100 μm
120	120 μm

Example: Nominal filtration accuracy 2 μm

ESKA-Z2701-002

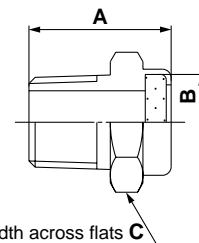
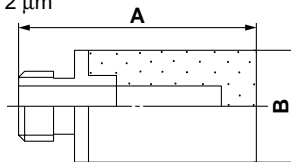

Hex width across flats C

① Simultaneous sintering (*1)

② Crimping

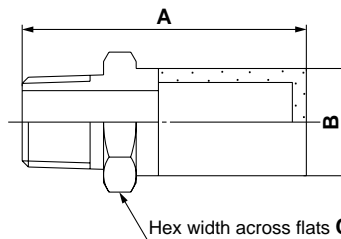

③ Welding

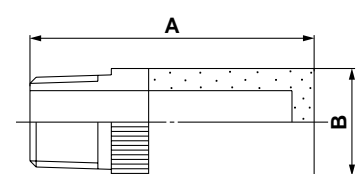

(*2)

* Minimum order quantity is 10 pieces.

FGD

FGE

FGG

FGA

FGB

FGC

FGF

FGH

EJ

ED

FQ1

FN

EB

ES

Sintered Metal Element

Cleaning Method

Select a suitable cleaning method as shown below, according to the substance type and clogging condition. A combination of both methods may yield greater results.

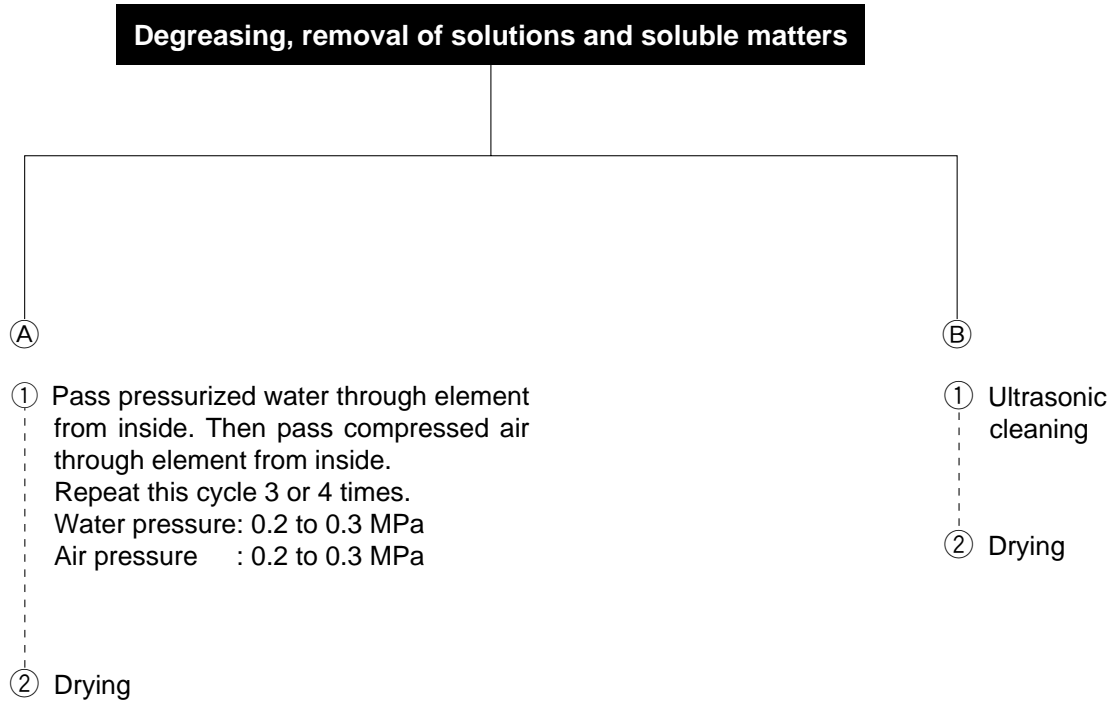



Sintered Metal Element Specific Product Precautions 1

Be sure to read before handling.

Precautions on Design

⚠ Caution

1. Tensile strength

The elements are made of porous material with voids inside. Therefore their tensile strength compared to conventional stainless steel or bronze products is lower by a factor of one or two magnitudes. Depending on the application conditions, reinforcing material may be required. Use punched metal or similar for reinforcement.

2. Operating temperature

The operating temperature range given in the specifications (page 842) is the range in which material strength does not deteriorate significantly.

In an oxidizing atmosphere (atmospheric air), the temperature point where oxidization and discoloring begins is 100°C for bronze elements and 250°C for stainless steel elements.

3. Wrench sleeve

For elements equipped with a fitting, provide a wrench sleeve at the fitting. If the element is grasped directly with a tool, the element may be damaged or destroyed.

4. Fatigue breakdown

Fatigue breakdown may occur under the following conditions:

- 1) Element is subject to vibrations
- 2) Element is subject to cyclic thermal expansion and contraction

In such cases, use suitable countermeasures such as vibration dampers or punched metal reinforcements to support the element, or employ a construction that absorbs thermal expansion and contraction.

5. End configuration

For information on end configurations of cylinder elements (open or with bottom), check the notes and configuration information on the page for the respective product in this catalog. When devising applications, make sure that there are no problems such as improper sealing or leaks due to the end configurations.

6. Particle separation

When cutting is performed, particle chipping will occur at edge sections. This is especially noticeable with products rated for high nominal filtration accuracy (μm) values. Particle chipping and other machining problems may also occur at edges of products that are not finished by cutting. Carefully check sealing properties before use.

7. Welded products (Stainless steel elements)

Welded stainless steel elements are produced by argon welding. Consequently, problems such as uneven height, distortion, warping, raised beads etc. may be present.

Discoloration of sections exposed to heat may not be completely removed by cleaning.

8. Cleaning

Sintered metal elements are cleaned before shipping, but not to clean room standards. Before use in a clean room, elements must be cleaned and flushed by the customer, and application suitability must be verified.

Bronze element	Oxide bath cleaning → Anti-corrosive treatment	Note)
Stainless steel element	Oxide bath cleaning → Passivation (Nitric acid bath)	Welded products
	Passivation (Nitric acid bath)	Non-welded finished products
	Freon ultrasonic cleaning	Non-welded non-finished products

Note) Anti-corrosive treatment is not intended to provide corrosion resistance during use or long-term storage capability. It is a simple treatment intended to prevent discoloration.

Products with nominal filtration accuracy of 2 to 10 micron and 5 t or higher may exhibit discoloration by oxide bath cleaning.

9. Corrosion

Note that corrosion will occur, depending on usage and ambient conditions. Major corrosive substances and corrosion conditions are listed below. Be sure to check this information.

Bronze elements

Category	Corrosive substances and corrosion conditions
Acid, alkali	Use in nitric acid, sulfur, and hydrochloric acid not possible, due to corrosion
	Use in solutions with ferric or cupric ion content or ammonium content not possible, due to corrosion
Atmosphere	Corrosion caused by hydrogen sulfide (H_2S) and sulfuric acid (SO_2)
Sea water	Products have some resistance but long-term use will cause corrosion
Fresh water	Corrosion caused by presence of carbonic acid (carbonation)

Stainless steel elements

Category	Corrosive substances and corrosion conditions
Acid, alkali, etc.	Sulfur, hydrochloric acid, etc. Corrosion may be accelerated by density, temperature, halogen (especially chlorine) ion content, etc.
	Nitric acid Compared to sulfur, hydrochloric acid etc., resistance is better due to passivity, but under certain conditions, corrosion may occur.
	Corrosion due to sodium hydroxide and potassium hydroxide Corrosion will be intensified by introduction of dissolved oxygen Sodium chloride, sodium bromide etc.
Atmosphere	Corrosion caused by CO_2 , SO_2 , NH_3 etc. in the atmosphere, and by temperature and other atmospheric conditions
Sea water	Corrosion depending on chlorine ion content, dissolved oxygen content, and organic matter
Fresh water	Corrosion caused by halogen (especially chlorine) ion content, deposits, etc.
	Corrosion caused by presence of carbonic acid (carbonation)
High-temperature water	Corrosion is accelerated at higher temperatures
Steam	Corrosion is accelerated at higher temperatures

10. Discoloration

Elements are processed with a simple anti-corrosive treatment to prevent discoloration, but this is not intended to provide long-term storage properties. After use, discoloration can be caused by foreign matter deposits, oxidization by flow medium, and other conditions.

With bronze elements in particular, moisture in the atmosphere will lead to the formation of a dark red CuO film. Discoloration after use is to be considered unavoidable.

FGD

FGE

FGG

FGA

FGB

FGC

FGF

FGH

EJ

ED

FQ1

FN

EB
ES



Sintered Metal Element Specific Product Precautions 2

Be sure to read before handling.

Precautions on Design

⚠ Caution

11. Nominal filtration accuracy

Nominal filtration accuracy of sintered metal elements is a classification rating using the particle size of the raw material. (This is different from the filtration rating with regard to the flow medium.) For reference, particle sizes that can be removed with an efficiency of 95% (in air and water) at different nominal filtration accuracy ratings are listed below.

Nominal filtration accuracy and 95% removable particle sizes (reference)

Nominal filtration accuracy (μm)	95% removable particle size (μm)			
	Flow medium: Air		Flow medium: Water	
	Bronze (BC)	Stainless steel (SUS)	Bronze (BC)	Stainless steel (SUS)
120	—	—	244	110
100	—	—	177	87
70	—	—	104	66
40	3.6	2.5	90	45
20	2.8	2	59	31
10	2.1	1.5	32	20
5	1.5	1.1	20	15
2	1	0.7	17	10

Installation

⚠ Caution

1. Installation of standard elements with fitting

- 1) Connection thread M3
First tighten by hand and then use a suitable wrench on the hex sleeve of the fitting to tighten further by about 1/4 turn.
Tighten the ESKA-Z2701-□ by hand. Do not grip the sintered part with pliers or other tools.
- 2) Connection thread M5
First tighten by hand and then use a suitable wrench on the hex sleeve of the fitting to tighten further by about 1/6 turn.
Tighten the ESKA-Z2702-□ by hand. Do not grip the sintered part with pliers or other tools.
- 3) Connection thread R (pipe taper thread)
First tighten by hand and then use a suitable wrench on the hex sleeve of the fitting to tighten further.

Connection thread	Suitable tightening torque (N·m)
R1/8	7 to 9 *
R1/4	12 to 14
R3/8	22 to 24
R1/2	28 to 30

* Tighten the ESKA-Z2801-□ by hand. Do not grip the sintered part with pliers or other tools.

Operating Environment

⚠ Caution

1. **Discoloration and material degradation may occur if used in a corrosive atmospheric environment.**
Severe corrosion will cause the product to lose its filtering functionality.
2. **When the product is subject to vibrations or shock, fatigue breakdown may occur. Provide suitable reinforcement to avoid such conditions.**

Storage

⚠ Caution

1. **Keep the product indoors and in its packing until use.**
Protect the product from water, humidity, and high temperatures, to avoid discoloration and corrosion.
2. **Do not place any objects on top of the product.**
Otherwise there is a risk of deformation or breakage.

Maintenance

⚠ Caution

1. **Pressure drop ΔP will change depending on operating conditions.**
Pressure drop ΔP is one of the performance parameters of the element. Establish suitable management standards for this parameter.
2. **Be aware of individual product warranty conditions and exclusions.**
In the case of sintered metal products, conditions such as filter performance degradation due to clogging and discoloration are not covered by the warranty, even during the warranty period.