

Compact Cylinder/Guide Rod Type

Series CQM



Lateral load
resisting
2 to 4 times

* Compared to compact
cylinder Series CQ

Non-rotating
accuracy
±0.2° or less

Refer to page 1000
for details.

Guide Rod

*Load can be directly
mounted.*

*Mounting dimensions
compatible with
Series CQS, CQ2.*

External dimensions

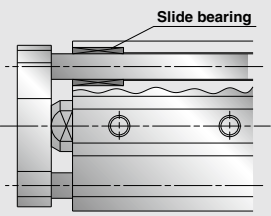
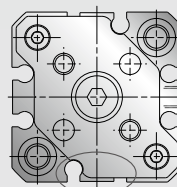

Auto switch is mountable/removable even when
the plate is retracted.

CUJ

CU

CQS

CQ2

-Z

RQ

CQM

CQU

MU

-Z

D-

-X

Technical
data

Series Variations

Series	Bore size (mm)	Standard stroke (mm)											Cushion				
		5	10	15	20	25	30	35	40	45	50	75		100			
CQM	12, 16	●	●	●	●	●	●	●	●	●	●	●	●	●	●	●	Rubber bumper
	20, 25	●	●	●	●	●	●	●	●	●	●	●	●	●	●	●	
	32, 40	●	●	●	●	●	●	●	●	●	●	●	●	●	●	●	
	50, 63, 80, 100	●	●	●	●	●	●	●	●	●	●	●	●	●	●	●	

Compact Cylinder: Guide Rod Type

Series CQM

ø12, ø16, ø20, ø25, ø32, ø40, ø50, ø63, ø80, ø100

How to Order

CQM **B** **20** - **15**

With auto switch

CDQM **B** **20** - **15** - **M9BW**

With auto switch
(Built-in magnet)

Mounting bracket

B	Through-hole (Standard)
A	Both ends tapped (ø32 to ø100)

Note 1) Cylinder bodies of ø12 to ø25 are common for both B (through hole) and A (both ends tapped) types. Symbol to order is unified to "B" for those sizes.

Note 2) Cylinder mounting bolts are not included. Order them separately referring to Mounting Bolts for CQM on pages 1002 and 1003.

Note 3) Contact SMC for the other mounting types.

Bore size

12	12 mm	40	40 mm
16	16 mm	50	50 mm
20	20 mm	63	63 mm
25	25 mm	80	80 mm
32	32 mm	100	100 mm

Number of auto switches

Nil	2 pcs.
S	1 pc.
n	"n" pcs.

Auto switch type

Nil	Without auto switch
------------	---------------------

* Refer to the table below for the applicable auto switch model.

Cylinder stroke (mm)

Refer to page 999 for standard and intermediate strokes.

Thread type

Nil	M thread	ø12 to ø25
	Rc	
TN	NPT	ø32 to ø100
TF	G	

Note) M thread to be used for without auto switch type of ø32, 5 stroke exceptionally. There is no need to enter the symbol when ordering.

Built-in Magnet Cylinder Model

If a built-in magnet cylinder without an auto switch is required, there is no need to enter the symbol for the auto switch. (Example) CDQMB32-10

Applicable Auto Switches

Refer to pages 1559 to 1673 for further information on auto switches.

Type	Special function	Electrical entry	Indicator light	Wiring (Output)	Load voltage		Auto switch model		Lead wire length (m)					Pre-wired connector	Applicable load
					DC	AC	Perpendicular ø12 to ø25	In-line ø32 to ø100	0.5 (Nil)	1 (M)	3 (L)	5 (Z)	None (N)		
Solid state auto switch	—	Grommet	—	3-wire (NPN)	5 V,	—	M9NV	M9N	●	●	●	○	○	Relay, PLC	
				12 V	M9PV		M9P	●	●	●	○				
		Connector	—	2-wire	12 V	M9BV	M9B	●	●	●	○	○			
				—	J79C	—	—	—	—	—	—	—			
	Diagnostic indication (2-color indication)	Yes	—	3-wire (NPN)	5 V,	M9NWV	M9NW	●	●	●	○	○			
				12 V	M9PWV	M9PW	●	●	●	○	○				
	Water resistance (2-color indication)	Grommet	—	3-wire (PNP)	12 V	M9BWW	M9BW	●	●	●	○	○			
				2-wire	12 V	M9NAV***	M9NA***	○	○	●	○	○			
	With diagnostic output (2-color indication)	—	—	3-wire (NPN)	5 V,	M9PA***	M9PA***	○	○	●	○	○			
				12 V	M9BAV***	M9BA***	○	○	●	○	○				
Magnetic field resistant (2-color indication)	—	—	4-wire	5 V, 12 V	—	F79F	●	—	●	○	○				
			2-wire (Non-polar)	—	—	P4DW**	—	—	●	●	○	○			
Reed auto switch	—	Grommet	Yes	3-wire (NPN equiv.)	5 V	—	A96V	A96	●	—	●	—	—	Relay, PLC	
				—	200 V	—	A72	—	A42H	●	—	●	—		
				12 V	100 V	—	A93V	—	A93	●	—	●	—		
		Connector	No	—	2-wire	5 V, 12 V	100 V or less	A90V	A90	●	—	●	—		IC circuit
					12 V	—	A73C	—	—	●	—	●	—		
		Grommet	Yes	—	2-wire	5 V, 12 V	24 V or less	A80C	—	●	—	●	—		IC circuit
					—	—	A79W	—	—	●	—	●	—		

*** Water resistant type auto switches can be mounted on the above models, but in such case SMC cannot guarantee water resistance. Consult with SMC regarding water resistant types with the above model numbers.

* Lead wire length symbols: 0.5 m..... Nil (Example) M9NV
1 m..... M (Example) M9NWM
3 m..... L (Example) M9NWV
5 m..... Z (Example) M9NWZ
None..... N (Example) J79CN

* Solid state auto switches marked with a "○" are produced upon receipt of order.
** D-P4DWL type is compatible with bore sizes ø40 to ø100.
* Only D-P4DW type is assembled when shipped.

* Besides the models in the above catalog, there are some other auto switches that are applicable. For more information, refer to page 1009.

* Refer to pages 1626 and 1627 for the details of auto switches with a pre-wired connector.

* When mounting D-A9C(V)/M9C(V)/M9C(W)(V)/M9C(A)(V) types on a side other than the port side with ø32 to ø50 cylinders, order auto switch mounting brackets separately. Refer to page 1009 for details.



⚠ Caution

- ① Do not use the product as a stopper.
- ② Do not disassemble and modify the product.

Symbol

Rubber bumper

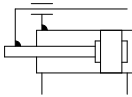

Specifications

Bore size (mm)	12	16	20	25	32	40	50	63	80	100
Model	Pneumatic (non-lube) type									
Action	Double acting, Single rod									
Fluid	Air									
Proof pressure	1.5 MPa									
Maximum operating pressure	1.0 MPa									
Minimum operating pressure	0.12 MPa					0.1 MPa				
Ambient and fluid temperature	Without auto switch: -10°C to 70°C (No freezing) With auto switch: -10°C to 60°C (No freezing)									
Cushion	Rubber bumper on both ends									
Stroke length tolerance	+1.0 mm* 0									
Mounting	Through-holes									
Piston speed	50 to 500 mm/s					50 to 300 mm/s				

* Stroke length tolerance does not include the amount of dumper change.

Standard Stroke

Bore size (mm)	Standard stroke (mm)
12,16	5, 10, 15, 20, 25, 30
20,25	5, 10, 15, 20, 25, 30, 35, 40, 45, 50
32,40	5, 10, 15, 20, 25, 30, 35, 40, 45, 50, 75, 100
50,63,80,100	10, 15, 20, 25, 30, 35, 40, 45, 50, 75, 100

Manufacture of Intermediate Stroke

Description		Intermediate stroke range	
Spacers are installed in a cylinder with standard stroke.		Bore size (mm)	Intermediate stroke range (mm)
		12, 16	1 to 29
		20, 25	1 to 49
		32	1 to 99
		40 to 100	5 to 95

Example) Part number: CQMB32-57

Constructed by installing an 18 mm spacer in the standard stroke cylinder CQMB32-75. B dimension: 108 mm.

Theoretical Output

Bore size (mm)	Operating direction	Operating pressure (MPa)		
		0.3	0.5	0.7
12	IN	25	42	59
	OUT	34	57	79
16	IN	45	75	106
	OUT	60	101	141
20	IN	71	118	165
	OUT	94	157	220
25	IN	113	189	264
	OUT	147	245	344
32	IN	181	302	422
	OUT	241	402	563
40	IN	317	528	739
	OUT	377	628	880
50	IN	495	825	1150
	OUT	589	982	1370
63	IN	840	1400	1960
	OUT	936	1560	2184
80	IN	1362	2270	3178
	OUT	1509	2515	3521
100	IN	2145	3575	5005
	OUT	2355	3925	5495

Auto Switch Mounting Bracket Weight

Mounting bracket part no.	Applicable cylinder bore size	Weight (g)
BQ-2	ø32 to ø100	1.5
BQP1-050	ø40 to ø100	16

Weight

Without Auto Switch

Bore size (mm)	Cylinder stroke (mm)											
	5	10	15	20	25	30	35	40	45	50	75	100
12	44	52	60	69	77	86	—	—	—	—	—	—
16	56	67	77	87	97	108	—	—	—	—	—	—
20	92	107	122	137	152	167	183	198	213	227	—	—
25	125	143	162	180	198	216	234	252	270	288	—	—
32	182	205	228	250	274	297	320	343	366	389	553	669
40	269	295	320	345	370	396	421	446	471	497	692	823
50	—	500	540	580	620	661	701	740	780	821	1133	1341
63	—	745	795	845	894	944	993	1043	1093	1143	1535	1791
80	—	1400	1479	1559	1639	1719	1800	1880	1959	2039	2671	3067
100	—	2365	2468	2571	2674	2776	2880	2983	3086	3188	4053	4574

With Auto Switch (Built-in magnet)

Bore size (mm)	Cylinder stroke (mm)											
	5	10	15	20	25	30	35	40	45	50	75	100
12	52	59	68	77	84	93	—	—	—	—	—	—
16	66	77	87	97	107	118	—	—	—	—	—	—
20	122	138	153	168	182	197	213	227	242	257	—	—
25	168	186	205	223	240	258	277	295	313	331	—	—
32	241	264	287	309	333	356	379	401	425	448	564	680
40	345	371	396	421	447	473	498	523	548	574	705	836
50	—	618	658	698	738	779	819	858	898	939	1147	1355
63	—	903	953	1003	1052	1102	1152	1201	1251	1301	1557	1813
80	—	1661	1740	1820	1900	1980	2061	2141	2220	2300	2695	3090
100	—	2745	2848	2950	3053	3156	3260	3362	3465	3568	4088	4609

Add each weight of auto switches and mounting brackets.
Refer to pages 1559 to 1673 for auto switch weight.

Plate Non-rotating Accuracy

Non-rotating accuracy without load is designed to be same or less than the figures shown in the table below at the retracted cylinder end (plate).

Bore size (mm)	Non-rotating accuracy
12, 16	$\pm 0.2^\circ$
20 to 100	$\pm 0.1^\circ$

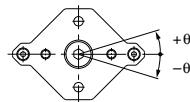
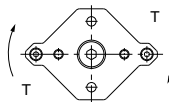

Plate Allowable Rotational Torque

Make sure to operate strictly within the allowable rotation torque range to the plate.

Operation outside of this range may result in shorter service life or damage to the devise.



Unit: N·m

Bore size (mm)	Cylinder stroke (mm)											
	5	10	15	20	25	30	35	40	45	50	75	100
12	0.11	0.10	0.08	0.07	0.07	0.06	—	—	—	—	—	—
16	0.15	0.12	0.11	0.10	0.09	0.08	—	—	—	—	—	—
20	0.37	0.32	0.28	0.25	0.23	0.21	0.19	0.18	0.17	0.16	—	—
25	0.40	0.35	0.31	0.28	0.25	0.23	0.21	0.20	0.18	0.17	—	—
32	0.66	0.59	0.53	0.49	0.45	0.42	0.39	0.36	0.34	0.32	0.25	0.20
40	1.06	0.96	0.88	0.81	0.75	0.70	0.65	0.61	0.58	0.55	0.43	0.36
50	—	1.70	1.56	1.45	1.35	1.26	1.19	1.12	1.06	1.01	0.80	0.67
63	—	3.90	3.62	3.37	3.15	2.96	2.80	2.65	2.51	2.39	1.92	1.61
80	—	7.44	6.98	6.56	6.20	5.87	5.57	5.31	5.07	4.84	3.98	3.37
100	—	11.85	11.19	10.61	10.08	9.60	9.17	8.77	8.41	8.07	6.73	5.77

Plate Allowable Lateral Load

Make sure to operate strictly within the allowable lateral load range to the plate.

Operation outside of this range may result in shorter service life or damage to the devise.

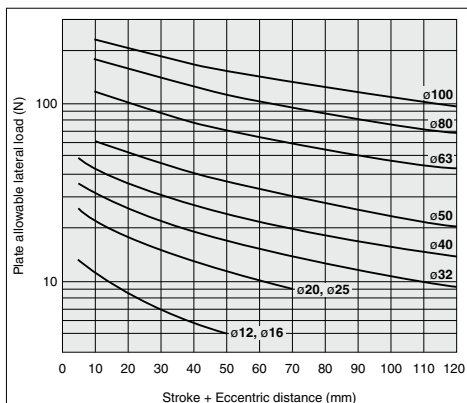
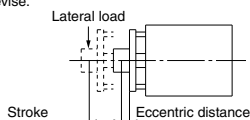

Allowable Kinetic Energy

Make sure to operate strictly within the allowable range of the load mass and maximum speed.

Operation outside of this range may cause excessive impact, which may result in the damage to the devise.

Operating pressure: 0.5 MPa

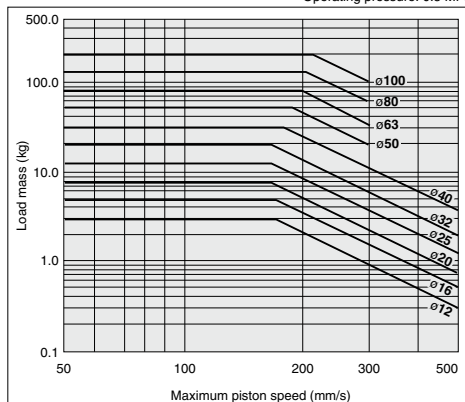

Construction

ø12 to ø25

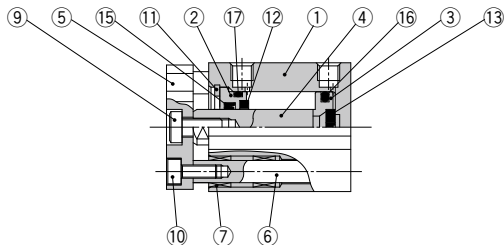

With auto switch
(Built-in magnet)

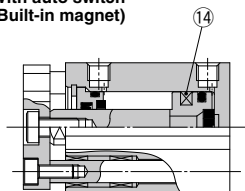

ø32 to ø100

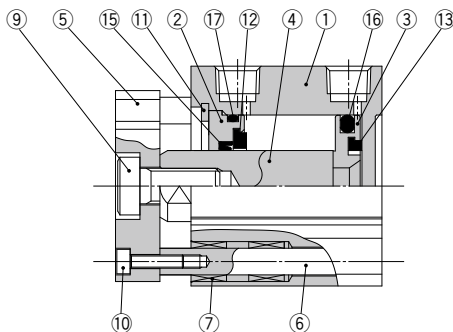

With auto switch
(Built-in magnet)

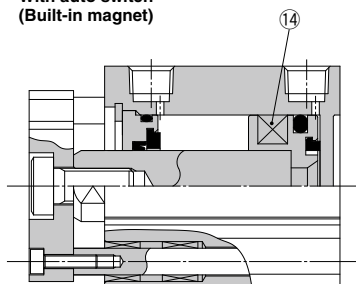

ø50 to ø100

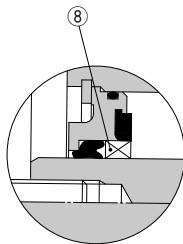

Component Parts

No.	Description	Material	Note
1	Cylinder tube	Aluminum alloy	Hard anodized
2	Collar	Aluminum alloy	ø12 to ø40 Anodized
		Aluminum alloy casted	ø50 to ø100 Chromated, Coated
3	Piston	Aluminum alloy	Chromated
4	Piston rod	Stainless steel	ø12 to ø25
		Carbon steel	ø32 to ø100 Hard chrome plated
5	Plate	Aluminum alloy	Anodized
6	Guide rod	Stainless steel	
7	Bushing	Bearing alloy	
8	Bushing	Bearing alloy	ø50 to ø100
9	Hexagon socket head cap screw	Carbon steel	Zmc chromated
10	Hexagon socket head cap screw	Carbon steel	Zmc chromated
11	Retaining ring	Carbon tool steel	Phosphate coated
12	Bumper A	Urethan	
13	Bumper B	Urethan	
14	Magnet	—	
15	Rod seal	NBR	
16	Piston seal	NBR	
17	Gasket	NBR	

CJ

CU

CQS

CQ2
-Z

RQ

CQM

CQU

MU
-Z

D-□

-X□

Technical
data

Mounting Bolt

Mounting method: Mounting bolt for through-hole style of C(D)MB is available as an option.

Refer to the following for ordering procedures.
Order the actual number of bolts that will be used.

Example) CQ-M3x25L 2 pcs.

Material: Chromium molybdenum steel
Surface treatment: Zinc chromated

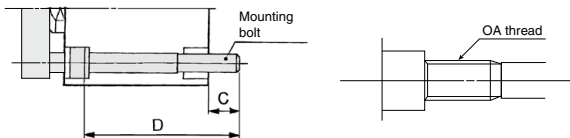

Note) To install a cylinder with bore size 12 to 25 mm with through-hole, be sure to use the attached flat washer.

Mounting Bolt for CQM/Without Auto Switch

Cylinder model	C	D	Mounting bolt part no.
CQMB12- 5	6.5	25	CQ-M3 x 25L
-10		30	x 30L
-15		35	x 35L
-20		40	x 40L
-25		45	x 45L
-30		50	x 50L
CQMB16- 5	6.5	25	CQ-M3 x 25L
-10		30	x 30L
-15		35	x 35L
-20		40	x 40L
-25		45	x 45L
-30		50	x 50L
CQMB20- 5	6.5	25	CQ-M5 x 25L
-10		30	x 30L
-15		35	x 35L
-20		40	x 40L
-25		45	x 45L
-30		50	x 50L
CQMB25- 5	8.5	30	CQ-M5 x 30L
-10		35	x 35L
-15		40	x 40L
-20		45	x 45L
-25		50	x 50L
-30		55	x 55L
-35	60	x 60L	
-40	65	x 65L	
-45	70	x 70L	
-50	75	x 75L	

Cylinder model	C	D	Mounting bolt part no.
CQMB32- 5	9	30	CQ-M5 x 30L
-10		35	x 35L
-15		40	x 40L
-20		45	x 45L
-25		50	x 50L
-30		55	x 55L
-35	60	x 60L	
-40	65	x 65L	
-45	70	x 70L	
-50	75	x 75L	
-75	110	x 110L	
-100	135	x 135L	
CQMB40- 5	7.5	35	CQ-M5 x 35L
-10		40	x 40L
-15		45	x 45L
-20		50	x 50L
-25		55	x 55L
-30		60	x 60L
-35	65	x 65L	
-40	70	x 70L	
-45	75	x 75L	
-50	80	x 80L	
-75	115	x 115L	
-100	140	x 140L	
CQMB50- 10	12.5	45	CQ-M6 x 45L
-15		50	x 50L
-20		55	x 55L
-25		60	x 60L
-30		65	x 65L
-35		70	x 70L
-40	75	x 75L	
-45	80	x 80L	
-50	85	x 85L	
-75	120	x 120L	
-100	145	x 145L	

Cylinder model	C	D	Mounting bolt part no.
CQMB63- 10	14.5	50	CQ-M8 x 50L
-15		55	x 55L
-20		60	x 60L
-25		65	x 65L
-30		70	x 70L
-35		75	x 75L
-40	80	x 80L	
-45	85	x 85L	
-50	90	x 90L	
-75	125	x 125L	
-100	150	x 150L	
CQMB80- 10	15	55	CQ-M10 x 55L
-15		60	x 60L
-20		65	x 65L
-25		70	x 70L
-30		75	x 75L
-35		80	x 80L
-40	85	x 85L	
-45	90	x 90L	
-50	95	x 95L	
-75	130	x 130L	
-100	155	x 155L	
CQMB100- 10	15.5	65	CQ-M10 x 65L
-15		70	x 70L
-20		75	x 75L
-25		80	x 80L
-30		85	x 85L
-35		90	x 90L
-40	95	x 95L	
-45	100	x 100L	
-50	105	x 105L	
-75	140	x 140L	
-100	165	x 165L	

Mounting Bolt for CDQM/With Auto Switch (Built-in magnet)

Cylinder model	C	D	Mounting bolt part no.
CDQMB12- 5	6.5	30	CQ-M3 x 30L
-10		35	x 35L
-15		40	x 40L
-20		45	x 45L
-25		50	x 50L
-30		55	x 55L
CDQMB16- 5	6.5	30	CQ-M3 x 30L
-10		35	x 35L
-15		40	x 40L
-20		45	x 45L
-25		50	x 50L
-30		55	x 55L
CDQMB20- 5	6.5	35	CQ-M5 x 35L
-10		40	x 40L
-15		45	x 45L
-20		50	x 50L
-25		55	x 55L
-30		60	x 60L
-35		65	x 65L
-40		70	x 70L
-45		75	x 75L
-50		80	x 80L
CDQMB25- 5	8.5	40	CQ-M5 x 40L
-10		45	x 45L
-15		50	x 50L
-20		55	x 55L
-25		60	x 60L
-30		65	x 65L
-35		70	x 70L
-40		75	x 75L
-45	80	x 80L	
-50	85	x 85L	

Cylinder model	C	D	Mounting bolt part no.
CDQMB32- 5	9	40	CQ-M5 x 40L
- 10		45	x 45L
- 15		50	x 50L
- 20		55	x 55L
- 25		60	x 60L
- 30		65	x 65L
- 35		70	x 70L
- 40		75	x 75L
- 45		80	x 80L
- 50		85	x 85L
- 75	110	x 110L	
-100	135	x 135L	
CDQMB40- 5	7.5	45	CQ-M5 x 45L
- 10		50	x 50L
- 15		55	x 55L
- 20		60	x 60L
- 25		65	x 65L
- 30		70	x 70L
- 35		75	x 75L
- 40		80	x 80L
- 45		85	x 85L
- 50		90	x 90L
- 75	115	x 115L	
-100	140	x 140L	
CDQMB50- 10	12.5	55	CQ-M6 x 55L
- 15		60	x 60L
- 20		65	x 65L
- 25		70	x 70L
- 30		75	x 75L
- 35		80	x 80L
- 40		85	x 85L
- 45		90	x 90L
- 50		95	x 95L
- 75		120	x 120L
-100	145	x 145L	

Cylinder model	C	D	Mounting bolt part no.
CDQMB63- 10	14.5	60	CQ-M8 x 60L
- 15		65	x 65L
- 20		70	x 70L
- 25		75	x 75L
- 30		80	x 80L
- 35		85	x 85L
- 40		90	x 90L
- 45		95	x 95L
- 50		100	x 100L
- 75		125	x 125L
-100	150	x 150L	
CDQMB80- 10	15	65	CQ-M10 x 65L
- 15		70	x 70L
- 20		75	x 75L
- 25		80	x 80L
- 30		85	x 85L
- 35		90	x 90L
- 40		95	x 95L
- 45		100	x 100L
- 50		105	x 105L
- 75		130	x 130L
-100	155	x 155L	
CDQMB100- 10	15.5	75	CQ-M10 x 75L
- 15		80	x 80L
- 20		85	x 85L
- 25		90	x 90L
- 30		95	x 95L
- 35		100	x 100L
- 40		105	x 105L
- 45		110	x 110L
- 50		115	x 115L
- 75		140	x 140L
-100	165	x 165L	

CUJ

CU

CQS

CQ2
-Z

RQ

CQM

CQU

MU
-Z

D-□

-X□

Technical
data

Series CQM

Dimensions

ø12 to ø25

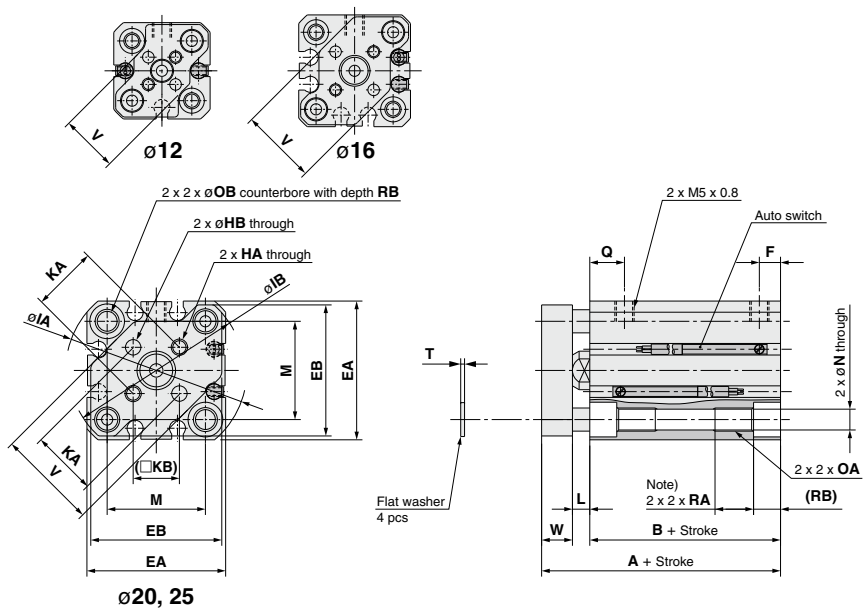

(mm)

Bore size (mm)	Stroke range (mm)	Without auto switch		With auto switch		EA	EB	F	HA	OA	HB	IA	IB
		A	B	A	B								
12	5 to 30	26.5	17	31.5	22	25	24	5	M3 x 0.5	M4 x 0.7	3 ^{+0.2} ₀	32	31.5
16	5 to 30	26.5	17	31.5	22	29	28	5	M3 x 0.5	M4 x 0.7	3 ^{+0.2} ₀	38	37
20	5 to 50	32	19.5	42	29.5	36	34	5.5	M4 x 0.7	M6 x 1.0	4 ^{+0.2} ₀	47	45.5
25	5 to 50	35.5	22.5	45.5	32.5	40	38	5.5	M5 x 0.8	M6 x 1.0	5 ^{+0.2} ₀	52	50.5

Bore size (mm)	KA	KB	L	M	N	OB	Q	RA	RB	T	V	W
12	10 ± 0.1	7.1	3.5	15.5	3.5	6.5	7.5	7	4	0.5	14.9	6
16	14 ± 0.1	9.9	3.5	20	3.5	6.5	7.5	7	4	0.5	20	6
20	17 ± 0.1	12	4.5	25.5	5.4	9	9	10	7	1	26	8
25	22 ± 0.1	15.6	5	28	5.4	9	11	10	7	1	30	8

Note) For the following bore/stroke sizes, the through-hole is threaded.

Standard without auto switch: ø12 and ø16; 5 stroke, ø20; 5 to 15 stroke, ø25; 5 and 10 stroke, Built-in magnet with auto switch: ø20; 5 stroke

Dimensions

ø32 to ø50

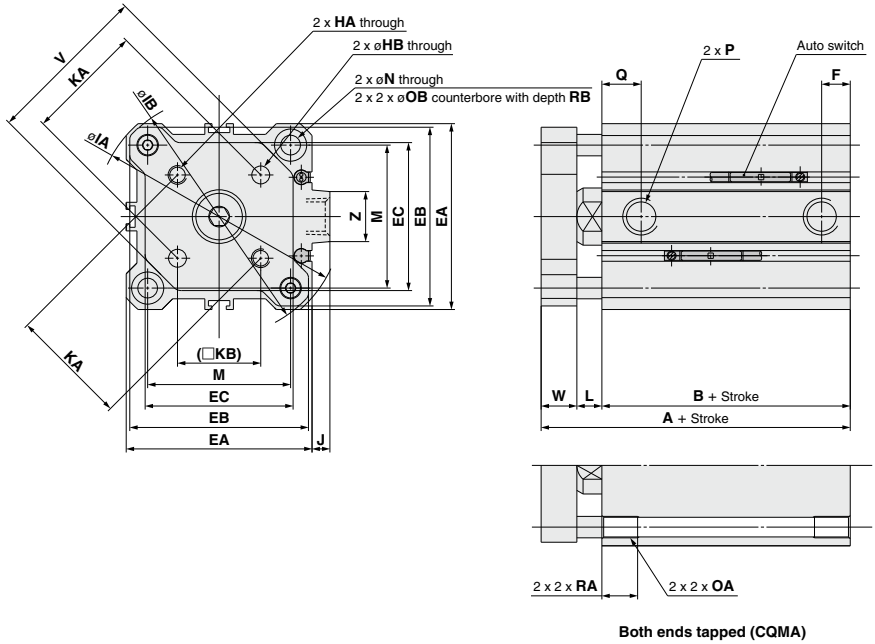

Bore size (mm)	Stroke range (mm)	Without auto switch								With auto switch								EA	EB	EC			
		A	B	F		Q		P			A	B	F		P								
				—	—	—	TN	TF	—	TN			TF	—	TN	TF							
32	5	40	23	5.5	11.5	M5 x 0.8	—	—	50	33	7.5	10.5	Rc 1/8	NPT 1/8	G 1/8	45	43	34.4					
	10 to 50			7.5	10.5	Rc 1/8	NPT 1/8	G 1/8															
	75, 100	50	33	—	—	—	—	—															
40	5 to 50	46.5	29.5	8	11	Rc 1/8	NPT 1/8	G 1/8	56.5	39.5	8	11	Rc 1/8	NPT 1/8	G 1/8	52	50	41.4					
	75, 100	56.5	39.5																—	—	—	—	—
	10 to 50	50.5	30.5																—	—	—	—	—
50	75, 100	60.5	40.5	10.5	10.5	Rc 1/4	NPT 1/4	G 1/4	60.5	40.5	10.5	10.5	Rc 1/4	NPT 1/4	G 1/4	64	62	53.4					

Bore size (mm)	HA	OA	HB	IA	IB	J	KA	KB	L	M	N	OB	RA	RB	V	W	Z
32	M5 x 0.8	M6 x 1.0	5 ^{+0.2} ₀	60	58.5	4.5	28 ± 0.2	19.8	7	34	5.5	9	10	7	38	10	14
40	M5 x 0.8	M6 x 1.0	5 ^{+0.2} ₀	69	67.5	5	33 ± 0.2	23.3	7	40	5.5	9	10	7	46	10	14
50	M6 x 1.0	M8 x 1.25	6 ^{+0.2} ₀	86	84.5	7	42 ± 0.2	29.7	8	50	6.6	11	14	8	58	12	19

CUJ

CU

CQS

CQ2-Z

RQ

CQM

CQU

MU-Z

D-□

-X□

Technical data

Series CQM

Dimensions

ø63 to ø100

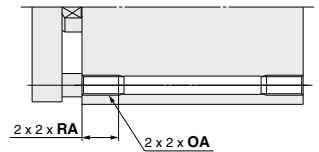
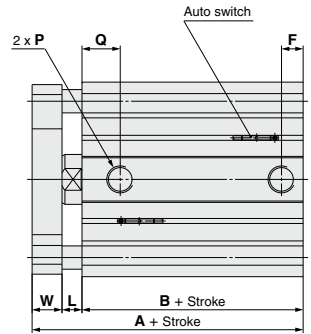
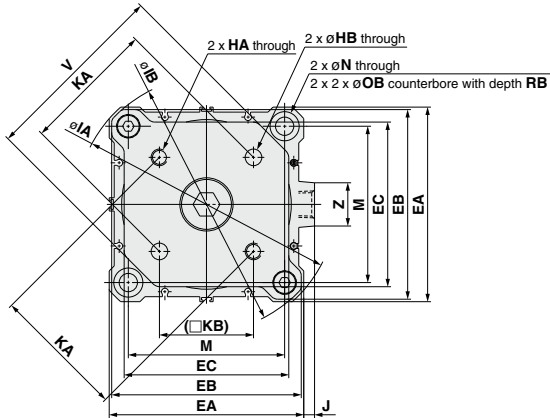

Both ends tapped (CQMA)

(mm)

Bore size (mm)	Stroke range (mm)	Without auto switch		With auto switch		EA	EB	EC	F	HA	HB	IA	IB	J	KA	KB	L	M
		A	B	A	B													
63	10 to 50	56	36	66	46	77	74	59.6	10.5	M6 x 1	6 ^{+0.2} ₀	103	100	7	50 ± 0.2	35.4	8	60
	75, 100	66	46															
80	10 to 50	67.5	43.5	77.5	53.5	98	95	79.5	12.5	M8 x 1.25	8 ^{+0.2} ₀	132	129	6	65 ± 0.2	46	10	77
	75, 100	77.5	53.5															
100	10 to 50	79	53	89	63	117	114	99	13	M10 x 1.5	10 ^{+0.2} ₀	156	153	6.5	80 ± 0.2	56.6	10	94
	75, 100	89	63															

Bore size (mm)	N	OA	OB	P			Q	RA	RB	V	W	Z
				—	TN	TF						
63	9	M10 x 1.5	14	Rc 1/4	NPT 1/4	G 1/4	15	18	10.5	69	12	19
80	11	M12 x 1.75	17.5	Rc 3/8	NPT 3/8	G 3/8	16	22	13.5	89	14	26
100	11	M12 x 1.75	17.5	Rc 3/8	NPT 3/8	G 3/8	23	22	13.5	113	16	26

Auto Switch Mounting 1

Minimum Auto Switch Mounting Stroke

Bore size (mm)	Auto switch model No. of auto switch mounted	(mm)																					
		D-M9□V	D-A9□V	D-A9□	D-M9□WV	D-M9□	D-M9□W	D-M9□A	D-F7□V	D-F7□V	D-A7□	D-A8□	D-F7□WV	D-F7□	D-A7□H	D-A80H	D-A79W	D-F7□W	D-J79W	D-F7BA	D-F7NT	D-F79F	D-P4DW
12, 16, 20, 25	1 pc. 2 pcs.	5 5	5 10	10(5) 10	10 10	15(5) 15	15(10) 15	— —	— —	— —	— —	— —	— —	— —	— —	— —	— —	— —	— —	— —	— —	— —	— —
32, 40, 50, 63, 80, 100	1 pc. 2 pcs.	5 5	5 10	10(5) 10	10 15	10(5) 10(5)	15(10) 15	5 5	5 10	10 15	15(15) 15(5)	15(5) 15(10)	15(5) 15(10)	15(5) 15(10)	15 20	20(15) 20	15 20	20(15) 20	— —	— —	— —	— —	15 15

* D-P4DWL type is compatible with bore sizes ø40 to ø100.

Note) The dimension stated in () shows the minimum mountable stroke when the auto switch does not project from the end face of the cylinder body and the lead wire bending space is not hindered. (Refer to the figure below.)

The auto switch and its mounting bracket are ordered separately. (Bore sizes ø12 to ø25 do not need any auto switch mounting bracket.)

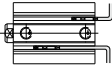

Proper Auto Switch Mounting Position (Detection at stroke end) and Its Mounting Height

D-A9□
D-M9□

ø12

ø16, 20, 25

ø32 to ø100

D-M9□W
D-M9□A

D-A9□V
D-M9□V
D-M9□WV
D-M9□AV

Approx. Hs

Proper Auto Switch Mounting Positions

Auto switch model Bore size	D-A9□ D-A9□V			D-M9□ D-M9□V D-M9□W D-M9□WV			D-M9□A D-M9□AV		
	A	B	W	A	B	W	A	B	W
12	1.5	0.5	1.5 (4)	5.5	4.5	5.5	5.5	4.5	7.5
16	2	0	2 (4.5)	6	4	6	6	4	8
20	6	3.5	-1.5 (1)	10	7.5	2.5	10	7.5	4.5
25	7	5.5	-3.5 (-1)	11	9.5	0.5	11	9.5	2.5
32	8	5	-3 (-0.5)	12	9	1	12	9	3
40	12	7.5	-5.5 (-3)	16	11.5	-1.5	16	11.5	0.5
50	10	10.5	-8.5 (-6)	14	14.5	-4.5	14	14.5	-2.5
63	12.5	13.5	-11.5 (-9)	16.5	17.5	-7.5	16.5	17.5	-5.5
80	15.5	18	-16 (-13.5)	19.5	22	-12	19.5	22	-10
100	20	23	-21 (-18.5)	24	27	-17	24	27	-15

Note 1) () : For D-A93 type

Note 2) W is used for mounting D-A9□, D-M9□, D-M9□W and D-M9□A types.

Note 3) Negative figures for W in the table indicate that an auto switch is mounted inward from the edge of the cylinder body.

Note 4) Adjust the auto switch after confirming the operating condition in the actual setting.

Auto Switch Mounting Height

Auto switch model Bore size	D-A9□V		D-M9□V D-M9□WV D-M9□AV	
	Hs	Hs	Hs	Hs
12	17	19	17	19
16	19	21	19	21
20	22.5	24	22.5	24
25	24.5	26	24.5	26
32	27	29	27	29
40	30.5	32.5	30.5	32.5
50	36.5	42	36.5	42
63	40	42	40	42
80	50	52	50	52
100	60	62	60	62

CUJ

CU

CQS

CQ2
-Z

RQ

CQM

CQU

MU
-Z

D-□

-X□

Technical
data

Auto Switch Mounting 2

Proper Auto Switch Mounting Position (Detection at stroke end) and Its Mounting Height

D-A7□ **D-F7□V** **D-A7□H** **D-F7□**
D-A80 **D-J79C** **D-A80H** **D-J79**
D-A73C **D-F7□WV** **D-F7□W**
D-A80C **D-F7BAV** **D-J79W**
D-A79W **D-F7BA**
 D-F79F
 D-F7NT

D-P4DW

ø32 to ø100

ø40 to ø100

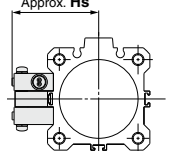
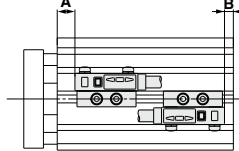
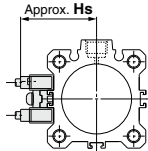
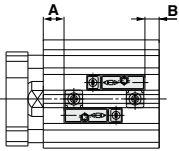

Proper Auto Switch Mounting Position

(mm)

Auto switch model	D-A73 D-A80		D-A72/A7□H/A80H D-A73C/A80C/F7□ D-J79/F7□W/J79W D-F7□V/F7□WV D-F79F/J79C D-F7BA/F7BAV		D-F7NT		D-A79W		D-P4DW	
	A	B	A	B	A	B	A	B	A	B
Bore size 32	9	6	9.5	6.5	14.5	11.5	6.5	3.5	—	—
40	13	8.5	13.5	9	18.5	14	10.5	6	9	4.5
50	11	11.5	11.5	12	16.5	17	12	8.5	7	7.5
63	13	14.5	14	15	15	16	11	12	9.5	10.5
80	17	18	18	18.5	19	19.5	15	15.5	13.5	14
100	21	24	21.5	24.5	22.5	25.5	18.5	21.5	17	20

* D-P4DWL type is compatible with bore sizes ø40 to ø100.

Note) Adjust the auto switch after confirming the operating condition in the actual setting.

Auto Switch Mounting Height

(mm)

Auto switch model	D-A7□ D-A80	D-A7□H/A80H D-F7□/J79/F7□W D-J79W/F79F D-F7BA/F7NT	D-A73C D-A80C	D-A79W	D-F7□V D-F7□WV D-F7BAV	D-J79C	D-P4DW
	Hs	Hs	Hs	Hs	Hs	Hs	Hs
Bore size 32	31.5	32.5	38.5	34	35	38	—
40	35	36	42	37.5	38.5	41.5	44
50	41	42	48	43.5	44.5	47.5	50
63	47.5	48.5	54.5	50	51	54	56.5
80	57.5	58.5	64.5	60	61	64	66.5
100	67.5	68.5	74.5	70	71	74	76.5

* D-P4DWL type is compatible with bore sizes ø40 to ø100.

Operating Range

(mm)

Auto switch model	Bore size									
	12	16	20	25	32	40	50	63	80	100
D-A9□/A9□V	6	7.5	10	10	9.5	9.5	9.5	11.5	9	11.5
D-M9□/M9□V D-M9□W/M9□WV D-M9□A/M9□AV	3	4	5.5	5.5	6	6	7	7.5	8	8.5
D-A7□/A80	—	—	—	—	12	11	10	12	12	13
D-A79W	—	—	—	—	13	14	14	16	15	17
D-F7□/F7□V D-J79/J79C D-F7□W/F7□WV D-J79W D-F7BA/F7BAV D-F7NT/F79F	—	—	—	—	6	6	6	6.5	6.5	7
D-P4DW	—	—	—	—	—	5	5	5	5	5.5

* Since the operating range is provided as a guideline including hysteresis, it cannot be guaranteed (assuming approximately ±30% dispersion). It may vary substantially depending on an ambient environment.

* Auto switch mounting brackets BQ2-012 are not used for sizes over ø32 of D-A9□(V)/M9□(V)/M9□A(V) types. The above values indicate the operating range when mounted with the conventional auto switch installation groove.

Auto Switch Mounting Bracket: Part No.

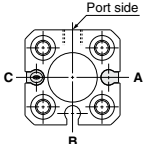
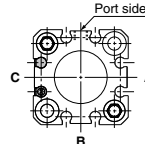
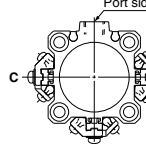
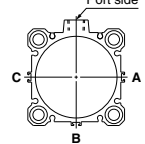
Auto switch mounting surface	Bore size (mm)			
	φ12	φ16, φ20, φ25	φ32, φ40, φ50	φ63, φ80, φ100
				
Auto switch model	Auto switch mounting surface A, B, C sides	Auto switch mounting surface Port, A, B, C sides	Auto switch mounting surface Port side A, B, C sides	Auto switch mounting surface Port, A, B, C sides
D-A9□ D-A9□V D-M9□ D-M9□V D-M9□W D-M9□WV D-M9□A D-M9□AV	Auto switch mounting bracket not required.	Auto switch mounting bracket not required.	Auto switch mounting bracket not required.	Auto switch mounting bracket not required.

Note 1) For each cylinder series, when a compact auto switch is mounted on the three sides (A, B and C above) other than the port side of bore sizes φ32 to φ50, the auto switch mounting brackets above are required. Order them separately from cylinders.

Order example

CDQM32-50-M9BW.....1

BQ-2.....2 pcs.

BQ2-012.....2 pcs.

Note 2) When shipping cylinders, auto switch mounting brackets and auto switches are shipped together.

Auto switch model	Bore size (mm)					
	32	40	50	63	80	100
D-A7□/A80 D-A73C/A80C D-A7□H/A80H D-A79W D-F7□/J79 D-F7□V D-J79C D-F7□W/J79W D-F7□WV D-F7BA/F7BAV D-F79F/F7NT	BQ-2					
D-P4DW	BQP1-050					

Note 3) Auto switch mounting brackets and auto switches are included when the cylinder is shipped. For only φ40 to φ100 with D-P4DW, they are assembled at the time of shipment.

Mounting screw set made of stainless steel

The following set of mounting screws made of stainless steel (including nuts) is available. Use it in accordance with the operating environment. (Please order BQ-2 separately, since auto switch spacers (for BQ-2) are not included.)

BBA2: For D-A7/A8/F7/J7 types

D-F7BA/F7BAV auto switches are mounted on the cylinder with the stainless steel screws above when shipped. When an auto switch is shipped independently, BBA2 is attached.

Note 4) Refer to page 1659 for the details of BBA2 screws.

Note 5) When D-M9□A(V) type is mounted on a side other than φ32, φ40 and φ50 port sides, order auto switch mounting brackets BQ2-012S and BQ-2, and a stainless steel screw set BBA2.

Auto Switch Mounting Bracket Weight

Mounting bracket part no.	Weight (g)
BQ-2	1.5
BQ2-012	5
BQP1-050	16

Other Applicable Auto Switches

(Refer to pages 1559 to 1673 for further information on auto switches.)

Type	Model	Electrical entry (Fetching direction)	Features
Reed auto switch	D-A73	Grommet (perpendicular)	Without indicator light
	D-A80		
	D-A73H, A76H	Grommet (in-line)	Without indicator light
	D-A80H		
Solid state auto switch	D-F7NV, F7PV, F7BV	Grommet (perpendicular)	—
	D-F7NWV, F7BWW		Diagnostic indication (2-color indication)
	D-F7BAV		Water resistance (2-color indication)
	D-F79, F7P, J79		—
	D-F79W, F7PW, J79W	Grommet (in-line)	Diagnostic indication (2-color indication)
	D-F7BA		Water resistance (2-color indication)
	D-F7NT		With timer
	D-P5DW		Magnetic field resistant (2-color indication)

* For solid state auto switches, auto switches with a pre-wired connector are also available. Refer to pages 1626 and 1627 for details.

* Normally closed (NC = b contact) solid state auto switches (D-F9G/F9H types) are also available. Refer to page 1577 for details.

* D-A7/A8/F7/J7 types cannot be mounted on φ12 to φ25.

Auto Switch Mounting 3

The number of surfaces and grooves where an auto switch can be mounted (as direct mounting).

The number of the surfaces and grooves where the auto switch can be mounted, by auto switch type, are shown in the table below.

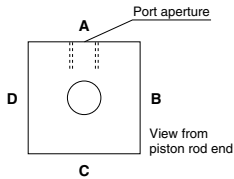

Auto switch type	D-A9□(V), M9□(V), M9□W(V), M9□A(V)				D-A7□, A8□, F7□, J7□			
Bore size (mm)	A (Mounting groove no.)	B (Mounting groove no.)	C (Mounting groove no.)	D (Mounting groove no.)	A (Mounting groove no.)	B (Mounting groove no.)	C (Mounting groove no.)	D (Mounting groove no.)
12	—	○ (1)	○ (1)	○ (1)	—	—	—	—
16	—	○ (2)	○ (2)	○ (2)	—	—	—	—
20	○ (2)	○ (2)	○ (2)	○ (2)	—	—	—	—
25	○ (2)	○ (2)	○ (2)	○ (2)	—	—	—	—
32	○ (2)	—	—	—	—	○	○	○
40	○ (2)	—	—	—	—	○	○	○
50	○ (2)	—	—	—	—	○	○	○
63	○ (2)	○ (2)	○ (2)	○ (2)	—	○	○	○
80	○ (2)	○ (2)	○ (2)	○ (2)	—	○	○	○
100	○ (2)	○ (2)	○ (2)	○ (2)	—	○	○	○



Series CQM

Specific Product Precautions

Be sure to read before handling.

Refer to front matter 57 for Safety Instructions and pages 3 to 12 for Actuator and Auto Switch Precautions.

Mounting

⚠ Warning

1. Do not put hands or fingers between the plate and cylinder tubing.

Never put hands or fingers in the gap between the plate and cylinder tubing when the piston rods are retracted. Due to the heavy power output of the cylinder, failure to comply with this directive may result in trapping and subsequent injury to the human body.

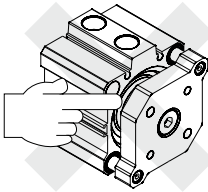

⚠ Caution

1. Do not scratch or dent the sliding parts of the piston rod and guide rods.

Damage to seals may cause air leakage or faulty operation.

2. Mounting of work piece

When screwing a bolt onto the threaded portion of the plate surface, be certain that the guide rods are fully extended to the end.

Also, be careful that the tightening torque is not applied to the guide rods.

3. Make sure that the cylinder mounting surface has a flatness of 0.02 mm or less.

When mounting the cylinder body or workpieces on the plate, improper flatness of the mounting surface may cause malfunctions.

When the flatness of a workpiece is not sufficient, attaching a shim such as a flat washer, etc., at the place of a mounting bolt between the workpiece and the plate may reduce the affect on the operation.

Others

⚠ Caution

1. This product should not be used as a stopper.
2. Do not disassemble and modify the product.
3. For example, in a pressing application, the cylinder thrust is directly applied to the plate, therefore, make sure that the pressing force is applied to the plate directly on the extended axial line of a rod. (Below figures.)

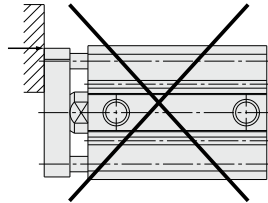
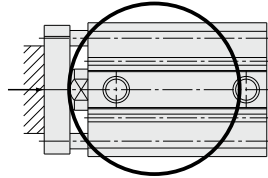

CJU

CU

CQS

CQ2
-Z

RQ

CQM

CQU

MU
-Z

D-□

-X□

Technical
data