

**CP96S(D), ISO 15552 Cylinder,
Double Acting, Single/Double Rod
with Air cushion on both ends and
Bumper cushion
CP96SDB50-100C**

Data Sheet

- CP96-C, ISO 15552 Cylinder, Double Acting, Single/Double Rod with Air Cushion and bumper.
- New types added: Standard for double rod, Non-rotating rod for double and single rod.
- Rod boot option added for the standard type.
- Integrated function of the air cushion and the bumper.
- Bore sizes (mm): 32 ~ 125.
- Strokes up to 2000 mm.
- Weight reduced by up to 15% thanks to the new the design of the cover and the piston.
- Many made to order available.

Standard Specifications

Magnet	Built-in Magnet
Mounting	Basic
Bore Size	50mm
Stroke	100 mm
Rod Boot	w/o Rod Boot
Rod	Single Rod
Auto Switch	No Switch
Lead Wire or Prewired Connector	Or None in the Case of No Switch
Number	Or None in the Case of No Switch
Pressure medium	Compressed air
Maximum temperature of pressure medium	70 °C
Maximum temperature of pressure medium with magnet	60 °C
Minimum temperature of pressure medium	-20 °C (no freezing)
Minimum temperature of pressure medium with magnet	-10 °C (no freezing)
Maximal operating pressure	1.0 MPa
Minimum operating pressure	0.05 MPa
Proof pressure	1.5 MPa
Maximum ambient temperature	70 °C
Maximum ambient temperature with magnet	60 °C
Minimum ambient temperature	-20 °C (no freezing)
Minimum ambient temperature with magnet	-10 °C (no freezing)
XC7	Double-acting cylinder with cushioning adjustable at both ends, single piston rod
Number of pneumatic connections	2 pcs.
Pneumatic input connection	G 1/4
Pneumatic exhaust connection	G 1/4
XC6A	2059A_en.jpg
XC6B	Symbol43.jpg
Mode of operation of drive	Double acting
Theoretical cylinder force, advance stroke (at 0.5 MPa)	982 N
Theoretical cylinder force, return stroke (at 0.5 MPa)	825 N
Maximum piston speed	1,000 mm/s
Piston rod end	Male Thread
Malethread of rod end	M16 x 1.5
Tolerance of torsion	Air cushion on both ends + Bumper cushion
Usable tubing material	PU
Subfamily	CP96S(D), ISO 15552 Cylinder, Double Acting, Single/Double Rod with Air cushion on both ends and Bumper cushion
Weight	1.800 kg

Dimensions

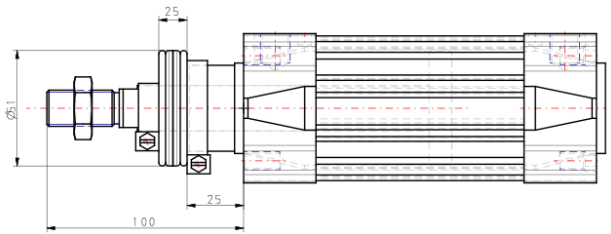
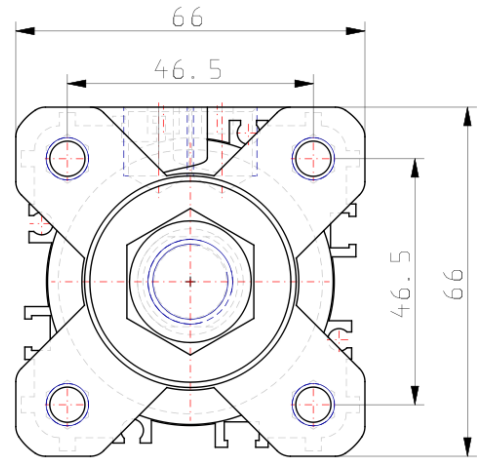
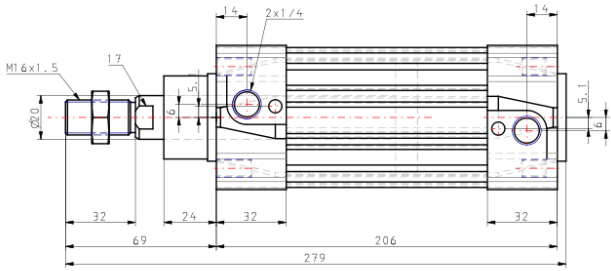

Constructions

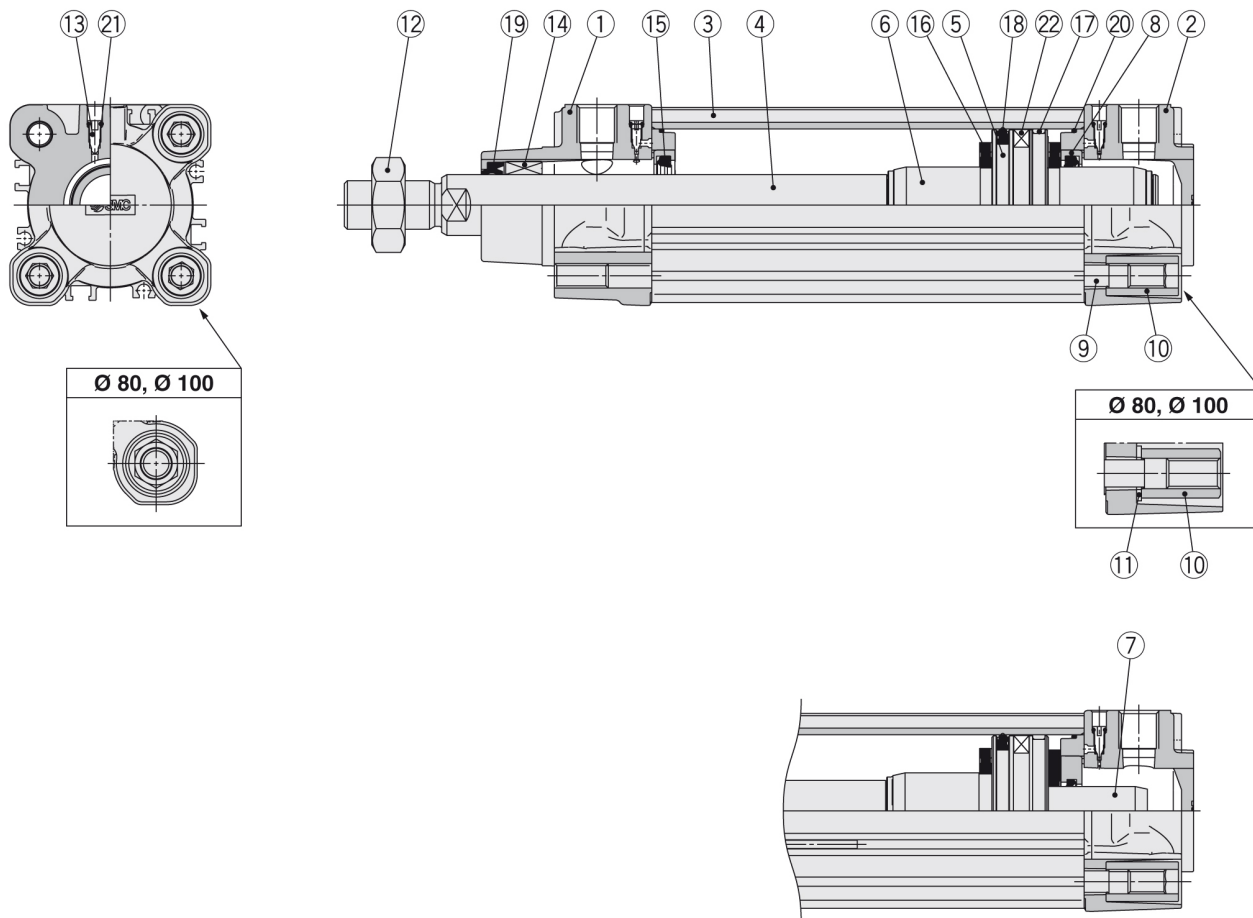

Component Parts

No.	Description	Material	Note
1	Rod cover	Aluminium die-cast	
2	Head cover	Aluminium die-cast	
3	Cylinder tube	Aluminium alloy	
4	Piston rod	Carbon steel	
5	Piston	Aluminium alloy	Ø 32 to Ø 63
		Aluminium die-cast	Ø 80, Ø 100
6	Cushion ring A	Aluminium alloy	
7	Cushion ring B	Aluminium alloy	
8	Cushion seal holder	Aluminium alloy	
9	Tie-rod	Carbon steel	
10	Tie-rod nut	Steel	
11	Flat washer	Steel	Ø 80, Ø 100
12	Rod end nut	Steel	
13	Cushion valve	Resin	
14	Bushing	Bearing alloy	
15	Cushion seal	Urethane	
16	Bumper	Urethane	
17	Wear ring	Resin	
18	Piston seal	NBR	
19	Rod seal	NBR	
20	Cylinder tube gasket	NBR	
21	Cushion valve seal	NBR	
22	Magnet		

Replacement Parts/Seal Kit (Single rod)

Bore size [mm]	Kit no.	Contents
32	CS95-32	Kits include items 15, 17 to 20.
40	CS95-40	
50	CS95-50	
63	CS95-63	
80	CS95-80	
100	CS96-100	

Seal Kit (Double rod)

Bore size [mm]	Kit no.	Contents
32	CS95W-32	Kits include items 15, 18 to 20.
40	CS95W-40	
50	CS95W-50	
63	CS95W-63	
80	CS95W-80	
100	CS96W-100	

Additional information

Catalogue

[CP96-Bb_EU.pdf](#)

Related Products



D-M9BWL

M9NW/M9PW/M9BW, 2 Colour Indication Style Solid State Switch, Direct Mounting, Grommet, In-line



D-M9BWL

M9NW/M9PW/M9BW, 2 Colour Indication Style Solid State Switch, Direct Mounting, Grommet, In-line



D-M9PWSAPC

D-**PC, Pre-wired Connector Auto Switch



D-A93L

A90/A93/A96, Reed Switch, Direct Mounting, Grommet, In-line



AS2201F-02-08SA

AS*2/3*1F-A, Speed Controller with One-touch Fitting, Push Lock, Elbow/Universal Type



AS2301F-02-08SA

AS*2/3*1F-A, Speed Controller with One-touch Fitting, Push Lock, Elbow/Universal Type



ASD430F-02-08S

ASD-T, Tamper Proof Dual Speed Controller



AS2052F-08

AS*2F, Speed Controller, One-touch Fitting, In-line, Compact



JA50-16-150

JA, Floating Joint, Standard



ASR430F-02-08S

ASR*30/ASQ*30, Air Saving Valve (PFC/QFC Valve), Metric



ASQ430F-02-08S

ASR*30/ASQ*30, Air Saving Valve (PFC/QFC Valve), Metric



KQ2H08-G02AS

KQ2H, One-touch Fitting White Color - Male Connector



TU0805B-20

TU, Polyurethane Tubing, Metric Size



SY

SY3000/5000/7000, Subplate for Single Unit New SY, IP67 Compliant