

# Speed Exhaust Controller

# Series ASV

Size: M3, M5, 1/8, 1/4, 3/8



## How to Order

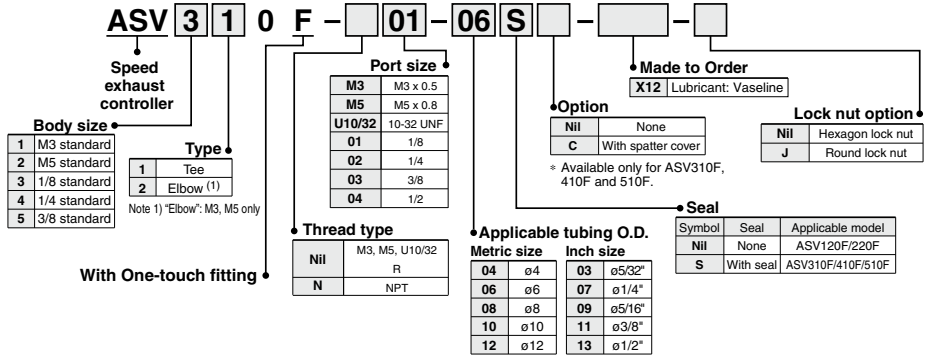

Integration of a quick exhaust valve and an exhaust restrictor permits high-speed cylinder operation.

- The flow rate is approximately twice. (In comparison with control by speed controller)  
Applicable model: ASV310F, ASV410F, ASV510F
- Silencer and One-touch fittings are installed.
- Flame resistant resin body as standard. (UL standard V-0)  
Applicable model: ASV310F, ASV410F, ASV510F
- Brass parts are all electroless nickel plated.



## Model

Model	Port size	Applicable tubing O.D. (mm)										Sonic conductance dm <sup>7</sup> /(s·bar)		Critical pressure ratio		
		4	6	8	10	12	5/32	1/4	5/16	3/8	1/2	IN→OUT	OUT→EXH	IN→OUT	OUT→EXH	
ASV120F-M3	M3 x 0.5	●											0.06	0.06	0.15	
ASV220F-M5	M5 x 0.8	●	●										0.26	0.26		
ASV310F-01	R 1/8		●	●									1.4	1.6		
ASV310F-02	R 1/4		●	●									1.4	1.6	0.35	
ASV410F-01	R 1/8			●	●								2.7	2.8		
ASV410F-02	R 1/4			●	●								2.7	2.8		
ASV410F-03	R 3/8			●	●								2.7	2.8		
ASV510F-02	R 1/4				●	●							4.6	5.4		
ASV510F-03	R 3/8				●	●							5.4	5.8		
ASV510F-04	R 1/2				●	●							5.4	5.8	0.25	
ASV220F-U10/32	10-32 UNF					●	●						0.26	0.26		
ASV310F-N01	NPT 1/8									●	●		1.4	1.6	0.35	
ASV310F-N02	NPT 1/4									●	●		1.4	1.6		
ASV410F-N01	NPT 1/8									●	●		2.7	2.8		
ASV410F-N02	NPT 1/4									●	●		2.7	2.8		
ASV410F-N03	NPT 3/8									●	●		2.7	2.8		
ASV510F-N02	NPT 1/4									●	●		4.6	5.4		
ASV510F-N03	NPT 3/8									●	●		5.4	5.8		
ASV510F-N04	NPT 1/2									●	●		5.4	5.8		

## Specifications

Series	ASV120F	ASV220F	ASV310F/410F	ASV510F
Fluid	Air			
Proof pressure	1.5 MPa			
Max. operating pressure	1 MPa			
Min. operating pressure	0.1 MPa			
Ambient and fluid temperature	-5 to 60°C (No freezing)			
Applicable tubing material (Note)	Nylon, Soft nylon, Polyurethane			
Option	Hexagonal lock nut		With spatter cover, Hexagonal lock nut	

Note) Use caution regarding the max. operating pressure when soft nylon or polyurethane tubing is used. (Refer to pages 411 and 412 for details.)

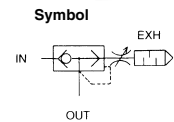

Made to Order



Lubricant: Vaseline

X12

Ex.) ASV120F-M3-04-X12

Note) Only for ASV120F and ASV220F

628



## Needle Valve/Flow Characteristics

Note) The flow characteristics are representative values.

**ASV120F**  
**OUT-Exhaust Flow**

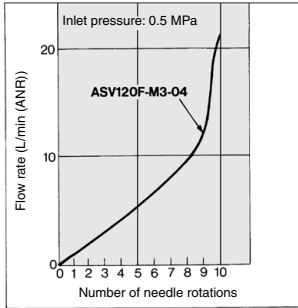

**ASV310F**  
**IN-OUT Flow**

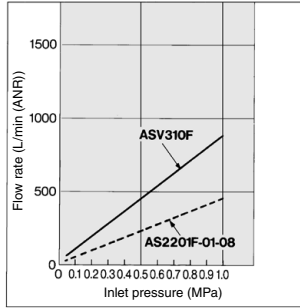

**OUT-Exhaust Flow**

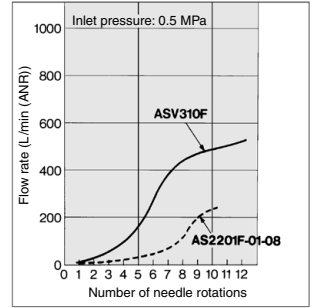

**ASV220F**  
**OUT-Exhaust Flow**

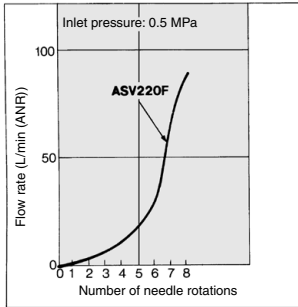

**ASV410F**  
**IN-OUT Flow**

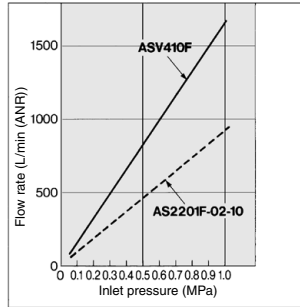

**OUT-Exhaust Flow**

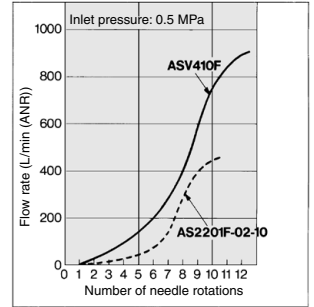

**ASV510F**

**IN-OUT Flow**

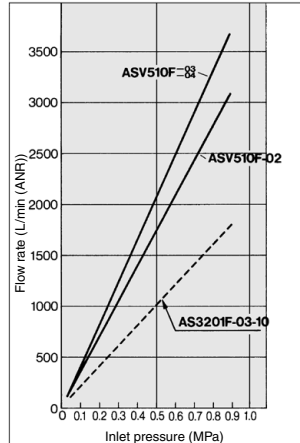

**OUT-Exhaust Flow**

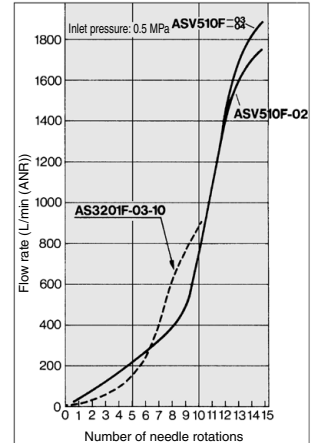

- AS
- TMH
- ASD
- AS
- AS-FE KE
- AS-FG
- AS-FP
- AS-FM
- AS-D AS-T
- ASP
- ASN
- AQ
- ASV
- AK
- VCHC
- ASS
- ASR ASQ

# Series ASV

## Construction

### ASV120F/220F

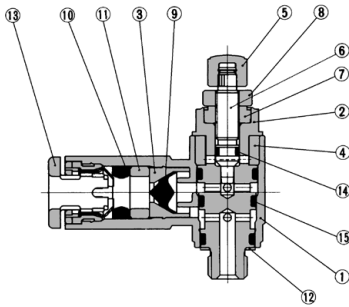

### ASV310F/410F/510F

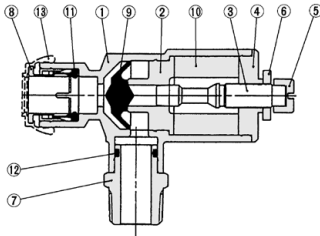

### Component Parts

No.	Description	Material	Note
1	Body A	PBT	
2	Body B	Brass <sup>(1)</sup>	Electroless nickel plated
3	Seat ring	Brass	Electroless nickel plated
4	Silencer	PVA sponge	
5	Handle	PBT	M3 type: Electroless nickel plated brass
6	Needle	Brass	Electroless nickel plated
7	Needle guide	Brass	Electroless nickel plated
8	Lock nut	Steel <sup>(3)</sup>	Zinc chromated <sup>(2)</sup>
9	Valve	HNBR	
10	Seal	NBR	
11	Spacer	POM	
12	Gasket	Stainless steel/NBR	M3 port : PVC
13	Cassette	—	
14	O-ring	NBR	
15	O-ring	NBR	

Note 1) M3 type is made of stainless steel.

Note 2) The round lock nut is electroless nickel plated.

Note 3) The round lock nut is made of brass.

### Component Parts

No.	Description	Material	Note
1	Body A	PBT	UL94V-0
2	Seat ring	Aluminum alloy	Chromate plated
3	Needle	Aluminum alloy	Electroless nickel plated
4	Needle guide	Aluminum alloy	Electroless nickel plated
5	Handle	Brass	Electroless nickel plated
6	Lock nut	Steel <sup>(2)</sup>	Zinc chromated <sup>(1)</sup>
7	Needle guide	Brass	Electroless nickel plated
8	Cassette	—	
9	Valve	Urethane rubber	
10	Silencer	PVA sponge	
11	Seal	NBR	
12	O-ring	NBR	
13	Cover	Flame proof CR	UL94V-0

Note 1) The round lock nut is electroless nickel plated.

Note 2) The round lock nut is made of brass. However,

note that only the ASV310F and ASV410F use steel.

## Circuit

### Circuit of speed exhaust controller

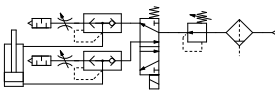

### Controlled by speed controller

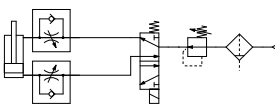

## ⚠ Specific Product Precautions

Be sure to read before handling.  
Refer to front matter 56 for Safety Instructions and pages 468 to 471 for Flow Control Equipment Precautions.

### Design/Selection

## ⚠ Caution

### 1. In the following cases, insufficient exhaust or vibration may cause noise.

- With residual pressure or back pressure on the IN side.
- When the differential pressure between the IN and OUT sides is smaller than the minimum operating pressure.
- When the effective area of the IN side piping of ASV, or the solenoid valve, is smaller than ASV.

## Dimensions

### ASV120F/220F

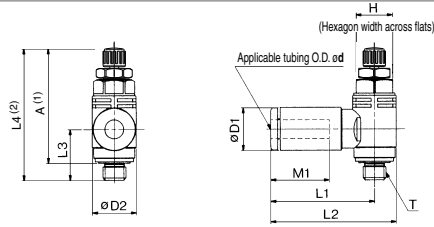

#### Metric Size

Model	Applicable tubing O.D. ed	T	H	D1	D2	L1	L2	L3	L4		A*		M1	Weight (g)
									Max.	Min.	Max.	Min.		
ASV120F-M3-04	4	M3 x 0.5	5.5	9.3	7.2	21.4	25	9.8	28.6	26.1	25.8	23.3	12.7	5
ASV220F-M5-04	4	M5 x 0.8	8	9.3	9.6	22.8	27.6	11.1	31.4	28.6	27.7	24.9	12.7	8
ASV220F-M5-06	6	M5 x 0.8	8	11.6	9.6	23.6	28.4	11.1	31.4	28.6	27.7	24.9	13.5	9

Note 1) Reference dimensions of M thread after installation. Note 2) L4: Reference dimensions

#### Inch Size

Model	Applicable tubing O.D. ed	T	H	D1	D2	L1	L2	L3	L4		A*		M1	Weight (g)
									Max.	Min.	Max.	Min.		
ASV220F-U10/32-03	5/32"	10-32UNF	8	9.3	9.6	22.8	27.6	11.1	31.4	28.6	27.7	24.9	12.7	8
ASV220F-U10/32-07	1/4"	10-32UNF	8	12	9.6	23.6	28.4	11.1	31.4	28.6	27.7	24.9	13.7	9

Note 1) Reference "U10/32" thread dimensions after installation.

Note 2) L4: Reference dimensions

### ASV310F/410F/510F

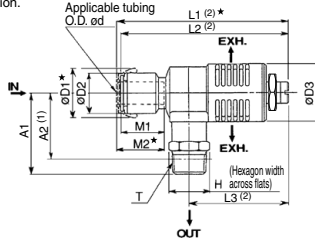

#### Metric Size

Model	Applicable tubing O.D. ed	T	H	D1	D2	D3	L1*		L2		L3		A1(2)	A2	M1	M2*	Weight (g)		
							Max.	Min.	Max.	Min.	Max.	Min.							
ASV310F-01-06S	6	R1/8	10	16.8	12.8	17.6	71.9	65.9	69.9	63.9	45.8	39.8	26.5	23.4	17	19	22		
ASV310F-01-08S	8						19.3	15.2	73.8	67.8								71.8	65.8
ASV310F-02-06S	6						16.8	12.8	71.9	65.9								69.9	63.9
ASV310F-02-08S	8	R1/4	14	19.3	15.2	17.6	73.8	67.8	71.8	65.8	45.8	39.8	30.9	25.4	19	21	31		
ASV410F-01-08S	8						83.1	75.6	81.1	73.6									
ASV410F-01-10S	10						85.2	77.7	83.2	75.7									
ASV410F-02-08S	8	R1/4	14	23.3	18.5	24	83.1	75.6	81.1	73.6	52.8	45.3	29.8	26.7	19	21	41		
ASV410F-02-10S	10						85.2	77.7	83.2	75.7									
ASV410F-03-08S	8						83.1	75.6	81.1	73.6									
ASV410F-03-10S	10	R3/8	17	23.3	18.5	24	85.2	77.7	83.2	75.7	52.8	45.3	35.6	30.4	19	21	61		
ASV510F-02-10S	10						88.2	82.2	86.2	80.2									
ASV510F-02-12S	12						89.8	83.8	87.8	81.8									
ASV510F-03-10S	10	R3/8	17	23.3	18.5	30	88.2	82.2	86.2	80.2	53.6	47.6	40.7	35.5	22	24	78		
ASV510F-03-12S	12						89.8	83.8	87.8	81.8									
ASV510F-04-10S	10						88.2	82.2	86.2	80.2									
ASV510F-04-12S	12	R1/2	22	23.3	18.5	30	89.8	83.8	87.8	81.8	53.6	47.6	44.9	37.6	22	24	100		
							89.8	83.8	87.8	81.8									

\* Dimension with cover Note 1) Reference dimension of "R" thread after installation. Note 2) L1, L2, L3: Reference dimensions

#### Inch Size

Model	Applicable tubing O.D. ed	T	H	D1*	D2	D3	L1*		L2		L3		A1(2)	A1(1)	M1	M2*	Weight (g)
							Max.	Min.	Max.	Min.	Max.	Min.					
ASV310F-N01-07	1/4"	NPT1/8	12.7	17.2	13.2	17.6	73	67	71	65	45.8	39.8	26.5	23.4	16.8	18.8	22
ASV310F-N01-09	5/16"						73.8	67.8	71.8	65.8							
ASV310F-N02-07	1/4"						73	67	71	65							
ASV310F-N02-09	5/16"	NPT1/4	14.3	19.3	15.2	17.6	73.8	67.8	71.8	65.8	45.8	39.8	30.9	25.4	19	21	31
ASV410F-N01-09	5/16"						83.1	75.6	81.1	73.6							
ASV410F-N01-11	3/16"						85.2	77.7	83.2	75.7							
ASV410F-N02-09	5/16"	NPT1/4	14.3	23.3	18.5	24.4	83.1	75.6	81.1	73.6	52.8	45.3	34.2	28.7	19	21	47
ASV410F-N02-11	3/16"						85.2	77.7	83.2	75.7							
ASV410F-N03-09	5/16"						83.1	75.6	81.1	73.6							
ASV410F-N03-11	3/16"	NPT3/8	17.5	19.3	18.5	24.4	85.2	77.7	83.2	75.7	52.8	45.3	35.6	30.4	19	21	63
ASV510F-N02-11	3/16"						88.2	82.2	86.2	80.2							
ASV510F-N02-13	1/2"						89.8	83.8	87.8	81.8							
ASV510F-N03-11	3/16"	NPT3/8	17.5	23.3	18.5	30	88.2	82.2	86.2	80.2	53.6	47.6	40.7	35.5	21	23	73
ASV510F-N03-13	1/2"						89.8	83.8	87.8	81.8							
ASV510F-N04-11	3/16"						88.2	82.2	86.2	80.2							
ASV510F-N04-13	1/2"	NPT1/2	22.2	23.3	18.5	30	89.8	83.8	87.8	81.8	53.6	47.6	44.9	37.6	21	23	95
							89.8	83.8	87.8	81.8							

\* Dimension with cover Note 1) Reference dimension of "NPT" thread after installation. Note 2) L1, L2, L3: Reference dimensions

- AS
- TMH
- ASD
- AS
- AS-FE KE
- AS-FG
- AS-FP
- AS-FM
- AS-D AS-T
- ASP
- ASN
- AQ
- ASV
- AK
- VCHC
- ASS
- ASR ASQ