



# OPERATION MANUAL

PRODUCT NAME : AIR REGULATOR, MANIFOLD REGULATOR

MODEL     ARM10-□□□-□□

ARM10F-□-□□□-□□

ARM11A□□-□□□-□□□

ARM11B□□-□□□-□□□

- Read this operation manual carefully to understand before installation and operation.
- Pay extra attention on the clause concerning the safety.
- Keep this operation manual available whenever necessary.

**SMC CORPORATION**

# CONTENTS

	PAGE
1. PRECAUTIONS FOR SAFETY	1
2. COMMON PRECAUTIONS	2~3
3. VARIOUS BLOCKS/INDIVIDUAL PRECAUTIONS	4
4. PRESSURE SWITCH/INDIVIDUAL PRECAUTIONS	5
5. APPLICATION	6
6. SPECIFICATIONS	6~7
7. HOW TO ORDER	8~11
8. TROUBLE SHOOTING	12
9. CONSTRUCTION/PARTS LIST	13~15
10. HOW TO REPLACE	16~20
11. DIMENSIONS	21~28

CONTACT ADDRESS: SMC CORPORATION

1-16-4, SHINBASHI, MINATO-KU, TOKYO

105-8659, JAPAN

TEL. 03-3502-8271

# 1. PRECAUTIONS FOR SAFETY

Precautions shown here are to ensure the product is used correctly and safely, and to prevent hazard and damage inflicting upon people from occurring. These precautions are divided into three categories, "Caution", "Warning", and "Danger" to indicate the degree of possible hazard and damage, and urgency.

As all these are important for safety, never fail to follow them in addition of ISO4414, JIS B8370, and other safety regulations.

⚠ Caution : Possible harmful effects are expected to be on people and possible loss is expected only of objects when wrong operation occurred.

⚠ Warning : Possible loss or serious injury of people is expected when wrong operation occurred.

⚠ Danger : Imminent danger that possible loss or serious injury of people is expected without evacuation.

※1) ISO 4414 Pneumatic fluid power—General rules relating to systems

※2) JIS B 8370 Common regulations for pneumatic systems.

## WARNING

### ① Suitability of pneumatic equipment should be determined by a designer of the pneumatic system or a person who prescribes its specifications.

Since the product shown here is used in various operating conditions, its suitability to a system should be determined by the pneumatic system designer or the person prescribes its specifications based on necessary analysis and tests. The person who determined the suitability of the system is responsible for the performance at a certain point of time and safety assurance of this system.

A system should be constructed by referring to the latest product information and catalogues, discussing all the contents of specifications, and considering possibilities of equipment failure.

### ② Equipment should be handled by those who have sufficient knowledge and experience

Compressed air fluid could be hazardous if it is handled incorrectly. Assembly, operation and maintenance of machinery and equipment for which pneumatic apparatuses are used should be performed by those who have sufficient knowledge and experience.

### ③ Never handle the machinery or equipment, or never take out the apparatus until safety is confirmed

- a. Check and maintenance of machinery or equipment should be performed after it is confirmed that dropping or uncontrollable running prevention measures are taken for the equipment on which the product is mounted.
- b. Apparatuses should be taken out after it is confirmed equipment corresponding to air supply, that is an energy source, should be turned off; and compressed air in the system should be exhausted.
- c. Re-starting of machinery or equipment should be done with ample care after it is confirmed that prevention measures for sudden movements are taken.

### ④ When the product is used in the following conditions or environment, considerations for safety measures should be given along with consultation to our company

- a. Outdoor usage, or usage in conditions or environment outside of the specifications indicated.
- b. Usage for nuclear power, railroad, air navigation, vehicle, medical equipment, appliances contacting food and beverage, entertainment apparatuses, emergency shutdown circuits, clutch/break circuits for pressing, and safety devices.
- c. Usage for applications which especially require safety because considerable effects to people and properties are expected.

## 2. COMMON PRECAUTIONS

### Design & Selection

#### ⚠ Warning

##### ① Confirm specifications.

Products represented in this manual are designed for use in compressed air applications only, unless otherwise indicated. Do not use the products outside their design parameters. Contact SMC when using the products in applications other than compressed air.

##### ② Confirm set pressure.

Place safety devices in areas where the output pressure is higher than the set pressure of the regulator. Else, it may cause damage to the equipment on secondary side or a malfunction.

③ Residual pressure after exhaust of inlet pressure  
Note that outlet pressure can't be removed (it may have residual pressure) in some cases where inlet pressure is exhausted with outlet pressure set to low

④ Use in the circuit where outlet is enclosed or in balance circuit

Contact SMC before use to confirm availability of the products in these circuits.

### Installation

#### ⚠ Warning

① Do not install unless the operation manual has been read and understood.

##### ② Maintenance

When installing the products, allow access for maintenance.

##### ③ Tightening torque

When installing the products, follow the listed torque specifications.

### Piping

#### ⚠ Caution

Tube insertion and removal from one-touch fittings

##### 1) Installing tube

① Cut the tube perpendicularly, being careful not to damage the outside surface. Use SMC tube cutter "TK-1", "TK-2" or "TK-3". Do not cut the tube with pliers, nippers, scissors, etc. otherwise, the tube will be deformed and troubles may result.

② Grasp the tube, slowly push it into the one-touch fittings until it comes to a stop.

③ Pull the tubing back gently to make sure it has a positive seat. Insufficient installation may cause air leakage or tube releasing.

##### 2) Removing tube

① Push in evenly on the release button.

② Pull out the tube while keeping the release button depressed. If the release button is not held down, the tube cannot be withdrawn.

③ To ensure the tubing, cut off the previously lodged portion of the tube.

Use of tubing other than SMC's brand

#### ⚠ Caution

When using a brand of tubing other than SMC, be careful of the tolerance of the tube's O.D. shown below.

1) Nylon tubing  $\leq \pm 0.1\text{mm}$

2) Soft nylon tubing  $\leq \pm 0.1\text{mm}$

3) Polyurethane tubing  $\leq +0.15\text{mm}$   
 $\leq -0.2\text{mm}$

When the tolerance of the tube's O.D. is out of range mentioned above, do not use the tubing. Tubing can not be connected and it causes air leakage or tubing may come out.

### Air source

#### ⚠ Warning

① Use clear air.

If the compressed air supply is contaminated with chemicals, synthetic materials containing organic solvent, salinity, corrosive gas, etc., damage to the pneumatic equipment may occur.

#### ⚠ Caution

① Install air filter.

Install air filter with filtration of  $5\mu\text{m}$  or less near inlet of the regulator.

② Install other air cleaning equipment such as aftercooler, air dryer and drain catch as necessary.

Compressed air containing a lot of drain may cause pressure switch and other pneumatic equipment as well as the regulator to have malfunction.

③ Place mist separator at inlet of regulator for the environment where carbon dust frequently occurs.

If a lot of carbon dust comes from compressor, a part of the carbon dust may attach inside of the regulator and cause it to have malfunction. For detail of quality of compressed air, refer to "Compressed air cleaning system".

## Environment

### ⚠ Warning

- ① Do not use in an environment where the product is directly exposed to corrosive gases, chemicals, salt water, water or steam.
- ② Do not expose the product to direct sunlight for an extended period of time. If the product has to be mounted in an area where exposure to direct sunlight can not be avoided, the use of a protective cover is recommended.
- ③ Do not mount the product in a location where it is subject to strong vibrations and/or shock. Check the product specifications for above ratings.
- ④ Do not mount the product in a location where it is exposed to radiant heat.

## Maintenance

### ⚠ Warning

- ① Maintenance procedure are outline in this manual. Not following proper procedures could cause to the product to malfunction and could lead to damage to the equipment or machine.
- ② Maintenance  
If handled improperly, compressed air can be dangerous. Assembly, handling and repair of pneumatic systems should be performed by qualified
- ③ Shut-down before maintenance  
sure the supply pressure is shut off and all residual air pressure is released from the system to be worked on.
- ④ Start-up after maintenance

Apply operating pressure and power to the equipment and check for proper operation and possible air leakage. If operation is abnormal, verify product set-up parameters.

- ⑤ Do not make any modification to the product.

## Adjustment

### ⚠ Warning

#### Regulator

- ① Set up the regulator while verifying the pressure that is indicated on inlet and outlet pressure gauges. Turning the handle excessively could damage the internal parts.
- ② Operate pressure adjusting handle manually. Use of any tool may damage the regulator.

### ⚠ Caution

#### Regulator

- ① Make sure to check inlet pressure before setting the pressure.
- ② The range for setting outlet pressure is 85% or less of inlet pressure.
- ③ Release lock of pressure adjusting handle before starting adjustment. Adjustment in improper order may damage the handle and cause fluctuation of outlet pressure.
- ④ Turn the handle clockwise for increase of outlet pressure and counterclockwise for decrease of outlet pressure. (Set pressure turning the handle in pressure incremental direction.)

### ⚠ Caution

#### Indicator of pressure gauge

Indicator of pressure gauge can be moved by removal of lens in the manner shown below.

- ① Open lens in direction arrow pointed by crow of finger.

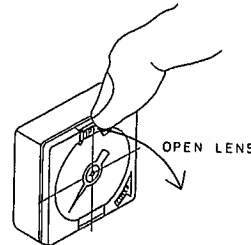

- ② Move the indicator by a kind of flat driver.

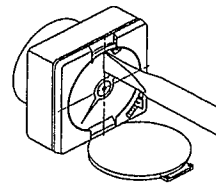

- ③ Close and push the lens until it has snap fit.

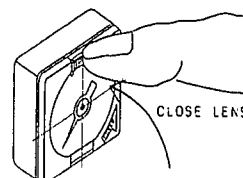

### 3. VARIOUS BLOCKS / INDIVIDUAL PRECAUTIONS

#### ⚠ Warning

Keep tightening torque specified for each screw as shown below.  
Excessive torque may damage block and switch as well as the screw. And insufficient torque may cause looseness of the screw.

#### ① Holding screw and panel nut for single regulator

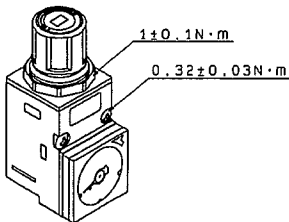

#### ② Holding screw for regulator assembly mounted on regulator block

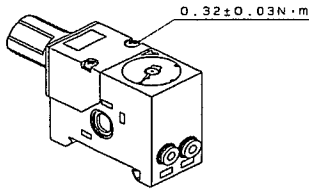

#### ③ Holding screw for blanking plate on regulator block and for pressure gauge

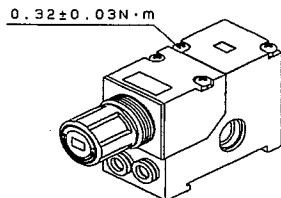

#### ④ Holding screw for common supply block with pressure switch and for pressure switch mounted on pressure switch block

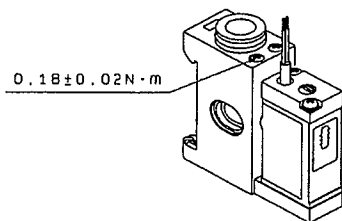

#### ⑤ Clamp screw for DIN rail of end block

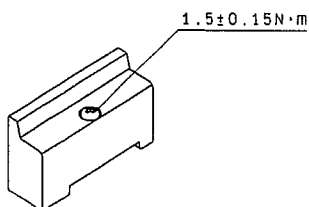

#### ⚠ Caution

Replacement of one-touch fitting  
One-touch fitting is a cassette type fitting and can be replaced easily.

One-touch fitting is hold by clip which is inserted in direction shown below not to come off. Therefore, first remove the clip by a kind of flat driver and enable the fitting to be disconnected. For installation, insert the fitting until it comes to a stop

#### ① Single regulator

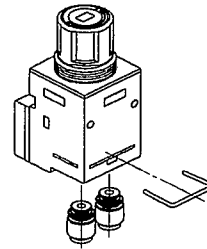

#### ② Regulator block

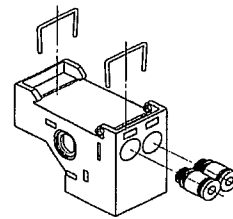

#### ③ Various common supply block

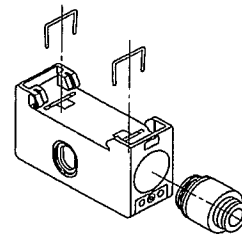

#### ⚠ Caution

Supply of pressure for 3 way valve type common supply block

Keep the handle at the position of OPEN or SHUT for supply of pressure. Since allowing slight air leakage, this product can't be used for the purpose of sealing pressure.

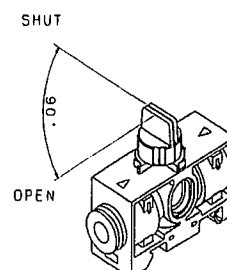

## 4. PRESSURE SWITCH/INDIVIDUAL PRECAUTIONS

### Design & Selection

#### ⚠ Warning

① Operate the switch only within the specified supply voltage limits.  
If supply voltage exceeds the rated voltage, the switch may have malfunction or could be damaged. It could also become a fire hazard.

② Do not exceed the max. allowable load specification. A load exceeding the max. load specification can lead to immediate damage to the switch or could shorten its operating life span considerably.

③ Do not use the switch outside the specified pressure range.

Damage to the switch may occur if the pressure sensor is subjected to the pressure higher than its design parameters.

### Installation

#### ⚠ Warning

① Do not continue to use the equipment and check for the cause of the problem if air leakage is present or increasing or the equipment is not operating. Verify proper installation after air and power is connected. The switch should be checked for proper operation and possible air leakage immediately after the initial installation.

② Do not apply tensile force to cable. Do not handle the switch with holding by the cable because tensile force is applied to the cable and the cord could result in breakage. Handle with holding by the body.

③ Do not drop and apply excessive force to the switch for handling.  
Any damage to the switch, internal or external, could cause the switch to malfunction.

### Pressure source

#### ⚠ Warning

① Do not use corrosive gas and liquid for the switch. The use of the switch with corrosive fluid, gas or liquid, could damage the switch.

② Do not use vacuum for the switch. The use of vacuum causes the switch to absorb outside air and to become unable to operate.

### Adjustment

#### ⚠ Caution

- ① Set pressure scale is the value when pressure increase.
- ② Note that when the switch is used to detect ON pressure, ON signal is outputted by pressure larger than set pressure referred on scale plate by
- ③ Pressure indicated on scale plate is just reference. Know exact value on pressure gauge.

### Wiring

#### ⚠ Warning

① Connect load with the switch.  
Do not supply power for the switch before connecting load there.

② Use a contact protective box.  
If the load moved by the switch is an inductive load or has lead wire of 5m or longer, use contact protective box specified below.

Part no. of box	Voltage	Length of lead wire
CD-P11	AC100V	0.5m connected with switch
CD-P12	DC24V	0.5m connected with load

③ Internal circuit of contact protective box

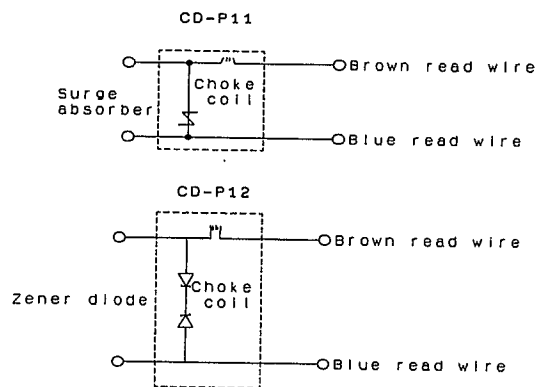

④ Connection of contact protective box  
Connect contact protective box with the switch by using lead wire with indication "SWITCH" of the box and lead wire of the switch. Locate these two products near each other as much as possible by lead wire within 1m.

⑤ Dimensions of lead wire

Outer:  $\phi 3.4$   
Insulation:  $\phi 1.1$   
Conductor:  $\phi 0.64$

### Environment

#### ⚠ Warning

- ① Do not use the switch in explosive environment. In its standard configuration, the switch is not explosion proof. The presence of explosive gas excludes the application of the switch.
- ② Do not use in magnetic environment. The malfunction of the switch could result from magnetic force.
- ③ Do not use in the place where water or oil may splash. The switch is not enclosed and allows water and oil to enter into its inside, corrode electrical circuit and finally cause malfunction and breakage of the switch.
- ④ Do not use in the environment with exposure to vibration. The switch could have failure and dispersion of setting.

## 5. APPLICATION

The product described in this manual aims at pressure controlling of air lines.

## 6. SPECIFICATIONS

### ①Regulator/ARM10type

Regulating type		Direct operation
Piston type		Diaphragm
Relieving construction	Standard	Relief type
	Semi-standard	Non-relief type
Reverse flow mechanism		Yes(Unbalanced type)
Tube O.D. of IN		φ 4, 6, 5/32, 1/4
Tube O.D. of OUT		φ 4, 6, 5/32, 1/4
Proof pressure		1.5MPa
Max. operating pressure		1.0MPa
Set pressure range	Standard	0.05~0.7MPa
	Semi-standard	0.05~0.35MPa (Low pressure type)
Fluid		Air
Ambient and fluid temperature		5~60°C
Weight		60g

### ②Regulator/ARM10Ftype

Regulating type		Direct operation
Piston type		Diaphragm
Relieving construction	Standard	Relief type
	Semi-standard	Non-relief type
Reverse flow mechanism		Yes(Unbalanced type)
Tube O.D. of IN		φ 6, 8, 10, 1/4, 5/16, 3/8
Tube O.D. of OUT		φ 6, 8, 10, 1/4, 5/16, 3/8
Proof pressure		1.5MPa
Max. operating pressure		1.0MPa
Set pressure range	Standard	0.05~0.7MPa
	Semi-standard	0.05~0.35MPa (Low pressure type)
Fluid		Air
Ambient and fluid temperature		5~60°C
Weight		72g



③Manifold regulator/ARM11A/Common supply spec.

(Regulator block·Common supply block·3 way valve type common supply block)

Regulating type		Direct operation
Piston type		Diaphragm
Relieving construction	Standard	Relief type
	Semi-standard	Non-relief type
Reverse flow mechanism		Yes(Unbalanced type)
Tube O.D. of IN		$\phi 6, \phi 8, \phi 10, \phi 1/4, \phi 5/16, \phi 3/8$
Tube O.D. of OUT		$\phi 4, \phi 6, \phi 5/32, \phi 1/4$
Proof pressure		1.5MPa
Max. operating pressure		1.0MPa
Set pressure range	Standard	0.05~0.7MPa
	Semi-standard	0.05~0.35MPa (Low pressure type)
Fluid		Air
Ambient and fluid temperature		5~60°C

Pressure switch (Common supply block with pressure switch, 3 way valve type common supply block + Pressure switch block)

Contact type		Direct operation	
Contact construction		Diaphragm	
Contact composition		1a	
Switching type		Piston type (magnet build-in)	
Electrical entry		Grommet type	
Wire length	Standard	0.5m	
Proof pressure		1.0MPa	
Max. operating pressure		0.7MPa	
Set pressure range		0.1~0.6MPa	
Hysteresis		0.08MPa	
Repeatability		$\pm 0.05$ MPa	
Fluid		Air	
Ambient and fluid temperature		-5~60°C	
Max. contact capacity		AC2VA, DC2W	
Operating voltage AC, DC		24V or less	48V 100V
Max. operating current range		50mA	40mA 20mA
Impact resistance		30G	

④Manifold regulator/ARM11B/Individual supply spec.

Regulating type		Direct operation
Piston type		Diaphragm
Relieving construction	Standard	Relief type
	Semi-standard	Non-relief type
Reverse flow mechanism		Yes(Unbalanced type)
Tube O.D. of IN		$\phi 4, \phi 6, \phi 5/32, \phi 1/4$
Tube O.D. of OUT		$\phi 4, \phi 6, \phi 5/32, \phi 1/4$
Proof pressure		1.5MPa
Max. operating pressure		1.0MPa
Set pressure range	Standard	0.05~0.7MPa
	Semi-standard	0.05~0.35MPa (Low pressure type)
Fluid		Air
Ambient and fluid temperature		5~60°C

# 7. HOW TO ORDER

## ① Regulator/ARM10 type

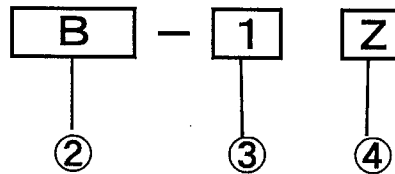
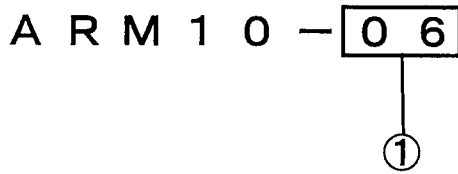

### ① Fitting type for IN and OUT

Mounting position	IN side				OUT side			
	Straight		Elbow		Straight		Elbow	
Symbol	$\phi 4$	$\phi 6$	$\phi 4$	$\phi 6$	$\phi 4$	$\phi 6$	$\phi 4$	$\phi 6$
06	●				●			
07		●			●			
08		●				●		
18			●				●	
19				●			●	
20				●				●
25	●						●	
26		●					●	
27		●						●
32			●		●			
33				●	●			
34				●		●		
Symbol	$\phi 5/32$	$\phi 1/4$	$\phi 5/32$	$\phi 1/4$	$\phi 5/32$	$\phi 1/4$	$\phi 5/32$	$\phi 1/4$
56	●				●			
57		●			●			
58		●				●		
68			●				●	
69				●			●	
70				●				●
75	●						●	
76		●					●	
77		●						●
82			●		●			
83				●	●			
84				●		●		

### ③ Semi standard

Symbol	None	Set pressure of 0.35MPa	Non-relief	Lub.Free
NIL	●			
1		●		
2			●	
3				●
4		●	●	
5		●		●
6			●	●
7		●	●	●

(Note1) Attached pressure switch has full span 0.4MPa.  
 (Note2) Pil free spec. is realized by elimination of grease from parts in contact with fluid.

### ④ Unit

Symbol	Content
NIL	Unit indicated on name plate and pressure gauge is MPa
Z	Unit indicated on name plate and pressure gauge is Mpa

(Note 1) Z is applicable to only overseas because of new measurement law in Japan(S1 unit)

### ② Accessory

Symbol	None	Bracket (Note1)	Pressure gauge (Note2)	Panel nut
NIL	●			
B		●		(●)
G			●	
P				●
BG		●	●	(●)
GP			●	●

(Note1) Panel nut is attached as well.  
 (Note2) Not applicable to copper free spec.

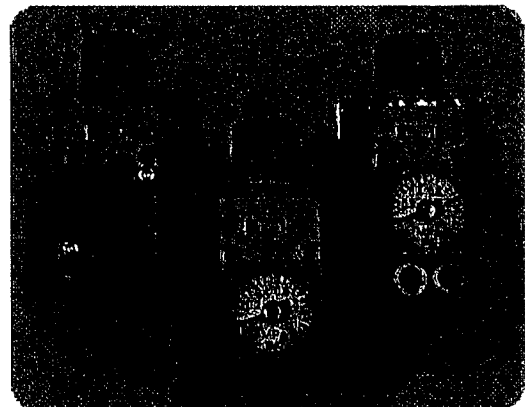

## ② Regulator/ARM10F type

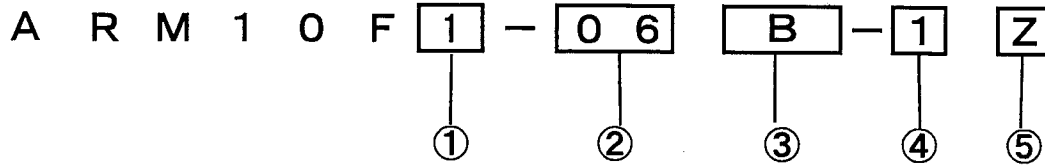

### ① IN·OUT position

Symbol	IN		OUT	
	Bottom	Top	Bottom	Top
1	●		●	
2		●		●
3	●			●
4		●	●	

### ④ Semi standard

Symbol	None	Set pressure of 0.35MP	Non-relief	Lub.Free
NIL	●			
1		●		
2			●	
3				●
4		●	●	
5		●		●
6			●	●
7		●	●	●

(Note1) Attached pressure switch has full span 0.4MPa.  
 (Note2) Pil free spec. is realized by elimination of grease from parts in contact with fluid.

### ② Fitting type for IN and OUT

Mounting position	IN side				OUT side			
	Straight		Elbow		Straight		Elbow	
Symbol	φ 4	φ 6	φ 4	φ 6	φ 4	φ 6	φ 4	φ 6
06	●				●			
07		●			●			
08		●				●		
18			●				●	
19				●			●	
20				●				●
25	●						●	
26		●					●	
27		●						●
32			●		●			
33				●	●			
34				●		●		
Symbol	φ 5/32	φ 1/4	φ 5/32	φ 1/4	φ 5/32	φ 1/4	φ 5/32	φ 1/4
56	●				●			
57		●			●			
58		●				●		
68			●				●	
69				●			●	
70				●				●
75	●						●	
76		●					●	
77		●						●
82			●		●			
83				●	●			
84				●		●		

### ⑤ Unit

Symbol	Content
NIL	Unit indicated on name plate and pressure gauge is MPa
Z	Unit indicated on name plate and pressure gauge is Psi

(Note1) Z is applicable to only overseas because of new measurement law in Japan(S1 unit)

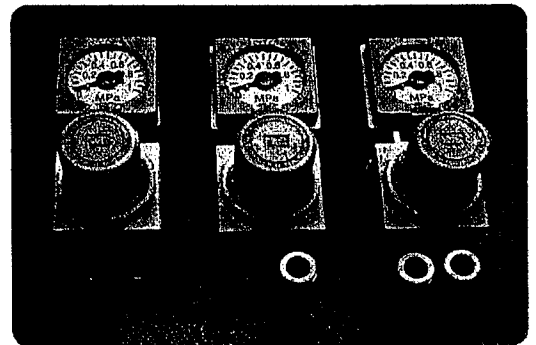

### ③ Manifold regulator/ARM11A/common supply block spec.

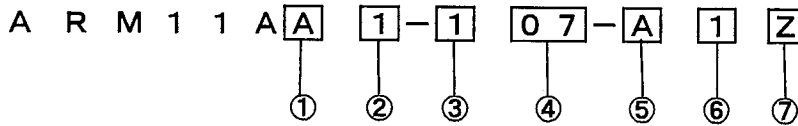

#### ① Handle position

Symbol	Handle
A	Top
B	Side
C	Bottom

#### ③ No. of station of regulator block

Symbol	STN.
1	1
2	2
3	3
4	4
5	5
6	6
7	7
8	8
9	9
M	10

#### ② IN·OUT position

Symbol	IN		OUT	
	Bottom	Top	Bottom	Top
1	●			
2		●		●
3	●			●
4		●	●	

#### ④ Fitting type (for IN and OUT)

Mounting position	IN						OUT				
	Fitting type	Straight			Elbow			Straight		Elbow	
		Symbol	φ6	φ8	φ10	φ6	φ8	φ10	φ4	φ6	φ4
07	●							●			
08	●									●	
09		●						●			
10		●							●		
11			●					●			
12			●						●		
19				●						●	
20				●							●
21					●					●	
22						●					●
23							●			●	
24							●				●
26	●								●		
27	●									●	
28		●								●	
29		●									●
30			●							●	
31				●							●
33					●				●		
34						●				●	
35							●				●
36							●				●
37								●			●
38								●			●
Symbol	φ1/4	φ5/16	φ3/8	φ1/4	φ5/16	φ3/8	φ5/32	φ1/4	φ5/32	φ1/4	
57	●									●	
58	●										●
59		●							●		
60		●								●	
61			●						●		
62			●							●	
69				●							●
70				●							●
71					●					●	
72						●					●
73							●				●
74								●			●
76	●									●	
77	●										●
78		●									●
79		●									●
80			●								●
81			●								●
83				●						●	
84					●						●
85						●				●	
86							●				●
87								●			●
88									●		●

(Note1) If position of handle is same as one of piping using elbow, the elbow shall be mounted on the back(DIN rail side)

#### ⑤ Accessory

Symbol	Pressure gauge		Supply block type				Supply block mounting position		
	None	Attached	Common supply block	Common supply block with pressure switch	3 way valve type common supply block	3 way valve type common supply block + Pressure switch block	Side L (Left)	Side R (Right)	Side B (Both sides)
NIL	●		●				●		
A	●			●			●		
B	●				●		●		
C	●					●	●		
D	●		●					●	
E	●			●				●	
F	●				●			●	
G	●					●		●	
H	●		●						●
J		●	●				●		
K		●		●				●	
L		●			●		●		
M		●				●	●		
N		●	●					●	
O		●		●				●	
P		●			●			●	
Q		●				●		●	
R		●	●						●

(Note1) Not applicable to copper free spec.  
(Note2) Pressure switch inapplicable for oil-free.

#### ⑥ Semi-standard

Symbol	None	Set press of 0.35MPa	Non-relief	Lub.Free
NIL	●			
1		●		
2			●	
3				●
4		●	●	
5		●		●
6			●	●
7		●	●	●

(Note1) Attached pressure switch has full span 0.4MPa.  
(Note2) Oil free spec. is realized by elimination of grease from parts in contact with fluid.

#### ⑦ Unit

Symbol	Content
NIL	Unit indicated on name plate and pressure gauge is MPa
Z	Unit indicated on name plate and pressure gauge is Psi

(Note 1) Z is applicable to only overseas because of new measurement law in Japan (SI unit).  
Also dual indication of MPa and Psi is adopted for Z.

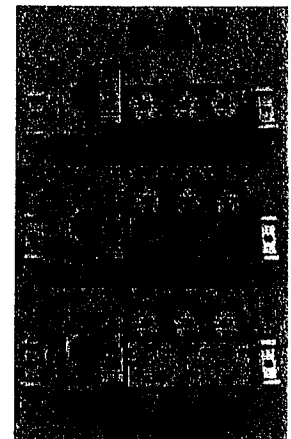

#### ④ Manifold regulator/ARM11B/Individual

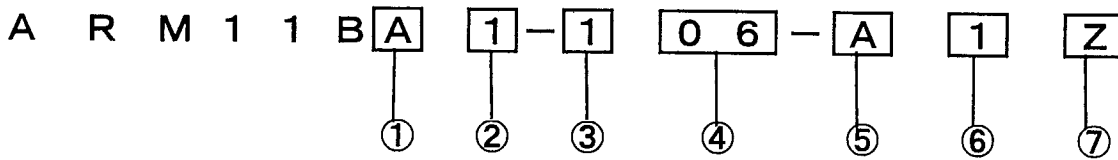

#### ① Handle position

Symbol	Handle
A	Top
B	Side
C	Bottom

#### ③ No. of station of regulator block

Symbol	STN.
1	1
2	2
3	3
4	4
5	5
6	6
7	7
8	8
9	9
M	10

#### ② IN·OUT position

Symbol	IN		OUT	
	Bottom	Top	Bottom	Top
1	●		●	
2		●		●
3	●			●
4		●	●	

#### ③ Fitting type for IN and OUT

Mounting position	IN side				OUT side			
	Straight		Elbow		Straight		Elbow	
Symbol	φ4	φ6	φ4	φ6	φ4	φ6	φ4	φ6
06	●				●			
07		●			●			
08		●				●		
18			●				●	
19				●			●	
20				●				●
25	●						●	
26		●					●	
27		●						●
32			●		●			
33				●	●			
34				●		●		
Symbol	φ5/32	φ1/4	φ5/32	φ1/4	φ5/32	φ1/4	φ5/32	φ1/4
56	●				●			
57		●			●			
58		●				●		
68			●				●	
69				●			●	
70				●				●
75	●						●	
76		●					●	
77		●						●
82			●		●			
83				●	●			
84				●		●		

(Note1) If position of handle is same as one of piping using elbow, the elbow shall be mounted on the back(DIN rail side)

#### ⑤ Accessory

Symbol	None
NIL	Without pressure gauge
A	With pressure gauge

(Note2) ✕ Not applicable to copper free spec.

#### ⑥ Semi-standard

Symbol	None	Set press of 0.35MPa	Non-relief	Lub.Free
NIL	●			
1		●		
2			●	
3				●
4		●	●	
5		●		●
6			●	●
7		●	●	●

(Note1) Attached pressure switch has full span 0.4MPa.  
 (Note2) Pfl free spec. is realized by elimination of grease from parts in contact with fluid.

#### ⑦ Unit

Symbol	Content
NIL	Unit indicated on name plate and pressure gauge is MPa
Z	Unit indicated on name plate and pressure gauge is Psi

(Note1) Z is applicable to only overseas because of new measurement law in Japan(S1 unit)

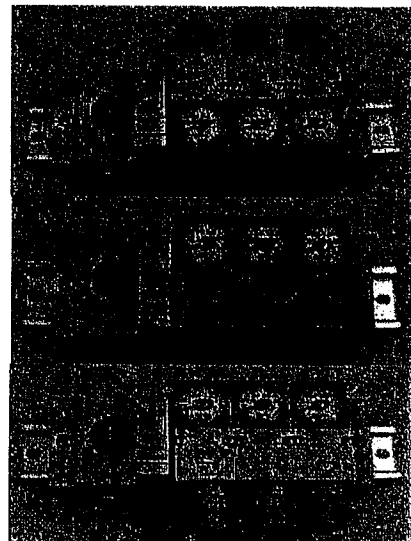

## 8. TROUBLESHOOTING

Refer to Fig.1(shown in next page)

TROUBLE		POSSIBLE CAUSE	REMEDY	Applicable model
Demarcation	Phenomenon			
Pressure	Pressure is not regulated.	1. Opposite installation of IN and OUT tube. ----- 2. Foreign materials caught in valve seat or its "O" ring. ----- 3. Damaged rubber lining on valve or O ring of valve seat.	1. Check installing direction of tube and if installed opposite, reinstall it. ----- 2. Remove bonnet, diaphragm assembly and valve seat assembly and wash valve seat and its "O" ring. ----- 3. Replace the valve seat or the "O" ring.	ARM10 ARM10F ARM11
	Set pressure does not return to zero when pressure handle is loosened.	1. Foreign materials caught in valve seat or its "O" ring. ----- 2. Damaged rubber lining on valve or O ring of valve seat.	1. Remove bonnet, diaphragm assembly and valve seat assembly and wash valve seat and its "O" ring. ----- 2. Replace the valve seat or the "O" ring.	
Air leakage	Air leaks the bonnet exhaust port (near the handle).	1. Damaged diaphragm. ----- 2. Foreign materials caught in valve seat or its "O" ring. ----- 3. Damaged rubber lining on valve or O ring of valve seat. ----- 4. Application of back pressure exceeding the set pressure to the outlet.	1. Replace the diaphragm assembly. ----- 2. Remove bonnet, diaphragm assembly and valve seat assembly and wash valve seat and its "O" ring. ----- 3. Replace the valve seat or the "O" ring. ----- pressure does not exceed the set pressure	
	Air leaks between bonnet and body.	1. Damaged diaphragm. ----- 2. Foreign materials caught in valve seat or its "O" ring.	1. Replace the diaphragm assembly. ----- 2. Remove bonnet, diaphragm assembly and valve seat assembly and wash valve seat and its "O" ring.	
	Air leaks between fitting and body.	1. Foreign materials caught in "O" ring of fitting. ----- 2. Damaged "O" ring of fitting	1. Remove the fitting assembly and wash its "O" ring. ----- 2. Replace the "O" ring.	
	Air leaks between fitting and tube.	1. Foreign materials caught in packing inside fitting. ----- 2. Damaged surface of tube. ----- 3. Improper connection between fitting and tube.	1. Remove the fitting assembly and wash the packing inside it. ----- 2. Replace the tube. ----- 3. Check mounting condition of tube and if mounted improperly, remount the tube to the fitting.	
	Air leaks between body (manifold) and blanking plate (pressure gauge).	1. Foreign materials caught in "O" ring of body (manifold). ----- 2. Damaged "O" ring of fitting.	1. Remove blanking plate (pressure gauge) from the body (manifold) and wash its "O" ring. ----- 2. Replace "O" ring of the body (manifold).	
	Air leaks between body and manifold block.	1. Foreign materials caught in gasket of manifold block.. ----- 2. Damaged gasket of manifold block..	1. Remove the body and replace its gasket. ----- 2. Replace the gasket.	
	Air leaks between bocks.	1. Foreign materials caught in "O" ring of bush of blocks. ----- 2. Damaged "O" ring of bush of blocks	1. Remove the bush and wash its "O" ring. ----- 2. Replace "O" ring of the bush.	

Note) The grease needs to be applied on washed "O" ring and gasket except for lub. free spec. Recommended grease is Mitsubishi diamond multipurpose No.2.

## 9. CONSTRUCTION/PARTS LIST

### ①Regulator/ARM10type

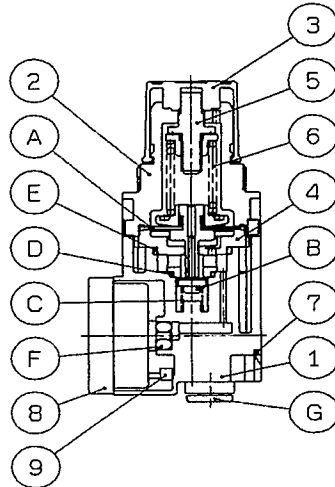

#### Componet parts

No.	Description	Material
1	Body	PBT
2	Bonnet	PBT
3	Handle	POM
4	Valve seat	POM
5	Pressure adjusting screw assembly	Steel for structural member
6	Pressure adjusting spring	steel wire
7	Clip for regulator	Stainless steel
8	Blanking plate assembly	—
9	Square nut	Steel plate

#### Replacement parts

No.	Description	Material	Part no.
A	Diaphragm assembly	Weather proof NBR•POM	136126A
B	Valve	HNBR•aluminum alloy	136127-30
C	Valve spring	Stainless steel	136131
D	Oring	NBR	136146
E	Oring	NBR	136147
F	Oring	NBR	136148
G	Fitting assembly	—	Refer to P15

### ①Regulator/ARM10Ftype

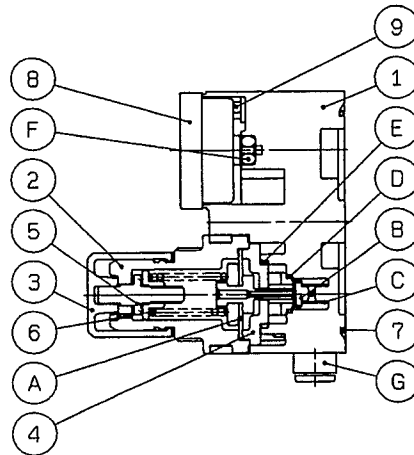

#### Componet parts

No.	Description	Material
1	Body	PBT
2	Bonnet	PBT
3	Handle	POM
4	Valve seat	POM
5	Pressure adjusting screw assembly	Steel for structural member
6	Pressure adjusting spring	steel wire
7	Clip for regulator	Stainless steel
8	Blanking plate assembly	—
9	Square nut	Steel plate

#### Replacement parts

No.	Description	Material	Part no.
A	Diaphragm assembly	Weather proof NBR•POM	136126A
B	Valve	HNBR•aluminum alloy	136127-30
C	Valve spring	Stainless steel	136131
D	Oring	NBR	136146
E	Oring	NBR	136147
F	Oring	NBR	136148
G	Fitting assembly	—	Refer to P15

## 9. CONSTRUCTION/PARTS LIST

### ③ Manifold regulator/ARM11A/Common supply spec.

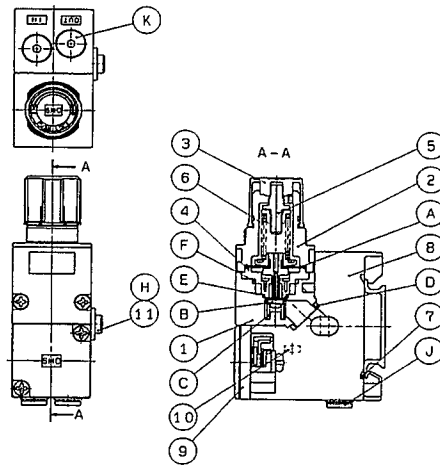

#### Component parts

No.	Description	Material
1	Body for regulator block	PBT
2	Bonnet	PBT
3	Handle	POM
4	Valve seat	POM
5	Pressure adjusting screw assembly	Steel for structural member
6	Pressure adjusting spring	Steel wire
7	Clip for regulator	Stainless steel
8	Manifold block	PBT
9	Blanking plate assembly	—
10	Square nut	Steel plate
11	Common supply bush	POM

#### Replacement parts

No.	Description	Material	Part no.
A	Diaphragm assembly	Weather proof NBR·POM	136126A
B	Valve	HNBR·aluminum alloy	136127-30
C	Valve spring	Stainless steel	136131
D	Gasket	HNBR	136137-30
E	O-ring	NBR	136146
F	O-ring	NBR	136147
G	O-ring	NBR	136148
H	O-ring	NBR	136149
J	Fitting assembly	—	Refer to P15
K	Port plug	PBT·HNBR	VVQ0000-58A

### ④ Manifold regulator/ARM11B/Common supply spec.

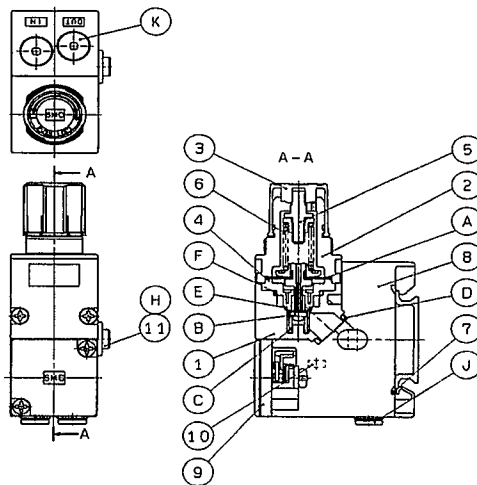

#### Component parts

No.	Description	Material
1	Body for regulator block	PBT
2	Bonnet	PBT
3	Handle	POM
4	Valve seat	POM
5	Pressure adjusting screw assembly	Steel for structural member
6	Pressure adjusting spring	Steel wire
7	Clip for regulator	Stainless steel
8	Manifold block	PBT
9	Blanking plate assembly	—
10	Square nut	Steel plate
11	Individual supply bush	POM

#### Replacement parts

No.	Description	Material	Part no.
A	Diaphragm assembly	Weather proof NBR·POM	136126A
B	Valve	HNBR·aluminum alloy	136127-30
C	Valve spring	Stainless steel	136131
D	Gasket	HNBR	136137-30
E	O-ring	NBR	136146
F	O-ring	NBR	136147
G	O-ring	NBR	136148
H	O-ring	NBR	136149
J	Fitting assembly	—	Refer to P15
K	Port plug	PBT·HNBR	VVQ0000-58A



### ⑤ One-touch fitting for regulator

V V Q 1 0 0 0 - 5 0 A - L 1 C 4 - X 1 7

One-touch fitting for regulator

Fitting type	
Symbol	Type
Nil	Straight
L1	Elbow

Fitting size	
Symbol	size
C4	φ 4
C6	φ 6
N3	φ 5/32
N7	φ 1/4

Option	
Symbol	Specifications
Nil	Standard
X17	Oil-free

#### 1) Regulator/ARM10 type

Straight type

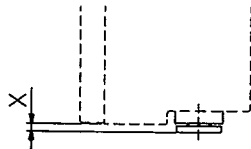

Fitting size	X
Ø4, Ø5/32	2
Ø6	2
Ø1/4	6

Elbow type

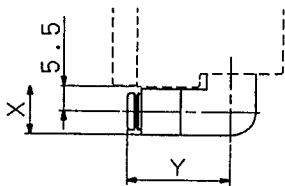

Fitting type	X	Y
Ø4, Ø5/32	10.5	21.5
Ø6	10.5	22
Ø1/4	10.6	24.5

#### 1) Regulator/ARM10F type

Straight type

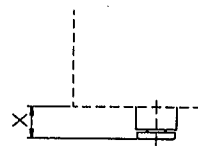

Fitting type	X
Ø4, Ø5/32	7
Ø6	7
Ø1/4	11

Elbow type

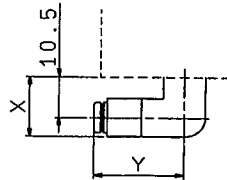

Fitting type	X	Y
Ø4, Ø5/32	15.5	21.5
Ø6	15.5	22
Ø1/4	15.6	24.5

#### 3) Manifold regulator/ARM11 type

Straight type

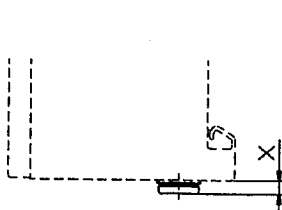

Fitting size	X
Ø4, Ø5/32	3
Ø6	3
Ø1/4	7

Elbow type

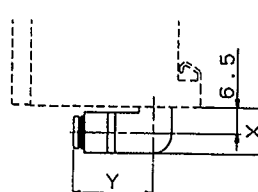

Fitting size	X	Y
Ø4, Ø5/32	11.5	19
Ø6	11.5	19.5
Ø1/4	11.6	22

# 10.REPLACEMENT PROCEDURE

## ⚠ WARNING

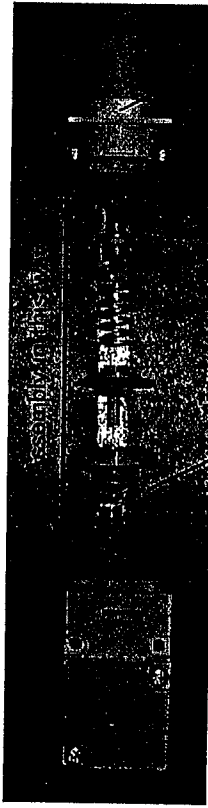

Before replacement, ensure that the regulator is not pressurized.

Rotate the pressure adjusting handle counterclockwise fully and to return it to zero operation.

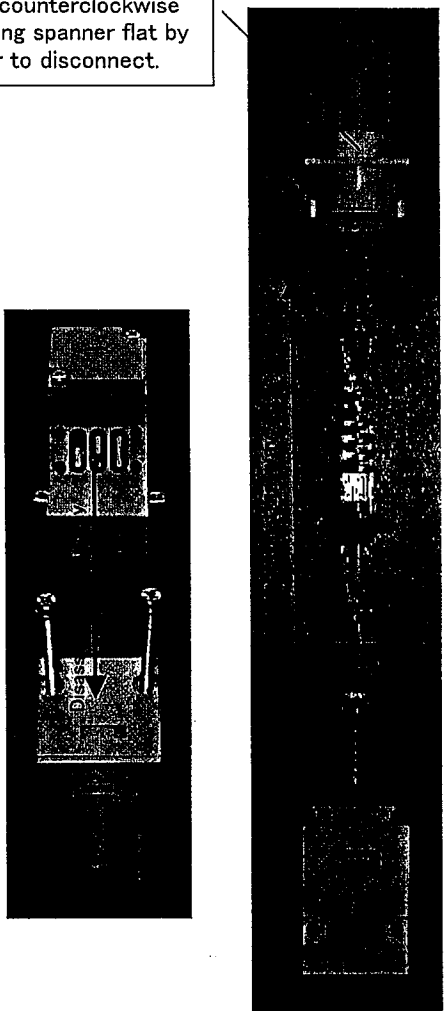
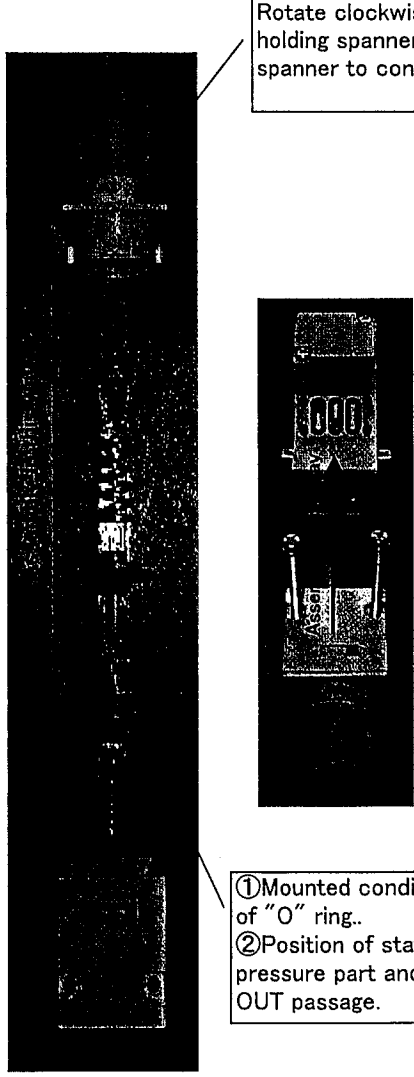
Model	ARM10,ARM10F	
Description	Regulator	
Content	Wash and replacement of diaphragm, rubber part, valve and valve spring	
Process	Disassembly	Assembly
Procedure	<ol style="list-style-type: none"> <li>① Rotate bonnet counterclockwise by holding its spanner flat by spanner to disconnect. (Remain pressure adjusting screw and spring mounted on)</li> <li>② Remove diaphragm assembly.</li> <li>③ Remove valve seat assembly by holding by snap ring pliers.</li> <li>④ Remove valve and valve spring.</li> </ol>	<ol style="list-style-type: none"> <li>① Mount valve spring and valve by pincette.</li> <li>② Mount valve seat assembly (with two "O" rings mounted) by snap ring pliers so that static pressure part of valve seat and OUT passage could be in proper position.</li> <li>③ Hold the valve seat assembly accessing from side opening to prevent it from coming off.</li> <li>④ Mounng diaphragm assembly.</li> <li>⑤ Mount bonnet which has pressure adjusting screw and spring installed to body and rotate it by holding spanner flat by spanner clockwise to connect with the body.</li> </ol>
Tools	Spanner (18mm in width), Snap ring pliers, Pincette	
Check item	-	<ol style="list-style-type: none"> <li>① Presence of "O" ring.</li> <li>② Position of static pressure part of valve seat and OUT passage.</li> </ol>
Referntial photo	 <p>Rotate counterclockwise by holding spanner flat by spanner to disconnect.</p>	 <p>Rotate clockwise by holding spanner flat by spanner to connect.</p> <p>① Mounted condition of "O" ring ② Position of static pressure part and OUT passage.</p>

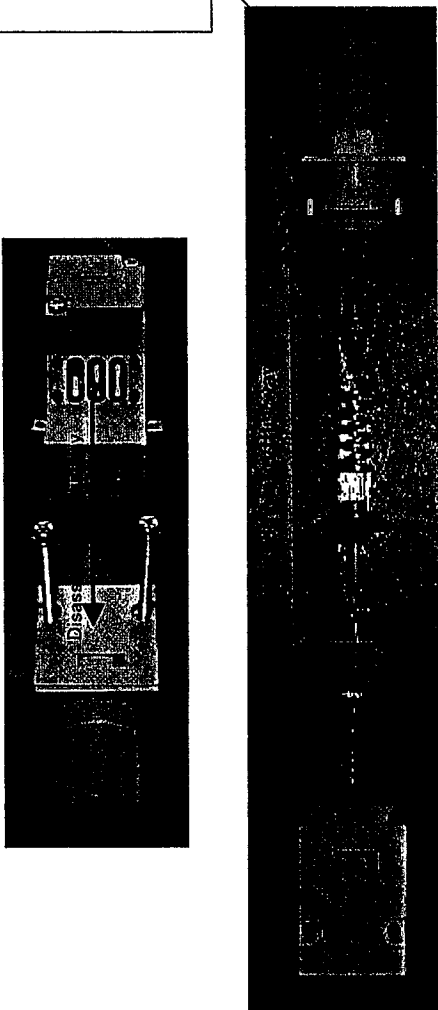
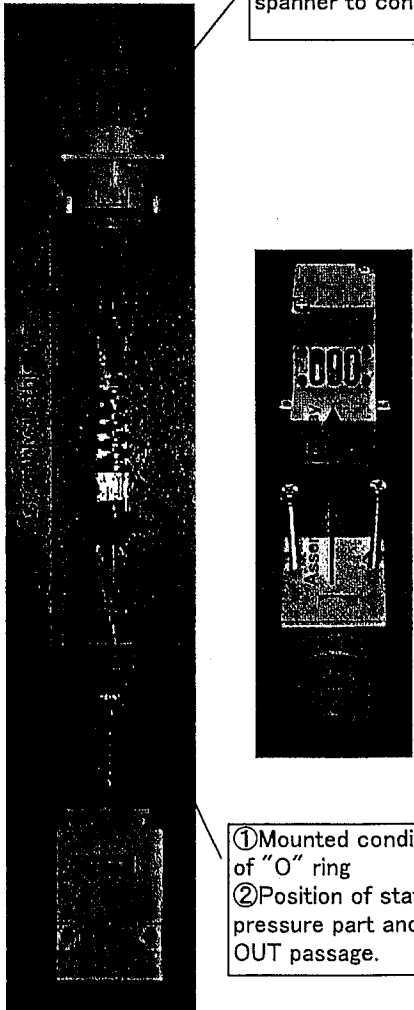
Model	ARM11□A, ARM11□C	
Description	Regulator block (Handle position: Top or bottom)	
Content	Wash and replacement of gasket, diaphragm, rubber part, valve and valve spring	
Process	Disassembly	Assembly
Procedure	<ol style="list-style-type: none"> <li>① Loosen and remove round screws of regulator assembly by Phillips driver to become the regulator assembly able to be disconnected manually.</li> <li>② Rotate bonnet counterclockwise by holding its spanner flat by spanner to disconnect. (Remain pressure adjusting screw and spring mounted on the</li> <li>③ Remove diaphragm assembly manually.</li> <li>④ Remove valve assembly with held by snap ring pliers.</li> <li>⑤ Remove valve and valve spring.</li> </ol>	<ol style="list-style-type: none"> <li>① Mount valve spring and valve by pincette.</li> <li>② Mount valve seat assembly (with two "O" rings mounted) by snap ring pliers so that static pressure part of valve seat and character "A" on body.</li> <li>③ Hold the valve seat assembly accessing from side opening to prevent it from coming off.</li> <li>④ Mounq diaphragm assembly.</li> <li>⑤ Mount bonnet which has pressure adjusting screw and spring installed to body and rotate it by holding spanner flat by spanner clockwise to connect with the body.</li> <li>⑥ Mount regulator assembly on manifold block and hold it by tightening two round screws by Phillips driver.</li> </ol>
Tools	Phillips driver, Spanner (18mm in width), Snap ring pliers, Pincette	
Check item	-	<ol style="list-style-type: none"> <li>① Presence of "O" ring.</li> <li>② Position of static pressure part of valve seat and character "A" on body.</li> <li>③ Tightening torque of round screw: <math>0.32 \pm 0.03 \text{N} \cdot \text{cm}</math></li> </ol>
Referential photo	<p>Rotate counterclockwise by holding spanner flat by spanner to disconnect.</p> 	<p>Rotate clockwise by holding spanner flat by spanner to connect.</p>  <p>① Mounted condition of "O" ring. ② Position of static pressure part and OUT passage.</p>

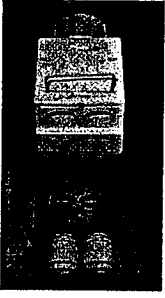
Model	ARM11□B	
Description	Regulator block (Handle position: Front type)	
Content	Wash and replacement of gasket, diaphragm, rubber part, valve and valve spring	
Process	Disassembly	Assembly
Procedure	<ol style="list-style-type: none"> <li>① Loosen and remove round screws of regulator assembly by Phillips driver to become the regulator assembly able to be disconnected manually.</li> <li>② Rotate bonnet counterclockwise by holding its spanner flat by spanner to disconnect. (Remain pressure adjusting screw and spring mounted on the)</li> <li>③ Remove diaphragm assembly manually.</li> <li>④ Remove valve assembly with held by snap ring pliers.</li> <li>⑤ Remove valve and valve spring.</li> </ol>	<ol style="list-style-type: none"> <li>① Mount valve spring and valve by pincette.</li> <li>② Mount valve seat assembly (with two "O" rings mounted) by snap ring pliers so that static pressure part of valve seat and character "A" on body.</li> <li>③ Hold the valve seat assembly accessing from side opening to prevent it from coming off.</li> <li>④ Mounq diaphragm assembly.</li> <li>⑤ Mount bonnet which has pressure adjusting screw and spring installed to body and rotate it by holding spanner flat by spanner clockwise to connect with the body.</li> <li>⑥ Mount regulator assembly on manifold block and hold it by tightening two round screws by Phillips driver.</li> </ol>
Tools	Phillips driver, Spanner (18mm in width), Snap ring pliers, Pincette	
Check item	-	<ol style="list-style-type: none"> <li>① Presence of "O" ring.</li> <li>② Position of static pressure part of valve seat and character "B" on body.</li> <li>③ Tightening torque of round screw: <math>0.32 \pm 0.03 \text{N} \cdot \text{cm}</math></li> </ol>
Referential photo	<p>Rotate counterclockwise by holding spanner flat by spanner to disconnect.</p> 	<p>Rotate clockwise by holding spanner flat by spanner to connect.</p>  <p>① Mounted condition of "O" ring ② Position of static pressure part and OUT passage.</p>

Model	ARM10,ARM10F,ARM 11	
Description	Regulator, Manifold block	
Content	Wash, air blowing and replacement of gasket, diaphragm, rubber part, valve and valve spring	
Process	Disassembly	Assembly
Procedure	<ol style="list-style-type: none"> <li>① Remove clip with held by flat small driver.</li> <li>② Pull fitting assembly out manually.</li> </ol>	<ol style="list-style-type: none"> <li>① Push fitting assembly until it comes to a stop to mount.</li> <li>② Push clip until it comes to a stop to mount.</li> </ol>
Tools	Small flat rvier	
Check item	-	<ol style="list-style-type: none"> <li>① Confirmation that the fitting assembly reaches mounting end for it.</li> <li>② Confirmation that the clip reaches mounting end for it.</li> </ol>
Referntial photo		

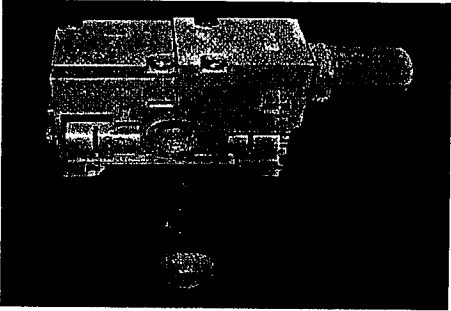
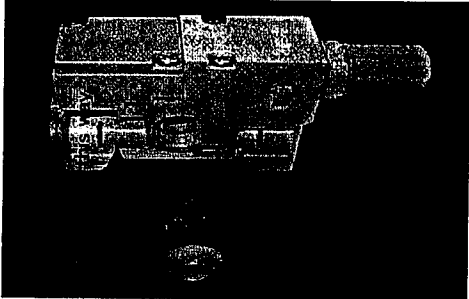
Model	ARM11	
Description	Regulator block	
Content	Wash and replacement of "O" ring of bush	
Process	Disassembly	Assembly
Procedure	<ol style="list-style-type: none"> <li>① Remove bush with held by flat small driver.</li> <li>② Remove "O" ring from the bush.</li> </ol>	<ol style="list-style-type: none"> <li>① Mount "O" ring to bush.</li> <li>② Push the bush until it comes to a stop to mount.</li> </ol>
Tools	Small flat rvier	
Check item	-	<ol style="list-style-type: none"> <li>① Confirmation that the bush reaches mounting end for it.</li> </ol>
Referntial photo	 <div style="border: 1px solid black; padding: 2px; width: fit-content; margin-top: 5px;">       Hold here by driver.     </div>	

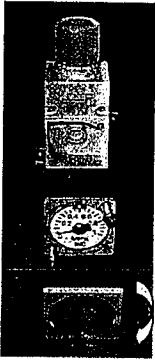
Model	ARM10,ARM10F	
Description	Regulator	
Content	Wash and replacement of "O" ring of pressure gauge	
Process	Disassembly	Assembly
Procedure	<ol style="list-style-type: none"> <li>① Remove cover assembly by rotating counterclockwise manually.</li> <li>② Loosen and remove two round screw by Phillips driver.</li> <li>③ Remove pressure gauge assembly.</li> <li>④ Remove "O" ring.</li> </ol>	<ol style="list-style-type: none"> <li>① Mount "O" ring.</li> <li>② Mount pressure gauge assembly.</li> <li>③ Hold the pressure gauge assembly by tightening two round screws by Phillips driver.</li> <li>④ Mount cover assembly by rotating clockwise manually. (Mind direction of cover and position of locating mark and detent.)</li> </ol>
Tools	Phillips driver	
Check item	-	<ol style="list-style-type: none"> <li>① Presence of "O" ring</li> <li>② Tightening torque of round screw: <math>0.32 \pm 0.03 \text{N} \cdot \text{cm}</math></li> </ol>
Referential photo	 <p style="text-align: center;">Rotate</p>	 <p style="text-align: center;">Rotate</p>

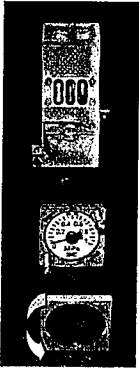
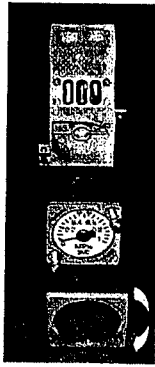
Model	ARM11	
Description	Regulator block	
Content	Wash and replacement of "O" ring of pressure gauge	
Process	Disassembly	Assembly
Procedure	<ol style="list-style-type: none"> <li>① Loosen and remove round screws from regulator assembly by Phillips driver to become the regulator assembly able to be disconnected.</li> <li>② Remove cover assembly by rotating counterclockwise manually.</li> <li>③ Remove two round screws from pressure assembly by Phillips driver.</li> <li>④ Remove pressure gauge assembly.</li> <li>⑤ Remove "O" ring.</li> </ol>	<ol style="list-style-type: none"> <li>① Mount "O" ring to bush.</li> <li>② Mount pressure gauge assembly.</li> <li>③ Hold the pressure gauge assembly by tightening two round screws by Phillips driver.</li> <li>④ Mount cover assembly by rotating clockwise manually. (Mind direction of cover and position of locating mark and detent.)</li> <li>⑤ Mount regulator assembly to manifold block and hold it by tightening two round screws by</li> </ol>
Tools	Phillips driver	
Check item	-	<ol style="list-style-type: none"> <li>① Presence of "O" ring</li> <li>② Tightening torque of round screw: <math>0.32 \pm 0.03 \text{N} \cdot \text{cm}</math></li> </ol>
Referential photo	 <p style="text-align: center;">Rotate</p>	 <p style="text-align: center;">Rotate</p>

# 11. DIMENSIONS

## ① Regulator/ARM10type

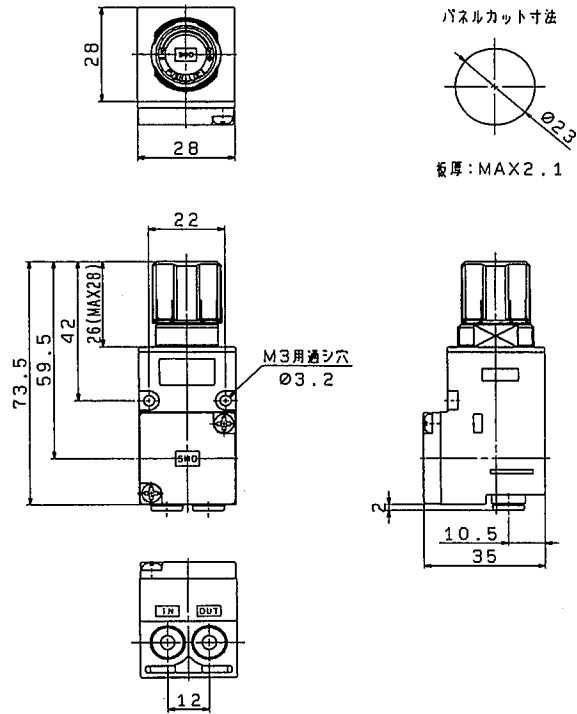

## ② Regulator/ARM10Ftype

### ARM10F1-06

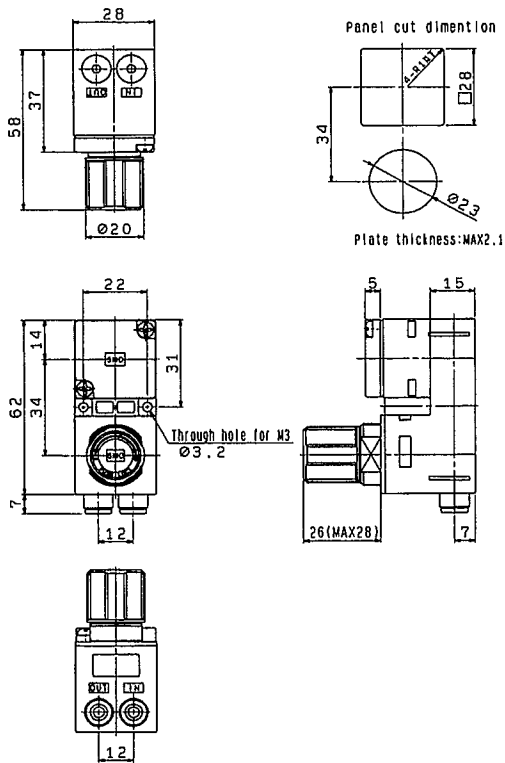

### ARM10F1-06GPC

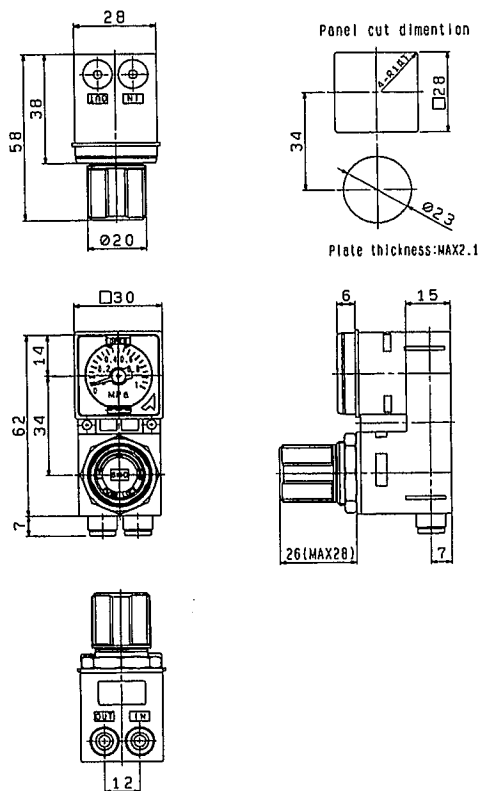

③Manifold regulator / common air supply spec.

ARM11AA1 - \* 12

Handle position top spec / common supply block

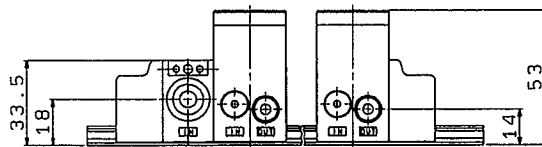
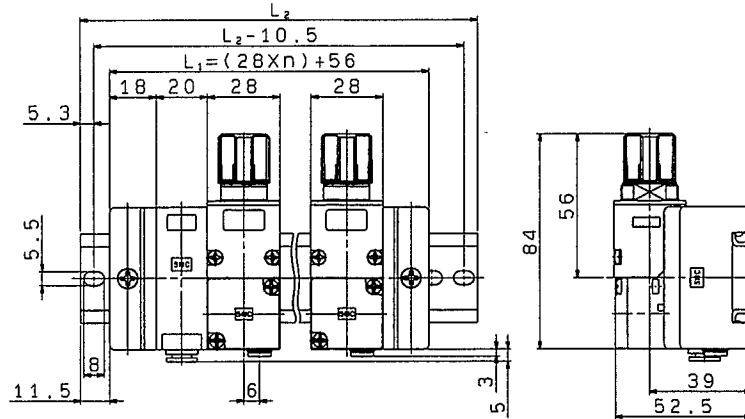

Stn.	Din rail no. (for side L,R)	L <sub>1</sub> Dimension
1	AXT100-DR-9	123
2	AXT100-DR-11	148
3	AXT100-DR-13	173
4	AXT100-DR-16	210.5
5	AXT100-DR-18	235.5
6	AXT100-DR-20	260.5
7	AXT100-DR-22	285.5
8	AXT100-DR-25	323
9	AXT100-DR-27	348
M	AXT100-DR-29	373

ARM11AA1 - \* 12-A

Handle position top spec / common supply with pressure switch

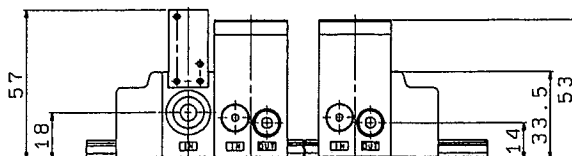
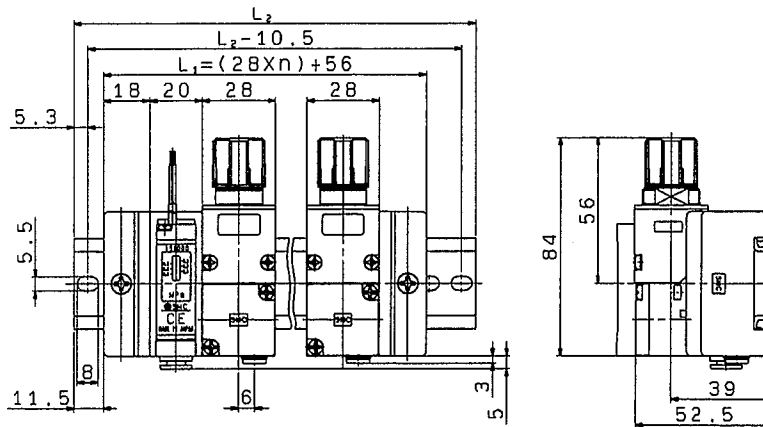

Stn.	Din rail no. (for side L,R)	L <sub>1</sub> Dimension
1	AXT100-DR-9	123
2	AXT100-DR-11	148
3	AXT100-DR-13	173
4	AXT100-DR-16	210.5
5	AXT100-DR-18	235.5
6	AXT100-DR-20	260.5
7	AXT100-DR-22	285.5
8	AXT100-DR-25	323
9	AXT100-DR-27	348
M	AXT100-DR-29	373



### ARM11AA1- \* 12-B

Handle position top spec/3 way valve type common supply block

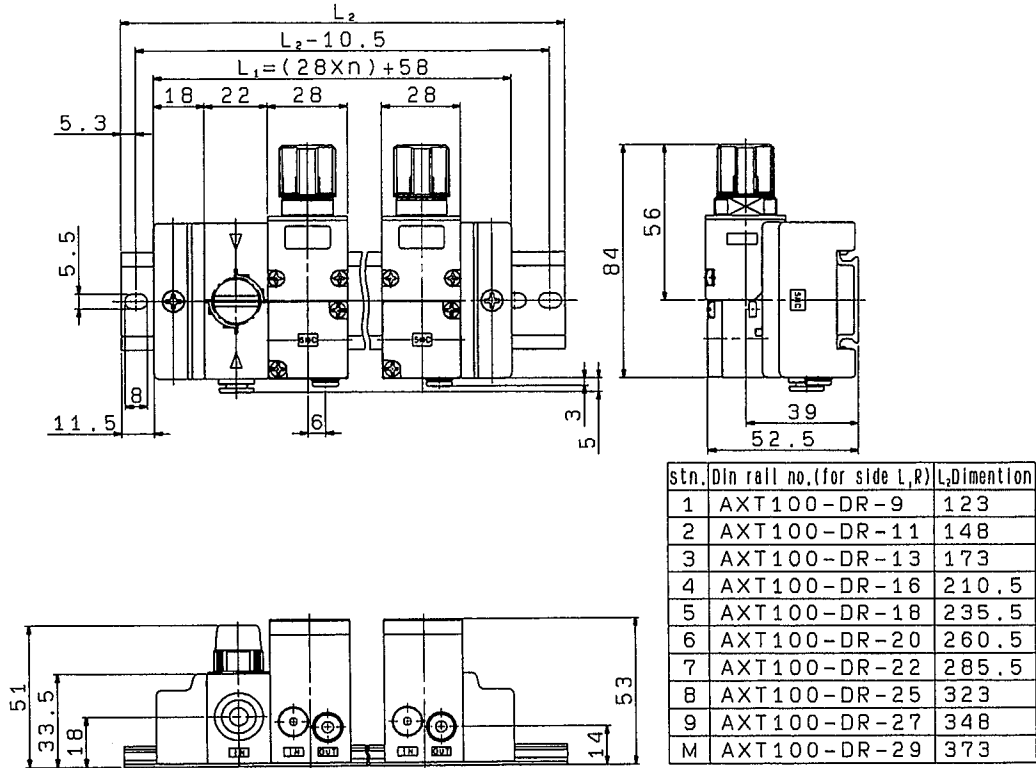

### ARM11AA1- \* 12-C

Handle position top spec/3 way valve type common supply block+pressure switch block

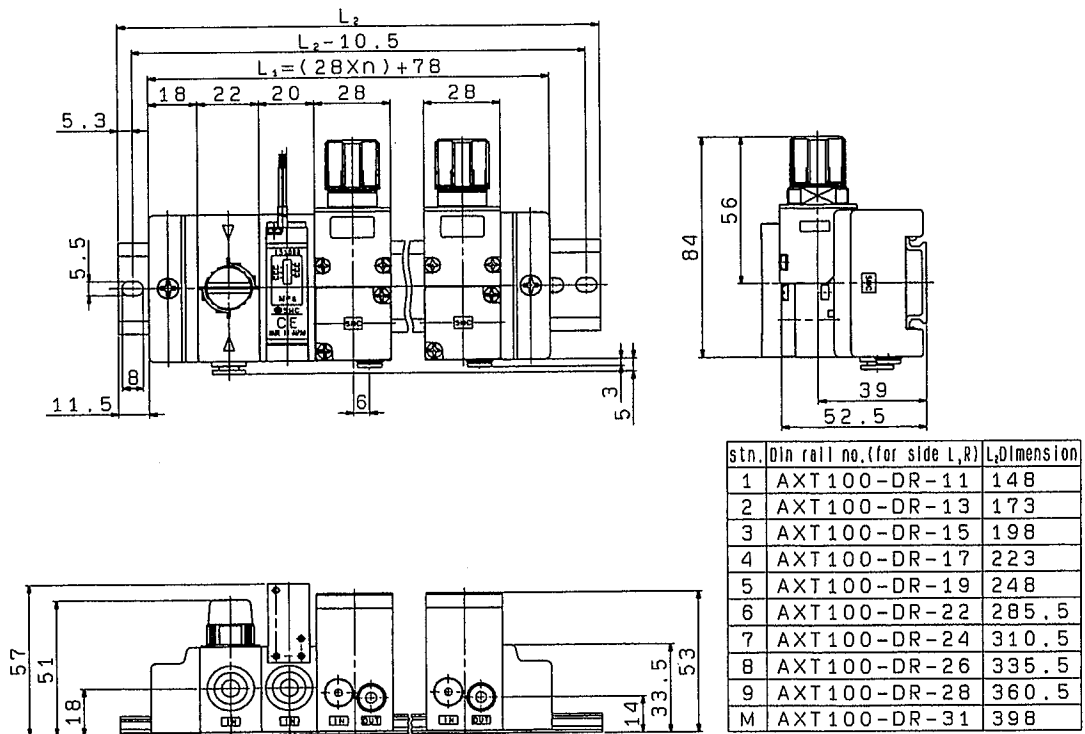

### ARM11AB1 - \* 12

Handle position front spec./common supply block

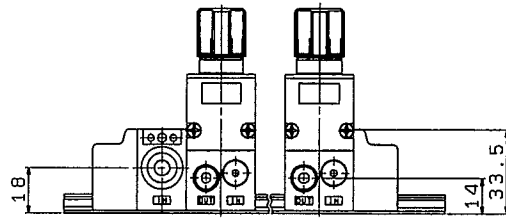
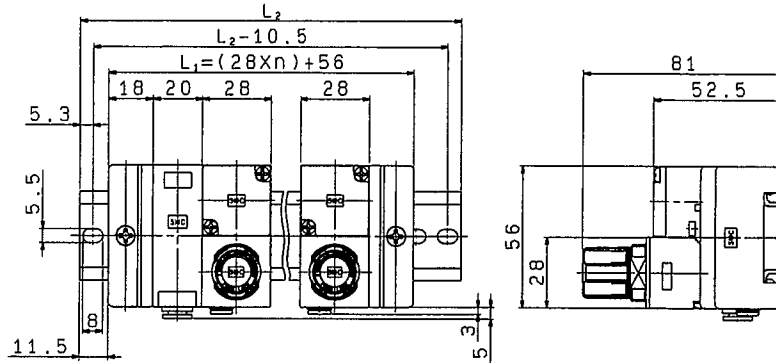

Stn.	Din rail no.	L <sub>2</sub> Dimension
1	AXT100-DR-9	123
2	AXT100-DR-11	148
3	AXT100-DR-13	173
4	AXT100-DR-16	210.5
5	AXT100-DR-18	235.5
6	AXT100-DR-20	260.5
7	AXT100-DR-22	285.5
8	AXT100-DR-25	323
9	AXT100-DR-27	348
M	AXT100-DR-29	373

### ARM11AB1 - \* 12-A

Handle position front spec./common supply with pressure switch

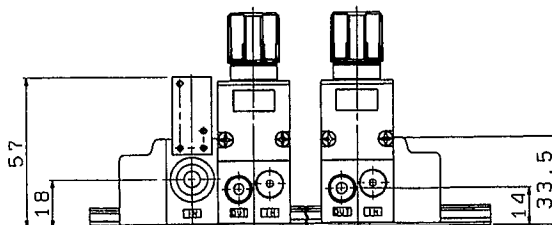
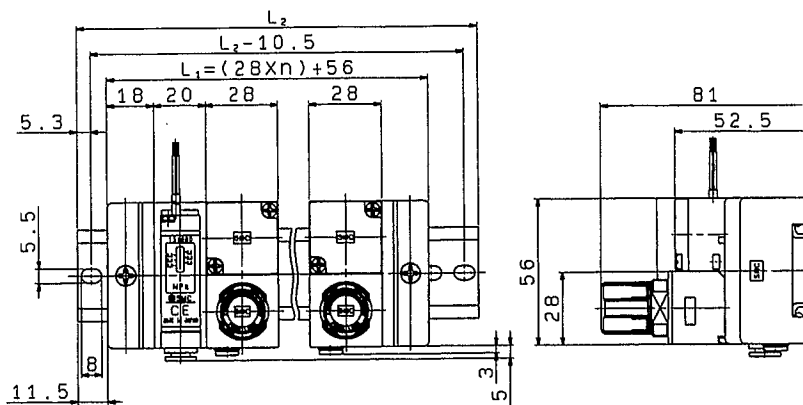

Stn.	Din rail no.	L <sub>2</sub> Dimension
1	AXT100-DR-9	123
2	AXT100-DR-11	148
3	AXT100-DR-13	173
4	AXT100-DR-16	210.5
5	AXT100-DR-18	235.5
6	AXT100-DR-20	260.5
7	AXT100-DR-22	285.5
8	AXT100-DR-25	323
9	AXT100-DR-27	348
M	AXT100-DR-29	373

### ARM11AB1- \* 12-B

Handle position front spec./3 way valve type common supply block

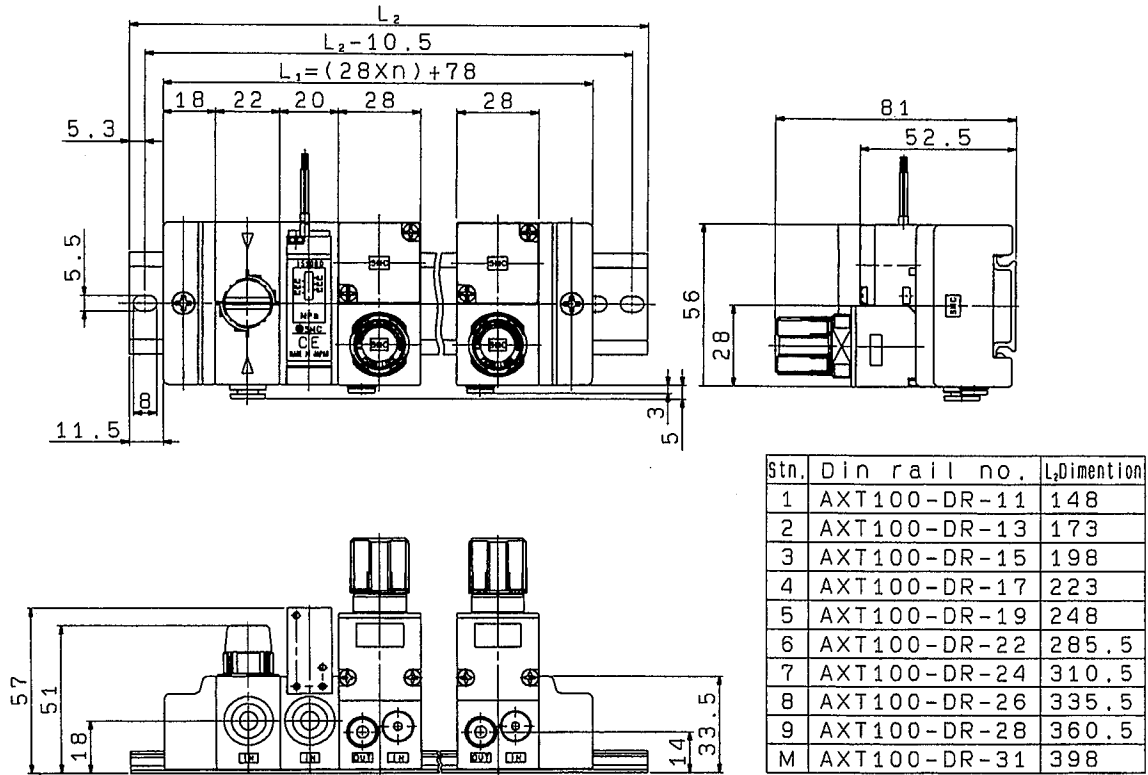

### ARM11AB1- \* 12-C

Handle position front spec./3 way valve type common supply block+pressure switch block

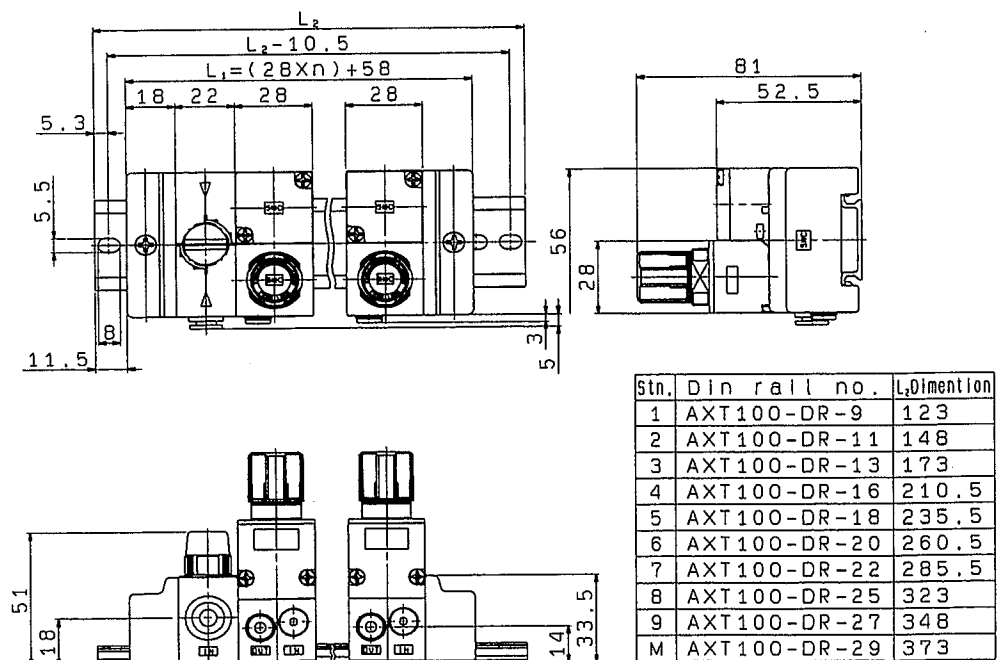

**ARM11AC2- \* 12**

Handle position bottom spec./common supply block

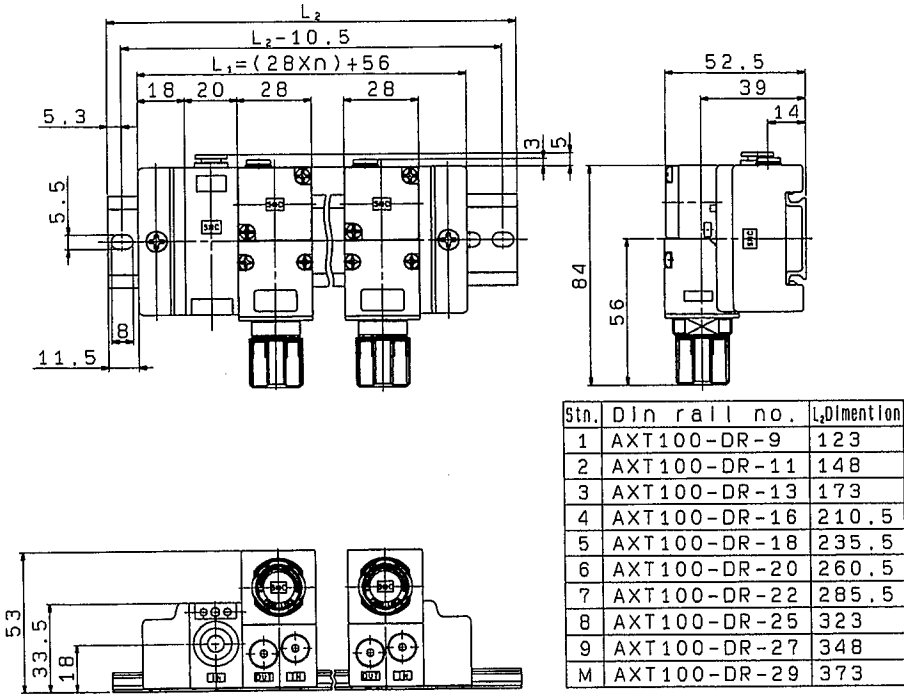

**ARM11AC2- \* 12-A**

Handle position bottom spec./common supply with pressure switch

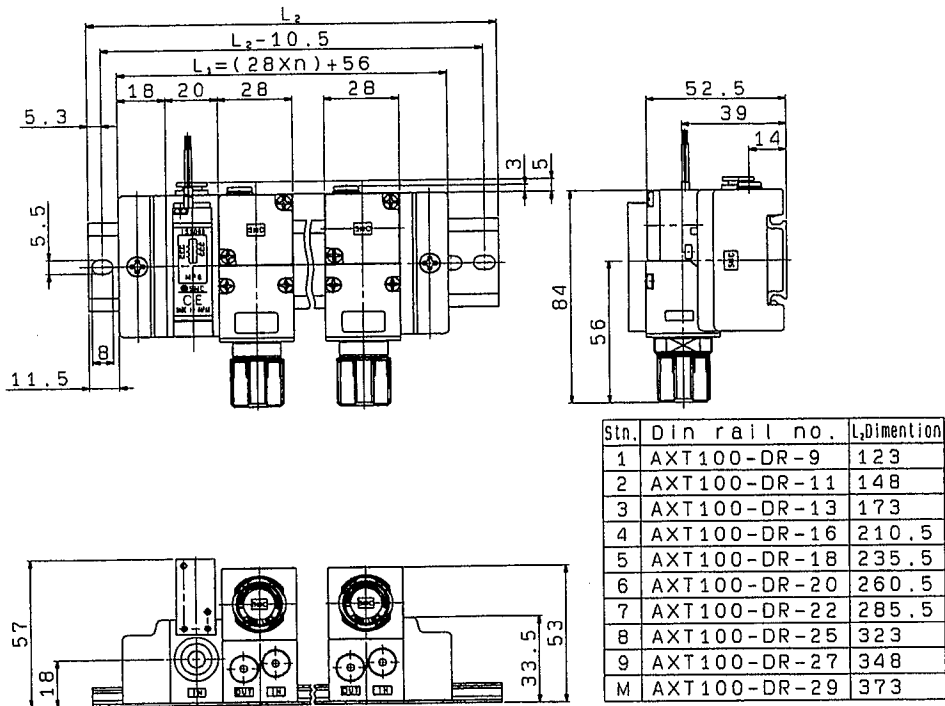

### ARM11AC2- \* 12-B

Handle position bottom spec./3 way valve type common supply block

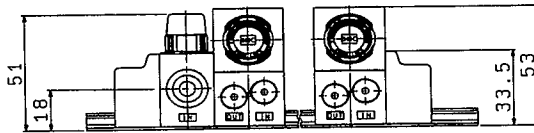
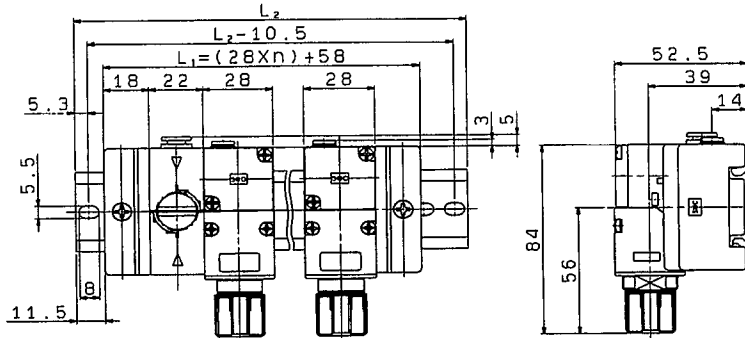

Stn.	Din rail no.	L <sub>2</sub> Dimension
1	AXT100-DR-9	123
2	AXT100-DR-11	148
3	AXT100-DR-13	173
4	AXT100-DR-16	210.5
5	AXT100-DR-18	235.5
6	AXT100-DR-20	260.5
7	AXT100-DR-22	285.5
8	AXT100-DR-25	323
9	AXT100-DR-27	348
M	AXT100-DR-29	373

### ARM11AC2- \* 12-C

Handle position bottom spec./3 way valve type common supply block+pressure switch block

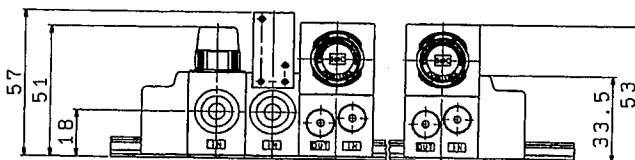
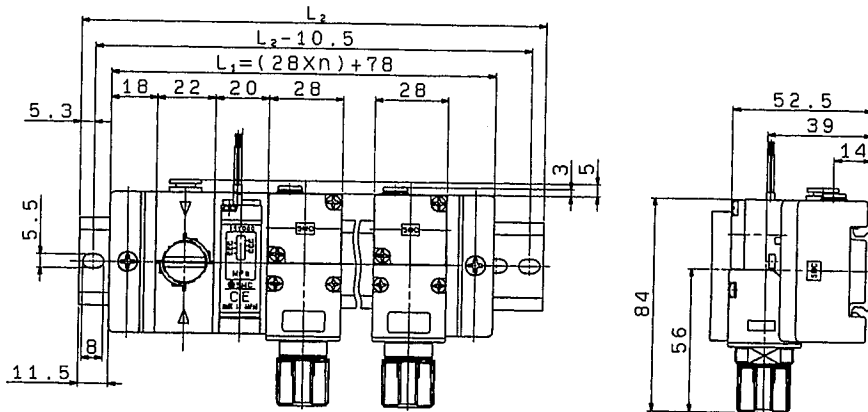

Stn.	Din rail no.	L <sub>2</sub> Dimension
1	AXT100-DR-11	148
2	AXT100-DR-13	173
3	AXT100-DR-15	198
4	AXT100-DR-17	223
5	AXT100-DR-19	248
6	AXT100-DR-22	285.5
7	AXT100-DR-24	310.5
8	AXT100-DR-26	335.5
9	AXT100-DR-28	360.5
M	AXT100-DR-31	398

③Manifold regulator / Individual air supply

ARM11BA1 — \* 08

Handle position top spec.

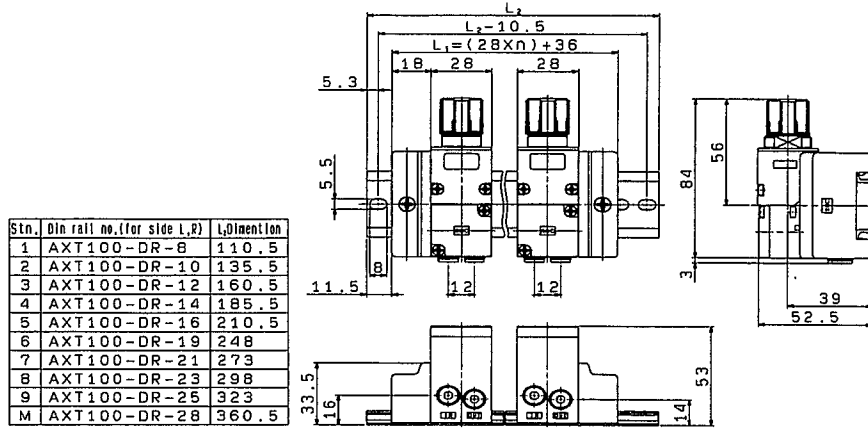

ARM11BB1 — \* 08

Handle position front spec.

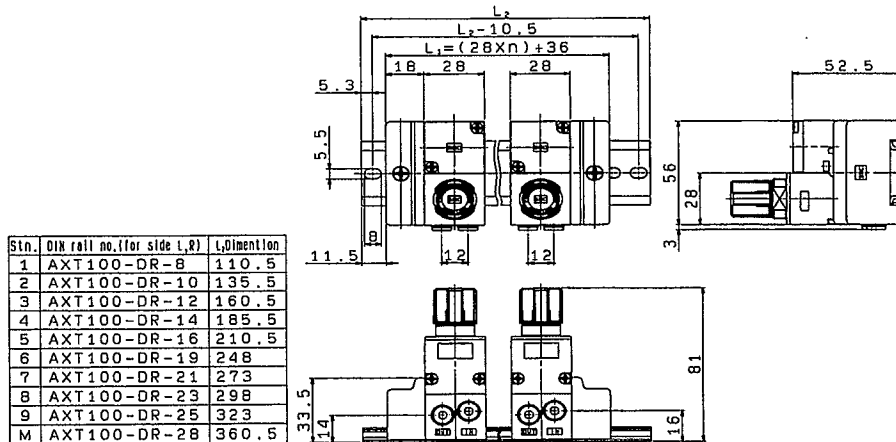

ARM11BC2 — \* 08

Handle position bottom spec.

