

# Circuit Breakers

Next Generation of Protection Capabilities



LISTEN.  
THINK.  
SOLVE.

# Circuit Breaker Offering

Rockwell Automation offers a full line of Allen-Bradley® circuit breakers and motor protection devices to help meet many of your application needs. With a current range up to 3000 A and a large variety of functions, these components are used in multiple industries – whether you are building panels or machines, in local installations or for the global market. From miniature circuit breakers to molded case circuit breakers and motor protection circuit breakers, they are accompanied by a full range of accessories and operating/mounting options to satisfy a range of installation needs.

## Global Availability

With a single global line of circuit breakers, you can standardize on one offering for all your circuit protection needs.

- Global offering including molded-case, motor protection, control circuit and load protection products.
- Shorter lead times with global logistics to support developing regions
- Enhanced support with advanced tools and configuration centers
- Extended range of products and line of accessories

## Standards and Certifications

To provide a global offering that will accommodate all industries in all regions, the circuit breaker protection products have been certified to a variety of standards.

- Molded case and motor protection products are UL and CE certified, including ground fault detectors
- All circuit breaker protection products are RoHS compliant – to help limit substances that may be harmful to the environment



Miniature Circuit Breakers



## Higher Short Circuit Current Ratings (SCCR)

- Increased short circuit protection – Standard Magnetic Trip (Fixed at 13...14 x I<sub>e</sub>) and High Magnetic Trip (Fixed at 16...21 x I<sub>e</sub>)
- Short circuit coordination is available for motors from 0.1 to 630 kW, fault currents up to 100 kA, and operational voltages up to 690V
- Higher interrupting ratings (i.e. up to a 150 kA)
- Greater customization in trip units for enhanced protection

## Ease of Selection and installation

Determine the necessary circuit protection for your application with easy to use selection and ordering tools.

- Wide range of accessories in stock for global availability
- A variety of mounting options including panel mounts, DIN Rail mounts and bus bar mounting system
- Simplified purchasing process and product availability with our distributor partners in more than 80 countries

## Molded Case Circuit Breakers



## Motor Circuit Protection

# Molded Case Circuit Breakers

With eight frame sizes with a range of 15 to 3000 A, Allen-Bradley molded case circuit breakers can accommodate your required current ratings and breaking capacities. With a wide range of operators and accessories, these circuit breakers provide the protection of circuits against overload, short circuit and ground fault.

This global portfolio features:

- Interrupting capacity from 25 to 150 kA allows a single unit to address many applications, thereby reducing the number of different products to be specified
- Electronic trip unit available from 25 to 3000 A
- Wide range of operating mechanisms to fit with a variety of panel configurations
- Short circuit current rating (SCCR) coordination with Allen-Bradley contactors, overload relays and motor starters



# Applying Short Circuit and Conductor Protection

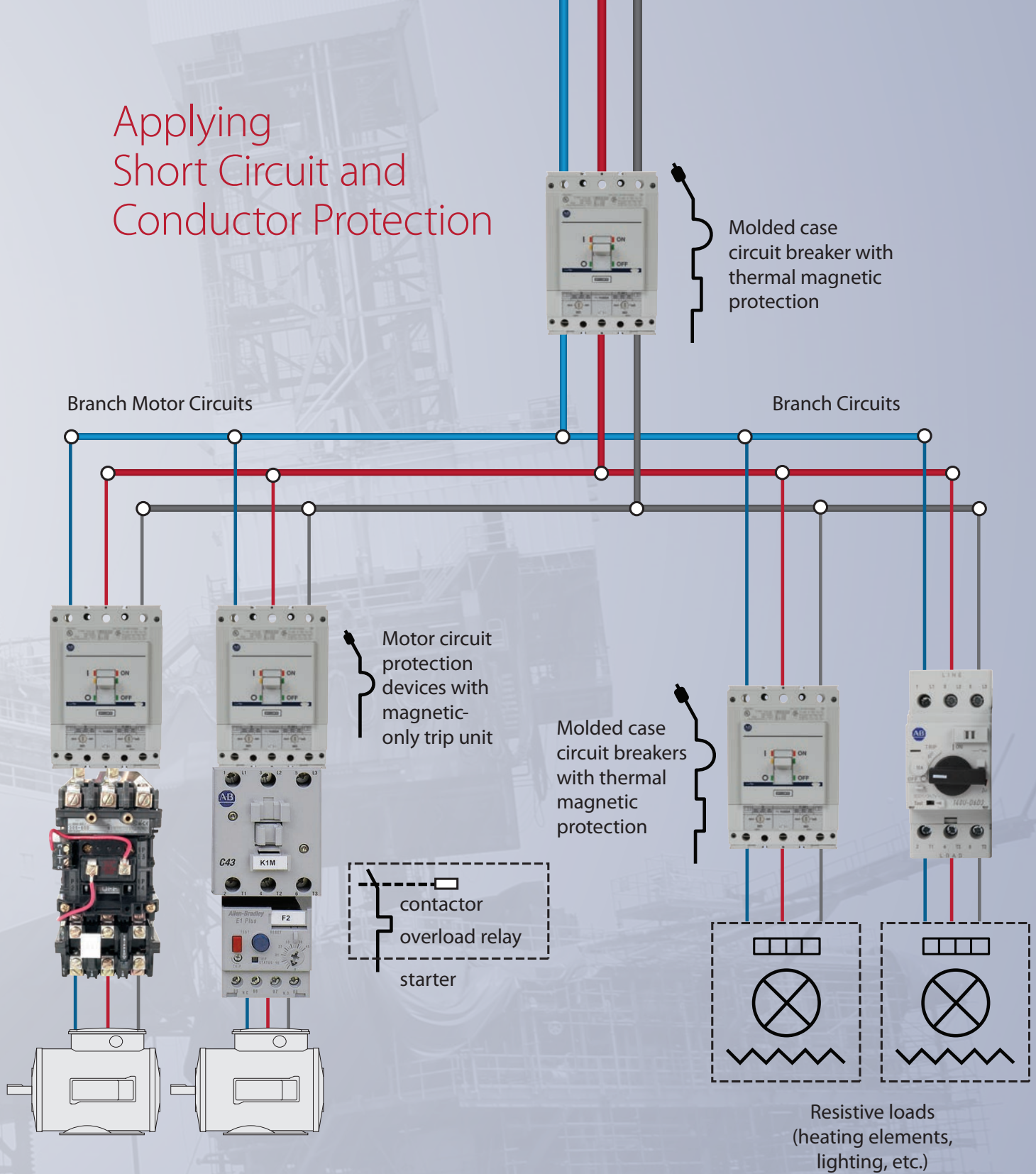

Motor circuit protection devices tested with combination starters or contactors to provide SCCR coordination to 65 kA.

See our *Global SCCR* website for more information:  
[www.rockwellautomation.com/support/global-sccr.page](http://www.rockwellautomation.com/support/global-sccr.page)

# Broad Selection of Accessories

## Termination Options

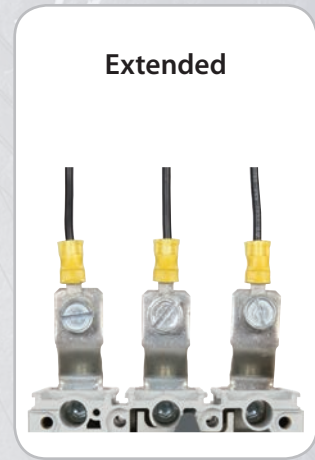

## Annunciate Options

Internal accessories are quickly and easily field installed by simply removing the front cover.



Shunt Trip/  
Undervoltage Relay

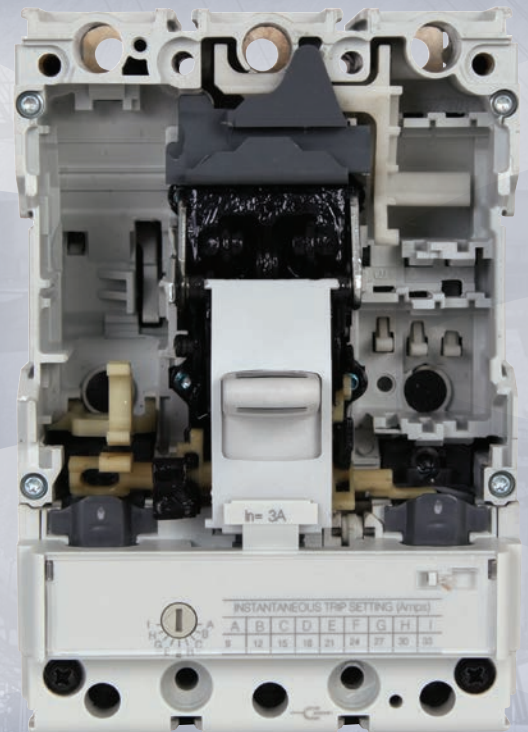

## Protection Options



Fixed Thermal/Magnetic

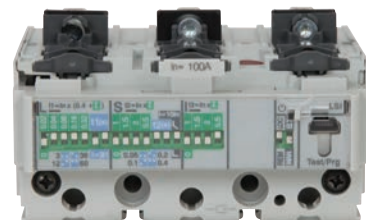

Adjustable Electronic  
Long Short Instantaneous (LSI) and  
Long Short Instantaneous Ground-Fault (LSIG)

# Ease of Installation

With multiple operator options, you can find the right installation for your application needs and safety requirements.



**Variable Depth Rotary Operator** – For global application of non-flanged enclosures.

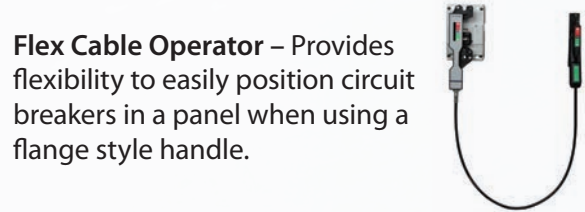

**Flex Cable Operator** – Provides flexibility to easily position circuit breakers in a panel when using a flange style handle.



**Motor Operators** – Allow for remote electrical operation of the MCCB.

**Direct Rotary Operators** – Through the door operation or control with the enclosure door open.



**NFPA Internal Operating Handle** – When using a variable depth operator allows for control of the MCCB with the enclosure door open without the use of tools.

**Variable Depth Flange Operating Mechanism** – Direct control for a flange style handle.



# Motor Circuit Protection

Allen-Bradley motor protection circuit breakers are available for a wide range of motor sizes and installation types. They can be combined with our NEMA and IEC motor starters, overload relays and contactors.

## Motor Circuit Protection up to 1200 A

### *Bulletin 140MG*



- Current range 3...1200 A Motor Circuit Protectors
- UL489 Listed/Recognized for motor loads
- Short-circuit only protection units available in 3...1200 A (overload protection must be provided separately)
- Combined short circuit and overload protection units available in 3...150 A
- Visible trip indication
- High current limiting
- High switching capacity
- Can be applied with NEMA and IEC contactors and overload relays
- Shares wide range of accessories with Bulletin 140G molded case circuit breakers

## Motor Circuit Protection up to 90 A – With or Without Overload Protection

### *Bulletin 140M – economical option for smaller-sized applications*



- Current range from 0.1...45 A
- Models up to 45 A are available with bimetallic overload protection for standard motor applications
- These models can also be used with Bulletin 100 contactors to create UL Type E or Type F combination starters
- Shunt and under voltage trip modules available
- Front mount auxiliary contacts require no additional panel space
- Compact bus bars simplify 3-phase wiring of multiple branch circuits
- Trip position: separate handle position indicates a trip has occurred
- Short circuit trip indication: identifies a short circuit trip, enabling operators to identify a fault quickly, reducing downtime

### *Bulletin 140-CMN*

- Current range from 16...90 A

The 140-CMN frame Motor Protection Circuit Breakers are UL Listed/CSA Certified as Manual Motor Controllers (with approvals for At Motor Disconnect and Group Installation).

In NEC/CEC Group Installations, these devices must be applied per the appropriate rules which require the use of an upstream Branch-Circuit, Short-Circuit Protective Device (BCPD).





# Applying Motor Protection Circuit Breakers

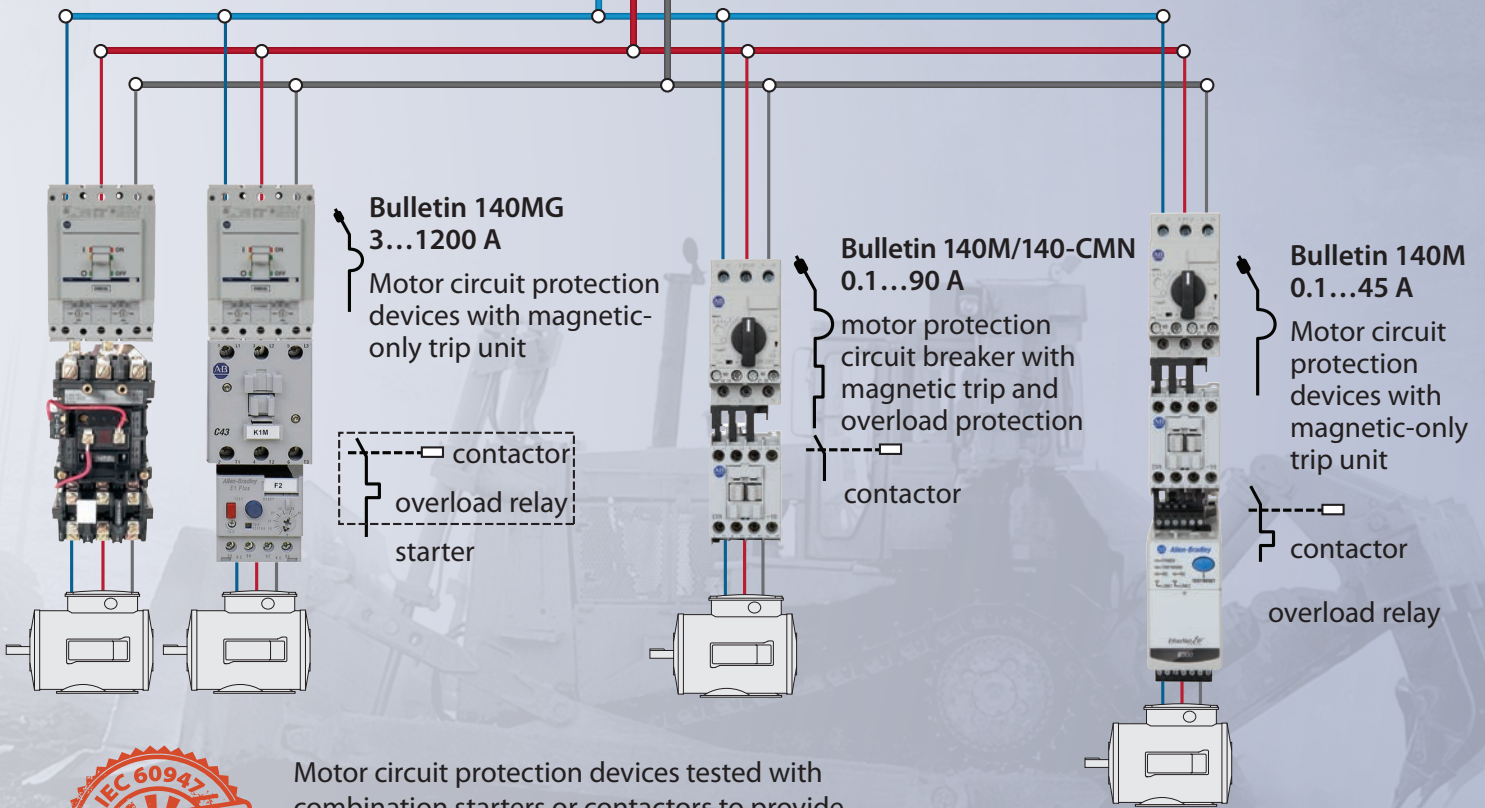
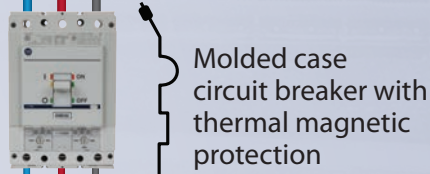

Motor circuit protection devices tested with combination starters or contactors to provide SCCR coordination to 65 kA.

See our Global SCCR website for more information:  
[www.rockwellautomation.com/support/global-sccr.page](http://www.rockwellautomation.com/support/global-sccr.page)

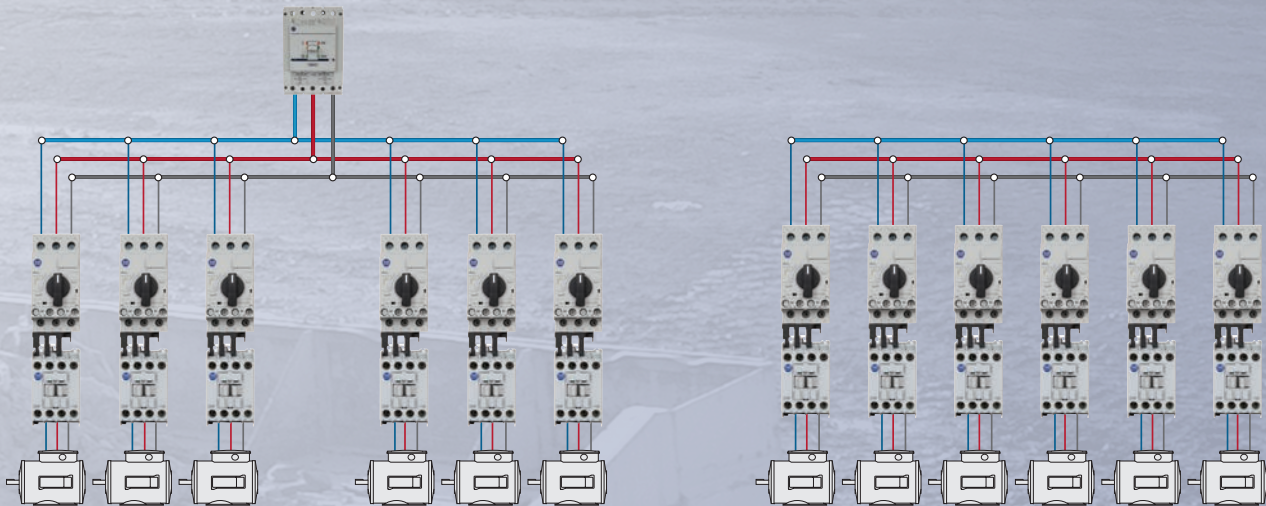

Approved for use in group motor applications in North America, it is possible to protect multiple motor branch circuits below a single short circuit protection device.

When used as a UL Type E combination motor controller, one can eliminate the need for separate, upstream short circuit protection device.

# Miniature Circuit Breakers for Control Circuit and Load Protection

The control circuit and load protection family has an updated and expanded portfolio to better fulfill your needs. The new offering of miniature circuit breakers is IP20 finger safe and RoHS compliant. These products also meet an expanded set of standards and certifications.



## Miniature Circuit Breakers

*UL 489 • CSA C22.2 No. 5.1 • EN 60947-2 • GB 14048.2*

*UL Listed • CSA • CE • CCC • VDE*

**Bulletin 1489-M** products are certified for branch circuit protection in the United States and Canada and as miniature circuit breakers for IEC applications.

- 0.5...63 A; 1, 2, 3 poles; C & D Trip Curves
- Current limiting
- Dual terminals for wiring and bus bar flexibility
- Suitable for extreme ambient conditions (-25...+55°C)

## Supplementary Protectors

*UL 1077 • CSA C22.2 No. 235 • EN 60947-2 • GB 14048.2*

*UL Recognized\* • CSA\* • CE • CCC • VDE (\* 1, 2 and 3 poles only)*

**Bulletin 1492-SP** products are supplemental protectors/miniature circuit breakers for equipment protection in applications.

- 0.5...63 A; 1(+N), 2, 3(+N) poles; B, C & D Trip Curves
- Current limiting
- Dual terminals for wiring and bus bar flexibility
- 40°C calibration temperature suitable for extreme ambient conditions (-25...+55°C)
- Wide range of accessories, including a bottom mounted auxiliary requiring no additional DIN rail space



## Regional Circuit Breakers

*EN 60898-1 • GB 10963*

*CE • CCC • VDE*

**Bulletin 188-J** circuit breakers are for application at the equipment level. These products have regional certifications only and are available in China, Singapore and Europe.

- 0.5...63 A; 1(+N), 2, 3(+N), 4 poles; B, C & D Trip Curves
- Current limiting
- Reversible line and load connections
- Suitable for extreme ambient conditions (-25...+55°C)



## Residual Current Devices

UL 1053 • ANSI/NFPA 70 • EN 61008 • CSA C22.2 No. 144 • GB 16196  
cURus Recognized • CE • CCC • VDE



**Bulletin 1492-RCD** products detect and interrupt leakage to ground, preventing injury to exposed personnel and damage to equipment. RCDs are used in series with miniature circuit breakers for additional circuit protection from not only overload and short circuit, but also ground fault.

- 25...80 A; 2, 4 poles
- 30 mA sensitivity devices for personnel protection (consult local requirements)
- 100, 300 and 500 mA sensitivity devices for equipment protection
- Reversible line and load connections

## High-density Supplementary Protectors

UL 1077 • CSA C22.2 No. 235 • EN 60934  
UL Recognized • CE • CSA



**Bulletin 1492-GH and 1492-GS** supplementary protectors have a high density design useful when panel space is at a premium.

- 0.2...25 A; 1, 2, 3 poles
- Compact design allows for 24 1-pole breakers per foot
- Low current ratings and numerous rated currents for precise circuit requirements
- Suitable for AC and DC applications
- Optional integrated N.O. contact for 1492-GS

## Accessories

	1489-M	1492-SP	188-J	1492-RCD	1492-G
Right Mount	✓	✓	✓	✓	
Left Mount		✓	✓		
Bottom Mount		✓	✓		
Toggle Mount Lock Out Attachment	✓	✓	✓		
N.O. Contact		✓	✓	✓	*
N.C. Contact		✓	✓	✓	
N.O./N.C. Contact	✓	✓	✓	✓	
Signal Contact	✓	✓	✓	✓	
Shunt Trip	✓	✓	✓		

\* Contact is integral to circuit breaker

Note: For inventory and installation flexibility, universal accessories common to 1492-SP, 188-J and 1492-RCD are available.

## Applying Miniature Circuit Breakers

Miniature Circuit Breakers can provide equipment protection for a wide variety of loads. Shown here are a few examples.

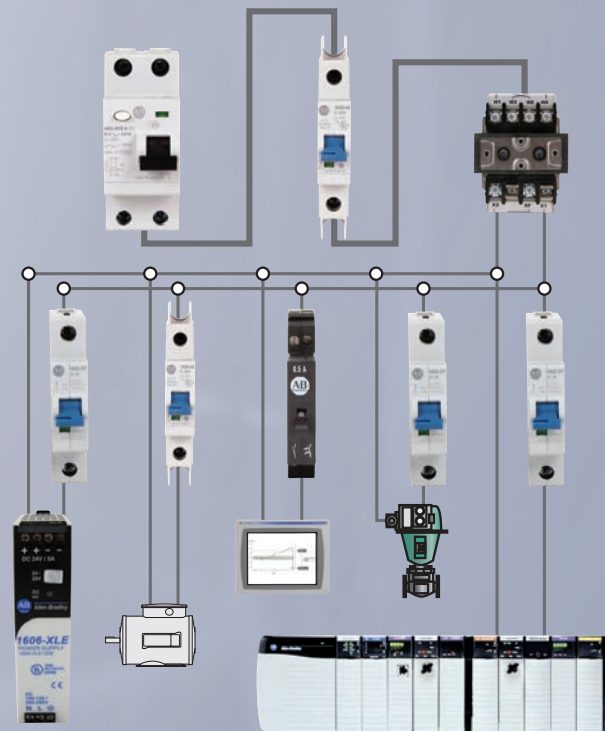

# Selection and Application Tools

Circuit breakers from Rockwell Automation provide a range of tools to help you understand and apply these products in your application. You can access these tools online or through your local distributor.

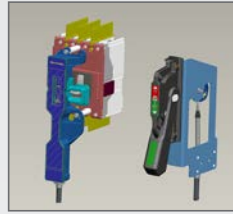

CAD drawings in a range of formats

Selection guides and technical documentation

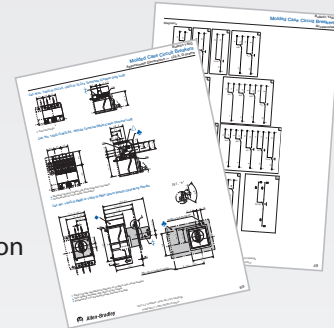

## Local Distributor

Visit our website to find your local Distributor.  
[www.rockwellautomation.com/distributor](http://www.rockwellautomation.com/distributor)



## On-Line Product Directory

Our extensive product portfolio is designed to improve your processes through every stage of your manufacturing cycle.  
<http://http://ab.rockwellautomation.com/Circuit-and-Load-Protection/Circuit-Breakers>



## Product Selection Toolbox

Our powerful range of product selection and system configuration tools assist you in choosing and applying our products.  
[www.rockwellautomation.com/en/e-tools](http://www.rockwellautomation.com/en/e-tools)



Rockwell Automation, Inc. (NYSE:ROK), the world's largest company dedicated to industrial automation, makes its customers more productive and the world more sustainable. Throughout the world, our flagship Allen-Bradley® and Rockwell Software® product brands are recognized for innovation and excellence.

Follow ROKAutomation on Twitter.    Connect with us on Facebook and LinkedIn.

Allen-Bradley, LISTEN. THINK. SOLVE. and Rockwell Software are trademarks of Rockwell Automation, Inc. Trademarks not belonging to Rockwell Automation are property of their respective companies.

[www.rockwellautomation.com](http://www.rockwellautomation.com)

### Power, Control and Information Solutions Headquarters

Americas: Rockwell Automation, 1201 South Second Street, Milwaukee, WI 53204-2496 USA, Tel: (1) 414.382.2000, Fax: (1) 414.382.4444

Europe/Middle East/Africa: Rockwell Automation NV, Pegasus Park, De Kleetlaan 12a, 1831 Diegem, Belgium, Tel: (32) 2 663 0600, Fax: (32) 2 663 0640

Asia Pacific: Rockwell Automation, Level 14, Core F, Cyberport 3, 100 Cyberport Road, Hong Kong, Tel: (852) 2887 4788, Fax: (852) 2508 1846