

# PlantPax Distributed Control System

System Release 4.0



LISTEN.  
THINK.  
SOLVE.®

# PlantPAX System Scope

The PlantPAX® system provides a modern approach to distributed control. The system shares common technology (Integrated Architecture® system) with all other automation disciplines in the plant. This approach creates a seamless information flow across the plant for optimization opportunities and enables a connected enterprise.

Our scalable platform provides you with the flexibility to implement a system appropriate for your application. [Figure 1](#) shows the documents (this manual in the highlighted section) that are available to help design and implement your system requirements.

**Figure 1 -- PlantPAX System Implementation and Documentation Strategy**

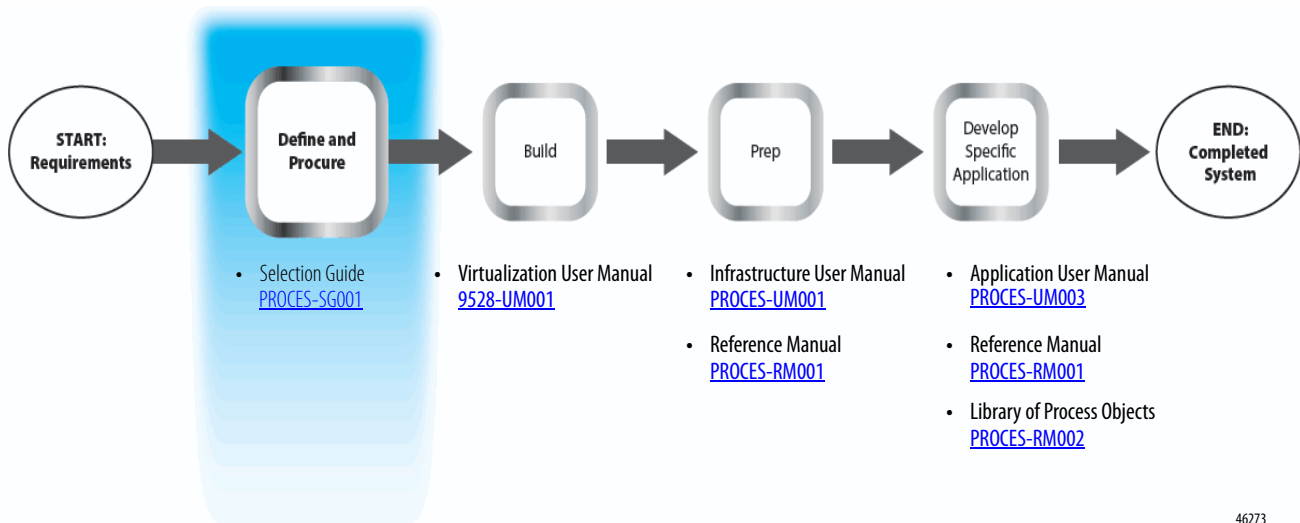

- **Define and Procure** - Helps you understand the elements of the PlantPAX system to make sure you buy the proper components.
- **Build** - Provides direction on how to implement the PlantPAX system architecture to help develop your application.
- **Prep** - Provides guidance on how to get started and learn the best practices for developing your application.
- **Develop Specific Application** - Contains the application-specific libraries and objects that are used to construct your application that resides on the PlantPAX architecture.

## Purpose of Selection Guide

This PlantPAX Selection Guide is designed to step you through the selection of system elements for creating a bill of materials for ordering your system. Using the prescribed architecture and recommendations explained in this manual, you can use the PlantPAX System Estimator tool to select a PlantPAX system. The PlantPAX System Estimator tool is part of the Integrated Architecture Builder software. See [page 12](#) for details.

You do not need to read the sections in the order outlined on [page 3](#). However, we do recommend that you start with the Overview to acquaint yourself with the system elements and architecture that comprise the PlantPAX system.

# Select a PlantPax System

## Overview

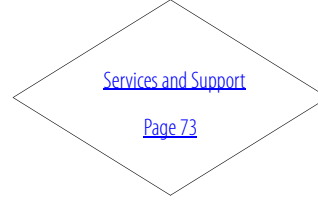
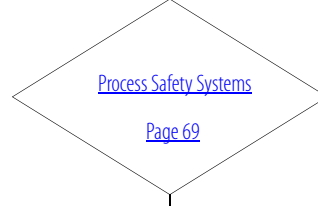
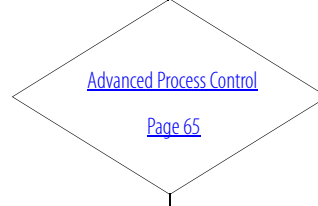
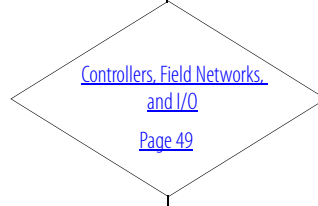
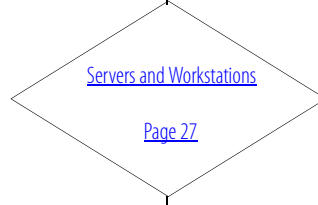
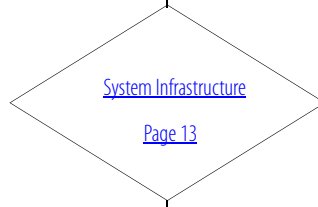
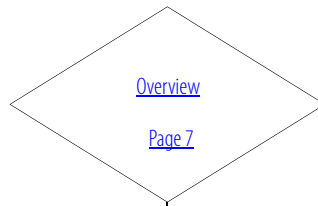
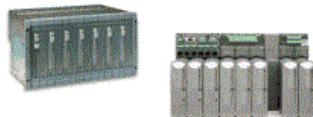
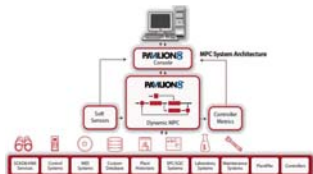
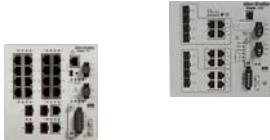
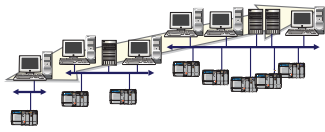

Review:

- Process system elements
- Scalable architectures
- High Availability architectures
- PlantPax System Estimator
- Software release information

Select:

- Traditional infrastructure
- Virtual infrastructure
- VMware component requirements
- Network topologies
- Ethernet switches

Select:

- PASS server
- Engineering workstation
- Operator workstation
- Independent workstation
- Application servers
- Domain controller

Select:

- Simplex controllers
- Redundant controllers
- Skid-based controllers
- I/O products
- Process network I/O
- Field devices

Select:

- Regulatory control options
- Supervisory control options
- PlantPax MPC

Select:

- ControlLogix SIL 2 systems
- AADvance and Trusted SIL 2, SIL 3, and TMR systems
- SIL-rated instruments
- PowerFlex SIL 2 and SIL 3 Systems
- OptiSIS Safety Integrated Systems

Select:

- Access to Remote Service Engineers
- On-site delivery of replacement parts
- Emergency on-site engineering services

## What's Inside

This revision of the PlantPAx Selection Guide updates system rules to support the latest characterized software versions and incorporates additional information on the following topics.

Topic	Description	Pages
References to new PlantPAx user manuals in Additional Resources	Added Infrastructure and Application Configuration user manuals.	4
'Scalable' and 'High Available' architectures in Overview section	Redesigned graphic includes the new Stratix™ 54x0 managed switches.	8, 10
IDC catalog numbers added to Virtual infrastructure	IDC table is packaged with VMware component requirements that have been moved forward with virtual information.	14, 16
New network topology graphics added	Graphics define network attributes within PlantPAx system map.	17, 18, 19, 20, 21
Ethernet managed switch catalog numbers added	Expanded switch section includes Stratix switches recommended for PlantPAx system.	23
Domain controller information moved to server section	Added virtual and traditional requirements for domain controllers.	46
Controller section is merged with field networks and I/O	Plant control equipment is packaged for your order convenience.	49
CompactLogix™ controller is added	CompactLogix 1769-L36ERM is among the skid-based solutions.	52
PlantPAx MPC information is added	Racked-based option promotes advanced process control.	67
New SIL table and OptiSIS® system are added	Process safety features offer cost-effective solutions.	69, 72
New Services and Support section is added	Available support services to keep your plant operational.	73

## Additional Resources

These documents contain additional information concerning related products from Rockwell Automation.

**Table 1 - Additional Resources**

Resource	Description
<b>System Core</b>	
PlantPAx Distributed Control System Infrastructure Configuration User Manual, publication <a href="#">PROCES-UM001</a>	Provides procedures to configure infrastructure components for your PlantPAx DCS systems.
PlantPAx Distributed Control System Application Configuration User Manual, publication <a href="#">PROCES-UM003</a>	Provides procedures to start the development of your PlantPAx DCS system.
PlantPAx Distributed Control System Reference Manual, publication <a href="#">PROCES-RM001</a>	Provides characterized recommendations for implementing your PlantPAx system.
PlantPAx Hardware Specifications and Certifications, publication <a href="#">PROCES-SR027</a>	Provides information on PlantPAx system hardware specifications and certifications.
ControlLogix System User Manual, publication <a href="#">1756-UM001</a>	Explains how to use traditional and extreme environment ControlLogix® controllers.
ControlLogix Selection Guide, publication <a href="#">1756-SG001</a>	Explains how to select a ControlLogix system that is based on your application requirements.
CompactLogix Selection Guide, publication <a href="#">1769-SG001</a>	Explains how to select a CompactLogix system that is based on your application needs.
Process Automation System Training Curriculum, publication <a href="#">PROCES-CA001A-EN-P</a>	Describes the courses that are available for a better understanding of the PlantPAx system.
Redundant I/O System User Manual, publication <a href="#">1715-UM001</a>	Explains how to install and set up the 1715 Redundant I/O system.
<a href="http://www.rockwellautomation.com/solutions/process">http://www.rockwellautomation.com/solutions/process</a>	Provides general information about Rockwell Automation process capabilities. From the left-hand menu on the home page, select DCS Migration Solutions for information on the DCS migration program.
<a href="http://www.migratemyprocess.com/webinars">http://www.migratemyprocess.com/webinars</a>	Features prerecorded webinars on the DCS migration program and capabilities for process customers.

**Table 1 - Additional Resources**

Resource	Description
<b>Infrastructure</b>	
PlantPax Virtualization User Manual, publication <a href="#">9528-UM001</a>	Describes the catalog numbers and details for using virtual image templates to configure virtual machines.
Ethernet Design Considerations Reference Manual, publication <a href="#">ENET-RM002</a>	Explains the infrastructure components that allow this open network to communicate seamlessly throughout a plant, from shop floor to top floor.
Industrial Ethernet Media, Complete Solution for Ethernet Networks and Integrated Architecture, publication <a href="#">1585-BR001</a>	Provides information on Rockwell Automation 1585 Ethernet cables.
Stratix Ethernet Device Specifications Technical Data, publication <a href="#">1783-TD001</a>	Contains product specifications, certifications, and catalog numbers for Ethernet switch devices.
Converged Plantwide Ethernet (CPwE) Design and Implementation Guide, publication <a href="#">ENET-ID001</a>	Provides information on Ethernet security and firewalls.
Product Compatibility and Download Center at <a href="http://www.rockwellautomation.com/rockwellautomation/support/pcdc.page">http://www.rockwellautomation.com/rockwellautomation/support/pcdc.page</a>	Website helps you find product-related downloads including firmware, release notes, associated software, drivers, tools, and utilities.
<b>Field Device Integration</b>	
FLEX™ I/O and FLEX Ex™ Selection Guide, publication <a href="#">1794-SG002</a>	Explains how to select a distributed I/O system for safe and hazardous environments.
POINT I/O™ Selection Guide, publication <a href="#">1734-SG001</a>	Explains how to select modular I/O modules for your system requirements.
ArmorBlock® I/O Selection Guide, publication <a href="#">1732-SG001</a>	Explains how to select ArmorBlock® I/O blocks that are suitable for On-Machine™ use.
ArmorPOINT® I/O selection Guide, publication <a href="#">1738-SG001</a>	Explains how to select ArmorPOINT® I/O modules.
Dynamix™ -1444 Series Monitoring System User Manual, publication <a href="#">1444-UM001</a>	Explains how to install and wire the Dynamix 1444 Series Monitoring System.
<a href="http://www.endress.com/eh/home.nsf/#products/~products-instruments">http://www.endress.com/eh/home.nsf/#products/~products-instruments</a>	List of instruments from Endress+Hauser.
E+H Instruments via HART to PlantPAX User Manual, publication <a href="#">PROCES-UM002</a>	Provides a step-by-step approach how to integrate Endress+Hauser devices into a Rockwell Automation Integrated Architecture for Process Control system.
Region Locations for Panduit Corporation, <a href="#">Product category</a>	Provides information on connected cabling systems and infrastructure management from Encompass™ partner Panduit Corporation.
<b>Process Safety</b>	
<a href="http://www.rockwellautomation.com/products/certification">http://www.rockwellautomation.com/products/certification</a>	Complete list of ControlLogix products that are certified for SIL 1 and SIL 2 applications.
Using ControlLogix in SIL2 Applications Safety Reference Manual, publication <a href="#">1756-RM001</a>	ControlLogix components that are supported in SIL 2 configurations.
AADvance® Solutions Handbook, publication <a href="#">ICSTI-RM447</a>	Explains the features, performance, and functionality of the AADvance controller and systems. It sets out some guidelines on how to specify a system to meet your application requirements.
AADvance System Build Manual, publication <a href="#">ICSTI-RM448</a>	Provides experienced panel builders with information on how to assemble a system, switch on and validate the operation of a controller.
AADvance Configuration Guide, publication <a href="#">ICSTI-RM405</a>	Defines how to configure an AADvance controller by using the AADvance Workbench to meet your Safety Instrument Function (SIF) application requirements.
AADvance Safety Manual, publication <a href="#">ICSTI-RM446</a>	Defines mandatory standards and makes recommendations to apply AADvance controllers for a SIF application. Explains how to use ControlLogix controllers.
AADvance Troubleshooting and Repair Manual, publication <a href="#">ICSTI-RM406</a>	Provides plant maintenance personnel with information on how to trace and repair a fault in an AADvance system and perform routine maintenance tasks.

You can view or download publications at <http://www.rockwellautomation.com/literature>. To order paper copies of technical documentation, contact your local Allen-Bradley distributor or Rockwell Automation sales representative.

Notes:

# Overview

Welcome and thank you for choosing the PlantPAx Distributed Control System. The PlantPAx system is an integrated control and information solution that provides plant-wide optimization in a wide range of industries. This single-platform system is built on open industry standards to help support the seamless integration of system components, and to provide connectivity to high level business systems.

Review these options:

- [Process System Elements](#)
- [Scalable Architectures](#)
- [High Availability Architectures](#)
- [PlantPAx System Estimator](#)
- [Software Release Information](#)

This section provides an overview on the system elements and architectures that comprise the PlantPAx system.

## Process System Elements

To get started building your system, [Table 2](#) summarizes the system elements. These elements (combinations of hardware and software products) are explained throughout this guide with corresponding catalog numbers to assist you with your equipment procurement.

**Table 2 - System Element Descriptions**

System Element	Description
Process Automation System Server (PASS)	The PASS is a required system element that can host displays, alarms, and data connections to controllers. Multiple PASS servers can be used to provide additional system capacity or to create logical segregation of application content that is based on the process. See <a href="#">page 28</a> for guidance on how many PASS servers you need.
Operator workstation (OWS) and Application server (AppServ-OWS)	The OWS and AppServ OWS provides an interactive graphical interface to monitor and control the process. The AppServ-OWS uses Microsoft® Remote Desktop Services (RDS) technology to serve multiple instances of the OWS as thin clients from a single server. The technology provides for FactoryTalk® View SE thin clients running applications and processing data on a remote computer.
Engineering workstation (EWS) and Application server (AppServ-EWS)	The EWS and AppServ-EWS provides a central location for configuring the system and monitoring/maintaining system operation. The AppServ-EWS uses Microsoft Remote Desktop Services (RDS) technology to serve multiple instances of the EWS as thin clients from a single server. The technology provides for FactoryTalk View SE thin clients running applications and processing data on a remote computer.
AppServ-Asset management	The asset management server acts as a centralized tool for managing automation-related asset information (both Rockwell Automation and third-party assets). The asset management application server includes capabilities for source control, audits, change notifications, calibration of instrumentation, reporting, and security.
AppServ-Batch	The batch application server provides comprehensive batch management, including unit supervision, recipe management, process management, and material management. The batch application server can be linked with visualization elements on the OWS and configuration clients on the EWS.
AppServ-Info (Historian, VantagePoint, SQL)	Data management storage can include a Historian or SQL server. There are three different types of AppServ-Info servers depending on the function that is being provided: FactoryTalk® Historian software, FactoryTalk® VantagePoint® software, and the SQL server.
Process controller	The ControlLogix and CompactLogix controllers support continuous process and batch applications. These controllers also support discrete and motion applications.
Independent workstation (IndWS)	The independent workstation acts as a PASS, EWS, and OWS for single-station systems (independent class).
Domain controller	A domain controller is a server that manages security authentication requests within the Windows® server domain. PlantPAx uses a domain controller to store user account information, authenticate users, and enforce security policies.

## Scalable Architectures

Rockwell Automation characterizes the PlantPAx system that is based on its size or architecture class. A 'characterized' (system- tested) classification yields system performance data and recommended hardware and software configurations. The classes of PlantPAx architecture offer system scalability while organizing Integrated Architecture products consistent with process industry expectations.

The architecture classes that are shown in the illustration include the following:

- System architecture with single station that acts as PASS, OWS, and EWS
- Distributed system architecture for single server with multiple OWS and EWS
- Distributed system architecture for multiple servers and multiple OWS and EWS

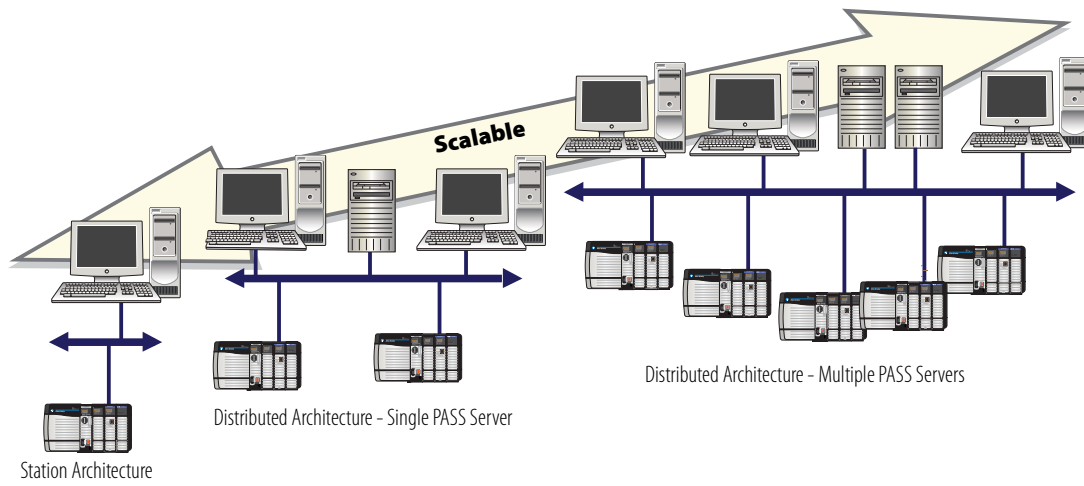

Use these system elements in your process architecture.

**Table 3 - Architectures and System Elements**

System Element	Station Architecture	Distributed Architecture
PASS	Single computer serves as PASS, EWS, and OWS in an independent workstation	One PASS required and includes the following: <ul style="list-style-type: none"> <li>• FactoryTalk Directory server</li> <li>• HMI server</li> <li>• Data server</li> <li>• Alarm and Event server</li> </ul> Additional PASS as needed (up to 10 servers or redundant server pairs)
EWS	Included in independent workstation	<ul style="list-style-type: none"> <li>• 1 EWS required</li> <li>• Can have as many as 5 EWSs</li> </ul>
OWS	Included in independent workstation	Can have as many as 50 OWS clients <sup>(1)</sup>
Process controller	1...5 ControlLogix controllers	There is no hard limit to the number of controllers. The number of controllers that can be supported per PASS (data server) depends on controller selection, controller loading, and number of OWS.
Application servers	AppServ-Asset Management as needed AppServ-Batch as needed AppServ-Information Management (SQL, Historian, or VantagePoint) as needed	AppServ-Asset Management as needed AppServ-Batch as needed AppServ-Information Management (SQL, Historian, or VantagePoint) as needed AppServ-OWS as needed

(1) Use the PlantPAx System Estimator to make sure that you have PASS server capacity to support all of your OWS clients.



## PlantPax System on an EtherNet/IP Network

The PlantPax system is built on open industry standards, leveraging the EtherNet/IP™ network as its backbone. The EtherNet/IP network helps support seamless integration of the system components, as well as to provide connectivity to higher-level business systems. The PlantPax system supports the EtherNet/IP and ControlNet™ networks for device-level communication to deliver a business solution with real-time results from the plant floor to the top floor.

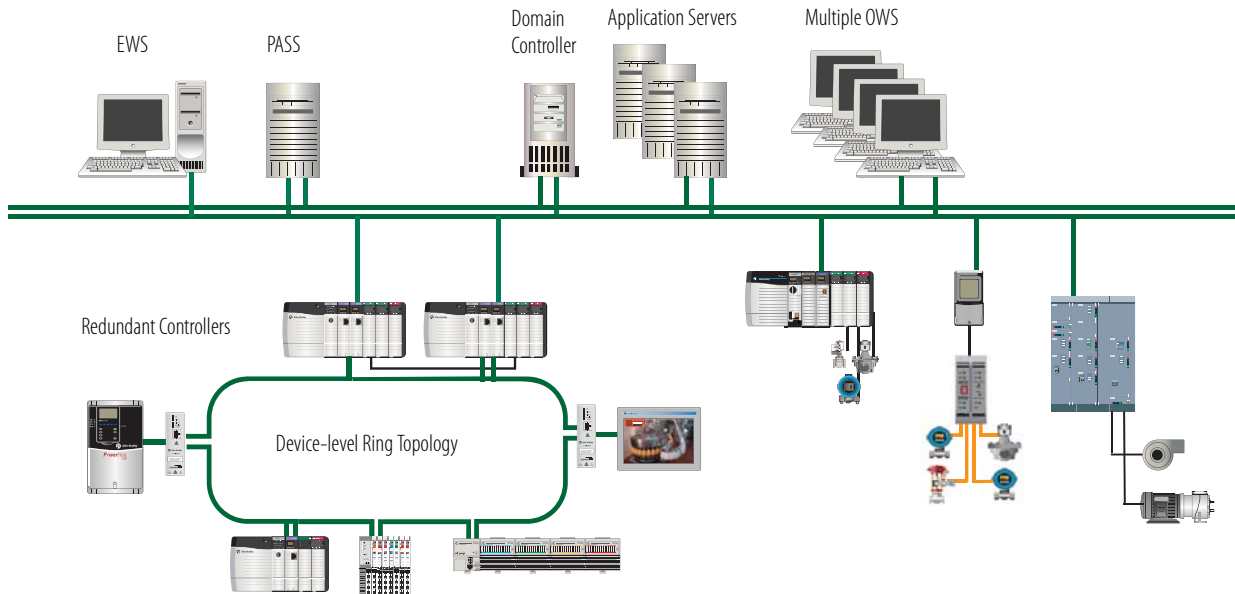

## PlantPax System on a ControlNet Network

This diagram shows an example of the PlantPax system architecture that uses the EtherNet/IP network for supervisory control and I/O and controller communication on the ControlNet network. The example is a distributed class for single or multiple PASS servers.

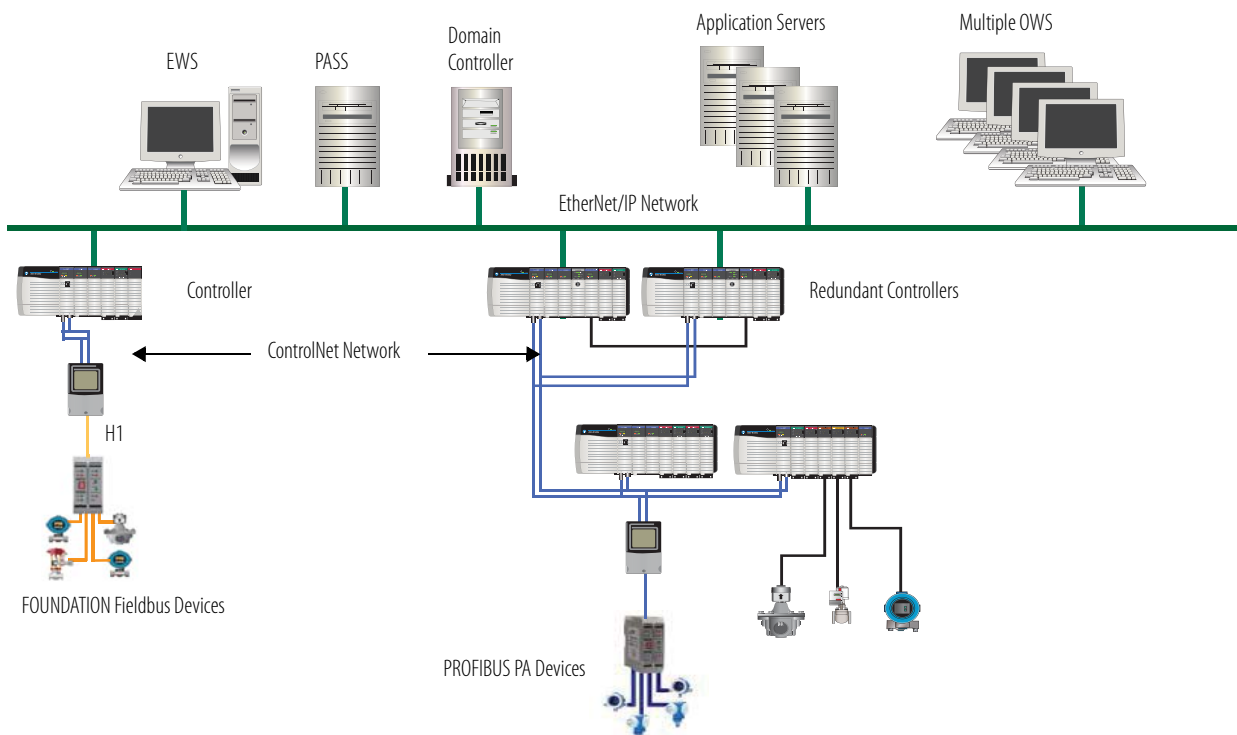



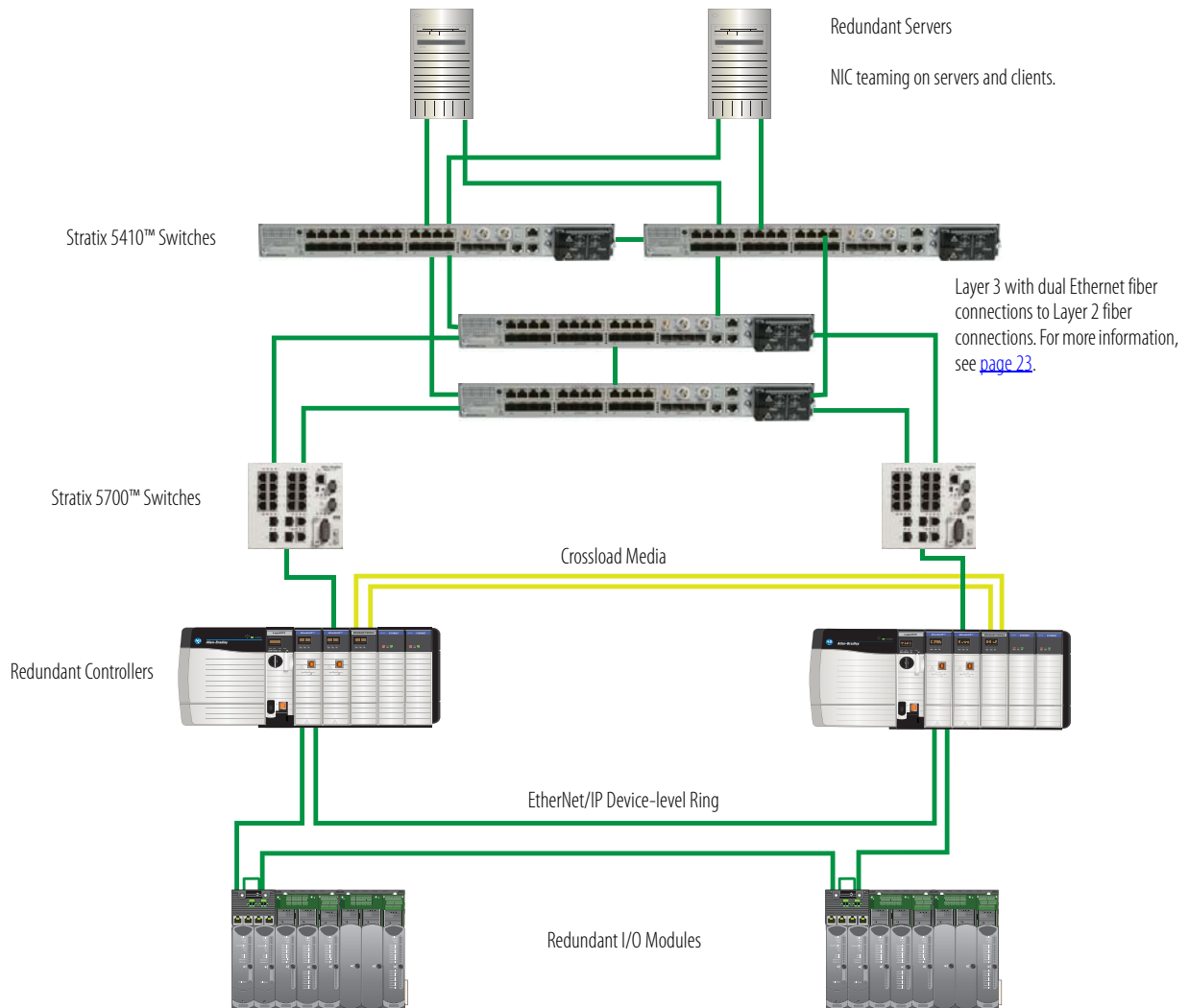

## High Availability Architectures

In process automation, maintaining critical operations requires doing your engineering best to make sure that nothing gets lost, stops working, or is damaged. This work ethic generally involves implementing a highly available automation system. The PlantPAx platform enables high availability by offering redundancy options at each level of the architecture. You can choose the level of redundancy you need without paying for redundant components you don't need.



High availability encompasses productivity, including reliability and maintainability. Reliability is the likelihood that a device performs its intended function during a specific period of time. Maintainability is the ability of a system to be changed or repaired.

**Table 4 - Redundant Element Options**

System Element	High Availability Options
<p>Networks</p> 	<p>The following applies for Ethernet networks:</p> <ul style="list-style-type: none"> <li>• NIC teaming on servers and workstation uses two physical Ethernet cards on each server and workstation</li> <li>• Dual Ethernet media can connect the NIC cards to two separate Layer 2 switches.</li> <li>• Dual Ethernet fiber media can connect the Layer 2 switches to separate switches on a Layer 3 Cisco® Catalyst® 3750x stack or equivalent.</li> <li>• A Device-level Ring network can be used to connect the I/O racks and devices to your simplex or redundant controllers.</li> </ul> <p>The ControlNet network supports redundant media and adapters. For more information, see <a href="#">Network Topologies on page 17</a>.</p>
<p>Servers</p> 	<p>PASS servers can be configured as redundant for the following software components:</p> <ul style="list-style-type: none"> <li>• HMI server</li> <li>• Alarm and Event server</li> <li>• Data server</li> </ul> <p>The AppServ-Batch server supports different levels of fault tolerance. For more information, see <a href="#">AppServ-Batch High Availability Options on page 46</a>.</p> <p>The PlantPAx system supports off-the-shelf hardware high availability options for servers from our Encompass partner Marathon Technologies or through virtualization by using VMware's ESXi architecture.</p>
<p>Controllers</p> 	<p>ControlLogix controllers support enhanced redundancy on EtherNet/IP or ControlNet networks. For more information, see <a href="#">Redundant Controller Hardware Requirements on page 51</a>.</p>
<p>I/O modules</p> 	<p>The 1715 redundant I/O system offers redundant digital and analog I/O. For more information, see <a href="#">High Availability I/O on page 54</a>.</p>
<p>Field devices</p> 	<p>Redundant process network interfaces are available for FOUNDATION Fieldbus and PROFIBUS PA networks. For more information, see <a href="#">FOUNDATION Fieldbus Devices on page 59</a> and <a href="#">PROFIBUS PA Devices on page 60</a>.</p>

See the PlantPAx Distributed Control System Reference Manual, publication [PROCES-RM001](#), for additional redundant components and features, such as alarms and events.

## PlantPax System Estimator

Rockwell Automation offers the PlantPax System Estimator tool as part of the Integrated Architecture® Builder software. The System Estimator tool lets you define your PlantPax system and verifies that your architecture and system elements are sized properly.

The System Estimator tool creates a new workspace and opens a wizard (shown at right) to help you select system elements and size the system. The sizing guidelines are based on the rules and recommendations from PlantPax system characterization to achieve known performance and reliability.

The following items are created based on your inputs:

- Supervisory Ethernet network with all servers, operator, and engineering workstations and controller chassis
- List of required software catalog numbers
- ControlNet or Ethernet network for each controller that includes all I/O requirements
- Various hardware views to support the various devices and chassis

After selecting the system elements as defined in this guide, use the PlantPax System Estimator tool to modify their properties. You can then create a bill of material (BOM) in conjunction with the Integrated Architecture Builder software. The BOM includes controllers, I/O, networks, drives, cabling and wiring, and other devices that comprise your Distributed Control System.

To access the Integrated Architecture Builder software to use the PlantPax System Estimator tool, see <http://www.rockwellautomation.com/en/e-tools/configuration.html>.

## Software Release Information

The rules that are contained within this selection guide are based on using the following characterized software releases:

- Studio 5000 Logix Designer® application, version 24.x
- Studio 5000 Architect™ application, version 1.0
- FactoryTalk View software, version 8.1
- FactoryTalk Batch software, version 12.01
- FactoryTalk AssetCentre software, version 6.1 or later
- FactoryTalk VantagePoint software, version 6.13 or later
- FactoryTalk Historian software, version 4.0 or later

Performance guidelines are based on the use of the software versions listed. For new PlantPax systems, we recommend that you use these versions of software.

For the latest compatible software information, see the Product Compatibility and Download Center at <http://www.rockwellautomation.com/rockwellautomation/support/pcdc.page>.

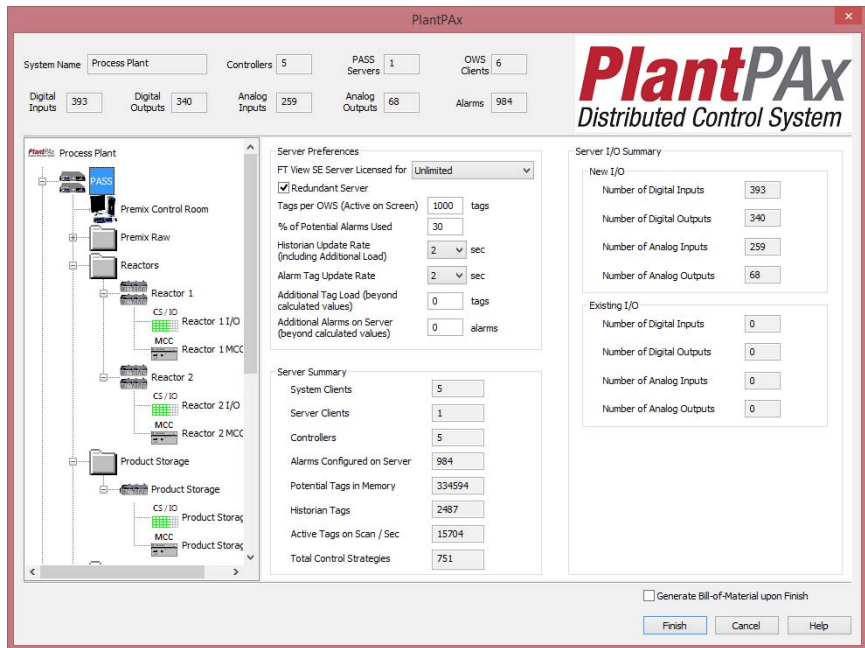

# System Infrastructure

When building your system, you must decide whether your server and client workstations are in a virtual or traditional environment. Traditional, for our purposes, means one operating system (OS) that is natively on one computer. Virtual machines are hardware independent; not tied directly to a specific hardware or OS.

This section describes the basics of the traditional and virtual infrastructures, network topologies, and Ethernet switches to help you select your system infrastructure. The Server and Workstations section ([page 27](#)) provides recommended specifications that are based on your selection of a traditional or virtual infrastructure.

Select from the following options:

- [Traditional Infrastructure](#)
- [Virtual Infrastructure](#)
- [VMware Component Requirements](#)
- [Network Topologies](#)
- [Ethernet Switches](#)

## Traditional Infrastructure

In a traditional infrastructure, each server and workstation is installed on its own physical machine. Software and hardware updates are performed on each server and workstation individually. In addition, there is a conventional relationship between switch ports and servers ports and a standard network management.

## Virtual Infrastructure

Virtualization breaks the dependency between operating system and physical hardware. Multiple virtual machines (VMs) can run different operating systems and applications from various locations on the same server. You can upgrade hardware without stopping your operation or replacing the operating system on the server or workstation system elements, thus reducing downtime and maintenance costs.

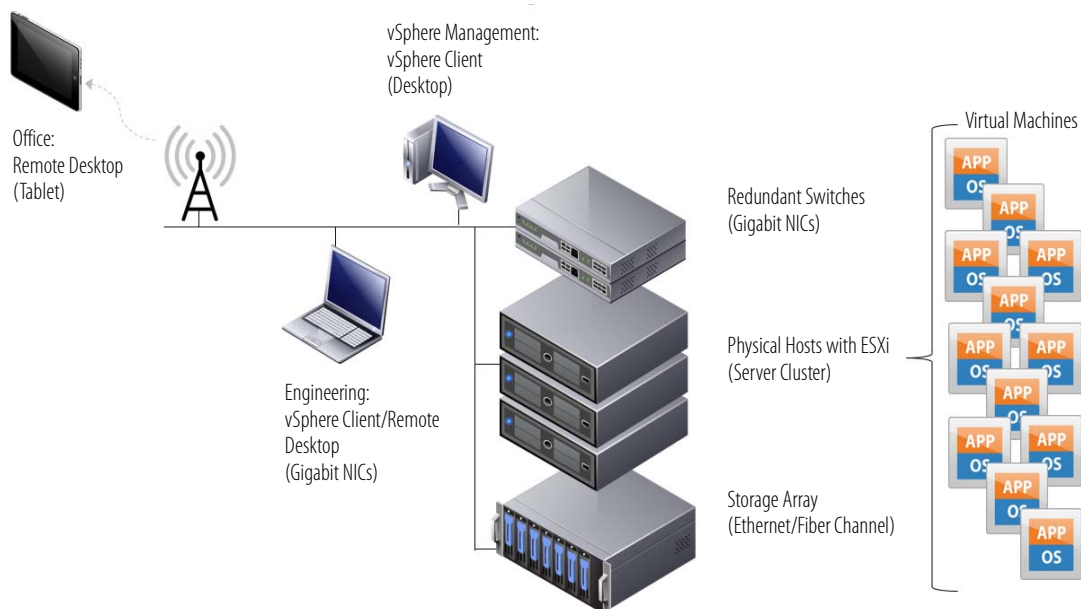

A VM behaves exactly like a physical computer because the VM contains its own 'virtual' CPU, RAM, hard disk drive, and network interface card. The VM runs as an isolated guest OS installation.

The Industrial Data Center (IDC) is a centralized hub for hosting virtual servers and workstations. The data centers have different capacities.

**Table 5 - IDC Model Types**

Model Type	Description
E-2000	<p>Cabinet (19 in.) that includes the following:</p> <ul style="list-style-type: none"> <li>• 2 Physical servers</li> <li>• Storage appliance with redundant controllers</li> <li>• VMware vSphere standard</li> <li>• VMware vCenter Foundation</li> <li>• VMware Horizon View</li> <li>• Redundant server access switch</li> </ul> <p>Optional items:</p> <ul style="list-style-type: none"> <li>• 3rd Physical server</li> <li>• Expands up to 25 additional disks</li> <li>• Data backup appliance</li> <li>• UPS</li> </ul>
E-3000	<p>Cabinet (19 in.) that includes the following:</p> <ul style="list-style-type: none"> <li>• 3 Physical servers</li> <li>• Storage appliance with redundant controllers</li> <li>• VMware vSphere Enterprise</li> <li>• VMware vCenter standard</li> <li>• VMware Horizon View</li> <li>• Redundant server access switch</li> </ul> <p>Optional items:</p> <ul style="list-style-type: none"> <li>• 4th, 5th, and 6th physical server</li> <li>• Expands up to 75 additional disks</li> <li>• Data backup appliance</li> <li>• Redundant UPS</li> </ul>

For purchase information, contact your local Allen-Bradley distributor or Rockwell Automation sales representative. Provide the representatives with a list of applications that you plan to deploy in an IDC.

If you are not using an IDC from Rockwell Automation, you can acquire your own dedicated or shared hosting infrastructure. For typical systems, we recommend that you use a VMware vSphere Standard license. If you want to leverage high availability across more than one Storage Area Network, we recommend that you use a VMware vSphere Enterprise license.

Rockwell Automation offers virtual image templates as an option to deploy the PlantPAx distributed control system. The PlantPAx Virtual Image Templates deliver the core system elements as pre-configured, drop-in templates. A single virtual image template needs only to be ordered. Multiple images can be deployed from a single template.

**Table 6 - Virtual Image Templates**

Virtual Template	Cat. No.	License Type	Description
PASS, EWS, OWS, PADC	9528-PAXVTOENM	OEM	USB device that contains four virtual image templates (PASS, EWS, OWS, and PADC). Each template contains an OEM or Volume License (VL) version of Microsoft® Windows® Server 2012 R2 Standard or Windows 8.1 Pro operating system. All required Rockwell Automation software is pre-installed but not activated.
	9528-PAXVTENM	VL	
AppServ-OWS, AppServ-EWS	9528-APPXWSOENM	OEM	USB device that contains the virtual image template for AppServ-OWS and AppServ-EWS. Each template contains an OEM or Volume License (VL) version of Microsoft Windows 2012 R2 Standard operating systems. All required Rockwell Automation software is pre-installed but not activated. <b>IMPORTANT:</b> Microsoft and Rockwell Automation Licensing has to be per EWS and OWS client, not per AppServ-EWS or AppServ-OWS. Each client needs its own licenses.
	9528-APPXWSENEM	VL	
AppServ-Info (Historian)	9528-APPHISOENM	OEM	USB device that contains the virtual image template for AppServ-Info (Historian). The template contains an OEM or Volume License (VL) version of Microsoft Windows Server 2012 R2 Standard operating system. All required Rockwell Automation software is pre-installed but not activated.
	9528-APPHISENM	VL	
AppServ-Asset	9528-APPASMOENM	OEM	USB device that contains the virtual image template for AppServ-Asset. The template contains an OEM or Volume License (VL) version of Microsoft Windows Server 2012 R2 Standard operating system. All required Rockwell Automation software is pre-installed but not activated.
	9528-APPASMENM	VL	
AppServ-Info (SQL)	9528-APPSQLOENM	OEM	USB device that contains the virtual image template for AppServ-Info (SQL). The template contains an OEM or Volume License (VL) version of Microsoft Windows Server 2012 R2 Standard operating system. All required Microsoft software is pre-installed and activated.
	9528-APPSQLENM	VL	

**Table 6 - Virtual Image Templates**

Virtual Template	Cat. No.	License Type	Description
AppServ-Info (VantagePoint)	9528-APPVTPQENM	OEM	USB device that contains the virtual image template for AppServ-Info (VantagePoint). The template contains an OEM or Volume License (VL) version of Microsoft Windows Server 2012 R2 Standard operating system. Most required Rockwell Automation software is pre-installed but not activated. The FactoryTalk VantagePoint software is not pre-installed for your convenience. For details, see the PlantPAX Virtualization User Manual, publication <a href="#">9528-UM001</a> .
	9528-APPVTPENM	VL	
AppServ-Batch	9528-APPBATOENM	OEM	USB device that contains the virtual image template for AppServ-Batch. The template contains an OEM or Volume License (VL) version of Microsoft Windows Server 2012 R2 Standard operating system. Most required Rockwell Automation software is pre-installed but not activated. The FactoryTalk Batch software is not pre-installed for your convenience. For details, see the PlantPAX Virtualization User Manual, publication <a href="#">9528-UM001</a> .
	9528-APPBATENM	VL	

Each template USB device includes a single OS system for each applicable type. [Table 7](#) shows the catalog numbers that are available to purchase additional OEM licenses of Microsoft Windows Server 2012 R2 Standard or Windows 8.1 software.

**Table 7 - Microsoft Software Licenses**

Software License	Cat. No.	License Type	Description
Microsoft Software License Catalog Numbers	9528-WINSRVOEMENM	OEM	Microsoft OEM License for activating the operating systems of virtual servers leveraging Windows Server 2012 R2 Standard operating system. Includes Windows Server 2012 R2 Standard DVD, Windows Server 2012 R2 Standard Certificate Of Authenticity, one Client Access License, and one Remote Desktop Services Client Access License.
	9528-WINPROOEMENM		Microsoft OEM License for activating the operating systems of virtual workstations leveraging Windows 8.1 Pro. Includes Windows 10 Pro DVD + Certificate Of Authenticity. <b>IMPORTANT:</b> This is a Windows 10 Pro License that can be downgraded and used to activate Windows 8.1 Pro.

If you are considering virtualization, we suggest that you visit the Rockwell Automation Network and Security Services website, <http://www.rockwellautomation.com/services/networks>.

For additional information, see the following:

- PlantPAX Virtualization User Manual, publication [9528-UM001](#) — Describes the PlantPAX virtual images for the deployment of the PlantPAX system on virtual architectures.
- PlantPAX Distributed Control System Reference Manual, publication [PROCES-RM001](#) — Provides recommendations and guidelines for best practice of system architecture and elements.

## VMware Component Requirements

When purchasing hardware, consider future expansion plans by adding an additional 20...30% of resources. VMware makes it simple to scale the system size upward by adding servers in the future to provide additional resources.

The VMware vCenter server provides a centralized platform for managing your VMware vSphere environments. The virtual desktop and virtual server require resources from the physical infrastructure to operate. For ESXi servers, you need to reserve 2 vCPUs and 4 GB of vRAM.

Remember to divide the total system requirements by the minimum number of servers that are required to run the system at any given time. For example, with a three-server system that uses VMware fault tolerance or high availability, you divide by two. Calculating resources this way makes sure that the system can continue to run with two servers if one server fails.

### VMware Sizing

Virtual Machines are always limited by the CPU megahertz of the physical core. A common misconception is that a VM can use as much CPU megahertz as needed from the combined total available. A single vCPU VM can never use more megahertz than the maximum of one CPU/core. If a VM has two vCPUs, it can never use more megahertz than the maximum of each CPU/core.

Determine the number of physical cores required for a system by using the consolidation ratios in [Table 8.1](#) in combination with the vCPU requirements documented in [Table 8.2](#) for a PlantPAx system with a known architecture.

**Table 8.1 - CPU Consolidation Ratios**

Server and Workstation Type	vCPU: Physical Core
Process Automation System Servers (PASS)	2:1
Operator Workstations (OWS)	6:1
Engineering Workstations (EWS)	2:1
Application Server HMI (AppServ-HMI)	2:1
Application Server Information Management (AppServ-Info)	2:1
Application Server Asset Management (AppServ-Asset)	2:1
Application Server Batch (AppServ-Batch)	2:1
Process Automation Domain Controller	2:1
VMware vCenter	1:1

**Table 8.2 - PlantPAx Resource Requirements**

PlantPAx System Elements (x64-bit OS)	vCPU	vRAM
Process Automation System Servers (PASS)	2	4 GB
Process Automation Domain Controller	1	4 GB
Operator Workstations (OWS)	1 <sup>(1)</sup>	2 GB
Engineering Workstations (EWS)	2 <sup>(1)</sup>	4 GB
Application Server HMI (AppServ-HMI)	2	4 GB
Application Server Information Management (AppServ-Info)	2	4 GB
Application Server Asset Management (AppServ-Asset)	2	4 GB
Application Server Batch (AppServ-Batch)	2	4 GB
Application Server Operator Workstation (AppServ-OWS)	4	8 GB

(1) This number of vCPUs is for two monitors. For four monitors, we recommend that you double the vCPU.

To calculate specific virtual requirements for your system, use the PSE. For information on the PSE tool, see [page 12](#).



## Network Topologies

The following network map is an example of a PlantPAx system topology. The map comprises different network layers, including Supervisory and Controller and I/O.

Each layer has specific infrastructure components to connect all the segments together. These include managed switches, media converters, cables, and routers. Managed switches are required throughout and can be configured as several topologies.

For more information on switches, see [page 23](#).

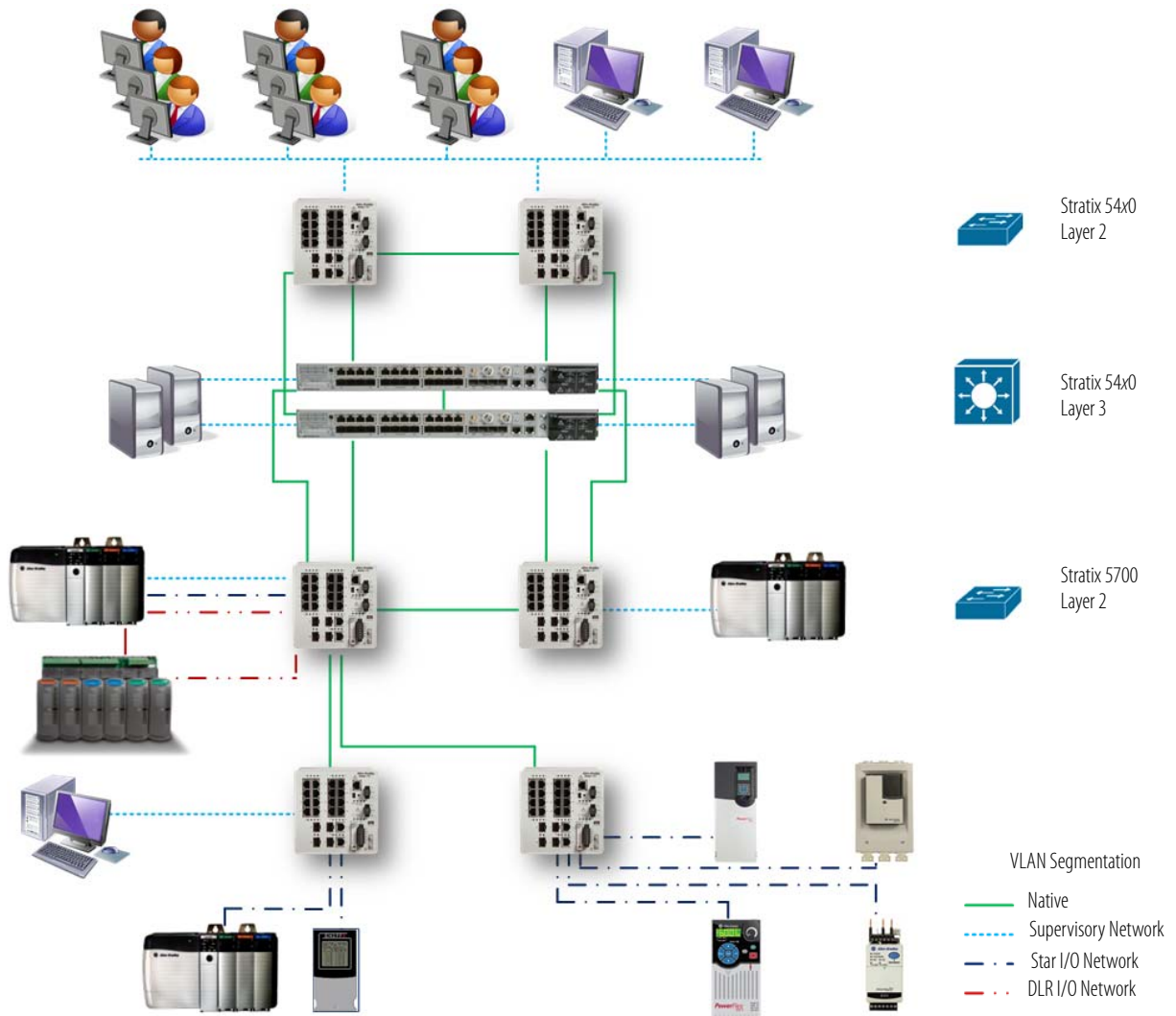

The following pages describe the individual network topologies that are recommended for each layer.

## Supervisory Layer

This section describes the topology that connects the user to the system. The layer provides access to information and lets you configure system settings, notably security authentication.

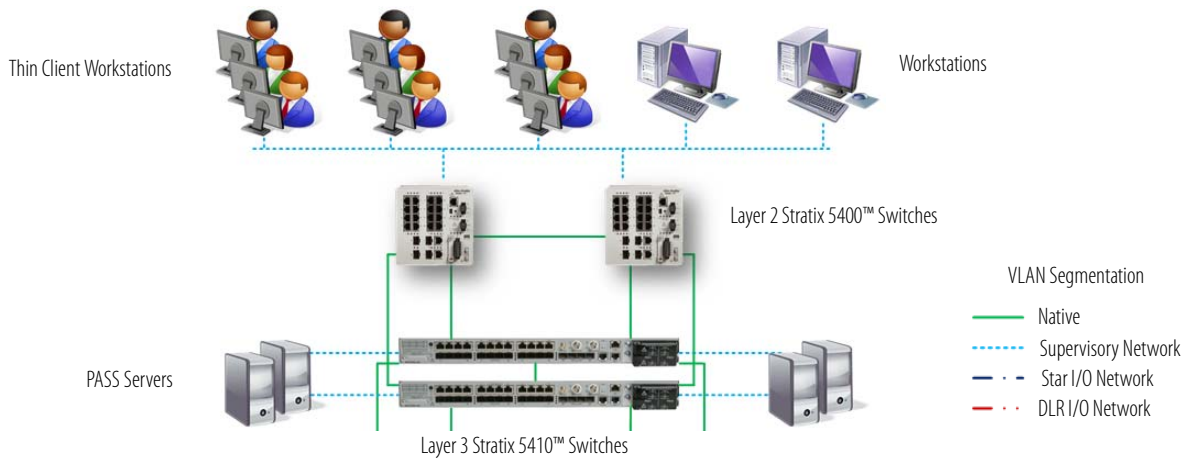

We recommend a Redundant Star topology where every Layer 2 access switch has dual connections to a Layer 3 distribution switch. Devices, such as servers and workstations, are connected via a single connection (or dual connections by using NIC teaming) to the Layer 2 switches.

Topology Characteristics:

- Best-suited for high availability with redundant distribution switches
- Direct path between layer 3 distribution switches and layer 2 access switches
- Additional removal of network devices (anything on the network other than the Layer 3 switch) without affecting the network

**Table 9 - Redundant Star (Recommended)**

Topology	Network Hardware		
	Necessary connections:		
	<ul style="list-style-type: none"> <li>• Layer 3 switches have two-GB connections to each Layer 2 switch.</li> <li>• Layer 2 switches have one 100-MB connection to each server and workstation on the network.</li> </ul>		
	Recommended Hardware:		
	Category	Product Family	Description
	Ethernet switch	Stratix 5400™ or Stratix 5410 See <a href="#">page 23</a>	Layer 3 distribution switch, with capacity to connect Layer 2 switches. Minimum of two switches needed.
		Stratix 5700™ or Stratix 54x0 See <a href="#">page 24</a>	Layer 2 access switch, with capacity to connect to all servers and workstations and uplink connections to Layer 3.

Additional Ethernet features that support high availability include these advanced network resiliencies and convergence techniques:

- EtherChannel and Link Aggregation Control Protocol (LACP) provide additional bandwidth between two devices by aggregating multiple Ethernet connections into a higher bandwidth virtual connection. These protocols quickly recover from the loss of one or more channel members.
- Flex Links is a Cisco-proprietary resiliency protocol that is for use in redundant star networks. This protocol connects an access switch to a distribution switch.

## Additional Supported Supervisory Network Topologies

In the Star topology, every Layer 2 access switch has a single connection to a Layer 3 distribution switch. Devices, such as servers and workstations, are connected via a single connection to the Layer 2 switches.

Topology Characteristics:

- Sensitive to a single point of failure due to a single centralized switch
- Additional removal of network devices (anything on the network other than the Layer 3 switch without affecting the network
- Increased port capability on the switch to add more devices.
- No hot standby for routing.

**Table 10 - Star**

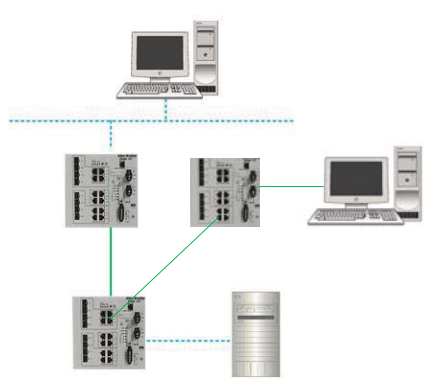
Topology	Network Hardware		
	Necessary connections: <ul style="list-style-type: none"> <li>• Layer 3 switches have 1-GB connection to each Layer 2 switch.</li> <li>• Layer 2 switches have one 100-MB connection to each server and workstation on the network.</li> </ul>		
	<b>Recommended Hardware:</b>		
	Category	Product Family	Description
Ethernet switch	Stratix 5400 or Stratix 5410 See <a href="#">page 23</a>	Layer 3 distribution switch, with capacity to connect Layer 2 switches.	
	Stratix 5700 or Stratix 54x0 See <a href="#">page 24</a>	Layer 2 access switch, with capacity to connect to all servers and workstations and uplink connections to Layer 3.	

A Switch Ring network is a single-fault tolerant ring network that connects Layer 2 access switches to a Layer 3 distribution switch.

Topology Characteristics:

- Network configuration changes automatically from a ring to a linear topology in the event of communication loss
- Network changes automatically from a linear to a ring topology once communication is restored
- Troubleshooting centralization, changes, or issues can be addressed by accessing the Layer 3 switch

**Table 11 - Switch Ring**

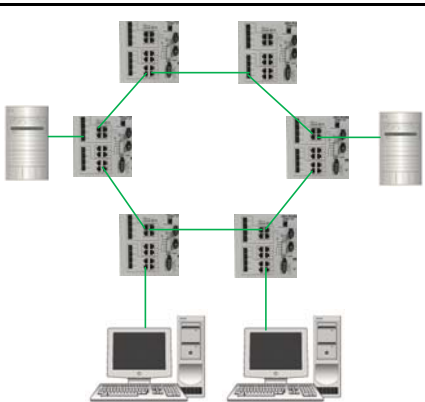
Topology	Network Hardware		
	Necessary connections: <ul style="list-style-type: none"> <li>• Layer 3 switches have 1-GB connection to each Layer 2 switch.</li> <li>• Layer 2 switches have one 100-MB connection to each server and workstation on the network.</li> </ul>		
	<b>Recommended Hardware:</b>		
	Category	Product Family	Description
Ethernet switch	Stratix 5400 or Stratix 5410 See <a href="#">page 23</a>	Layer 3 distribution switch, with capacity to connect Layer 2 switches.	
	Stratix 5700 or Stratix 54x0 See <a href="#">page 24</a>	Layer 2 access switch, with capacity to connect to all servers and workstations and uplink connections to Layer 3.	

## Controller and I/O Layer

The plant-level network that executes controller commands and processes input from field devices.

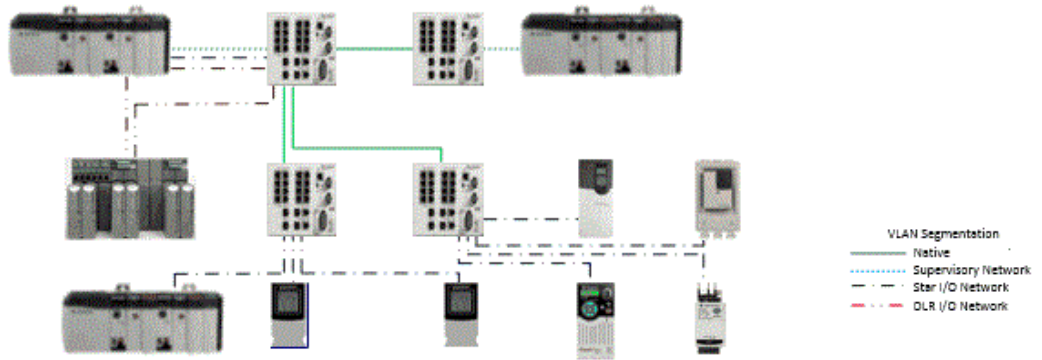

The Star is the most common EtherNet/IP network where devices are connected and communicate with each other via a switch. Nodes are typically grouped closely together.

Topology Characteristics:

- East to design, configure, and implement
- Direct path between the Layer 2 access switch and the end device
- Remove and add end devices without affecting the rest of the network
- Troubleshooting centralization, changes, or issues can be addressed by accessing the Layer 3 switch

**Table 12 - Star I/O (Recommended)**

Topology	Network Hardware		
	Necessary connections: <ul style="list-style-type: none"> <li>• Layer 2 switches have one 100-MB connection to each Ethernet adapter for each end device, and block of distributed I/O.</li> <li>• Ethernet adapters must be used to bridge I/O modules and Layer 2 switches.</li> </ul>		
	<b>Recommended Hardware:</b>		
	<b>Category</b>	<b>Product Family</b>	<b>Description</b>
Ethernet switch	Stratix 5400 or Stratix 5410 See <a href="#">page 23</a>	Layer 2 access switch, with capacity to connect to all controllers, drives, and I/O.	
Ethernet adapter	See <a href="#">page 53</a> and <a href="#">page 61</a>	Communication adapter for controllers, drives, and I/O	

## Additional Supported I/O Network Topologies

A Device-level ring (DLR) network is intended for the interconnection of automation devices. This topology has switches that are embedded into the end devices themselves; no additional switches are required.

**IMPORTANT:** The DLR network provides a level of fault tolerance that permits a single point of failure, similar to a ControlNet ring. However, unlike ControlNet, powering down a device that is on a DLR network acts as a break on the ring. Consider this aspect when doing your network topology selection. If the devices on the DLR network are controlling multiple pieces of equipment and there are more than four nodes, consider the impact of de-energizing or disconnecting a panel, rack, adaptor, or device that can occur as part of regular maintenance procedures. Using a star topology (or redundant ControlNet) can be a better topology to make sure these types of maintenance actions do not impact operations when compared to a large DLR network.

**Table 13 - DLR Network**

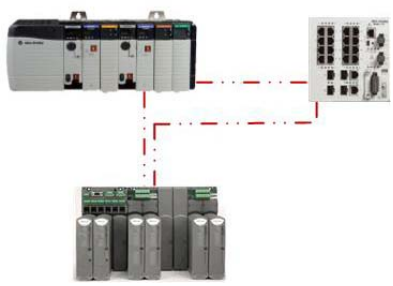
Topology	Network Hardware		
	Necessary connections:		
	<ul style="list-style-type: none"> <li>Requires dual-port Ethernet adapters that support DLR.</li> <li>Non-DLR devices can be implemented in this configuration through the use of the 1783-Etap.</li> </ul>		
	<b>Recommended Hardware:</b>		
	Category	Product Family	Description
Ethernet switch	Optional, Stratix 5700 or Stratix 5400 See <a href="#">page 24</a>	Layer 2 access switch, with switching only; no routing capabilities.	
Ethernet adapter	See <a href="#">page 53</a> and <a href="#">page 56</a>	Communication adapter for controllers, drives, and I/O. Adapters must support DLR.	

A Linear network is a collection of devices that are daisy-chained together. A linear topology works best for a limited number of nodes.

Topology Characteristics:

- Low cost of implementation
- Sensitive to a single point of failure
- Minimal amount of cabling is needed

**Table 14 - Linear Network**

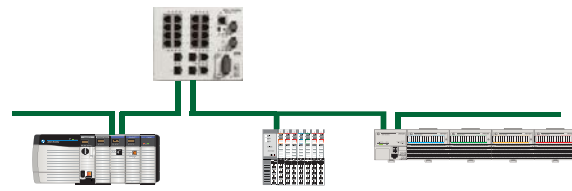
Topology	Network Hardware		
	Necessary connections:		
	<ul style="list-style-type: none"> <li>The EtherNet/IP embedded switch technology lets this topology to be implemented at the device level.</li> <li>No additional switches are required.</li> </ul>		
	<b>Recommended Hardware:</b>		
	Category	Product Family	Description
Ethernet switch	Optional, Stratix 5700 or Stratix 5400 See <a href="#">page 24</a>	Layer 2 access switch, with switching only; no routing capabilities.	
Ethernet adapter	See <a href="#">page 53</a> and <a href="#">page 56</a>	Communication adapter for controllers, drives, and I/O. Be sure to use dual-port Ethernet adapters.	

A ControlNet network supports the option of redundant media. For information on ControlNet media, see the ControlNet Media System Components List, [AG-PA002](#).

Topology Characteristics:

- Open control network that is deterministic for real-time, high-throughput applications
- Provides control networking in discrete and process applications that include high availability applications.

**Table 15 - Redundant ControlNet Media**

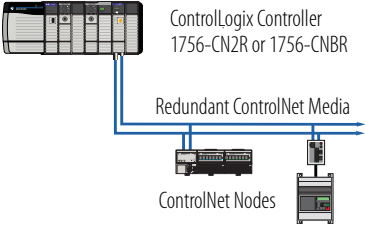
Topology	Network Hardware		
 <p>ControlLogix Controller 1756-CN2R or 1756-CNBR</p> <p>Redundant ControlNet Media</p> <p>ControlNet Nodes</p>	Necessary connections: <ul style="list-style-type: none"> <li>• Supports controller-to-controller interlocking and real-time control of I/O, drives, and valves.</li> </ul>		
	<b>Recommended Hardware:</b>		
	<b>Category</b>	<b>Product Family</b>	<b>Description</b>
ControlNet adapter	See <a href="#">page 53</a> and <a href="#">page 57</a> .	Communication adapter for controllers, drives, and I/O.	

## Ethernet Switches

A network switch is a computer networking device that is used to connect devices on a computer network by performing a form of packet switching. A switch is considered more advanced than a hub. A switch sends a message only to the device that needs or requests it, rather than broadcasting the same message out of each of its ports. Leveraging the collaboration of Rockwell Automation with Cisco on products and services, the PlantPAX system integrates technical and business systems by using EtherNet/IP and industrial grade Ethernet switches.

All applications require proper configuration to achieve the best system performance. If you do not configure the managed switch, it's possible that system performance can be adversely affected. We provide network configuration guidance in the PlantPAX System Infrastructure User Manual, publication [PROCES-UM001](#). In any case, we recommend that you contact your system administrator if there are any doubts on the installation and configuration.

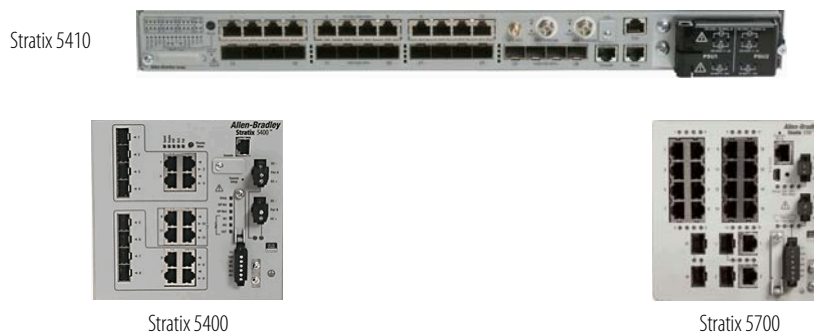

The following catalog numbers are recommended options for the PlantPAX system. For switch specifications, certifications, and the latest product information available, see the Stratix Ethernet Device Specifications Technical Data, publication [1783-TD001](#).

**Table 16 - 5410 Ethernet Managed Switches (19-in. Rack Mount)**

Cat. No.	Total Ports	SFP Slots <sup>(2)</sup>	Firmware Type	Power Supply <sup>(3)</sup>
1783-IMS28NDC	28	12 GE + 4 TEN	Layer 2	Low DC: 24 . . . 60V DC, 10 A
1783-IMS28NAC				AC/High DC: 100 . . . 240V AC, 2 A or 100 . . . 250V DC, 12 A
1783-IMS28RDC			Layer 3	Low DC: 24 . . . 60V DC, 10 A
1783-IMS28RAC				AC/High DC: 100 . . . 240V AC, 2 A or 100 . . . 250V DC, 12 A
<b>Optional Power Supplies<sup>(1)</sup></b>				
1783-IMXDC	Low DC			
1783-IMXAC	AC/High DC			

(1) The switch supports an optional second power supply of any voltage type to provide redundancy and additional power for PoE devices. One power supply provides 60 W for PoE/PoE+. Two power supplies provide 185 W for PoE/PoE+.

(2) GE = Gigabit Ethernet; TEN = 10 Gigabit Ethernet. Use GE connections for distance up to 550 m (1804 ft). FE (fast Ethernet) provides distance up to 10 km (32,808 ft). See [Table 20 on page 25](#).

(3) One power supply ships pre-installed in each Stratix 5410 switch.

**Table 17 - Distribution 5400 Layer 3 Ethernet Managed Switches (DIN Rail)<sup>(1)</sup>**

Cat. No.	Total Ports	RJ45 Ports <sup>(2)</sup>	Combo Ports	SFP Ports
1783-HMS8TG4CGR	12	8 GE	4GE	N/A
1783-HMS8SG4CGR		N/A		8 GE
1783-HMS4EG8CGR			4 GE	4 GE
1783-HMS4SG8EG4CGR	16		4 GE	4 GE
1783-HMS16TG4CGR	20	16 GE	4 GE	N/A
1783-HMS8TG8EG4CGR		8 GE		

- (1) All 5400 switches require 24V DC power. Redundant power sources recommended.  
 (2) GE = Gigabit Ethernet. Use GE connections for distance up to 550 m (1804 ft). FE (fast Ethernet) provides distance up to 10 km (32,808 ft). See [Table 20 on page 25](#).

**Table 18 - Access 5400 Layer 2 Ethernet Managed Switches<sup>(1)</sup>**

Cat. No.	Total Ports	RJ45 Ports <sup>(2)</sup>	Combo Ports	SFP Ports
1783-HMS4C4CGN	8	N/A	4 FE, 4 GE	N/A
1783-HMS8T4CGN	12	8 FE	4 GE	8 FE
1783-HMS8S4CGN		N/A		
1783-HMS4T4E4CGN		4 FE		
1783-HMS4S8E4CGN	16	N/A		4 FE
1783-HMS16T4CGN	20	16 FE		N/A
1783-HMS8TG4CGN	12	8 GE	8 GE	8 GE
1783-HMS8SG4CGN		N/A		
1783-HMS4EG8CGN		4 GE		
1783-HMS4SG8EG4CGN	16			4 GE
1783-HMS16TG4CGN	20	16 GE		N/A
1783-HMS8TG8EG4CGN		8 GE		

- (1) All 5400 switches require 24V DC power. Redundant power sources recommended.  
 (2) FE = Fast Ethernet; GE = Gigabit Ethernet. Use GE connections for distance up to 550 m (1804 ft). FE (fast Ethernet) provides distance up to 10 km (32,808 ft). See [Table 20 on page 25](#).

**Table 19 - Access 5700 Layer 2 Ethernet Managed Switches<sup>(1) (2)</sup>**

Cat. No. <sup>(3)</sup>	Total Ports	RJ45 Ports <sup>(4)</sup>	Combo Ports	SFP Slots	CIP Sync (IEEE 1588)	NAT	DLR
1783-BMS10CGP	10	8 FE	2 GE	N/A	Yes	N/A	Yes
1783-BMS10CGN						Yes	
1783-BMS12T4E2CGP	18	12 FE				2 FE	
1783-BMS12T4E2CGNK				Yes			
1783-BMS20CGP	20	16 FE	2 FE			N/A	
1783-BMS20CGN						Yes	
1783-BMS20CGPK						N/A	

- (1) For configuration back up and restore, we recommend 1 GB industrial SD Card, catalog number 1784-SD1.  
 (2) All 5700 switches require 24V DC power. Redundant power sources recommended.  
 (3) Conformal Coating is available. For more information, see the Stratix Ethernet Device Specifications Technical Data, publication [1783-TD001](#).  
 (4) FE = Fast Ethernet; GE = Gigabit Ethernet. Use GE connections for distance up to 550 m (1804 ft). FE (fast Ethernet) provides distance up to 10 km (32,808 ft). See [Table 20 on page 25](#).



**Table 20 - SFP Transceivers**

Cat. No.	SFP	Description	Wavelength (nm)	Core Size/ Cladding Size (micron)	Modal Bandwidth (MHz/km)	Cable Length
1783-SFP100FX	FE	100Base-FX multi-mode transceiver	1310	50/125	500	2 km (6562 ft)
1783-SFP100LX				62.5/125		
		100Base-LX single-mode transceiver		G.652	N/A	10 km (32,808 ft)
1783-SFP1GSX	GE	1000Base-SX multi-mode transceiver	850	62.5/125	160	220 m (722 ft)
				62.5/125	200	275 m (902 ft)
				50/125	400	500 m (1640 ft)
				50/125	500	550 m (1804 ft)
1783-SFP1GLX		1000Base-LX/LH single-mode transceiver	1310	G.652	N/A	10 km (32,808 ft)

### Additional Switch Information

See the Stratix Ethernet Device Specifications Technical Data, publication [1783-TD001](#), for information on the following switch components:

- Stratix 5900™ Service Router (Layer 2/3)
- Stratix 5100™ Wireless Access Point/Workgroup Bridge (Layer 2)
- Embedded EtherNet/IP Taps

We also support the use of Cisco switches. To help make sure of performance, we recommend that all system switches are Cisco or Stratix for common use of protocols.

The following switches are supported on the PlantPax system:

- Cisco Catalyst 3750x (Layer 3)
- Cisco Catalyst 3850 (Layer 3)
- Cisco Catalyst 4500x (Layer 3)
- Cisco Catalyst 2960G (Layer 2)

For more information, see the Cisco website at [www.cisco.com](http://www.cisco.com).

Notes:

# Servers and Workstations

The supervisory layer of the PlantPAx system can include several servers and workstations. This section explains the server and workstation system elements to help you define a bill-of-material.

## PASS Server

The Process Automation System Server (PASS) is a required system element that hosts essential software components to run the system. The essential software components include the data server, HMI server, and alarm server.

Select from the following options:

- [PASS Server](#)
- [Engineering Workstation \(EWS\)](#)
- [Operator Workstation \(OWS\)](#)
- [Operator Workstation Application Server \(AppServ-OWS\)](#)
- [Independent Workstation \(IndWS\)](#)
- [AppServ-Info \(Historian\)](#)
- [AppServ-Info \(VantagePoint\)](#)
- [AppServ-Info \(SQL\)](#)
- [Asset Management Server \(AppServ-Asset\)](#)
- [Batch Management Server \(AppServ-Batch\)](#)
- [Domain Controller](#)

You need to determine how many PASS servers are needed for your architecture. If your system requires more than one server, acquaint yourself with the following descriptions of the data, HMI, and alarm servers. See [page 28](#) for illustrations.

**Table 21 - PASS Server Software Components**

Software Components	Description
FactoryTalk Network Directory (FTD) server <sup>(1)</sup>	Secures information from multiple Rockwell Automation software components across multiple computers and allows central administration throughout the PlantPAx system. Application components, such as display and security settings, can be stored in their original environments and made available to the entire PlantPAx system without the need for duplication. See <a href="#">Process Automation System Server Software and Licenses on page 30</a> for licensing information.
FactoryTalk Activation server <sup>(1)</sup>	The FactoryTalk Activation server is part of the FactoryTalk Services Platform. The server is used for FactoryTalk-enabled software products to be activated via files generated by Rockwell Automation over the Internet. This server essentially manages the files that are required to license Rockwell Automation products on the PlantPAx system.
FactoryTalk View HMI server	The human machine interface (HMI) server is configured within your FactoryTalk View Site Edition (SE) application. The HMI server stores HMI project components, such as graphic displays, and serves these components to OWSs upon request. The HMI server also can manage tag databases and log historical data. Multiple HMI servers can exist on the PlantPAx system. Each HMI server must be on a separate PASS.
FactoryTalk View Data server	The Data server component provides access to information from the process controllers to servers and workstations on the PlantPAx system. FactoryTalk View software supports two types of data servers: Rockwell Automation Device servers (RSLinx® Enterprise software) and OPC Data servers. The Data server that is mentioned in PlantPAx documentation generally refers to the Rockwell Automation Device servers. Data servers are configured within your FactoryTalk View SE application. Multiple data servers can exist on the PlantPAx system.
FactoryTalk View Alarms and Events server	The Alarm and Event server publishes information from controllers and servers available to all subscribing OWSs. Alarm and Event servers are configured within your FactoryTalk View SE application. There are two types of Alarm and Event servers: device-based and server-based. Device-based Alarm and Event servers are configured as an option to the data server. The server-based Alarm and Event servers are configured as a separate component. Each Alarm and Event server must be on a separate PASS. The Alarm and Event server that is mentioned in PlantPAx documentation refers to the Alarm and Event server that is server-based.
<b>Optional</b>	
FactoryTalk Batch client software	If a Batch Application server is being used on the system, FactoryTalk Batch client components are required to support replication of batch-related objects on the displays to the OWS.

(1) In redundant PASS configurations, this component is included on the primary PASS only. See [PASS Redundancy Options on page 29](#) for more information.

## Determining the Number of PASS Servers

The following graphics illustrate how many servers are needed when you are not considering redundancy options. If you are using redundant servers, see [page 29](#).

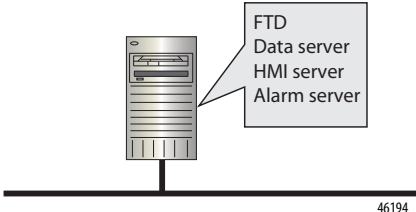
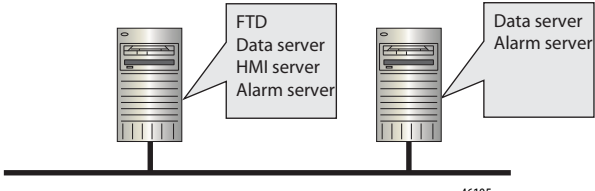
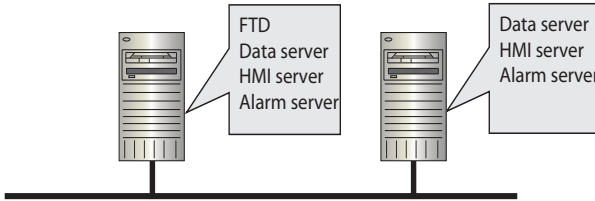
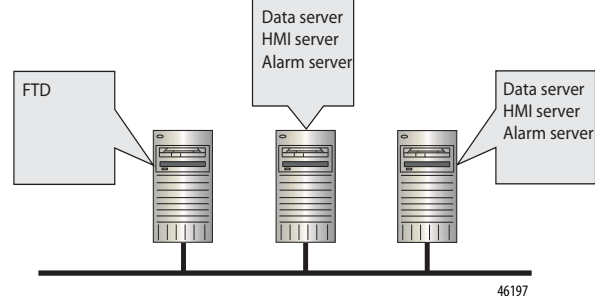
Server Options	Description
<p>Option 1 - One Server</p> 	<p>This option has all of the essential software components housed in a single PASS server:</p> <ul style="list-style-type: none"> <li>• FTD – FactoryTalk Directory allows for central administration of multiple components that exist on multiple client servers. For example, security settings in original environments can be shared throughout the PlantPax system.</li> <li>• Data server – The data server handles communication between controllers and the servers and workstations. Data servers are limited by capacity, such as number of OWSs, communication of controllers to displays, and communication of controllers to data logs or Historian software.</li> <li>• HMI server – These servers segregate the plant into logical areas; also store visualization components for OWS upon request.</li> <li>• Alarm server – When the PASS is used as a data server, it is also typically used as an alarm server.</li> </ul> <p>One HMI server license is required.</p>
<p>Option 2 - One Server with Additional Data Capacity Required<sup>(1)</sup></p> 	<p>This option contains all of the software components in one server as shown in Option 1. Option 2 also adds an additional server for extra data and alarm capacity without adding an additional HMI server.</p> <p>If the PASS server is being used as a data server, and additional capacity is needed, you can add more PASS servers. Use the PSE to determine if more PASS servers are needed. A PASS server can typically handle 1...8 controllers.</p> <p>We recommend that you have an HMI server on the PASS if you are segregating the application into individual operational areas. See Option 3.</p> <p>One HMI server license is required.</p>
<p>Option 3 - Logically Segregated Plant into Operational Areas</p> 	<p>This option lets you configure separate areas, each one with its own server that is based on the particular process.</p> <p>An HMI server license is required for each PASS.</p>
<p>Option 4 - Logically Segregated Plant into Operational Areas (fully independent)</p> 	<p>You can place the FTD on its own server to manage applications that exist on multiple client servers.</p> <p>If an area needs to be shut down, the other separate areas are not affected because the FTD is on its own server. For example, you can perform maintenance on one area without affecting another operational area of the plant. FTD can be a workstation class machine.</p> <p>An HMI server license is required for each PASS containing an HMI server.</p>

(1) Not characterized with the PlantPax system, but a valid configuration.

## PASS Redundancy Options

PASS servers can be configured as redundant for the following software components:

- HMI server
- Alarm server
- Data server

Redundancy can be added to be sure of the availability of critical operations. For PASS servers, you can choose the level of redundancy that you need. When a PASS is made redundant, typically all of the above elements that are hosted on the PASS are made redundant. Redundant PASS servers require duplicate hardware as listed in [Table 22.1](#).

Selecting redundant data servers impacts controller memory and communication bandwidth.

For more information, see the following:

- [High Availability Architectures on page 10](#)
- PlantPAx Distributed Control System Reference Manual, publication [PROCES-RM001](#)

**Table 22.1 - PASS Virtual Requirements**

Category	Requirement <sup>(1)</sup>
Virtual infrastructure	Required: <ul style="list-style-type: none"> <li>• 2 vCPU</li> <li>• 4 GB vRAM min</li> </ul> Recommended CPU and memory allocation: <ul style="list-style-type: none"> <li>• High priority Resource pool<sup>(2)</sup></li> </ul>
Operating system	Windows Server 2012 R2 operating system, 64 bit
Additional third-party software	Antivirus software <sup>(3)</sup>

(1) All numbers and figures are referenced for initial sizing only. The values can be adjusted for system performance if needed.

(2) See the PlantPAx Distributed Control System Reference Manual, publication [PROCES-RM001](#), for Resource Pool Allocation.

(3) Rockwell Automation has tested the use of Symantec Endpoint Protection. For more information, see Knowledgebase Answer ID 35330 at <https://www.rockwellautomation.custhelp.com>.

**Table 22.2 - PASS Traditional Requirements**

Category	Requirement
Traditional infrastructure	The PASS must be installed on server-class hardware. The following are sample specifications based on PlantPAx system characterization: <ul style="list-style-type: none"> <li>• Intel® Xeon Multicore processor (4 cores or greater)</li> <li>• 2.40 GHz CPU</li> <li>• 4 GB RAM min</li> <li>• Ethernet card that supports redundant media if NIC-teaming is used (If you plan to use a motherboard-NIC make sure it supports redundant media)</li> </ul>
Operating system	Windows Server 2012 R2 operating system, 64 bit
Additional third-party software	Antivirus software <sup>(1)</sup>

(1) Rockwell Automation has tested the use of Symantec Endpoint Protection. For more information, see Knowledgebase Answer ID 35330 at <https://www.rockwellautomation.custhelp.com>.

The PASS requires that you purchase visualization software licenses depending on the number of displays hosted by the PASS server. If the PASS server is not being used as an HMI server, then no license purchase is required.

Make sure to account for process displays, faceplates and navigation devices in your display count. For example, the Rockwell Automation Library of Process Objects includes more than 100 faceplates, help displays, and quick displays. If all of the library objects are loaded into your application, these faceplates and help files count against your display count license.

**Table 22.3 - Process Automation System Server Software and Licenses**

Category	Cat. No.	Description
Virtual image template	Select one copy per project of the following if using virtualization and virtual image templates: <ul style="list-style-type: none"> <li>• 9528-PAXVTOENM</li> <li>• 9528-PAXVTENM (if using Microsoft volume licensing)</li> </ul>	USB device contains a virtual image template that has pre-installed all applications that are required on the PASS.  See <a href="#">Table 6 on page 14</a> for template details.
Rockwell Automation software licenses	Select one of the following per PASS when the PASS is used as an HMI server: <sup>(1)</sup> <ul style="list-style-type: none"> <li>• 9528-PASS100ENE</li> <li>• 9528-PASS250ENE</li> <li>• 9528-PASSUNLENE</li> </ul>	Number of displays: <ul style="list-style-type: none"> <li>• 100-display license for the PASS server</li> <li>• 250-display license for the PASS server</li> <li>• Unlimited display license for the PASS server</li> </ul>

(1) These PASS software licenses are equivalent to FactoryTalk View SE server licenses: 9701-VWSS000LENE, 9701-VWSS250LENE, 9701-VWSS100LENE. You can use either the PlantPAx or FactoryTalk View SE software license with the PASS server.

## Engineering Workstation (EWS)

The engineering workstation (EWS) supports system configuration, application development, and maintenance functions. This is the central location for monitoring and maintaining the systems operation. The recommended limit is five EWS per system.

**Table 23.1 - EWS Virtual Requirements**

Category	Requirement <sup>(1)</sup>
Virtual infrastructure	Required: <ul style="list-style-type: none"> <li>• 2 vCPU</li> <li>• 4 GB vRAM min</li> </ul> Recommended CPU and memory allocation: <ul style="list-style-type: none"> <li>• Normal priority Resource pool<sup>(2)</sup></li> </ul>
Operating system	Windows 8.1 operating system, 64 bit
Additional third-party software	Antivirus software <sup>(3)</sup>

(1) All numbers and figures are referenced for initial sizing only. The values can be adjusted for system performance if needed.

(2) See the PlantPAx Distributed Control System Reference Manual, publication [PROCES-RM001](#), for Resource Pool Allocation.

(3) Rockwell Automation has tested the use of Symantec Endpoint Protection. For more information, see Knowledgebase Answer ID 35330 at <https://www.rockwellautomation.custhelp.com>.

**Table 23.2 - EWS Traditional Requirements**

Category	Requirement
Traditional infrastructure	The EWS must be installed on workstation-class hardware. The following are sample specifications based on PlantPAx system characterization: <ul style="list-style-type: none"> <li>• Intel Core 2 Duo</li> <li>• 2.40 GHz CPU</li> <li>• 4 GB RAM min</li> <li>• Ethernet card that supports redundant media if NIC-teaming is used (If you plan to use a motherboard-NIC make sure that it supports redundant media)</li> </ul>
Operating system	Windows 8.1 operating system, 64 bit
Additional third-party software	Antivirus software <sup>(1)</sup>

(1) Rockwell Automation has tested the use of Symantec Endpoint Protection. For more information, see Knowledgebase Answer ID 35330 at <http://www.rockwellautomation.custhelp.com>.

**Table 23.3 - EWS Automation System Software and License**

Category	Cat. No.	Description
Virtual Image Template	Select one per project of the following if using virtualization and virtual image templates: <ul style="list-style-type: none"> <li>• 9528-PAXVTOENM</li> <li>• 9528-PAXVTENM (if using Microsoft volume licensing)</li> </ul>	USB device contains a virtual image template that has pre-installed all applications that are required on the EWS. See <a href="#">Table 6 on page 14</a> for template details.
Rockwell Automation software license	For each client that is served by the AppServ-EWS: 9528-EWSLICENE <sup>(1)</sup>	Software activation license for the EWS for virtual and traditional environments.

(1) This EWS software license is equivalent to a FactoryTalk View Studio license (9701-VWSTENE) and Studio 5000 Logix Designer application license (9324-RLD700NXENE). You can use the PlantPAx or FactoryTalk View Studio and Logix Designer Application licenses with the EWS.

## Engineering Workstation Application Server (AppServ-EWS)

The AppServ-EWS uses Microsoft Remote Desktop Services (RDS) technology to serve multiple instances of the EWS as thin clients from a single server. Thin clients can run applications and process data on a remote computer. The recommended limit is five RDS client connections per AppServ-EWS.

**Table 24.1 - AppServ-EWS Virtual Requirements**

Category	Description <sup>(1)</sup>
Virtual Infrastructure	Required: 4 vCPU 8 GB vRAM min Recommended CPU and memory allocation: Normal priority Resource pool
Thin client	We recommend a maximum of five FactoryTalk View SE clients per application server.
Operating system	Windows Server 2012 R2 operating system, 64 bit

(1) All numbers and figures are referenced for initial sizing only. The values can be adjusted for system performance if needed.

**Table 24.2 - AppServ-EWS Automation System Software and License**

Category	Cat. No.	Description
Virtual Image Template	Select one per project of the following if using virtualization and virtual image templates: <ul style="list-style-type: none"> <li>9528-APPXWSQENM</li> <li>9528-APPXWSENM (if using Microsoft volume licensing)</li> </ul>	USB device contains a virtual image template that has pre-installed all applications that are required on the EWS.  See <a href="#">Table 6 on page 14</a> for template details.
Rockwell Automation software license <b>IMPORTANT:</b> Microsoft and Rockwell Automation licensing has to be per EWS client, not per AppServ-EWS. Each client needs its own licenses.	For each AppServ-EWS: 9528-EWSLICENE <sup>(1)</sup>	Software activation license for the EWS for virtual and traditional environments.

(1) This EWS software license is equivalent to a FactoryTalk View Studio license (9701-VWSTENE) and Studio 5000 Logix Designer Application license (9324-RLD700NXENE). You can use the PlantPAx or FactoryTalk View Studio and Logix Designer Application licenses with the EWS.



## Operator Workstation (OWS)

The operator workstation (OWS) provides the graphical view and interface into the process. The OWS supports operator interaction and is not meant to support development or maintenance activities, although these activities are possible if desired.

**Table 25.1 - OWS Virtual Requirements**

Category	Requirement <sup>(1)</sup>
Virtual infrastructure	Required: <ul style="list-style-type: none"> <li>• 1 vCPU</li> <li>• 2 GB vRAM min</li> </ul> Recommended CPU and memory allocation: <ul style="list-style-type: none"> <li>• High priority Resource pool<sup>(2)</sup></li> </ul>
Operating system	Windows 8.1 operating system, 64 bit
Additional third-party software	Antivirus software <sup>(3)</sup>

(1) All numbers and figures are referenced for initial sizing only. The values can be adjusted for system performance if needed.

(2) See the PlantPAx Distributed Control System Reference Manual, publication [PROCES-RM001](#), for Resource Pool Allocation.

(3) Rockwell Automation has tested the use of Symantec Endpoint Protection. For more information, see Knowledgebase Answer ID 35330 at <http://www.rockwellautomation.custhelp.com>.

**Table 25.2 - OWS Traditional Requirements**

Category	Requirement
Traditional infrastructure	The OWS must be installed on workstation-class hardware. The following are sample specifications based on PlantPAx system characterization: <ul style="list-style-type: none"> <li>• Intel Core 2 Duo</li> <li>• 2.40 GHz CPU</li> <li>• 2 GB RAM min</li> <li>• Ethernet card that supports redundant media if NIC-teaming is used (If you plan to use a motherboard-NIC make sure that it supports redundant media)</li> </ul>
Operating system	Windows 8.1 operating system, 64 bit
Additional third-party software	Antivirus software <sup>(1)</sup>

(1) Rockwell Automation has tested the use of Symantec Endpoint Protection. For more information, see Knowledgebase Answer ID 35330 at <http://www.rockwellautomation.custhelp.com>.

On an OWS, you can run multiple screens. Each screen impacts the data server and controller loading.

**Table 25.3 - OWS Automation System Software and License**

Category	Cat. No.	Description
Virtual image template	Select one per project of the following if using virtualization and virtual image templates: <ul style="list-style-type: none"> <li>• 9528-PAXVTOENM</li> <li>• 9528-PAXVTENM (if using Microsoft volume licensing)</li> </ul>	USB device contains a virtual image template that has pre-installed all applications that are required on the OWS. See <a href="#">Table 6 on page 14</a> for template details.
Rockwell Automation software license	For each OWS: 9528-OWSLICENE <sup>(1)</sup>	Software activation license for the OWS for virtual and traditional environments.

(1) This PlantPAx software license is equivalent to a FactoryTalk View SE Client license (9701-VWSCWAENE). You can use either a PlantPAx or FactoryTalk View SE software license with the OWS.

## Operator Workstation Application Server (AppServ-OWS)

The AppServ-OWS uses Microsoft Remote Desktop Services (RDS) technology to serve multiple instances of the OWS as thin clients from a single server. Thin clients can run applications and process data on a remote computer to minimize the amount of information on a network. The AppServ-OWS is only configured to run FactoryTalk View SE clients and the recommended limit is 10 clients per application server.

**Table 26.1 - AppServ-OWS Virtual Requirements**

Category	Requirement <sup>(1)</sup>
Virtual infrastructure	Required: <ul style="list-style-type: none"> <li>• 4 vCPU</li> <li>• 8 GB vRAM min</li> </ul> Recommended CPU and memory allocation: <ul style="list-style-type: none"> <li>• High priority Resource pool<sup>(2)</sup></li> </ul>
Operating system	Windows Server 2012 R2 operating system, 64 bit
Thin client	We recommend a maximum of 10 FactoryTalk View SE clients per application server.
Additional third-party software	Microsoft Internet Explorer™ Antivirus software <sup>(3)</sup>

(1) All numbers and figures are referenced for initial sizing only. The values can be adjusted for system performance if needed.

(2) See the PlantPAx Distributed Control System Reference Manual, publication [PROCES-RM001](#), for Resource Pool Allocation.

(3) Rockwell Automation has tested the use of Symantec Endpoint Protection. For more information, see Knowledgebase Answer ID 35330 at <http://www.rockwellautomation.custhelp.com>.

**Table 26.2 - AppServ-OWS Automation System Software and License**

Category	Cat. No.	Description
Virtual image template	Select one per project of the following if using virtualization and virtual image templates: <ul style="list-style-type: none"> <li>• 9528-APPXWSOENM</li> <li>• 9528-APPXWSENEM (if using Microsoft volume licensing)</li> </ul>	USB device contains a virtual template for the AppServ-OWS.  See <a href="#">Table 6 on page 14</a> for template details.
Rockwell Automation software license <b>IMPORTANT:</b> Client license has to be per OWS client, not per AppServ-OWS.	For each client that the AppServ-OWS serves: 9528-OWSLICENE <sup>(1)</sup>	Software activation license for the OWS client that is being served by the AppServ-OWS (up-to 10 per server).

(1) This PlantPAx software license is equivalent to a FactoryTalk View SE Client license (9701-VWSCWAENE). You can use either a PlantPAx or FactoryTalk View SE software license with the OWS.

## Independent Workstation (IndWS)

The independent workstation (IndWS) combines the roles of the PASS, EWS, and OWS in one computer. This workstation, which is also referred to as a network station, is a client machine that is connected to a server and can be used as a 'shadow system' for emergency purposes.

**Table 27.1 - IndWS Traditional Requirements**

Category	Requirement
Traditional infrastructure	The IndWS must be installed on workstation-class hardware. The following are sample specifications based on PlantPAx system characterization: <ul style="list-style-type: none"> <li>• Intel Core 2 Duo</li> <li>• 2.40 GHz CPU</li> <li>• 8 GB RAM</li> <li>• Ethernet card that supports redundant media if NIC-teaming is used (If you plan to use a motherboard-NIC make sure that it supports redundant media)</li> </ul>
Operating system	Windows 8.1 operating system, 64 bit
Additional third-party software	Antivirus software <sup>(1)</sup>

(1) Rockwell Automation has tested the use of Symantec Endpoint Protection. For more information, see Knowledgebase Answer ID 35330 at <http://www.rockwellautomation.custhelp.com>.

**Table 27.2 - IndWS Automation System Software and Licenses**

Category	Cat. No.	Description
PlantPAx software	One per IndWS if being used as EWS: 9324-RLD700NXENE	Studio 5000 Logix Designer Professional Edition, English version
Rockwell Automation software licenses	Select one of the following: <ul style="list-style-type: none"> <li>• 9701-VWSB100ENE</li> <li>• 9701-VWSB250ENE</li> <li>• 9701-VWSB000AENE</li> </ul>	Number of displays: <ul style="list-style-type: none"> <li>• 100 display license with FactoryTalk View SE network station</li> <li>• 250 display license with FactoryTalk View SE network station</li> <li>• Unlimited display license with FactoryTalk View SE network station</li> </ul>

## Information Management Application Server (AppServ-Info)

Information management application servers (AppServ-Info) represent a broad category of servers and software that provide value to the PlantPAx system, offering data management and decision support functionalities. This section outlines various options available to meet the needs of your system.

Except where specifically noted, all options that are listed must be installed on their own servers to maximize performance. While it is possible to install data management (Table 28) and decision support (Table 29) software on the same server for small scale applications, it is not recommended.

Data management solutions can contain chassis-based and server-based historian systems.

**Table 28 - Data Management Options**

Category	Requirement	Option
Time series	<ul style="list-style-type: none"> <li>High-speed, On-Machine™ data collection</li> <li>&lt; 2500 tags</li> </ul>	<p>Information Management server is optional because you can use an embedded historian module for the ControlLogix chassis (FactoryTalk Historian Machine Edition). If the historian ME module is collecting 2500 points per second, select one of the following depending on how long it takes for the onboard memory to become full:</p> <ul style="list-style-type: none"> <li>1756-HIST1G (1 GB) = 4 hours</li> <li>1756-HIST2G (2 GB) = 14 hours</li> </ul> <p>FactoryTalk Historian ME can also be accessed directly by various decision support tools (FactoryTalk VantagePoint, ProcessBook, and TrendX - View SE software, version 7.0 and later). FactoryTalk Historian ME is compatible with FactoryTalk Historian Site Edition software, which lets the module offload and forward that data. In the event that no Historian Site Edition server is provided, the Continuous data buffer can be configured to overwrite oldest data, or stop data collection when it reaches storage capacity.</p>
	<ul style="list-style-type: none"> <li>Longer term data storage</li> <li>&gt; 2500 tags</li> </ul>	<p>An Information Management server is required with FactoryTalk Historian SE software, which is a scalable process historian that provides real-time access to information:</p> <ul style="list-style-type: none"> <li>Provides data capture, management, and analytical capabilities to support decision-making</li> <li>Auto Discovery and Auto Configuration features reduce deployment time and lower total cost of ownership</li> </ul>
Event based	Relational database	<p>An additional AppServ-Info server can be considered for the storage of transactional data. You can select a Microsoft SQL server database to act as the central collection point for event-based data:</p> <ul style="list-style-type: none"> <li>FactoryTalk Alarm and Event data<sup>(1)</sup></li> <li>FactoryTalk Batch data</li> </ul> <p>This can be installed on an Information Management server or another server on your system.</p>

(1) For more information, see Knowledgebase Answer ID 48313 at <http://www.rockwellautomation.custhelp.com>.

Decision support strategies incorporate the tools described in Table 29.

**Table 29 - Decision Support Options**

Category	Description
FactoryTalk VantagePoint software	<p>An Information Management server is required to host this web-based reporting software that brings all data together into a single decision-support system:</p> <ul style="list-style-type: none"> <li>All manufacturing data is accessible in real time</li> <li>Published reports, current dashboards, and real-time KPIs viewable via web browser</li> <li>Pre-configured reports, trends, and dashboards</li> <li>Enhanced HMI trending available by using FactoryTalk VantagePoint Trend Active X within FactoryTalk View SE</li> </ul>
FactoryTalk Historian ProcessBook software	<p>An Information Management server is required to enable ProcessBook content (standard ProcessBook displays, SQC view, batch view, alarm view). The content is to be hosted and displayed from within FactoryTalk View SE by using the ProcessBook Runtime.</p>

We recommend that you host FactoryTalk Historian and FactoryTalk VantagePoint applications on separate information management servers. The same server requirements apply for each server.

See Knowledgebase Answer ID 62869 at <http://www.rockwellautomation.custhelp.com> for guidance on whether one or more servers are required.

## AppServ-Info (Historian)

One of the ways to configure the AppServ-Info is as a historian to collect data. Follow these guidelines if you are adding a Historian server to your PlantPAX system..

**Table 30.1 - AppServ-Info (Historian) Virtual Requirements**

Category	Requirement <sup>(1)</sup>
Virtual infrastructure	Required: <ul style="list-style-type: none"> <li>• 2 vCPU</li> <li>• 4 GB vRAM min</li> </ul> Recommended CPU and memory allocation: <ul style="list-style-type: none"> <li>• Normal priority Resource pool<sup>(2)</sup></li> </ul>
Operating system	Windows Server 2012 R2 operating system, 64 bit <sup>(3)</sup>
Additional third-party software	Antivirus software <sup>(4)</sup>

(1) All numbers and figures are referenced for initial sizing only. The values can be adjusted for system performance if needed.

(2) See the PlantPAX Distributed Control System Reference Manual, publication [PROCES-RM001](#), for Resource Pool Allocation.

(3) To install FactoryTalk View SE Historian software, version 4.0, with Windows Server 2012, you must install a patch from the Product Compatibility and Download Center at <http://www.rockwellautomation.com/rockwellautomation/support/pcdc.page>.

(4) Rockwell Automation has tested the use of Symantec Endpoint Protection. For more information, see Knowledgebase Answer ID 35330 at <http://www.rockwellautomation.custhelp.com>.

**Table 30.2 - AppServ-Info (Historian) Traditional Requirements**

Category	Requirement
Traditional infrastructure	The Information Management server must be installed on server-class hardware: <ul style="list-style-type: none"> <li>• Intel Xeon Multicore processor (4 cores or greater)</li> <li>• 2.40 GHz CPU</li> <li>• 4 GB RAM min</li> <li>• Ethernet card that supports redundant media if NIC-teaming is used (If you plan to use a motherboard-NIC make sure that it supports redundant media)</li> </ul>
Operating system	Windows Server 2012 R2 operating system, 64 bit <sup>(1)</sup>
Additional third-party software	Antivirus software <sup>(2)</sup>

(1) To install FactoryTalk View SE Historian software, version 4.0, with Windows server 2012, you must install a patch from the Product Compatibility and Download Center at <http://www.rockwellautomation.com/rockwellautomation/support/pcdc.page>

(2) Rockwell Automation has tested the use of Symantec Endpoint Protection. For more information, see Knowledgebase Answer ID 35330 at <http://www.rockwellautomation.custhelp.com>.

**Table 30.3 - AppServ-Info (Historian) Software**

Category	Requirement	Description
Virtual image template	Select one per project of the following if using virtualization and virtual image templates: <ul style="list-style-type: none"> <li>• 9528-APPHISOENM</li> <li>• 9528-APPXWSENEM (if using Microsoft volume licensing)</li> </ul>	USB device contains a virtual template for the AppServ-Info (Historian).  See <a href="#">Table 6 on page 14</a> for template details.

**Table 30.4 - FactoryTalk Historian Licenses**

Category	Cat. No. <sup>(1)</sup> <sup>(2)</sup>	Description
FactoryTalk Historian software includes a FactoryTalk VantagePoint software license and one named user client. The number of users is cumulative, and can be a mixed number of named users and concurrent users. If you choose concurrent on the PSE, you must purchase a license for the server based on the number of active CPUs on the server.		
Virtual server license <sup>(3)</sup>	Select one of the licenses: <ul style="list-style-type: none"> <li>• 9528-HSE250M</li> <li>• 9528-HSE500M</li> <li>• 9528-HSE1KM</li> <li>• 9528-HSE2K5M</li> <li>• 9528-HSE5KM</li> <li>• 9528-HSE10KM</li> <li>• 9528-HSE20KM</li> <li>• 9528-HSE50KM</li> <li>• 9528-HSE100KM</li> </ul>	<ul style="list-style-type: none"> <li>• 250 tags</li> <li>• 500 tags</li> <li>• 1000 tags</li> <li>• 2500 tags</li> <li>• 5000 tags</li> <li>• 10,000 tags</li> <li>• 20,000 tags</li> <li>• 50,000 tags</li> <li>• 100,000 tags</li> </ul>
ProcessBook	Select for each client that is using ProcessBook: <ul style="list-style-type: none"> <li>• 9518-HPBENM</li> <li>• 9518-HPBENFM</li> </ul>	<ul style="list-style-type: none"> <li>• FactoryTalk Historian ProcessBook - Single User</li> <li>• FactoryTalk Historian ProcessBook - Concurrent User</li> </ul>
Excel Add-in	Select the following: <ul style="list-style-type: none"> <li>• 9518-HDLENM</li> <li>• 9518-HDLENFM</li> </ul>	<ul style="list-style-type: none"> <li>• FactoryTalk Historian DataLink Excel Add in - Single User</li> <li>• FactoryTalk Historian DataLink Excel Add in - Concurrent User</li> </ul>

(1) English version is listed. Different languages are available by contacting your local Allen-Bradley distributor or Rockwell Automation sales representative.  
 (2) If you plan to use redundant Historian for high availability, you must duplicate the number of licenses. Licenses on the backup Historian must mirror the licenses on the primary Historian.  
 (3) The Virtual server software licenses are equivalent to FactoryTalk Historian licenses that start with 9518. You can use a virtual server or a FactoryTalk Historian software license with a Historian system element.

## AppServ-Info (VantagePoint)

AppServ-Info can be configured as a decision support tool by using VantagePoint software.

**Table 31.1 - AppServ-Info (VantagePoint) Virtual Requirements**

Category	Requirement <sup>(1)</sup>
Virtual infrastructure	Required: <ul style="list-style-type: none"> <li>• 2 vCPU</li> <li>• 4 GB vRAM min</li> </ul> Recommended CPU and memory allocation: <ul style="list-style-type: none"> <li>• Normal priority Resource pool<sup>(2)</sup></li> </ul>
Operating system	Windows Server 2012 R2 operating system, 64 bit
Additional third-party software	Antivirus software <sup>(3)</sup>

(1) All numbers and figures are referenced for initial sizing only. The values can be adjusted for system performance if needed.

(2) See the PlantPAx Distributed Control System Reference Manual, publication [PROCES-RM001](#), for Resource Pool Allocation.

(3) Rockwell Automation has tested the use of Symantec Endpoint Protection. For more information, see Knowledgebase Answer ID 35330 at <http://www.rockwellautomation.custhelp.com>.

**Table 31.2 - AppServ-Info (VantagePoint) Traditional Requirements**

Category	Requirement
Traditional infrastructure <sup>(1)</sup>	The Information Management server must be installed on server-class hardware: <ul style="list-style-type: none"> <li>• Intel Xeon Multicore processor (4 cores or greater)</li> <li>• 2.40 GHz CPU</li> <li>• 4 GB RAM min</li> <li>• Ethernet card that supports redundant media if NIC-teaming is used (If you plan to use a motherboard-NIC make sure that it supports redundant media)</li> </ul>
Operating system	Windows Server 2012 R2 operating system, 64 bit
Additional third-party software	Antivirus software <sup>(2)</sup>

(1) A Microsoft Excel software license is required.

(2) Rockwell Automation has tested the use of Symantec Endpoint Protection. For more information, see Knowledgebase Answer ID 35330 at <http://www.rockwellautomation.custhelp.com>.

**Table 31.3 - AppServ-Info (VantagePoint) Software**

Category	Requirement	Description
Virtual image template	Select one per project of the following if using virtualization and virtual image templates: <ul style="list-style-type: none"> <li>• 9528-APPVTP0ENM</li> <li>• 9528-APPVTPENM (if using Microsoft volume licensing)</li> </ul>	USB device contains a virtual template for the AppServ-Info (VantagePoint).  See <a href="#">Table 6 on page 14</a> for template details.

Use the following licensing considerations when configuring AppServ-Info with VantagePoint software.

**Table 31.4 - FactoryTalk VantagePoint Licenses**

Category	Cat. No. <sup>(2)</sup>	Description
FactoryTalk VantagePoint software licenses consist of user clients. The number of users is cumulative, and can be a mixed number of named users and concurrent users. If you choose concurrent on the PSE, you must purchase a license for the server based on the number of active CPUs on the server.		
Virtual server license <sup>(1)</sup>	Select the following: 9528-VPSEVERENM	FactoryTalk VantagePoint EMI server software

**Table 31.4 - FactoryTalk VantagePoint Licenses**

Category	Cat. No. <sup>(2)</sup>	Description
FactoryTalk VantagePoint software licenses consist of user clients. The number of users is cumulative, and can be a mixed number of named users and concurrent users. If you choose concurrent on the PSE, you must purchase a license for the server based on the number of active CPUs on the server.		
Virtual server named user licenses <sup>(1)</sup>	Select one or more of the following for FactoryTalk VantagePoint Client named users: <ul style="list-style-type: none"> <li>• 9528-VPCL01ENM</li> <li>• 9528-VPCL03ENM</li> <li>• 9528-VPCL05ENM</li> <li>• 9528-VPCL010ENM</li> <li>• 9528-VPCL025ENM</li> <li>• 9528-VPCL050ENM</li> </ul>	<ul style="list-style-type: none"> <li>• 1 named user</li> <li>• 3 named users</li> <li>• 5 named users</li> <li>• 10 named users</li> <li>• 25 named users</li> <li>• 50 named users</li> </ul>
	Select one or more of the following for FactoryTalk VantagePoint Client concurrent users: <ul style="list-style-type: none"> <li>• 9528-VPNLO1ENM</li> <li>• 9528-VPNLO3ENM</li> <li>• 9528-VPNLO5ENM</li> <li>• 9528-VPNLO10ENM</li> <li>• 9528-VPNLO25ENM</li> <li>• 9528-VPNLO50ENM</li> </ul>	<ul style="list-style-type: none"> <li>• 1 concurrent user</li> <li>• 3 concurrent users</li> <li>• 5 concurrent users</li> <li>• 10 concurrent users</li> <li>• 25 concurrent users</li> <li>• 50 concurrent users</li> </ul>
Virtual server concurrent user licenses <sup>(1)</sup>	If VantagePoint is being used for concurrent users, select one for each CPU of the hosting server: 9528-VPCCPENM	FactoryTalk VantagePoint Concurrent User CPU License (per CPU)
Virtual server data connector licenses <sup>(1)</sup>	Select the following: <ul style="list-style-type: none"> <li>• 9528-VPHSCENM</li> <li>• 9528-VPRTCENM</li> </ul>	<ul style="list-style-type: none"> <li>• FactoryTalk VantagePoint 3rd Party Historian Connector</li> <li>• FactoryTalk VantagePoint 3rd Party Real-time Connector</li> </ul>

(1) The Virtual server software licenses are equivalent to FactoryTalk Historian licenses that start with 9521. You can use a virtual server or a FactoryTalk Historian software license with a Historian system element.

(2) English version is listed. Different languages are available by contacting your local Allen-Bradley distributor or Rockwell Automation sales representative.



## AppServ-Info (SQL)

Another way to configure AppServ-Info is as an SQL server. Software such as FactoryTalk AssetCentre, FactoryTalk VantagePoint, and FactoryTalk Batch use an SQL database to store and access process data. Additionally, the FactoryTalk Alarm and Event server uses an SQL database to store information.

**Table 32.1 - AppServ-Info (SQL) Virtual Requirements**

Category	Requirement <sup>(1)</sup>
Virtual infrastructure	Required: <ul style="list-style-type: none"> <li>• 2 vCPU</li> <li>• 4 GB vRAM min</li> </ul> Recommended CPU and memory allocation: <ul style="list-style-type: none"> <li>• Normal priority Resource pool<sup>(2)</sup></li> </ul>
Operating system	Windows Server 2012 R2 operating system, 64 bit
Additional third-party software	Antivirus software <sup>(3)</sup>

(1) All numbers and figures are referenced for initial sizing only. The values can be adjusted for system performance if needed.

(2) See the PlantPAx Distributed Control System Reference Manual, publication [PROCES-RM001](#), for Resource Pool Allocation.

(3) Rockwell Automation has tested the use of Symantec Endpoint Protection. For more information, see Knowledgebase Answer ID 35330 at <http://www.rockwellautomation.custhelp.com>.

**Table 32.2 - AppServ-Info (SQL) Traditional Requirements**

Category	Requirement
Traditional infrastructure <sup>(1)</sup>	The Information Management server must be installed on server-class hardware: <ul style="list-style-type: none"> <li>• Intel Xeon Multicore processor (4 cores or greater)</li> <li>• 2.40 GHz CPU</li> <li>• 4 GB RAM min</li> <li>• Ethernet card that supports redundant media if NIC-teaming is used (If you plan to use a motherboard-NIC make sure that it supports redundant media)</li> </ul>
Operating system	Windows Server 2012 R2 operating system, 64 bit
Additional third-party software	Antivirus software <sup>(2)</sup>

(1) A Microsoft Excel software license is required.

(2) Rockwell Automation has tested the use of Symantec Endpoint Protection. For more information, see Knowledgebase Answer ID 35330 at <http://www.rockwellautomation.custhelp.com>.

**Table 32.3 - AppServ-Info (SQL) Software**

Category	Requirement	Description
Virtual image template	Select one per project of the following if using virtualization and virtual image templates: <ul style="list-style-type: none"> <li>• 9528-APPSQLOENM</li> <li>• 9528-APPSQLENM (if using Microsoft volume licensing)</li> </ul>	USB device contains a virtual template for the AppServ-Info (SQL).  See <a href="#">Table 6 on page 14</a> for template details.

The SQL Server is licensed in one of two ways: Server+CAL licensing, or Core-based license. 'CAL' is an abbreviation for client access license. Server+CAL licensing is recommended for fewer clients. Every additional client requires a CAL license. Core-based licensing provides unlimited number of CALs. The 4-Core license is required to add additional 2-Core licenses.

**Table 32.4 - FactoryTalk SQL Server Licenses**

Category	Cat. No. <sup>(2)</sup>	Description
Virtual server licenses <sup>(1)</sup>	Select one of the following: <ul style="list-style-type: none"> <li>• 9528-DBSVRCALENM</li> <li>• 9528-DBADCALENE</li> <li>• 9528-DBCOR4ENM</li> <li>• 9528-DBADCOR2ENE</li> </ul>	<ul style="list-style-type: none"> <li>• FactoryTalk Database License 1 Server and 1 Client Access License (CAL)</li> <li>• FactoryTalk Database License 1 CAL</li> <li>• 4 Cores (unlimited CALs)</li> <li>• 2 Cores (unlimited CALs)</li> </ul>

(1) The Virtual server software licenses are equivalent to FactoryTalk Database licenses that start with 9319. You can use a virtual server or a FactoryTalk Database software license with a SQL server system element.

(2) English version is listed. Different languages are available by contacting your local Allen-Bradley distributor or Rockwell Automation sales representative.

## Asset Management Server (AppServ-Asset)

An asset management server (AppServ-Asset) is an extension to the PlantPAx system that adds maintenance and plant operations to the system. This server provides controller data backup for disaster recovery, diagnostics, calibration, real-time monitoring, as well as auditing equipment and network health to improve overall resource availability.

The asset management server provides centralized system management for Rockwell Automation and third-party field assets.

**Table 33.1 - AppServ-Asset Virtual Requirements**

Category	Requirement <sup>(1)</sup>
Virtual infrastructure	Required: <ul style="list-style-type: none"> <li>• 2 vCPU</li> <li>• 4 GB vRAM min</li> </ul> Recommended CPU and memory allocation: <ul style="list-style-type: none"> <li>• Normal priority Resource pool<sup>(2)</sup></li> </ul>
Operating system	Windows Server 2012 R2 operating system, 64 bit
Additional third-party software	Antivirus software <sup>(3)</sup>

(1) All numbers and figures are referenced for initial sizing only. The values can be adjusted for system performance if needed.

(2) See the PlantPAx Distributed Control System Reference Manual, publication [PROCES-RM001](#), for Resource Pool Allocation.

(3) Rockwell Automation has tested the use of Symantec Endpoint Protection. For more information, see Knowledgebase Answer ID 35330 at <http://www.rockwellautomation.custhelp.com>.

**Table 33.2 - AppServ-Asset Traditional Requirements**

Category	Requirement
Traditional infrastructure	The Asset Management server must be installed on server-class hardware: <ul style="list-style-type: none"> <li>• Intel Xeon Multicore processor (4 cores or greater)</li> <li>• 2.40 GHz CPU</li> <li>• 4 GB RAM min</li> <li>• Ethernet card that supports redundant media if NIC-teaming is used (If you plan to use a motherboard-NIC make sure that it supports redundant media)</li> </ul>
Operating system	Windows Server 2012 R2 operating system, 64 bit
Additional third-party software	Antivirus software <sup>(1)</sup>

(1) Rockwell Automation has tested the use of Symantec Endpoint Protection. For more information, see Knowledgebase Answer ID 35330 at <http://www.rockwellautomation.custhelp.com>.

**Table 33.3 - AppServ-Asset Software**

Category	Requirement	Description
Virtual image template	Select one per project of the following if using virtualization and virtual image templates: <ul style="list-style-type: none"> <li>• 9528-APPASMOENM</li> <li>• 9528-APPASMENM (if using Microsoft volume licensing)</li> </ul>	USB device contains a virtual template for the AppServ-Asset.  See <a href="#">Table 6 on page 14</a> for template details.

**Table 33.4 - AppServ-Asset Server Software and Licenses**

Category	Cat. No. <sup>(1)</sup>	Description
Virtual server licenses <sup>(2)</sup>	The following is required to include any option below: 9528-ASTSRVRENM	FactoryTalk AssetCentre server software
Virtual server asset licenses <sup>(2)</sup>	Select one or more of the following so that the sum of licenses is equal to or greater than the number of assets that is to be managed by the Asset Management server: <ul style="list-style-type: none"> <li>• 9528-ASTCAP0005M</li> <li>• 9528-ASTCAP0025M</li> <li>• 9528-ASTCAP0100M</li> <li>• 9528-ASTCAP0500M</li> <li>• 9528-ASTCAP1000M</li> <li>• 9528-ASTCAP5000M</li> </ul>	<ul style="list-style-type: none"> <li>• 5 additional assets</li> <li>• 25 additional assets</li> <li>• 100 additional assets</li> <li>• 500 additional assets</li> <li>• 1000 additional assets</li> <li>• 5000 additional assets</li> </ul>
Virtual server process device licenses <sup>(2)</sup>	If process device configuration is to be used, select the following: 9528-ASTPRDCFENM	FactoryTalk AssetCentre process device configuration
Virtual server disaster recovery licenses <sup>(2)</sup>	If disaster recovery is to be used, select all of the following: <ul style="list-style-type: none"> <li>• 9528-ASTDRROKENM</li> <li>• 9528-ASTDRRCENM</li> </ul>	<ul style="list-style-type: none"> <li>• Disaster recovery for Rockwell Automation</li> <li>• Disaster recovery for remote computers</li> </ul>
Virtual server calibration licenses <sup>(2)</sup>	If calibration management is to be used, the first license is required and the remainder are optional: <ul style="list-style-type: none"> <li>• 9528-ASTCLMANENM</li> <li>• 9528-ASTCLWRKENEM</li> <li>• 9528-ASTCLFLKENM</li> </ul>	<ul style="list-style-type: none"> <li>• FactoryTalk AssetCentre calibration management</li> <li>• FactoryTalk AssetCentre calibration management remote workstation</li> <li>• FactoryTalk AssetCentre calibration management FLUKE documenting calibration</li> </ul>

(1) Additional licenses are available for disaster recovery and calibration management. English version is listed. Different languages are available by contacting your local Allen-Bradley distributor or Rockwell Automation sales representative.

(2) The Virtual server software licenses are equivalent to FactoryTalk AssetCentre licenses that start with 9515. You can use a virtual server or a FactoryTalk AssetCentre software license with an Asset Management system element.

## Batch Management Server (AppServ-Batch)

The batch management server (AppServ-Batch) offers equipment-independent recipe management, batch-independent equipment control, and regulatory compliance. System size varies from small to large and system requirements vary from simple to complex.

Basic solutions provide capabilities for small or simple systems to use core system functions, including Logix5000™ controllers and FactoryTalk View HMI. Generally these solutions do not need the functionality provided by server-based FactoryTalk Batch software solutions. Comprehensive solutions provide capability for large or complex systems to use modular software components. This solution includes FactoryTalk Batch software, eProcedure® software, and Material Manager software.

You need a batch server when any of the following apply for your system:

- Equipment allocation and arbitration
- Complex recipes (product recipes with loops, branches, and transitions; phases with more than four inputs and four outputs)
- Multiple unit coordination (product is made across multiple, coordinated units)
- More than 32 recipes
- String values or numeration-required for parameter and report values
- Number of parameters or report values required by phase > 4
- Require class-based recipes
- Manual and electronic work instructions (web-based instructions, embedded pictures, video)
- Material management (materials, containers, lots, locations, and inventory tracking).

**Table 34.1 - AppServ-Batch Virtual Requirements**

Category	Requirement <sup>(1)</sup>
Virtual infrastructure	Required: <ul style="list-style-type: none"> <li>• 2 vCPU</li> <li>• 4 GB vRAM min</li> </ul> Recommended CPU and memory allocation: <ul style="list-style-type: none"> <li>• Normal priority Resource pool<sup>(2)</sup></li> </ul>
Operating system	Windows Server 2012 R2 operating system, 64 bit
Additional third-party software	Antivirus software <sup>(3)</sup>

(1) All numbers and figures are referenced for initial sizing only. The values can be adjusted for system performance if needed.

(2) See the PlantPAx Distributed Control System Reference Manual, publication PROCES-RM001, for Resource Pool Allocation.

(3) Rockwell Automation has tested the use of Symantec Endpoint Protection. For more information, see Knowledgebase Answer ID 35330 at <http://www.rockwellautomation.custhelp.com>.

**Table 34.2 - AppServ-Batch Traditional Requirements**

Category	Requirement
Traditional infrastructure	The Batch Management server must be installed on server-class hardware: <ul style="list-style-type: none"> <li>• Intel Xeon Multicore processor (4 cores or greater)</li> <li>• 2.40 GHz CPU</li> <li>• 4 GB RAM min</li> <li>• Ethernet card that supports redundant media if NIC-teaming is used (If you plan to use a motherboard-NIC make sure that it supports redundant media)</li> </ul>
Operating system	Windows Server 2012 R2 operating system, 64 bit
Additional third-party software	Antivirus software <sup>(1)</sup>

(1) Rockwell Automation has tested the use of Symantec Endpoint Protection. For more information, see Knowledgebase Answer ID 35330 at <http://www.rockwellautomation.custhelp.com>.

**Table 34.3 - AppServ-Batch Software**

Category	Requirement	Description
Virtual image template	Select one per project of the following if using virtualization and virtual image templates: <ul style="list-style-type: none"> <li>9528-APPBATOENM</li> <li>9528-APPBATENM (if using Microsoft volume licensing)</li> </ul>	USB device contains a virtual template for the AppServ-Asset. See <a href="#">Table 6 on page 14</a> for template details.

**Table 34.4 - Batch Management Server Licenses**

Category	Cat. No.	Description
Batch unit software licenses	Purchase multiple licenses to obtain the desired number of batch units. For example, purchase 3 licenses if you have 100 units on a single batch unit - - 1 license with 10 units, 1 license for 30 units, and 1 license for 60 units: <ul style="list-style-type: none"> <li>9358-FTB01ENM</li> <li>9358-FTB03ENM</li> <li>9358-FTB10ENM</li> <li>9358-FTB30ENM</li> <li>9358-FTB60ENM</li> </ul>	<ul style="list-style-type: none"> <li>FactoryTalk Batch - 1 unit</li> <li>FactoryTalk Batch - 3 units</li> <li>FactoryTalk Batch - 10 units</li> <li>FactoryTalk Batch - 30 units</li> <li>FactoryTalk Batch - 60 units</li> </ul>
Batch backup software licenses	If a back-up server is enabled on the PlantPAX System Estimator, an additional server is added to the BOM with an equal number of back-up server unit licenses. These are license options: <ul style="list-style-type: none"> <li>9358-FTBKY01ENM</li> <li>9358-FTBKY03ENEM</li> <li>9358-FTBKY10ENM</li> <li>9358-FTBKY30ENM</li> <li>9358-FTBKY60ENM</li> </ul>	<ul style="list-style-type: none"> <li>FactoryTalk Batch Back-up Key - 1 unit</li> <li>FactoryTalk Batch Back-up Key - 3 units</li> <li>FactoryTalk Batch Back-up Key - 10 units</li> <li>FactoryTalk Batch Back-up Key - 30 units</li> <li>FactoryTalk Batch Back-up Key - 60 units</li> </ul>
eProcedure® software licenses	If an eProcedure server is enabled on the PlantPAX System Estimator, an additional server is added to the BOM with an equal number of server unit licenses. These are license options: <ul style="list-style-type: none"> <li>9358-EPO3ENM</li> <li>9358-EP10ENM</li> <li>9358-EP30ENM</li> <li>9358-EP60ENM</li> </ul>	<ul style="list-style-type: none"> <li>FactoryTalk eProcedure - 3 units</li> <li>FactoryTalk eProcedure - 10 units</li> <li>FactoryTalk eProcedure - 30 units</li> <li>FactoryTalk eProcedure - 60 units</li> </ul>
eProcedure backup software licenses	If an eProcedure server is enabled on the PlantPAX System Estimator, an additional server is added to the BOM with an equal number of back-up server unit licenses. These are license options: <ul style="list-style-type: none"> <li>9358-EPBKY03ENM</li> <li>9358-EPBKY10ENM</li> <li>9358-EPBKY30ENM</li> <li>9358-EPBKY60ENM</li> </ul>	<ul style="list-style-type: none"> <li>FactoryTalk eProcedure Back-up Key - 3 units</li> <li>FactoryTalk eProcedure Back-up Key - 10 units</li> <li>FactoryTalk eProcedure Back-up Key - 30 units</li> <li>FactoryTalk eProcedure Back-up Key - 60 units</li> </ul>

## AppServ-Batch High Availability Options

Batch high availability options depend on the hardware and software options in the system:

- For the application server in a system where a bump in the process cannot be tolerated, FactoryTalk Batch software helps support a real-time, uninterrupted high availability option that leverages Stratix servers or VMware virtualization.
- Standard FactoryTalk Batch software supports a warm back-up option that allows a Batch server to start up and rebuild the active batches from the Event Journals and Logs and places them on the batch list in a held state. The primary server copies real-time data to the back-up server. On failure, the process goes to a controlled state. On restart of the back-up server, you clear the failure and the process resumes where it left off.
- A redundant ControlLogix system with PhaseManager™ software provides protection so that the control platform continues to execute during a hardware failure.
- If your system requirements include the batch not going to 'hold' on a controller switchover, the connection bridge (1756-CN2R) module between the component and a redundant chassis on the ControlNet network needs to be paired with a 1756-EN2TR bridge module to the EtherNet/IP network. If the batch going to 'hold' upon a controller switchover is acceptable, you can connect to the FactoryTalk Batch server directly from an EtherNet/IP module placed in the redundant chassis.

For an illustration, see Chapter 7 in the PlantPAx Distributed Control System Reference Manual, publication [PROCES-RM001](#).

## Domain Controller

A domain controller is a server that responds to security authentication requests (logging in, checking permissions, and so forth) within the Windows server domain. A domain grants you access to a number of network resources (such as applications and printers) with the use of a single user name and password combination. PlantPAx uses a domain controller to store user account information, authenticate users, and enforce security policies.

Domain authentication is recommended, whether it's an existing domain or a new one. Follow these guidelines for the domain controller:

- A domain controller is required if there are 10 or more workstations or servers.
- The domain controllers are separate computers. Do not load any application software on a domain controller. Load all system application software on the other computers, such as the PASS, application server, OWS, and EWS.
- Microsoft support does not recommend running applications on a domain controller, and not applications that require more than Authenticated User privileges to run.
- The domain controllers must be local to the system workstations and servers (within the local firewall) and not remote to the system.

**Table 35.1 - Domain Virtual Requirements**

Category	Requirement <sup>(1)</sup>
Virtual infrastructure	Required: <ul style="list-style-type: none"> <li>• 1 vCPU</li> <li>• 4 GB vRAM min</li> </ul> Recommended CPU and memory allocation: <ul style="list-style-type: none"> <li>• Low priority Resource pool<sup>(2)</sup></li> </ul>
Operating system	Windows Server 2012 R2 operating system, 64 bit
Additional third-party software	Antivirus software <sup>(3)</sup>

(1) All numbers and figures are referenced for initial sizing only. The values can be adjusted for system performance if needed.

(2) See the PlantPAx Distributed Control System Reference Manual, publication [PROCES-RM001](#), for Resource Pool Allocation.

(3) Rockwell Automation has tested the use of Symantec Endpoint Protection. For more information, see Knowledgebase Answer ID 35330 at <http://www.rockwellautomation.custhelp.com>.

**Table 35.2 - Domain Traditional Requirements**

Category	Requirement
Traditional infrastructure <sup>(1)</sup>	The Information Management server must be installed on server-class hardware: <ul style="list-style-type: none"> <li>• Intel Xeon Multicore processor (4 cores or greater)</li> <li>• 2.40 GHz CPU</li> <li>• 4 GB RAM min</li> <li>• Ethernet card that supports redundant media if NIC-teaming is used (If you plan to use a motherboard-NIC make sure it supports redundant media)</li> </ul>
Operating system	Windows Server 2012 R2 operating system, 64 bit
Additional third-party software	Antivirus software <sup>(2)</sup>

(1) A Microsoft Excel software license is required.

(2) Rockwell Automation has tested the use of Symantec Endpoint Protection. For more information, see Knowledgebase Answer ID 35330 at <http://www.rockwellautomation.custhelp.com>.

**Table 35.3 - Domain Software**

Category	Requirement	Description
Virtual image template	Select one per project of the following if using virtualization and virtual image templates: <ul style="list-style-type: none"> <li>• 9528-PAXVTOENM</li> <li>• 9528-PAXVTENM (if using Microsoft volume licensing)</li> </ul>	USB device contains a virtual template for the AppServ-Asset.  See <a href="#">Table 6 on page 14</a> for template details.

For redundancy purposes, we recommend that you use at least two domain controllers in the domain. These domain controllers replicate automatically to provide high availability and an online configuration backup.

For more domain recommendations, see the PlantPAx Distributed Control System Reference Manual, publication [PROCES-RM001](#).

Notes:



# Controllers, Field Networks, and I/O

This section describes controller elements, field devices, how to select appropriate I/O, how to determine I/O count, and basic sizing guidelines.

The optimal number of controllers for the PlantPAx system depends on the size of your application, physical layout of your plant, and the design of your process. Consider segregating non-related process equipment into separate controllers so that maintenance activities in one area do not impact the operation of another area.

Controllers are also capacity limited. This capacity can be roughly estimated based on I/O count, but also is greatly impacted by the design of your application. These limitations can include the amount of automation code required, the amount of information being read by supervisory applications, and the number of alarms in your system.

## Controller Sizing

The I/O count for controller sizing is often determined directly from the application P&ID or plant design. On existing systems where classic I/O is used only (for example, 4...20 mA, 24V DC dry contacts), the I/O count can be determined by the number of I/O channels available on the I/O cards.

When you have integrated smart devices, such as drives or transmitters on an EtherNet/IP network, any signal from the device used by your control strategy is considered an I/O point.

For example, an I/O count for a system comprised with the following:

- Two 8-channel 4...20 mA input cards
- One 8-channel 4...20 mA output cards
- Two 16-channel 24V DC dry-contact input cards
- One Motor Control Center (MCC) with six drives
  - Each drive provides six signals to the control strategy: speed reference, actual speed, start, stop, running, and fault
- Two Coriolis flowmeters on PROFIBUS PA, each providing three signals for flow, temperature, and density

We can roughly calculate the following I/O count for the example system:

$$4...20 \text{ mA AI} \quad 2 \times 8 = 16$$

$$4...20 \text{ mA AO} \quad 1 \times 8 = 8$$

$$24\text{V DC DI} \quad 2 \times 16 = 32$$

$$\text{MCC} \quad 6 \times 6 = 36 \text{ (6 AI, 6 AO, 12 DI, 12 DO)}$$

$$\text{Smart instruments} \quad 2 \times 3 = 6 \text{ (6 AI)}$$

$$\text{Controller I/O count} \quad \overline{98}$$

When considering I/O count by using the method as described, not all I/O points map to individual process objects (for example, P\_DIn, P\_AIn). For example, a P\_VSD object processes all of the I/O points associated with a variable speed drive. However, this I/O count method enables you to enter I/O counts into the PSE to determine an appropriate number of control strategy footprints to determine sizing.

Review controller sizing and then select from the following options:

- [Simplex Controllers](#)
- [Redundant Controllers](#)
- [Controllers for Skid-based Equipment](#)
- [I/O Products](#)
- [Process Network I/O](#)
- [Field Devices](#)

## Simplex Controllers

Non-redundant controllers are referred to as simplex controllers.

**Table 36 - Simplex Controller Hardware Requirements<sup>(1)</sup>**

Category	Cat. No.
Process controller <sup>(2)</sup>	ControlLogix 1756-L71, 1756-L72, 1756-L73, 1756-L74, or 1756-L75 controller
Ethernet interface	<ul style="list-style-type: none"> <li>1756-EN2TR, 1783-ETAP, 1783-ETAP1F, 1783-ETAP2F (supports device-level ring topology)</li> <li>1756-EN2T, 1756-ENBT, 1756-EWEB, 1756-EN2F</li> <li>1756-EN2TSC for supported secure connections</li> </ul>
ControlNet interface (if applicable)	<ul style="list-style-type: none"> <li>1756-CN2, 1756-CN2R</li> <li>1756-CNB, 1756-CNBR</li> </ul>

- (1) If environmental conditions warrant, you can use an extreme temperature controller, for example, the 1756-L74XT. Conformal coating options are also available for protection from harsh environments that can contain moisture and/or chemical contaminants.
- (2) As the PlantPAx system release 4.0 uses controller firmware revision 24, implementation requires use of the 1756-L7x controller family. PlantPAx system release 4.0 can co-exist with older generation controllers, such as the 1756-L6x.

**Table 37 - Simplex ControlLogix Controller Sizing**

Category <sup>(1)</sup>	1756-L71	1756-L72	1756-L73	1756-L74	1756-L75 <sup>(2)</sup>
User memory	2 MB	4 MB	8 MB	16 MB	32 MB
Total I/O recommended, max	375	750	1500	2250	2250
Recommended control strategies, max <sup>(3)</sup>	60	125	250	450	450
Total control strategies @ 250 ms, max	60	125	250	250	250
Total control strategies @ 500 ms, max	60	125	250	450	450
Tags/sec delivered to data server, max	10,000	20,000	20,000	20,000	20,000

- (1) These values are recommended maximum limits. It's possible that achieving all of these values in a single controller is not doable. For more detailed sizing, you can use the PSE (see [page 12](#)).
- (2) The advantages to using the 1756-L75 controller are to maintain common spare parts with redundant systems or if you are doing some memory intensive storage not accounted for in sizing model.
- (3) Recommended maximum control strategies are based on all controller strategies being simple regulatory control. See Sizing Control Strategies in the PlantPAx Distributed Control System Reference Manual, publication [PROCES-RM001](#).

## Redundant Controllers

ControlLogix controllers support redundancy on ControlNet and EtherNet/IP networks. In a redundant controller system on the PlantPAx system, you need these components:

- Two 1756 chassis each with matching configuration on the following aspects:
  - Number of slots
  - Modules in the same slots
  - Redundancy firmware revisions in each module
  - Two additional ControlNet or Ethernet nodes outside the redundant chassis pair
- One 1756-RM2 module per chassis

**Table 38 - Redundant Controller Hardware Requirements<sup>(1)</sup>**

Category	Cat. No.
Process controller	ControlLogix 1756-L73, 1756-L74, or 1756-L75 controller
Redundancy module	1756-RM2 <sup>(2)</sup>
Ethernet interface	<ul style="list-style-type: none"> <li>• 1756-EN2TR, 1783-ETAP, 1783-ETAP1F, 1783-ETAP2F (DLR support)</li> <li>• 1756-EN2T, 1756-ENBT, 1756-EWEB, 1756-EN2F (no DLR support)</li> </ul>
ControlNet interface (if applicable)	<ul style="list-style-type: none"> <li>• 1756-CN2, 1756-CN2R</li> <li>• 1756-CNB, 1756-CNBR</li> </ul>

- (1) If environmental conditions warrant, you can use an extreme temperature controller, for example, the 1756-L74XT. Conformal coating options are also available for protection from harsh environments that can contain moisture and or chemical contaminants.
- (2) The PlantPAx system recommendation is to use only one redundant controller in a chassis with a 1756-RM2 redundancy module. While a 1756-RM2 module can support two controllers, the resulting performance of each controller is not easily predicted.

**Table 39 - Redundant ControlLogix Controller Sizing**

Category <sup>(1)</sup>	1756-L73	1756-L74	1756-L75 <sup>(2)</sup>
User memory	8 MB	16 MB	32 MB
Total I/O recommended, max	750	1500	2250
Recommended control strategies, max <sup>(3)</sup>	125	250	450
Total control strategies @ 250 ms, max	120	120	120
Total control strategies @ 500 ms, max	125	220	220
Tags/sec delivered to data server, max	20,000	20,000	20,000

- (1) These values are recommended maximum limits. To achieve all of these values in a single controller is likely not feasible. For more detailed sizing, you can use the PSE (see [page 12](#)).
- (2) The advantages to using the 1756-L75 controller is to maintain common spare parts with redundant systems or if you are doing some memory intensive storage not accounted for in the sizing model.
- (3) Maximum controller strategy is based on all controller strategies being simple regulatory control. See Process Controller I/O Considerations in the PlantPAx Distributed Control System Reference Manual, publication [PROCES-RM001](#).

## Controllers for Skid-based Equipment

The PlantPAx system is a complete, scalable system, from single controller to a fully distributed set of equipment. You can integrate skid-based equipment into the overall system.

The CompactLogix controller platform offers a solution for skid-based equipment to be part of the overall PlantPAx system if the application requires the following:

- Control of multiple loops for temperature, pressure, flow, or level
- Operating as a subsystem with sequencing and automation
- Controlled as part of the overall process, accepting reference inputs and delivering process variables to a supervisory controller

**Table 40 - Skid-based Controller Sizing**

Category <sup>(1)</sup>	CompactLogix 1769-L24ER-QBFC1B	CompactLogix 1769-L33ER	CompactLogix 1769-L36ERM
User memory	0.75 MB	2.0 MB	3.0 MB
Total I/O recommended, max	80	250	350
Recommended control strategies, max <sup>(2)</sup>	10	30	45
Total control strategies @ 250 ms, max	10	30	45
Total control strategies @ 500 ms, max	10	30	45
Tags/sec delivered to data server, max	3000	3000	3000

(1) These values are recommended maximum limits. To achieve all of these values in a single controller is likely not feasible. For more detailed sizing, you can use the PSE (see [page 12](#)).

(2) Maximum controller strategy is based on all controller strategies being simple regulatory control. See Process Controller I/O Considerations in the PlantPAx Distributed Control System Reference Manual, publication [PROCES-RM001](#).

## I/O Products

Field networks and I/O components connect process instrumentation and field devices to the PlantPAX system for real-time data acquisition and control. The PlantPAX system supports several families of I/O. Our supported I/O choices include the following:

- ControlLogix 1756 - recommended I/O choice; deploys efficiently and provides flexible expansion
- CompactLogix 1769 - ideal I/O for Process skid-based applications
- 1715 - redundant I/O; high availability platform
- FLEX I/O1794 or POINT I/O 1734 - small form factor I/O; favorable in limited space environments

[Table 41](#) shows available I/O families and the interfaces to connect to the controller.

**Table 41 - I/O Communication Interfaces**

Category	Family	Communication Interface Cat. No.
Chassis-based I/O modules	1756 ControlLogix I/O <sup>(1)</sup>	Ethernet modules: <ul style="list-style-type: none"> <li>• 1756-EN2T, 1756-EN2TR, 1756-EN3TR, 1756-EN2F, 1756-EN2TXT, 1756-EN2TSC</li> </ul> ControlNet modules: <ul style="list-style-type: none"> <li>• 1756-CN2, 1756-CN2R, 1756-CNB, 1756-CNBR</li> </ul> DeviceNet module: 1756-DNB For more information, see the ControlLogix Selection Guide, publication <a href="#">1756-SG001</a> .
	1769 Compact I/O	No communication interface required as they're all local to controller chassis For more information, see the CompactLogix Selection Guide, publication <a href="#">1769-SG001</a> .
Distributed I/O, low-channel density	1734 POINT I/O	<ul style="list-style-type: none"> <li>• 1734-AENT, 1734-AENTR EtherNet/IP adapters</li> <li>• 1734-ACNR ControlNet adapter (redundant)</li> <li>• 1734-ADN, 1734-ADNX, 1734-PDN DeviceNet adapters</li> </ul> For more information, see the POINT I/O Selection Guide, publication <a href="#">1734-SG001</a> .
Distributed I/O, high-channel density	1794 FLEX I/O <sup>(2)</sup>	<ul style="list-style-type: none"> <li>• 1794-AENT, 1794-AENTR, 1794-AENTRXT EtherNet/IP adapters</li> <li>• 1794-ACN15, 1794-ACNR15, 1794-ACN15K, 1794-ACNR15K, 1794-ACNR15XT ControlNet adapters</li> <li>• 1794-ADN, 1794-ADNK DeviceNet adapters</li> </ul> For more information, see the FLEX I/O, FLEX I/O XT and FLEX Ex Selection Guide, publication <a href="#">1794-SG002</a> .
Distributed I/O, no cabinet enclosure	1738 ArmorPOINT I/O	<ul style="list-style-type: none"> <li>• 1738-AENT, 1738-AENTR EtherNet/IP adapters</li> <li>• 1738-ACNR ControlNet adapter</li> <li>• 1738-ADN12, 1738-ADN18, 1738-ADN18P, 1738-ADNX DeviceNet adapters</li> </ul> For more information, see the ArmorPoint I/O Selection Guide, publication <a href="#">1738-SG001</a> .
Condition monitoring module	Dynamix 1444	<ul style="list-style-type: none"> <li>• Built-in Ethernet connectivity with 1444-DYN04-01RA adapter</li> </ul> For more information, see the Dynamix -1444 Series Monitoring System User Manual, publication <a href="#">1444-UM001</a> .

(1) If environmental conditions warrant, you can use extreme temperature ControlLogix modules.

(2) If environmental conditions warrant, you can use extreme temperature FLEX I/O modules.

## High Availability I/O

For High Availability, the 1715 redundant I/O system lets a ControlLogix controller communicate to a remote, redundant I/O chassis over an EtherNet/IP network. The 1715 redundant I/O system provides fault tolerance and redundancy for critical processes by using a redundant adapter pair and multiple I/O modules that have enhanced diagnostics.

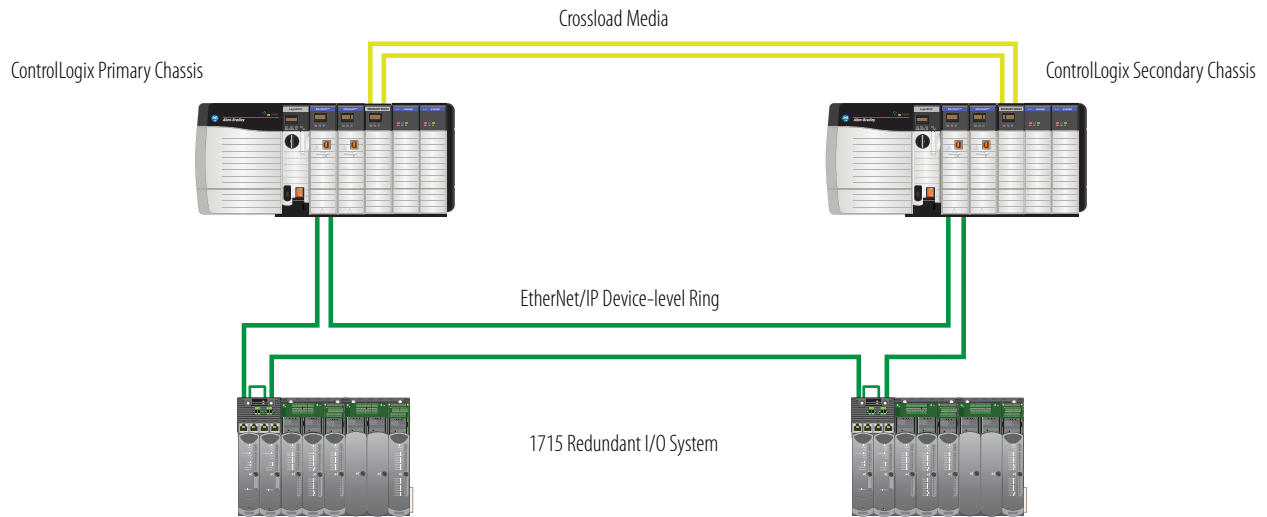

The 1715 I/O system supports as many as 24 I/O modules per set of adapters.

**Table 42 - 1715 High Availability I/O Modules**

Cat. No.	Description
1715-IB16D	16 point, 24V DC diagnostic input module
1715-OB8DE	8 point, 24V DC diagnostic output module, electronically fused
1715-IF16	16 channel, 4...20 mA, current analog input module
1715-OF8I	8 channel, 4...20 mA, current analog output module, isolated
1715-AENTR	Redundant EtherNet/IP adapter

For more information, see the Redundant I/O System User Manual, publication [1715-UM001](#).

Table 43 shows some of the modules that you can add to the Controller Organizer in the Logix Designer application when the controller is in Run mode.

**Table 43 - Online Addition of Module and Connection Types**

Module Type and Connection Method	In Local Chassis		Remote via a ControlNet Network				Remote via an EtherNet/IP Network		Configure Hold Last Output State
	Offline	Runtime	Offline		Runtime		Offline	Runtime	
			Scheduled	Unscheduled	Scheduled	Unscheduled			
Motion - direct	Yes	No	N/A	N/A	N/A	N/A	N/A	N/A	N/A
Digital - direct	Yes	Yes	Yes	Yes	No	Yes	Yes	Yes	Yes - 1756 I/O digital output modules
Digital - rack-optimized	N/A	N/A	Yes	No	Yes	No	Yes	Yes	Yes - 1756 I/O digital output modules
Analog - direct	Yes	Yes	Yes	Yes	No	Yes	Yes	Yes	Yes
Generic third party - direct	Yes	Yes	Yes	Yes	No	Yes	Yes	Yes	N/A
1756-DNB	Yes	No	Yes	No	No	No	Yes	Yes	N/A
1756-DHRIO	Yes	No	Yes	No	No	No	Yes	Yes	N/A
1756-CNx - no connection	Yes	Yes	Yes	Yes	No	Yes	N/A	N/A	N/A
1756-CNx - rack-optimized	N/A	N/A	Yes	N/A	N/A	N/A	N/A	N/A	N/A
Generic ControlNet third party - direct	N/A	N/A	Yes	Yes	No	Yes	N/A	N/A	N/A
1788HP-EN2PA-R	N/A	N/A	N/A	N/A	N/A	N/A	Yes	Yes	N/A
1788HP-CN2PA-R	N/A	N/A	Yes	Yes	No	Yes	N/A	N/A	N/A
1715 Redundant I/O	No	No	No	No	No	No	Yes	Yes	N/A
1756-ENx - no connection	Yes	Yes	N/A	N/A	N/A	N/A	Yes	Yes	N/A
1756-ENx - rack-optimized	N/A	N/A	N/A	N/A	N/A	N/A	Yes	Yes	N/A
Generic EtherNet/IP third party - direct	N/A	N/A	N/A	N/A	N/A	N/A	Yes	Yes	N/A
1794 FLEX I/O	N/A	N/A	Yes	Yes	No	No	Yes	No	Yes - Analog output modules only
1734 POINT I/O	N/A	N/A	Yes	Yes	No	No	Yes	No	Yes <sup>(1)</sup>

(1) When you lose communication to the controller, POINT I/O ignores the last output state configuration, and sets the outputs to zero.

## Process Network I/O

Use of smart instrumentation has increased in the marketplace. This enables the PlantPAx system to leverage the devices' improved data and control capabilities. In a PlantPAx system, the controllers are connected to the field devices via field device components and communicate through the EtherNet/IP, DeviceNet, ControlNet, FOUNDATION Fieldbus, and PROFIBUS PA networks or by using the HART protocol.



Many I/O components and field devices are available via the Encompass third-party product referencing program. To sort and filter products from best-in-industry suppliers in your region, see <http://www.rockwellautomation.com/encompass>.

### EtherNet/IP Devices

In a PlantPAx system, the EtherNet/IP network provides the communication backbone for the supervisory network for the workstations, servers, and the controllers. The EtherNet/IP network also supports controller downlinks and connections to remote I/O and field device interfaces. The EtherNet/IP network is supported by ODVA.

Field instruments that support a direct connection to EtherNet/IP networks include the following:

- Endress+Hauser, Promass 83 and compact Promass 100 Coriolis flowmeters for liquid and gas flows
- Endress+Hauser, Promag 53 electromagnetic flowmeter for conductive liquids
- Endress+Hauser, Liquiline CM444 Multiparameter transmitter for monitoring and controlling processes
- Endress+Hauser, Proline Promag 100 Electromagnetic flowmeter for conductive liquids
- Endress+Hauser, Proline Promag L 400 Electromagnetic flowmeter for conductive liquids

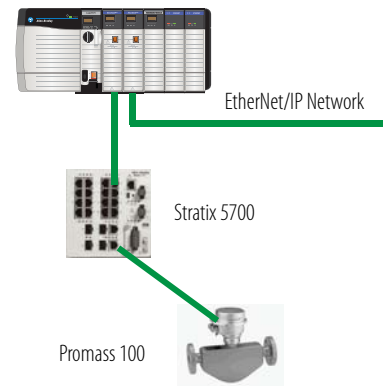

**Table 44 - EtherNet/IP Interface**

Category	Cat. No.	Description
ControlLogix controller interface	1756-EN2T, 1756-EN2TR, 1756-EN3TR, 1756-EN2F 1756-ENBT	ControlLogix EtherNet/IP bridge.
	1788-EN2FFR	EtherNet/IP to FOUNDATION Fieldbus linking device. Supports H1 FOUNDATION Fieldbus networks and redundant media.
	1788-EN2PAR	EtherNet/IP to PROFIBUS PA linking device. Supports redundant PROFIBUS PA media and DLR-capable Ethernet network.



## ControlNet Devices

The ControlNet™ network is an open, control network for real-time, high-throughput applications. The network uses the Common Industrial Protocol™ (CIP) to combine the functionality of an I/O network and a peer-to-peer network, providing high-speed performance for both functions. The ControlNet network is supported by ODVA.

In a PlantPAx system, the ControlNet network supports controller downlinks and connections to remote I/O and field device interfaces.

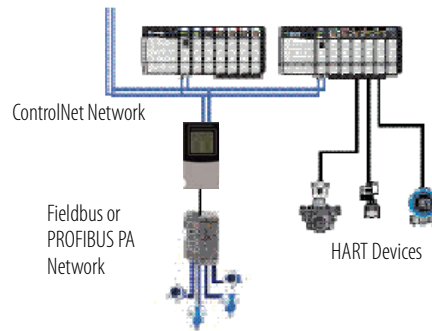

**Table 45 - ControlNet Interface**

Category	Cat. No.	Description
ControlLogix controller interface	1756-CN2, 1756-CN2R 1756-CNB, 1756-CNBR	ControlLogix ControlNet scanner.
	1788-CN2FFR	ControlNet to FOUNDATION Fieldbus linking device. Supports H1 FOUNDATION Fieldbus networks. Compatible with ControlLogix redundancy and redundant ControlNet media.
	1788-CN2PAR	ControlNet to PROFIBUS PA linking device. Supports redundant PROFIBUS PA media and redundant ControlNet media.

## DeviceNet Devices

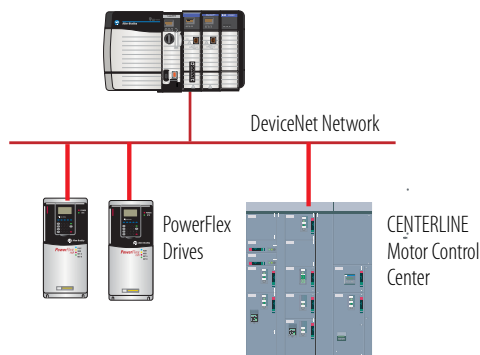

The DeviceNet™ network is an open, device-level network that provides connections between simple industrial devices (such as sensors and actuators) and higher-level devices (such as controllers and computers). The DeviceNet network uses the proven Common Industrial Protocol (CIP) to provide the control, configuration, and data collection capabilities for industrial devices. The DeviceNet network is supported by ODVA.

In a PlantPAx system, the DeviceNet network connects networked control devices.

**Table 46 - DeviceNet Interface**

Category	Cat. No.	Description
ControlLogix controller interface	1756-DNB	ControlLogix DeviceNet scanner

## HART Devices

HART is an open communication protocol designed to connect analog devices to the controller and system.

The PlantPAx system interfaces with HART devices both directly and via remote I/O modules. The HART protocol creates a single termination point to gather analog process variables and the additional HART digital data.

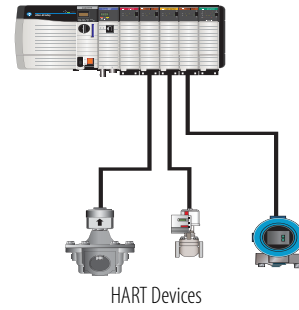

**Table 47 - HART Interface**

Category	Cat. No.	Description
Chassis-based I/O modules	1756-IF8IH, 1756-OF8IH	ControlLogix analog isolated I/O modules. These modules enable basic configuration through the I/O tree, provide status and diagnostics information, and provide remote configuration and troubleshooting.
	MVI56-HART	ProSoft Technology, HART multi-drop communication interface module for ControlLogix system for use in FactoryTalk AssetCentre Process Device Configuration or other asset management system based on FDT Technology (IEC-62453, ISA103).
Distributed I/O modules	1734-sc-IF4H	Spectrum Controls, analog input module with HART for the POINT I/O™ system.
	1769-sc-IF4IH, 1769-sc-OF4IH	Spectrum Controls, analog, isolated input and output modules with HART for Compact I/O™ modules.
	1794-IE8H, 1794-OE8H, 1794-IF8IH, 1794-OF8IH, 1797-IE8H, 1797-OE8H, 1794-IF8IHNEXT	FLEX analog I/O and FLEX Ex™ analog I/O modules with the following: <ul style="list-style-type: none"> <li>• Standard profiles in Studio 5000 Logix Designer</li> <li>• DTMs</li> </ul>
Multiplexers/gateways	Wireless HART adapter	Pepperl+Fuchs <sup>(1)</sup> , wireless HART adapter. See the Encompass website for Pepperl+Fuchs product offerings.
Network configuration	Handheld device	Endress+Hauser <sup>(1)</sup> , handheld configuration and diagnostic device. See the Encompass website for Endress+Hauser product offerings.

(1) For more information on Encompass third-party products, see <http://www.rockwellautomation.com/encompass>.

## FOUNDATION Fieldbus Devices

The FOUNDATION Fieldbus network is a protocol designed for robust, distributed process application control. Devices connected by a FOUNDATION Fieldbus network can be used for sophisticated process control with seamless data distribution from the H1 device-level network.

PlantPAx systems communicate with FOUNDATION Fieldbus devices through EtherNet/IP and ControlNet linking devices as shown in the examples below. Other configurations are available for simple and redundant topologies.

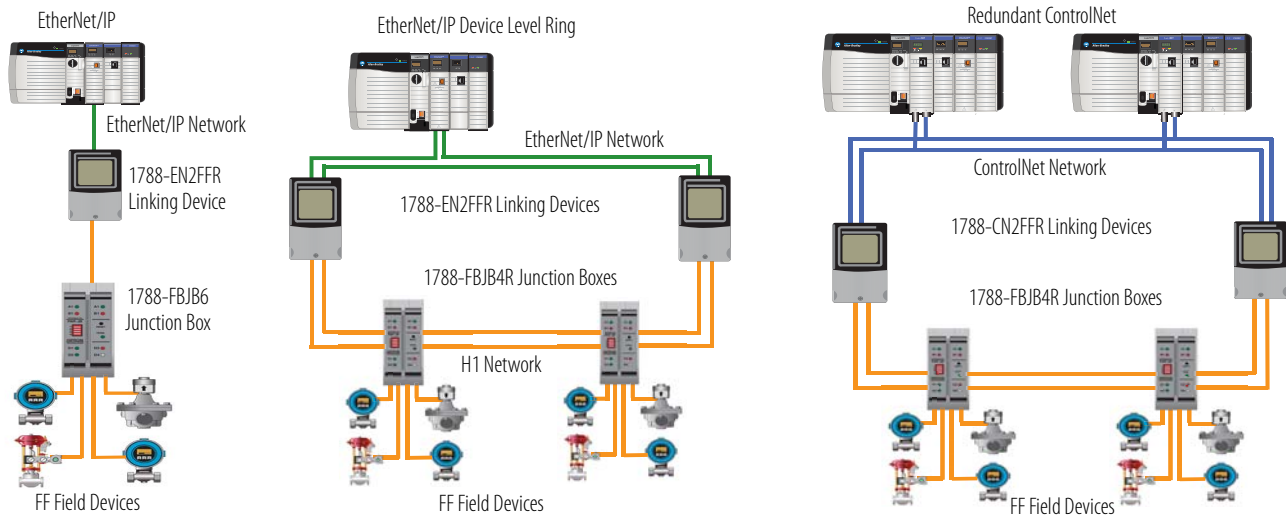

**Table 48 - FOUNDATION Fieldbus Interface**

Category	Cat. No.	Description
EtherNet/IP interface	1788-EN2FFR	Bridge from an Ethernet network to an H1 network. Supports redundant media and DLR-capable Ethernet network. Linking devices have built-in termination.
ControlNet interface	1788-CN2FFR	Bridge from a ControlNet network to an H1 network; compatible with ControlLogix redundancy and redundant ControlNet media. Linking devices have built-in termination.
FOUNDATION Fieldbus network components	Power conditioning	Both linking devices have built-in power conditioning.
	1788-FBJB4R	Intelligent junction box supports redundancy, includes four drop ports and four trunk ports.
	1788-FBJB6	Intelligent junction box with six drop ports and two trunk ports.
	Additional components	Pepperl+Fuchs <sup>(1)</sup> , FOUNDATION Fieldbus components, such as valve couplers, surge protectors, and distributors. See the Encompass website for Pepperl+Fuchs product offerings.
	Segment protection	Helps protect against device or line faults with short- and open-circuit protection. Pepperl+Fuchs <sup>(1)</sup> , intrinsic safety components, such as isolated barrier systems, hazardous area enclosures, and equipment. See the Encompass website for Pepperl+Fuchs product offerings.

(1) For more information on Encompass third-party products, see <http://www.rockwellautomation.com/encompass>.

## PROFIBUS PA Devices

The PROFIBUS PA network is the PROFIBUS solution for process automation. The PROFIBUS PA network connects automation systems and process control systems with field devices such as flow, level, pressure, and temperature transmitters.

PlantPax systems communicate with PROFIBUS PA fieldbus devices through EtherNet/IP and ControlNet linking devices as shown in the examples below. Other configurations are available for simple and redundant topologies.

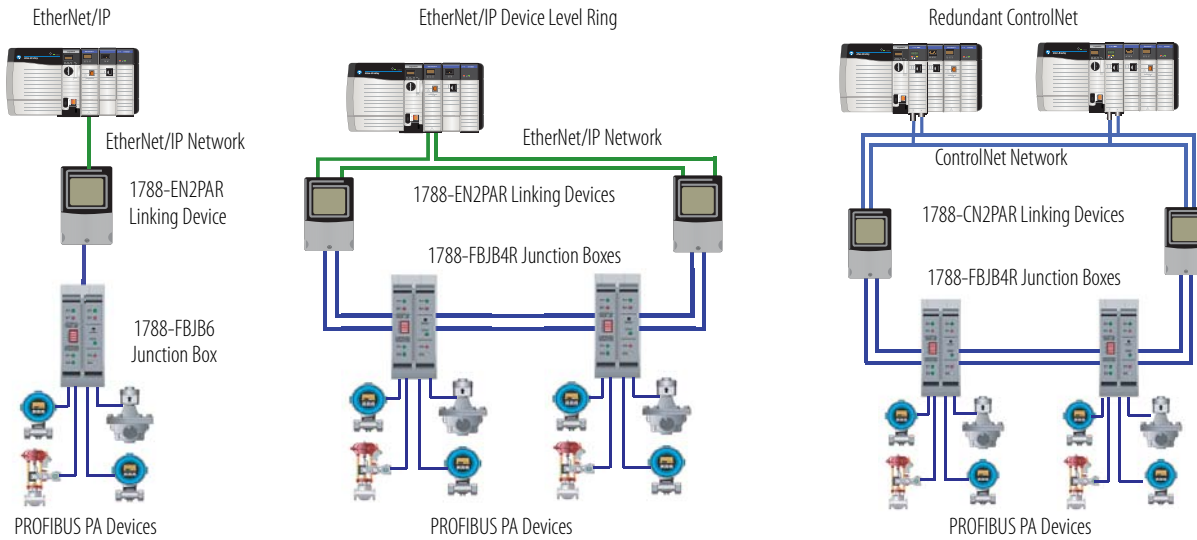

**Table 49 - PROFIBUS PA Interface**

Category	Cat. No.	Description
PROFIBUS interface	1788-EN2PAR	EtherNet/IP to PROFIBUS PA linking device. Supports redundant PROFIBUS PA media and DLT-capable Ethernet network. Linking devices have built-in terminators.
	1788-CN2PAR	ControlNet to PROFIBUS PA linking device. Supports redundant PROFIBUS PA media and redundant ControlNet media. Linking devices have built-in terminators.
PROFIBUS network components	Power conditioning	Both linking devices have built-in power conditioning.
	1788-FJB4R	Intelligent junction box supports redundancy, includes four drop ports and four trunk ports.
	1788-FJB6	Intelligent junction box with six drop ports and two trunk ports.
	Additional components	Pepperl+Fuchs <sup>(1)</sup> , PROFIBUS components, such as valve couplers, surge protectors, and distributors. See the Encompass website for Pepperl+Fuchs product offerings.
	Segment protection	Helps protect against device or line faults with short- and open-circuit protection. Pepperl+Fuchs <sup>(1)</sup> , intrinsic safety components, such as isolated barrier systems, hazardous area enclosures, and equipment. See the Encompass website for Pepperl+Fuchs product offerings.

(1) For more information on Encompass third-party products, see <http://www.rockwellautomation.com/encompass>.

## Field Devices

Rockwell Automation offers a broad range of motor control solutions to complement a variety of application requirements. The portfolio of motor control includes more simplified programming and configuration along with safety features to help protect personnel and assets that helps to reduce downtime.

Select from the following options:

- [Drives](#)
- [Soft Starters](#)
- [Across-the-Line Starters](#)

### Drives

PowerFlex® Low Voltage AC drives provide scalable motor control solutions and are designed to deliver more powerful performance and flexibility for process applications. As part of a PlantPAx system, PowerFlex drives offer seamless integration into your process control system for simplified development, use, and maintenance. The benefits of this exceptional level of integration between the drives and Logix controllers provides distinctive time-saving features for the PowerFlex 525, 753, and 755 drives, including Automatic Device Configuration.

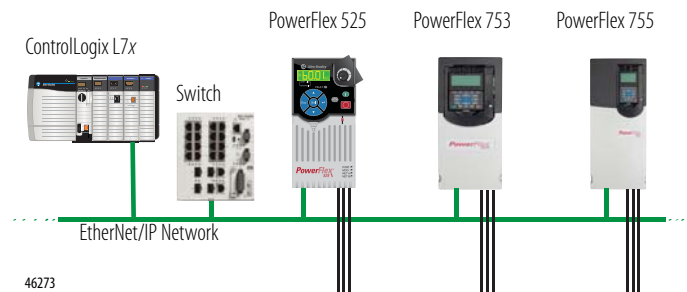

With Automatic Device Configuration, a Logix controller can automatically detect a replaced PowerFlex 525, 753<sup>(1)</sup>, or 755 drive and download all configuration parameters, minimizing the need for manual reconfiguration and helping to reduce downtime.

(1) PowerFlex 753 AC drives require a dual-port EtherNet/IP communication card.

**Table 50 - PowerFlex Drives and Communication Modules**

Drive Cat. No.	Description	Available Communication Modules	
		Cat. No.	Description
25B- <sup>(1)</sup>	PowerFlex 525 AC drive with an embedded EtherNet/IP port and an embedded Safe Torque Off (STO). See <a href="#">page 72</a> for more information on STO.	<ul style="list-style-type: none"> <li>• 25-COMM-E2P</li> <li>• 25-COMM-D</li> <li>• 25-COMM-P</li> </ul>	<ul style="list-style-type: none"> <li>• Dual-port EtherNet/IP, supports DLR functionality</li> <li>• DeviceNet</li> <li>• PROFIBUS PA</li> </ul>
20F- <sup>(1)</sup>	PowerFlex 753 AC drive	<ul style="list-style-type: none"> <li>• 20-750-BNETIP</li> <li>• 20-750-CNETC</li> <li>• 20-750-DNET</li> <li>• 20-750-ENETR</li> <li>• 20-750-PBUS</li> <li>• 20-750-PNET</li> <li>• 20-750-PNET2P</li> <li>• 20-COMM-C<sup>(2)</sup></li> <li>• 20-COMM-D<sup>(2)</sup></li> <li>• 20-COMM-E<sup>(2)</sup></li> <li>• 20-COMM-H<sup>(2)</sup></li> <li>• 20-COMM-K<sup>(2)</sup></li> <li>• 20-COMM-L<sup>(2)</sup></li> <li>• 20-COMM-M<sup>(2)</sup></li> <li>• 20-COMM-P<sup>(2)</sup></li> <li>• 20-COMM-Q<sup>(2)</sup></li> <li>• 20-COMM-R<sup>(2)(3)</sup></li> <li>• 20-COMM-S<sup>(2)</sup></li> </ul>	<ul style="list-style-type: none"> <li>• BACnet/IP option module</li> <li>• Coaxial ControlNet option module</li> <li>• DeviceNet option module</li> <li>• Dual-port EtherNet/IP option module</li> <li>• PROFIBUS DPV1 option module</li> <li>• Single-port PROFINET I/O option module</li> <li>• Dual-port PROFINET I/O option module</li> <li>• ControlNet communication adapter (coax)</li> <li>• DeviceNet communication adapter</li> <li>• EtherNet/IP communication adapter</li> <li>• HVAC communication adapter (only Modbus RTU)</li> <li>• CANopen communication adapter</li> <li>• LonWorks communication adapter</li> <li>• Modbus/TCP communication adapter</li> <li>• PROFIBUS DR communication adapter</li> <li>• ControlNet communication adapter (fiber)</li> <li>• Remote I/O communication adapter</li> <li>• RS485 DF1 communication adapter</li> </ul>
20G- <sup>(1)</sup>	PowerFlex 755 drive		

(1) For a complete list of catalog numbers, see the PowerFlex Low Voltage AC Drives Selection Guide, publication [PFLEX-SG002](#).

(2) Requires a Communication Carrier Card (20-750-20COMM or 20-750-COMM-F1). Refer to the PowerFlex 750-series Technical Data, publication [750-TD001](#) for details.

(3) This item has Silver Series status.

## Soft Starters

SMC™ Soft Starters are designed to help minimize cost by reducing overall system power requirements and wear and tear on equipment. Our soft starters can be easily integrated into your process control system to offer higher productivity and shorter downtimes.

We offer a diverse line of soft-starters to meet your communication, control, and space requirements.

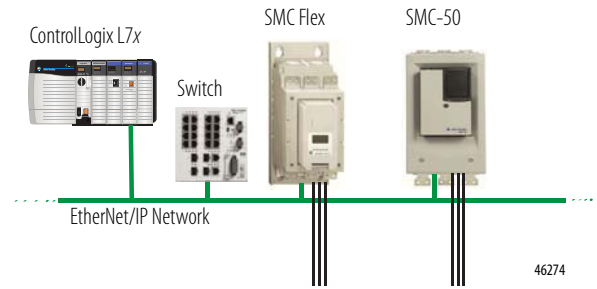

**Table 51 - SMC Soft Starters and Communication Modules**

Cat. No.	Description	Available Communication Modules	
		Cat. No.	Description
150-F <sup>(1)</sup>	SMC Flex Smart Motor Controllers	<ul style="list-style-type: none"> <li>• 20-COMM-S</li> <li>• 20-COMM-P</li> <li>• 20-COMM-C</li> <li>• 20-COMM-I</li> <li>• 20-COMM-M</li> <li>• 20-COMM-D</li> <li>• 20-COMM-E</li> <li>• 20-COMM-ER</li> <li>• 20-COMM-H</li> </ul>	<ul style="list-style-type: none"> <li>• RS485 DF1 communication adapter</li> <li>• PROFIBUS DP communication adapter</li> <li>• ControlNet communication adapter (Coax)</li> <li>• Interbus communication adapter</li> <li>• Modbus/TCP communication adapter</li> <li>• DeviceNet communication adapter</li> <li>• EtherNet/IP communication adapter</li> <li>• Dual-port EtherNet/IP communication adapter</li> <li>• HVAC communication adapter</li> </ul>
150-S <sup>(1)</sup>	SMC 50 Solid State Smart Motor Controllers	<ul style="list-style-type: none"> <li>• 20-COMM-S</li> <li>• 20-COMM-P</li> <li>• 20-COMM-C</li> <li>• 20-COMM-I</li> <li>• 20-COMM-M</li> <li>• 20-COMM-D</li> <li>• 20-COMM-E</li> <li>• 20-COMM-ER</li> <li>• 20-COMM-H</li> <li>• 20-COMM-Q</li> </ul>	<ul style="list-style-type: none"> <li>• RS485 DF1 communication adapter</li> <li>• PROFIBUS DP communication adapter</li> <li>• ControlNet communication adapter (Coax)</li> <li>• Interbus communication adapter</li> <li>• Modbus/TCP communication adapter</li> <li>• DeviceNet communication adapter</li> <li>• EtherNet/IP communication adapter</li> <li>• Dual-port EtherNet/IP communication adapter</li> <li>• HVAC communication adapter</li> <li>• ControlNet communication adapter (Fiber)</li> </ul>

(1) For additional product information, see the Smart Motor Controllers – SMC-3, SMC Flex, and SMC-50 Soft Starters Family Brochure, publication [150-BR144](#).

## Across-the-Line Starters

We offer a full line of versatile and robust starters for both IEC and NEMA applications. Our light industrial IEC starters are environmentally friendly, versatile, and flexible. Our heavy-duty NEMA starters are renowned for a more-rugged construction, more dependable performance, and longer electrical life. In addition, this portfolio offers Electronic Overload Relays that provide integration between the starters and Logix controllers. The diagnostic capabilities of the overload relays help maximize uptime for motor control in an automation system.

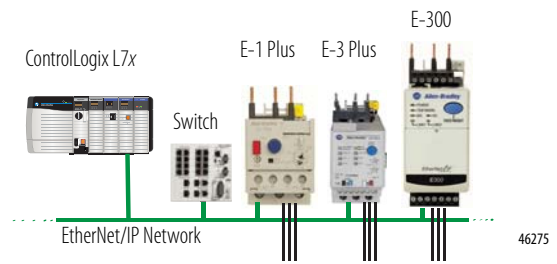

**Table 52 - Electronic Overload Relays and Communication Modules**

Cat. No.	Description	Available Communication Modules	
		Cat. No.	Description
193/592-EE <sup>(1)</sup>	E1 Plus™ Electronic Overload Relays	<ul style="list-style-type: none"> <li>193-ETN</li> <li>193-EPRB</li> <li>193-EDN</li> </ul>	<ul style="list-style-type: none"> <li>EtherNet/IP module</li> <li>PROFIBUS module</li> <li>DeviceNet module</li> </ul>
193/592-EC <sup>(1)</sup>	E3 Plus™ Electronic Overload Relays with embedded DeviceNet	193-DNENCAT	EtherNet/IP communication auxiliary DeviceNet to EtherNet/IP linking device, single port
		193-DNENCATR	EtherNet/IP communication auxiliary DeviceNet to EtherNet/IP linking device, dual port
193/592-E300 <sup>(2)</sup>	E300™ Electronic Overload Relays	193-ECM-ETR	EtherNet/IP communication module

(1) For additional product information, see the Bulletin 193, 592, and 825 Overload Relay Family Brochure, publication [193-BR029](#).

(2) For more information, see the E300 Electronic Overload Relay Selection Guide, publication [193-SG010](#).

## Motor Control Centers

As an alternative to wiring each device individually, Rockwell Automation offers two, low-voltage motor control centers (MCC) that feature a rugged, high-performance packaging solution for all your motor control needs that integrate control and power in one centralized location. Consider CENTERLINE® 2100 or CENTERLINE 2500 MCCs to house your starters, soft-starters, and drives to meet IEC, UL, and NEMA standards.

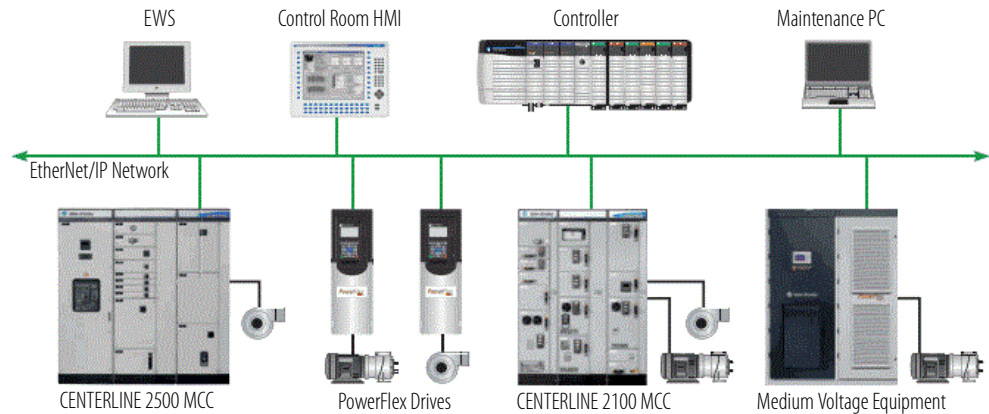

Benefit from embedded network systems with IntelliCENTER® technology and software. EtherNet/IP™ networks provide enhanced integration between the plant floor and corporate operations by using a single programming environment, and built-in DeviceNet™ technology is designed and tested to ODVA specifications to help assure reliable communication. Use IntelliCENTER software for seamless integration into your Logix architecture and gain valuable access to your MCC operating data.

CENTERLINE MCCs are available with safety options that help reduce exposure to electrical hazards and arc flash mitigation and containment. Remove units without opening the door and help reduce exposure to electrical hazards with SecureConnect™ units for CENTERLINE 2100 MCCs. ArcShield™ enclosure options for both 2100 and 2500 MCCs help mitigate and contain arc flash incidents.

**Table 53 - Low Voltage Motor Control Centers**

Category <sup>(1)</sup>	Cat. No.	Description
CENTERLINE 2100 MCC	2100	<ul style="list-style-type: none"> <li>• Designed to meet UL and NEMA standards</li> <li>• Allen-Bradley motor control devices: starters, soft-starters, and drives</li> <li>• Available with SecureConnect units</li> <li>• ArcShield arc resistant enclosures also available</li> <li>• EtherNet/IP and DeviceNet networking</li> <li>• IntelliCENTER software</li> </ul>
CENTERLINE 2500 MCC	2500	<ul style="list-style-type: none"> <li>• Designed to meet IEC standards</li> <li>• Allen-Bradley motor control devices: starters, soft-starters, and drives</li> <li>• ArcShield arc resistant enclosures also available</li> <li>• EtherNet/IP and DeviceNet networking</li> <li>• IntelliCENTER software</li> </ul>

(1) For more information, see the website at <http://www.ab.rockwellautomation.com/Motor-Control/Motor-Control-Centers>.



# Advanced Process Control

Advanced Process Control (APC) is an umbrella term that covers a wide range of control technologies from simple regulatory loops to complex multi-unit optimizations. Depending on the context, anything more sophisticated than a simple PID loop can be considered APC.

Select from the following options:

- [Regulatory Control Options](#)
- [Supervisory Control Options](#)
- [PlantPAx MPC](#)

The PlantPAx portfolio for APC provides a comprehensive set of tools and solutions to optimize performance. This scalable framework lets you add the tools you need:

- Control regulatory loops, individual process units, and plant operations
- Use modeling techniques to achieve more accurate and robust models

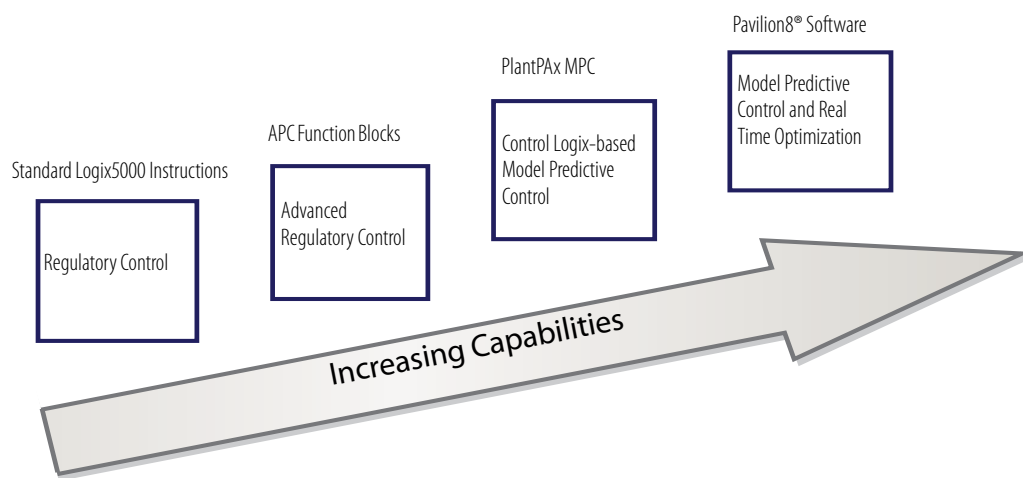

As you add advanced process control technologies, the technologies deliver more value while becoming more complex.

There are two main categories for APC technologies: regulatory control and supervisory control:

- Regulatory control focuses on the **process** variables, including levels, flows, temperatures, and pressures. Regulatory control is designed to improve poorly performing loops and automate loops that are typically run in manual mode by the operator. This process includes techniques such as ratio, feed-forward, cascade, and decoupling control. The techniques can be used to compensate for process dead-time and simple process coupling and nonlinearities that a PID loop cannot handle.
- Supervisory control focuses on the **product** being manufactured, such as cement, polyethylene, ethanol, and paper. Supervisory control is designed to control the various product specifications and parameters that determine whether the product is marketable. Parameters include impurity percentage, moisture content, color, density, and fineness. Instead of making direct control outputs, supervisory controls generate setpoints for lower-level regulatory controls. Thus, good regulatory control performance is a first step before implementing supervisory control.

## Regulatory Control Options

APC function blocks can be used in place of PID instructions for loops with long dead-times and interacting loops. The APC function blocks are licensed, run on the EWS, and require the Logix Designer application.

**Table 54 - APC Function Block Descriptions**

APC Instruction	Description
Internal model control (IMC)	Controls a single process variable (such as a temperature or pressure) with a single control variable (such as a valve position or pump speed). Compares actual process error against error calculated by an internal first order lag plus dead-time model. Suitable for long dead-time processes, which are difficult to control with standard PID loops.
Coordinated control (CC)	Controls a single process variable with up to three control variables. It is good for situations where multiple outputs are available for control, and costs need to be minimized or for situations where additional process information is available for feed-forward control. Target values and priorities for outputs are used to optimize your process.
Modular multivariable control (MMC)	Controls two process variables with up to three control variables. It is good for situations where there is significant interaction between the various control variables and process variables.

**Table 54.1 - APC Software**

Category	Cat. No. <sup>(1)</sup>	Description
Automation software	<ul style="list-style-type: none"> <li>9324-RLDAPCENE for first controller</li> <li>9324-RLDAPCLENE for subsequent controllers</li> </ul>	<ul style="list-style-type: none"> <li>Logix Designer APC Design License</li> <li>Logix Designer APC Runtime License</li> </ul>

(1) Different languages are available, but you must contact your local Allen-Bradley distributor or Rockwell Automation sales representative.

## Supervisory Control Options

The most common supervisory control technique is Model Predictive Control (MPC). MPC can handle large multivariable processes and control these product parameters while optimizing the production process through maximizing rates and yields, reducing raw material usage and minimizing energy.

The Pavilion8® workstation-based software platform is a modular design that includes modules to help control, analyze, monitor, visualize, warehouse, and integrate information. MPC technology is an intelligence layer on top of basic automation systems that continuously drives the plant. The technology helps achieve multiple business objectives, such as cost reductions, decreased emissions, consistent quality, and production increases—every production minute.

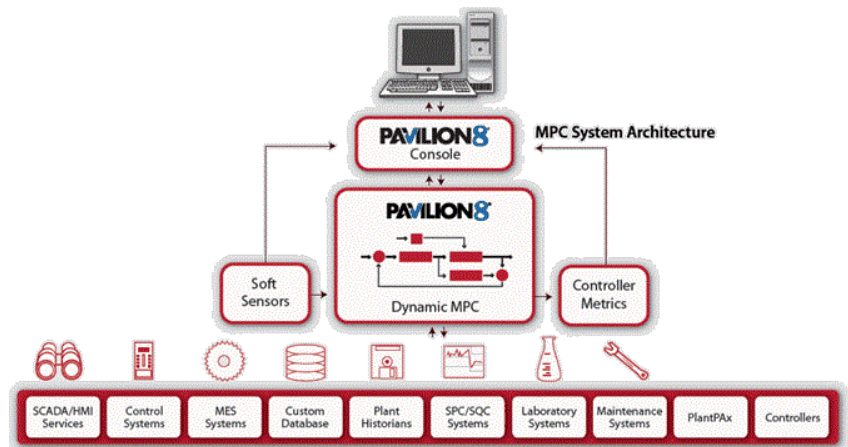

MPC technology also assesses current and predicted operational data and compares them to desired results. Once computed, new control targets help reduce in-process variability to improve process performance.

Use the Pavilion platform within a PlantPAx system to add model predictive control, environmental performance management, and production performance management.

## PlantPAx MPC

PlantPAx model predictive control (MPC) is a fully functional, rack-based option of MPC. The rack-based option runs in the Rockwell Automation ControlLogix chassis. Configuration software available to create the application is called PlantPAx MPC Builder. PlantPAx MPC Builder software lets you configure and integrate a developed application as an Add-On Instruction. In the Studio 5000 Logix Designer® application, you can move the created MPC Add-On Instruction into a Logix controller.

PlantPAx MPC has a dynamic form that is identical to Pavilion 8 MPC dynamic transforms. PlantPAx MPC supports up to 10 controlled variables (CV), 10 manipulated variables (MV) and 10 disturbance variables (DV). A single PlantPAx MPC module (required) can support up to five independent MPC applications. The five applications can share information with each other. Therefore, large applications can be controlled with a single PlantPAx MPC module when appropriately segmented. This approach facilitates development, integration, commissioning and execution of your application.

For purchase information, contact your local Allen-Bradley distributor or Rockwell Automation sales representative.

**Table 55 - PlantPAx MPC Software and License**

Category	Cat. No.	Description
Automation software	1756-PPMPC <sup>(1)</sup>	ControlLogix MPC module
MPC License	9529-PPMPCENM <sup>(1)</sup>	PlantPAx MPC firmware
MPC Modeling Editors	<ul style="list-style-type: none"> <li>• 9529-PPMPCBENE</li> <li>• 9529-PPMPCBENM</li> </ul>	PlantPAx MPC Builder configuration software

(1) The version of the PlantPAx MPC firmware and PlantPAx MPC Builder configuration software must match.

Notes:

# Process Safety Systems

A process automation solution often includes the requirement for an integrated safety system as part of the overall Safety Instrumented System (SIS) requirements for a process facility. The SIS logic solver is a separate but integrated technology that can use common or diverse technology to meet the safety integrity needs for any process application.



The SIS logic solver requirements can include fault tolerance, fail safe, or a mix of architecture and Safety Integrity Level (SIL) requirements. Fault tolerance means to maintain plant operation in the event of a fault, while fail-safe means to initiate a shutdown in the event of a fault.



Select from the following technologies:



- [ControlLogix SIL 2 Systems](#)
- [AADvance and Trusted SIL2, SIL3, and TMR systems](#)
- [SIL-rated Instruments](#)
- [PowerFlex SIL 2 and SIL 3 Systems](#)
- [OptiSIS Safety Integrated Systems](#)

[Table 56](#) provides guidance of which SIS logic solver is typically used based on application. This is not an absolute selection guide. We recommend that you work with subject matter experts from Rockwell Automation to make the right choice.

**Table 56 - Typical SIL and Architecture System Requirements**

Process Safety Platform	Safety Application	Architecture	Typical SIL Range	Demand
 <p>Trusted®</p> <p>AADvance</p> 	Emergency shutdown/SIS	Fault Tolerant	Up to SIL 3	Low/High
	Fire and gas		SIL 2	Low
	High integrity pressure system		SIL 3	
	Chemical processing		Up to SIL 3	High
	Refining			Low/High

Process Safety Platform	Safety Application	Architecture	Typical SIL Range	Demand
 <p>AADvance</p> 	Burner management (continuous process)	Fault Tolerant	Up to SIL 3	High
	Subsea <sup>(1)</sup>		SIL 2	Low
	Power generators			

Process Safety Platform	Safety Application	Architecture	Typical SIL Range	Demand	
 <p>ControlLogix</p> 	Burner management (power and utilities)	Fail Safe	SIL 2	High <sup>(2)</sup>	
	Turbo machinery				
	Life sciences				Low
	Mining	Fault Tolerant			
	Power equipment				
	Speciality chemical				
	High Availability control systems				Low/High <sup>(2)</sup>

(1) AADvance is available in a Eurocard format, qualified for Subsea production applications under ISO13628-6.

(2) ControlLogix is limited to a demand rate not to exceed 10 demands per year. This is high demand, but it's not all high-demand applications.

Safe, reliable systems safeguard people, property, the environment, and company or corporate reputations. Third-party certification for applying technologies in applications up to a specific SIL level significantly reduces complexity when complying with national and international process safety standards worldwide.

Process safety technology selection is based on functional and target SIL requirements, defined in the projects Safety Requirements Specification (SRS). For example, if the SRS requirement is for the Safety Instrumented Function to always fail safely upon a fault, you can select a fail-safe only technology. If, however, some level of fault tolerance is defined for your process safety system, you can select a fault tolerant technology.

There are different levels of fault tolerance available. For example:

- 1oo2d refers to a voting and degradation architecture where diagnostics is used to determine the validity of two values or states. When both values are 'healthy', then either one out of the two (1oo2) available is used in the outcome of the Safety instrumented Function (SIF). When one of the two values or states is determined to be 'invalid', that value or state is no longer considered when determining the outcome of the SIF (the voting degrades to 1oo1, one out of the remaining good one). This dramatically reduces the nuisance trip rate of a basic 1oo2 architecture, while maintaining safety performance.
- 2oo3 refers to a voting and degradation architecture where comparison diagnostics are used to determine the outcome of the SIF. Two 'out of' the three (2oo3) available values or states are required to determine the outcome of a SIF. This architecture, often referred to as Triple Modular Redundancy (TMR), lets a failed value or state to be ignored when resolving the SIF.

**TIP:** In addition to the comparison diagnostics, active diagnostics are also used to validate states and values used in the outcome of the SIF.

[Table 57](#) shows the capabilities of the process safety systems. Your solution can include one or a combination of technologies.

**Table 57 - Process Safety System Capabilities**

Process Safety System Specification	ControlLogix	AADvance	Trusted
SIL2	Yes	Yes	Yes
SIL3	No	Yes	Yes
Fault tolerant (1oo2d)	Yes <sup>(1)</sup>	Yes	Yes
Fault tolerant (2oo3/TMR)	No	Yes	Yes
Diverse safety system (programmed with diverse hardware and programming software)	No	Yes	Yes
Integrated safety system (programmed with common hardware and programming software)	Yes	No	No
Single project spanning controllers (distributed safety environment)	No	Yes	No

(1) The 1oo2d mechanism for the ControlLogix SIL 2 system is provided by the 1715 I/O platform. A ControlLogix SIL 2 system also provides fault tolerance through controller redundancy, but ControlLogix redundancy acts as a hot backup and is not a voting architecture.

## ControlLogix SIL 2 Systems

ControlLogix supports process safety applications up to SIL 2 requiring fault tolerance and redundancy. ControlLogix supports 1oo2d fault tolerance with the 1715 I/O system. However, ControlLogix redundancy does not use a voting mechanism, rather it acts as a hot standby. The components of the 1715 I/O system comprise a pair of partnered Ethernet adapter modules that communicate to ControlLogix controllers via an EtherNet/IP network, and digital and analog I/O modules that are configurable in simplex and duplex modes.

The ControlLogix L7x controller complies with the requirements of the relevant standards (SIL2 according to IEC 61508) and can be used in low demand applications up to SIL2 according to IEC 61508). The instructions of the associated Safety Reference Manual and User Manuals are to be considered.

ControlLogix SIL 2 systems use the same programming software and data interfaces as used for process control on the PlantPAx system. The hardware that is used for process safety must be dedicated for process safety applications.

Specific hardware, firmware revisions, and software versions are required to meet SIL certifications. To make sure that you have the correct equipment, see the Using ControlLogix in SIL 2 Application Safety Reference Manual, publication [1756-RM001](#).

## AADvance and Trusted SIL2, SIL3, and TMR systems

Diverse SIS logic solvers use different hardware and software platforms for process safety applications than that used for process control on the PlantPAx system. This approach is used to minimize common cause faults from influencing the overall safety integrity. Triple redundancy minimizes the possibility of any single component failure to cause a spurious or false trip. Diverse process safety integrates with the basic process control on the PlantPAx system by using CIP connectivity including profile support in Logix Designer software (AADvance) or via OPC connectivity (AADvance or Trusted®).

Both the Trusted and AADvance systems share a common EtherNet/IP network within a PlantPAx system. In addition, AADvance and Trusted support redundant Ethernet networks, while the AADvance system supports the CIP producer and consumer communication protocol.

**Table 58 - Diverse SIL 2 and SIL 3 Products**

Category	Description
AADvance system	The AADvance technology is the following: <ul style="list-style-type: none"> <li>• Configurable for SIL 2 and SIL 3</li> <li>• Scalable redundancy for fault tolerance</li> <li>• Simplex, duplex, or triplex configuration</li> </ul>
Trusted system	Trusted technology uses 3-2-0 (3-2-2-0 optionally) fault-tolerant control to virtually eliminate spurious trips. Triple modular redundancy (TMR) uses majority voting to identify a source of failure. Available with OPC or CIP integration.

**Table 59 - Additional Resources**

Resource	Description
AADvance Solutions Handbook, publication <a href="#">ICSTI-RM447</a>	Explains the features, performance, and functionality of the AADvance controller and systems. It sets out some guidelines on how to specify a system to meet your application requirements.
AADvance System Build Manual, publication <a href="#">ICSTI-RM448</a>	Provides experienced panel builders with information on how to assemble a system, switch on and validate the operation of a controller.
AADvance Configuration Guide, publication <a href="#">ICSTI-RM405</a>	Defines how to configure an AADvance controller by using the AADvance Workbench to meet your Safety Instrument Function (SIF) application requirements.
AADvance Safety Manual, publication <a href="#">ICSTI-RM446</a>	Provides mandatory guidance on how to apply AADvance to meet various industry standards and makes recommendations to safely apply AADvance in SIS applications. Explains how to use ControlLogix controllers.
AADvance Troubleshooting and Repair Manual, publication <a href="#">ICSTI-RM406</a>	Provides plant maintenance personnel with information on how to trace and repair a fault in an AADvance system and perform routine maintenance tasks.

## SIL-rated Instruments

SIL-rated instruments are typically required for process safety loops. Rockwell Automation provides premier integration between ControlLogix systems and Endress+Hauser SIL-rated instruments. For more details, see the Endress+Hauser website at <http://www.us.endress.com>.

## PowerFlex SIL 2 and SIL 3 Systems

PowerFlex AC drives offer SIL ratings up to and including SIL 3. Specifically, the PowerFlex 525 AC drive offers Safe Torque Off (STO) as a standard embedded feature with a safety rating of PLd/SIL2 Cat. 3. The PowerFlex 753 and 755 AC drives are available with optional STO functionality with a safety rating of PLe/SIL3 Cat. 3. In addition, the PowerFlex 753 and 755 offer a Safe Speed Monitor option for applications that can benefit from access to a safety zone while there is limited motion. The Safe Speed Monitor option has a rating of PLe/SIL3 Cat. 4.

PowerFlex STO functionality is designed to help safely remove power from the gate firing circuits of the drive's output power devices (IGBT's). This helps prevent the drive's output power devices from switching in the pattern necessary to generate AC power to the motor. Can be used in combination with other safety devices to satisfy the requirements of IEC 61508, IEC 61800-5-2 SIL 3, ISO 13849-1 PL e, and Category 3 for STO.

For more information, see the PowerFlex Low Voltage AC Drives Selection Guide, publication [PFLEX-SG002](#).

## OptiSIS Safety Integrated Systems

The OptiSIS safety system uses an AADvance safety logic solver for a process safety solution that is ready to install and configure with no programming required. OptiSIS lets you configure safety functions by using an intuitive Cause and Effect interface from the HMI display.

OptiSIS includes options for:

- Fail safe or fault tolerant architectures
- Indoor or outdoor environments
- Floor and wall mount
- 50 or 100 I/O count

OptiSIS is a great solution for small process safety applications. In addition, if you have an existing process safety system (for example, an older relay or legacy system) that can no longer be maintained, OptiSIS can provide a cost-effective and short delivery replacement.

For more information, see the OptiSIS Product Profile, publication [SSB-PP030](#).



---

# Services and Support

---

Rockwell Automation offers annual support agreements that help keep your systems running by combining our world-class service capabilities into a service and support process tailored to your unique needs.

Select from the following options:

- [Access to Remote Support Engineers](#)
- [On-site Delivery of Replacement Parts](#)
- [Emergency On-site Engineering Services](#)

Assurance™ Integrated Support features a range of services and support options to help keep your plant operational.

## Access to Remote Support Engineers

We offer system-wide support for troubleshooting. Specialized engineers examine your system to help prevent downtime for optimal performance. A senior engineer is with you every step of the way and assists you throughout the process.

## On-site Delivery of Replacement Parts

A parts management agreement helps to reduce the operating costs associated with managing spare parts. We own, locate, and manage the Rockwell Automation inventory at your site, which provides you access to parts 24 hours, 7 days a week, all year. This agreement is backed by our remanufacturing and renewal parts services to replenish any used inventory.

## Emergency On-site Engineering Services

Day or night, Rockwell Automation field service professionals across the globe are available for dispatch on an as-needed basis. These professionals help troubleshoot and resolve unplanned downtime events, problems affecting critical operations, and other automation-related issues.

Benefits and features include the following:

- 24 x 7 breakdown support
- Factory-trained engineers with skills matched to your application or anomaly
- Assistance for startup, special projects, and peak workloads
- Technical support during maintenance activity

Additionally, support can be expanded to include the following:

- On-site preventative maintenance
- Enhanced and ongoing Installed Base Evaluations and Storeroom Assessments
- Customized application level support
- Network performance assessments
- Full-time resident engineering and/or asset management professionals

**Simple** - You make only one call to initiate technical assistance. If needed, we coordinate the shipment of parts or dispatch a service professional for no additional cost. No new purchase orders to assign. No additional calls to make.

**Flexible** - We offer multiple service levels to help you meet your business goals. You choose the guaranteed level of response for replacement parts to arrive on-site, the arrival time of a service professional, and other pro-active services you need to be successful.

**Worry free** - We can help you avoid unplanned costs and reduce downtime. Achieve greater peace of mind knowing you have the support you need when the unexpected happens.

**Easy to Order** - Contact your Rockwell Automation Distributor or Account Manager for a personalized estimate that includes all the services you need.

For more information, see the Rockwell Automation Assurance Integrated Support website at [www.rockwellautomation.com](http://www.rockwellautomation.com).



Rockwell Automation maintains current product environmental information on its website at

<http://www.rockwellautomation.com/rockwellautomation/about-us/sustainability-ethics/product-environmental-compliance.page>.

AADvance, ArcShield, Allen-Bradley, ArmorBlock, ArmorPOINT, Assurance, CENTERLINE, Compact I/O, CompactLogix, ControlLogix, Dynamix, Encompass, E1 Plus, E3 Plus, E300, eProcedure, FactoryTalk, FLEX, FLEX Ex, Integrated Architecture, IntelliCENTER, LISTEN. THINK. SOLVE., Logix5000, On-Machine, OptiSIS, Pavilion8, PhaseManager, PlantPAx, POINT I/O, PowerFlex, Rockwell Automation, Rockwell Software, RSLinx, RSLogix 5000, Secure Connect, SMC, Studio 5000, Studio 5000 Architect, Studio 5000 Logix Designer, Stratix 5100, Stratix 5410, Stratix 5400, Stratix 5700, Stratix 5900, Trusted, VantagePoint, and XM are trademarks of Rockwell Automation, Inc.

Cisco is a trademark of Cisco Systems, Inc.

Common Industrial Protocol, ControlNet, DeviceNet, and EtherNet/IP are trademarks of the ODVA.

Intel is a trademark of the Intel Corporation.

Microsoft and Windows are trademarks of the Microsoft Corporation.

TUV Rheinland is a trademark of TUV Rheinland.

Trademarks not belonging to Rockwell Automation are property of their respective companies.

**[www.rockwellautomation.com](http://www.rockwellautomation.com)**

---

#### **Power, Control and Information Solutions Headquarters**

Americas: Rockwell Automation, 1201 South Second Street, Milwaukee, WI 53204-2496 USA, Tel: (1) 414.382.2000, Fax: (1) 414.382.4444

Europe/Middle East/Africa: Rockwell Automation NV, Pegasus Park, De Kleetlaan 12a, 1831 Diegem, Belgium, Tel: (32) 2 663 0600, Fax: (32) 2 663 0640

Asia Pacific: Rockwell Automation, Level 14, Core F, Cyberport 3, 100 Cyberport Road, Hong Kong, Tel: (852) 2887 4788, Fax: (852) 2508 1846

Publication PROCES-SG001I-EN-P - April 2016

Supersedes Publication PROCES-SG001H-EN-P - March 2016

Copyright © 2016 Rockwell Automation, Inc. All rights reserved. Printed in the U.S.A.