



Allen-Bradley

GuardMaster®

MatGuard

PRESSURE SENSITIVE SAFETY MAT SYSTEM

I N S T A L L A T I O N & U S E R M A N U A L

READ THIS MANUAL IN FULL BEFORE INSTALLATION

After installation this manual should be retained in a safe and accessible place

MatGuard - Pressure sensitive safety mat system

Installation and user manual

Section 1	STORAGE AND HANDLING	page 4
Section 2	SYSTEM DESCRIPTION	page 5
Section 3	APPLICATIONS	page 8
Section 4	SPECIFICATIONS	page 10
Section 5	INSTALLATION DESIGN	page 14
Section 6	INSTALLATION and COMMISSIONING	page 26
Section 7	USE	page 36
Section 8	MAINTENANCE	page 37

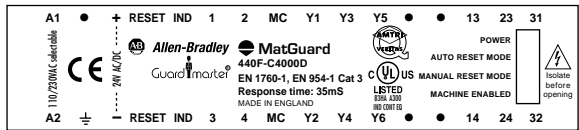
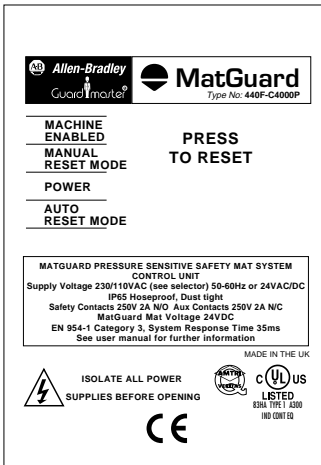

Control unit marking MGCD1

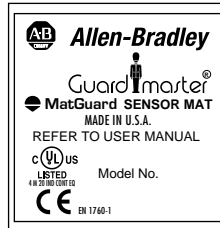

Sensor mat marking

Control unit marking

440F-C4000P & 440F-C4000S

Note: position of reset button is different to above on 440F-C4000S

440F-C4000S



Control unit markings
440F-C28013

The following Standards are referred to in this manual:

- EN 292 - 1&2: Safety of machinery - Basic concepts - General principles for design - Parts 1 and 2
- EN 294: Safety of machinery - Safety distances to prevent danger zones being reached by upper limbs.
- EN 811: Safety of machinery - Safety distances to prevent danger zones being reached by lower limbs.
- EN 953: Safety of machinery - General requirements for the construction of guards.
- EN 954-1: Safety of machinery - Safety related parts of control systems - Part 1: General principles for design.
- EN 999:(Draft Standard) Safety of machinery - Positioning of protective equipment in respect of approach speeds of parts of the human body.
- EN 1050: Safety of machinery - Risk assessment.
- EN 1760-1: Safety of machinery - Pressure sensitive protective devices - Part 1: Pressure sensing mats and floors.
- EN 60204-1: Safety of machinery - Electrical equipment of machines - Part 1: Specification for general requirements.

Information on the availability of these standards can be obtained from BSI Sales Tel: +44 (0) 20 8996 9001
Fax: +44 (0) 20 8996 7001.

INTRODUCTION

The pressure sensitive mat system is designed for use as a safety product in an industrial environment by professional personnel. It provides protection against risks which can be eliminated by the isolation of electrical power when an operator is in the vicinity of the hazard. This manual covers the installation and use of all parts of the system including special shapes and sizes of sensor mats. All installation procedures should be carried out by suitably trained and qualified personnel and should be in accordance with statutory requirements for safety. **READ THIS MANUAL IN FULL BEFORE INSTALLATION.** After installation this manual should be retained in a safe and accessible place. For further assistance please contact the supplier.

Section 1 - STORAGE AND HANDLING

1.1 STORAGE

The control units and mat sensors should be stored within the temperature range -40°C to +70°C. The mat sensors should be stored vertically.

1.2 HANDLING & TRANSPORT

The control units and mat sensors should be transported within the temperature range -40°C to +70°C. The original packaging or similar should be used, together with stiffening if necessary, to give protection from damage and flexing. Always unpack carefully and avoid damage by knives etc.

When sensor mats are being moved into position **NEVER PULL OR LIFT THE SENSORS BY THEIR CONNECTING WIRES.**

For the larger sensor mats, two people are required for safe lifting and to prevent risk of damage to the sensor mats from excessive flexing.

Section 2 - SYSTEM DESCRIPTION

The system comprises one or more interconnected pressure sensitive mats and a control unit. There are no 'dead zones' within the detection zone. Individual sensor mat sections are available in rectangular standard sizes and also in specially cut shapes up to the size of the largest standard mat. All sensor mats have the same construction and operation principle.

Each mat has two conductive plates which are held apart by non-conductive compressible separators. The mats operate at 24V DC and are connected together in series to form a floor level sensing system for hazard areas around machinery. The circuit through the mats is monitored by the control unit which, when the area is clear, provides a signal to the machine control circuit. When any mat is stepped on, the conductive plates touch and the resistance in the circuit drops. This is monitored by the control unit which shuts the machine down. Any single electrical fault in the mat, wiring or control unit will be detected and the control unit outputs will go to a safe (OFF) state. The moulded vinyl sensor mats are sealed to IP 67.

440F-C28013 Control Unit

The unit comprises of an eight-channel sensing mat system. When any mat is stepped on the control unit shuts the machine down and indicates on the CHANNEL FAULT STATUS display which mat is operated.

Two operating modes are available: manual reset and auto reset.

IN MANUAL RESET mode the output 'ON' signal can only be restored after the actuating force has been removed and after a reset. The manual reset is achieved by pushing and releasing the lid mounted control unit reset button or a remote mounted button. At power-on or following the loss and subsequent restoration of power, the outputs will be 'off' until a reset signal is received even if the mat is not actuated.

IN AUTO RESET mode the output 'ON' signal is achieved solely by removal of the actuating force. For both modes, the safety contacts will always be 'OFF' (open) after the mat is actuated. Mode selection is covered in more detail in section 5.

Individual sensor mats connect to each other and to the control unit via 4 wires. The control unit has cross monitored safety relays and it is possible to configure the unit so that an external contactor fault will be detected.

Compliance with the requirements of EN 954-1 category 3 is achieved for the control unit regarding electrical faults and can be met for the associated part of the machine control system. Compliance with the requirements of EN 954-1 category 1 is achieved for the mat sensors.

Section 5 deals with interfacing in detail. The operating principle of the mat is shown in fig. 1.

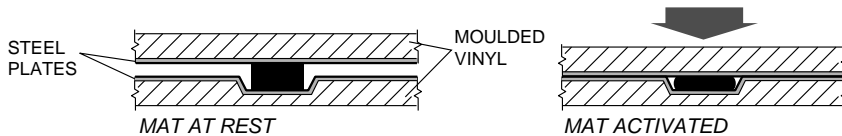

Fig. 1

When the mat is activated the non conductive compressible separators (shown black) compress into their recess allowing the two plates to make contact, giving all over sensitivity. The system is intended for the detection of adult persons with a weight of 35Kg or more. It is suitable for the detection of adults using walking aids (walking sticks or frames).

THE SYSTEM IS NOT SUITABLE FOR THE DETECTION OF CHILDREN.

THE SYSTEM MUST NOT BE USED WITH ANY ADDITIONAL COVERING ON THE MAT.

The vinyl outer surface of the mat is completely sealed to resist the ingress of liquids. It will resist bleaches, acids, salts and most industrial chemicals. Refer to section 5.3.1 for detailed guidance on chemical resistance.

The system operates at 24V DC with restricted fault current. Damage to the mats or interconnecting wiring will not therefore generate any electrical shock hazard in normal circumstances.

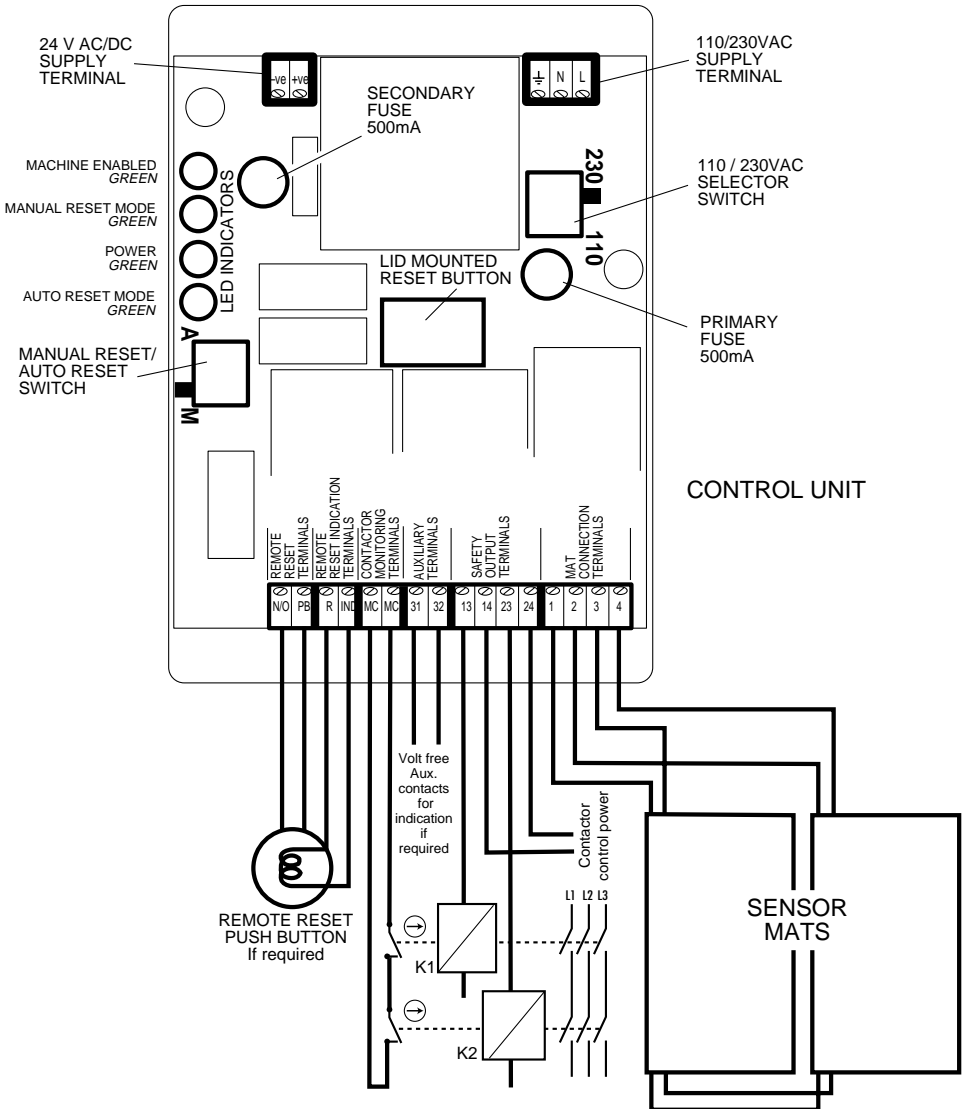

Fig. 2 Basic system and connections (shown with two contactors). 440F-C4000P and 440F-C4000S.
 Note: position of reset button is different to above on 440F-C4000S.

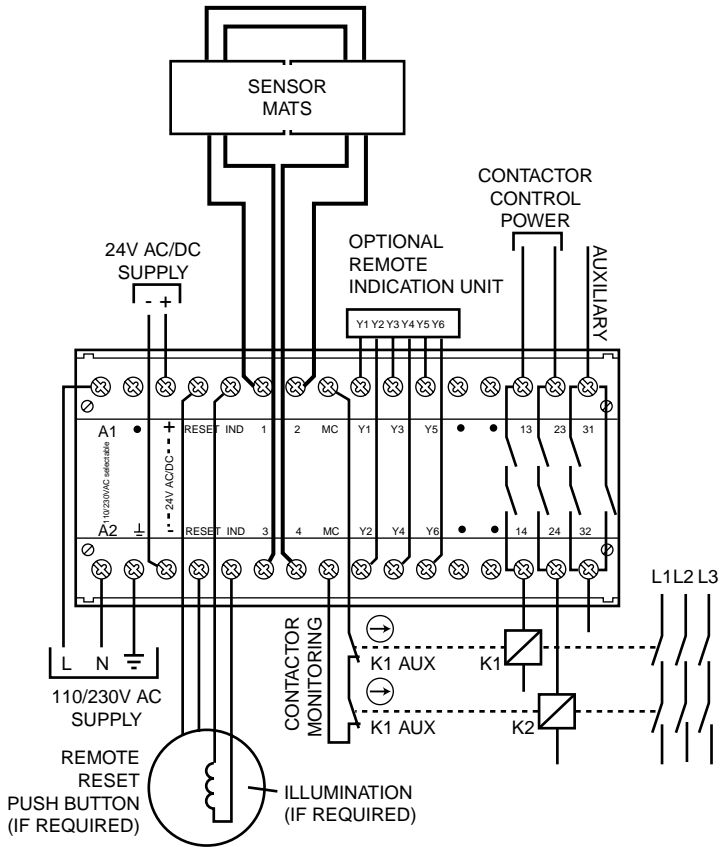

Fig. 3 Basic system and connections (shown with two contactors). 440F-C4000D

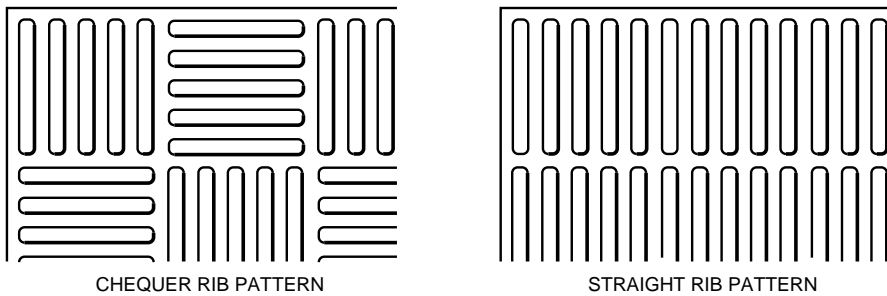

Fig. 4 Alternative rib patterns.

The mat sensors have two different rib patterns as shown. Either pattern may be used as the upper surface. The chequer pattern gives the best grip in all directions. The straight rib pattern is easier to hose/wash down and is more suitable for use in dirty or hygiene sensitive applications.

Section 3 - APPLICATIONS

It is important that the type of safeguarding system is suitable for the application for which it is intended. A documented process of risk assessment of the machinery or process will reveal the identity and nature of the hazards together with other relevant information. The characteristics of the safeguarding system should then be compared with the results of the risk assessment to determine whether the risk can be reduced to an acceptable level. On some applications the combined use of more than one type of safeguarding system may be necessary to achieve an acceptable level of risk.

- The system is designed for the protection of personnel by sensing their presence on floor areas around machinery and other similar hazards.
- The system must be used only within the specification limits given and be installed strictly in accordance with the information provided in this manual.
- The system alone does not provide protection against hazards arising from the ejection of materials, gasses and radiation. For these applications additional protective measures such as physical guards may be required.
- The system is not intended for use as a perimeter only guard.
- The system is not intended for use as a machine initiation or re-initiation device. The machine control circuit must be configured such that closing of the systems output contacts enables the starting circuit of the machine but does not directly cause the machine to start up. The starting or restarting of the machine should only be possible by a separate and deliberate action at the designated machine controls.
- The system is not suitable for use in explosive atmospheres.
- If further guidance is required concerning the suitability of the system for a specific application please contact supplier.

USE AS A COMBINED TRIP AND PRESENCE SENSING SYSTEM

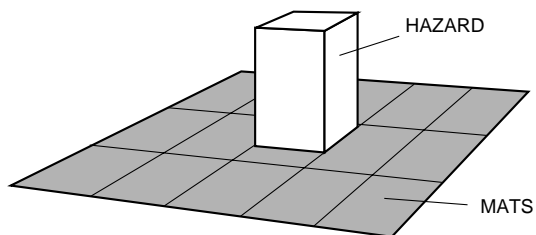

Fig. 5 Use as a combined trip and presence sensing system.

The system allows a clear view of the process and unhindered access for operators and some types of vehicles.

- There must be sufficient space to allow the minimum distance from the hazard to the accessible mat perimeter to be in accordance with safety distance calculations given in section 5.
- The entire floor area between the defined perimeter and the hazard must be covered by mat sensors so that it is not possible to approach or be in the vicinity of the hazard without actuating the mat system.

USE AS A PRESENCE SENSING SYSTEM WITHIN A GUARDED PERIMETER

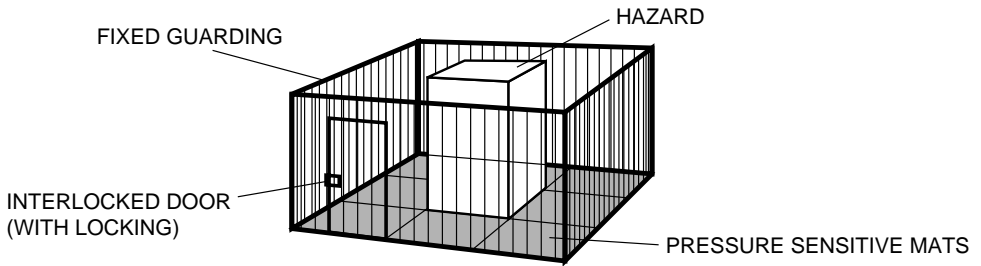

Fig. 6 Use as a presence sensing system within a guarded perimeter.

The system provides presence sensing to prevent any possibility of the machine being started whilst personnel are inside the enclosed area.

- The safety distance calculations given in section 5.4.1 are not applicable when the system is used in this way as a secondary protective system. The perimeter guarding method should conform with all relevant requirements.
- The entire floor area between the enclosed perimeter and the hazard must be covered by mat sensors so that it is not possible for personnel to be in the enclosed area without actuating the mat system.

Section 4 - SPECIFICATIONS

Control Unit	440F-C4000P	440F-C4000S	440F-C4000D
Conformity	EN 1760-1, EN 60204-1, EN 954-1: CATEGORY 3, UL 508		
Response time (mat pressed-safety contacts open)	35mS		
Environmental protection	IP65	NEMA12	Enclosure-IP40 DIN0470 Terminals-IP20 DIN0470
Impulse withstand voltage	2500V		
Contamination level	III		
Min switched current/voltage	10mA/10V		
Power supply - user select	110/230V AC (50-60Hz) and 24V AC/DC +10% -15% (110V setting also allows use at 100v ±10%)		
Power consumption	<9 VA 6W		
Relay outputs	2 x independant volt free N/O safety contacts 1 x volt free N/C auxilliary contact NB - Aux must not be used for safety circuit Fuse externally, 5A max (quick acting) for AC 2.5A max (quick acting) for DC AC - 15 ; 4A / 250V AC DC - 13 ; 2A / 30V DC 24V DC / 0.24W		
Utilisation category	Remote reset switch (2 x N/O) 4 wire mat		
Outputs: remote reset/indicator	LED 1 Power GREEN LED 2 Auto reset mode GREEN LED 3 Manual reset mode GREEN LED 4 Machine enabled GREEN		
Inputs	AC Voltage selector, auto/manual reset selector		
Safety inputs	500mA Replaceable (2 off) 500mA Replaceable (2 off) 500mA Replaceable (1 off) 500mA Resettable (1 off)		
Indicator LEDs			
Internal controls			
Internal supply fuses			
Operating temperature range	-10°C to +45°C		
Humidity	Up to 90% RH at +50°C		
Vibration	Tested in accordance with IEC 68-2-6, frequency range 10 - 55Hz, displacement 0.15mm 10 cycles per axis, sweep rate, 1 octave per minute		
MC-MC Contactor monitor loop	Normally closed contactor loop		
Maximum conductor size	1 x 1.5mm ² stranded with sleeves stripped 5mm, 1 x 2.5mm ² solid conductor	1 x 1.5mm ² stranded with sleeves stripped 5mm, 1 x 2.5mm ² solid conductor	2 x 1.5mm ² stranded with sleeves stripped 8mm, 2 x 2.5mm ² solid conductor
Terminals	Minus terminal screws M2.5 mounted at 45° to PCB	Minus terminal screws M2.5 mounted at 45° to PCB	Plus/minus captive terminal screws M3.5 with self lifting connection, washer terminal boards separately removable
Installation group	C in accordance with VDE 0110		
Material	Polycarbonate	Steel c/w polycarbonate screen	Polycarbonate
Fixing details	4 x M4 holes	4 x M6 holes	35mm din-rail
Misc.	N/A	N/A	In the manual reset mode (M), a reset button must be connected
Housing	D = 75mm H = 180mm W = 130mm	D = 143mm H = 230mm W = 210mm	D = 120mm H = 73mm W = 152mm 32 way din-rail
Weight	880g	3,200g	920g

Control Unit	440F-C28013		
Power supply	24V AC/DC or 110/230V selectable		
Relay outputs	2 x independant volt free N/O safety contacts 1 x independant volt free N/C monitored contact 1 x volt free N/C auxilliary contact 1 x volt free N/O auxilliary contact		
Safety inputs	8 x 4 wire mats with molded Allen Bradley connectors		
Indicator LEDs	LED 1	Power	GREEN
	LED 2	Manual reset mode	GREEN
	LED 3	Auto reset mode	GREEN
	LED 4	Machine enabled	GREEN
	LED 5-12	Channel fault status	GREEN/RED
Terminals	Minus terminal screws M2.5 mounted at 45° to PCB		
Note: for all other specifications and dimension details please refer to the 440F-C4000S control unit.			

SENSOR MAT

Sensor mat conformity:	EN 1760-1, EN954 -1: CATEGORY 1, UL 508
Minimum weight of person with assured detection:	35Kg
Maximum detection zone:	100m ²
Maximum number of individual mats:	No limit (up to max 100m ²)
Maximum total length of connection wires:	200m
Mass / m ² (sensor mats):	24Kg
Environmental protection mats:	IP67
Mechanical life:	1 x 10 ⁶ operations
Humidity:	0 - 100% RH
Sensor mat outer covering material:	Vinyl
Standard colour:	Yellow
Operating temperature range	-10°C to + 55°C
Storage temperature range	-40°C to +70°C

The system comprising of interconnecting sensor mats and control unit meets the requirements of EN 954-1 category 3.

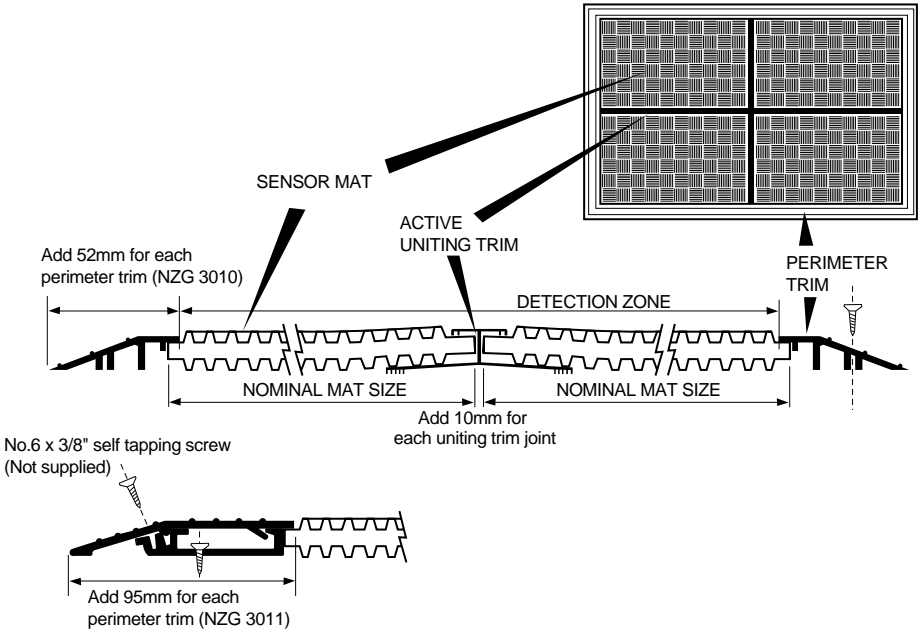

Fig. 7 Detail of perimeter trim and uniting trim showing detection zone.

- For guidance on machine interfacing see Section 5.
- For details of the fixing and interconnection arrangements see Section 6.

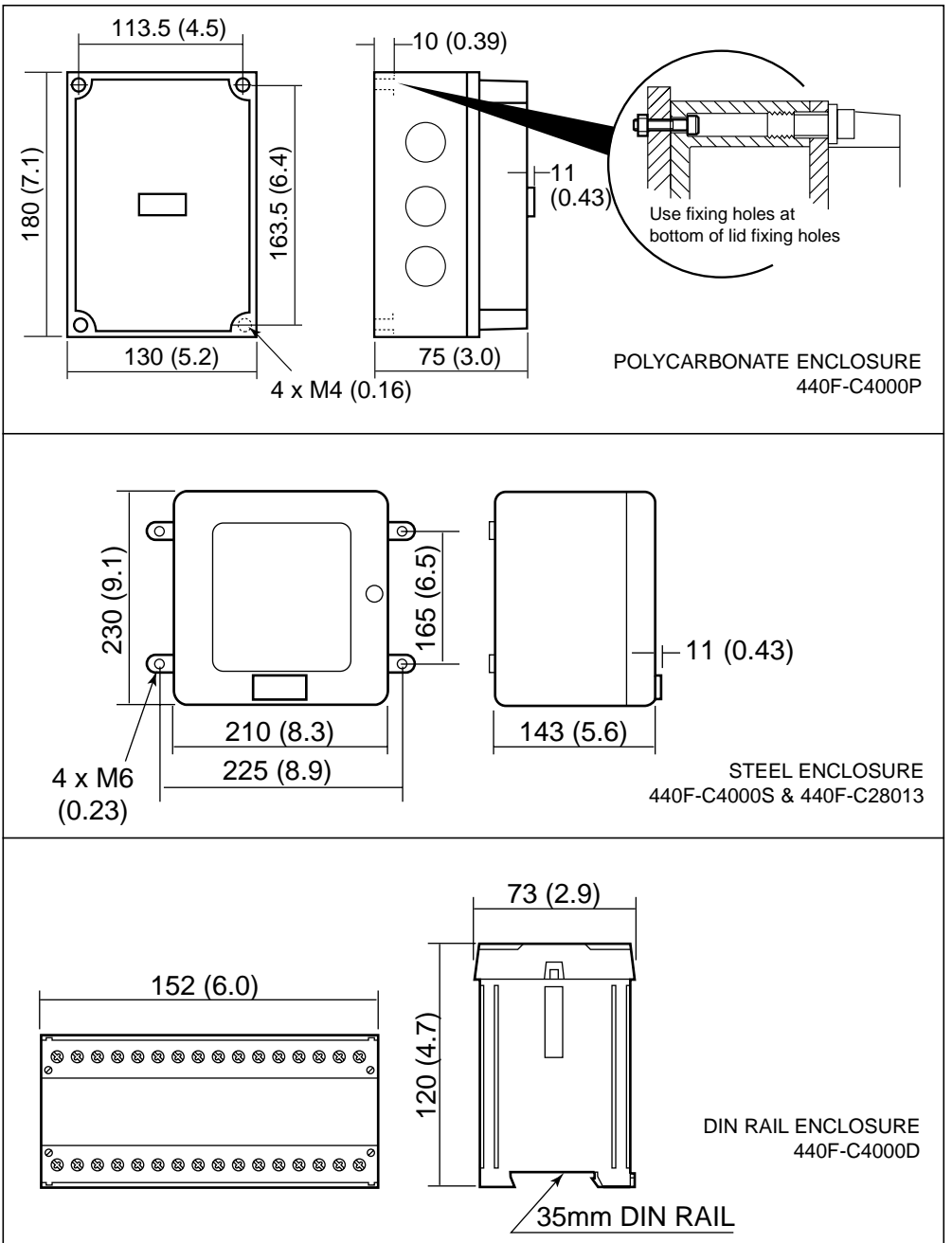

Fig. 8 Dimensions in mm (inches) - not to scale.

Section 5 - INSTALLATION DESIGN

This manual should be read in full before installation is commenced.

It is recommended that installations should only be designed by persons suitably competent in electrical and mechanical engineering and having experience in safety related control system design.

Many factors contribute to a safe and reliable installation. Working through the following steps will ensure that nothing is overlooked and that the installation can be planned and implemented with minimum fuss and maximum confidence. The detail of the procedures which follow is based on European best practice, and compliance with EU Machinery Directive. Even if these requirements do not apply in your installation, we recommend that you follow the same steps but modify the detail to suit relevant statutory requirements or codes of practice (e.g. ANSI, OSHA).

5.1 NATURE OF HAZARD

The system provides protection against risks which can be eliminated by the isolation of electrical power when an operator is in the vicinity of the hazard.

Additional measures be required to deal with other hazards identified at a risk assessment (e.g. part ejection, hot surfaces etc.). These measures may include fixed guards, interlocked guards, warning notices etc. Contact supplier for further information if required.

NOTE: Risk assessment is included in EN 291-1 and detailed in EN 1050.

5.2 NATURE OF SAFEGUARDING

The system design must satisfy three main requirements:

1. The machine must be stopped if a person is in a position of being able to reach into the hazard zone.
2. The machine must come to a stop before an approaching person can be in the position of being able to reach into the hazard zone.
3. The system shall not be easily bypassed.

The recommended use of the mat system gives presence sensing over the whole area where access is possible to the hazard. (see the examples in fig. 9). Other uses of mat system, for example, solely as a perimeter access guard, or as a machine enabling device are not recommended. If you are considering mat system for any application not covered by this manual, please contact Supplier.

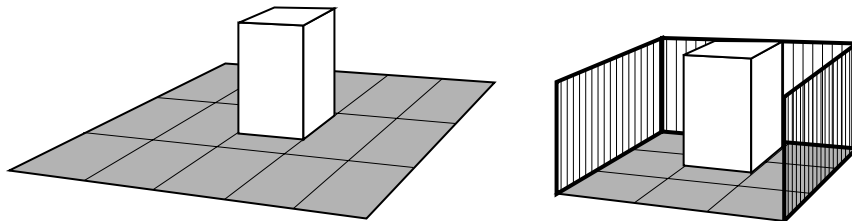

Fig. 9

5.3 ENVIRONMENT AND OPERATING CONDITIONS

By reference to the specifications given in section 4 and the information in this section, ensure that there are no adverse factors which could compromise the integrity of the system.

5.3.1 CHEMICAL RESISTANCE OF SENSOR MAT VINYL COVERING

<i>Substance</i>	–	<i>Resistance of mat covering</i>
WATER	–	EXCELLENT
ETHYL ALCOHOL	–	EXCELLENT
SODIUM CHLORIDE	–	EXCELLENT
BLEACH	–	EXCELLENT
HYDROCHLORIC ACID	–	FAIR to EXCELLENT
SULPHURIC ACID	–	FAIR to EXCELLENT
NITRIC ACID	–	FAIR to EXCELLENT
ACETIC ACID	–	FAIR
PETROL (GASOLINE)	–	FAIR
TRICHLORETHYLENE	–	FAIR to POOR
BENZENE	–	POOR
ACETONE	–	POOR

In general the covering has excellent resistance to acids, alkalis and salts.

Hot acids and alkalis, as well as concentrated and organic acids, have a deleterious effect on prolonged exposure. The covering has fair resistance to aliphatic solvents, fair to poor resistance to aromatic and chlorinated solvents and poor resistance to ketones and most esters.

NOTE: Combinations of chemicals can have unpredictable effects. Testing is recommended in such cases. Small pieces of the vinyl material are available from supplier if testing is required.

5.3.2 SLIPPING / TRIPPING HAZARDS

Both sensor mat patterns provide a non-slip surface under most conditions but should be kept free from large deposits of grease, soaps or gels. If the straight rib side is uppermost, it is recommended that the ribs run across the hazard to give improved grip.

5.3.3 WEAR AND DAMAGE

The mat outer surface can be damaged by impacts from sharp or heavy objects. After every such event the mat should be inspected for deformation or puncturing and replaced if necessary.

Mats have been designed and tested to withstand one million operations in any one spot. In use, this number of operations in any single location should not be exceeded.

Occasional heavy loads, (e.g. up to 3 tonne trucks) are unlikely to damage the mats but they should not be used on traffic through routes.

5.3.4 EXPLOSIVE ATMOSPHERES

The system is not suitable for use in explosive atmospheres.

5.3.5 E.M.C.

The mat system complies with the requirements of the European EMC Directive. Normal operation under interference conditions likely in industrial environments is assured and has been tested and certified.

NOTE: Special measures may be required in the presence of abnormally high levels of E.M.I. e.g. near to welding or induction heating equipment or near radio transmitters/transceivers.

5.3.6 FLOOR

The floor or mounting surface for the sensor mats must be flat, smooth and rigid, i.e. show no perceptible distortion under the heaviest load anticipated. Undulations, protrusions, large gaps or other irregularities will increase the sensitivity of the sensor mats and may result in intermittent unintended switching off (nuisance tripping).

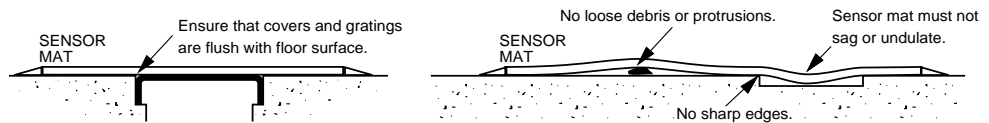

Fig 10 Floor condition for mats.

Small and regular protrusions such as chequer plate pattern are acceptable. Skimmed concrete floors are ideal. If any doubt exists please contact the supplier.

5.3.7 CONTROL UNIT MOUNTING (refer to section 4 fig. 8)

The control unit **MUST NOT** be mounted within the detection zone.

If access to the control unit is required for manual reset or routine indicator observation, it should be mounted at an accessible position outside the protection zone which provides a good view of the hazard and protection zone.

The reset actuator shall be situated outside the protection zone and in a position giving good visibility of the hazard and protection zone.

In other cases, the control unit may be mounted anywhere convenient outside the protection zone taking into account the access requirements for test and maintenance.

The 440F-C4000D control unit should be mounted within an enclosure to a minimum of IP 54 (in accordance with EN 60529).

NOTE: the Control unit is not suitable for direct exposure to high pressure cleaning.

5.4 MAT POSITIONING

5.4.1 FOR USE AS A COMBINED TRIP AND PRESENCE SENSING DEVICE

The positioning of the mat edges is calculated as a horizontal distance from the hazard zone. Define the hazard zone as a volume, taking into account all the possible modes of the machine and all variations in size of the workpiece. It is essential to record the dimensions and position of the hazard zone and the assumptions used, so that the adequacy of the safeguarding can be checked.

If other safeguarding measures are used in conjunction with the mat system they may affect the

requirements for the size and positioning of the mats as shown in Fig. 11.

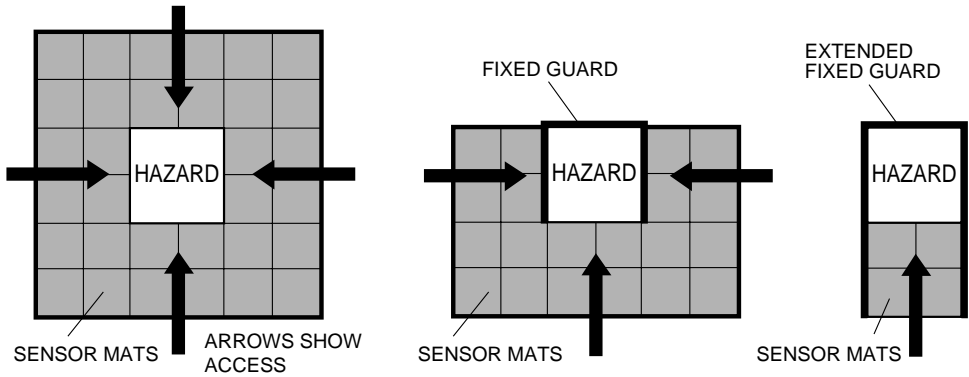

Fig. 11. NOTE: Fixed guarding should meet the requirements of EN 953, EN 294 & EN 811.

Firstly, ascertain the route(s) where unobstructed access to the hazard zone is required across the mat system. Take into account all the routine needs for access, such as product inspection, machine inspection and adjustment, tool changes & clearing blockages. Consider also visual observation of the process. Take into account the space requirements of persons and ancillary equipment close to the machine during interventions.

SAFETY DISTANCE CALCULATIONS

For applications using the mat system as a combined trip and presence sensing system these should be done in accordance with EN999. The flow chart at fig. 12 shows the essential steps.

NOTE: If the machine is designed in conformity with an existing harmonised European "C": type standard for that machine which gives specific formulae or minimum distances, then these should be used in preference to those given in EN 999.

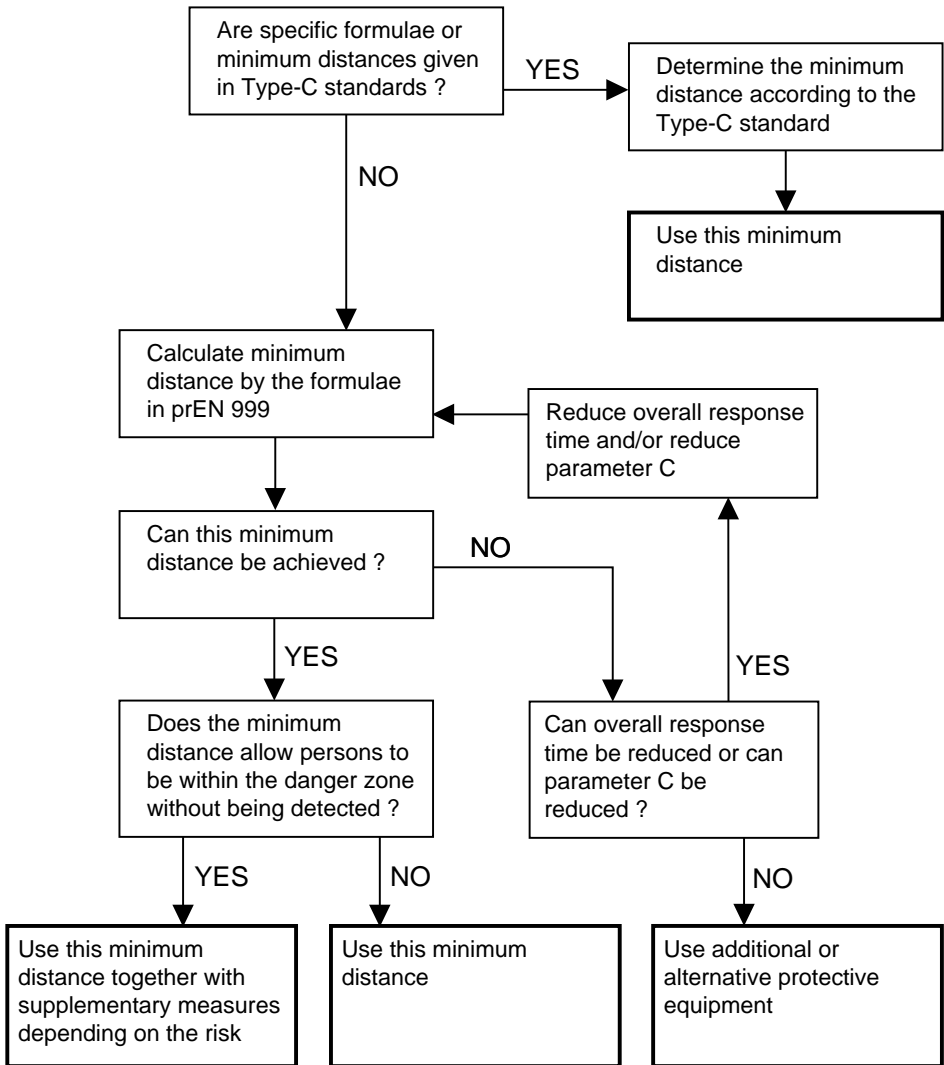

Fig. 12 FLOW CHART SHOWING METHODOLOGY

The minimum distance calculated is the minimum horizontal distance from the outer edge of the sensor mat detection zone to the nearest part of the hazard.

The EN 999 formula for floor mounted safety mats is $S = (1600 \times T) + 1200\text{mm}$

S is the minimum safety distance in millimetres

The factor of 1600 is based on the standard assumption of 1600mm/s as the approach speed.

T is the overall stopping time in seconds

The added 1200mm is parameter C given in EN 999 and takes into account stride length and arm reach.

The overall stopping time T is made up of two parts: $T = t_1 + t_2$

t_1 is the maximum time between actuation of the sensing function and the output signal switching devices being in the OFF state.

For the mat system, $t_1 = 35\text{mS}$.

t_2 is the response time of the machine i.e. the time required to stop the machine or remove the risks after receiving the output from the mat system.

The response time of the machine used in the calculation needs to be the worst case time. Some machines have inconsistent response times which are dependent upon mode of operation, nature of the workpiece and point in the operating cycle at which stopping is initiated. An allowance should be made for wear in brakes etc if this can affect the response time. An allowance for further delays in the machine control system may be required in some circumstances.

CALCULATION EXAMPLE

In this example the mat system is being used with a machine whose worst case response time has been measured as 0.485 seconds.

Using the formula,

$$\begin{aligned} T &= t_1 + t_2 \\ &= 35\text{mS} + 485\text{mS} \\ &= 520\text{mS} = 0.520\text{S} \end{aligned}$$

$$\begin{aligned} S &= (1600 \times 0.520) + 1200\text{mm} \\ &= 832 + 1200\text{mm} = 2032\text{mm} \end{aligned}$$

Sensor mats will be required from 2032mm right up to the edge of the machine baseplate.

5.4.2 FOR USE AS A PRESENCE SENSING SYSTEM WITHIN A PERIMETER GUARDED AREA

If the area around the hazard is totally enclosed within a guarded perimeter, the requirements of prEN 999 may not apply. In these applications the mat system detects the presence of an operator to prevent the perimeter guarding system being reset and the machine re-started while the operator is inside the enclosure.

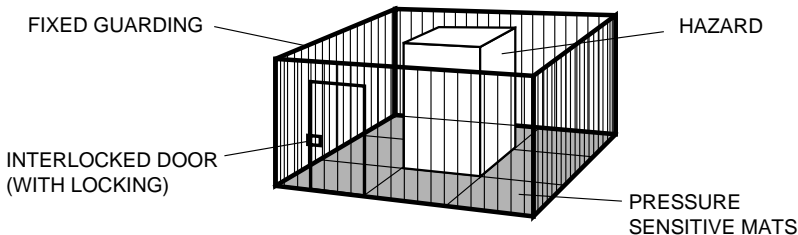

Fig. 13 NOTE: Fixed guarding should meet the requirements of EN 953, EN 294 & EN 811.

A suitable perimeter guarding system would be a fixed guard with an access door fitted with an interlock switch with conditional guard unlocking (see EN 1088). A trip device such as a safety light curtain may also be suitable for some applications. It is important to note that the positioning of the light curtain must be calculated according to EN 999.

When using the mat system for these applications the entire enclosed floor area accessible to the operator should be covered by sensor mats.

5.5 FIXED GUARDS

The fixed guards should be designed so that access is not possible to the hazard zone other than via mat system. Guard construction and positioning should be in accordance with EN 953, EN 294 and EN 811.

5.6 GOOD INSTALLATION DESIGN AND MEASURES AGAINST BYPASS

It must not be possible to reach the hazard without standing on the mats.

Access to the hazard zone from positions which do not involve standing on the mats must be prevented. This will typically require additional angle plates and careful positioning of pipework and trunking. Good practice in this respect is illustrated in fig. 14.

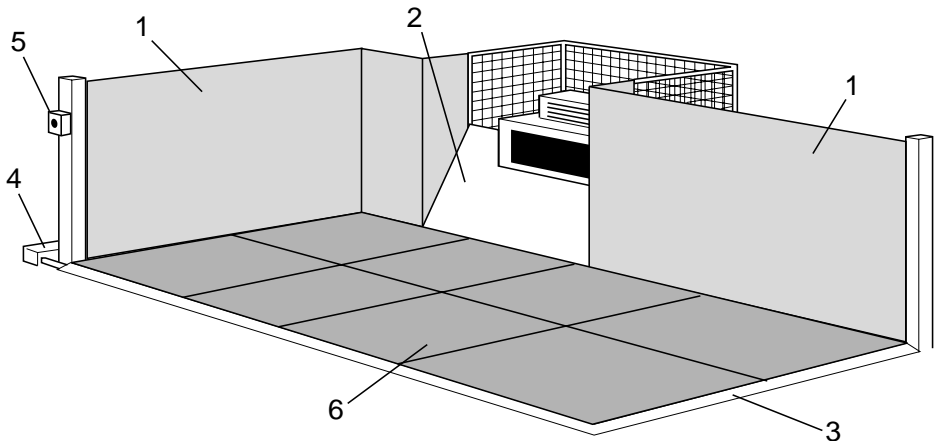

Fig 14

1. Fixed guards prevent access to the hazard zone in such a way that there is no access between the guard and sensors.
2. A sloping cover plate prevents the operator eluding the sensing area by standing on the machine base plate.
3. The tripping hazard at the sensor edge is reduced by a ramp at the point of access. The ramp may also protect connecting cables. The optional perimeter trim is a ramp section.
4. Cable trunking is installed outside of the fixed guard. This prevents its misuse as access to the hazard zone.
5. A reset button is located in a well protected location giving full visibility of the machine.
6. Mats are properly installed.

5.7 ELECTRICAL INTERFACING

THE PROTECTION PROVIDED BY THE SYSTEM DEPENDS ON THE CORRECT INTERFACING BETWEEN THE SYSTEM AND THE MACHINE.

The safety output contacts from the system are arranged as two independent voltage free N/O contact pairs. The terminal positions are given in section 6.2 and ratings are given in Section 4.

The control unit conforms to category 3 according to EN 954-1. In common with other safety mats and floors, category 3 performance for the sensor mat cannot be achieved for faults resulting from severe mechanical damage or long term degradation. The sensor mats conform to category 1 according to EN 954-1.

The system comprising of interconnecting sensor mats and control unit meets the requirements of EN 954-1 category 3.

The mat system may be used as the sole protective measure or in combination with other measures or devices (e.g. safety light curtain, system of work).

Where a harmonised European “C” standard is available for the machine type, it will contain requirements and guidance for the machine’s safety related control system. EN954-1 also provides guidance. It is important that an adequate level of protection against foreseeable faults is provided to the appropriate category of EN 954-1 and for this reason it is recommended that a dual channel configuration with duplication and monitoring of the final switching elements (contactors) is used on all higher risk applications.

Examples of interconnections of the mat system are given in figures 15, 16, 17 and 18.

24VDC, SUPPLY

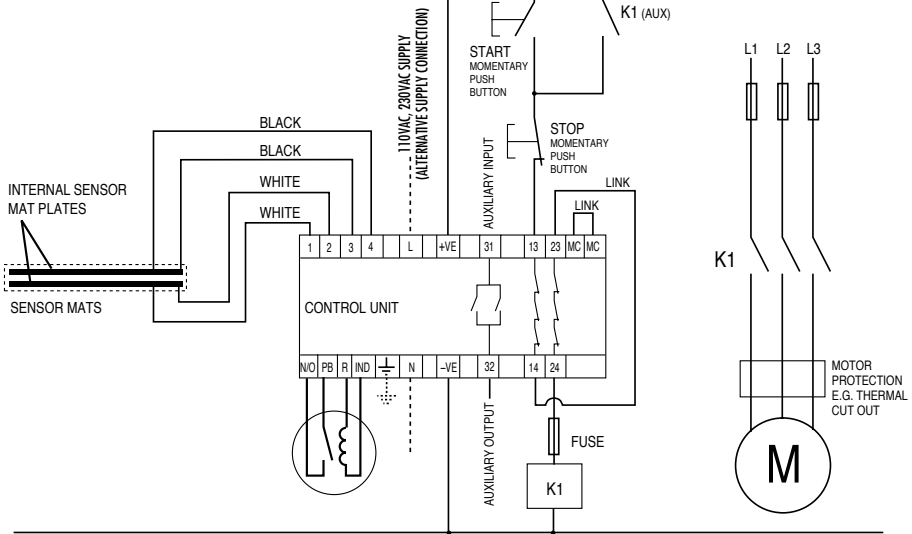

Fig. 15 Example connection diagram showing application with single contactor (single channel), 440F-4000P and 440F-C4000S. Circuit status - Supply power ON - No presence on sensor mat - Reset button operated (if in manual reset mode) - Machine start circuit enabled.

NOTE: If the contactor sticks ON - the motor will not stop when the mat is stood on.

24VDC, SUPPLY

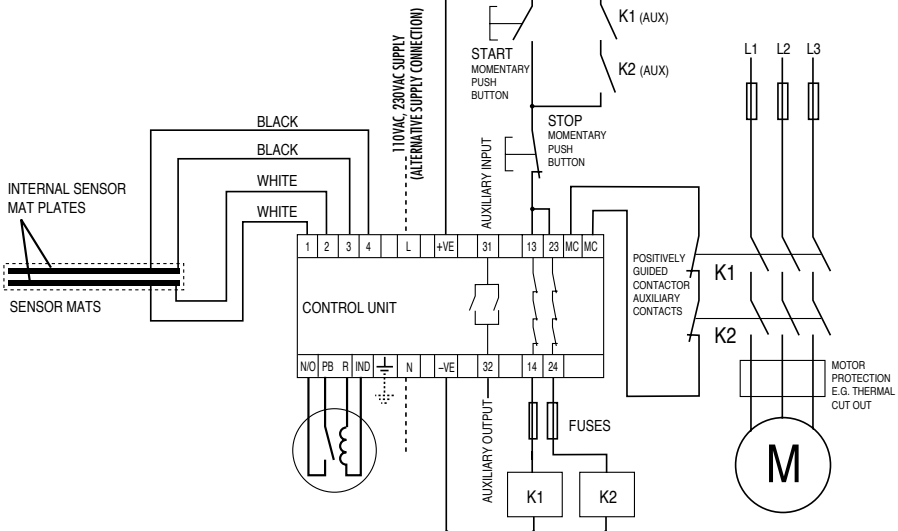

Fig. 16 Example connection diagram showing application with two contactors and contactor monitoring (dual channel), 440F-4000P and 440F-C4000S.

Circuit status - Supply power ON - No presence on sensor mat - Reset button operated (if in manual reset mode) - Machine start circuit enabled.

NOTE: If either of the contactors stick ON - the motor will stop when the mat is stood on and the fault will be detected.

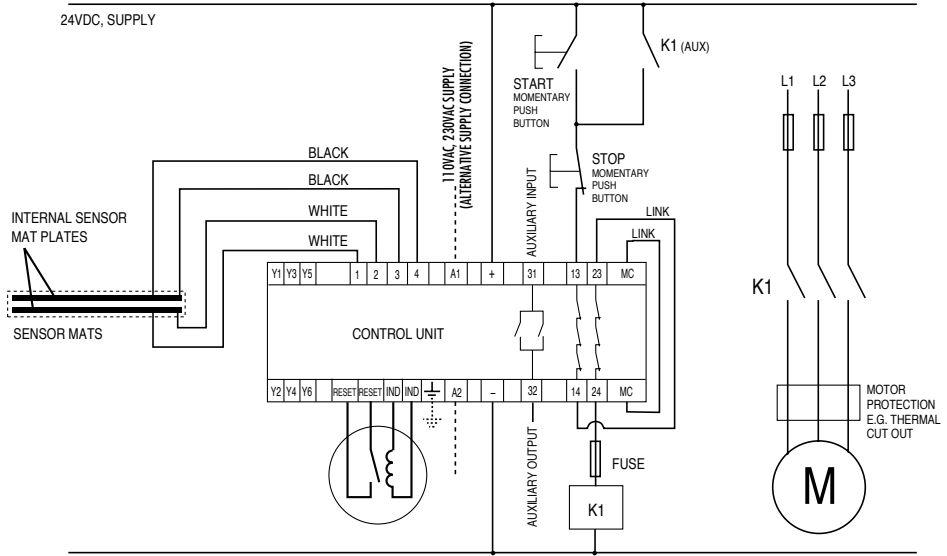

Fig. 17 Example connection diagram showing application with single contactor (single channel), 440F-C4000D. Circuit status - Supply power ON - No presence on sensor mat - Reset button operated (if in manual reset mode) - Machine start circuit enabled.

NOTE: If the contactor sticks ON - the motor will not stop when the mat is stood on.

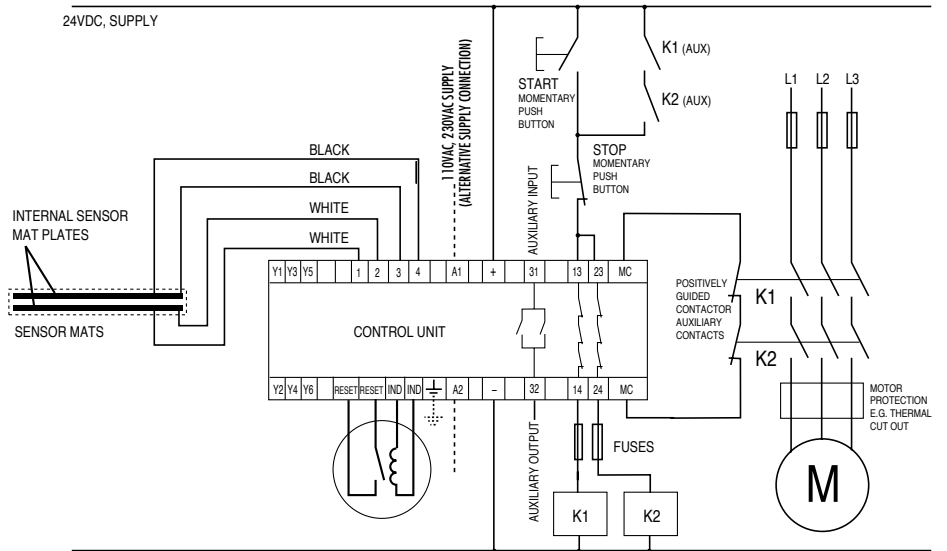

Fig. 18 Example connection diagram showing application with two contactors and contactor monitoring (dual channel), 440F-C4000D.

Circuit status - Supply power ON - No presence on sensor mat - Reset button operated (if in manual reset mode) - Machine start circuit enabled.

NOTE: If either of the contactors stick ON - the motor will stop when the mat is stood on and the fault will be detected.

After completion of the design of the safety related control system ensure that the response time assumed at 5.4.1 remains valid. If the value changes, it will be necessary to repeat the safety distance calculations.

Next consider the options for reset. The consequences of the reset scheme selected should be carefully considered for hazards caused by unexpected start up etc., both under normal conditions and under fault conditions. Timing diagrams are given below for both modes of the mat system.

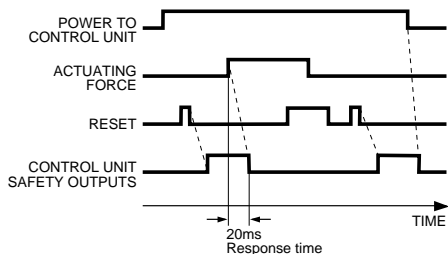

Fig 19 Manual reset mode
Relationship between actuation, reset and output.

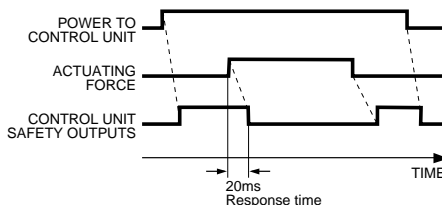

Fig 20 Auto reset mode
Relationship between actuation and output

MANUAL RESET MODE

The reset can be accomplished by the button on the control unit or by a remote push button or by voltage free contacts within the machine safety related control system. The outputs of system will remain off until reset after power up and may require master/slave reset circuits in complex systems where other power up interlocks (start interlocks) are present.

AUTO RESET MODE

When used in the auto reset mode, the machine's control system will need a separate reset function to prevent machine start up when stepping off the mat or after a temporary power supply failure or dip.

SELECTING THE POWER SUPPLY

The system offers four possibilities for power supply and in virtually every case a suitable supply will be available from the machine. Check that the power supply parameters conform with the requirements of mat system as given in the specification. Where a 24V AC or DC supply is used it must be isolated from the mains supply in accordance with international electrical safety practice (IEC 364-4-41). One pole should be earthed (negative to be earthed for DC supplies). If special arrangements have to be made, commercial units supplying 24V DC to suit the system are readily available.

AUXILIARY OUTPUT

This is a non-safety output provided as a status output. It is particularly useful in systems using PLC functional machine control in combination with hard wired safety circuits as a status import to the PLC. Other uses include diagnostics in protection schemes and/or driving status lamps or alarms. The safety function must not depend on this output.

ARC SUPPRESSION

Arc suppression networks or devices are recommended for all inductive loads. For safety circuits, suppressors should be fitted across the load and never across the contacts. The type and ratings of the suppressors will be determined by the supply and load characteristics. Note that suppressors can increase response time, particularly suppressor diodes across DC coils, and should be in place when measuring response times.

CONTACTOR MONITORING

Contactors monitoring is provided via the two terminals marked MC. It should be used in all dual channel two contactor systems. If one of the contactors fails to isolate the power, the mat control unit will lock out and prevent the re-energisation of the other contactor until the fault is rectified.

5.8 FINAL SENSOR MAT LAYOUT

Having considered these factors, the sensor mat layout can now be checked and finalised. Consider whether the machine response time has changed from the initial calculations.

Whenever possible, mats should be arranged with the wires at the outside edge of the detection zone. This simplifies installation and replacement if required and all wiring is protected by the perimeter trim.

5.9 WIRING

All system wiring must be protected from mechanical damage and suitably sealed for the operating environment. Waterproof butt connectors are supplied for mat to mat connections and are protected by the edge trim. Where wire runs are required across the floor, the 440F-T3230 wire guide can provide suitable protection. Conduit or trunking should be used for other wire runs. The sealing integrity of the control unit must be maintained by the use of correctly sized and tightened conduit fittings or cable glands to IP65.

Wiring practices must be in accordance with EN 60204-1 Clause 14.

NOTE: In order to ensure the isolation of the 110/230V supply, the input power supply must be separately routed and enter the control unit via separate fittings or glands to those used for the output wiring. Wiring from the control unit to the mat may be buried in the floor using conduit, or pass via the edge trim. Flexible conduit is recommended for this type of installation. See section 6 for further details.

Determine the wiring method and determine the input and output connection points for the mat to control unit wiring.

5.10 FINAL DETAILS

Prepare a work schedule and drawings of the installation layout and the electrical circuit. It is recommended that all measurements and calculations are recorded and retained in the technical file for the machine.

Section 6 - INSTALLATION AND COMMISSIONING

This manual should be read in full before commencing installation.

Study this section completely before starting work.

The installation and commissioning should be supervised by the system designer. A mechanical technician and an electrician familiar with industrial wiring practices will be required to undertake the installation.

Commissioning should be undertaken by a trained electrical technician experienced in safety installations.

The following special tools are required:

Crimp tool for pre-insulated butt splice connectors (e.g. Raychem AD-1522-T)

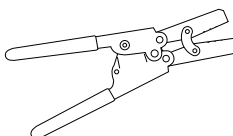

Fig. 21

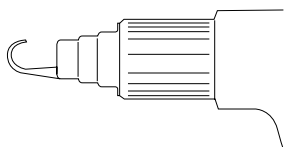

Fig. 22

Hot air gun with reflector attachment for heat shrinking (e.g. Raychem HL1802E)

6.1 MAT INSTALLATION

Isolate and lock off the machine power supply at source. Check that the floor is flat, smooth, clean and free of debris and that any buried conduit or other wiring provision is correctly in place. Unpack the mats being careful to keep them flat and not to pull on the wires. Place the mats on the floor in the planned positions with the connecting wires at the periphery of the detection zone. Connect the mat sections together according to fig. 23.

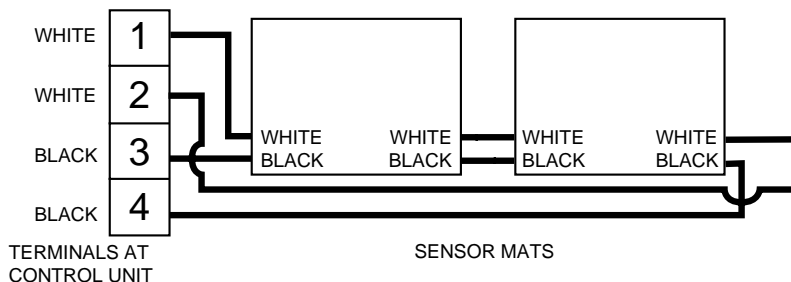

Fig. 23

NOTE: The mat wires have a black outer covering. Two have a black inner sheath and two have a white inner sheath (see fig. 23 for positions).

Leave sufficient wire tail length to enable the connection to be remade if a mat is to be replaced, but ensure that the interconnecting wires will fit easily under the edge trim without crushing. Join the wires using butt connectors supplied as shown in Fig. 24 below. Where mat wires require extending, e.g. front mat to rear mat connections, and control unit connections, use an extra pair of the butt connectors and a length of twin wire (see wiring specification - section 6.2).

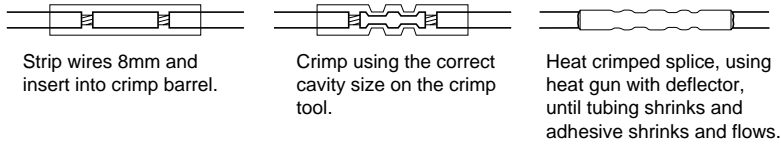

Fig. 24

UNITING TRIM FIXING

All active uniting trim sections used in installation must be mitred to 45°. This aids in installation and helps retain overall sensitivity of the sensing area.

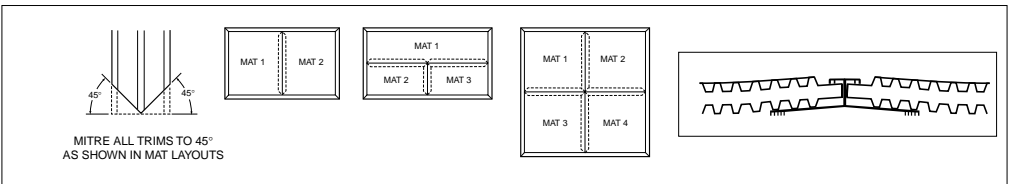

Fig. 24a

PERIMETER TRIM FIXING

Where the wiring to the control unit is not buried, notch the perimeter trim at the wire entry and exit positions and cut the trim slope to suit the conduit system selected. Take care to notch completely so that any flexing of the perimeter trim will not trap the wiring. Ensure that there are no sharp edges or burrs which could damage the wires.

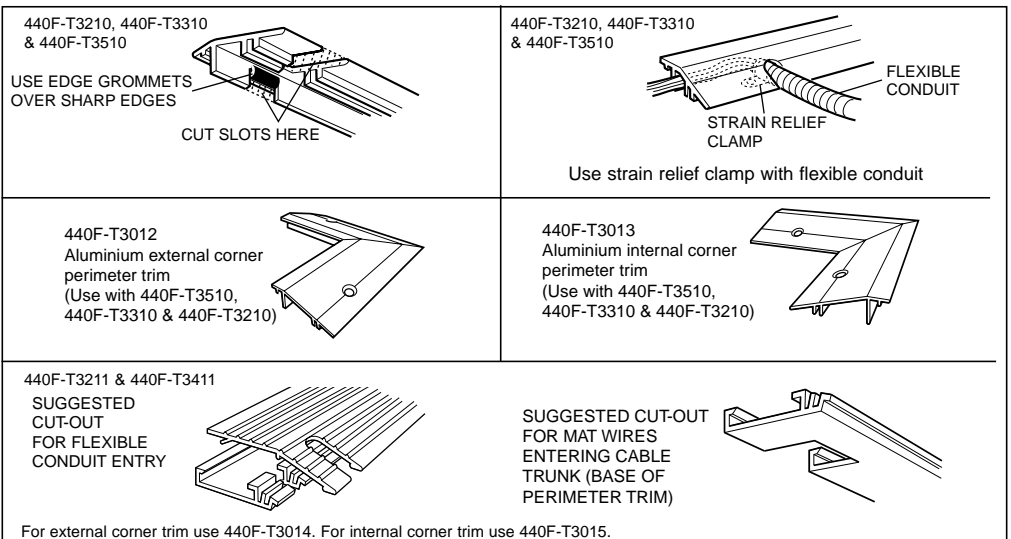

Fig. 25 Details of trim fixings

Mark out the edge trim fixing positions on the floor allowing the trim to overlap the mat. Using the holes in the trim as a guide, mark out and drill the floor (fit plugs if required). Clean off the floor and fix the mats and edge trim in place using countersunk screws to suit the application.

As the perimeter trim is fitted ensure none of the wiring is trapped or crushed between the trim and the floor or the top and bottom sections (depending on trim type).

If there is a possibility that the wires may be caught or pulled, a strain relief clamp should be used where the wiring exits the perimeter trim. All wiring should be protected in suitable conduit. If possible, the wiring/conduit should not cross a floor area where it will be a tripping hazard. If it is not possible to avoid this, the wiring/conduit should be enclosed within our Protective Wire Guide 440F-T3230 (see Available Spares on page 37).

6.2 CONTROL UNIT INSTALLATION AND WIRING (also refer to section 4 fig. 7, section 5.3.7 and section 5.7)

The control unit should be installed as supplied. It must not be modified or subjected to any procedures or connections other than those described in this manual.

Prepare the control unit by carefully knocking out (440F-C4000P) or drill out (440F-C4000S, 440F-C28013) the cable entry positions to be used. The input power supply must be separately routed and enter the control unit via a separate entry to those used for the output wiring. Mount the control unit in its planned position. All wiring to the control unit terminals must use either wire type supplied or multistrand conduit cable/ switchgear cable/ equipment wire with 0.5 - 1.5mm² conductors. Cable entry into the control unit (440F-C4000P, 440F-C4000S & 440F-C28013) must be achieved using glands or adaptors which provide an ingress protection rating of IP65. Ensure that the glands or adaptors are of a suitable size and are fully tightened.

The insulated pin crimps supplied must be used. This wire and terminal combination avoids the possibility of shorts from loose strands or open circuits caused by overtightening or vibration.

Ensure that a suitable ratchet type crimp tool is used. Crimp onto both the conductor and the insulation. Do not connect more than one wire onto one crimp.

ENSURE THAT THE POWER SUPPLY REMAINS ISOLATED AND LOCKED OFF UNTIL SECTION 6.4.

The mains AC supply must be externally fused at the point of supply by a 500mA max. high rupture capacity (HRC) fuse. Unless the neutral side of the supply is referenced to earth, it must be fused to the same specification.

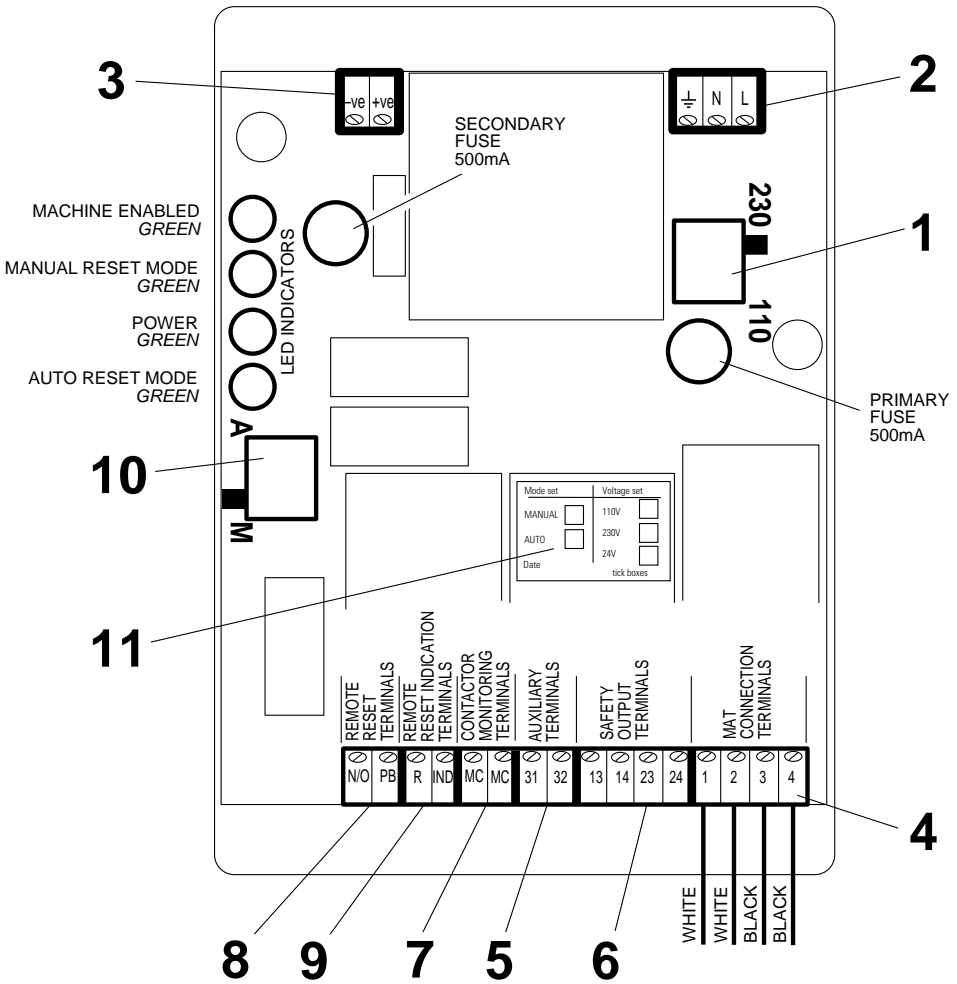

Fig. 26 440F-C4000P and 440F-C4000S (Follow steps 1-12 for correct installation - see following pages)

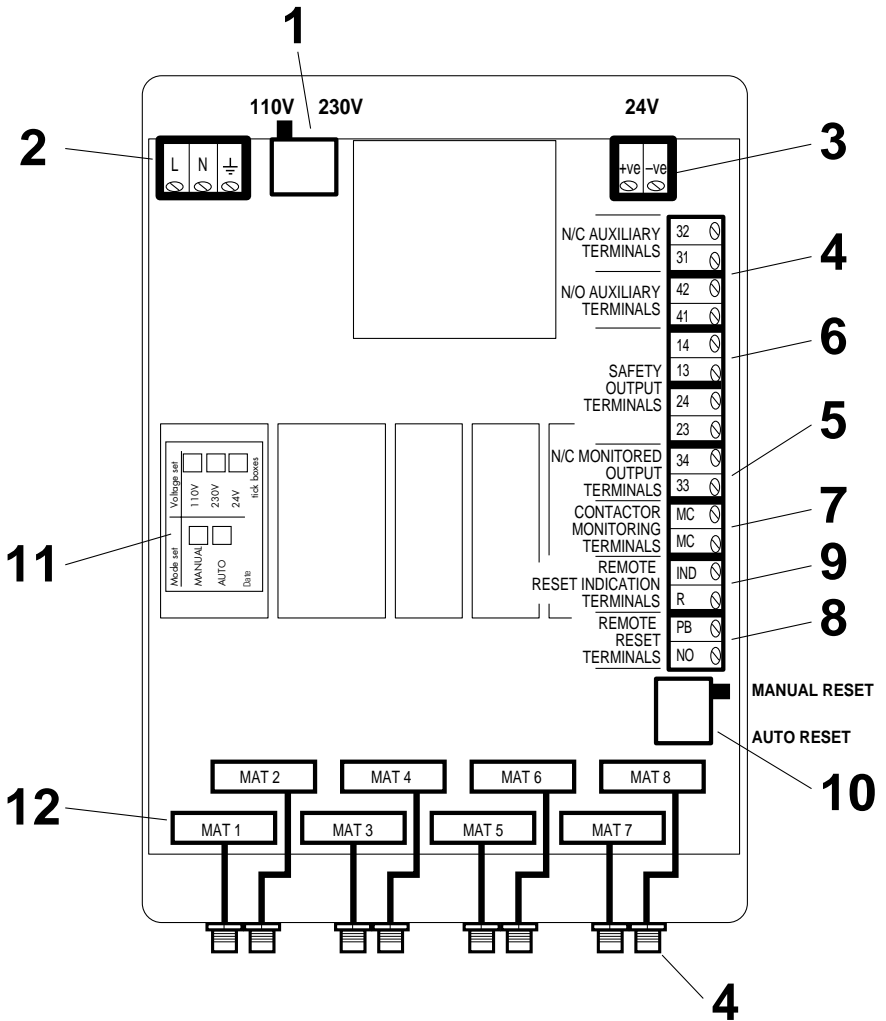

Fig. 26a 440F-C28013 (Follow steps 1-12 for correct installation - see following pages)

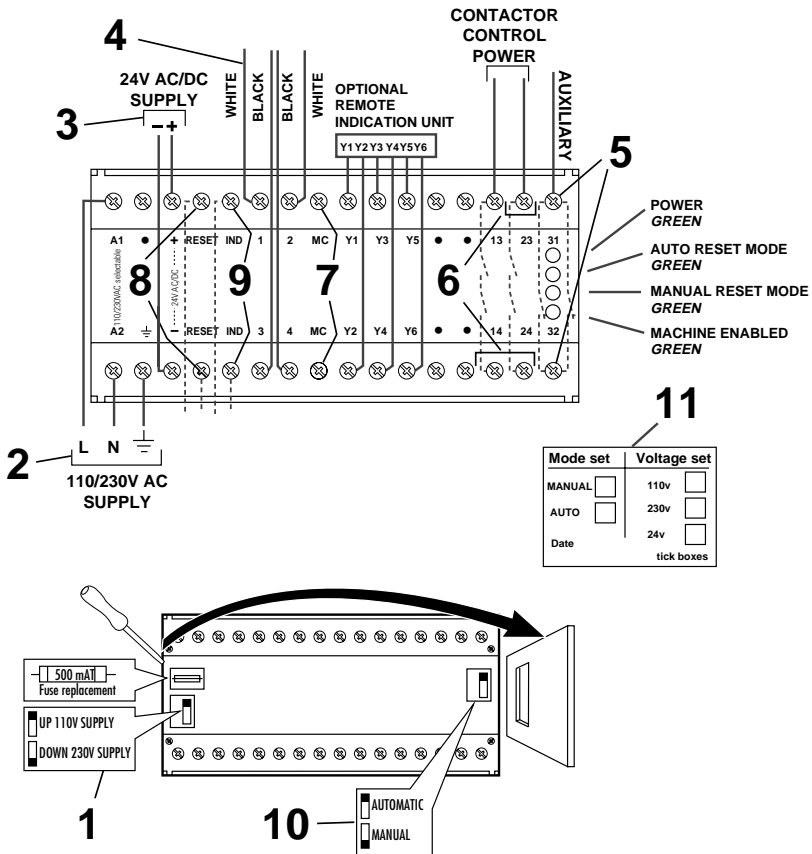

Fig. 27 440F-C4000D (Follow steps 1-12 for correct installation)

- When using a 110V or 230VAC supply switch the voltage selector switch to 110V or 230V as appropriate. NOTE: The system is despatched from the factory with the selector set at 230V AC.
- If a 110V or 230V AC supply is being used it should be wired, including a protective earth, to the terminals shown. Check setting on voltage selector switch, see step 1. Do not make any connections to the terminal shown at step 3. The size of the protective earth wire should be at least equal to that of the supply wire.
- If a 24VAC/DC supply is being used it should be connected to the terminals shown, ensuring correct polarity. Do not make any connections to the terminals shown at step 2. With 24VAC the earthed pole of the power supply should be connected to the -ve terminal.
- MAT CONNECTIONS:** Connect the leads from the mat to the terminals shown.
1=WHITE, 2=WHITE, 3=BLACK, 4=BLACK.
440F-C28013 - eight quick connect adaptors labelled 1 to 8 are located on the base of the unit and provide connection to the mats.

Connecting the mats to 440F-C28013 control unit

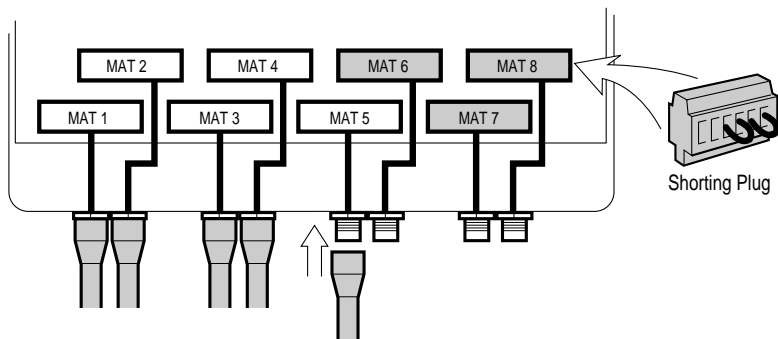

Fig. 27a Terminating unused mat connections and connecting mats

If less than 8 mats are to be connected to the control unit, the other connections must be terminated with the shorting plugs supplied. The required mats should be connected in sequence (1 to 8) to the quick connect adaptors located on the outside of the unit. Terminate unused connectors by un-plugging fitted connectors and replacing with shorting plugs as shown in Fig. 27a.

5. AUXILIARY OUTPUTS: This terminal provides auxiliary N/C contacts (i.e. Closed when the *MACHINE ENABLED* light is OFF) suitable for indication or alarm devices. **THEY MUST NOT BE CONNECTED TO THE SAFETY CIRCUIT.** NOTE: MGCSM1 and MGCSM4 offer N/C and N/O contacts.

6. SAFETY OUTPUTS: These are volt free terminals for connection to the machine safety circuit i.e.. They are connected in series with the machine contactor control circuit (max rating 250V 4A). They should be externally protected by a suitably rated fuse(s). For **ONE CONTACTOR** use terminals 13 & 24 with terminals 14 & 23 linked.

For **TWO CONTACTORS** with two independent control circuits (i.e. a dual channel system), use 13 & 14 for connection to one contactor control circuit and 23 & 24 to the other.

See figs. 14/15 and 16/17 in section 5 for examples of typical interfacing with the machine control circuit. NOTE: The safety outputs should be connected directly via hard wiring to the machine primary control elements (contactors). They must not be connected via any elements e.g. ordinary relays, PLCs, etc. not suitably specified for safety related functions.

7. CONTACTOR MONITORING: The control unit is provided with these terminals linked. When the link is removed they can be connected to positively guided N/C auxiliary contacts on the machine contactors to provide monitoring of the contactors in dual channel control systems. If one contactor fails to isolate the power at de-energisation of its control coil the mat control unit will not allow the other contactor to be energised until the fault has been rectified.

8. REMOTE RESET: N/O - These terminals are provided for the connection of a remote reset button. This **MUST** be a N/O momentary push button device positioned at a location which gives a full view of the detection zone.

440F-C4000P, 440F-C4000S, 440F-C28013 only. If there is not also a full view of the hazard zone from the control unit, disconnect the wires from the reset switch on the control unit lid at the terminal block to disable the reset function at the control unit.

9. REMOTE RESET INDICATION: If this is used in conjunction with an illuminated push button remote reset switch, it will show when the mat system needs to be reset. These terminals are for connection to the bulb (28V).

10. MANUAL RESET / AUTO RESET: M/A SWITCH. Set the M/A switch to the required setting.
M = MANUAL RESET MODE
A = AUTO RESET MODE.

11. Mark and sign the label according to the Voltage and Mode settings established.

12. Eight six-way connectors labeled 1 to 8. These are the mat connections into the control unit and are connected to the external quick connect plugs on the outside of the unit.

13. Re-check the wiring connections including connections or modifications made to the machine control system wiring. Replace lid. Secure lid on relevant units.

DISCONNECT THE MACHINE PRIME MOVER FROM THE FINAL CONTACTOR(S), SO THAT NO MACHINE MOVEMENT CAN TAKE PLACE.

6.3 CHECKING THE MECHANICAL INSTALLATION

1. Check that sensor mats, perimeter trim and uniting trims are undamaged and correctly positioned and secured. Check that the designed safety distance has been achieved.
2. Check that access to the hazard zone is not possible other than via the mat and that any fixed guards etc. are positioned according to the design and are secure.
3. Check that the presence of a person between the hazard zone and mat system is prevented.
4. Check that the environmental conditions present or foreseeable correspond to those considered during the design stage.
5. Check that the installation is free of hazards not foreseen at the design stage.
6. Check that any warning notices are in place.
7. Check that any other protective measures required have been installed.

6.4 CHECKING THE ELECTRICAL FUNCTIONS

1. Ensure the mat is clear of persons and equipment. Temporarily disconnect any automatic reset function provided by the machine control system. Reinststate the machine power supply but ensure that the machine prime mover is still disconnected from the machine final contactor(s).

A. MANUAL MODE ONLY *(not relevant when using 440F-C28013 control unit)*

2. Check on the Control unit that:
 - the green LED - *POWER* is illuminated
 - the green LED - *MANUAL RESET* is illuminated
 - the reset lamp in the reset button is illuminated
 - the green LED - *MACHINE ENABLED* is off.
3. Press and release the reset button
 - check the *MACHINE ENABLED* LED comes on and the reset lamp goes off
 - stand on the mat and check the *MACHINE ENABLED* LED goes off.
4. Step off the mat, check the *MACHINE ENABLED* LED remains off and the reset button is illuminated.
 - Press and release the reset button, check the *MACHINE ENABLED* LED comes on and the reset button goes off.
5. Repeat the above tests to check the remote reset button(s) and lamp(s) if fitted.

6. Repeat the above to check the correct operation of any status monitoring connected to the mat system.

B. AUTO RESET MODE ONLY (not relevant when using 440F-C28013 control unit)

2. Check on the Control unit that:
 - the green LED - *POWER* is illuminated
 - the green LED - *MACHINE ENABLED* is on.
3. Stand on the mat and check the *MACHINE ENABLED* LED goes off.
4. Step off the mat, check that the *MACHINE ENABLED* LED goes on.
5. Repeat the above to check the correct operation of any status monitoring connected to the mat system.

440F-C28013 CONTROL UNIT FUNCTIONS

Auto reset mode only

1. Check on the control unit that:
 - The green LED - *POWER* is illuminated
 - The green LED - *MACHINE ENABLED* is illuminated
 - The CHANNEL FAULT LED's 1 to 8 are illuminated green matching the number of mats installed.
2. Stand on mat number 1 and check the *MACHINE ENABLED* LED goes off and the CHANNEL FAULT LED changes to RED.
3. Step off the mat and check that the control system returns to the same state as item 1 above.
4. Repeat process for each mat connected to the control unit checking the corresponding CHANNEL FAULT LED changes to RED.

Manual reset mode only

1. Check on the control unit that:
 - The green LED - *POWER* is illuminated
 - The green LED - *MACHINE ENABLED* is illuminated
 - The CHANNEL FAULT LED's 1 to 8 are illuminated green matching the number of mats installed.
2. Stand on mat number 1 and check the *MACHINE ENABLED* LED goes off and the CHANNEL FAULT LED changes to RED.
3. Step off the mat, manually reset the system by operating the RESET BUTTON and then check that the control system returns to the same state as item 1 above.
4. Repeat process for each mat connected to the control unit checking the corresponding CHANNEL FAULT LED changes to RED.

Note that CHANNEL FAULT STATUS LED's indicate individual mat operation or fault.

Control unit - Mode of operation (440F-C28013)

Auto reset

On power up:

Power, auto reset and machine enabled LED's illuminate.

When mat operated:

Machine enabled LED goes out

Stand off mat:

Machine enabled LED illuminates

Manual reset

On power up:

Power, manual reset and machine enabled LED's illuminate.

Press reset button:

Machine enabled LED illuminates

When mat operated:

Machine enabled LED goes out

Stand off mat:

Machine enabled LED still out

Press reset button:

Machine enabled LED illuminates

Under fault condition

Machine enabled light goes out and will not allow reset until fault is rectified. In the fault condition if there is a mat fault, one or more of the MAT STATUS LED's will be illuminated. Under open circuit or short circuit the LED(s) will illuminate RED. If there is a fault condition and none of the MAT STATUS LED's are illuminated then it is a control unit fault.

6.5 CHECKING THE SAFETY FUNCTIONS

6.5.1 SINGLE CHANNEL SYSTEMS (see figs. 15 and 17 section 5)

Simulate normal operation. Actuate the mat by standing on it and check that the main contactor drops out immediately. Check that any other safety related stop functions e.g. brake, clutch contactors are operating as intended.

6.5.2 DUAL CHANNEL SYSTEMS (see fig. 16 and 18 section 5)

1. Simulate normal operation. Actuate the mat by standing on it and check both final contactors drop out immediately. Check that any other safety related stop functions e.g. brake/clutch contactors are operating as intended.

2. Isolate the power source and then install a temporary fault by short circuiting terminals 13 and 14 at terminal block 6 (figs. 26 or 27).

3. Reinstall the power source and actuate the sensor mat and check that one of the final contactors drops out immediately and any other stop functions associated with that channel operate as intended.

4. CHECK CONTROL UNIT WILL NOT RESET

5. Isolate the power source and remove the temporary fault. Reinstall the power source and check mat system operates normally. Taking the same electrical safety precautions, repeat the test with a temporary short circuit across terminals 23 and 24 at terminal block 6 (figs. 26 or 27).

6. AGAIN CHECK CONTROL UNIT WILL NOT RESET

7. Remove the temporary fault, check mat system operates correctly.

6.5.3 ALL SYSTEM TYPES

1. Carry out any other tests required to confirm that the safety related control system meets the requirements of its Category according to EN 954-1 and works as intended.
2. Check any other safety functions associated with the machine circuits which have been affected by the installation of the mat system. There should be an existing procedure for these tests.
3. **ISOLATE THE MACHINE POWER SUPPLY AT SOURCE.**
4. Reconnect any automatic reset function provided by the machine control system.
5. Reconnect the machine prime mover to the final contactors.
6. Secure all covers and doors.

6.6 FUNCTIONAL CHECKOUT

Reinstate the machine electrical supply.

Check:-

1. Machine operation cannot commence until the mat control unit has been reset. Perform the walking test described in section 8.2.
2. Check that actuation of the mat stops hazardous movement.
3. Check that stepping off the mat does not start machine operation but does enable restart.
4. Check that when approaching the machine at walking pace, hazardous movement stops before the hazard zone can be reached. In critical applications, stop-time tests should be carried out
5. If any type of muting system is installed, check that the mat system is muted only during non-hazardous parts of the operating cycle and that any mute indicators operate correctly.
6. Test the machine's Emergency stop function.

Section 7 - USE

Prior to putting the machine into its normal service, ensure that operators and supervisors are aware of the nature and purpose of the mat system and that they understand the functions of the controls and indicators.

Ensure that the technical specifications together with inspection, test and servicing instructions are available to the appropriate personnel and that a system for recording inspections is in place.

ENSURE THAT PERSONNEL UNDERSTAND THAT NO ADDITIONAL COVERINGS, BOARDS, PLATES OR PLANKS ARE TO BE ON THE SENSOR MAT DURING OPERATION OF THE MACHINE.

Section 8 - MAINTENANCE

This section should be read in full before any maintenance is attempted.

Attention is drawn to requirements for planned preventive maintenance.

During maintenance operations, disconnect the machine's prime mover before working on the mat system. Observe electrical safety precautions.

8.1 MAT CLEANING

The sensor mats should be regularly swept to clear them of deposits such as swarf and other materials. If it is necessary to wash or hose down the sensor mats to clean or remove grease etc it is permissible to use warm water and detergent. **DO NOT USE SOLVENTS.**

8.2 ROUTINE INSPECTION AND TEST - (Recommended Weekly)

Stop the machine. Clean the sensor mats and allow them to dry off. Inspect the top surface of the mat for damage. Minor nicks and abrasions of the vinyl cover are acceptable but any damage which exposes the metal plate must be dealt with immediately. Check that the perimeter trim and uniting trim are not cracked, broken or distorted and that the fixings are secure. Damaged parts must be replaced immediately.

Test the mat operation. Two persons are required, one to walk on the mat, the other to observe the control unit. On systems using manual reset mode the reset button must be continuously pressed and released. Check that the *MACHINE ENABLED* LED is ON prior to actuation of the mat and goes OFF as soon as the mat is stepped on. One person should walk over each section of the mat in turn and each joining section in turn (i.e. stand with both feet on the same uniting trim between two sections). The *MACHINE ENABLED* LED must remain OFF during the entire time. Step off the mat, operate the reset button. Check the *MACHINE ENABLED* LED is illuminated. Start the machine, step onto the mat and check that the machine stops immediately.

Check that all fixed guards and angle plates etc. are in place, undamaged and securely fixed.

IF THESE CHECKS REVEAL ANY PROBLEMS, DO NOT ALLOW USE OF THE MACHINE UNTIL THEY ARE RECTIFIED. RECORD THE INSPECTION AND TEST IN A WRITTEN LOG.

8.3 THOROUGH EXAMINATION AND TEST - (Recommended twice yearly or after damage)

Contact the supplier for information on an authorised testing service.

To be undertaken by a person competent in electrical and mechanical engineering.

- Carry out the test at 8.2 above.
- Isolate power source to the machine and mat system. Observe electrical safety precautions.
- Inspect the mat components thoroughly for mechanical damage.
- Disconnect the wires to the mat at terminals 1, 2, 3 and 4 at the control unit.
- Connect the two white wires to one test input of an ohmmeter and connect the two black wires to the other input. One person should walk over each section of the mat in turn and each joining section in turn (i.e. stand with both feet on the same uniting trim between two sections) until all areas of the sensor mat have been covered. The maximum resistance with presence on the mat should not exceed 100ohms.

IF THESE CHECKS REVEAL ANY PROBLEMS, DO NOT ALLOW USE OF THE MACHINE UNTIL THEY ARE RECTIFIED.

Check that the stopping performance of the machine has not deteriorated from that used in the original safety distance calculations (see section 5).

Record the inspection and test in a written log.

8.4 DISMANTLING AND DISPOSAL

Dismantling the mat system is the reverse of the installation procedure and no extra hazards are presented.

ENSURE THAT THE MACHINE AND MAT SYSTEM POWER IS ISOLATED AND LOCKED OFF AT SOURCE BEFORE STARTING WORK.

If the system is to be reconfigured or relocated, observe the handling precautions given in section 1.

The mat system does not contain any hazardous materials which require special precautions for disposal.

8.5 FAULT FINDING

Disconnect prime mover prior to working on mat control system with power applied.

Observe electrical safety precautions.

8.5.1 Symptom – *With no presence on the mat and after the correct reset procedure has been followed, the machine cannot be started.*

1. If the *MACHINE ENABLED* LED on the mat control unit is **ON** there is a probable fault on the machine or its control system external to mat system. Check the external fuses in the control unit safety output wiring and replace if necessary. **ENSURE THAT THE CORRECT VALUE OF FUSE IS USED (2A max).** Record the replacement in the inspection log. If either fuse blows immediately or requires early replacement there is a probable fault in the machine control circuit between the safety output of the mat control unit and the machine's final control element(s) (contactors).
2. If the *MACHINE ENABLED* LED on the mat control unit is **OFF**, take the following actions:
Check that the the *POWER* LED is illuminated.
If it is not, check the power supply to the mat control unit.
Check that the power supply is connected to the appropriate terminals.
Check the primary and secondary fuses in the control unit and replace if necessary. **ENSURE THAT THE CORRECT VALUE OF FUSE IS USED (500mA anti-surge)** for both primary and secondary fuses. Record the replacement in the inspection log. If either fuse blows immediately or requires early replacement please contact the supplier.
3. If the the *MACHINE ENABLED* LED on the mat control unit is **OFF** and the *POWER* LED is **ON**.
On dual channel systems with contactor monitoring, if the external safety output fuses have not blown, it is still probable that there is a fault external to the control unit. A single fault in either wiring channel will cause the mat control unit to lock off the safety outputs until the fault is rectified and the control unit is reset. Check that all connecting wiring in the system is configured correctly and has not been damaged and that both contactors are functioning correctly.
Rectify any faults and if in manual reset mode press and release the control unit reset button.
4. If the problem is not resolved please contact the supplier.

8.5.2 Symptom – *Machine does not stop or can be started with presence on the mat.*
DO NOT ALLOW USE OF THE MACHINE

1. With presence on the mat, is the *MACHINE ENABLED* LED illuminated on the mat control unit ?

2. If the *MACHINE ENABLED* LED is not illuminated there is a probable fault on the machine or its control system external to the mat system.– **DO NOT ALLOW USE OF THE MACHINE UNTIL THE FAULT HAS BEEN RECTIFIED AND TESTED.**

3. If the *MACHINE ENABLED* LED is illuminated.– **DO NOT ALLOW USE OF THE MACHINE AND CONTACT THE SUPPLIER IMMEDIATELY.**

8.5.3 Symptom – *Machine stops unexpectedly with no presence on the sensor mat but can be restarted after stepping on and off the mat (and resetting when in manual reset mode).*

1. Check that all indicator lights are operating correctly. If they are, the problem is likely to be caused by a dip in supply power of a certain value and duration. This can cause one of the internal relays in the control unit to drop out, thus simulating a fault condition. This is a very unlikely occurrence and no remedial action is required. In the unusual event of the problem persisting, measures may be required to ensure a smoother power supply to the mat system.

8.6 REPAIR

Prior to working on the mat system or machine control system, isolate power source to the machine and mat system. Observe electrical safety precautions.

User repairs are limited to replacement by new mat system parts. In the event of problems, the units should be returned to the supplier.

Any repairs to the connecting wires should be made using the recommended butt splice connectors.

TAMPERING WITH COMPONENT PARTS WILL INVALIDATE WARRANTY.

WARRANTY INVALID IF QUALITY SEAL IS BROKEN ON DIN RAIL CONTROL UNIT.

AVAILABLE SPARES

<i>Mat Size</i>		<i>Safety Mat</i>	<i>Standard Perimeter Trim Kit</i>
millimetres	Inches	Catalog No.	Catalogue No.
500 x 500	19.7 x 19.7	440F-M1010BYNN	440F-T1010
500 x 600	19.7 x 23.6	440F-M1012BYNN	440F-T1012
500 x 900	19.7 x 35.4	440F-M1018BYNN	440F-T1018
500 x 1000	19.7 x 39.4	440F-M1020BYNN	440F-T1020
500 x 1200	19.7 x 47.2	440F-M1024BYNN	440F-T1024
500 x 1500	19.7 x 59.1	440F-M1030BYNN	440F-T1030
600 x 600	23.6 x 23.6	440F-M1212BYNN	440F-T1212
600 x 750	23.6 x 29.5	440F-M1215BYNN	440F-T1215
600 x 900	23.6 x 35.4	440F-M1218BYNN	440F-T1218
600 x 1000	23.6 x 39.4	440F-M1220BYNN	440F-T1220
600 x 1200	23.6 x 47.2	440F-M1224BYNN	440F-T1224
600 x 1500	23.6 x 59.1	440F-M1230BYNN	440F-T1230
750 x 500	29.5 x 19.7	440F-M1510BYNN	440F-T1510
750 x 750	29.5 x 29.5	440F-M1515BYNN	440F-T1515
750 x 1500	29.5 x 59.1	440F-M1530BYNN	440F-T1530
800 x 600	31.5 x 23.6	440F-M1612BYNN	440F-T1612
800 x 750	31.5 x 29.5	440F-M1615BYNN	440F-T1615
800 x 900	31.5 x 35.4	440F-M1618BYNN	440F-T1618
800 x 1000	31.5 x 39.4	440F-M1620BYNN	440F-T1620
800 x 1200	31.5 x 47.2	440F-M1624BYNN	440F-T1624
800 x 1500	31.5 x 59.1	440F-M1630BYNN	440F-T1630
900 x 900	35.4 x 35.4	440F-M1818BYNN	440F-T1818
900 x 1000	35.4 x 39.4	440F-M1820BYNN	440F-T1820
900 x 1200	35.4 x 47.2	440F-M1824BYNN	440F-T1824
900 x 1500	35.4 x 59.1	440F-M1830BYNN	440F-T1830
1000 x 750	39.4 x 29.5	440F-M2015BYNN	440F-T2015
1000 x 1000	39.4 x 39.4	440F-M2020BYNN	440F-T2020
1000 x 1200	39.4 x 47.2	440F-M2024BYNN	440F-T2024
1000 x 1250	39.4 x 49.2	440F-M2025BYNN	440F-T2025
1000 x 1500	39.4 x 59.1	440F-M2030BYNN	440F-T2030

	<i>length</i>	<i>Catalog No.</i>
Standard Perimeter Trim	2M	440F-T3210
Standard Perimeter Trim	3M	440F-T3310
Standard Perimeter Trim	5M	440F-T3510
External Corner Standard Perimeter Trim	-	440F-T3012
Internal Corner Standard Perimeter Trim	-	440F-T3013
Perimeter Trim with Cable Channel	2M	440F-T3211
Perimeter Trim with Cable Channel	4M	440F-T3411
External Corner Perimeter Trim with Cable Channel	-	440F-T3014
Internal Corner Perimeter Trim with Cable Channel	-	440F-T3015
Active Uniting Trim	-	440F-T3020
Vinyl Wire Guide	-	440F-T3230
Mat Controllers	-	440F-C4000P
	-	440F-C4000S
	-	440F-C4000D
	-	440F-C28013
Fuse, 500 mA	-	440R-A31562
Shorting Plug	-	440F-A28639

For special sized sensor mats, refer to the model no. printed on the label.

After replacing any parts the inspection and test shown at 8.2 must be carried out with special attention given to those parts replaced.

WARNING

After maintenance or repair operations it is important that all edging trims, fastenings and cable protection are correctly refitted. Failure to do this or the use of non approved parts or modifications may result in the mat system failing to achieve its specified performance.

8.7 SERVICE

For service and assistance please contact the supplier.



Allen-Bradley

Guardmaster®

Drawing No: 28563/2
Change No: 26190