

CompactLogix 5370 L1 Controllers

Catalog Numbers 1769-L16ER-BB1B, 1769-L18ER-BB1B, 1769-L18ERM-BB1B



Important User Information

Read this document and the documents listed in the additional resources section about installation, configuration, and operation of this equipment before you install, configure, operate, or maintain this product. Users are required to familiarize themselves with installation and wiring instructions in addition to requirements of all applicable codes, laws, and standards.

Activities including installation, adjustments, putting into service, use, assembly, disassembly, and maintenance are required to be carried out by suitably trained personnel in accordance with applicable code of practice.

If this equipment is used in a manner not specified by the manufacturer, the protection provided by the equipment may be impaired.

In no event will Rockwell Automation, Inc. be responsible or liable for indirect or consequential damages resulting from the use or application of this equipment.

The examples and diagrams in this manual are included solely for illustrative purposes. Because of the many variables and requirements associated with any particular installation, Rockwell Automation, Inc. cannot assume responsibility or liability for actual use based on the examples and diagrams.

No patent liability is assumed by Rockwell Automation, Inc. with respect to use of information, circuits, equipment, or software described in this manual.

Reproduction of the contents of this manual, in whole or in part, without written permission of Rockwell Automation, Inc., is prohibited.

Throughout this manual, when necessary, we use notes to make you aware of safety considerations.



WARNING: Identifies information about practices or circumstances that can cause an explosion in a hazardous environment, which may lead to personal injury or death, property damage, or economic loss.



ATTENTION: Identifies information about practices or circumstances that can lead to personal injury or death, property damage, or economic loss. Attentions help you identify a hazard, avoid a hazard, and recognize the consequence.

IMPORTANT

Identifies information that is critical for successful application and understanding of the product.

Labels may also be on or inside the equipment to provide specific precautions.



SHOCK HAZARD: Labels may be on or inside the equipment, for example, a drive or motor, to alert people that dangerous voltage may be present.



BURN HAZARD: Labels may be on or inside the equipment, for example, a drive or motor, to alert people that surfaces may reach dangerous temperatures.

ARC FLASH HAZARD: Labels may be on or inside the equipment, for example, a motor control center, to alert people to potential Arc Flash. Arc Flash will cause severe injury or death. Wear proper Personal Protective Equipment (PPE). Follow ALL Regulatory requirements for safe work practices and for Personal Protective Equipment (PPE).

Follow the path that matches your hardware and network configuration.

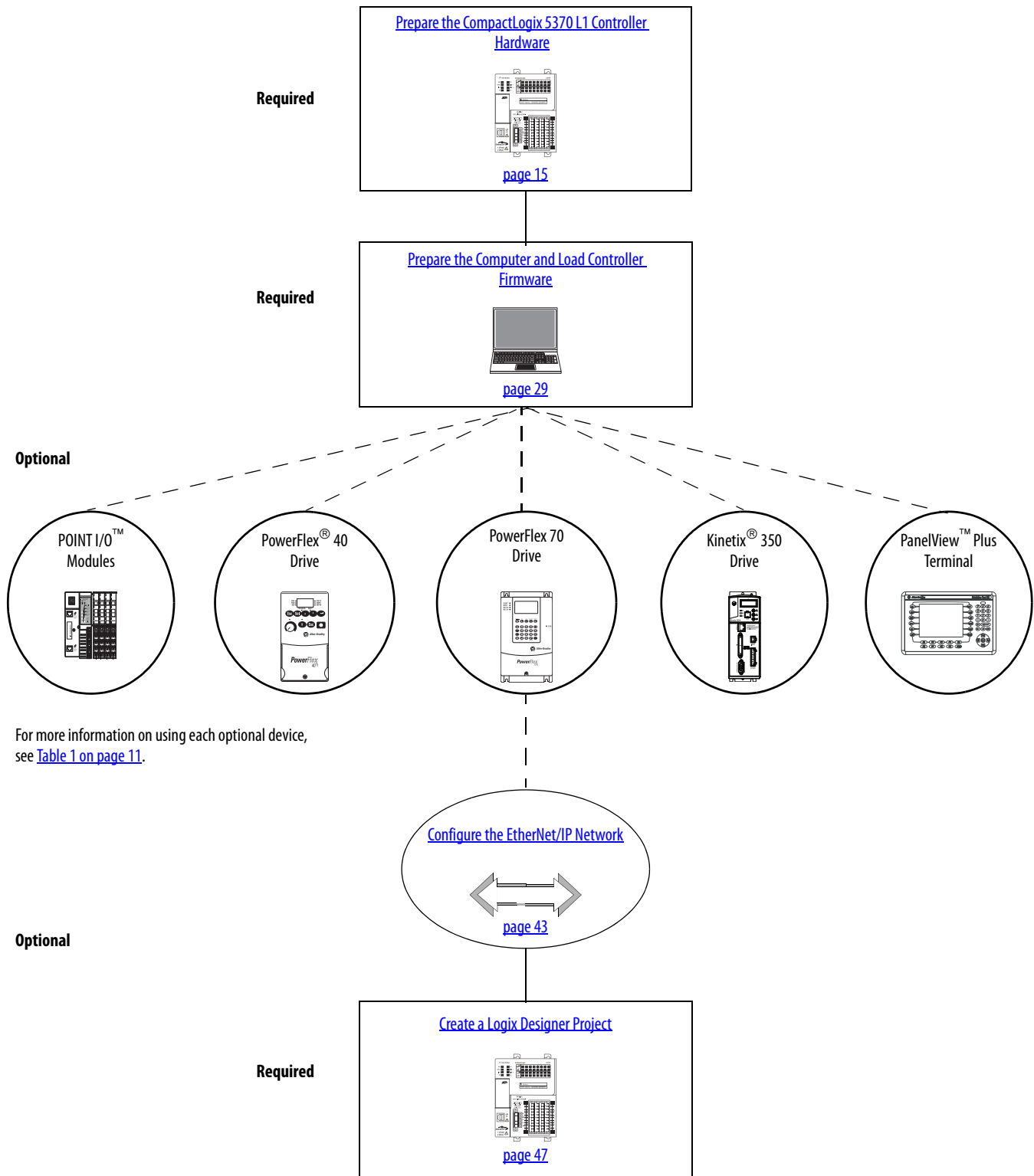

How Hardware Is Connected

This quick start, in use with the additional quick starts listed in [Table 1 on page 11](#), describes a CompactLogix™ 5370 L1 control system as shown in [Figure 1](#).

Figure 1 - CompactLogix 5370 L1 Controller in a Star Network Topology

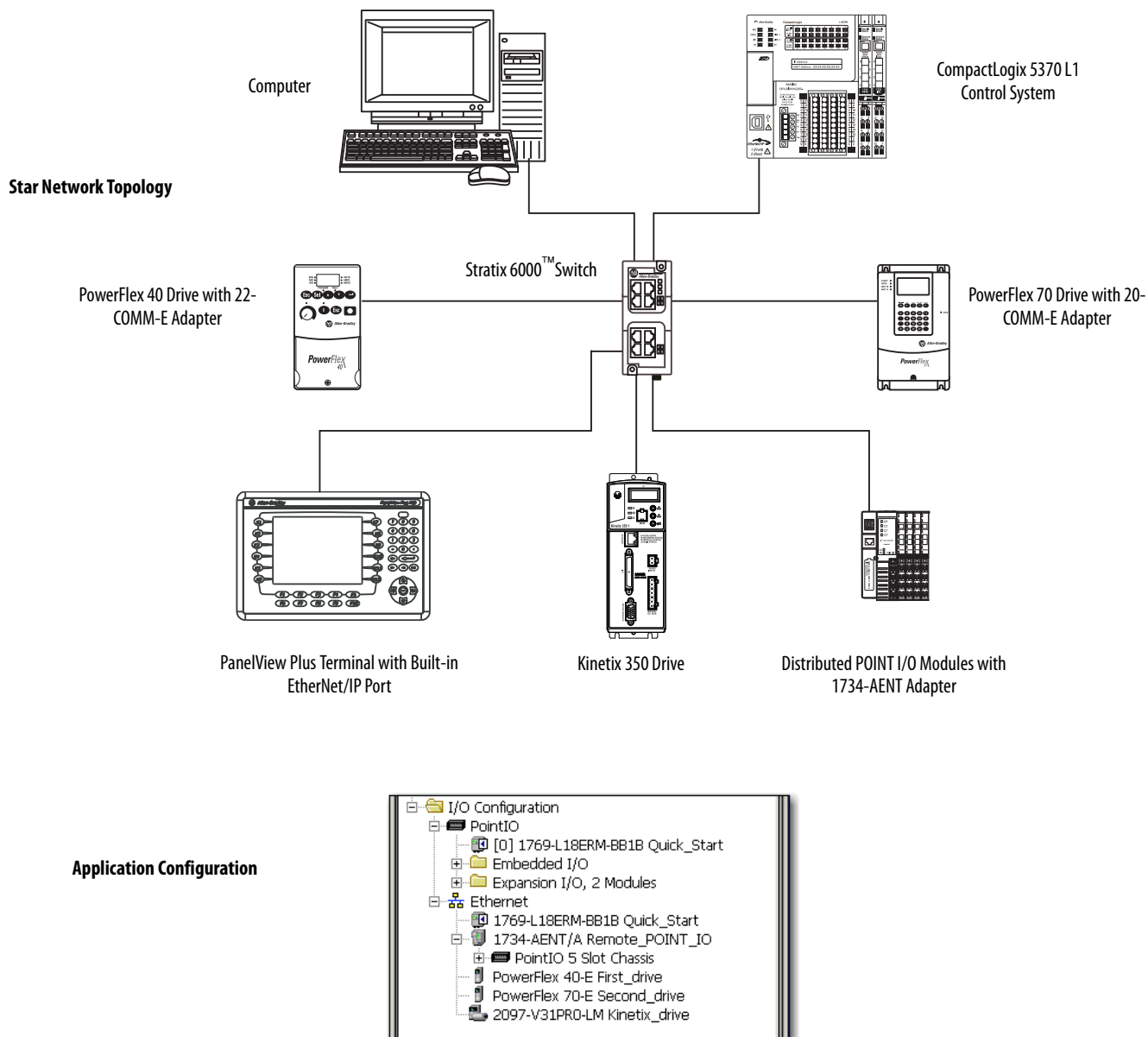

Sample Panel Layout

The sample panel layout shows the orientation of an example CompactLogix 5370 L1 control system using an EtherNet/IP network.

IMPORTANT The following graphic is an example panel layout. The layout of CompactLogix 5370 L1 control systems varies by application.

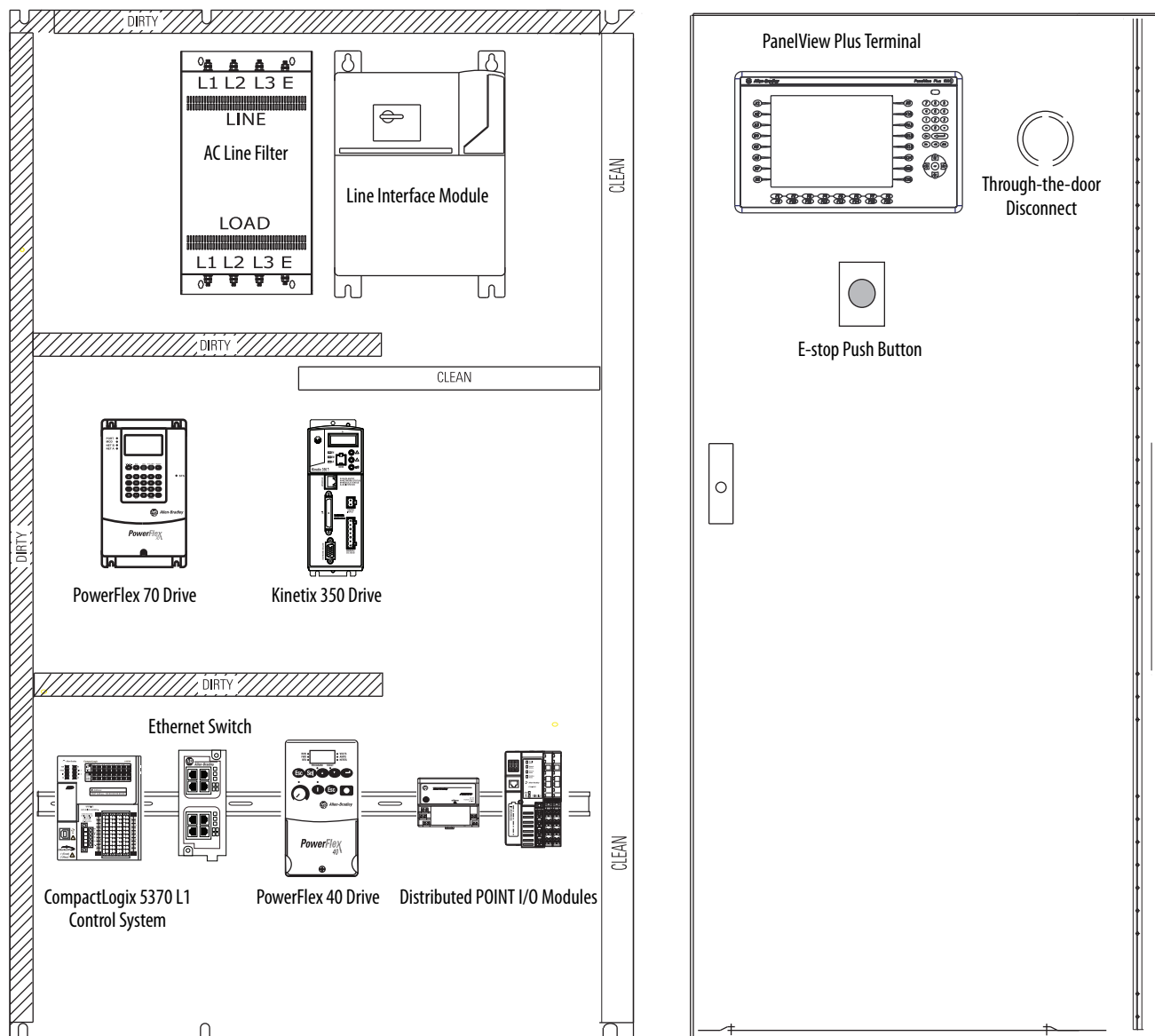

Notes:

	Preface	
	About the CompactLogix 5370 L1 Controllers	10
	Choose to Integrate Optional Devices	11
	Studio 5000 Environment	12
	Required Software	12
	Parts List	13
	Additional Resources.....	13
	Chapter 1	
Prepare the CompactLogix 5370 L1 Controller Hardware	What You Need	15
	Follow These Steps.....	16
	Install the EtherNet/IP Network.....	17
	Install the Secure Digital Card	18
	Mount the Controller	20
	Install the Local Expansion Module.....	21
	Wire Power to the Controller	23
	Make Network Connections	26
	Make a USB Connection	26
	Make EtherNet/IP Network Connections.....	27
	Chapter 2	
Prepare the Computer and Load Controller Firmware	Before You Begin	29
	What You Need	29
	Follow These Steps.....	30
	Install the Studio 5000 Environment	31
	Automatic Installation of ControlFLASH Software.....	33
	Configure an EtherNet/IP Driver in RSLinx Classic Software	33
	Set the IP Address for the Computer.....	35
	Load the Controller Firmware	38
	Install Additional Software - Optional	41
	Chapter 3	
Configure the EtherNet/IP Network	Before You Begin	44
	What You Need	44
	Assign an IP Address to the Controller over a USB Connection.....	45
	Chapter 4	
Create a Logix Designer Project	Before You Begin	48
	What You Need	48
	Follow These Steps.....	49
	Create a Project.....	50
	Configure the Controller	51
	Add a Local Expansion Module	54
	Add Ladder Logic to Test the Local Expansion Module	56

	Download to the Controller.....	59
	Appendix A	
Understanding Other Application Options	DLR Network Topology.....	62
	Follow These Steps	63
	Integrated Motion on the EtherNet/IP Network.....	64
	Follow These Steps	64

This quick start describes how to use CompactLogix 5370 L1 controllers to install a simple CompactLogix 5370 L1 control system and execute a task with a local 1734 POINT I/O output module. The programming examples that are included are not complex, and offer solutions to verify that devices are functioning and communicating properly.

IMPORTANT Consider the following points:

- A typical CompactLogix 5370 L1 control system includes more components than listed in this quick start. For example, you can use 1734 POINT I/O modules over an EtherNet/IP network in a CompactLogix 5370 L1 control system. Other quick starts describe how to use additional components with your control system.

For a list of quick starts describing how to use other components in Logix5000™ control systems, see [Choose to Integrate Optional Devices on page 11](#).

- Not all tasks that are described in this quick start are required to complete the final task, that is, use ladder logic to test a 1769-OB16 output module as described beginning on [page 47](#). For example, you do not need a DeviceNet configuration file to test the module.

We expect that you can attempt to complete additional tasks with your control system by using the publications that are listed on [page 11](#). When you use those publications, some assumptions are made. For example, if you use a PanelView Plus terminal over an EtherNet/IP network in a CompactLogix 5370 L3 control system, you must have created a project and assigned an IP address to the controller.

If you complete all tasks that are described in this quick start, you can easily complete the tasks that are described in the publications that are listed on [page 11](#).

The following topics are described in this quick start:

- Installing hardware for a basic CompactLogix 5370 L1 control system
- Installing software that is required for the basic CompactLogix 5370 L1 control system
- Configuring an EtherNet/IP network

IMPORTANT You are not required to install nor configure an EtherNet/IP network to complete the tasks that are described in this quick start. However, before you can complete the tasks that are described in some of the publications that are listed on [page 11](#), you must first install an EtherNet/IP network.

For example, Chapter 4, on [Create a Logix Designer Project on page 47](#) describes how to use ladder logic to test a 1734-OB4E output module. The test is completed by using the output module in a local expansion slot in the CompactLogix 5370 L1 control system and does not require use of a 1783-EMS08T Stratix 6000 managed switch because it can be done via a USB connection to the controller.

If you use 1734 POINT I/O modules over an EtherNet/IP network in your CompactLogix 5370 L1 control system, as described in the Logix5000 Control Systems: POINT I/O over an EtherNet/IP Network Quick Start, publication [IASIMP-QS027](#), you must install and configure an EtherNet/IP network.

Completing all tasks that are described in this quick start can assist you when attempting to complete the tasks in some other quick starts, such as publication [IASIMP-QS027](#).

- Creating a Studio 5000 Logix Designer™ project

About the CompactLogix 5370 L1 Controllers

These CompactLogix 5370 L1 controllers are available:

- 1769-L16ER-BB1B
- 1769-L18ER-BB1B
- 1769-L18ERM-BB1B

IMPORTANT The tasks that are described in this publication use a 1769-L18ERM-BB1B controller.

These features are available on CompactLogix 5370 L1 controllers:

- Embedded 24V DC input nonisolated power supply
- Secure Digital (SD) card for nonvolatile memory storage
- Network connections:
 - USB (single port)
 - Support for EtherNet/IP network- Option to use the controller in device-level ring (DLR), linear, and star topologies on EtherNet/IP networks
- I/O module options:
 - 16 embedded 24V DC digital input points
 - 16 embedded 24V DC digital output points
 - 1734 POINT I/O modules as local expansion module
 - Control of distributed I/O modules over an EtherNet/IP network
- Support for Integrated Motion on the EtherNet/IP network only with the 1769-L18ERM-BB1B controller.
- For more information on using the 1769-L18ERM-BB1B controller in an application that includes Integrated Motion on the EtherNet/IP network, see Appendix A, [Understanding Other Application Options on page 61](#).

This graphic shows an example CompactLogix 5370 L1 control system.

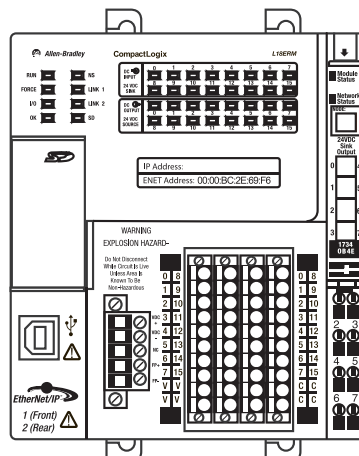





Choose to Integrate Optional Devices

This table describes additional optional devices and their related documentation that you can use in a CompactLogix 5370 L1 control system on an EtherNet/IP network.

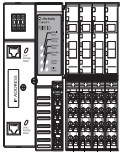
You can view or download publications at <http://www.rockwellautomation.com/literature/>.

Table 1 - Devices in Logix5000 Control System

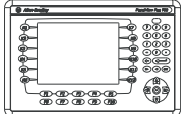
Device Type	Product Line ⁽¹⁾	Additional Resource with More Information
Distributed I/O	POINT I/O 	Logix5000 Control Systems: Connect POINT I/O Modules over an EtherNet/IP Network Quick Start, publication IASIMP-QS027
Drives	PowerFlex40 	Logix5000 Control Systems: Connect PowerFlex 40 Drives over an EtherNet/IP Network Quick Start, publication IASIMP-QS029
	PowerFlex 70 	Logix5000 Control Systems: Connect PowerFlex 70 Drives over an EtherNet/IP Network Quick Start, publication IASIMP-QS031
	Kinetix 350 	Logix5000 Control Systems: Connect Kinetix 350 Drives over an EtherNet/IP Network Quick Start, publication IASIMP-QS032
HMI terminals	PanelView Plus 	Logix5000 Control Systems: Connect PanelView Plus Terminals over an EtherNet/IP Network Quick Start, publication IASIMP-QS033

(1) You can use other I/O modules, drives, and HMI terminals in Logix5000 control systems. These product lines are used for example purposes.

Studio 5000 Environment

The Studio 5000 Automation Engineering & Design Environment™ combines engineering and design elements into a common environment. The first element in the Studio 5000® environment is the Studio 5000 Logix Designer™ application. The Logix Designer application is the rebranding of RSLogix™ 5000 software and continues to be the product to program Logix5000™ controllers for discrete, process, batch, motion, safety, and drive-based solutions.



The Studio 5000 environment is the foundation for the future of Rockwell Automation engineering design tools and capabilities. The environment is the one place for design engineers to develop all elements of their control system.

Required Software

[Table 2](#) lists the software that is used in this quick start. Software requirements are listed at the beginning of each chapter.

Table 2 - Software Used in This Quick Start

Software	Minimum Version	Required
Studio 5000 environment	21.00.00	Yes
Studio 5000 Logix Designer application	21.00.00	Yes
RSLink® Classic	3.51.00 or later	Yes
ControlFLASH™	Automatically installed with the Studio 5000 environment	Yes

Parts List

[Table 3](#) lists the hardware that is used in this quick start. Hardware requirements are listed at the beginning of each chapter.

Table 3 - Parts Used with This Quick Start

Quantity	Cat. No.	Description
1 or more	N/A	DIN rail (steel, not aluminum)
1	One of the following: • 1769-L16ER-BB1B • 1769-L18ER-BB1B • 1769-L18ERM-BB1B	CompactLogix 5370 L1 controller The tasks that are described in this publication use a 1769-L18ERM-BB1B controller.
1	User Selected, for example 1606-XLE120E	Switched-mode power supply
1	1734-0B4E	POINT I/O 8-point 24V DC electronically fused output module
1	1783-EMS08T	Stratix 6000 Ethernet managed switch
2 ⁽¹⁾	1585J-M8PBJM-2	RJ45-to-RJ45 patchcord Ethernet cables

(1) One Ethernet cable is required to connect the controller to the Ethernet switch and a second Ethernet cable is required to connect the Ethernet switch to the computer.

Additional Resources

These documents contain additional information concerning related products from Rockwell Automation.

Table 4 - Additional Resources

Resource	Description
CompactLogix 5370 Controllers User Manual, publication 1769-UM021	Describes how to design, install, operate, and troubleshoot a CompactLogix 5370 control system.
ControlFLASH Firmware Upgrade Software User Manual, publication 1756-UM105	Provides details regarding the installation of ControlFLASH software and execution of firmware upgrades.
Ethernet Design Considerations Reference Manual, publication ENET-RM002	Describes installing an EtherNet/IP network.
EtherNet/IP Embedded Switch Technology Application Guide, publication ENET-AP005	Describes using the controller in a DLR network topology.
EtherNet/IP Network Configuration User Manual, publication ENET-UM001	Describes how to install, configure, and operate EtherNet/IP modules.
Integrated Architecture and CIP Syne Configuration Application Technique, publication IA-AT003	Describes using the controller in an application that includes Integrated Motion on the EtherNet/IP network.
Integrated Motion on the EtherNet/IP Network Configuration and Startup User Manual, publication MOTION-UM003	Describes using the controller in an application that includes Integrated Motion on the EtherNet/IP network.
Logix5000 Control Systems: Connect POINT I/O Modules over an EtherNet/IP Network Quick Start, publication IASIMP-QS027	Describes basic steps that are required to include distributed POINT I/O modules over an EtherNet/IP network in a Logix5000 control system, including hardware, firmware, and software considerations.
Logix5000 Control Systems: Connect PowerFlex 40 Drives over an EtherNet/IP Network Quick Start, publication IASIMP-QS029	Describes basic steps that are required to include PowerFlex 40 drives over an EtherNet/IP network in a Logix5000 control system, including hardware, firmware, and software considerations.
Logix5000 Control Systems: Connect PowerFlex 70 Drives over an EtherNet/IP Network Quick Start, publication IASIMP-QS031	Describes basic steps that are required to include PowerFlex 70 drives over an EtherNet/IP network in a Logix5000 control system, including hardware, firmware, and software considerations.
Logix5000 Control Systems: Connect Kinetix 350 Drives over an EtherNet/IP Network Quick Start, publication IASIMP-QS032	Describes basic steps that are required to include Kinetix 350 Multi-axis Servo drives over an EtherNet/IP network in a Logix5000 control system, including hardware, firmware, and software considerations.
Logix5000 Control Systems: Connect a PanelView Plus Terminal over an EtherNet/IP Network Quick Start, publication IASIMP-QS033	Describes basic steps that are required to include PanelView Plus terminals over an EtherNet/IP network in a Logix5000 control system, including hardware, firmware, and software considerations.

Table 4 - Additional Resources

Resource	Description
Stratix 6000 Ethernet Managed Switches Installation Instructions, publication 1783-IN004	Describes installing an EtherNet/IP network.
Stratix 6000 Ethernet Managed Switch User Manual, publication 1783-UM001	Describes installing an EtherNet/IP network
EtherNet/IP Media Planning and Installation Manual, ODVA publication Click here to access the publication	Describes how to design and install an EtherNet/IP network.
Industrial Automation Wiring and Grounding Guidelines, publication 1770-4.1	Provides general guidelines for installing a Rockwell Automation® industrial system.
Product Certifications website, http://www.ab.com	Provides declarations of conformity, certificates, and other certification details.

You can view or download publications at <http://www.rockwellautomation.com/literature/>. To order paper copies of technical documentation, contact your local Allen-Bradley distributor or Rockwell Automation sales representative.

Prepare the CompactLogix 5370 L1 Controller Hardware

This chapter describes how to install the hardware that is needed for your CompactLogix 5370 L1 control system.

What You Need

[Table 5](#) lists the hardware components that are used in this chapter.

Table 5 - Parts Used with This Quick Start

Quantity	Cat. No.	Description
1 or more	N/A	DIN rail (steel, not aluminum)
1	One of the following: <ul style="list-style-type: none"> • 1769-L16ER-BB1B • 1769-L18ER-BB1B • 1769-L18ERM-BB1B 	CompactLogix 5370 L1 controller The tasks that are described in this publication use a 1769-L18ERM-BB1B controller.
1	User Selectable, for example 1606-XLE120E	NEC Class 2/SELV switched-mode power supply
1	1734-0B4E	POINT I/O 8-point 24V DC electronically fused output module
1	1783-EMS08T	Stratix 6000 Ethernet managed switch
2 ⁽¹⁾	1585J-M8PBJM-2	RJ45-to-RJ45 patchcord Ethernet cables

(1) One Ethernet cable is required to connect the controller to the Ethernet switch and a second Ethernet cable is required to connect the Ethernet switch to the computer.

Follow These Steps

[Install the EtherNet/IP Network](#) [page 17](#)

[Install the Secure Digital Card](#) [page 18](#)

[Mount the Controller](#) [page 20](#)

[Install the Local Expansion Module](#) [page 21](#)

[Wire Power to the Controller](#) [page 23](#)

[Make Network Connections](#) [page 26](#)

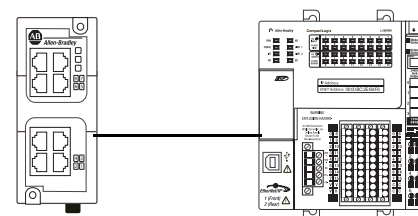
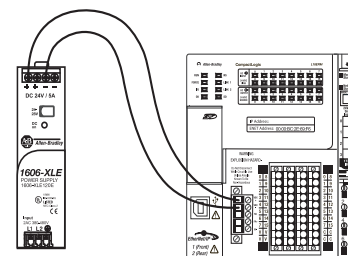
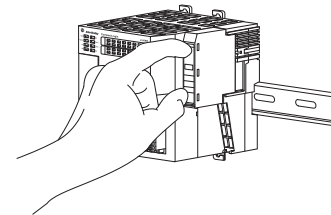
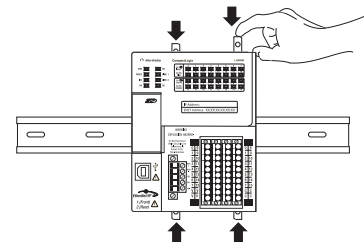
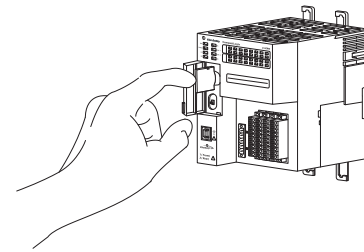

Install the EtherNet/IP Network

You are not required to install an EtherNet/IP network to complete the tasks that are described in this quick start. You can complete the tasks via a USB connection to the CompactLogix 5370 L1 controller. However, we **recommend** that you install an EtherNet/IP network.

You can complete some tasks that are described in the publications that are listed on [page 11](#). If you install an EtherNet/IP network when using this quick start, you can complete the tasks that are described in the publications that are listed on [page 11](#) more easily.

For information on installing an EtherNet/IP network, see the publications that are listed in the following table.

Network	Publication Title	Publication Number
EtherNet/IP	EtherNet/IP Media Planning and Installation Manual	Publication that is maintained and made available by ODVA. Click here to access the publication.
	Ethernet Design Considerations Reference Manual	ENET-RM002
	Stratix 6000 Ethernet Managed Switches Installation Instructions	1783-IN004
	Stratix 6000 Ethernet Managed Switch User Manual	1783-UM001

The publications that are listed previously describe how to install the communication network and not how to connect your controller to the network. Make Network Connections on [page 26](#) describes how to connect your controller to the network.

Install the Secure Digital Card

The SD card provides nonvolatile storage for the CompactLogix 5370 L1 controller. You can store Logix Designer projects to an SD card or load a Logix Designer project from an SD card.

The following SD cards are available for use with your CompactLogix 5370 L1 controller:

- 1784-SD1 card - 1 GB of memory
- 1784-SD2 card - 2 GB of memory

The CompactLogix 5370 L1 controllers ship from the factory with the 1784-SD1 SD card installed.

Complete these steps to reinstall an SD card that has been removed from the controller back into the controller or if installing a new SD card into the controller.



WARNING: When you insert or remove the SD card while power is on, an electrical arc can occur. This could cause an explosion in hazardous location installations.

Be sure that power is removed or the area is nonhazardous before proceeding.

1. Verify that the SD card is locked or unlocked according to your preference.

Consider these points when deciding to lock the card before installation:

- If the card is unlocked, the controller can write data to it or read data from it.
- If the card is locked, the controller can only read data from it.

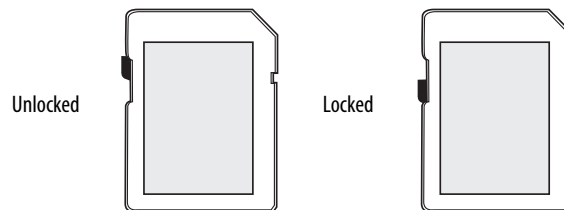

2. Open the door for the SD card.

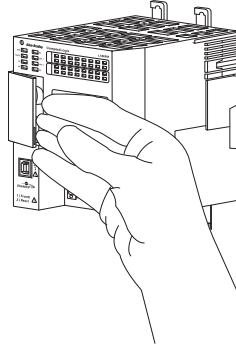

3. Insert the SD card into the SD card slot.

You can install the SD card in only one orientation. The beveled corner is at the top. An orientation logo is printed on the card.

If you feel resistance when inserting the SD card, pull it out and change the orientation.

4. Gently press the card until it clicks into place.
5. Close the SD card door.

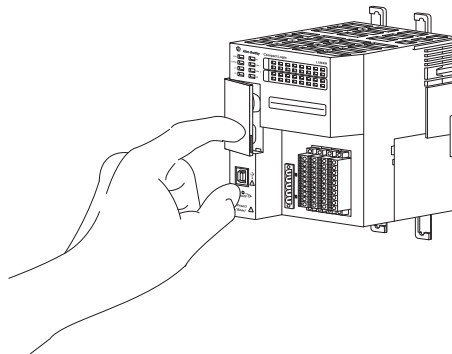
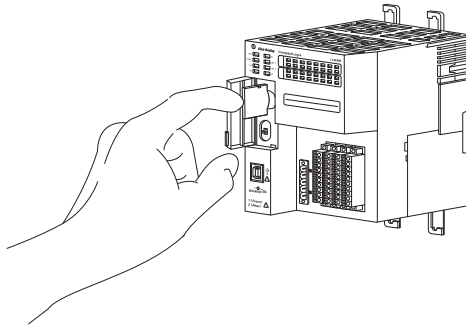

Mount the Controller

1. Pull out the locking tabs.

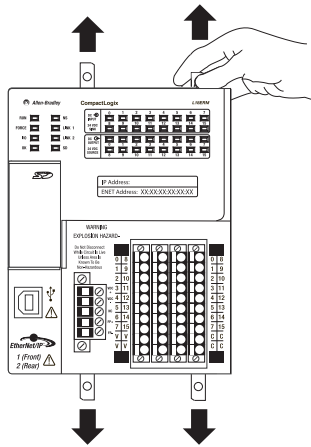

2. Slide the controller into position on the DIN rail and push the locking tabs in.
3. Make sure the protective covering on the right side of the controller is removed.

The protective covering must be removed to install a local expansion module, as described beginning on [page 21](#).

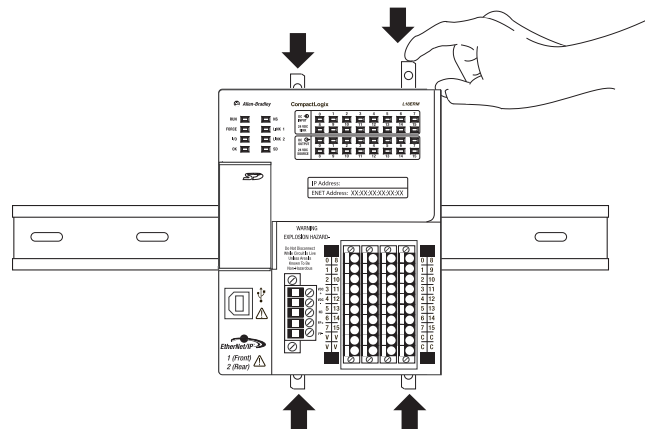

Install the Local Expansion Module

This quick start uses a 1734-OB4E POINT I/O output module in a local expansion module slot.

1. Make sure the DIN rail locking screw in the mounting base, for example, the 1734-TB mounting base, is in the vertical position.
2. Align the tongue and groove slots of the mounting base to the slots on the right side of the controller and push it back until it seats on the DIN rail.

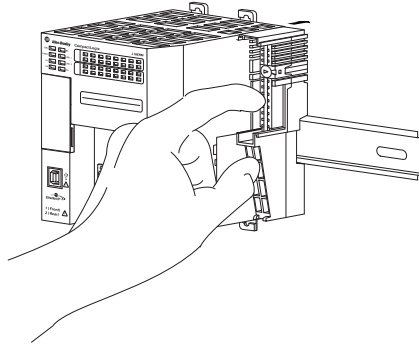

3. Use a small-bladed screwdriver to rotate the DIN rail locking screw to a horizontal position, locking the mounting base in place.

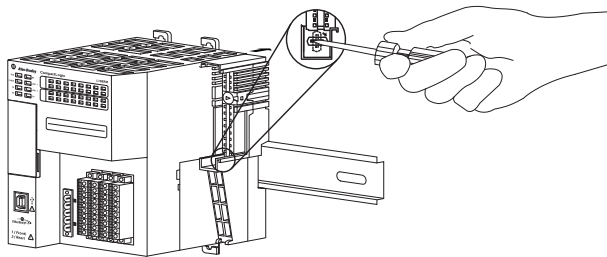

4. Set the key position on the mounting base before installing the 1734-OB4E module.

This example shows position 1.

5. Make sure the output module's key position matches the position that is used on the mounting base. Pull the key out from the output module to reposition it if necessary.

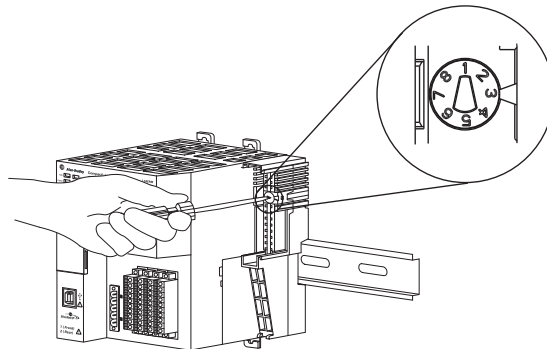

6. Insert the module straight into the mounting base and press to secure.

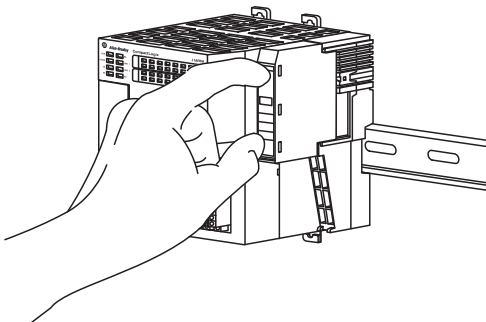

7. Insert the RTB end opposite the handle into the base unit.

The end has a curved section that engages with the mounting base.

8. Rotate the terminal block into the mounting base to lock it in place.
9. Snap the RTB handle into place on the module.

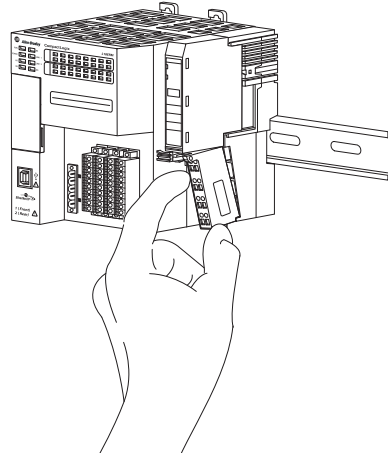

10. Connect an end cap to the right side of the module.

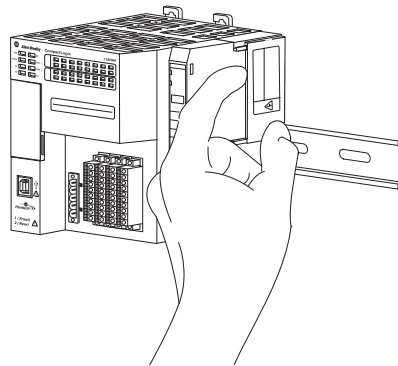

Wire Power to the Controller

This quick start uses a 1606-XLE120E NEC Class 2, switched-mode power supply to power the CompactLogix 5370 L1 controller. The controller used in this quick start is a CompactLogix 5370 L1 series B controller. Further wiring information for the CompactLogix 5370 L1 series A controller can be found in the CompactLogix 5370 Controllers User Manual, publication [1769-UM021](#).

IMPORTANT This section describes how to wire power to the controller. The controller is grounded by its connection to the DIN rail.

1. Verify that input power to the external power supply is turned off.
2. Mount the power supply on the DIN rail.
3. Wire input power to the power supply by using the following terminals:

-  (ground)
- L2 (neutral)
- L1 (line)

4. Connect a wire to the 24V DC+ terminal on the top of the power supply.

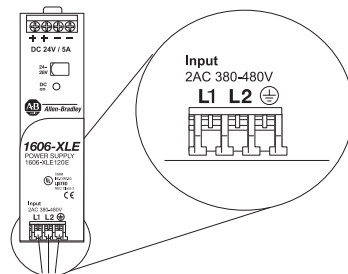

5. Loosen the screws securing the removable connector to the CompactLogix 5370 L1 controller and pull the connector off of the controller.

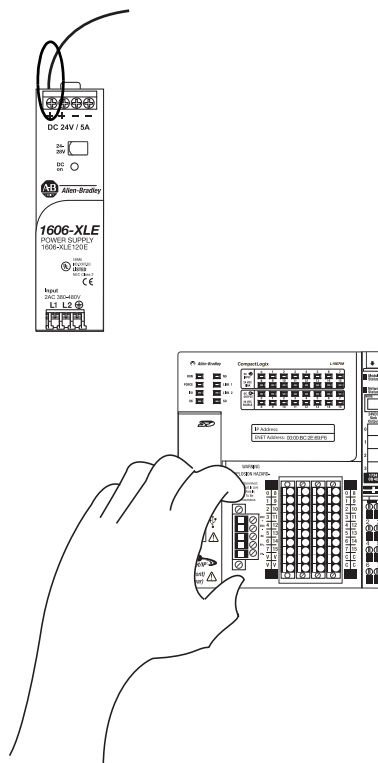

6. Open the top terminal on the removable connector.

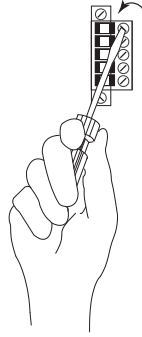

7. Insert the wire that is connected to the 24V DC+ terminal on the external power supply to the VDC + terminal on the removable connector and close the terminal.

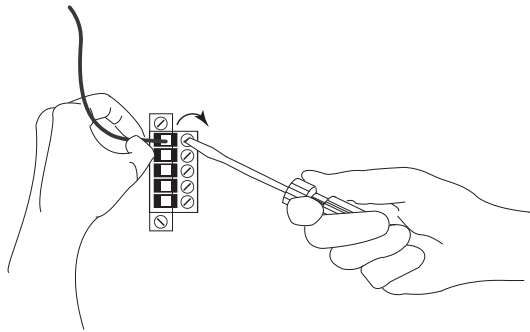

8. Connect a wire to a 24V DC- terminal on the power supply.
9. Connect the other end of the wire to the VDC - terminal on the removable connector by repeating steps 6 and 7.

10. Plug the removable connector into the controller.

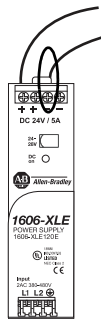

- Secure the removable connector in place.

This graphic shows the 1606-XLP50E switched-mode power supply that is connected to the CompactLogix 5370 L1 controller.

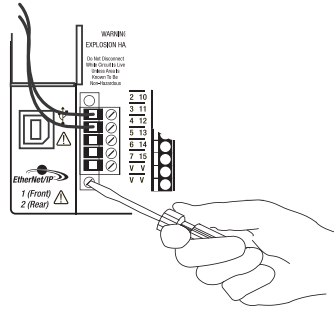

- Turn on incoming power to the external power supply.

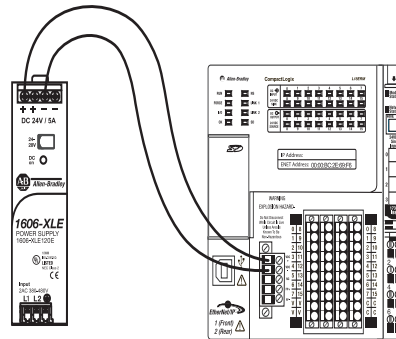

IMPORTANT You wire only the VDC+ and VDC- terminals on the CompactLogix 5370 L1 controller’s embedded power supply to complete the tasks in this quick start.

In real-world applications, you can have additional considerations that are related to connected power in an application, such as connecting power to multiple controllers or connecting power to input and output devices that are connected to the controller’s embedded I/O modules and local expansion modules via the FP+, and FP- terminals on the removable terminal.

For more information on connecting power to the CompactLogix 5370 L1 control system, see the CompactLogix 5370 Controllers User Manual, publication [1769-UM021](#).

Make Network Connections

You can make these connections to a CompactLogix 5370 L1 controller:

- [Make a USB Connection](#)
- [Make EtherNet/IP Network Connections](#)

IMPORTANT This section describes the methods of connecting your computer to your CompactLogix 5370 L1 controller. This quick start was written under the assumption that you have installed an EtherNet/IP network.

Make a USB Connection

The controller has a USB port that uses a Type B receptacle. The port is USB 2.0-compatible and operates at 12 Mbps.

Use a USB cable to connect your computer to the USB port. With this connection, you can upgrade firmware and download programs to the controller directly from your computer.



ATTENTION: The USB port is intended only for temporary local programming purposes and not intended for permanent connection.

The USB cable is not to exceed 3.0 m (9.84 ft) and must not contain hubs.



WARNING: Do not use the USB port in hazardous locations.

1. Plug one end of the USB cable into your CompactLogix 5370 L1 controller.
2. Plug the other end of the USB cable into your computer.

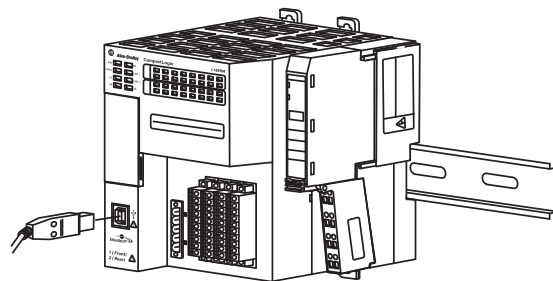

Make EtherNet/IP Network Connections

This section assumes that you installed an EtherNet/IP network as described on [page 17](#) and the network includes a 1783-EMS08T Stratix 6000 Ethernet managed switch.

1. Plug a 1585J-M4TBJM-1, Ethernet cable (straight-through) into a port on the Stratix 6000 switch.
2. Plug the other end of the Ethernet cable into one of the Ethernet ports on the bottom of the controller.

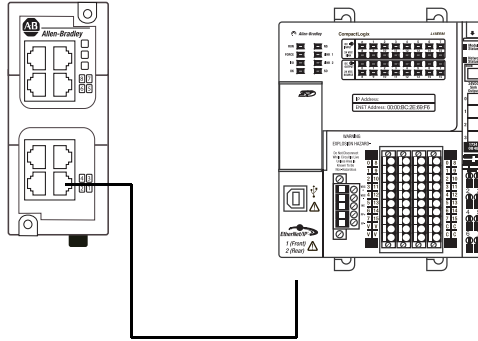

Set the Network IP Address

Once you connect the CompactLogix 5370 L1 controller to an EtherNet/IP network, you must assign the controller a unique IP address. For information about how to set the network IP address for your controller, see Chapter 3, [Configure the EtherNet/IP Network on page 43](#).

Notes:

Prepare the Computer and Load Controller Firmware

In this chapter, you install and configure the necessary programming and configuration software on your computer and load firmware on your controller.

Before You Begin

Before you begin using this chapter, complete these tasks:

- Verify that your computer meets the software's system requirements for installation and use of the software that is listed in [Table 2 on page 12](#).
- The tasks that are described in Chapter 1, [Prepare the CompactLogix 5370 L1 Controller Hardware on page 15](#), including the following:
 - Install the EtherNet/IP network - Optional task because you can use a USB cable connection.
 - Install the controller and the local expansion module.
 - Wire power to the controller.
 - Make network connections.

What You Need

[Table 6](#) lists the components you use in this chapter.

Table 6 - What You Need to Prepare the Computer

Component	Description
Studio 5000 environment	Environment that combines engineering and design elements into a common environment.
Logix Designer application	Software that is used to create a project the CompactLogix 5370 L3 controller uses in your application.
RSLinx Classic software	Communication server that supports multiple software applications simultaneously, establishing communication between devices on many Rockwell Automation industrial networks.
IP address	A number in the form xxx.xxx.xxx.xxx where each xxx is a number from 000 . . . 254. The IP address uniquely identifies the computer on the EtherNet/IP network.
Subnet Mask	Extension of the IP address that lets a site use one network ID for multiple physical networks. If you change the subnet mask of an already-configured controller, you must cycle power to the controller for the change to take effect.
ControlFLASH software	Software that is used to upgrade the firmware on certain Allen-Bradley® products in a CompactLogix 5370 L1 controller application. Automatically installed with the Studio 5000 environment installation.

Follow These Steps

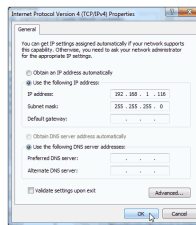
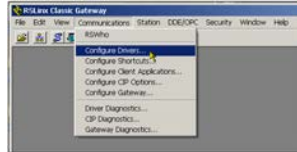
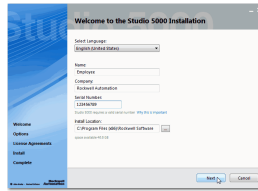
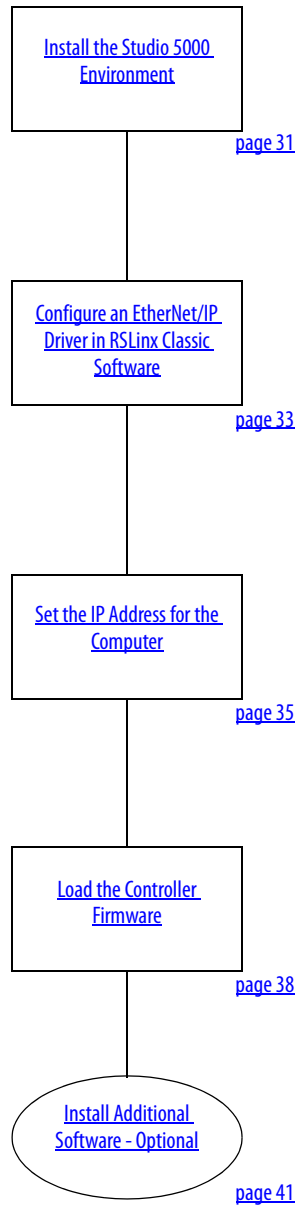

Install the Studio 5000 Environment

The Studio 5000 environment installation process is configured so that, among other software applications, RSLinx Classic software, version 3.51.00, is automatically installed.

The automatic installation option is enabled by default. You can change the installation setting and install RSLinx Classic software separately. We strongly recommend that you use the installation process default settings that are described in this chapter.

IMPORTANT The steps in this section are based on a version 21.00.00 Studio 5000 environment installation. The steps necessary for your installation may vary.

1. Start the installation.

You can load the software from a CD or web download.

2. Choose a language, enter the required information, and click Next.

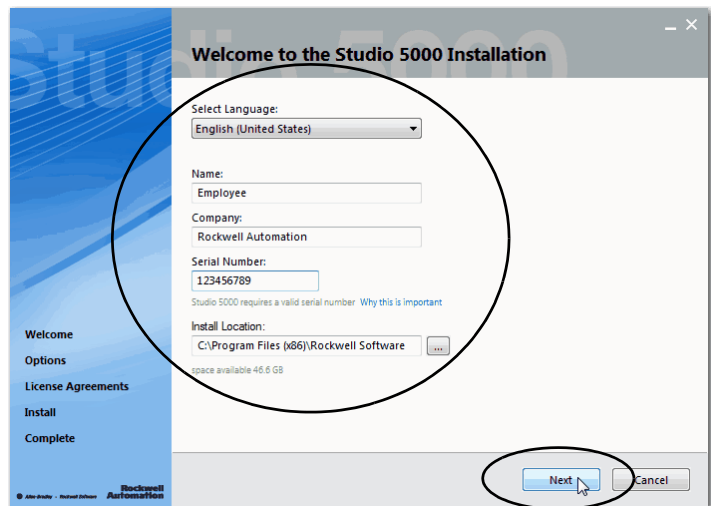

3. Use the default selections and click Install.
4. Read the license agreement carefully.

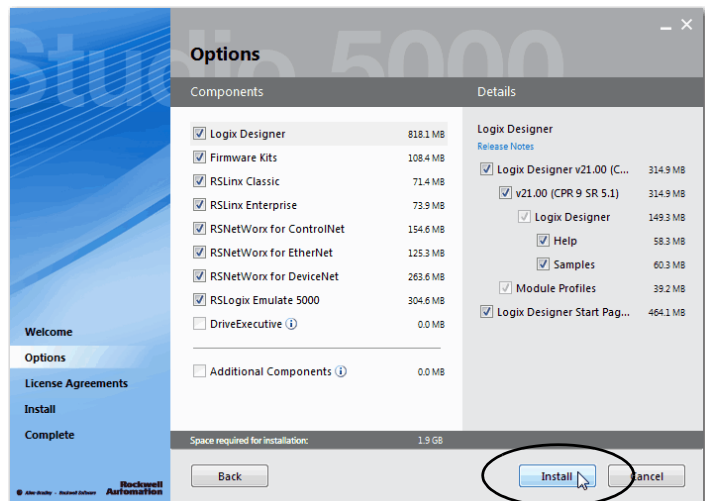

5. Click Accept All.

The installation process begins.

When installation is complete, your computer has the software necessary required to complete the tasks that are described in this publication.

Among other software, your computer has the following:

- Studio 5000 environment, version 21.00.00 or later
- RSLinx Classic software, version 3.51.00 or later

You are prompted to activate the software. For more information on software activation, see the following:

- Rockwell Automation Technical Support Software Activations site <http://www.rockwellautomation.com/rockwellautomation/support/activations.html>

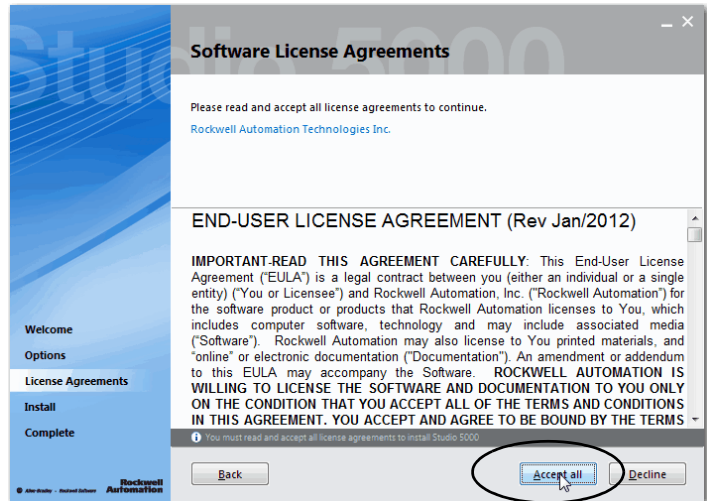

Automatic Installation of ControlFLASH Software

ControlFLASH software is used to upgrade a CompactLogix 5370 L1 controller's firmware revision. ControlFLASH software is automatically installed when you install the Studio 5000 environment.

For more information on loading firmware on your controller, see [Load the Controller Firmware on page 38](#).

Configure an EtherNet/IP Driver in RSLinx Classic Software

1. Start the software.

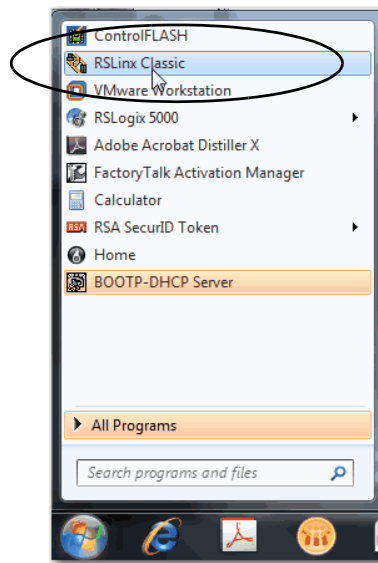

2. From the Communications pull-down menu, choose Configure Drivers.

The Configure Drivers dialog box appears.

3. From the Available Driver Types menu, choose EtherNet/IP Driver or Ethernet devices and click Add New.

We recommend that you use EtherNet/IP Driver.

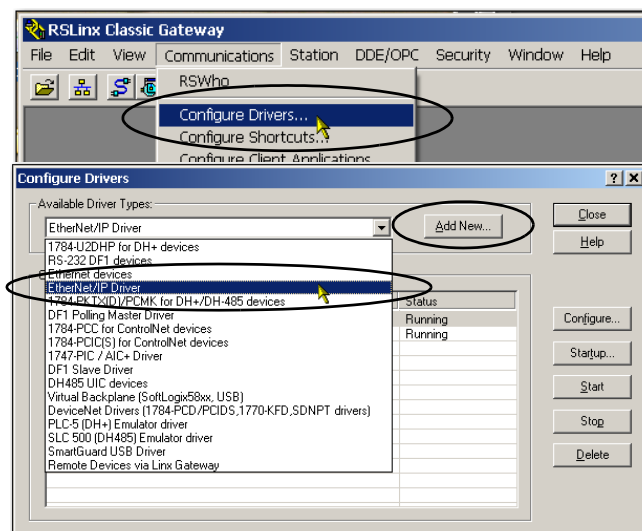

The Add New RSLinx Driver dialog box appears.

4. Click OK to keep the default name.

A Configure driver:AB_ETHxxx dialog box appears. The full name of the dialog box varies by what driver type was chosen in [step 3](#).

This example uses the EtherNet/IP Driver; the driver name is AB_ETHIP-1.

5. Select an Ethernet card and click OK.

This new driver is available.

6. Verify that the driver's Status is Running and click Close.

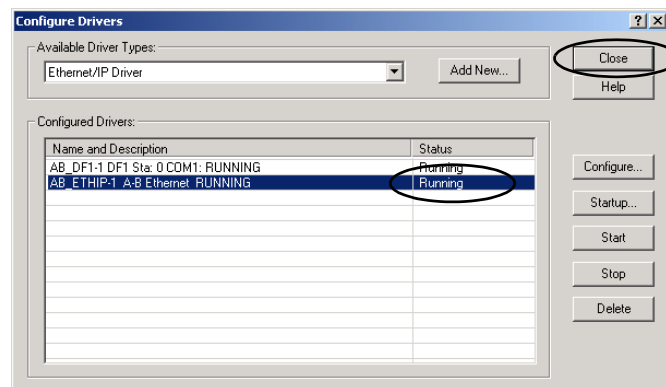
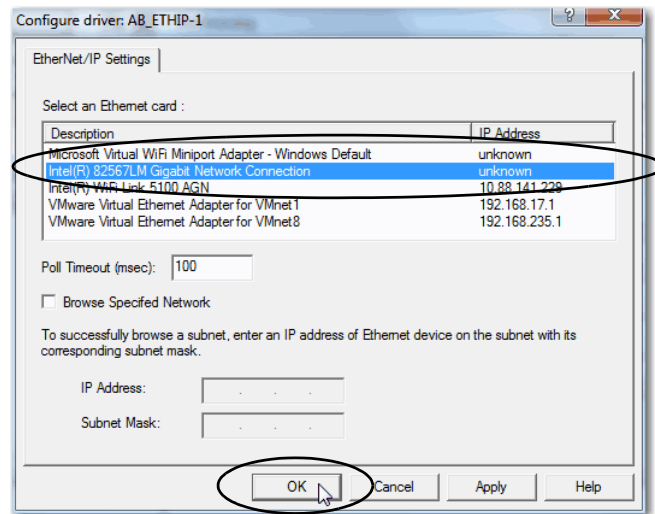
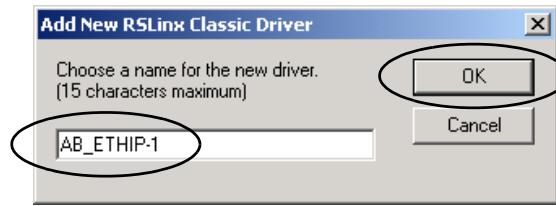

Set the IP Address for the Computer

Your computer requires an Internet Protocol (IP) address to operate on an EtherNet/IP network. The IP address uniquely identifies the controller and is in the form *xxx.xxx.xxx.xxx* where each *xxx* is a number from 000...254 with some exceptions for reserved values.

A computer's IP address can be set automatically or manually. The manual option is typically used with isolated networks. This section describes how to set the IP address manually.

For more information on setting an IP address for your CompactLogix 5370 L1 controller, see the CompactLogix 5370 Controllers User Manual, publication [1769-UM021](#).

1. On your desktop, right-click Network and choose Properties.

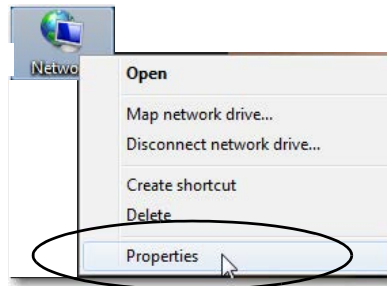

2. Click adapter settings.

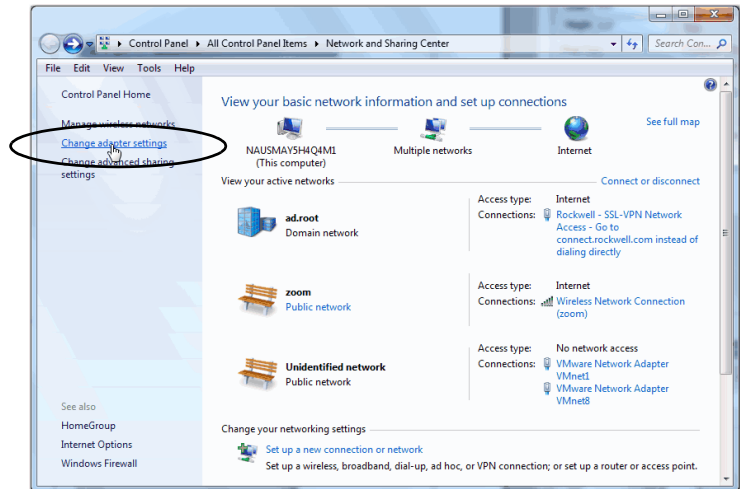

3. Right-click Local Area Connection and choose Properties.

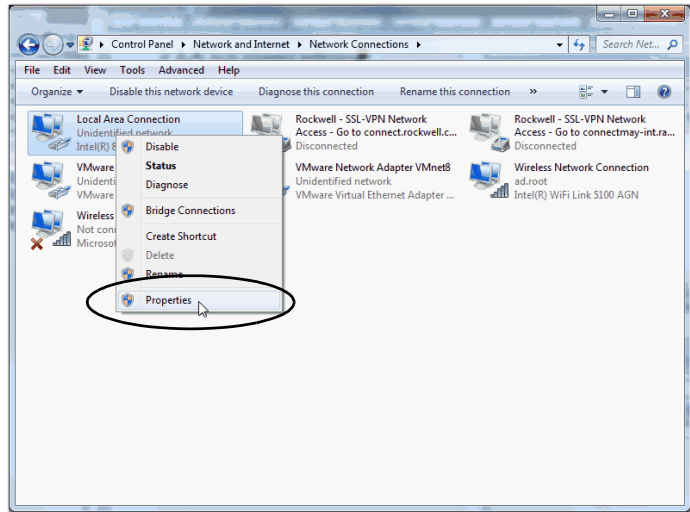

4. On the Networking tab, choose Internet Protocol Version 4 (TCP/IPv4) and click Properties.

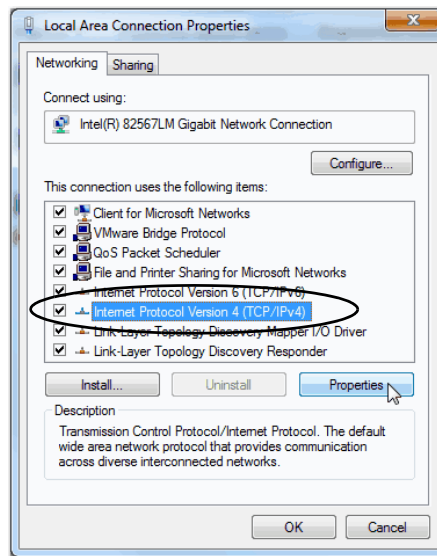

5. Select Use the following IP address and enter an IP address and Subnet mask for your computer.
 6. Record the IP address and subnet mask.
 7. Click OK.
-
8. Close the Local Area Connection Properties dialog box.

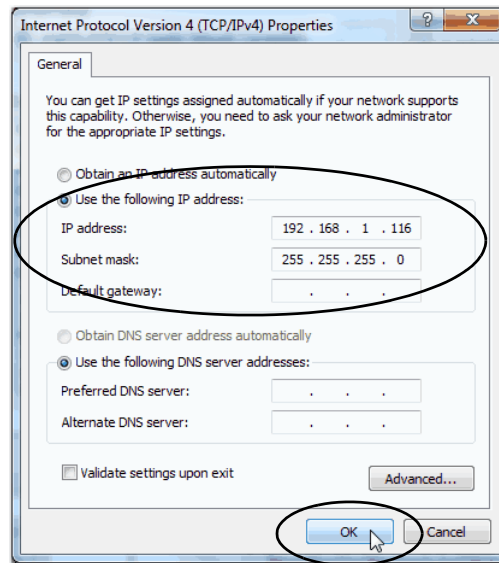

Load the Controller Firmware

IMPORTANT

This section assumes that you downloaded the controller firmware from the Rockwell Automation technical support website to install on your CompactLogix 5370 L1 controller. If not, download the firmware before following the steps in this section.

The firmware is available with Logix Designer application or you can download it from the support website.

Go to <http://www.rockwellautomation.com/support/>.

This section describes how to load firmware on your CompactLogix 5370 L1 controller before setting an IP address for the controller. In this case, you must connect from your workstation to the controller over the USB port.

With this quick start, you must use RSLinx Classic software, version 3.51.00 or later with CompactLogix 5370 L1 controllers. When the software is installed, a USB driver is automatically installed. When your computer is connected to the CompactLogix 5370 L1 controller over a USB connection, the controller appears in the RSWho window whenever you perform a Browse.

1. Verify that the SD card in the controller is unlocked.
2. Connect to the controller via the USB port as described in [Make a USB Connection on page 26](#).

The controller is powered on. If it is not, turn on power to the controller.

3. Start the ControlFLASH software.

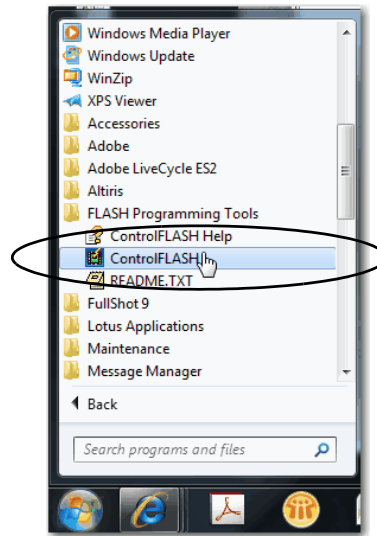

4. Select the directory that you want to use.

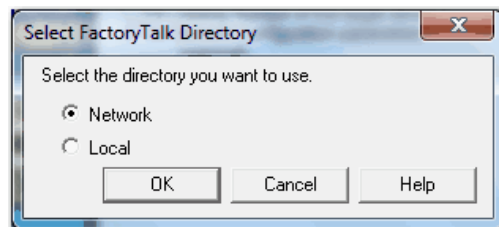

5. Click Next.

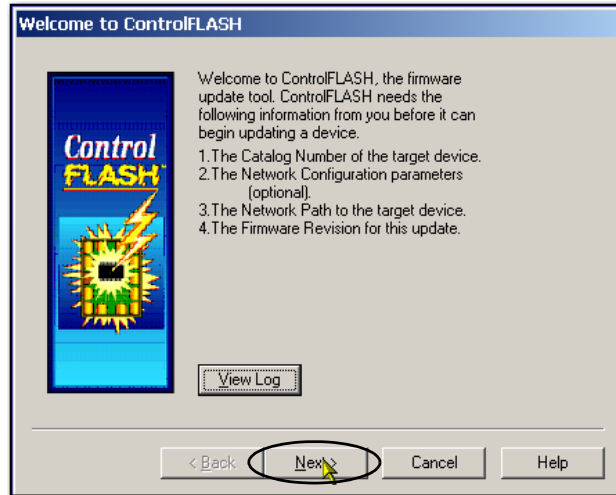

6. Select the controller catalog number and click Next.

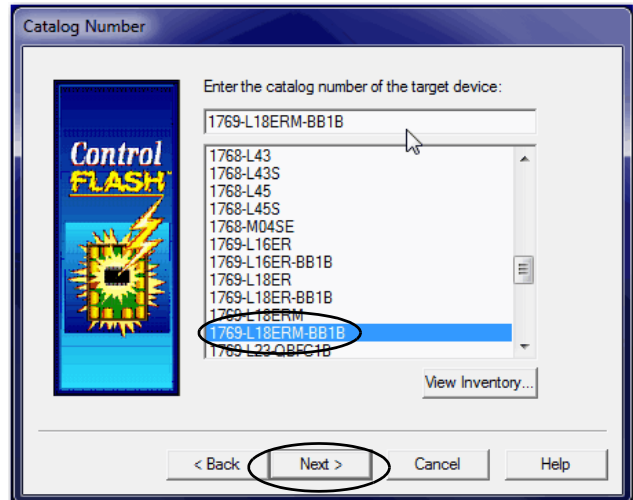

7. Expand the USB driver, and select your controller.
8. Click OK.

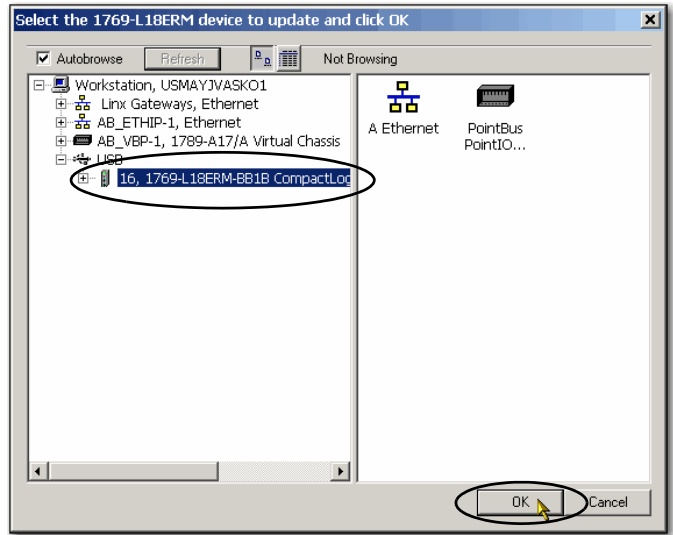

9. If it's not in the position, move the mode switch on the controller to the REM position.

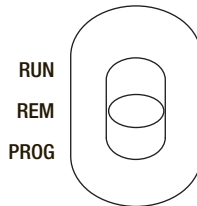

10. Choose the desired firmware revision and click Next.

- TIP** Consider the following:
- If the Current Revision matches the firmware revision that is shown in the box below it, click Cancel. You are finished with this task.
 - This example uses firmware revision 21.011.49. Your firmware revision is another number.

You can access the latest firmware revision at the Rockwell Automation Technical Support webpage.

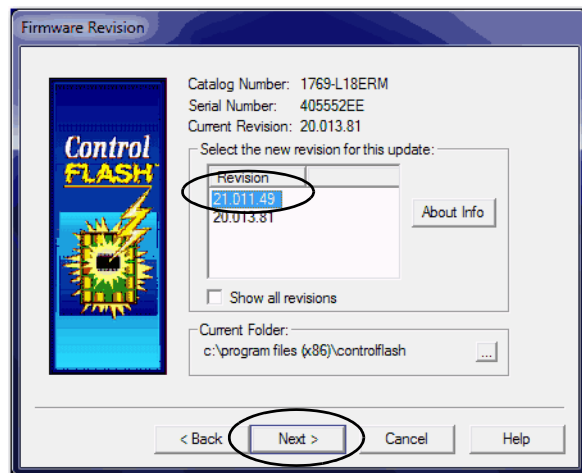

- To start the firmware update, click Finish and click Yes.

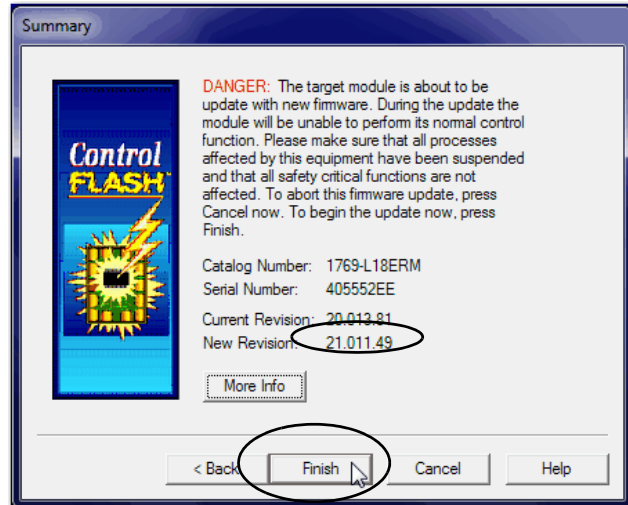

Before the firmware upgrade begins, you see the following dialog box. Take the required action for your application. In this example, the upgrade continues when OK is clicked. This can take a few minutes to complete.

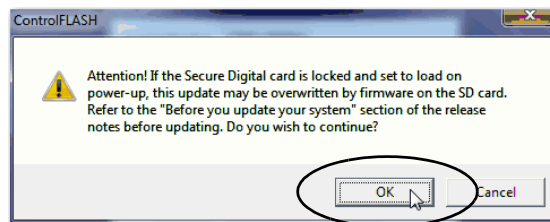

When the update completes, the status box informs you that the update was successful.

- In the Update Status dialog box, Click OK.

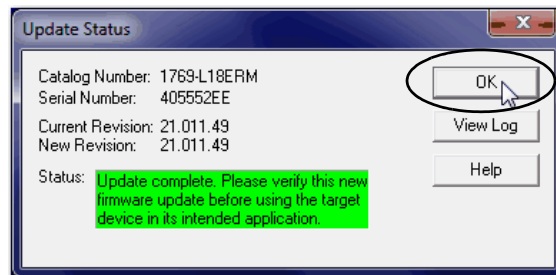

Install Additional Software - Optional

Depending on your application, you can install additional software.

For example, if you are integrating a PanelView Plus terminal into your system, you must install the following:

- RSLinx Enterprise software

IMPORTANT You must install this software before you install any other additional software.

- FactoryTalk® View Machine Edition software

Notes:

Configure the EtherNet/IP Network

In this chapter, you assign an IP address to your CompactLogix 5370 L1 controller.

This quick start does not describe how to use other devices on the EtherNet/IP network. It is common to use other devices on an EtherNet/IP network in a CompactLogix 5370 L1 control system. If you were to do so, for example, use a PanelView Plus terminal on an EtherNet/IP network, you must assign an IP address to those devices.

IMPORTANT Not all tasks that are described in this quick start are required to complete the final task, that is, use ladder logic to test a 1734-OB4E output module as described beginning on [page 47](#). For example, you do not need to install an EtherNet/IP network to connect to a CompactLogix 5370 L3 controller because you can do so over a USB cable.

We expect that you can attempt to complete additional tasks with your control system by using the publications that are listed on [page 11](#) relating to using a component over an EtherNet/IP network in a Logix5000 control system. When you use those publications, some assumptions are made. For example, if you use POINT I/O modules over an EtherNet/IP network in a CompactLogix 5370 L1 control system, you must have created a Logix Designer project and have an IP address that is assigned to the controller.

If you complete all tasks that are described in this chapter, you can easily complete the tasks that are described in the publications that are listed on [page 11](#) related to using an EtherNet/IP network.

Before You Begin

Before you begin using this chapter, complete these tasks:

- The tasks that are described in Chapter 1, [Prepare the CompactLogix 5370 L1 Controller Hardware on page 15](#), including the following:
 - Install the EtherNet/IP network.
 - Mount the controller and install the local expansion module.
 - Wire power to the controller.
 - Make network connection.

IMPORTANT If you connect all devices, including the computer, through an Ethernet switch, you can create an isolated network. This chapter assumes you are using an isolated network. If you are not, contact your network administrator to obtain IP addresses.

- The tasks that are described in Chapter 2, [Prepare the Computer and Load Controller Firmware on page 29](#), including the following:
 - Install the Studio 5000 environment and RSLinx Classic software.
 - Logix Designer application is installed when you install the Studio 5000 environment.
 - Configure an EtherNet/IP driver in RSLinx Classic software.
 - Set the IP address for the computer.
 - Load firmware on the controller.
- Verify that power is applied to all devices.

What You Need

[Table 7](#) lists the software components you use in this chapter.

Table 7 - What You Need to Configure the EtherNet/IP Network

Component	Description
Studio 5000 environment	Environment that combines engineering and design elements into a common environment.
Logix Designer application	Software that is used to create a project the CompactLogix 5370 L1 controller use in your application.
RSLinx Classic software	Communication server that supports multiple software applications simultaneously, establishing communication between devices on many Rockwell Automation industrial networks.
IP address	A number in the form xxx.xxx.xxx.xxx where each xxx is a number from 000...254. The IP address uniquely identifies the controller on the EtherNet/IP network.
Subnet mask	Extension of the IP address that lets a site use one network ID for multiple physical networks. If you change the subnet mask of a configured controller, you must cycle power to the controller for the change to take effect.

Assign an IP Address to the Controller over a USB Connection

At initial powerup, the CompactLogix 5370 L1 controller does not have an IP address. Use RSLinx Classic software over a USB connection to assign an IP address. The following steps work only if the computer with RSLinx Classic software is connected to the controller via a USB connection.

IMPORTANT There are other methods to assign an IP address to the controller, such as using the BOOTP/DHCP utility. This section is only one example of how to assign the IP address to the controller.

For more information on the methods of assign an IP address to the CompactLogix 5370 L1 controller, see the CompactLogix 5370 Controllers User Manual, publication [1769-UM021](#).

1. Verify that your computer is connected to the USB port on the front of the controller.
2. From the Communications menu, choose RSWho.

The RSWho dialog box appears.

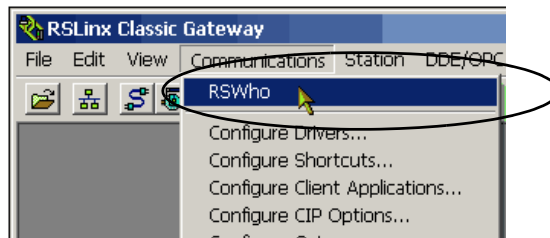

3. Navigate to the USB connection.
4. Right-click the controller and choose Module Configuration.

The Module Configuration dialog box appears.

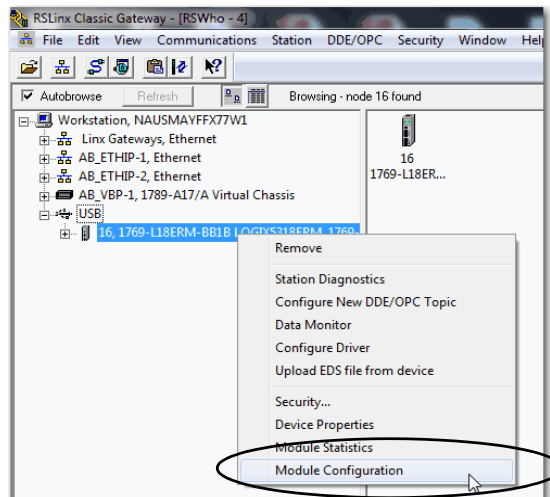

5. Click the Port Configuration tab.
6. For Network Configuration Type, click Static to assign this configuration to the port.

IMPORTANT The controller's default configuration is Dynamic. When the controller is configured for Dynamic, on a power cycle, it clears the current IP address and resumes sending BOOTP requests.

7. Enter the IP address and Network Mask for the controller.
8. Enter other network parameters, if necessary.
9. Click OK.
10. In the ControlLogix Gateway Tool dialog box, click Yes.

For more information on setting the network IP address, see EtherNet/IP Network Configuration User Manual, publication [ENET-UM001](#).

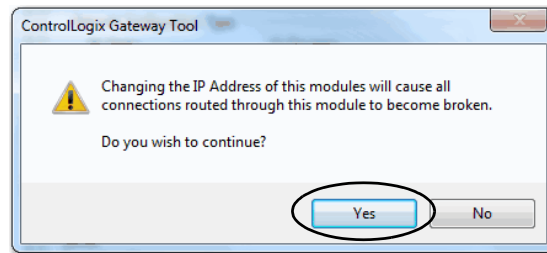
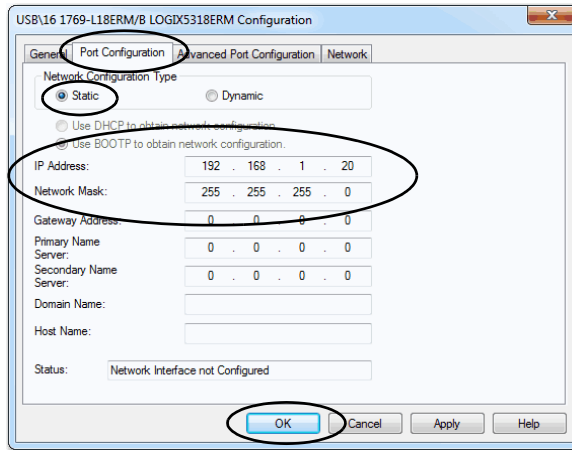

Create a Logix Designer Project

In this chapter, you create a Logix Designer project. In the project, you use ladder logic to create a push button that controls a light on a digital output module.

You learn how to complete the following tasks:

- Create a Logix Designer project.
- Configure your 1769-L18ERM-BB1B controller.
- Add a local expansion module to the project.
- Add ladder logic to the project to test the local expansion module.
- Download the project to the controller.

IMPORTANT You must use Logix Designer application with this quick start. The tasks that are described in this chapter are described with the intention that you can reuse the project to complete the tasks that are described in publications listed on [page 11](#). Because you are likely to use other devices in your CompactLogix 5370 L1 control system, you can use the project that is created in this chapter to complete the tasks that are described in the publications that are listed on [page 11](#).

Before You Begin

Before you begin, complete these tasks:

- The tasks that are described in Chapter 1, [Prepare the CompactLogix 5370 L1 Controller Hardware on page 15](#), including the following:
 - Install the EtherNet/IP network.
 - Install the controller and the local expansion module.
 - Wire power to the controller.
 - Make network connections.
- The tasks that are described in Chapter 2, [Prepare the Computer and Load Controller Firmware on page 29](#), including the following:
 - Install the Studio 5000 environment and RSLinx Classic software.

Logix Designer application is installed when you install the Studio 5000 environment.
 - Configure an EtherNet/IP driver in RSLinx Classic software.
 - Set the IP address for the computer.
 - Load firmware on the controller.
- Set the IP address for the controller as described in Chapter 3 on [page 43](#).
- Verify that all devices are powered.

What You Need

You need Logix Designer application to complete the tasks in this chapter.

Follow These Steps

[Create a Project](#)

[page 50](#)



[Configure the Controller](#)

[page 51](#)



[Add a Local Expansion Module](#)

[page 54](#)

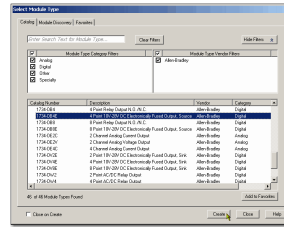

[Add Ladder Logic to Test the Local Expansion Module](#)

[page 56](#)

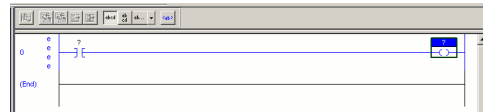

[Download to the Controller](#)

[page 59](#)

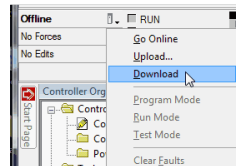

Create a Project

1. Start the application.

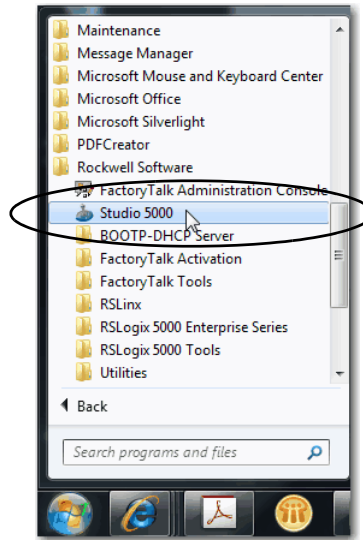

2. Click New Project.

The New Controller dialog box appears.

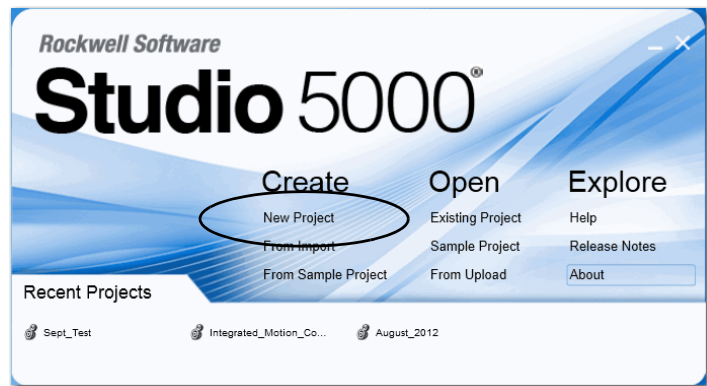

3. Choose your controller and name the project.
4. Click Next.

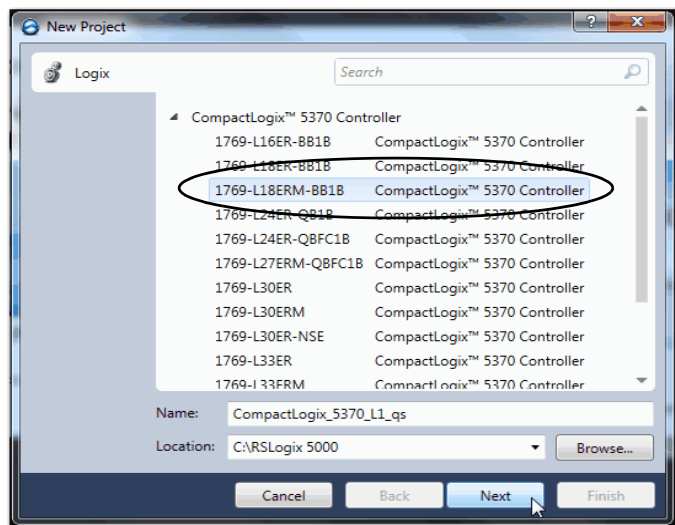

- Set Expansion I/O to a number that matches the number of 1734 POINT I/O modules that are physically installed in the system.

In this case, the value is 1 Module.

- Click Finish.

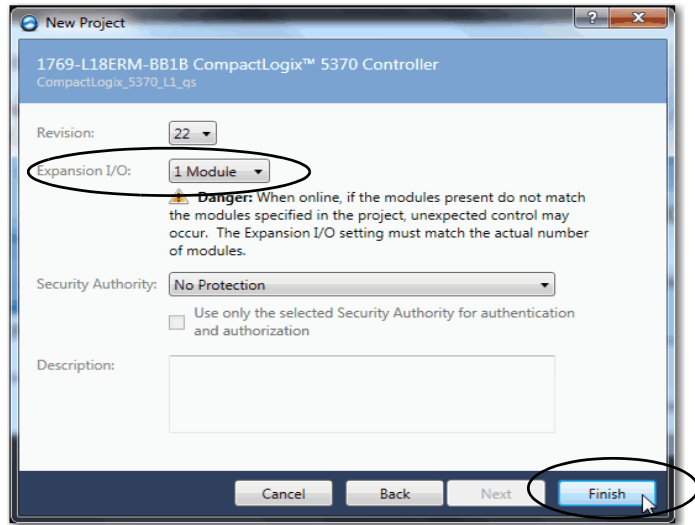

Configure the Controller

- Verify that the mode switch on the controller is in the REM position.

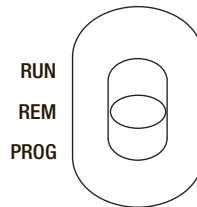

- Click the Who Active icon.



3. In the Who Active dialog box, expand the path to the controller and select it.
4. Click Set Project Path.

By clicking this button, you set the path and do not have to browse to the controller each time you use an option in the Who Active dialog box.

5. Click Go Online.

You must be online to set the controller's IP address in the Logix Designer project.

6. Click Download twice on successive dialog boxes.
7. Change the controller mode to Remote Run.
8. Click Yes at the dialog box.

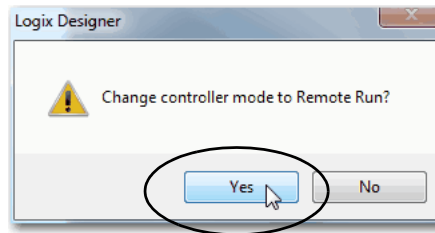
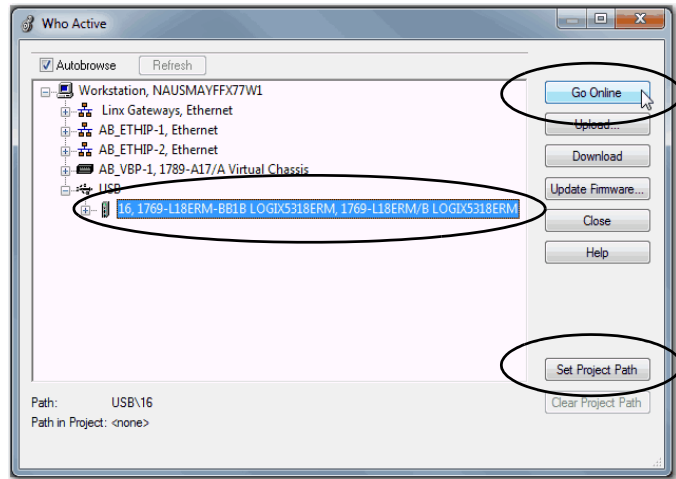

9. Expand the I/O Configuration tree.
10. Right-click the controller and choose Properties.

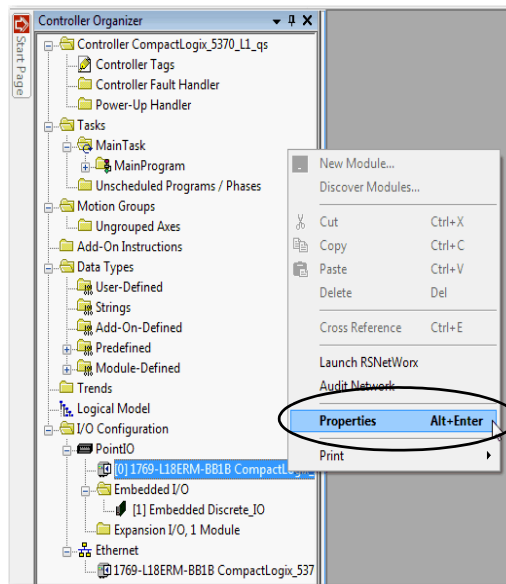

- Use the tabs on the Controller Properties dialog box to configure the controller.

The IP address is set on the Internet Protocol tab.

IMPORTANT Make sure you set an IP Address and Subnet Mask that matches the values set in [Set the IP Address for the Computer on page 35](#).

There are many configurable parameters on various tabs in the Controller Properties dialog box. For more information on configuring your CompactLogix 5370 L1 controller, see the CompactLogix 5370 Controllers User Manual, publication [1769-UM021](#).

- Click OK.
- Click Yes to apply changes.
- Go offline.

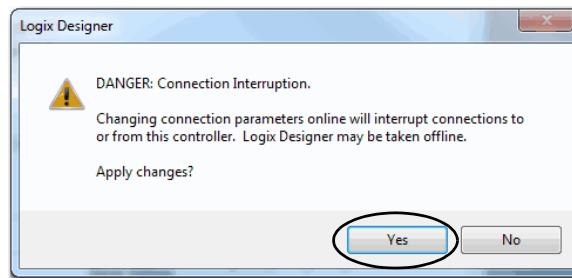
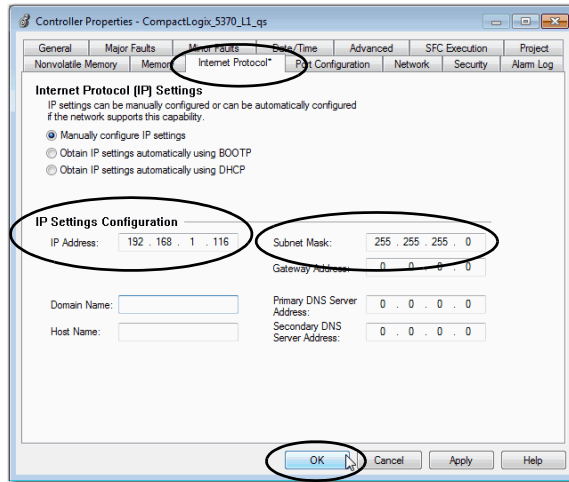

Add a Local Expansion Module

1. Right-click PointIO and choose New Module.

The Select Module Type dialog box appears.

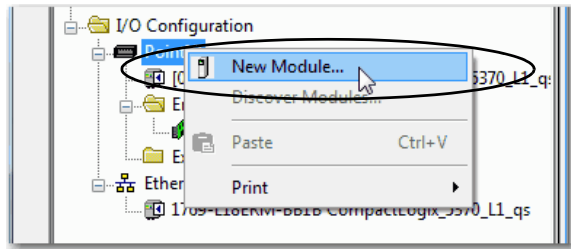

2. Select the 1734-OB4E module and click Create.

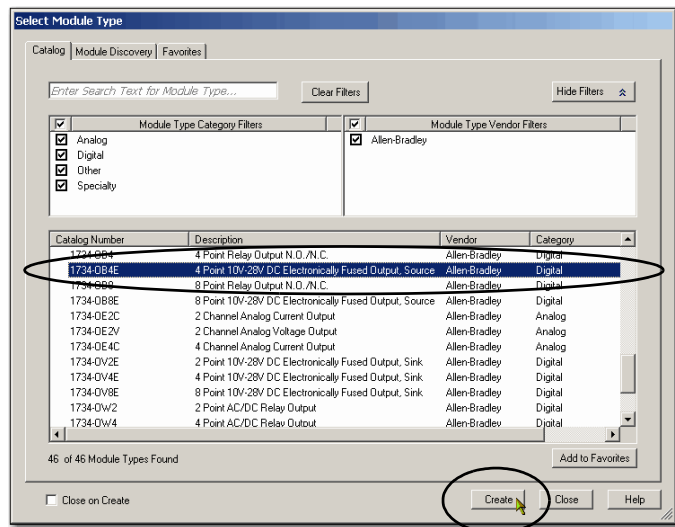

TIP You can use the Search feature in Logix Designer application to find the I/O module you must add to your project.

The New Module dialog box appears for the module created.

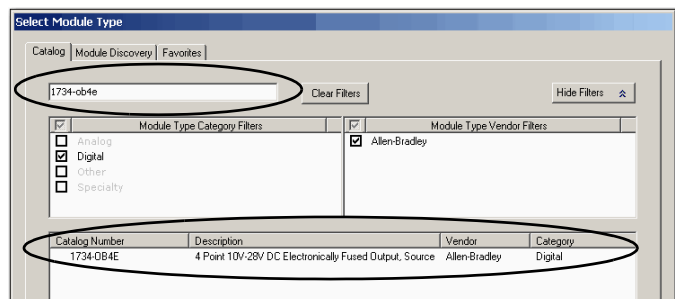

- Use the tabs to create the parameters for the I/O module.

IMPORTANT For the purposes of this exercise, make sure that you change the Module Definition parameters so Electronic Keying is set to Disable Keying.

- Type in a name for the module.
- When the module configuration is complete, click OK.

The module is added to the I/O Configuration.

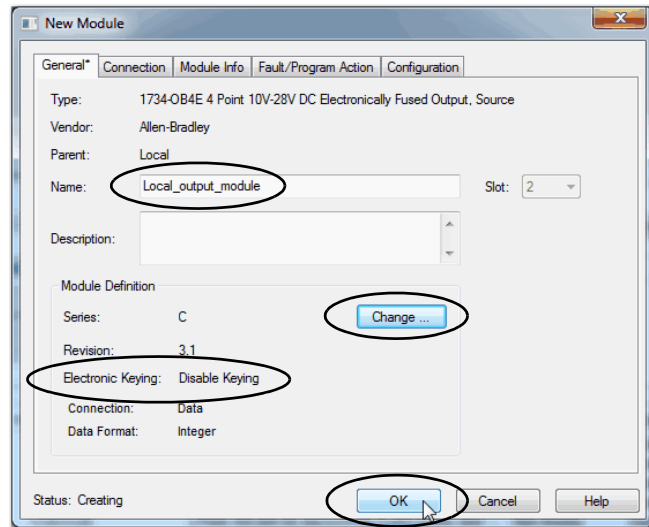

Add Ladder Logic to Test the Local Expansion Module

IMPORTANT If you do not have a 1734-OB4E module, you can use ladder logic with an embedded output point on the CompactLogix 5370 L1 controller in a similar fashion.

When using an embedded output point, instead of choosing an output point on the local expansion module, as described in [step 14 on page 58](#), you choose an embedded digital output point on the CompactLogix 5370 L1 controller.

1. Expand the Tasks folders.
2. Right-click MainRoutine and choose Open.

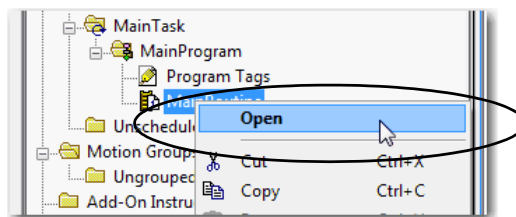

A blank MainRoutine opens.

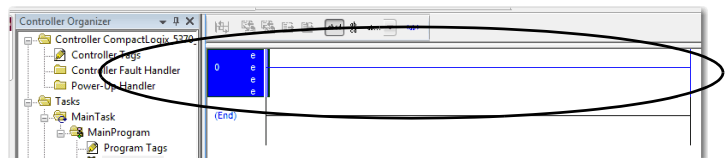

3. From the Element Toolbar, drag and drop an Examine On and an Output Energize element onto the rung.

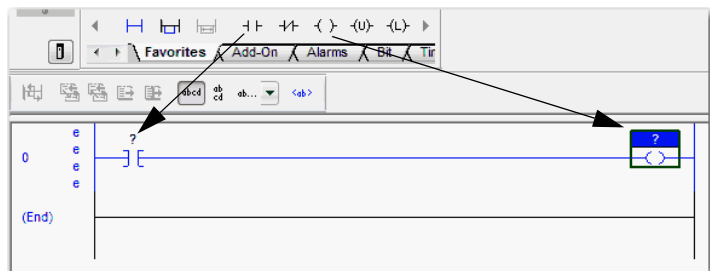

4. Double-click the ? in the Examine On element.
5. Type PB (for push button).
6. Press Enter.

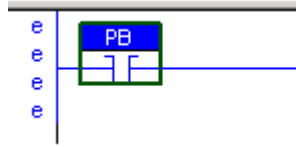
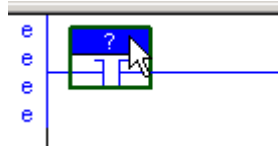

7. Right-click PB and choose New 'PB'.

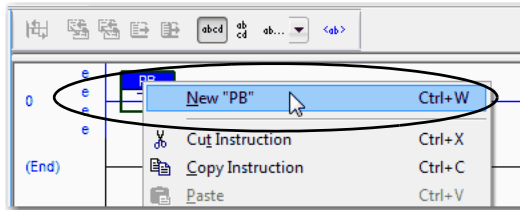

8. Select your controller from the Scope pull-down menu if necessary.
9. Keep the default settings and click one of the Create options.

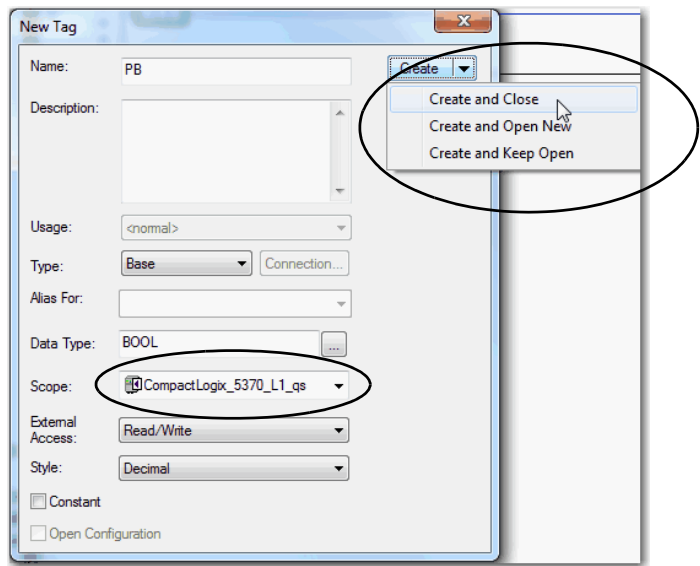

- Double-click the ? in the Output Energize element.

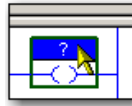

- Name the Output Energize element OB4E_Light and press Enter.



IMPORTANT Do not use spaces in the tag name. Use underscores (_) instead.

- Right-click the OB4E_Light tag name and choose New 'OB4E_Light'.

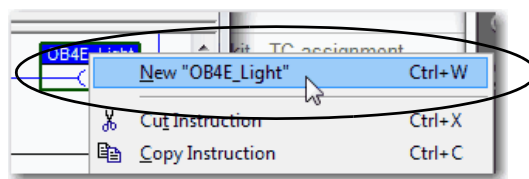

OB4E_Light is an alias tag for the I/O point tag name. With an alias tag, you can assign a simple name to a physical I/O point address.

- From the Type pull-down menu, choose Alias.
- From the Alias For pull-down menu, browse to the 1734-OB4E digital output module and choose any bit.

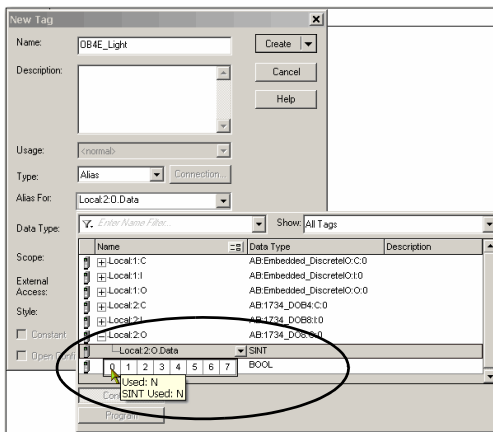

This example uses Local:2:O.Data.0.

15. Click one of the Create options.

The graphic shows the Output Energize after assigning the Alias tag to a point on the output module.



16. Save your changes.

Download to the Controller

1. From the mode pull-down menu, choose Download.
2. When the dialog box appears with information about the download, click Download.
3. Click Yes to change the controller mode to Remote Run mode.

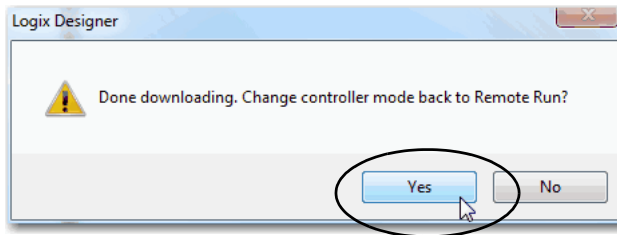
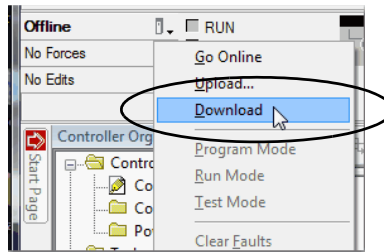

4. Move the mode switch on your controller to the RUN position.

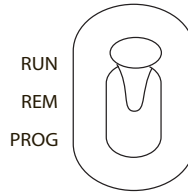

5. In the Main Routine, select the PB Examine On instruction.

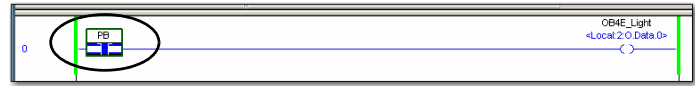

6. Press Ctrl+T to toggle the state from 0 to 1, or Off to On.

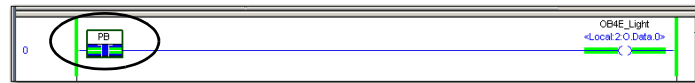

7. Verify that the status indicator on the digital output module turns on after you toggle the state to 1 or On.
8. Press Ctrl+T to toggle the state back to 0 or Off.
9. Go Offline.

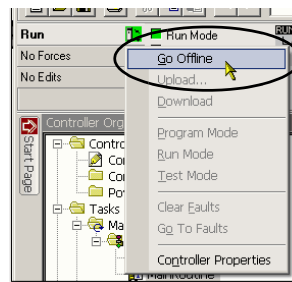

Understanding Other Application Options

This chapter describes two application options available with a CompactLogix 5370 L1 controller:

- Using the controller in a DLR network topology
- Using the controller in an application that includes Integrated Motion only on an EtherNet/IP network - 1769-L18ERM-BB1B controller

IMPORTANT This chapter does not describe the steps that are required to use the CompactLogix 5370 L1 controller in applications with DLR networks or Integrated Motion over an EtherNet/IP network.
The purpose is to introduce you to these other applications.

See the following publications for more information on using the application options:

- Using the controller in a DLR network topology:
 - CompactLogix 5370 Controllers User Manual, publication [1769-UM021](#)
 - EtherNet/IP Embedded Switch Technology Application Guide, publication [ENET-AP005](#)
- Using the controller in an application that includes Integrated Motion on the EtherNet/IP network:
 - CompactLogix 5370 Controllers User Manual, publication [1769-UM021](#)
 - CIP Motion Configuration and Startup User Manual, publication [MOTION-UM003](#)
 - Integrated Architecture® and CIP Sync Configuration Application Technique, publication [IA-AT003](#)

DLR Network Topology

A DLR network topology is a single-fault-tolerant ring network in which DLR-capable Rockwell Automation devices use embedded technology and dual EtherNet/IP ports to establish a network that is resilient to single points of failure, recovers faster when single faults occur, and does not require switches.

Configuring a DLR network topology requires you to complete a few tasks that do not apply to using a CompactLogix 5370 L1 controller in a linear or star network topology. For example, a DLR network topology requires that one supervisor-capable network device be configured as the active ring supervisor. CompactLogix 5370 L1 controllers are supervisor-capable devices on a DLR network.

This graphic shows a DLR network topology with a CompactLogix 5370 L1 controller.

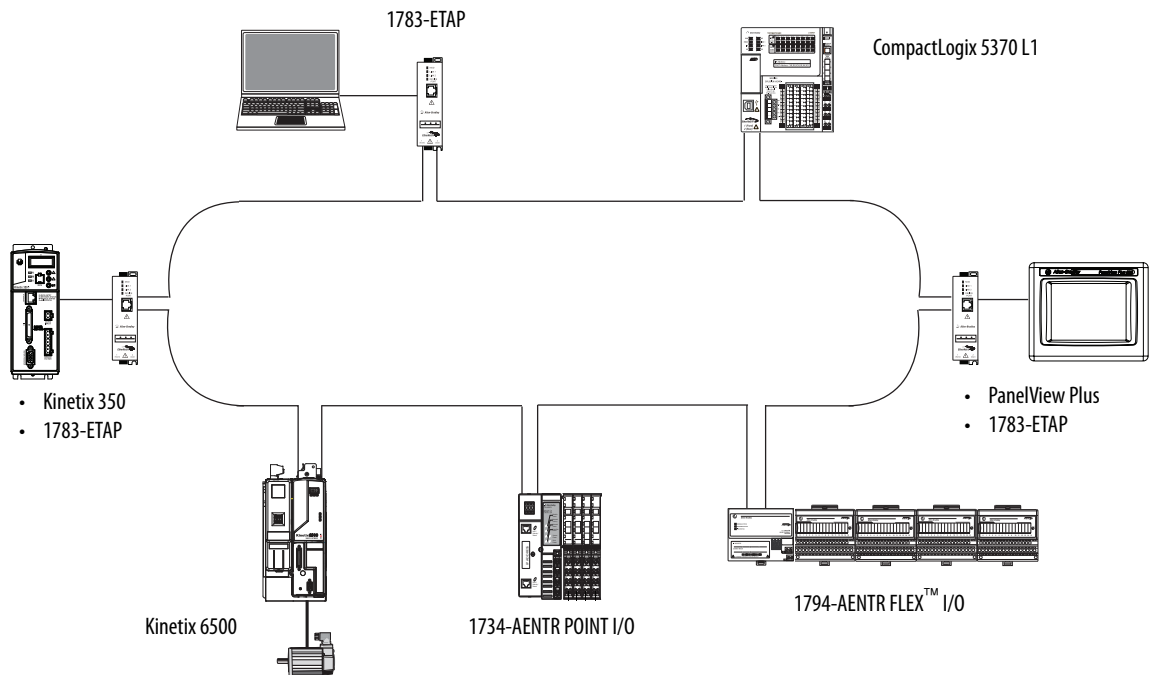

Follow These Steps

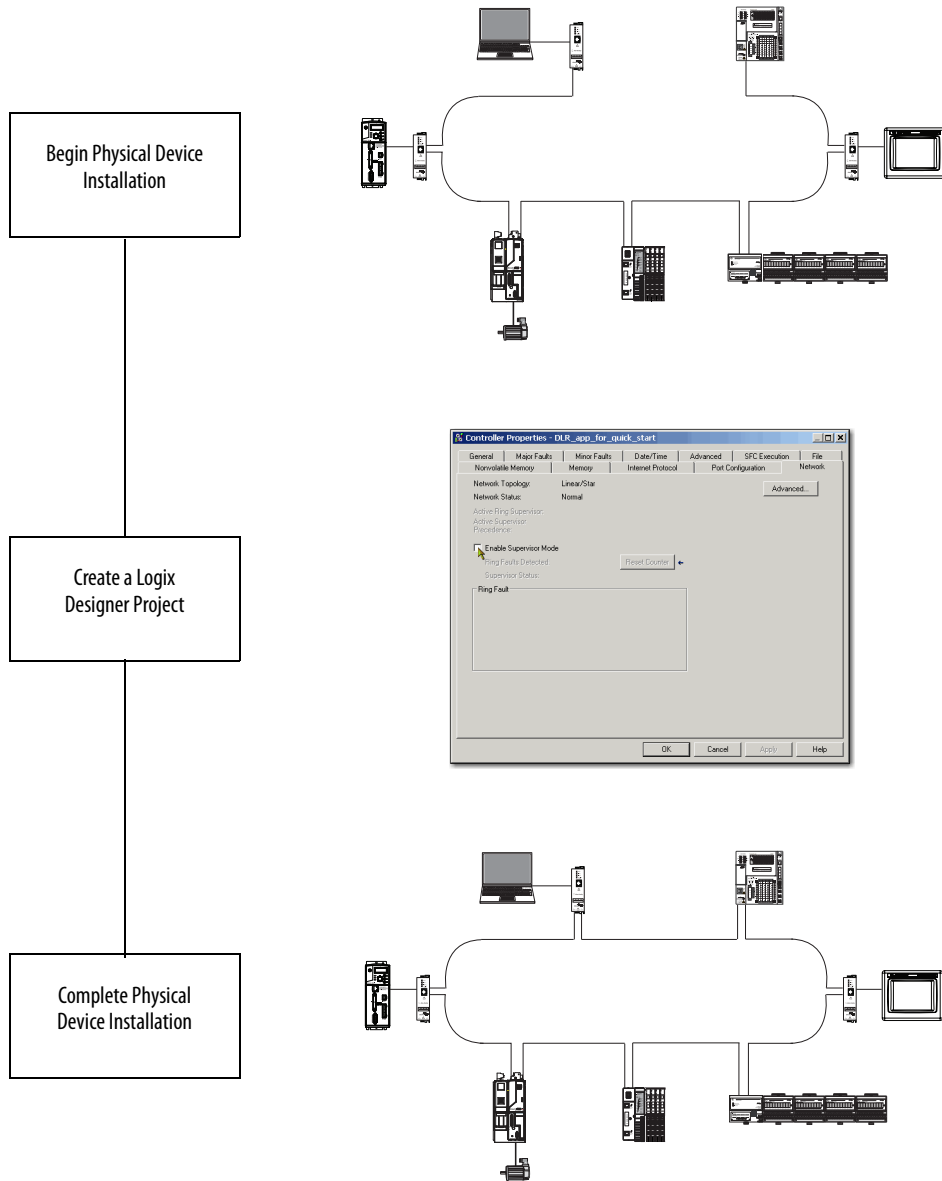

For a complete description of the tasks that are required, such as configuring at least one device on the network to be the Active Supervisor, to use a CompactLogix 5370 L1 controller in a DLR application, see the EtherNet/IP Embedded Switch Technology Application Guide, publication [ENET-AP005](#).

Integrated Motion on the EtherNet/IP Network

Integrated Motion on the EtherNet/IP network is an integrated motion solution on a standard, unmodified EtherNet/IP network that delivers high performance with lower costs and simpler design or configuration when compared to traditional, multi-network motion applications.

The 1769-L18ERM-BB1B controller supports Integrated Motion on the EtherNet/IP network.

Follow These Steps

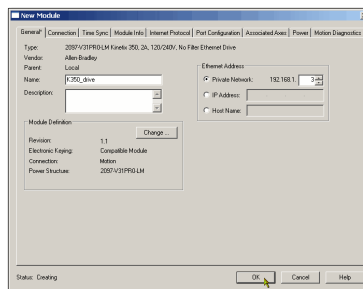
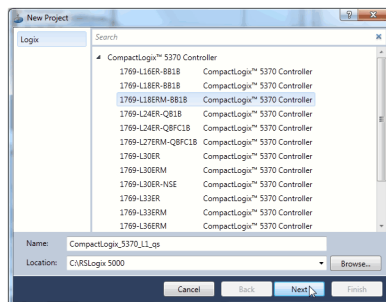
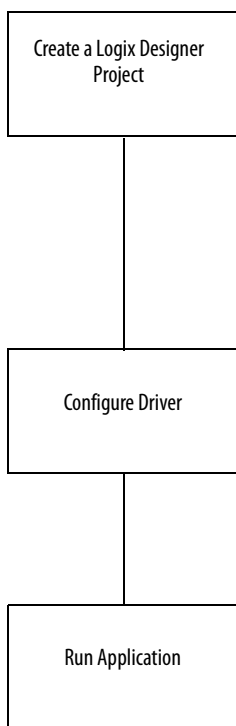

For a complete description of the tasks that are required to use Integrated Motion on the EtherNet/IP network with a CompactLogix 5370 L1 controller, see the CIP Motion Configuration and Startup User Manual, publication [MOTION-UM003](#)

C**CompactLogix 5370 L1 controllers**

available 10
 devices to integrate 11
 features 10

ControlFLASH software 12, 29

install 33

controller firmware

load 38

D**devices**

Kinetix 350 drives 11
 PanelView Plus terminals 11
 POINT I/O modules 11
 PowerFlex 40 drives 11
 PowerFlex 70 drives 11
 to integrate in controller application 11

DLR network topology 61, 62**E****EtherNet/IP network**

configure 43
 connection 27
 network topologies 10, 62

F**features**

common to all controllers 10

firmware

load on controller 38

H**hardware** 10, 13, 15

connections to other devices 4
 optional system devices 11

I**I/O support** 54**Integrated Motion on the EtherNet/IP**

network 61, 64

internal energy storage solution 10**K****Kinetix 350 drives** 11**L****Logix Designer application** 12, 29, 44, 47**M****motion support**

Integrated Motion on the EtherNet/IP
 network 61, 64

N**networks**

configure an EtherNet/IP network 43
 connect to an EtherNet/IP network 27
 USB connection 26

nonvolatile memory

SD card 10

P**panel layout**

sample 5

PanelView Plus terminals 11**POINT I/O modules** 11**power supplies**

wire 23

PowerFlex 40 drives 11**PowerFlex 70 drives** 11**R****required parts** 13**RSLinx Classic software** 12, 29, 44**S****SD card** 10

installation 18

software

ControlFLASH 12
 install ControlFLASH 33
 install the Studio 5000 environment 31
 Logix Designer 12, 29, 44, 47
 required 12
 RSLinx Classic 12, 29, 44

Studio 5000 environment

install 31

U**USB connection** 26

Rockwell Automation Support

Rockwell Automation provides technical information on the Web to assist you in using its products.

At <http://www.rockwellautomation.com/support>, you can find technical manuals, technical and application notes, sample code and links to software service packs, and a MySupport feature that you can customize to make the best use of these tools. You can also visit our Knowledgebase at <http://www.rockwellautomation.com/knowledgebase> for FAQs, technical information, support chat and forums, software updates, and to sign up for product notification updates.

In addition, we offer multiple support programs for installation, configuration, and troubleshooting. For more information, contact your local distributor or Rockwell Automation representative, or visit <http://www.rockwellautomation.com/support/>.

Installation Assistance

If you experience a problem within the first 24 hours of installation, review the information that is contained in this manual. You can contact Customer Support for initial help in getting your product up and running.

United States or Canada	1.440.646.3434
Outside United States or Canada	Use the Worldwide Locator at http://www.rockwellautomation.com/support/americas/phone_en.html , or contact your local Rockwell Automation representative.

New Product Satisfaction Return

Rockwell Automation tests all of its products to ensure that they are fully operational when shipped from the manufacturing facility. However, if your product is not functioning and needs to be returned, follow these procedures.

United States	Contact your distributor. You must provide a Customer Support case number (call the phone number above to obtain one) to your distributor to complete the return process.
Outside United States	Please contact your local Rockwell Automation representative for the return procedure.

Documentation Feedback

Your comments will help us serve your documentation needs better. If you have any suggestions on how to improve this document, complete this form, publication [RA-DU002](#), available at <http://www.rockwellautomation.com/literature/>.

Rockwell Otomasyon Ticaret A.Ş., Kar Plaza İş Merkezi E Blok Kat:6 34752 İçerenköy, İstanbul, Tel: +90 (216) 5698400

www.rockwellautomation.com

Power, Control and Information Solutions Headquarters

Americas: Rockwell Automation, 1201 South Second Street, Milwaukee, WI 53204-2496 USA, Tel: (1) 414.382.2000, Fax: (1) 414.382.4444
Europe/Middle East/Africa: Rockwell Automation NV, Pegasus Park, De Kleetlaan 12a, 1831 Diegem, Belgium, Tel: (32) 2 663 0600, Fax: (32) 2 663 0640
Asia Pacific: Rockwell Automation, Level 14, Core F, Cyberport 3, 100 Cyberport Road, Hong Kong, Tel: (852) 2887 4788, Fax: (852) 2508 1846

Publication IASIMP-QS024C-EN-P - August 2014

Supersedes Publication IASIMP-QS024B-EN-P - December 2012

Copyright © 2014 Rockwell Automation, Inc. All rights reserved. Printed in the U.S.A.