

Compact 5000 I/O and FLEX 5000 EtherNet/IP Communication Modules in Logix 5000 Control Systems

Compact 5000 I/O Catalog Numbers 5069-AENTR, 5069-AEN2TR

FLEX 5000 Catalog Numbers 5094-AENTR, 5094-AENTRXT, 5094-AEN2TR, 5094-AEN2TRXT



Important User Information

Read this document and the documents listed in the additional resources section about installation, configuration, and operation of this equipment before you install, configure, operate, or maintain this product. Users are required to familiarize themselves with installation and wiring instructions in addition to requirements of all applicable codes, laws, and standards.

Activities including installation, adjustments, putting into service, use, assembly, disassembly, and maintenance are required to be carried out by suitably trained personnel in accordance with applicable code of practice.

If this equipment is used in a manner not specified by the manufacturer, the protection provided by the equipment may be impaired.

In no event will Rockwell Automation, Inc. be responsible or liable for indirect or consequential damages resulting from the use or application of this equipment.

The examples and diagrams in this manual are included solely for illustrative purposes. Because of the many variables and requirements associated with any particular installation, Rockwell Automation, Inc. cannot assume responsibility or liability for actual use based on the examples and diagrams.

No patent liability is assumed by Rockwell Automation, Inc. with respect to use of information, circuits, equipment, or software described in this manual.

Reproduction of the contents of this manual, in whole or in part, without written permission of Rockwell Automation, Inc., is prohibited

Throughout this manual, when necessary, we use notes to make you aware of safety considerations.



WARNING: Identifies information about practices or circumstances that can cause an explosion in a hazardous environment, which may lead to personal injury or death, property damage, or economic loss.



ATTENTION: Identifies information about practices or circumstances that can lead to personal injury or death, property damage, or economic loss. Attentions help you identify a hazard, avoid a hazard, and recognize the consequence.

IMPORTANT Identifies information that is critical for successful application and understanding of the product.

Labels may also be on or inside the equipment to provide specific precautions.



SHOCK HAZARD: Labels may be on or inside the equipment, for example, a drive or motor, to alert people that dangerous voltage may be present.



BURN HAZARD: Labels may be on or inside the equipment, for example, a drive or motor, to alert people that surfaces may reach dangerous temperatures.



ARC FLASH HAZARD: Labels may be on or inside the equipment, for example, a motor control center, to alert people to potential Arc Flash. Arc Flash will cause severe injury or death. Wear proper Personal Protective Equipment (PPE). Follow ALL Regulatory requirements for safe work practices and for Personal Protective Equipment (PPE).

Table of Contents	Important User Information 2
	Preface 5
	Summary of Changes 5
	Additional Resources 6
	 Chapter 1
EtherNet/IP Communication Module Overview	EtherNet/IP Communication Module Functionality. 10
	Compact 5000 I/O and FLEX 5000 EtherNet/IP Adapter Functionalities 12
	Secure Digital Card 14
	Power I/O Modules and Field-side Devices 16
	Protected Mode 24
	Enter and Exit Protected Mode 25
	Restrictions Imposed By Protected Mode 25
	Perform Tasks When Not Restricted. 25
	 Chapter 2
Configure Communication Drivers in RSLinx Classic Software	Configure the Ethernet Communication Driver in RSLinx Classic Software 29
	Configure the Ethernet Devices Drivers in RSLinx Classic Software 31
	Configure the USB Communication Driver in RSLinx Classic Software 33
	 Chapter 3
Start to Use the Adapter	Determine Network Parameters 38
	Set the IP Address on the Adapter 40
	Out-Of-Box State 40
	Set the IP Address with the Rotary Switches 42
	Set the IP Address with the BOOTP DHCP EtherNet/IP Commissioning Tool 43
	Disable BOOTP/DHCP with RSLinx Classic Software 46
	Set the IP Address with a DHCP Server 47
	Set the IP Address with RSLinx Classic Software 48
	Duplicate IP Address Detection 51
	Duplicate IP Address Resolution 51
	DNS Addressing 52
	Configure Port Settings with RSLinx Classic Software. 53
	 Chapter 4
Configure the Adapter	Add the Module to a Project 57
	Time Synchronization 70

	Chapter 5	
Use the Module on a Device Level	Chapter 6	
Ring Network		
Module Diagnostics		
	Diagnostics with the Logix Designer Application	75
	Connection Category	76
	Module Info Category	78
	Port Configuration Category	82
	Time Sync Category	84
	Diagnostics with RSLinx Classic Software	86
	General Tab.	86
	Port Diagnostics Tab	87
	Connection Manager Tab	89
	USB Tab.	90
	EtherNet/IP Adapter Diagnostic Web Pages	91
	Access Web Browser Support	92
	Diagnostic Overview Page	93
	Network Settings	94
	Ethernet Statistics	95
	Ring Statistics	97
	Reset the Adapter	98
	Reset the 5069-AENTR or a FLEX 5000 EtherNet/IP Adapter	98
	Reset the 5069-AEN2TR EtherNet/IP Adapter	99
	 Appendix A	
EtherNet/IP Communication	5069-AENTR Adapter Status Indicators	101
Module Status Indicators	5069-AEN2TR Adapter Status Indicators	104
	FLEX 5000 EtherNet/IP Adapter Status Indicators	107
	 Index	109

This manual describes how to use Compact 5000™ I/O and FLEX 5000™ EtherNet/IP communication modules in Logix 5000™ control systems.

Make sure that you are familiar with the following:

- Use of a controller in a Logix 5000 control system, including the following controllers:
 - CompactLogix™ 5380 controllers
 - Compact GuardLogix® 5380 controllers
 - ControlLogix® 5580 controllers
 - GuardLogix 5580 controllers
- Use of an EtherNet/IP network
- Use of various software applications from Rockwell Automation

IMPORTANT Throughout this document, 'FLEX 5000 EtherNet/IP adapters' refers to all 5094 adapter catalogs, collectively, and 'FLEX 5000 EtherNet/IP adapter' refers to any single 5094 catalog listed below:

- 5094-AENTR adapter
 - 5094-AENTRXT adapter
 - 5094-AEN2TR adapter
 - 5094-AEN2TRXT adapter
-

IMPORTANT Information in this user manual applies to all FLEX 5000 EtherNet/IP adapters and Compact 5000 I/O EtherNet/IP adapters unless specified.

Summary of Changes

This manual was changed to add information about FLEX 5000 EtherNet/IP adapters.

Additional Resources

These documents contain more information concerning related products from Rockwell Automation.

Table 1 - Additional Resources

Resource	Description
Compact 5000 I/O Modules Specifications Technical Data, publication 5069-TD001	Provides Compact 5000™ I/O module and Compact 5000 I/O EtherNet/IP adapter specifications.
Compact 5000 I/O EtherNet/IP Adapter Installation Instructions, publication 5069-IN003	Describes how to install a Compact 5000 I/O EtherNet/IP adapter.
FLEX 5000 Modules Specifications Technical Data, publication 5094-TD001	Provides FLEX 5000 modules and EtherNet/IP adapters specifications.
FLEX 5000 EtherNet/IP Adapters with RJ45 Ports Installation Instructions, publication 5094-IN001	Describes how to install a FLEX 5000 EtherNet/IP adapter with RJ45 ports.
EtherNet/IP Media Planning and Installation Manual	Describes how to use the required media components and how to plan for, install, verify, troubleshoot, and certify your EtherNet/IP network. This manual is available from the Open DeviceNet Vendor Association (ODVA) at: http://www.odva.org .
Ethernet Design Considerations Reference Manual, publication ENET-RM002	Describes the following Ethernet concepts: <ul style="list-style-type: none"> • Overview • Network layout and components • Network infrastructure devices • Network infrastructure features • Protocol
EtherNet/IP Socket Interface Application Technique, publication ENET-AT002	Describes the socket interface that you can use to program MSG instructions to communicate between a Logix5000™ controller and Ethernet devices. In this case, the interface is used because the Ethernet devices that do not support the EtherNet/IP application protocol. Such devices include bar code scanners, RFID readers, or other standard Ethernet devices.
EtherNet/IP Embedded Switch Technology Application Guide, publication ENET-AP005	Describes how to install, configure, and maintain linear and Device Level Ring (DLR) networks by using Rockwell Automation® EtherNet/IP devices that are equipped with embedded switch technology.
Compact 5000 I/O Digital and Safety Modules User Manual, publication 5000-UM004	Provides information on how to install, configure, and operate 5000 Series digital I/O modules.
5000 Series Analog I/O Module User Manual, publication 5000-UM005	Provides information on how to install, configure, and operate 5000 Series analog I/O modules.
5000 Series High-speed Counter Module User Manual, publication 5000-UM006	Provides information on how to install, configure, and operate 5000 Series high-speed counter modules.
FLEX 5000 Digital I/O Modules User Manual, publication 5094-UM001	Provides information on how to install, configure, and operate FLEX 5000 digital I/O modules.
FLEX 5000 Analog I/O Modules User Manual, publication 5094-UM002	Provides information on how to install, configure, and operate FLEX 5000 analog I/O modules.
FLEX 5000 High-speed Counter I/O Modules User Manual, publication 5094-UM003	Provides information on how to install, configure, and operate FLEX 5000 high-speed counter modules.
Integrated Architecture and CIP Sync Configuration Application Technique, publication IA-AT003	Provides information on CIP Sync and the IEEE 1588-2008 Precision Time Protocol.
Integrated Motion on the EtherNet/IP Network Reference Manual, publication MOTION-RM003	Reference descriptions of the AXIS_CIP_DRIVE attributes and the Studio 5000 Logix Designer® application Control Modes and Methods

Table 1 - Additional Resources

Resource	Description
Electronic Keying in Logix5000 Control Systems Application Technique, publication LOGIX-AT001	Describes how to use electronic keying in Logix5000 control system applications.
Network Technology web page, http://www.rockwellautomation.com/rockwellautomation/products-technologies/network-technology/overview.page?	Provides information on reference architectures and white papers on networking.
Industrial Automation Wiring and Grounding Guidelines, publication 1770-4.1	Provides general guidelines for installing a Rockwell Automation® industrial system.
Product Certifications website, http://www.rockwellautomation.com/rockwellautomation/certification/overview.page	Provides declarations of conformity, certificates, and other certification details.

You can view or download publications at <http://www.rockwellautomation.com/literature/>. To order paper copies of technical documentation, contact your local Allen-Bradley distributor or Rockwell Automation sales representative.

■ **Notes:**

EtherNet/IP Communication Module Overview

Topic	Page
EtherNet/IP Communication Module Functionality	10
Compact 5000 I/O and FLEX 5000 EtherNet/IP Adapter Functionalities	12
Protected Mode	24

EtherNet/IP networks offer a comprehensive suite of messages and services for many automation applications.

These application examples use EtherNet/IP networks:

- Real-time Control
- Time Synchronization
- Motion

This open network standard uses standard Ethernet communication products to support real-time I/O messaging, information exchange, and general messaging.

EtherNet/IP networks also support CIP Safety. Such support makes the simultaneous transmission of safety and standard control data and diagnostics information over a common network possible.

EtherNet/IP Communication Module Functionality

EtherNet/IP communication modules can provide the following functionality:

- Support for messaging, produced/consumed tags, and distributed I/O
- Encapsulate messages within standard TCP/UDP/IP protocol
- Share a common application layer with ControlNet and DeviceNet network protocols
- Interface via RJ45, category 5, unshielded, twisted-pair cable connectors
- Support for the following EtherNet/IP network communication rates:
 - 10 Mbps
 - 100 Mbps
 - 1 Gbps

IMPORTANT

- When the adapter uses the 1 Gbps network communication rate, it supports only full-duplex mode.
- When the adapter uses the 10 Mbps or 100 Mbps network communication rate, it supports full-duplex and half-duplex mode.

- No network scheduling or routing table requirements
- Communicate with Logix 5000™ controllers to function as a remote gateway for I/O modules
- Support for the following EtherNet/IP network topologies:
 - Device Level Ring (DLR)
 - Linear
 - Star
- Option to operate as a Ring supervisor on a Device Level Ring (DLR) network

Figure 1 shows how Rockwell Automation® EtherNet/IP communication modules fit into a control system. In this example, the following can occur over the EtherNet/IP network:

- Controllers produce and consume tags
- Controllers initiate MSG instructions that send and receive data and configure devices
- Control of I/O modules
- Use of Integrated Motion over an EtherNet/IP network
- Workstations upload or download projects to the controllers

Figure 1 - EtherNet/IP Communication Modules in a Control System

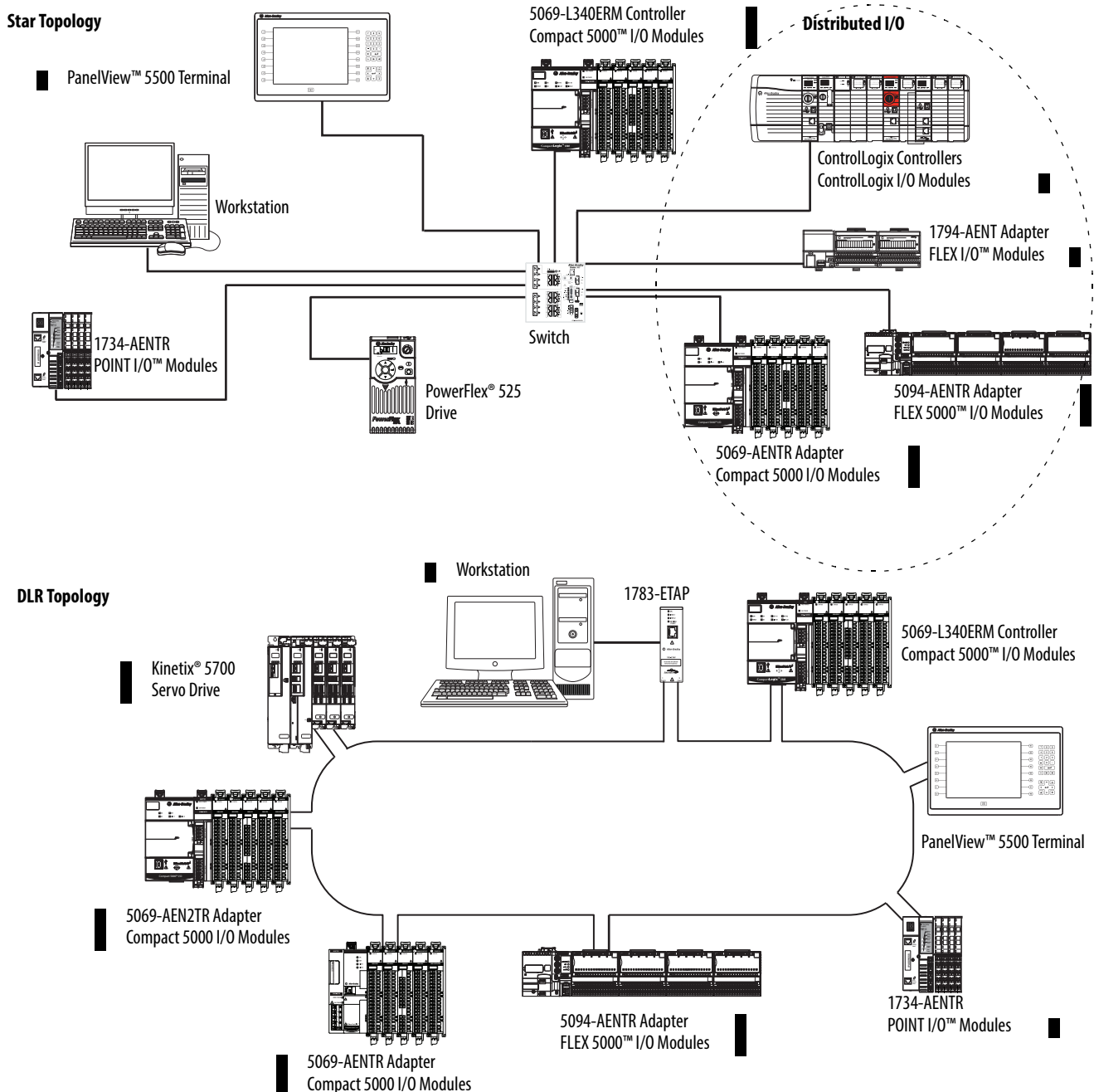

Compact 5000 I/O and FLEX 5000 EtherNet/IP Adapter Functionalities

A Compact 5000™ I/O or FLEX 5000™ EtherNet/IP adapter performs the following functions:

- Facilitates high-speed data transfer between some Logix 5000™ controllers and remote I/O modules.
- Provides power to the I/O modules, as follows:
 - Compact 5000 I/O EtherNet/IP adapters provide system-side power and field-side power to Compact 5000 I/O system.
 - FLEX 5000 EtherNet/IP adapters provide system-side power to FLEX 5000 I/O modules.

For more information, see [page 16](#).

- Connects to multiple EtherNet/IP network topologies, as shown in the graphics that begin on [page 11](#).
- Supports multiple I/O modules, as follows:
 - 5069-AENTR and 5069-AEN2TR adapters support as many as 31 Compact 5000 I/O modules.
 - 5094-AENTR and 5094-AEN2TRXT adapters support as many as 8 FLEX 5000 I/O modules.
 - 5094-AEN2TR and 5094-AEN2TRXT adapters support as many as 16 FLEX 5000 I/O modules.

Figure 2 - Compact 5000 I/O Modules

5069-AENTR Adapter with
5069 Compact I/O Modules

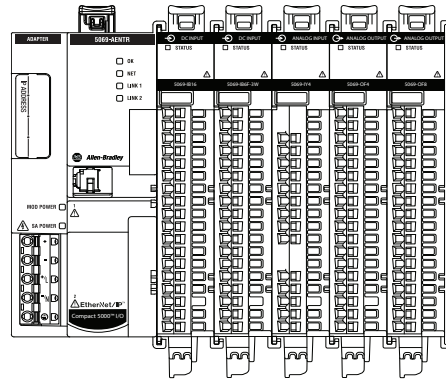

5069-AEN2TR Adapter with
5069 Compact I/O Modules

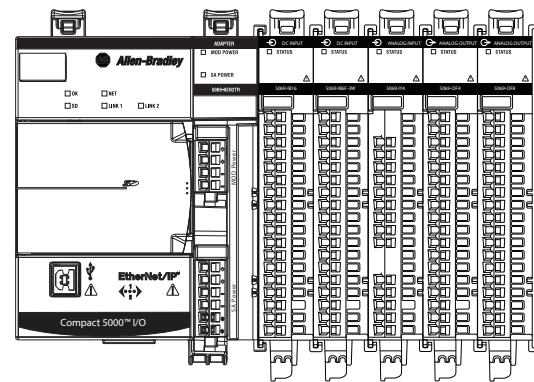
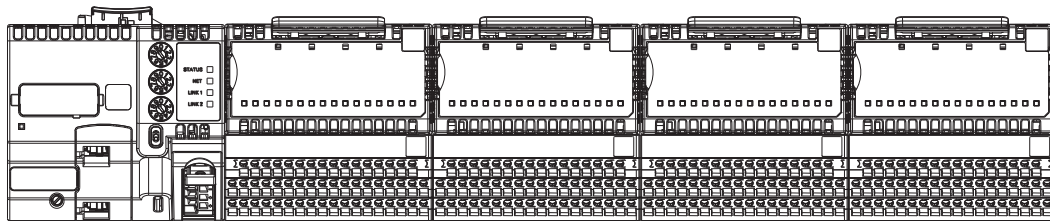

Figure 3 - FLEX 5000 Modules

FLEX 5000 EtherNet/IP Adapter
with FLEX 5000 I/O Modules



Secure Digital Card

The 5069-AEN2TR EtherNet/IP adapter supports the use of a Secure Digital (SD) card to store all configuration data that is stored in nonvolatile memory, for example, the IP address or network communication rate for each port.

IMPORTANT The 5069-AEN2TR adapter and FLEX 5000 EtherNet/IP adapters do not support the use of an SD card.

The adapter supports the use of a 1784-SD1 (1 GB) and 1784-SD2 (2 GB) card. You can use third-party SD cards with the controller. You can use SD cards with as much as 32 GB of memory. Keep in mind, Rockwell Automation **does not test the use of third-party SD cards** with the controller.

If you use an SD card other than those cards that are available from Rockwell Automation, unexpected results can occur. For example, you can experience data corruption or data loss.

SD cards that are not provided by Rockwell Automation can have different industrial, environmental, and certification ratings as those cards that are available from Rockwell Automation. These cards can have difficulty with survival in the same industrial environments as the industrially rated versions available from Rockwell Automation.

An SD card slot is on the front of the adapter.

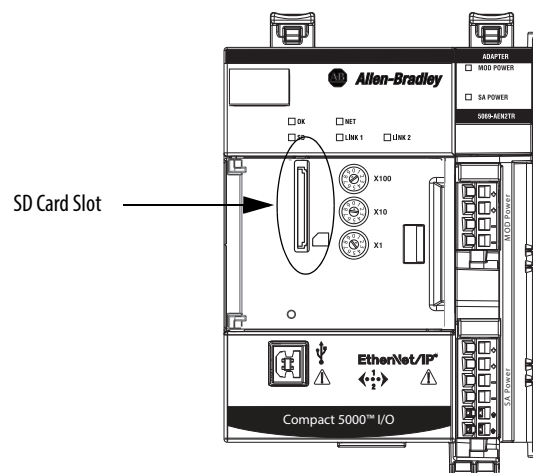

Adapter and SD Card Interaction

The 5069-AEN2TR adapter interacts with the SD card at power-up and when the card is installed while the adapter is running.

IMPORTANT No user action is required for the interaction between the adapter and the SD card to occur.

Whenever configuration is written to the adapter, either at initial configuration or when changes occur, it is written to the internal memory in the adapter and the SD card.

The following apply with respect to the adapter and SD card interacting:

Conditions	Action That Occurs
<ul style="list-style-type: none"> The adapter powers-up. The installed SD card does not contain adapter configuration data. 	The adapter configuration is copied from the internal memory to the SD card.
<ul style="list-style-type: none"> The adapter powers-up. The installed SD card contains configuration data that differs from what is stored on the internal memory. 	<p>The configuration data on the SD card is copied to the internal memory and overwrites what was previously there.</p> <p>If the configuration data on the SD card includes an IP address that differs from the what is on the adapter, the overwrite changes the adapter IP address to match what is on the SD card.</p>
<ul style="list-style-type: none"> The adapter is running. You insert an SD card that contains configuration data that differs from what is stored on the internal memory. 	<p>There is no change to the configuration data in either the internal memory or the SD card.</p> <p>A fault occurs and is indicated by the following:</p> <ul style="list-style-type: none"> The message <i>SD Data Mismatch</i> scrolls across the adapter 4-character display. The S.MemoryCardDataMismatch tag changes to 1. <p>We recommend that you keep the data on the internal memory and SD card the same.</p> <p>In this case, you can take one of the following actions to clear the fault and make sure the configuration in the internal memory matches that on the SD card:</p> <ul style="list-style-type: none"> If you want to use the configuration that is on the SD card, cycle power. After power-up, the configuration data on the SD card is copied to the internal memory. If you want to use the configuration that is in the internal memory, change something in the adapter configuration. The configuration data is updated in the internal memory and then copied to the SD card. Then change the configuration on the adapter back to its previous settings. The configuration data is updated in the internal memory and then copied to the SD card.
<ul style="list-style-type: none"> The adapter is running. The adapter configuration changes. 	The updated configuration data is copied from the internal memory to the SD card.
The adapter firmware revision is updated.	<p>The adapter configuration data on the SD card is deleted before the update begins.</p> <p>After the firmware revision is updated, the adapter configuration is copied from the internal memory to the SD card.</p>

Power I/O Modules and Field-side Devices

The adapters provide power to I/O modules as follows:

- Compact 5000 I/O and FLEX 5000 EtherNet/IP adapters provide system-side power that powers the I/O modules and lets them transfer data and execute logic.

System-side power is provided through the Module (MOD) Power connector and is passed to each module as it is added to the system.

System-side power is also known as MOD power.

- Compact 5000 I/O EtherNet/IP adapters also provide field-side power that powers some Compact 5000 I/O modules and field-side devices that are connected to them.

Field-side power is provided through the Sensor/Actuator (SA) Power connector and is passed to each module as it is added to the system.

Field-side power is also known as SA power.

Power begins at the EtherNet/IP adapter and passes across the I/O module internal circuitry via power buses. The MOD power bus and SA power bus are isolated from each other.

IMPORTANT For Compact 5000 I/O EtherNet/IP adapter and I/O modules, we recommend that you use a separate external power supply for the MOD power and SA power, respectively.

If you use one external power supply and power is lost from that supply, the system loses both MOD power and SA power. That is, system-side and field side power, respectively, is lost.

If you use separate external power supplies, the loss of power from one external power supply does not affect the availability of power from the other supply. For example, if separate external power supplies are used and SA power is lost, MOD power remains available for the Compact 5000 I/O EtherNet/IP adapter and Compact 5000 I/O modules.

IMPORTANT We recommend the following power supplies for FLEX 5000 EtherNet/IP adapters:

- 1606-XLP72E power supply for 5094-AENTR and 5094-AENTRXT adapters
- 1606-XLE80E power supply for 5094-AEN2TR and 5094-AEN2TRXT adapters

For more information, refer to Switched Mode Power Supplies Technical Data, publication [1606-TD002](#).

Power Connectors for Each Adapter

You connect external power supplies to removable terminal blocks (RTBs) to provide MOD power and SA power. The adapters use different RTBs to connect power.

The 5069-AENTR adapter uses a 5-terminal Power RTB to connect MOD power and SA power. Both power types are provided to the system via one RTB.

Figure 4 - 5069-AENTR EtherNet/IP Adapter Power Connector

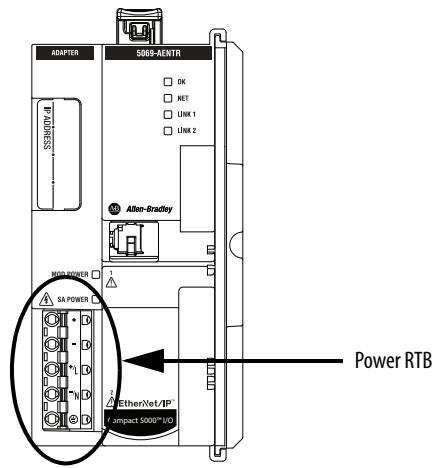

The 5069-AEN2TR adapter uses two RTBs to connect MOD power and SA power. You connect an external power supply to the MOD power RTB to provide MOD power. You connect an external power supply to the SA power RTB to provide SA power.

Figure 5 - 5069-AEN2TR EtherNet/IP Adapter Power Connectors

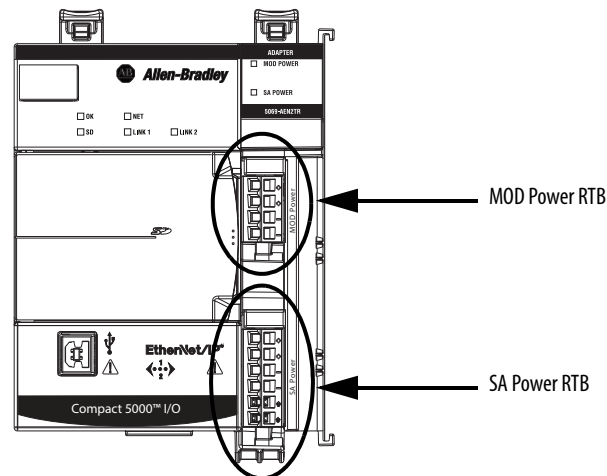

For more information on how to connect MOD power and SA power, see the Compact 5000 I/O EtherNet/IP Adapter Installation Instructions, publication [5069-IN003](#).

FLEX 5000 EtherNet/IP adapters use one 4-terminal Power RTB.

Figure 6 - FLEX 5000 EtherNet/IP Adapter Power Connection

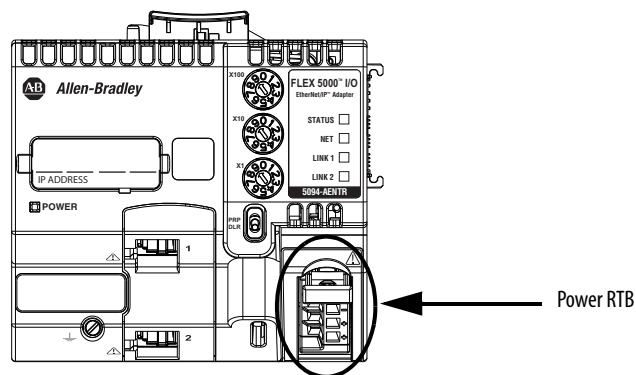

For more information on how to connect MOD power, see the FLEX 5000 EtherNet/IP Adapters with RJ45 Ports Installation Instructions, publication [5094-IN001](#).

MOD Power Bus

MOD power is a DC power source that is required to operate the adapter and the I/O modules installed with it. Remember the following:

- The adapter and the I/O modules that are installed with it use only one MOD power bus.
- Every module draws current from the MOD power bus and passes the remaining current to the next module.
- You must limit the MOD power source to 10 A, max, at 18...32V DC.
- We recommend that you use an external power supply that is adequately sized for the total MOD power bus current drawn by the adapter and I/O modules.

For example, if the total MOD power current draw is 5 A, you can use a MOD power supply that is limited to 5 A.

You must consider **current inrush requirements** when you calculate the total MOD power bus current draw in the system.

When the MOD power source is turned on, that is, I/O modules receive system-side power, the following occurs.

1. The adapter draws current from the MOD power bus current and passes the remaining current through to the next module.
2. The next module draws MOD power bus current and passes the remaining current through to the next module.

3. The process continues until MOD power bus current needs are met for all modules.

For more information on the current that the modules draw from the MOD power bus, see the following publications:

- Compact 5000 I/O Modules Specifications Technical Data, publication [5069-TD001](#).
- FLEX 5000 I/O Modules Specifications Technical Data, publication [5094-TD001](#).

Compact 5000 I/O System SA Power Bus

SA power provides power to devices that are connected to some Compact 5000 I/O modules. Remember the following:

- Some Compact 5000 I/O modules draw current from the SA power bus and pass the remaining current to the next module.
- Some Compact 5000 I/O modules only pass current along the SA power bus to the next module.
- A Compact 5000 I/O EtherNet/IP adapter and the I/O modules installed with it can have multiple SA power buses. You use a 5069-FPD field potential distributor to establish a new SA power bus. The new SA power bus is isolated from the SA power bus to its left in the system.

For more information on 5069-FPD field potential distributors, see [page 22](#).

- If AC and DC modules that require SA power are installed with a Compact 5000 I/O EtherNet/IP adapter, you must use a 5069-FPD field potential distributor to establish a new SA power bus.

You install one set of the same module types, for example, DC modules, to the first SA power bus. Then you install the other set, for example, AC modules to the second SA power bus. That is, the SA power bus to the right of the 5069-FPD field potential distributor.

The SA power source limitations described previously apply to each isolated SA power bus separately.

- You must limit the SA power source to one of the following:
 - If you use **DC voltage**, you must limit the SA power source to **10 A, max at 18...32V DC**.
 - If you use **AC voltage**, you must limit the SA power source to **10 A, max at 18...240V AC**.

- We recommend that you use an external power supply that is adequately sized for the total SA power bus current draw.

For example, if the total SA power current draw is 4 A, you can use an SA power supply that is limited to 4 A.

You must consider **current inrush requirements** when you calculate the total SA power bus current draw.

- Connections to an SA power bus use a **shared common**. All inputs that draw current from an SA power bus to power field-side devices have a return through circuitry to the SA - terminal on the SA power connector.

IMPORTANT Each SA power bus has a shared common unique to that bus because SA power buses are isolated from each other. That is, the SA power bus that the adapter establishes has a shared common. If you use a 5069-FPD field potential distributor to establish a new SA power bus in the system, the second bus has its own shared common for modules that draw current from it.

When the SA power source is turned on, that is, the adapter and I/O modules receive field-side power, the following occurs.

1. The Compact 5000 I/O EtherNet/IP adapter draws current from the SA power bus current and passes the remaining current through to the next module.
2. The next module completes one of the following tasks.
 - If the module uses SA power to power a field-side device, the module draws current from the SA power bus and passes the remaining current through to the next module.
 - If the module does not use SA power bus current, the module passes the remaining current through to the next module.
3. The process continues until all SA power bus current needs are met for the modules on the SA power bus.

For more information on the current that the 5069 Compact I/O modules draw from the SA power bus, see the 5069 Compact I/O Modules Specifications Technical Data, publication [5069-TD001](#).

Track SA Power Bus Current Draw

We recommend that you track the SA power bus current draw, max, per module, and collectively for the adapter and I/O modules installed with it.

Consider the following with this example:

- The values in this example represent a worst-case calculation. That is, all modules that draw SA power bus current, draw the maximum available on the module.
- Not all modules that are shown in [Figure 7](#) use SA power bus current. For example, the 5069-ARM and 5069-OW4I modules only pass SA power bus current to the next module. Some other Compact 5000 I/O modules do not use SA power bus current, but are not shown in the graphic, for example, the 5069-OB16 module.
- System SA power bus current, max, is calculated as each module draws SA power bus current.

In the example in [Figure 7](#), after the 5069-IB16 module in slot 1 draws SA power bus current, the system SA power bus current, max, is 138 mA. After the 5069-IB16 module in slot 2 draws SA power bus current, the system SA power bus current draw is 266 mA.

This process continues until the system SA power bus current, max, is 1.222 A.

Figure 7 - Compact 5000 I/O EtherNet/IP Adapter and I/O Modules - Calculate SA Power Bus Current Draw

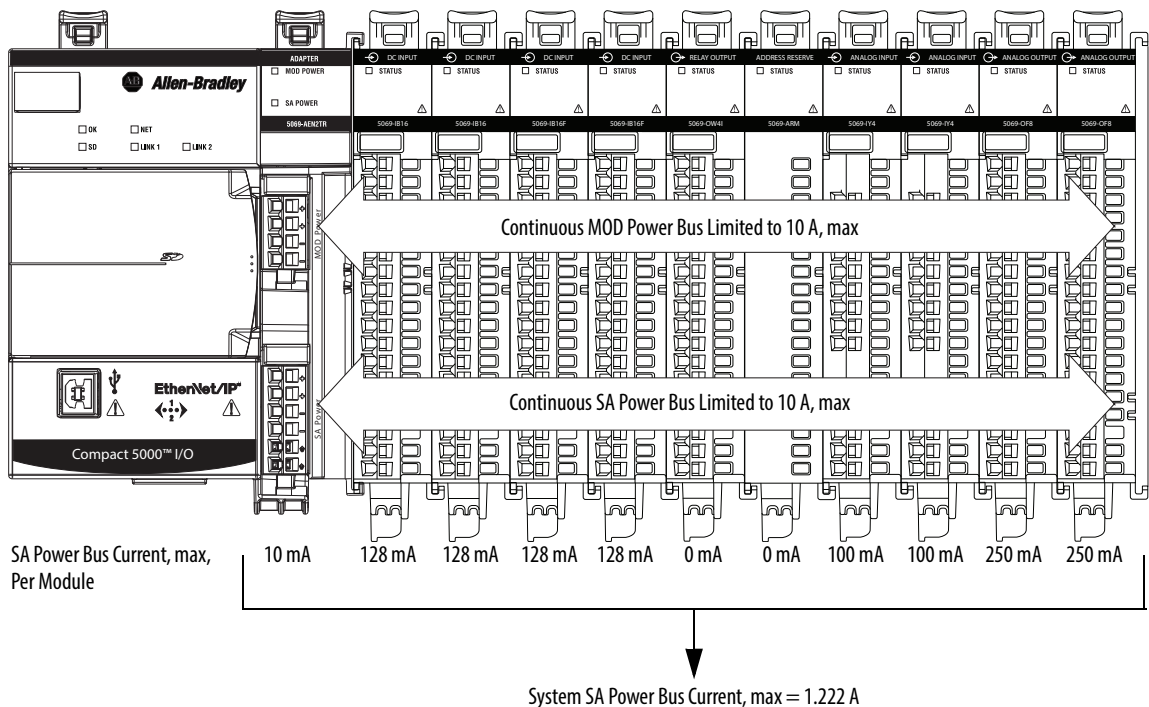

5069-FPD Field Potential Distributor Creates Additional SA Power Buses

The 5069-FPD Field Potential Distributor lets you change the field-side power distribution source for Compact 5000 I/O modules to the right of the field power distributor. The field potential distributor passes MOD power bus signals through to the next module in the system.

You can use a 5069-FPD field potential distributor to add an SA power bus to a 5069 Compact I/O system. The field potential distributor blocks the current that passes across the SA power bus to the left of the field potential distributor. It then establishes a new SA power bus for modules to the right.

The SA power bus that a field potential distributor establishes functions in the same way as the SA power bus that a 5069 Compact I/O EtherNet/IP adapter establishes, as described on [page 19](#).

Examples of system configurations that use multiple SA power buses include:

- The modules in the system collectively draw more than 10 A of SA power. That is, the maximum current that one SA power bus can provide.
- The modules in the system must be isolated according to module types, such as digital I/O and analog I/O modules.
- The modules in the system are isolated according to the type of field-side device to which they are connected. For example, you can separate modules that are connected to field-side devices that require DC voltage for SA power from modules that are connected to field-side devices that require AC voltage for SA power.

Figure 8 - 5069-FPD Field Potential Distributor

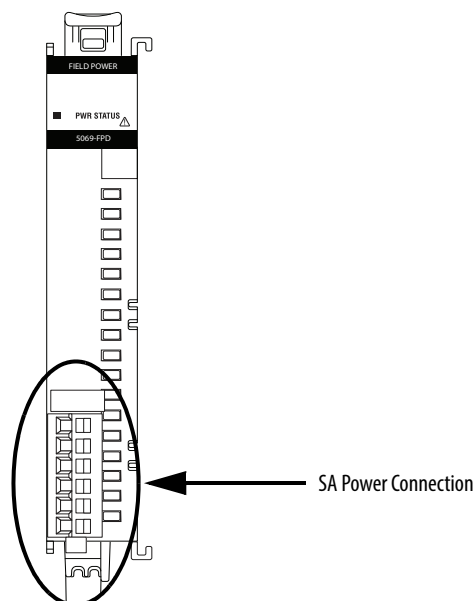

Create a New SA Power Bus

Figure 9 show examples when a 5069-FPD field potential distributor to create a second SA power bus.

Figure 9 - Compact 5000 I/O EtherNet/IP Adapter and I/O Modules - Create a New SA Power Bus

In this example, a 5069-FPD field potential distributor is used to create a new SA power bus so the digital I/O modules are separated from the analog I/O modules.

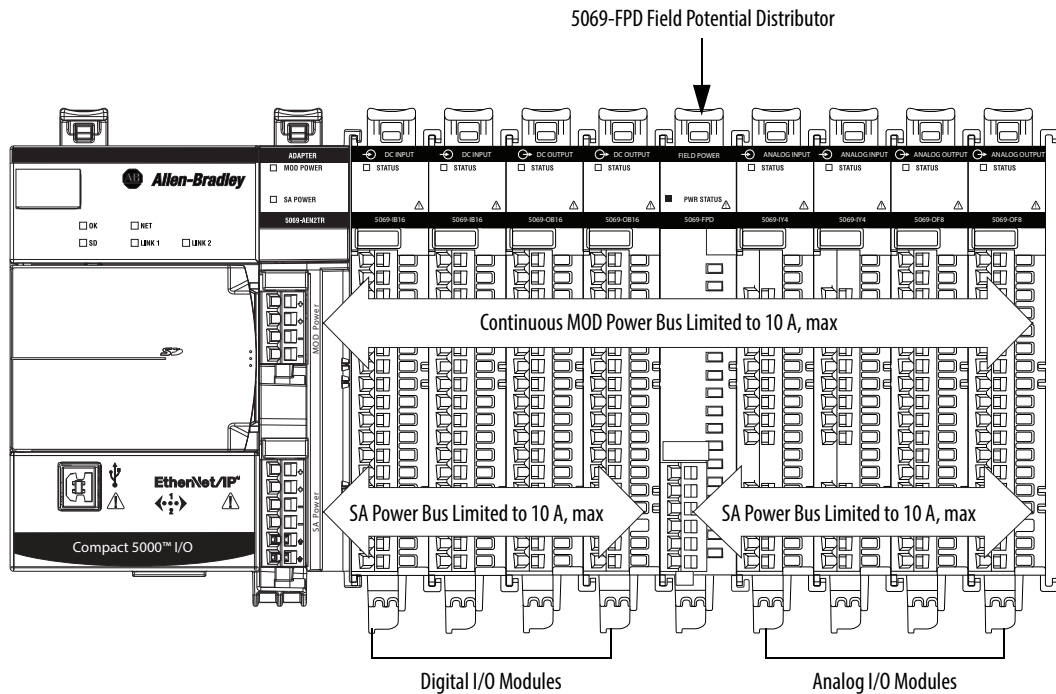

In this example, a 5069-FPD field potential distributor is used to create a new SA power bus so the DC type I/O modules are separated from the AC type I/O modules.

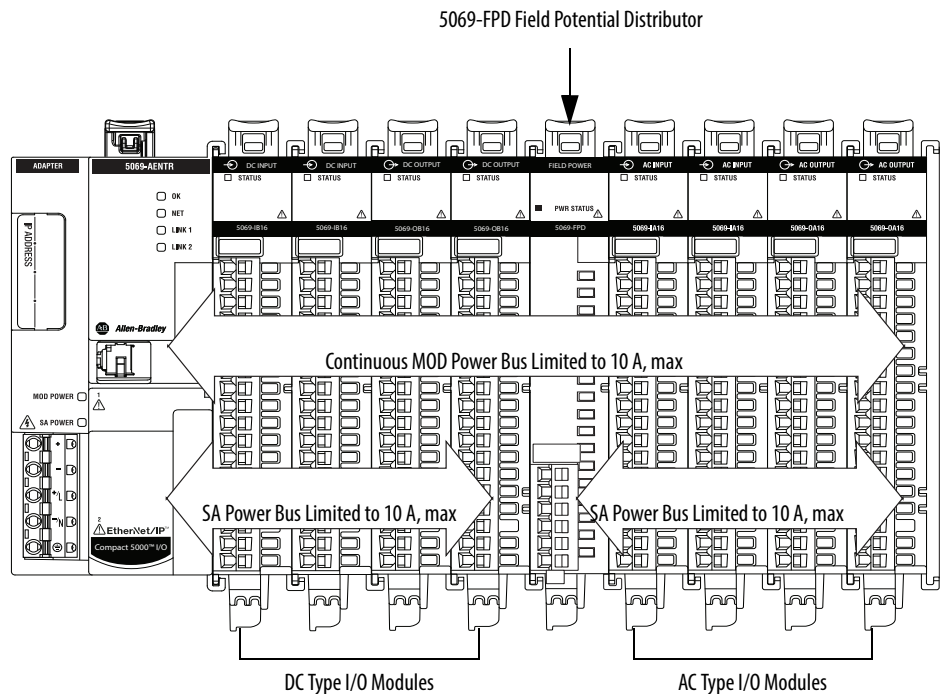

SA Power - Additional Notes

Remember the following:

- We recommend that you use a separate power supply for the SA power connection from the power supply that is used with the MOD power connection.
- The actual current in a Compact 5000 I/O system SA power bus current draw changes based on the operating conditions at a given time.

For example, the SA power bus current draw on some modules is different if all channels power field devices or half of the channels power field devices.

- Not all Compact 5000 I/O modules use SA power.

For example, the 5069-ARM, 5069-OB16, 5069-OB16F, 5069-OW4I, and 5069-OX4I modules do not use SA power.

- Some Compact 5000 I/O modules use field-side power but do not draw it from a SA power bus. The modules receive field-side power from an external power supply that is connected to the module RTB.

For example, the 5069-OB16 and 5069-OB16F modules use Local Actuator (LA) terminals, that is, LA+ and LA- terminals for all module channels.

Protected Mode

Protected Mode is a security enhancement that is automatically triggered as soon as one of the following occur:

- The adapter bridges I/O connections.
- The adapter is a target of I/O connections.

Protected mode is a state where the device is operational, but has implemented defenses against disruptive changes that would take the product out of service for the process.

This security enhancement occurs on the I/O module level and helps prevent unauthorized configuration changes that can affect system behavior and cause unintended and unforeseen changes.

IMPORTANT Protected Mode is not available on the 5069-AEN2TR adapter.

Enter and Exit Protected Mode

The adapter enters Protected Mode as soon as I/O connections are established through the adapter. The adapter exits Protected Mode as soon as all I/O connections through the adapter are stopped.

Restrictions Imposed By Protected Mode

Protected mode prevents access to services that are not required after the device is configured and in normal operation. Protected mode disables features that can make the device vulnerable to disruptive actions. By doing so, Protected mode helps to reduce the attack surface.

IMPORTANT Protected mode is not configurable.

When it is in Protected Mode, the adapter prevents execution of the following tasks:

- Changing Ethernet configuration settings, such as port speed.
- Changing IP settings, such as IP address, mask, and DHCP mode.
- Updating the adapter firmware revision.
- Disabling or re-enabling external product ports.
- Performing remote adapter resets.

Perform Tasks When Not Restricted

If the adapter is in Protected Mode and you attempt to perform any of the restricted tasks, you are alerted that such a task cannot be performed because the adapter is in Protected Mode.

The following are example alerts that result from an attempt to set IP values on the adapter when the adapter is in Protected Mode:

- Studio 5000 Logix Designer® application

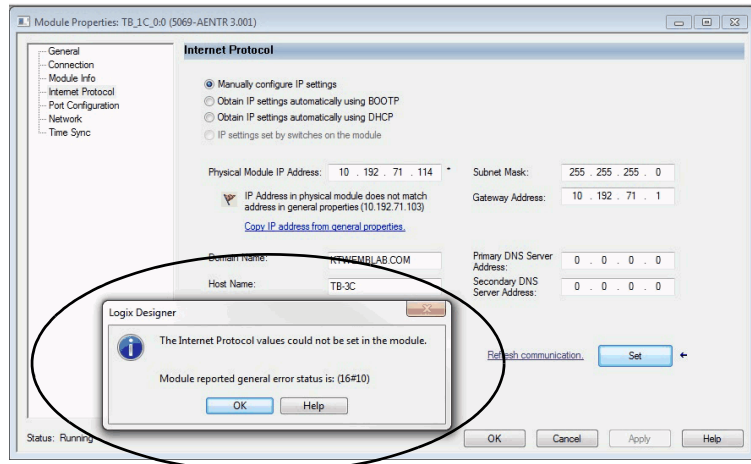

- RSLinx® software

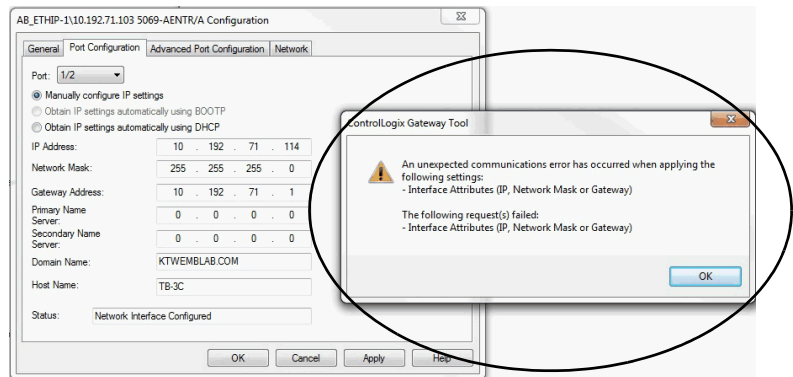

If the adapter is not in Protected Mode, the adapter does not reject attempts to perform the tasks that are described previously.

For example, after the adapter is initially powered up, but no I/O connections are established yet, the adapter is not in Protected Mode. You can attempt to update the adapter firmware revision and the adapter does not reject the attempt.

TIP If the adapter enters Protected Mode each time the adapter powers up, check application controllers to determine if there are active I/O connections that are opened via the adapter.

Configure Communication Drivers in RSLinx Classic Software

Topic	Page
Configure the Ethernet Communication Driver in RSLinx Classic Software	29
Configure the USB Communication Driver in RSLinx Classic Software	33

You connect to a controller through RSLinx® Classic software. To use RSLinx Classic software with your adapter, you must use a communication driver that corresponds to the cable connection.

For example, before you can connect to the adapter via an Ethernet cable, you must create an EtherNet/IP driver in RSLinx Classic software.

A communication driver is required to complete these tasks:

- Upload and download Logix Designer application projects to Logix 5000™ controllers over an EtherNet/IP network
- Collect controller data for electronic operator interfaces, for example, PanelView™ Plus terminals, and visualization software, for example, FactoryTalk® View software
- Update adapter firmware
- Set or change the IP address, if you do not use one of the other tools described in [Set the IP Address on the Adapter on page 40](#)
- Configure the adapter

Remember the following when you use the RSLinx Classic software communication drivers:

- EtherNet/IP driver:
 - Supports runtime communications
 - Requires that the workstation is properly connected to the EtherNet/IP network
 - Supports communications over longer distances when compared to the USB driver
- Ethernet devices driver:
 - Requires that you configure the IP addresses to which the software browses and, therefore, the devices with which the adapter communicates
- USB driver:
 - Convenient method to connect to an unconfigured adapter and configure the Ethernet port
 - Convenient method to connect to an adapter when the Ethernet port configuration is unknown
 - Convenient method to update the adapter firmware
 - Not intended for runtime connections; it is a temporary-use only connection with a limited cabling distance

IMPORTANT You can use a USB driver only with a 5069-AEN2TR adapter.

Configure the Ethernet Communication Driver in RSLinx Classic Software

Before you add an Ethernet driver, confirm that these conditions exist:

- The workstation is properly connected to the EtherNet/IP network.
- The workstation IP address and other network parameters are configured correctly.

To configure the EtherNet/IP driver, follow these steps.

1. From the Communications menu, choose Configure Drivers.

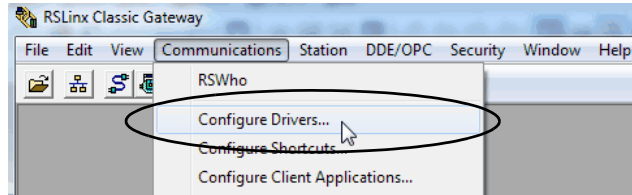

The Configure Drivers dialog box appears.

2. From the Available Driver Types pull-down menu, choose EtherNet/IP Driver.
3. Click Add New.

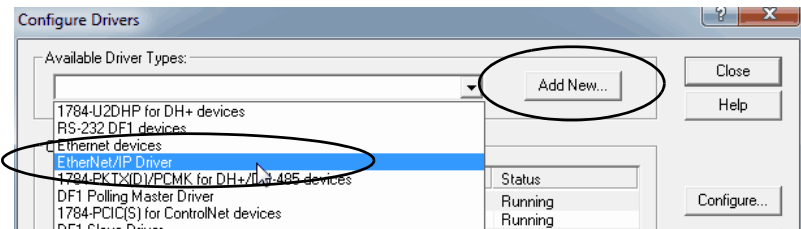

The Add New RSLinx Driver dialog box appears.

4. Type a name for the new driver and click OK.

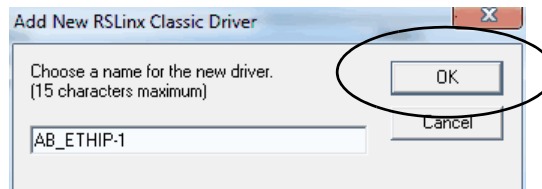

The Configure driver dialog box appears.

5. Click Browse Local Subnet.

TIP To view devices on another subnet or VLAN from the workstation running RSLinx Classic software, click Browse Remote Subnet.

6. Select the desired driver, and click OK.

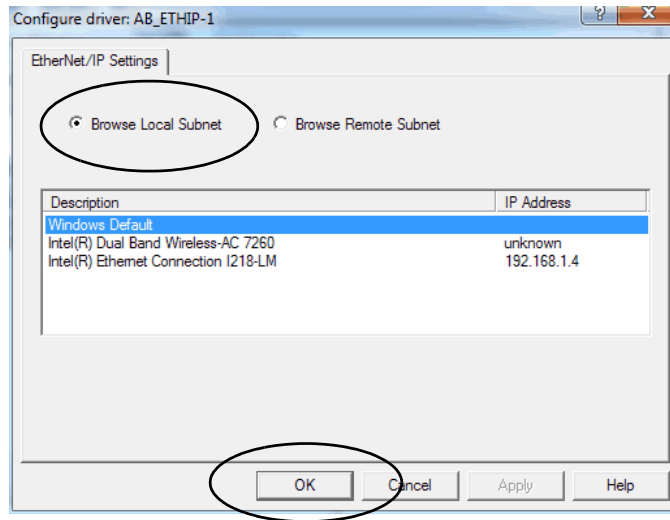

The new driver is available on the Configure Drivers dialog box.

7. Click Close.

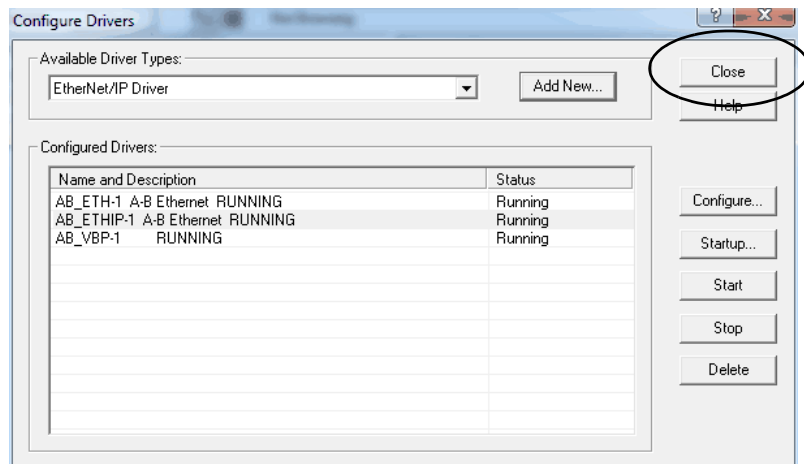

Configure the Ethernet Devices Drivers in RSLinx Classic Software

The following conditions must exist to configure an Ethernet devices driver:

- The workstation is connected to another EtherNet/IP network than the target controller.
- The IP address and other network parameters are correctly configured on the workstation.

To configure the Ethernet devices driver, complete the following steps.

1. From the Communications pull-down menu, choose Configure Drivers.

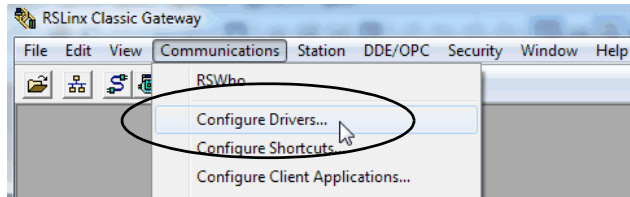

The Configure Drivers dialog box appears.

2. From the Available Driver Types pull-down menu, choose Ethernet devices.
3. Click Add New.

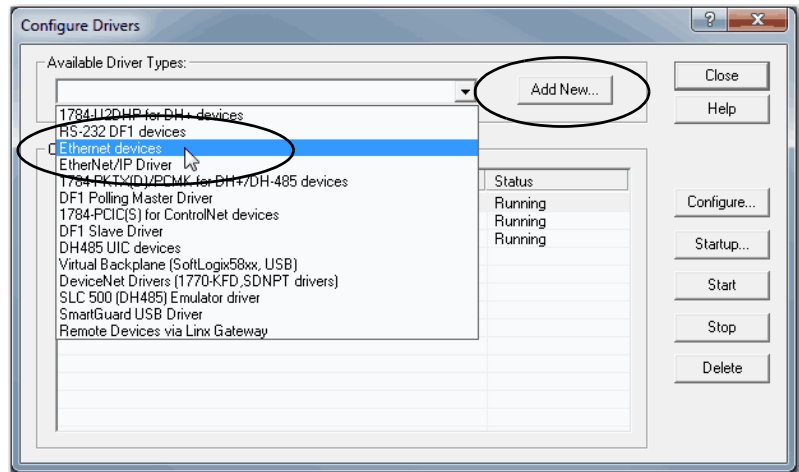

The Add New RSLinx Driver dialog box appears.

4. You can use the default name for the new drive or type a new name, and click OK.

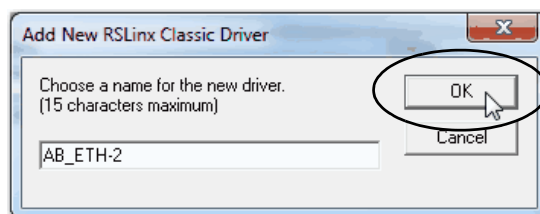

The Configure driver dialog box appears.

5. On the Configure driver dialog box, enter a host name for each station to which RSLinx Classic software browses.

The host name is the IP address for the device.

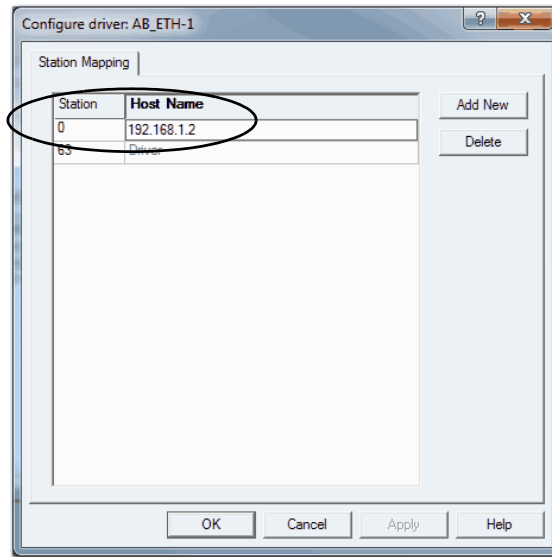

6. Click Add New to add stations and give each a host name.
7. When you finish adding stations, click OK.
8. On the Configure Drivers dialog box, click Close.

Configure the USB Communication Driver in RSLinx Classic Software

In RSLinx Classic software, version 3.80.00 or later, a USB driver automatically appears in the software when you connect the USB cable from your workstation to the controller.

IMPORTANT You can use a USB driver only with a 5069-AEN2TR adapter.

The USB driver can take a moment to appear in RSLinx Classic software.

IMPORTANT EtherNet/IP drivers remain visible in RSLinx Classic software after they are configured regardless of whether they are in use or not.

A USB driver appears in RSLinx Classic software only when a USB cable is connected between the workstation and the controller.

Once the cable is disconnected, the driver disappears from RSLinx Classic software.



ATTENTION: The USB port is intended for temporary, local programming purposes only and is not intended for permanent connection. The USB cable is not to exceed 3.0 m (9.84 ft) and must not contain hubs.



WARNING: Do not use the USB port in hazardous locations.

IMPORTANT Do not simultaneously load firmware for multiple modules through a USB port. If you do, one or more of the firmware loads can fail in the middle of the loading process.

If you use the RSLinx Classic software, version 3.80.00 or later, and a USB driver does not appear automatically, complete the following steps.

1. Connect one end of the USB cable to your workstation, and the other end to the USB port on the communication module.

The RSLinx Found New Hardware Wizard dialog box appears.

2. Click Install the software automatically (recommended).

3. Click Next.



These dialog boxes appear consecutively.

4. Click Finish.

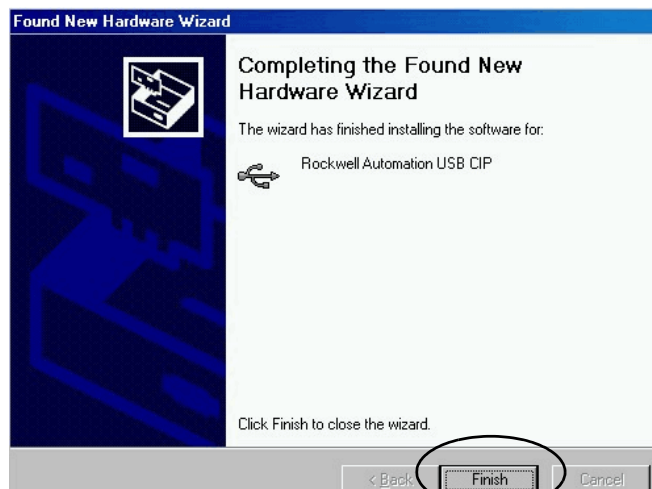
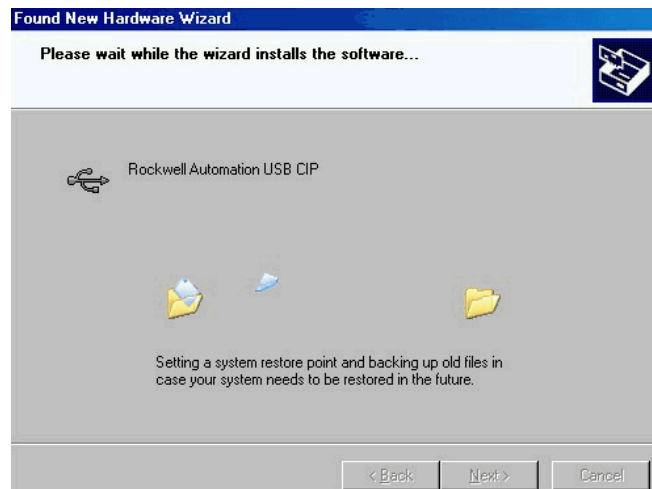

5. In RSLinx Classic software, from the Communications menu, click RSWHo.

The RSLinx Workstation organizer appears, and your module appears under two different drivers, a virtual chassis and the USB port.

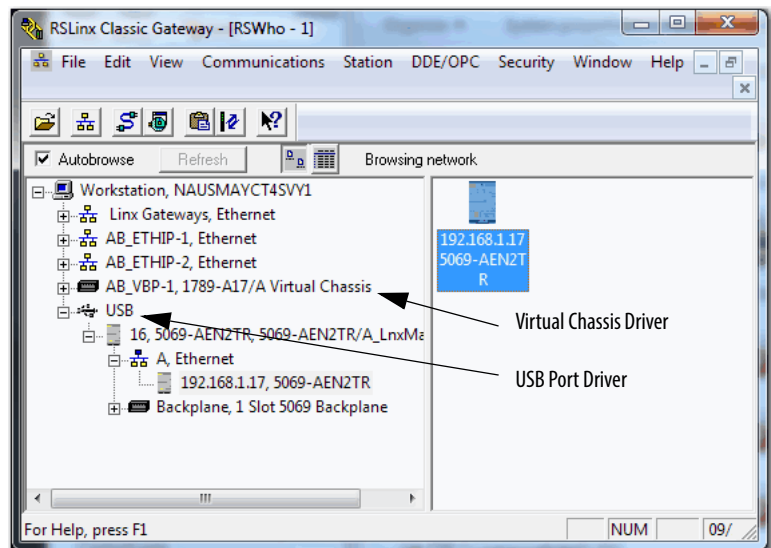

Notes:

Start to Use the Adapter

Topic	Page
Determine Network Parameters	38
Set the IP Address on the Adapter	40
Duplicate IP Address Detection	51
Duplicate IP Address Resolution	51
DNS Addressing	52
Configure Port Settings with RSLinx Classic Software	53

Determine Network Parameters

To operate an EtherNet/IP network, you must define these parameters.

EtherNet/IP Network Parameter	Description
IP address	<p>The IP address uniquely identifies the module. The IP address is in the form <i>xxx.xxx.xxx.xxx</i> where each <i>xxx</i> is a number from 000 . . . 254.</p> <p>There are some reserved values that you cannot use as the first octet in the address. These numbers are examples of values you cannot use:</p> <ul style="list-style-type: none"> • 001.<i>xxx.xxx.xxx</i> • 127.<i>xxx.xxx.xxx</i> • 223.<i>xxx.xxx.xxx</i> to 255.<i>xxx.xxx.xxx</i> <p>The specific reserved values that cannot be used vary according to the conditions of each application. The previous values are only examples of reserved values.</p>
Subnet mask	<p>Subnet addressing is an extension of the IP address scheme that allows a site to use one network ID for multiple physical networks. Routing outside of the site continues by dividing the IP address into a net ID and a host ID via the class. Inside a site, the subnet mask is used to redivide the IP address into a custom network ID portion and host ID portion. This field is set to 0.0.0.0 by default.</p> <p>If you change the subnet mask of an already-configured module, you must cycle power to the module for the change to take effect.</p>
Gateway	<p>A gateway connects individual physical networks into a system of networks. When a node communicates with a node on another network, a gateway transfers the data between the two networks. This field is set to 0.0.0.0 by default.</p> <p>If you change the gateway of an already-configured module, you must cycle power to the module for the change to take effect.</p>

If you use DNS addressing, or reference the module via host name in MSG instructions, define these parameters.

Table 2 - EtherNet/IP Network Parameters for DNS Addressing

EtherNet/IP Network Parameter	Description
Host name	A host name is part of a text address that identifies the host for a module. The full text address of a module is <i>host_name.domain_name</i> .
Domain name	A domain name is part of a text address that identifies the domain in which the module resides. The full text address of a module is <i>host_name.domain_name</i> . The domain name has a 48-character limit. If you specify a DNS server, you must type a domain name.
Primary DNS server address	<p>The server address identifies any DNS servers that are used in the network. You must have a DNS server that is configured if you specified a domain name or a host name in the module configuration. The DNS server converts the domain name or host name to an IP address that is used by the network.</p> <p>IMPORTANT: This applies to only the 5069-AEN2TR adapter. The 5069-AENTR and FLEX 5000 EtherNet/IP adapters do not support DNS client use. Therefore, the 5069-AENTR and FLEX 5000 EtherNet/IP adapters cannot convert the domain name or host name to an IP address that is used by the network.</p> <p>For more information on DNS addressing, see page 52.</p>
Secondary DNS server address	

Check with your Ethernet network administrator to determine if you must specify these parameters.

Consider these factors when you determine how to set the network IP address:

- Network isolation from or integration into the plant/enterprise network
- Network size - For large networks or isolated networks, it can be more convenient to use DHCP server. The DHCP server also limits the possibility that duplicate IP addresses are assigned.

For more information, see [page 47](#).

- Company policies and procedures that deal with plant floor network installation and maintenance
- Level of involvement by IT personnel in plant-floor network installation and maintenance
- Type of training that is offered to control engineers and maintenance personnel

If you use BOOTP/DHCP server in an uplinked subnet where an enterprise DHCP server exists, the enterprise server can assign an address before the BOOTP/DHCP server. In this case, you must disconnect from the uplink to set the address and configure the module to retain its static address before reconnecting to the uplink. This process is not a problem if you configured node names in the module and leave DHCP enabled.

■ Set the IP Address on the Adapter

You must set the IP address on the adapter for the adapter to operate on an EtherNet/IP network.

The following are adapter conditions in which you set the IP address:

- Set the IP address for the **first time** after it powers up in the out-of-box state.

IMPORTANT The adapter powers up in the out-of-box the first time you install it. However, the adapter also after power is cycled and the adapter is configured to clear its IP address after power is cycled.

- Change the IP address after it has been set.

Out-Of-Box State

When the adapter is in the out-of-the-box state, the following apply regarding IP addresses:

- The adapters ship without an IP address.
- The rotary switches on the adapter are set as follows:
 - 5069-AENTR adapter - 999
 - 5069-AEN2TR adapter - 000
 - FLEX 5000™ EtherNet/IP adapters - 999
- The adapter is DHCP-enabled. That is, the adapter is configured to obtain an IP address via a DHCP server.

If there is no DHCP server or the DHCP server is not configured to set the IP address, you must set the IP Address manually.

- The adapter issues requests for an IP address via DHCP until an IP address is set by using one of the tools that are described in this section.
- The adapter is configured so that you must set the IP address each time that power is cycled.

You can change the adapter configuration so that you are not required to set an IP address each time that power is cycled.

You can use these tools to set the IP address:

- Rotary switches - See [page 42](#)
- BOOTP-DHCP tool - See [page 43](#).
- DHCP server - See [page 43](#).
- RSLinx® Classic software - See [page 48](#).

Each tool has connection requirements to set the IP address via that tool. For more information, see the detailed descriptions of each tool.

[Figure 10](#) shows the process that the module uses to set the IP address.

Figure 10 - How the Module IP Address is Set

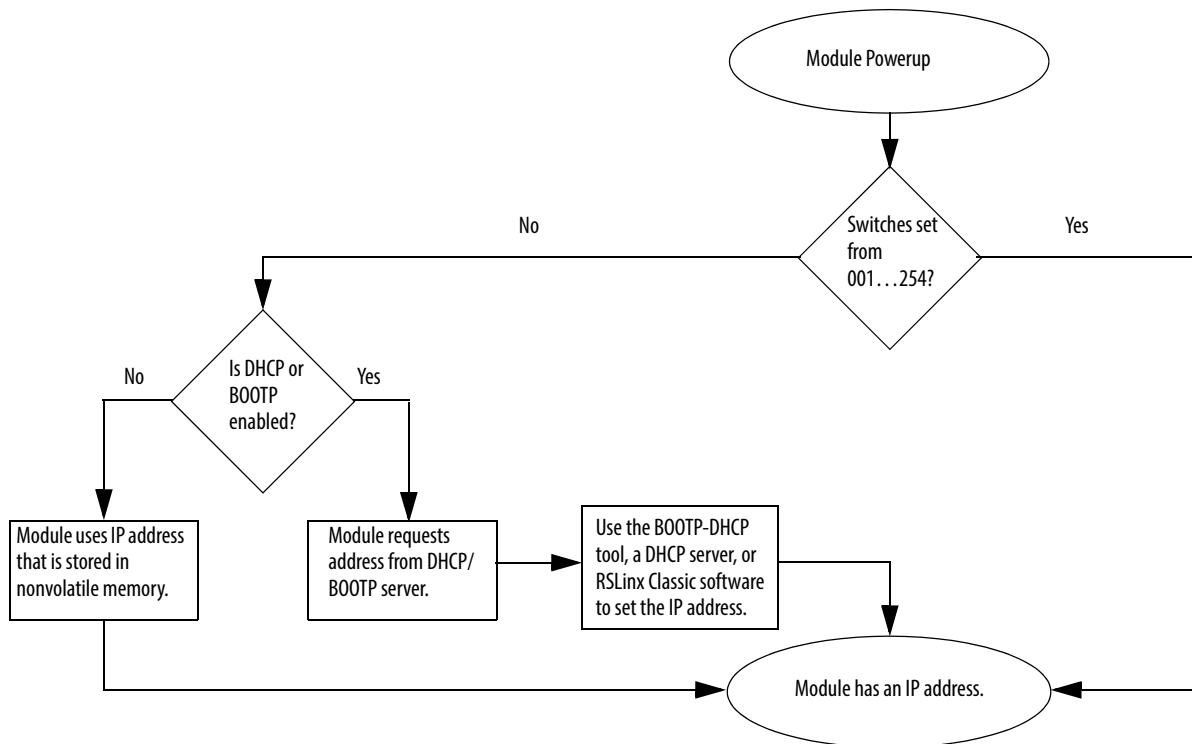

Set the IP Address with the Rotary Switches

If the network uses 192.168.1.x, use the rotary switches on the adapter to set the last octet of network IP address. Valid numbers range from 001...254.

IMPORTANT The rotary switches only set the IP address when power is cycled.



WARNING: When you change switch settings on the adapter while power is on, an electric arc can occur. This could cause an explosion in hazardous location installations. Be sure that power is removed or the area is nonhazardous before proceeding.

When you press the reset button on the 5069-AEN2TR adapter while power is on, an electric arc can occur. This could cause an explosion in hazardous location installations. Be sure that power is removed or the area is nonhazardous before proceeding.

IMPORTANT: The 5069-AEN2TR and FLEX 5000 EtherNet/IP adapters do not have a reset button.

- 5069-AEN2TR - The left-most switch represents the first digit in the octet, the middle switch represents the second digit, and the right-most switch represents the third digit.

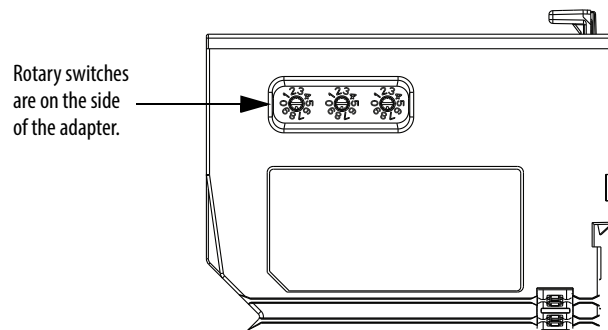

- 5069-AEN2TR - The bottom switch represents the first digit in the octet, the middle switch represents the second digit, and the top switch represents the third digit.

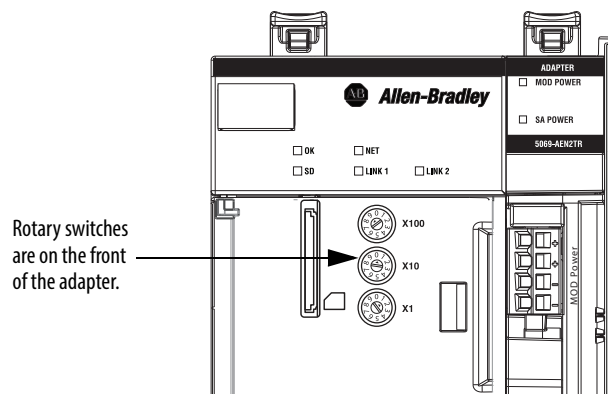

- FLEX 5000 EtherNet/IP adapters - The bottom switch represents the first digit in the octet, the middle switch represents the second digit, and the top switch represents the third digit.

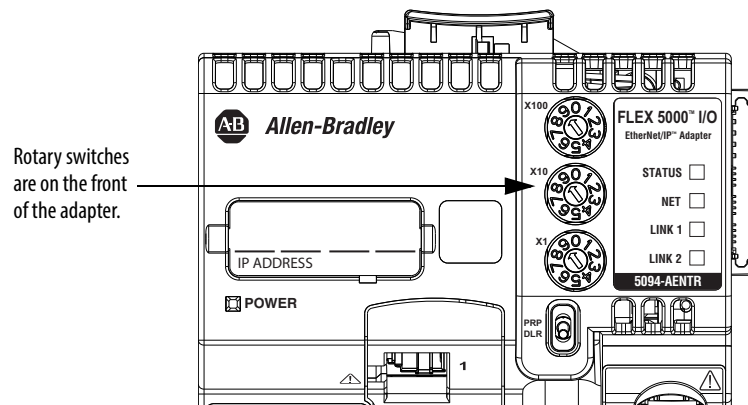

Set the IP Address with the BOOTP DHCP EtherNet/IP Commissioning Tool

The BOOTP/DHCP tool is a standalone server that you can use to set an IP address. The BOOTP/DHCP tool sets an IP address and other Transport Control Protocol (TCP) parameters.

You can use the BOOTP/DHCP tool to set the IP address when the adapter powers up in the out-of-box state. That is, the rotary switches are not set to a valid IP address, and the adapter is DHCP enabled.

Access the BOOTP/DHCP tool from one of these locations:

- Programs > Rockwell Software > BOOTP-DHCP Tool > BOOTP-DHCP Tool
- Tools directory on the Studio 5000® environment installation CD

IMPORTANT Before you start the BOOTP/DHCP tool, remember the following:

- Make sure that you have the hardware (MAC) address of the adapter.

The hardware address is on a sticker on the side of the communication module and uses an address in a format similar to the following:

00-00-BC-14-55-35

- Make sure that the workstation that you use to set the IP address has only one connection to the EtherNet/IP network on which the adapter resides.

The BOOTP/DHCP tool can fail to work if your workstation has multiple connections to the EtherNet/IP network.

To set the IP address with BOOTP/DHCP tool, complete the following steps.

1. Confirm that the adapter is connected to the network.
2. Start the BOOTP-DHCP tool.

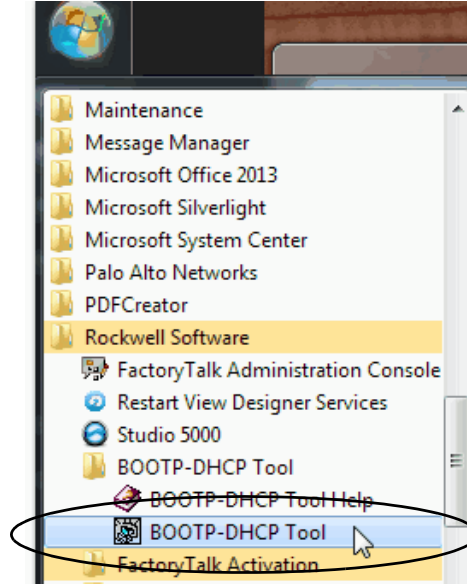

The MAC ID of the adapter appears in the Request History window.

3. Select the appropriate adapter and click Add to Relation List.

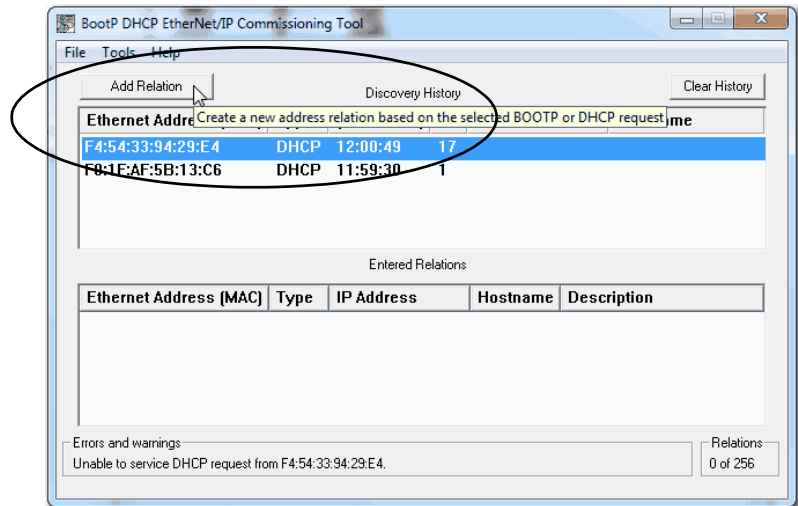

The New Entry dialog box appears.

4. Type an IP address, Hostname, and Description for the module.

Hostname and Description are optional.

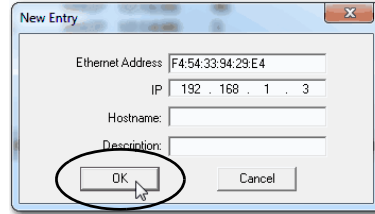

5. Click OK.
6. To assign this configuration on the module, wait for the module to appear in the Relation List panel and select it.
7. Click Disable BOOTP/DHCP.

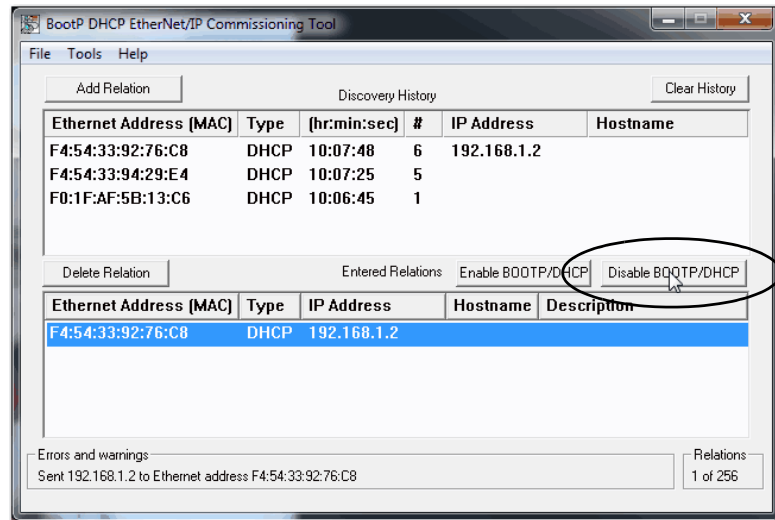

The module now uses the assigned configuration and does not issue BOOTP or DHCP requests after power is cycled on the controller.

IMPORTANT Remember the following:

- If you do not click Disable BOOTP/DHCP, on future power cycles, the current IP configuration is cleared and the controller sends DHCP requests again.
- If you click Disable BOOTP/DHCP and it does not disable BOOTP/DHCP, you can use RSLinx Classic software to disable BOOTP/DHCP.

For more information on how to use RSLinx Classic software to disable BOOTP/DHCP, see page [46](#).

Disable BOOTP/DHCP with RSLinx Classic Software

To disable BOOTP/DHCP in RSLinx Classic software, complete the following steps.

1. Start RSLinx Classic software.

After several seconds, an RSWho dialog box appears.

2. If no RSWho dialog box appears, from the Communications pull-down menu, choose RSWho.

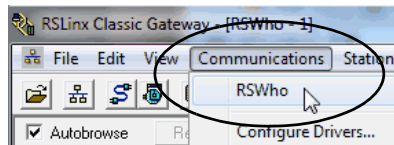

3. Navigate to the adapter.

You can access the adapter via the USB or an EtherNet/IP driver.

4. Right-click on the adapter and choose Module Configuration.

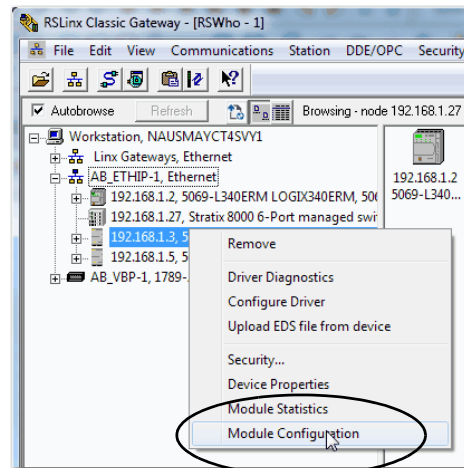

5. Click the Port Configuration tab.
6. Click Manually configure IP settings.

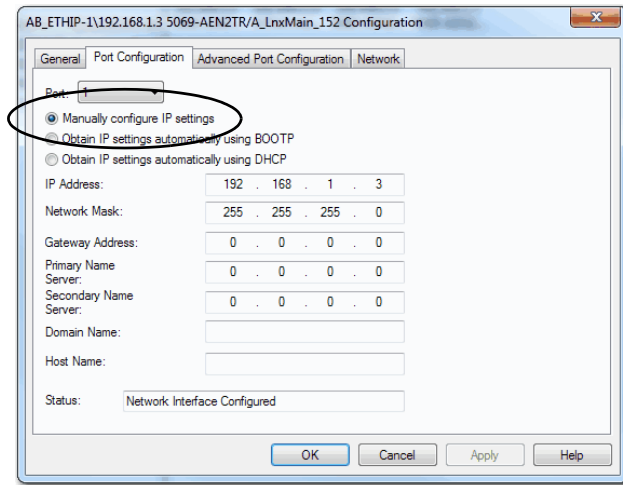

7. Click OK.

Set the IP Address with a DHCP Server

Because the adapters are DHCP-enabled when they are in the out-of-box condition, you can use a DHCP server to set the IP address.

The DHCP server automatically assigns IP addresses to client stations logging on to a TCP/IP network. DHCP is based on BOOTP and maintains some backward compatibility.



ATTENTION: You can use a DHCP server that is configured to always assign the same IP address to specific devices when they appear on the EtherNet/IP network and request an IP address.

If your system does not use a DHCP server that assigns the same IP address for specific devices, we **strongly recommend** that you assign the EtherNet/IP communication module a fixed IP address. Do not set the IP address dynamically. That is, do not use the Obtain IP settings automatically by using DHCP.

When an EtherNet/IP communication module uses Obtain IP settings automatically by using DHCP, the IP address for that adapter is cleared with each power cycle. If the same IP address is not automatically assigned to the module when it requests a new IP address, the module can be assigned another IP address than what was used before cycling power.

The use of a new IP address can result in such issues as a Duplicate IP Address condition or configuration faults because the module IP address differs from what is stored in a Logix Designer application project.

Failure to observe this precaution can result in unintended machine motion or loss of process control.

Set the IP Address with RSLinx Classic Software

To use RSLinx Classic software to set the 5069-AEN2TR adapter IP address for the **first time**, after it powers up in the out-of-box state, you must connect to the adapter via the USB port.

You cannot use RSLinx Classic software to set the IP address on a 5069-AENTR or a FLEX 5000 EtherNet/IP adapter for the first time after it powers up in the out-of-box state; the adapter does not have a USB port.

You must use one of the tools that are described previously to set the IP address on a 5069-AENTR or a FLEX 5000 EtherNet/IP adapter for the first time after it powers up in the out-of-box state.

IMPORTANT You can use RSLinx Classic software to configure the adapter, including to change the IP address after it has been set.

To change the IP address by using the RSLinx Classic software, the rotary switches on the adapter must be set to positions that are valid for DHCP address configuration (000...254).

You must access the adapter by browsing to it via an EtherNet/IP driver.

For more information on how to configure an adapter with RSLinx Classic software, see [page 53](#).



WARNING: Do not use the USB port in hazardous locations.



ATTENTION: The USB port is intended for temporary local programming purposes only and not intended for permanent connection. The USB cable is not to exceed 3.0 m (9.84 ft) and must not contain hubs.

Complete these steps to set the IP address on a 5069-AEN2TR adapter with RSLinx Classic software when the adapter is in the out-of-box state.

1. Confirm that your computer is connected to the adapter via a USB cable.
2. Start the RSLinx Classic software.

After several seconds, an RSWho dialog box appears.

3. If the RSWho dialog box does not appear, from the Communications pull-down menu, choose RSWho.

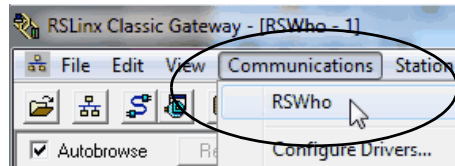

4. Right-click the adapter and choose Module Configuration.

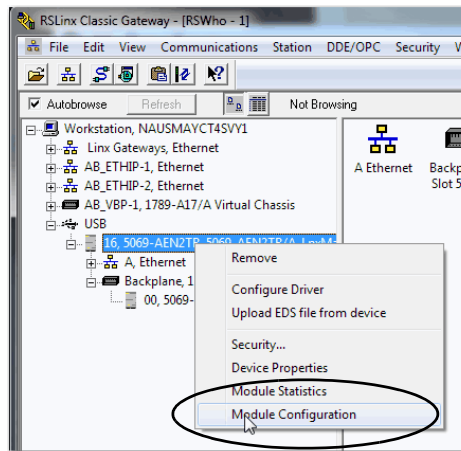

The Module Configuration dialog box appears.

5. Click the Port Configuration tab.
6. Click the Port Configuration tab.
7. Click Manually configure IP settings and set the port configuration parameters.

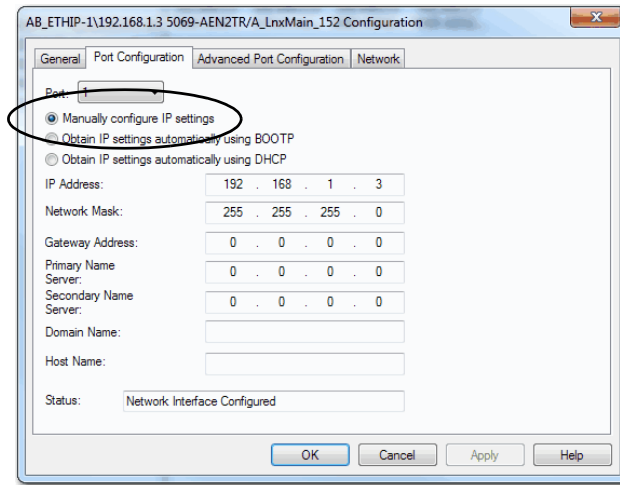

8. Click OK.
9. Open the USB branch on the menu tree.
The adapter shows the IP address.

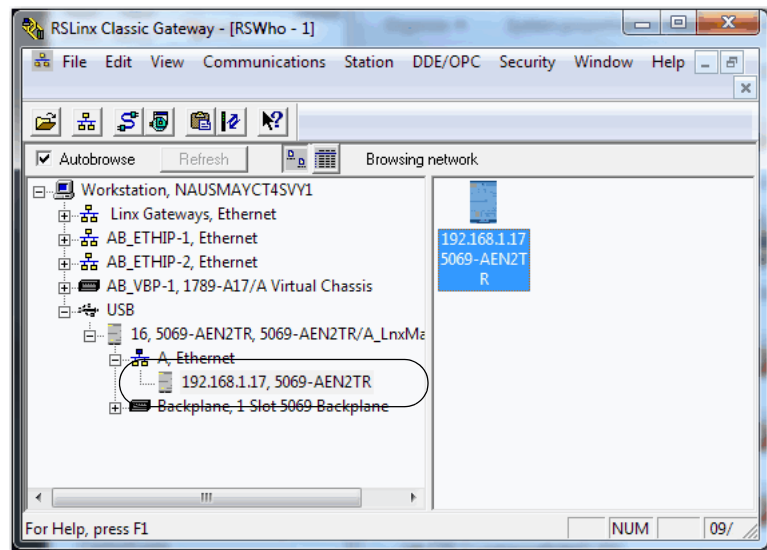

Duplicate IP Address Detection

The adapter verifies that its IP address does not match any other device IP address on the network when you perform either of these tasks:

- Connect the adapter to a EtherNet/IP network.
- Change the IP address on the adapter.

If the IP address matches that of another device on the network, the EtherNet/IP port on the adapter transitions to conflict mode. In conflict mode, these conditions exist:

- OK status indicator blinks red.
- Network (NET) status indicator is solid red.
- The following message scrolls across the 4-character display:

IMPORTANT The 5069-AENTR and FLEX 5000 EtherNet/IP adapters do not have a 4-character display.

<IP_address_of_this_module> Duplicate IP -
<MAC_address_of_duplicate_node_detected>

For example: 10.88.60.196 Duplicate IP - 00:00:BC:02:34:B4

Duplicate IP Address Resolution

This table describes how to resolve duplicate IP addresses.

Duplicate IP Address Detection Conditions	Resolution Process
<ul style="list-style-type: none"> • Both modules support duplicate IP address detection • Second module is added to the network after the first module is operating on the network 	<ol style="list-style-type: none"> 1. The module that began operation first uses the IP address and continues to operate without interruption. 2. The module that begins operation second detects the duplication and enters Conflict mode. To assign a new IP address to the module that entered Configure mode and then leave Conflict mode, see Set the IP Address on the Adapter on page 40.
<ul style="list-style-type: none"> • Both modules support duplicate IP address detection • Both modules were powered up at approximately the same time 	<p>Both EtherNet/IP devices enter Conflict mode. To resolve this conflict, follow these steps:</p> <ol style="list-style-type: none"> a. Assign a new IP address to one of the modules by using the methods that are described in Set the IP Address on the Adapter on page 40. b. Cycle power to the other device or disconnect and reconnect all Ethernet cables from the other device.
<p>One module supports duplicate IP address detection and a second module does not</p>	<ol style="list-style-type: none"> 1. Regardless of which module obtained the IP address first, the module that does not support IP address detection uses the IP address and continues to operate without interruption. 2. The module that supports duplicate IP address detection detects the duplication and enters Conflict mode. To assign a new IP address to the module and leave Conflict mode, see Set the IP Address on the Adapter on page 40.

DNS Addressing

To qualify the module address further, use DNS addressing to specify a host name for a module. When you specify a host name for the module, you also specify a domain name and DNS servers. DNS addressing makes it possible to create similar network structures and IP address sequences under different domains.

DNS addressing is necessary only if you refer to the module by host name, such as in path descriptions in MSG instructions.

To use DNS addressing, follow these steps.

1. Assign a host name to the module.

A network administrator can assign a host name. Valid host names must be IEC-1131-3 compliant.

2. Configure the module parameters:

- IP address
- Subnet mask
- Gateway address
- Host name for the module
- Domain name
- primary/secondary DNS server addresses.

In the DNS server, the host name must match the IP address of the module.

IMPORTANT Make sure the DNS enable bit is set.

- If you use **Logix Designer application**, version 28 or later, to configure your module, the enable bit is set and **DNS addressing is successful**.
 - If you use **RSLinx Classic software**, version 2.41.00 or later, to configure your module, the enable bit is cleared and **DNS addressing fails**.
-

3. In the Logix Designer application, add the module to the I/O configuration tree.

For more information, see Chapter 4, [Configure the Adapter on page 57](#).

IMPORTANT If a child module resides in the same domain as its parent module, type the host name. If the domain name of the child module differs from its parent module, type the host name and the domain name (host.domain)

IMPORTANT You can also use DNS addressing in a module profile in the I/O configuration tree or in a message path. If the domain name of the destination module differs from the source module, use a fully qualified DNS name (hostname.domainname). For example, to send a message from AEN2TR1.location1.companyA to AEN2TR1.location2.company, the host names match, but the domains differ. Without the entry of a fully qualified DNS name, the module adds the default domain name to the specified host name.

Configure Port Settings with RSLinx Classic Software

You can use RSLinx Classic software to configure a subset of the parameters available on the adapter. This section focuses on how to change the port settings on the adapter.

For information on how to configure the adapter in a Logix Designer application project, see [Start to Use the Adapter on page 37](#).

Consider the following:

- 5069-AENTR and FLEX 5000 EtherNet/IP adapters - You can configure the adapter with RSLinx Classic software only **after** an IP address is assigned.

The IP address must be assigned first because you can only connect to the adapter over an EtherNet/IP network. If there is not an IP address, the adapter does not appear in RSLinx Classic software when it browses the network.

- 5069-AEN2TR adapter - You can configure the adapter with RSLinx Classic software before or after an IP address is assigned.

Consider the following:

- To configure the adapter with RSLinx Classic software before you assign an IP address, you must connect to the adapter via the USB port.
- To configure the adapter with RSLinx Classic software after you assign an IP address, you can connect to the adapter via the USB port or over the EtherNet/IP network.

Complete the following steps.

1. Right-click the adapter and then click Module Configuration.
2. Click the Advanced Port Configuration tab.

IMPORTANT Consider the following when you configure the port settings:

- When the adapter uses the 1 Gbps network communication rate, it supports only full-duplex mode.
- When the adapter uses the 10 Mbps or 100 Mbps network communication rate, it supports full-duplex and half-duplex mode.
- The speed and duplex settings for the devices on the same Ethernet network must be the same to avoid transmission errors.
- Fixed speed and full-duplex settings offer better reliability than autonegotiate settings and are recommended for some applications.
- If the module is connected to an unmanaged switch, leave Auto-negotiate checked or the module fails.
- If you force the port speed and duplex with a managed switch, the corresponding port of the managed switch must be forced to the same settings or the module fails.
- If you connect a manually configured device to an autonegotiate device (duplex mismatch), a high rate of transmission errors can occur.
- To disable a port, clear the Enable checkbox.

You cannot disable both ports on a 5069-AENTR or FLEX 5000 EtherNet/IP adapter at the same time in RSLinx Classic software. We recommend that before you disable a port, you confirm that the port is not in use.

- If you disable a port in RSLinx Classic software and the port is being used for network communication, the communication is interrupted.

In this case, if the other Ethernet port is enabled, we recommend that you moved the Ethernet cable from the disabled port and connect it to the enabled port.

After you re-enable the port that was mistakenly disabled, you can change the cable connection back to the first port

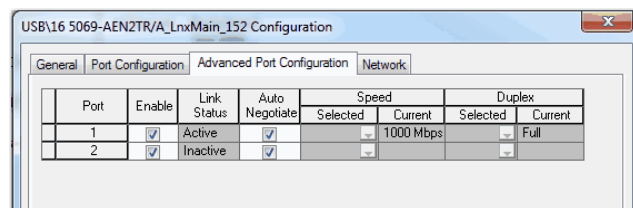

Task	Action
Let the module automatically set the port speed and duplex settings.	Leave the Auto-negotiate enabled.
Manually configure the port speed and duplex settings.	Follow these steps. <ol style="list-style-type: none">1. Clear the Auto-negotiate port speed and duplex checkbox.2. From the Current Port Speed pull-down menu, choose a port speed.3. From the Current Duplex pull-down menu, choose full-duplex.

3. On the Module Configuration dialog box, click OK.

■ Notes:

Configure the Adapter

Topic	Page
Add the Module to a Project	57
Time Synchronization	70

After you install the communication module and set the IP address, you must add the module to a controller project. The project must be online to set the Speed and Duplex configurable parameters on the module.

IMPORTANT You must use the following Logix Designer application, versions:

- 5069-AENTR adapter - Version 30 or later
- 5069-AEN2TR adapter - Version 28 or later
- FLEX 5000™ EtherNet/IP adapters - Version 31 or later

Version 28 or later is slightly different from previous programming software versions. For example, in some cases, instead of tabs across the top of the Module Properties dialog box, the application uses categories on the left side of the dialog box.

Add the Module to a Project

1. Verify that your project is offline.
2. Right-click your network port, and choose New Module.

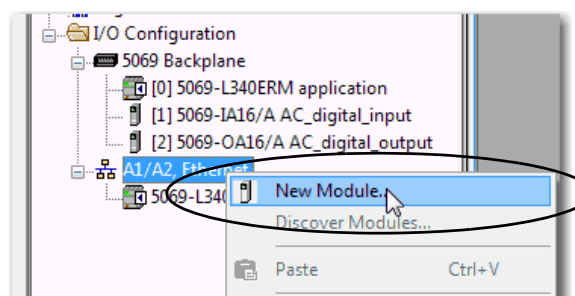

3. On the Select Module Type dialog box, complete the following tasks:
 - a. In the search field, type the catalog number for your adapter.

This example uses the 5069-AEN2TR adapter.

- b. In the Catalog Number field, select the adapter.

For some modules, the Select Major Revision dialog box can appear. If the dialog box appears, choose the major revision of the module and click OK.

- c. Click Create.

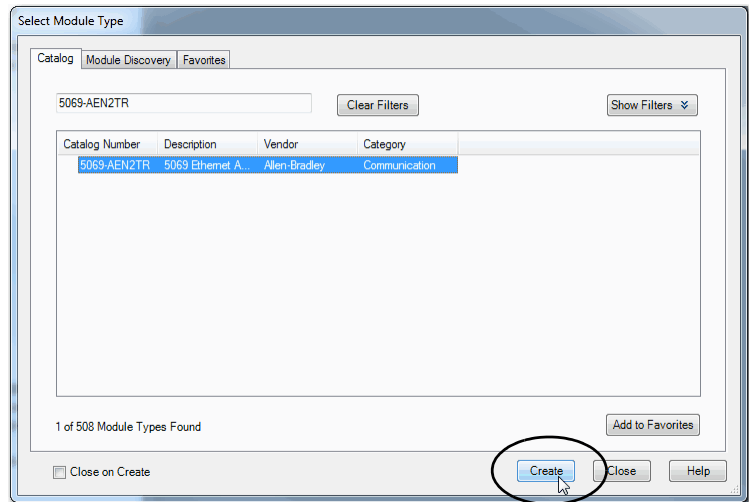

4. On the New Module dialog box, complete the following tasks on the General category page:
 - a. Type a name.
 - b. Enter the IP address.
 - c. In the Module Definition area, click Change.

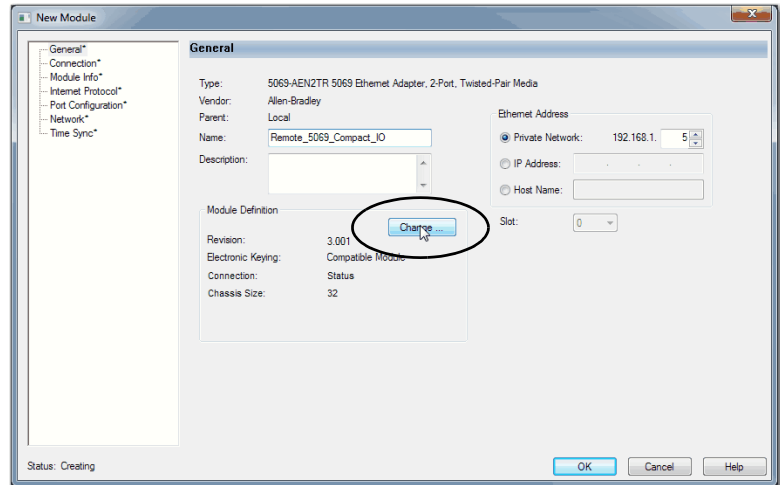

The Module Definition dialog box appears.

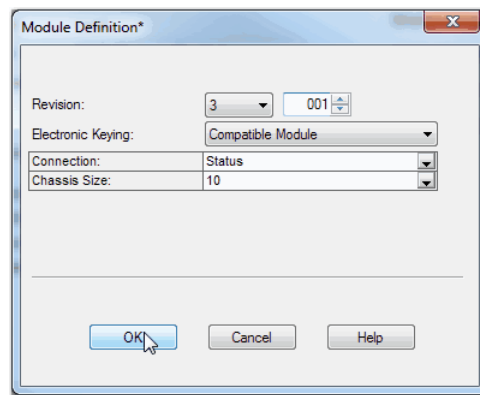

5. Complete the following tasks.
 - a. Set the appropriate Revision of the firmware that is on your adapter.

Major Revision (left pull-down menu)	This field only displays the major revisions that are applicable to the selected series. This field appears dimmed when online unless the module supports allowing major revision changes to be made while online.
Minor Revision (right field)	Sets the minor revision of the module. The valid range is 1...255. This field is enabled while offline, and while in the Program, Remote Program, and Remote Run modes. It appears dimmed when in Run mode, or when electronic keying is set to Disable Keying

- b. Select the appropriate the Electronic Keying setting.

Electronic Keying is enabled while offline, and while in Program, Remote Program, and Remote Run modes. It appears dimmed when in Run mode.

Electronic Keying reduces the possibility that you use the wrong device in a control system. It compares the device that is defined in your project to the installed device. If keying fails, a fault occurs. These attributes are compared.

Attribute	Description
Vendor	The device manufacturer.
Device Type	The general type of the product, for example, digital I/O module.
Product Code	The specific type of the product. The Product Code maps to a catalog number.
Major Revision	A number that represents the functional capabilities of a device.
Minor Revision	A number that represents behavior changes in the device.

The following Electronic Keying options are available.

Keying Option	Description
Compatible Module	Lets the installed device accept the key of the device that is defined in the project when the installed device can emulate the defined device. With Compatible Module, you can typically replace a device with another device that has the following characteristics: <ul style="list-style-type: none"> • Same catalog number • Same or higher Major Revision • Minor Revision as follows: <ul style="list-style-type: none"> – If the Major Revision is the same, the Minor Revision must be the same or higher. – If the Major Revision is higher, the Minor Revision can be any number.
Disable Keying	Indicates that the keying attributes are not considered when attempting to communicate with a device. With Disable Keying, communication can occur with a device other than the type specified in the project. ATTENTION: Be cautious when you use Disable Keying; if used incorrectly, this option can lead to personal injury or death, property damage, or economic loss. We strongly recommend that you do not use Disable Keying. If you use Disable Keying, you must take full responsibility for understanding whether the device being used can fulfill the functional requirements of the application.
Exact Match	Indicates that all keying attributes must match to establish communication. If any attribute does not match precisely, communication with the device does not occur.

Carefully consider the implications of each keying option when selecting one.

IMPORTANT When you change Electronic Keying parameters online, it interrupts connections to the device and any devices that are connected through the device. Connections from other controllers can also be broken. If an I/O connection to a device is interrupted, the result can be a loss of data.

For more detailed information on Electronic Keying, see Electronic Keying in Logix5000 Control Systems Application Technique, publication [LOGIX-AT001](#).

The following table shows which FLEX 5000 EtherNet/IP adapters are compatible for Electronic Keying.

In Use ('x' means compatible)					
Configured in Logix Designer		5094-AENTR	5094-AEN2TR	5094-AENTRXT	5094-AEN2TRXT
	5094-AENTR	x	x	x	x
	5094-AEN2TR		x		x
	5094-AENTRXT			x	x
	5094-AEN2TRXT				x

c. Select the Connection.

None	No direct connection from Controller (Originator) to the adapter.
Status	Reports device status.

d. Set the Chassis Size to the number of modules including the adapter.

For example, one adapter with nine I/O modules equals a chassis size of ten.

e. Click OK.

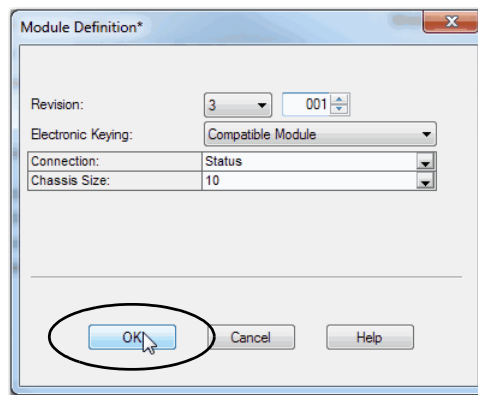

If you set the Connection to Status, click Yes on the RSLogix 5000® dialog box.

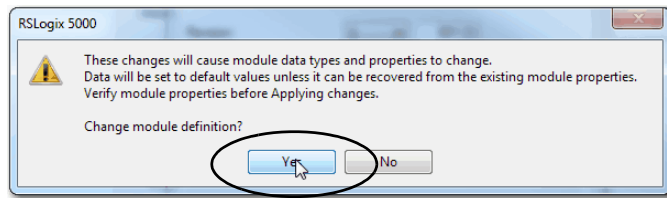

6. On the New Module dialog box, click the Connection category and complete the tasks:
 - a. Set the Requested Packet Interval (RPI). The range is 25...750 ms, with 100 ms as the default. This connection is for status data only, with no I/O.
 - b. Select the Connection over Ethernet/IP, Unicast, or Multicast.

For non-redundant controllers, the default value is Unicast when the target device supports unicast; otherwise, the default value is Multicast. For redundant controllers, the default value is Multicast when the target device supports multicast; otherwise, the default value is Unicast.

- c. Click OK.

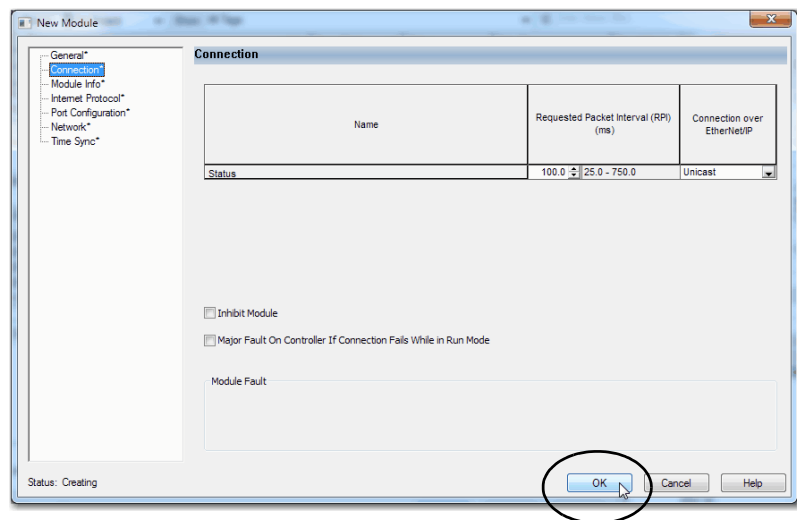

7. Save the project.
8. If the project does not have a communication path to the controller, click Browse to create a path.

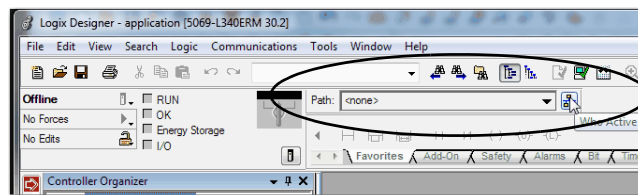

9. On the Who Active dialog box, choose the desired path and click Set Project Path and close the dialog box.

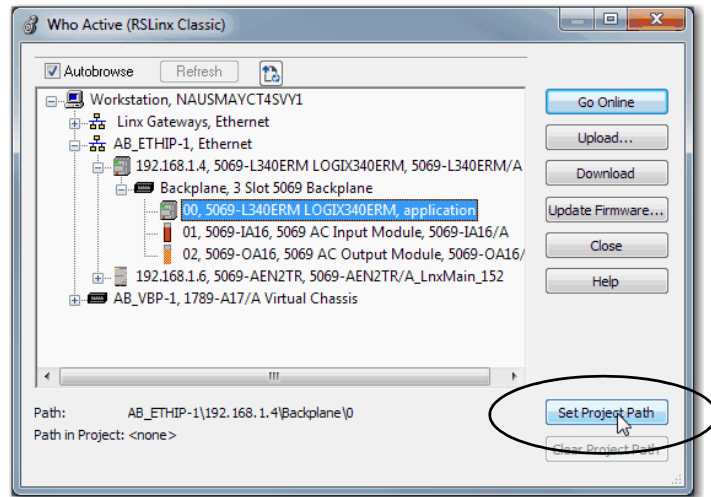

10. Verify that the controller mode switch is in the PROG mode position
11. Click the Controller Status icon, and choose Go Online.

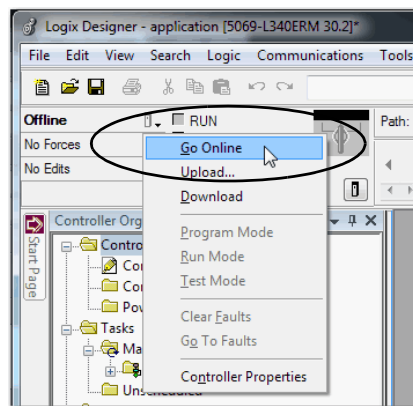

12. On the Connected To Go Online dialog box, click Download.

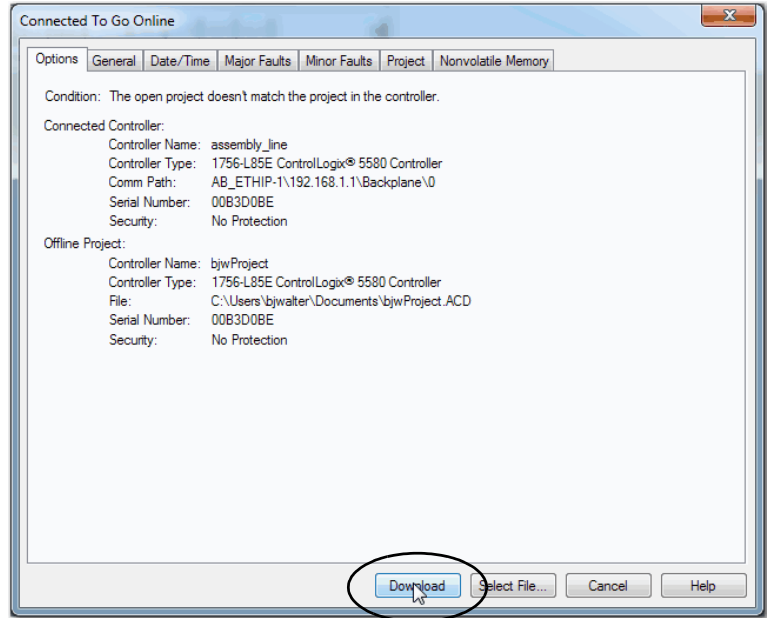

13. On the Download dialog box, click Download.

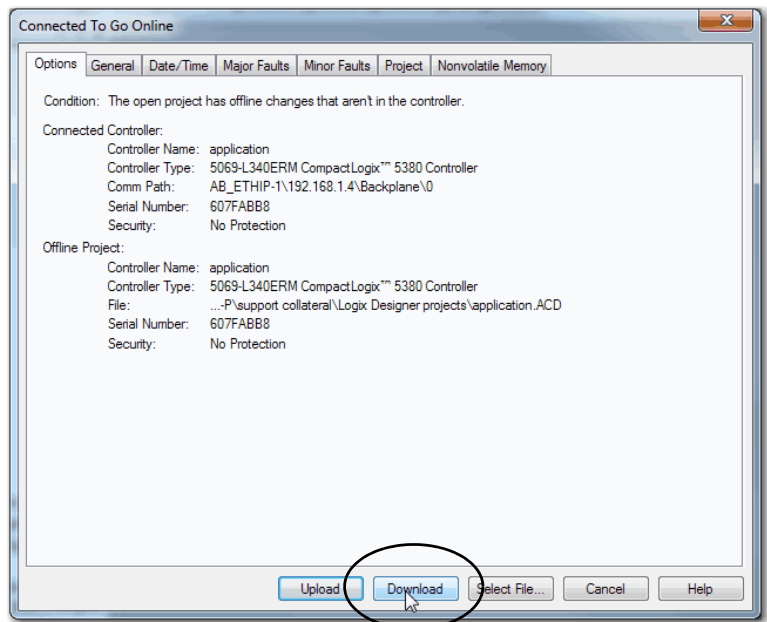

14. Confirm that you want to download the project.

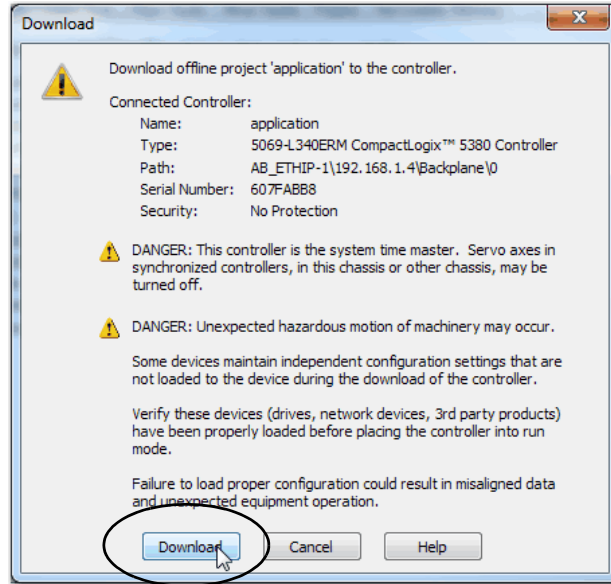

The project downloads to the controller. The dialog box closes when the download is complete.

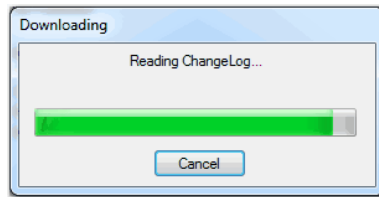

15. If you did not already configure the Ethernet port speed and duplex settings with RSLinx® Classic software, complete these tasks:
 - a. Put the controller mode switch in the REM position.
 - b. Change the Logix Designer application project to Run mode.

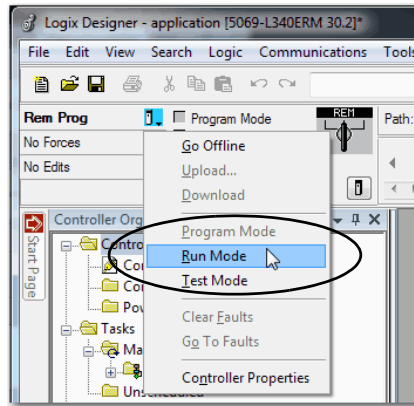

- c. When prompted to Change controller mode to Remote Run, click Yes.

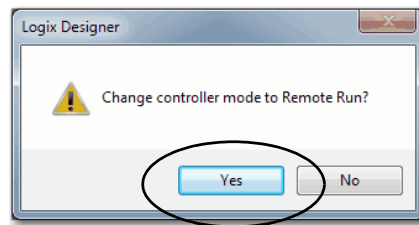

- d. Right-click the adapter, and choose Properties.

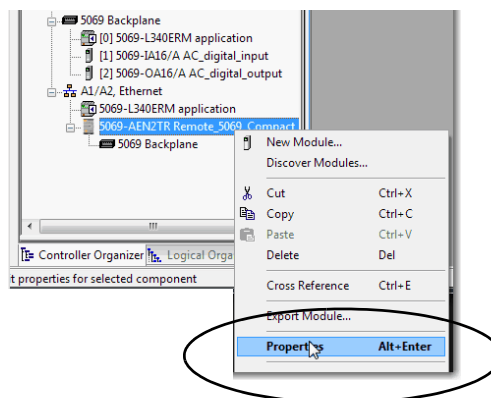

e. On the Module Properties dialog box, click the Port Configuration category.

Desired Task	Action
Let the module automatically set the port speed and duplex settings.	Leave Auto-negotiate enabled.
Manually configure your port speed and duplex settings.	Follow these steps. 1. Clear the Auto-negotiate port speed and duplex checkbox. 2. From the Current Port Speed pull-down menu, choose a port speed. 3. From the Current Duplex pull-down menu, choose full-duplex.

IMPORTANT Consider the following when you configure the port settings:

- The Compact 5000™ I/O EtherNet/IP adapters only support full-duplex mode.
- The speed and duplex settings for the devices on the same Ethernet network must be the same to avoid transmission errors.
- Fixed speed and full-duplex settings are offer better reliability than autonegotiate settings and are recommended for some applications.
- If the module is connected to an unmanaged switch, leave Auto-negotiate checked or the module fails.
- If you force the port speed and duplex with a managed switch, the corresponding port of the managed switch must be forced to the same settings or the module fails.
- If you connect a manually configured device to an autonegotiate device (duplex mismatch), a high rate of transmission errors can occur.

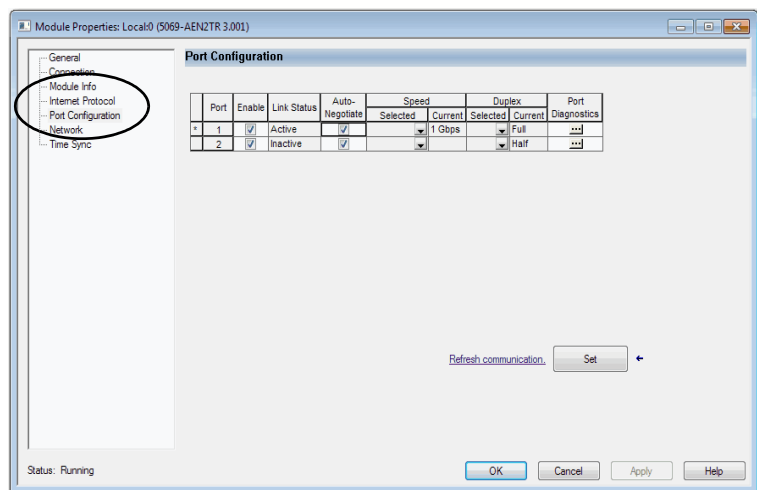

16. Click the Internet Protocol category.

If needed, you can set Internet Protocol properties such as:

- Domain Name
- Host Name
- Gateway Address
- Primary and secondary DNS Server Addresses.

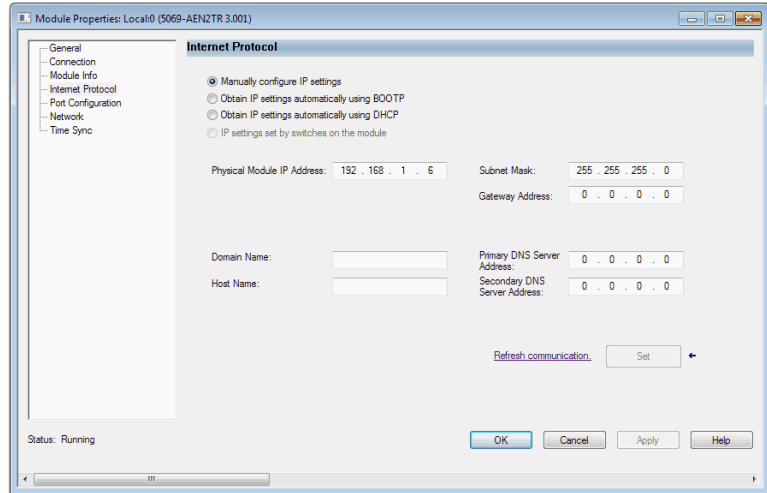

f. On the Module Properties dialog box, click OK.

IMPORTANT If you try to change the IP Address on this page, the following alert appears:

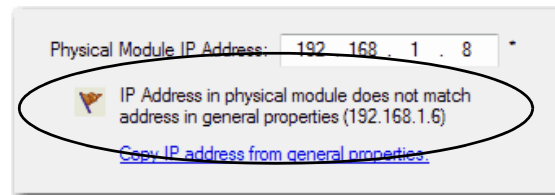

g. Save the project.

Time Synchronization

In certain situations, the I/O modules can synchronize with the adapter before the adapter synchronizes with the system Grandmaster clock. This synchronization occurrence leads to a time difference between the I/O and the Grandmaster clock until the adapter synchronizes with the Grandmaster clock.

In your logic, verify that the adapter is synchronized with the Grandmaster clock (CIPSyncValid) before you initiate timestamp requests or scheduled outputs from your I/O modules. A system with intermediate devices, such as network bridges and switches, can require that you insert a delay until the time stabilizes in the system.

For information on how to verify that the adapter is synchronized to a Grandmaster clock, see CIP Sync Diagnostics in the Integrated Architecture and CIP Sync Configuration Application Technique, publication [IA-AT003](#). This publication also includes information on Time Sync Object Attributes.

Notes:

Use the Module on a Device Level Ring Network

IMPORTANT This chapter summarizes a DLR network.

For information on how to plan, configure, and monitor a DLR network, see the EtherNet/IP Embedded Switch Technology Application Guide, publication [ENET-AP005](#).

A Device Level Ring (DLR) network is a single-fault-tolerant ring network that is intended for the interconnection of automation devices without the need for additional switches. The ring topology offers these advantages:

- Media redundancy
- Fast network fault detection and reconfiguration
- Resiliency of a single-fault tolerant network
- Easy implementation without any additional hardware requirements

One DLR network can support as many as 50 nodes. A DLR network supports copper connections (maximum of 100 m [328 ft]), fiber-optic connections (maximum of 2 km [1.24 mi]), or a mix of copper and fiber.

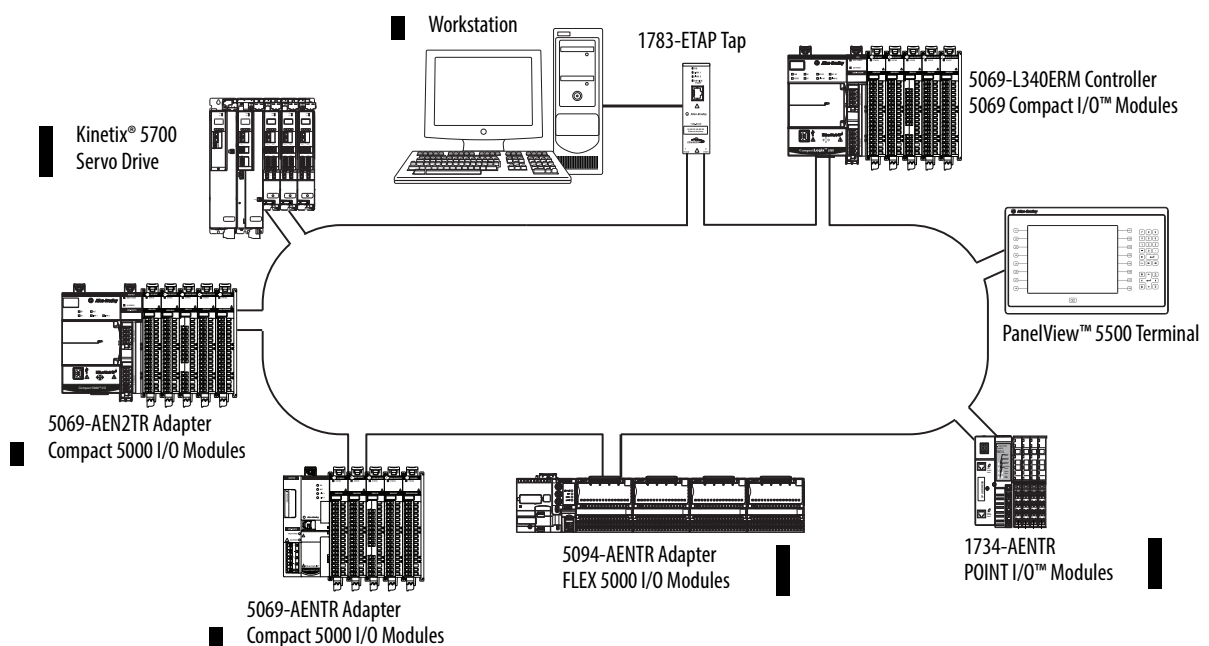

A DLR network includes the following nodes.

Node	Description
Supervisor node	<p>A DLR network requires at least one node to be configured as ring supervisor.</p> <p>IMPORTANT: By default, the supervisor function is disabled on supervisor-capable devices, so they are ready to participate in a linear/star network or as a ring node on a DLR network.</p> <p>In a DLR network, you must configure at least one of the supervisor-capable devices as the ring supervisor before physically connecting the ring. If you do not, the DLR network does not work.</p> <p>The ring supervisor provides these main functions:</p> <ul style="list-style-type: none"> • Manages traffic on the DLR network • Collects diagnostic information for the network <p>We recommend that you do the following:</p> <ul style="list-style-type: none"> • Configure at least one back-up supervisor. • Configure the desired active ring supervisor with a numerically higher precedence value as compared to the back-up supervisors. • Track the supervisor-precedence values for all supervisor-enabled nodes in the DLR network.
Ring node	<p>A ring node is any node that operates on the network to process data that is transmitted over the network. A ring node can also pass on the data to the next node on the network. When a fault occurs on the DLR network, the ring nodes reconfigure themselves and relearn the network topology. Additionally, ring nodes can report fault locations to the active ring supervisor.</p>

IMPORTANT Take note of the following:

- To operate on a specific network speed, all devices that are connected to the network must be configured to use the same speed. Otherwise, the lowest speed defines the network speed.
- You must set the PRP/DLR switch on FLEX 5000 EtherNet/IP adapters to the DLR position. If you set the switch to the PRP position, the adapter cannot establish connection with the I/O modules.

Module Diagnostics

Topic	Page
Diagnostics with the Logix Designer Application	75
Diagnostics with RSLinx Classic Software	86
EtherNet/IP Adapter Diagnostic Web Pages	91
Reset the Adapter	98

This chapter describes how to diagnose and troubleshoot issues with the Compact 5000™ I/O or FLEX 5000™ EtherNet/IP adapters.

IMPORTANT The example screens in this chapter are for a 5069-AEN2TR adapter. Unless specified, the screens for the 5069-AENTR and FLEX 5000 EtherNet/IP adapters are the same as the 5069-AENT2TR screens.

Diagnostics with the Logix Designer Application

You can use the Module Properties in the Logix Designer application to diagnose issues with the adapter.

When your project is online, these categories display information about the state and status of the adapter:

- [Connection Category](#)
- [Module Info Category](#)
- [Port Configuration Category](#)
- [Time Sync Category](#)

Connection Category

The Connection category displays information about the condition of the connection between the controller and the module. The data on this tab comes directly from the controller.

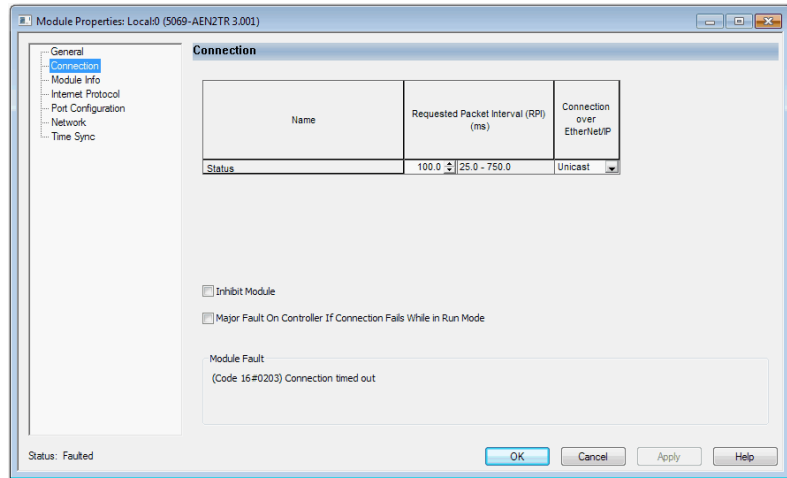

Module Fault

Module Fault displays the fault code that is returned from the controller, and text on the Module Fault that occurred. In the Logix Designer online help, type the fault code into the Search field to find information on the fault code.

The following are common categories for errors.

Connection Request Error	The controller is attempting to make a connection to the module and has received an error. The connection was not made.
Service Request Error	The controller is attempting to request a service from the module and has received an error. The service was not performed successfully.
Module Configuration Invalid	The configuration in the module is invalid.
Electronic Keying Mismatch	Electronic Keying is enabled and some part of the keying information differs between the software and the module.

Status

The Status line at the bottom of the Module Properties dialog box displays the status that the controller has about the module.

Status	Meaning
Standby	A transient state that occurs when shutting down.
Faulted	The controller is unable to communicate with the module. When the status is Faulted, the Connection tab displays the fault.
Validating	A transient state that occurs before connecting to the module.
Connecting	A state that occurs while connections are being established to the module.
Running	The module is communicating and everything is working as expected.
Shutting Down	The connections are closing.
Inhibited	The connection to the module is inhibited.
Waiting	The connection to this module is not made due to one of the following: <ul style="list-style-type: none"> • The parent has not yet made a connection to it. • The parent is inhibited. • The parent is faulted.
Offline	You are not online.
Reconfiguring	The configuration information is being downloaded to the module again.
Firmware Updating	The modules firmware is being updated.
Configuring	Indicates that the Logix controller is configuring the module.

Module Info Category

Module Info displays the module identity and status information about the module. See [Table 3](#) for parameter descriptions. You can also reset the module to its power-up state if needed. See [Reset Module on page 79](#).



ATTENTION: When you reset a module, all connections to or through the module are closed, and can result in loss of control.

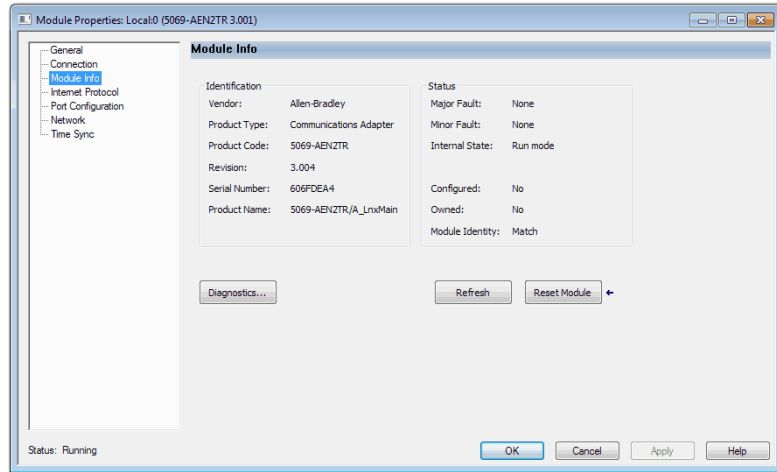

Table 3 - Module Info Parameters

Parameter	Description
Identification	<p>Displays the following:</p> <ul style="list-style-type: none"> • Vendor • Product Type • Product Code • Revision • Serial Number • Product Name <p>The name that is displayed in the Product Name field is read from the module. This name displays the series of the module.</p>
Major/Minor Fault	<p>Displays one of the following fault types:</p> <ul style="list-style-type: none"> • None • Unrecoverable • Recoverable

Table 3 - Module Info Parameters

Parameter	Description
Internal State	<p>Displays the current operational state of the module:</p> <ul style="list-style-type: none"> • Self-test • Flash update • Communication fault • Unconnected • Flash configuration bad • Major Fault (refer to Major/Minor Fault) • Run mode • Program mode • (16#xxxx) unknown <p>If you selected the wrong module from the module selection tab, this field displays a hexadecimal value. A textual description of this state is only given when the module identity you provide is a match with the actual module.</p>
Configured/Owned	For I/O modules only. Does not apply to adapters, scanners, bridges, or other communication modules
Module Identity	<p>Match</p> <ul style="list-style-type: none"> • Agrees with what is specified on the General Tab. • For the Match condition to exist, the following must agree: <ul style="list-style-type: none"> – Vendor – Module Type (the combination of Product Type and Product Code for a particular Vendor) – Major Revision <p>Mismatch</p> <ul style="list-style-type: none"> • Does not agree with what is specified on the General Tab. <p>The Module Identity field does not consider the Electronic Keying or Minor Revision selections for the module that were specified on the General Tab.</p>

Refresh

Click this button to refresh the tab with new data from the module.

Reset Module

To reset a module to its power-up state, click Reset Module.

IMPORTANT You cannot reset the 5069-AENTR or a FLEX 5000 EtherNet/IP adapter when it is in Protected Mode. For more information on Protected Mode, see [page 24](#).



ATTENTION: When you reset a module, all connections to or through the module are closed, and can result in loss of control.

Diagnostics for FLEX 5000 EtherNet/IP Adapters

Click this button to access the diagnostics for a module.

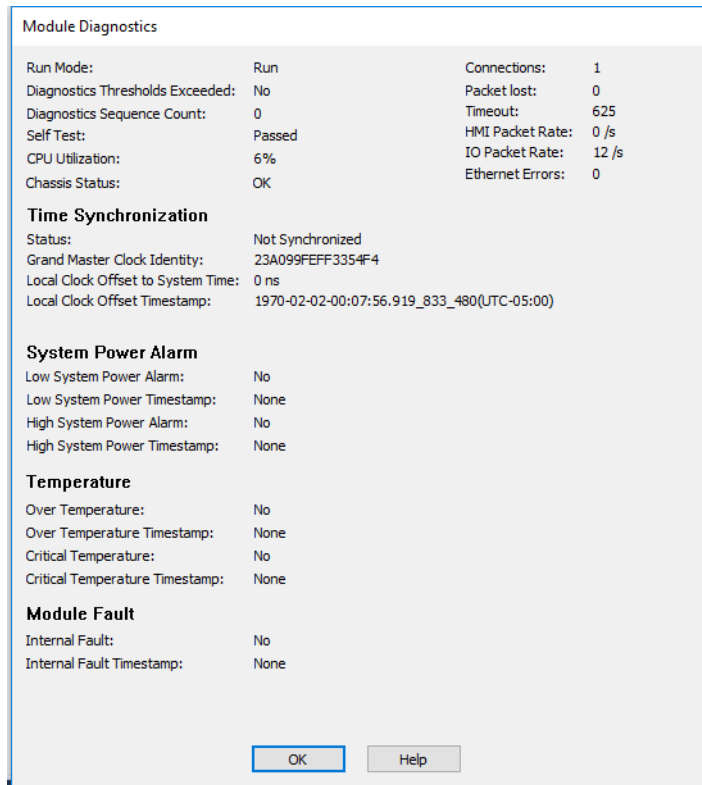

Table 4 - Module Diagnostics Parameters

Parameter	Description
Run Mode	Shows the operating state for the module. Run Mode is blank when the module is offline, or when the connection is not established to the module.
Diagnostics Thresholds Exceeded	Shows whether any diagnostics are active or a threshold has been reached when the event occurred.
Diagnostics Sequence Count	Shows the count for each time a distinct diagnostic condition was detected, and also each time a distinct diagnostic condition transitioned from detected to not detected.
Self Test	Shows whether the product initialization code detected an error.
CPU Utilization	Shows the usage of the compute engine.
Chassis Status	Shows whether the end cap and the module bases are properly connected.
Connections	Shows the number of CIP connections currently open to and through the adapter.
Packets Lost	Shows the running sum of the number of Sequenced Address Item Sequence Numbers that are skipped in Class 0 and Class 1 connections consumed by the adapter and its children.
Timeouts	Shows the running count of the number of connections that time out, both originated and targeted, to and through the adapter.
HMI Packet Rate	Shows the rate at which the HMI sent data. The number of Class 3 packets and unconnected packets sent and received by the device in the previous second.
IO Packet Rate	Shows the rate at which the I/O sent data. The number of Class 0 and Class 1 packets that were transmitted or received by the adapter in the previous second.

Table 4 - Module Diagnostics Parameters

Parameter	Description
Ethernet Errors	Shows the sum over all ports of the following Ethernet Link object values: In Discards, In Errors, In Unknown Protos, Out Discards, Out Errors, Alignment Errors, FCS Errors, Single Collisions, Multiple Collisions, SQE Test Errors, Deferred Transmissions, Late Collisions, Excessive Collisions, MAC Transmit Errors, Carrier Sense Errors, Frame Too Long, and MAC Receive Errors.
Time Synchronization Status	Shows whether the module is currently synchronized with a 1588 master.
Grand Master Clock Identity	Shows the identity of the Grand Master clock to which the module is synced.
Local Clock Offset to System Time	Shows the offset, in nanoseconds, from the local clock to the system time. Use this value to detect steps in time. This value updates when a precision time protocol (PTP) update message is received.
Local Clock Offset Timestamp	Shows the timestamp of the local clock offset in YYYY-MM-DD-HH:mm:SS.mmm format. <ul style="list-style-type: none"> • YYYY = year • MM = month • DD = day • HH = hour (24 hour) • mm = minutes • SS = seconds • mmm = milliseconds
Low System Power Alarm	Shows whether the input system power voltage has moved below the configured Low System Power Limit. If it is below the configured Low System Power Limit, it remains set until the input system power voltage moves above the configured Low System Power Alarm Limit.
Low System Power Timestamp	The time when a Low System Power condition most recently transitioned from No to Yes.
High System Power Alarm	Shows whether the input system power voltage moves above the configured High System Power Limit. If it is above the configured High System Power Limit, it remains set until the input system power voltage moves below the configured High System Power Alarm Limit.
High System Power Timestamp	The time when a High System Power condition most recently transitioned from No to Yes.
Over Temperature	Shows whether the product temperature is higher than its rated operating limits.
Over Temperature Timestamp	Shows the time when the product most recently became higher temperature than its operating limits.
Critical Temperature	Shows whether the product is above critical temperature limit for proper operation and may shutdown without further warning.
Critical Temperature Timestamp	The time when the module temperature most recently transitioned above the Critical Temperature.
Internal Fault	Shows whether one or more of several internal diagnostics indicate an internal issue in the product.
Internal Fault Timestamp	The time when an Internal Fault condition most recently transitioned from false to true.
Refresh communications	Updates the data displayed on the dialog box.

Port Configuration Category

If communication with the adapter fails, click Refresh communication to try to restart communication with the module.

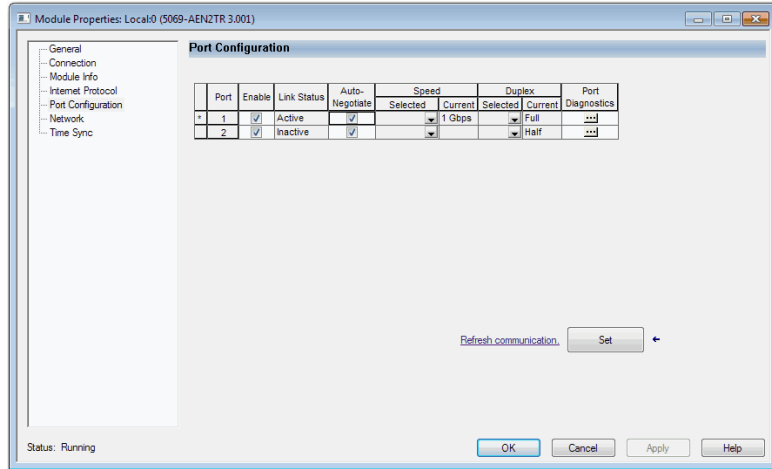

Port Diagnostics

On the Port Configuration category, click the Port Diagnostics button to view information for the port. See [Table 5 on page 83](#) for parameter descriptions.

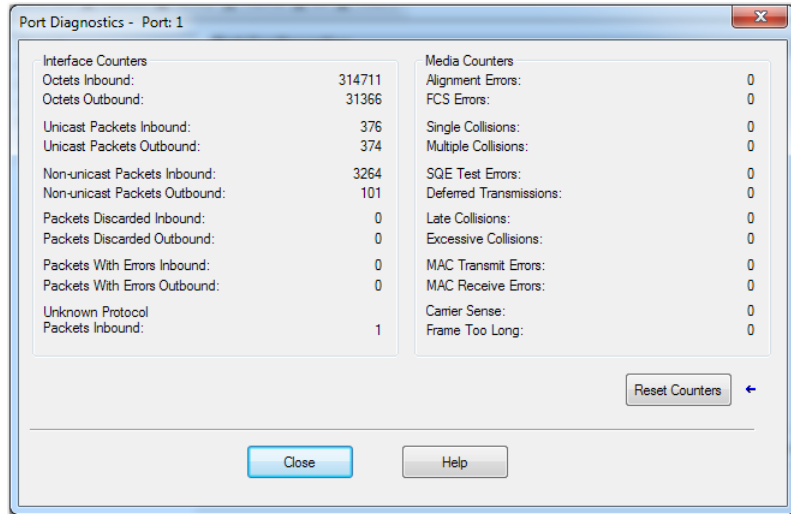

Table 5 - Port Diagnostics Parameters - Logix Designer

Parameter	Description
Interface Counters	The interface Counters values have no value when you are offline or online and there is a communication error.
Octets Inbound	Displays the number of octets that are received on the interface.
Octets Outbound	Displays the number of octets that are transmitted to the interface.
Unicast Packets Inbound	Displays the number of unicast packets that are received on the interface.
Unicast Packets Outbound	Displays the number of unicast packets that are transmitted on the interface.
Non-unicast Packets Inbound	Displays the number of non-unicast packets that are received on the interface.
Non-unicast Packets Outbound	Displays the number of non-unicast packets that are transmitted on the interface.
Packets Discarded Inbound	Displays the number of inbound packets that are received on the interface but discarded.
Packets Discarded Outbound	Displays the number of outbound packets that are transmitted on the interface but discarded.
Packets With Errors Inbound	Displays the number of inbound packets that contain errors (excludes discarded inbound packets).
Packets With Errors Outbound	Displays the number of outbound packets that contain errors (excludes discarded outbound packets).
Unknown Protocol Packets Inbound	Displays the number of inbound packets with unknown protocol.
Media Counters	The Media Counters values have no value when you are offline or online and there is a communication error.
Alignment Errors	Displays the number of frames received that are not an integral number of octets in length.
FCS Errors	Displays the number of frames received that do not pass the FCS check.
Single Collisions	Displays the number of successfully transmitted frames that experienced exactly one collision.
Multiple Collisions	Displays the number of successfully transmitted frames that experienced multiple collisions.
SQE Test Errors	Displays the number of times an SQE test error message was generated.
Deferred Transmissions	Displays the number of frames for which the first transmission attempt is delayed because the medium is busy.
Late Collisions	Displays the number of times a collision is detected later than 512 bit-times into the transmission of a packet.
Excessive Collisions	Displays the number of frames for which transmission fails due to excessive collisions.
MAC Transmit Errors	Displays the number of frames for which transmission fails due to an internal MAC sub layer transmit error.
MAC Receive Errors	Displays the number of frames for which reception on an interface fails due to an internal MAC sub layer receive error.
Carrier Sense	Displays the number of times that the carrier sense condition was lost or never asserted when attempting to transmit a frame.
Frame Too Long	Displays the number of frames received that exceed the maximum permitted frame size.
Reset Counters	Click Reset Counter to reset the interface and media counter values to zero. The values then update to the current counter values. Reset Counter appears dimmed in the following conditions: <ul style="list-style-type: none"> • The project is offline. • The project is online and a communication error occurred.

Time Sync Category

The Time Sync displays information that is related to CIP Sync time synchronization. The information appears only if the project is online and CIP Sync is enabled.

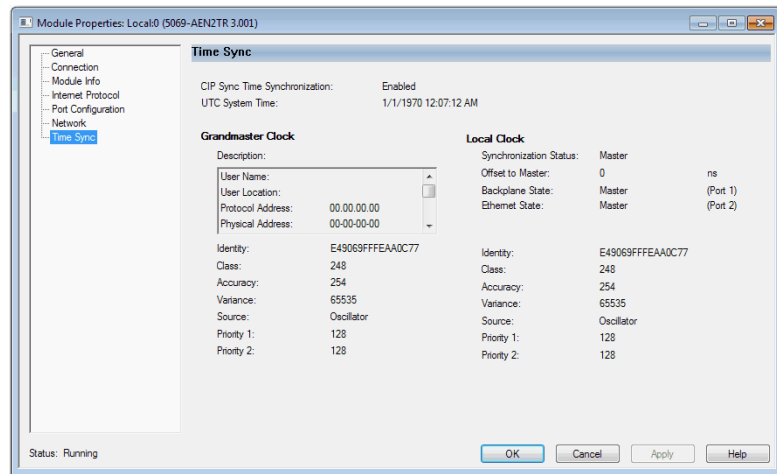

Table 6 - Time Sync Parameters

Grandmaster Clock	
Description	<p>Displays information about the Grandmaster clock. The vendor of the Grandmaster device controls this information. The following information is specified:</p> <ul style="list-style-type: none"> • User Name • User Location • Protocol Address • Physical Address • Clock Type • Manufacturer Name • Model • Serial Number • Hardware Revision • Firmware Revision • Software Version • Profile Identity • Physical Protocol • Network Protocol • Port Number <p>Use the vertical scroll bar to view the data.</p>
Identity	Displays the unique identifier for the Grandmaster clock. The format depends on the network protocol. Ethernet network encodes the MAC ID into the identifier.
Class	Displays a measure of the quality of the Grandmaster clock. Values are defined from 0...255 with zero as the best clock.
Accuracy	Indicates the expected absolute accuracy of the Grandmaster clock relative to the PTP epoch. The accuracy is specified as a graduated scale that starts at 25 nsec and ends at greater than 10 seconds or unknown. The lower the accuracy value, the better the clock.
Variance	Displays the measure of inherent stability properties of the Grandmaster clock. The value is represented in offset scaled log units. The lower the variance, the better the clock.

Table 6 - Time Sync Parameters

Source	Displays the time source of the Grandmaster clock. The available values are: <ul style="list-style-type: none"> • Atomic Clock • GPS • Radio • PTP • NTP • HAND set • Other • Oscillator
Priority 1 / Priority 2	Displays the relative priority of the Grandmaster clock to other clocks in the system. The priority values range from 0 . . . 255. The highest priority is zero. The default value for both settings is 128.
Local Clock	
Synchronization Status	Displays whether the local clock is synchronized or not synchronized with the Grandmaster reference clock. A clock is synchronized if it has one port in the slave state and is receiving updates from the time master.
Offset to Master	Displays the amount of deviation between the local clock and the Grandmaster clock in nanoseconds.
Backplane State	Displays the current state of the backplane. The available values are: Initializing, Faulty, Disabled, Listening, PreMaster, Master, Passive, Uncalibration, Slave, or None.
Ethernet State	Displays the state of the Ethernet port. The available values are: Initializing, Faulty, Disabled, Listening, PreMaster, Master, Passive, Uncalibration, Slave, or None.
Identity	Displays the unique identifier for the local clock. The format depends on the network protocol. Ethernet network encodes the MAC ID into the identifier.
Class	Displays a measure of quality of the local clock. Values are defined from 0 . . . 255, with zero as the best clock.
Accuracy	Indicates the expected absolute accuracy of the local clock relative to the PTP epoch. The accuracy is specified as a graduated scale that starts at 25 nsec and ends at greater than 10 seconds or unknown. The lower the accuracy value, the better the clock.
Variance	Displays the measure of inherent stability properties of the local clock. The value is represented in offset scaled log units. The lower the variance, the better the clock.
Source	Displays the time source of the local clock. The available values are: <ul style="list-style-type: none"> • Atomic Clock • GPS • Terrestrial Radio • PTP • NTP • HAND set • Other • Oscillator

Diagnostics with RSLinx Classic Software

You can also view diagnostic information in RSLinx® Classic software. Diagnostic information is available on the following tabs:

- [General Tab](#)
- [Port Diagnostics Tab](#)
- [Connection Manager Tab](#)
- [USB Tab](#)

1. From the Communications menu, click RSWho.

The RSWho dialog box appears.

2. Navigate to the Ethernet network.

3. Right-click the EtherNet/IP module and click Module Statistics.

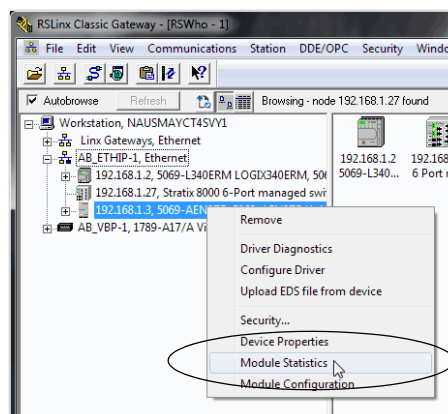

General Tab

The General tab shows device information and any faults on the adapter.

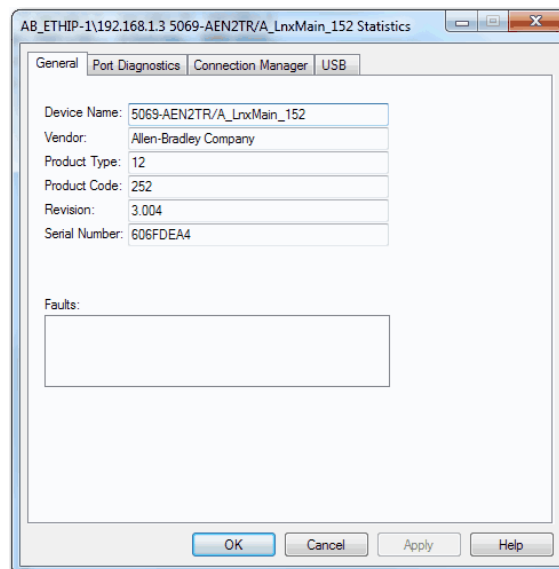

Port Diagnostics Tab

The Port Diagnostics tab shows information for the port. See [Table 7 on page 87](#) for parameter descriptions.

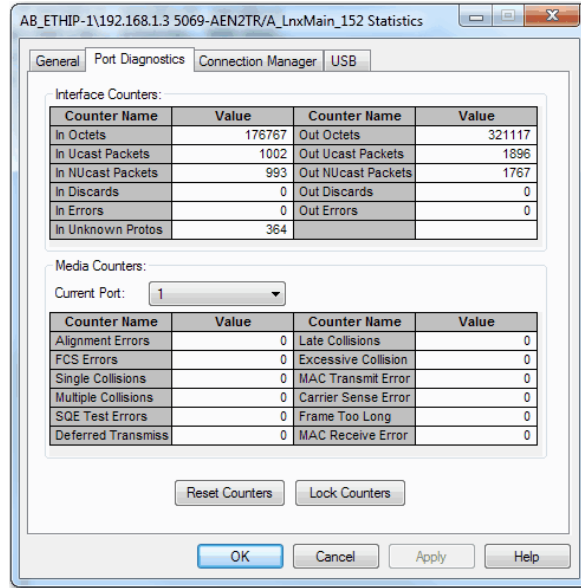

Table 7 - Port Diagnostics Parameters - RSLinx Classic

Parameter	Description
Interface Counters	Provides information relevant to receipt of packets on the interface
In Octets	Octets received on the interface.
Out Octets	Octets sent out from the interface.
In Ucast Packets	Unicast packets that are received on the interface.
Out Ucast Packets	Unicast packet sent out from the interface.
In NUCast Packets	Non-unicast packets that are received on the interface.
Out NUCast Packets	Non-unicast packets sent out from the interface.
In Discards	Inbound packets that were received on the interface but discarded.
Out Discards	Outbound packets that were sent out from the interface but were discarded.
In Errors	Inbound packets that contain errors (excludes In Discards).
Out Errors	Outbound packets that contain errors.
In Unknown Protos	Inbound packets with unknown protocol.

Table 7 - Port Diagnostics Parameters - RSLinx Classic

Parameter	Description
Media Counters	Provides information specific to Ethernet media you are using
Alignment Errors	Frames received that are not an integral number of octets in length.
FCS Errors	Frames received that do not pass the FCS (Frame Check Sequence) check.
Single Collisions	Successfully transmitted frames that experienced exactly one collision.
Multiple Collisions	Successfully transmitted frames that experienced multiple collisions.
SQE Test Errors	Number of times an SQE test error message was generated.
Deferred Transmissions	Frames for which the first transmission attempt is delayed because the medium is busy.
Late Collisions	Number of times a collision is detected later than 512 bit-times into the transmission of a packet.
Excessive Collisions	Frames for which transmission fails due to excessive collisions.
MAC Transmit Errors	Frames for which transmission fails due to an internal MAC sub layer transmit error.
MAC Receive Errors	Frames for which reception on an interface fails due to an internal MAC sub layer receive error.
Carrier Sense	Times that the carrier sense condition was lost or never asserted when attempting to transmit a frame.
Frame Too Long	Frames received that exceed the maximum permitted frame size.
Reset Counters	Click Reset Counter to reset the interface and media counter values to zero. The values then update to the current counter values. Reset Counter appears dimmed in the following conditions: <ul style="list-style-type: none"> • The project is offline. • The project is online and a communication error occurred.

Connection Manager Tab

See [Table 8](#) for a description of the Connection Manager properties.

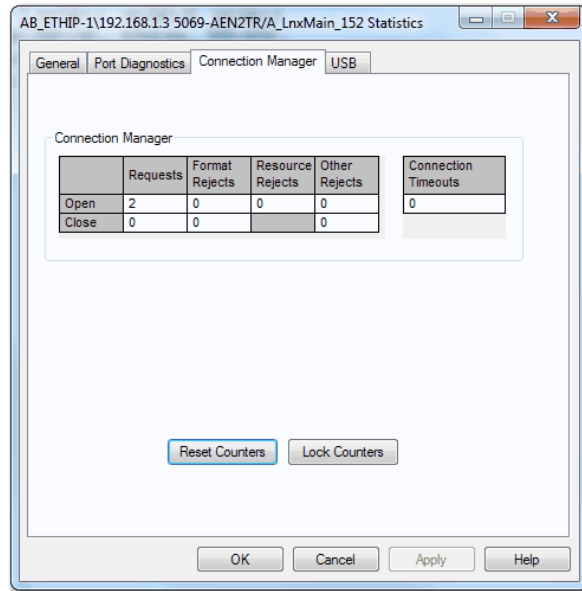

Table 8 - Connection Manager Properties - RSLinx Classic

Field	Description
Requests	Number of open/close connection requests that this module has received.
Format Rejects	Number of open/close connection requests that this module has rejected because the request was not formatted correctly or because some parameter value was not within a supported range of values.
Resource Rejects	Number of open connection requests that this module has rejected because the module did not have enough resources (buffers, link bandwidth, or CPU utilization) to honor the request.
Other Rejects	Number of forwarded open/close connection requests a module rejects.
Timeouts	Number of connections that are not explicitly closed by the connection originator, but closed by this module because they were not being used.

USB Tab

IMPORTANT The 5069-AENTR adapter and FLEX 5000 EtherNet/IP adapters do not have a USB tab because these adapters do not have a USB port.

The USB tab provides the following information about the adapter USB object.

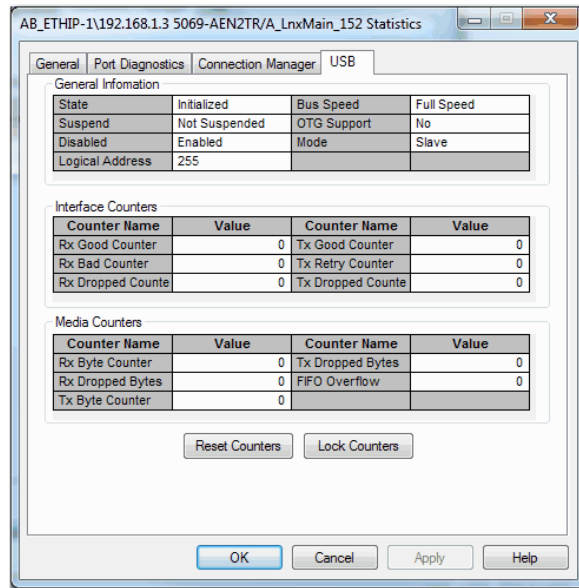

Table 9 - General Information - RSLinx Classic

Attribute Name	Description
State	State (Initializing, Fault, Initialized, Configured, Ready, and Reserved) of the USB interface.
Suspend	The USB interface was suspended by the host.
Disabled	The USB interface was disabled by the host.
Logical Address	Logical address of the USB interface (slot number in the virtual backplane).
Bus Speed	The highest USB bus speed the USB interface supports.
OTG Support	USB On The Go (OTG) capability support.
Mode	The operating mode (slave/host) of the USB interface, if the interface supports OTG.

Table 10 - Interface Counters Provide Diagnostic Information in the USB-CIP Layer - RSLinx Classic

Counter Name	Description
Rx Good Counter	Total number of good USB-CIP transfers received.
Rx Bad Counter	Total number of bad USB-CIP transfers received.
Rx Dropped Counter	Total number of dropped USB-CIP transfers.
Tx Good Counter	Total number of USB-CIP transfers sent.
Tx Retry Counter	Total number of USB-CIP transfers retried.
Tx Dropped Counter	Total number of USB-CIP transfers dropped.

Table 11 - Media Counters - RSLinx Classic

Counter Name	Description
Rx Byte Counter	Total number of bytes received.
Rx Dropped Counter	Total number of received bytes dropped.
Tx Byte Counter	Total number of bytes sent.
Tx Dropped Bytes	Total number of transmit bytes dropped.
FIFO Overflow	Total number of FIFO (First in First Out) overflows.

EtherNet/IP Adapter Diagnostic Web Pages

The adapters provide diagnostic web pages.

IMPORTANT Consider the following:

- The diagnostic web pages have many fields that you can use to monitor the EtherNet/IP adapter operating state. This section describes only the most common fields that are used during monitoring.
To troubleshoot problems that you diagnose, see the Troubleshoot EtherNet/IP Networks Application Technique, publication [ENET-AT003](#).
- You cannot disable the diagnostic web pages for the Compact 5000™ I/O and FLEX 5000 EtherNet/IP adapters.

The diagnostic web pages are available for the adapters whenever the adapters are operating.

The most commonly used diagnostic web pages for the 5069 Compact I/O EtherNet/IP adapters are the following:

- [Diagnostic Overview Page](#)
- [Network Settings](#)
- [Ethernet Statistics](#)
- [Ring Statistics](#)

IMPORTANT The Compact 5000 I/O and FLEX 5000 EtherNet/IP adapters offer other diagnostic web pages. Those web pages are not as commonly used as the other pages described in this section.

Access Web Browser Support

To access the diagnostic web pages, follow these steps.

1. Open your web browser.
2. In the Address field, type the IP address of the adapter and press Enter.

The Home diagnostic web page appears.

EtherNet/IP Module Internet Protocol (IP) Address

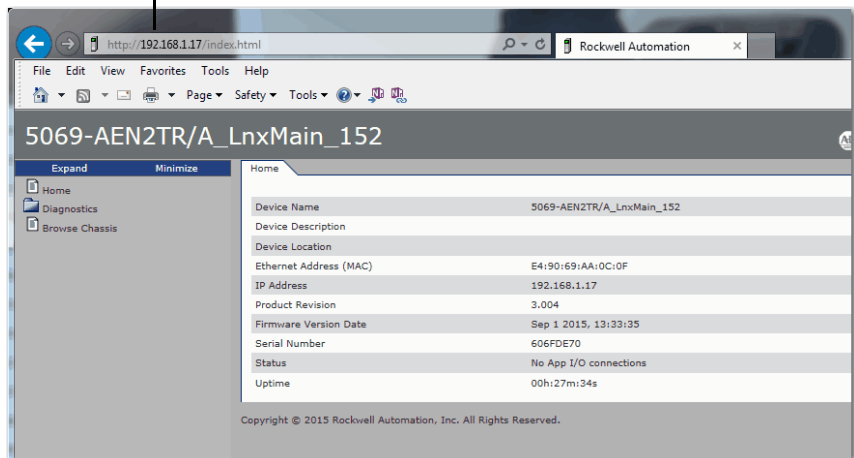

3. Open the Diagnostics folder in the left-most navigation bar, and click the link for each diagnostic web page you must monitor.

Diagnostic Overview Page

The Diagnostic Overview web page shows the status of the adapter.

5069-AEN2TR/A_LnxMain_152 Allen-Bradley **Rockwell Automation**

Expand Minimize

Diagnostic Overview | Network Settings | Application Connections | Bridge Connections | Ethernet Statistics | Ring Statistics

Home
Diagnostics
Diagnostic Overview
Network Settings
Application Connections
Bridge Connections
Ethernet Statistics
Ring Statistics
Advanced Diagnostics
Browse Chassis

Module Resource Utilization (All Ports)	
I/O Comms Utilization (Actual)	0.0 %
I/O Comms Utilization (Theoretical)	0.0 %

CIP Connection Statistics (All Ports)	
Active Total	0
Active Messaging	0
Active I/O	0
Maximum Total Observed	1
Maximum Total Supported	320

TCP Connections (EtherNet/IP Port)	
Active	1
Maximum Observed	1
Maximum Supported	32

HMI/MSG Unconnected (EtherNet/IP Port)	
Sent Packets Per Second	0
Received Packets Per Second	0
Sent Packet Count	224
Received Packet Count	224

HMI/MSG Connected (EtherNet/IP Port)	
Sent Packets Per Second	0
Received Packets Per Second	0
Sent Bytes Per Second	0
Received Bytes Per Second	0
Sent Packet Count	518
Received Packet Count	518

I/O Packets Per Second (EtherNet/IP Port)	
Total	0
Sent	0
Received	0

I/O Packet Counts (EtherNet/IP Port)	
Total	0
Sent	0
Received	0
Rejected	0
Missed	0

Multicast Producers (EtherNet/IP Port)	
Active	0
Maximum Observed	0
Maximum Supported	32
Base Address	239.192.3.0

Seconds Between Refresh: Disable Refresh with 0.

Copyright © 2015 Rockwell Automation, Inc. All Rights Reserved.

Network Settings

The Network Settings diagnostic web page shows the settings for the Network Interface configuration, Ethernet Interface Configuration, and the Ethernet ports.

The screenshot displays the 'Network Settings' diagnostic web page. The page title is '5069-AEN2TR/A_LnxMain_152'. The left sidebar shows a navigation menu with 'Network Settings' selected. The main content area is divided into three sections:

- Network Interface:**

Ethernet Address (MAC)	E4:90:69:AA:0C:0F
IP Address	192.168.1.17
Subnet Mask	255.255.255.0
Default Gateway	
Primary Name Server	
Secondary Name Server	
Default Domain Name	
Host Name	
Name Resolution	DNS Enabled
SMTP Server	
- Ethernet Interface Configuration:**

Obtain Network Configuration	Static
Switches	999
- Ethernet Port 1:**

Interface State	Enabled
Link Status	Active
Speed	1000 Mbps
Duplex	Full Duplex
Autonegotiate Status	Autonegotiate Speed and Duplex
- Ethernet Port 2:**

Interface State	Enabled
Link Status	Inactive
Speed	
Duplex	
Autonegotiate Status	

At the bottom of the main content area, there is a refresh interval setting: 'Seconds Between Refresh: 15' with a 'Disable Refresh with 0.' checkbox.

Copyright © 2015 Rockwell Automation, Inc. All Rights Reserved.

Ethernet Statistics

The Ethernet Statistics diagnostic web page shows the status of communication activity on the Ethernet network. The most commonly monitored fields are described in [Table 12](#).

The screenshot displays the Ethernet Statistics diagnostic web page for a 5069-AENTR/A module. The page is divided into several sections:

- Navigation:** A left sidebar contains a tree view with options: Home, Diagnostics, Diagnostic Overview, Network Settings, Application Connections, Bridge Connections, Ethernet Statistics (selected), Ring Statistics, Advanced Diagnostics, and Browse Chassis. The top navigation bar includes tabs for Diagnostic Overview, Network Settings, Application Connections, Bridge Connections, Ethernet Statistics, and Ring Statistics.
- Ethernet Port 1 Configuration:**
 - Interface State: Enabled
 - Link Status: Active
 - Speed: 1000 Mbps
 - Duplex: Full Duplex
 - Autonegotiate Status: Autonegotiate Speed and Duplex
- Media Counters Port 1:**
 - Alignment Errors: 0
 - FCS Errors: 0
 - Single Collisions: 0
 - Multiple Collisions: 0
 - SQE Test Errors: 0
 - Deferred Transmissions: 0
 - Late Collisions: 0
 - Excessive Collisions: 0
 - MAC Transmit Errors: 0
 - Carrier Sense Errors: 0
 - Frame Too Long: 0
 - MAC Receive Errors: 0
- Interface Counters:**
 - In Octets: 0
 - In Ucast Packets: 0
 - In NUCast Packets: 18
 - In Discards: 0
 - In Packet Drops: 0
 - In Errors: 0
 - In Unknown Protos: 0
 - Out Octets: 11124
 - Out Ucast Packets: 0
 - Out NUCast Packets: 82
 - Out Discards: 0
 - Out Errors: 0
- Ethernet Port 2 Configuration:**
 - Interface State: Enabled
 - Link Status: Inactive
 - Speed: (blank)
 - Duplex: (blank)
 - Autonegotiate Status: (blank)
- Media Counters Port 2:**
 - Alignment Errors: 0
 - FCS Errors: 0
 - Single Collisions: 0
 - Multiple Collisions: 0
 - SQE Test Errors: 0
 - Deferred Transmissions: 0
 - Late Collisions: 0
 - Excessive Collisions: 0
 - MAC Transmit Errors: 0
 - Carrier Sense Errors: 0
 - Frame Too Long: 0
 - MAC Receive Errors: 0

Table 12 - Ethernet Statistic Fields

Field	Specifies
Ethernet Port 1 and Ethernet Port 2	
Interface State	Whether the port is turned off or on. Active or inactive indicates whether there is a cable that is connected.
Link Status	Whether the port is blocked for DLR protocol frames.
Speed	Whether the Ethernet port is operating at 10 Mbps, 100 Mbps, or 1 Gbps.
Duplex	If the Ethernet port is operating at full-duplex mode.
Autonegotiate Status	Whether the port speed and Duplex mode were determined via autonegotiation or whether they were manually configured.
Media Counters Port 1 and Port 2	
Alignment Errors	A frame containing bits that do not total an integral multiple of eight.
FCS Errors	A frame containing eight bits, at least one of which has been corrupted.
Single Collisions	The number of outgoing packets that encountered only one collision during transmission.
Multiple Collisions	The number of outgoing packets that encountered 2 . . . 15 collisions during transmission.
SQE Test Errors	A test to detect the collision-present circuit between a transceiver and a network interface card (NIC). IMPORTANT: Because most NICs now have an integrated transceiver, the SQE test is unnecessary. Ignore this media counter.
Deferred Transmissions	The number of outgoing packets whose transmission is deferred because the network is busy when the first attempt is made to send them.
Late Collisions	The number of times two devices transmit data simultaneously.
Excessive Collisions	The number of frames that experience 16 consecutive collisions.
MAC Transmit Errors	Frames for which transmission fails due to an internal MAC sublayer transmit error.
Carrier Sense Errors	Times that the carrier sense condition was lost or never asserted when attempting to transmit a frame.
Frame Too Long	The number of incoming packets that exceed the maximum Ethernet packet size.
MAC Receive Errors	Frames for which reception on the Ethernet interface failed due to an internal MAC sublayer receive error.
Interface Counters	
In Octets	Octets received on the Ethernet interface
In Ucast Packets	Unicast packets received on the Ethernet interface
In NUCast Packets	Non-unicast packets received on the Ethernet interface
In Discards	Inbound packets received on the Ethernet interface but discarded
In Packet Drops	The number of incoming packet drops on all interfaces, including backplanes, that are caused by overloading one or more adapter CPUs with high network traffic.
In Errors	Inbound packets that contain errors (does not include In Discards)
In Unknown Protos	Inbound packets with unknown protocol
Out Octets	Octets sent on the Ethernet interface
Out Ucast Packets	Unicast packets sent on the Ethernet interface
Out NUCast Packets	Non-unicast packets sent on the Ethernet interface
Out Discards	Outbound packets discarded
Out Errors	Outbound packets that contain errors

Ring Statistics

The Ring Statistics diagnostic web page shows the status of the Device Level Ring.

The screenshot displays the Ring Statistics diagnostic web page for device 5069-AEN2TR/A_LnxMain_152. The interface includes a navigation menu on the left and a main content area with several data sections.

Network

Network Topology	Linear / Star
Network Status	Normal

Ring Supervisor

Ring Supervisor Mode	Disabled
Ring Supervisor Status	No Ring
Ring Protocol Participants Count	0
Ring Faults Detected	0

Ring Advanced Config

Beacon Interval	400
Beacon Timeout	1960
Supervisor Precedence	0
Protocol VLAN ID	0

Ring Fault Location

IP	MAC
Last Active Node on Port 1	0.0.0.0 000000000000
Last Active Node on Port 2	0.0.0.0 000000000000

Active Ring Supervisor

Address	0.0.0.0 000000000000
Precedence	0

Seconds Between Refresh: Disable Refresh with 0.

Copyright © 2015 Rockwell Automation, Inc. All Rights Reserved.

Reset the Adapter

You can reset the adapters to their factory default values. There are differences in the required tasks to reset the adapters.

Reset the 5069-AENTR or a FLEX 5000 EtherNet/IP Adapter

To reset the 5069-AENTR or a FLEX 5000 EtherNet/IP adapter to its default settings, complete the following steps.

1. Power down the adapter.
2. Set the rotary switches to 888.
3. Power up the adapter.
4. Wait for the adapter power-up sequence to complete.

The power-up sequence is complete, and the adapter has returned to its factory default setting when the status indicator states are as follows:

- OK indicator - Flashing red
 - All other indicators - Alternating between red and green
5. Power down the adapter.
 6. Set the rotary switches to the desired address.

IMPORTANT If you do not want to set the IP address via the rotary switches, set them to 999.

After the adapter powers up, set the IP address in one of the methods that are described in [Set the IP Address on the Adapter on page 40](#).

7. Power up the adapter.

Reset the 5069-AEN2TR EtherNet/IP Adapter

You can reset the 5069-AEN2TR EtherNet/IP adapter to its factory default values with the reset button.



ATTENTION: When you reset a module, all connections to or through the module are closed, and can result in loss of control.



WARNING: When you press the reset button while power is on, an electrical arc can occur. This could cause an explosion in hazardous location installations. Be sure that power is removed or the area is nonhazardous before proceeding.

1. Power down the adapter.
2. Open the front door on the adapter.
3. Use a small tool or screwdriver to press and hold the reset button.
4. While holding in the reset button, power up the adapter.
5. Continue to hold the reset button while the 4-character display cycles through TEST, DFLT, 4, 3, 2, 1.
6. Factory Default scrolls one time across the display.
7. Release the reset button.

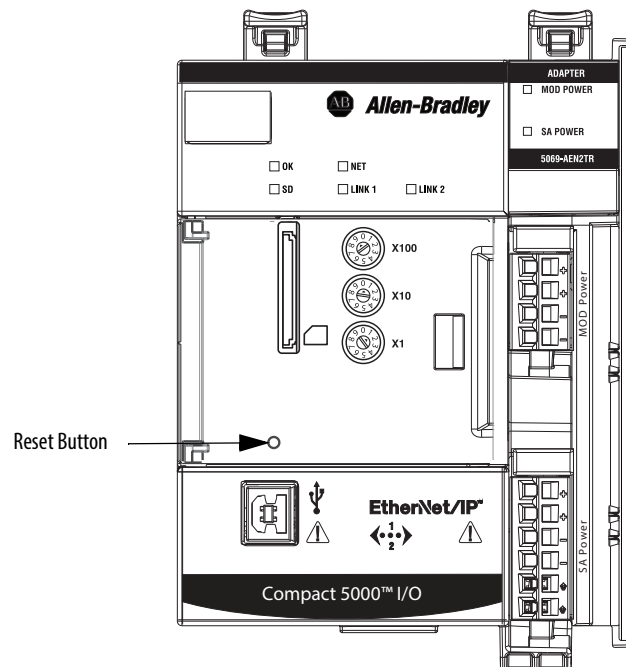

Notes:

EtherNet/IP Communication Module Status Indicators

EtherNet/IP communication modules have multi-character displays and status indicators to assist with performance and diagnostics.

5069-AENTR Adapter Status Indicators

[Figure 11](#) shows the 5069-AENTR adapter status indicators.

Figure 11 - 5069-AENTR Adapter Status Indicators

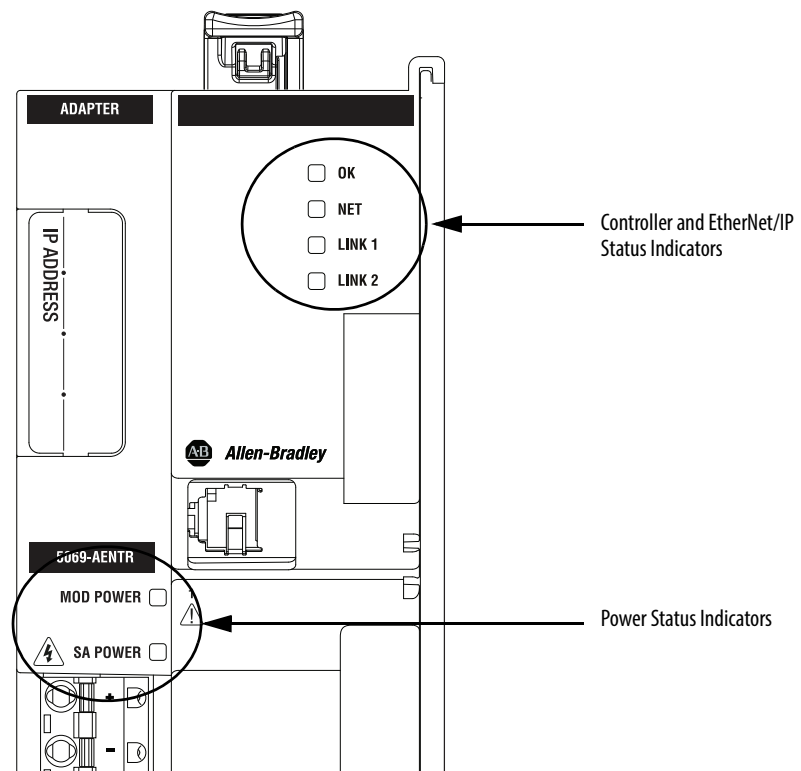

Table 13 describes the 5069-AENTR adapter status indicators.

Table 13 - 5069-AENTR Status Indicators

Indicator	State	Description	Recommended Action
OK	Off	There is no power applied to the device.	Apply power as necessary
	Steady green	The device is operating in a normal condition.	None
	Flashing red	One of the following: <ul style="list-style-type: none"> The device has a recoverable fault. The fault can be read from the diagnostic web pages that are described on page 91. A firmware update is being performed on the device. The adapter has powered up and is in the Factory Default state. In this case, all of the other indicators flash red and green. 	One of the following: <ul style="list-style-type: none"> Cycle power. Wait for the firmware update to finish. Use adapter as necessary. For more information, see Chapter 3, Start to Use the Adapter on page 37.
	Steady red	The device has an unrecoverable fault.	Cycle power. If the fault persists, replace the device.
NET	Off	The device is not configured, or does not have an IP address.	Configure the device or assign an IP address. For more information on how to configure the 5069-AENTR adapter and assign an IP address, see Chapter 3, Start to Use the Adapter on page 37 .
	Flashing green	The device has an IP address, but no active connections are established.	Establish connections as required by the project.
	Steady green	The device has an IP address and at least one established active connection.	None
	Steady red	There is a Duplicate IP Address condition or invalid configuration.	Troubleshoot the issue and remedy the cause. For example, if a Duplicate IP address condition exists, determine which devices on the network use the same IP address and change the IP addresses to unique values.
	Flashing red and green	The device has powered up and is in the Factory Default state. In this case, the OK indicator is flashing red and all of the other indicators flash red and green.	Use adapter as necessary.
LINK1	Off	No activity. One of these conditions exists: <ul style="list-style-type: none"> The module is not powered. The RJ45 cables are properly seated in the adapter and connected devices. No link exists on the port. The port is administratively disabled. 	One of the following: <ul style="list-style-type: none"> If there is no power to the device, complete one of the following: <ul style="list-style-type: none"> Turn on power. Verify that the module RTB is properly seated in the adapter. IMPORTANT: Before you touch the module RTB, verify that power is not applied to the adapter. Once the module RTB is properly seated, turn on power. Verify that the RJ45 cables are properly seated in the adapter and connected devices. If there is power to the device but no link exists, troubleshoot the issue and remedy the cause. If the port is administratively disabled, confirm that is the desired state. If not, use RSLinx Classic software or the Logix Designer application to enable the port.
	Flashing green	Activity exists on the port.	None
	Flashing red and green	The device has powered up and is in the Factory Default state. In this case, the OK indicator is flashing red and all of the other indicators flash red and green.	Use adapter as necessary. For more information, see Chapter 3, Start to Use the Adapter on page 37 .

Table 13 - 5069-AENTR Status Indicators

Indicator	State	Description	Recommended Action
LINK2	Off	<p>No activity. One of these conditions exists:</p> <ul style="list-style-type: none"> The module is not powered. The RJ45 cables are properly seated in the adapter and connected devices. No link exists on the port. The port is administratively disabled. The port is disabled due to rapid ring faults. The port configuration is configured in a manner that can result in issues. For example, the port can be configured to Autonegotiate and the port at the other end of the cable is configured such that Autonegotiate is disabled. 	<p>One of the following:</p> <ul style="list-style-type: none"> If there is no power to the device, complete one of the following: <ul style="list-style-type: none"> Turn on power. Verify that the module RTB is properly seated in the adapter. <p>IMPORTANT: Before you touch the module RTB, verify that power is not applied to the adapter. Once the module RTB is properly seated, turn on power.</p> Verify that the RJ45 cables are properly seated in the adapter and connected devices. If there is power to the device but no link exists, troubleshoot the issue and remedy the cause. If the port is administratively disabled, confirm that is the desired state. If not, use RSLinx Classic software or the Logix Designer application to enable the port. If the port is disabled due to rapid ring faults, troubleshoot the cause of the fault and remedy it. Check configuration for the links at both ends of the cable and verify that they are correct to perform normal operation.
	Flashing green	Activity exists on the port.	None
	Steady green	Adapter is the supervisor of a Device Level Ring network.	None
	Flashing red and green	The device has powered up and is in the Factory Default state. In this case, the OK indicator is flashing red and all of the other indicators flash red and green.	Use adapter as necessary. For more information, see Chapter 3, Start to Use the Adapter on page 37 .
MOD Power	Off	There is no Module Power applied to the device.	Apply MOD Power as necessary
	Steady green	Module Power is present.	None
	Flashing red and green	The device has powered up and is in the Factory Default state. In this case, the OK indicator is flashing red and all of the other indicators flash red and green.	Use adapter as necessary.
SA Power	Off	Status of SA Power is unknown.	Apply SA Power as necessary
	Steady green	SA Power is present.	None
	Flashing red and green	The device has powered up and is in the Factory Default state. In this case, the OK indicator is flashing red and all of the other indicators flash red and green.	Use adapter as necessary.

5069-AEN2TR Adapter Status Indicators

Figure 12 shows the 5069-AEN2TR adapter status indicators.

Figure 12 - 5069-AEN2TR Adapter Status Indicators

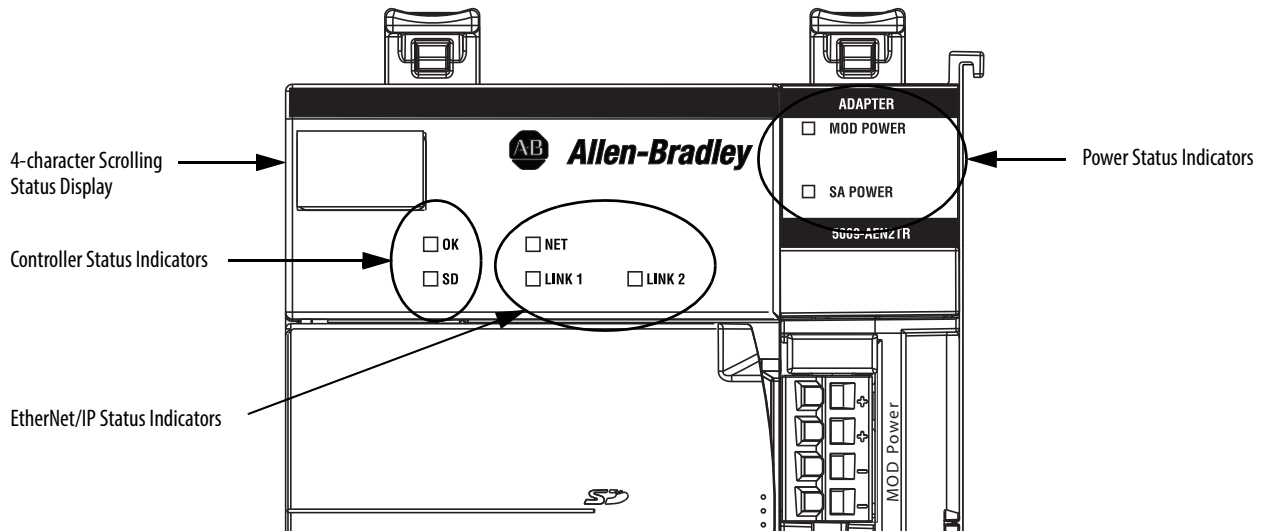

Table 14 describes the 5069-AEN2TR adapter status indicators.

Table 14 - 5069-AEN2TR Status Indicators

Indicator	State	Description	Recommended Action
OK	Off	There is no power applied to the device.	Apply power as necessary
	Steady green	The device is operating in a normal condition.	None
	Flashing red	One of the following: <ul style="list-style-type: none"> The device has a recoverable fault. The fault can be read from the device through the USB or Ethernet ports. A firmware update is being performed on the device. 	One of the following: <ul style="list-style-type: none"> Cycle power. Wait for the firmware update to finish.
	Steady red	The device has an unrecoverable fault.	Cycle power. If the fault persists, replace the device.
SD	Off	There is no activity to the SD card.	None
	Flashing green	The controller is reading from, or writing to the SD card.	None
	Steady red	The SD card does not have a valid file system.	None
NET	Off	The device is not configured, or does not have an IP address.	Configure the device or assign an IP address.
	Flashing green	The device has an IP address, but no active connections are established.	Establish connections as required by the project.
	Steady green	The device has an IP address and at least one established active connection.	None
	Steady red	There is a Duplicate IP Address condition or invalid configuration.	Troubleshoot the issue and remedy the cause. For example, if a Duplicate IP address condition exists, determine which devices on the network use the same IP address and change the IP addresses to unique values.

Table 14 - 5069-AEN2TR Status Indicators

Indicator	State	Description	Recommended Action
LINK1	Off	No activity. One of these conditions exists: <ul style="list-style-type: none"> The module is not powered. The RJ45 cables are properly seated in the adapter and connected devices. No link exists on the port. 	One of the following: <ul style="list-style-type: none"> If there is no power to the device, complete one of the following: <ul style="list-style-type: none"> Turn on power. Verify that the module RTB is properly seated in the adapter. <p>IMPORTANT: Before you touch the module RTB, verify that power is not applied to the adapter. Once the module RTB is properly seated, turn on power.</p> Verify that the RJ45 cables are properly seated in the adapter and connected devices. If there is power to the device but no link exists, troubleshoot the issue and remedy the cause.
	Flashing green	Activity exists on the port.	None
LINK2	Off	No activity. One of these conditions exists: <ul style="list-style-type: none"> The module is not powered. The RJ45 cables are properly seated in the adapter and connected devices. No link exists on the port. The port is administratively disabled. The port is disabled due to rapid ring faults. 	One of the following: <ul style="list-style-type: none"> If there is no power to the device, complete one of the following: <ul style="list-style-type: none"> Turn on power. Verify that the module RTB is properly seated in the adapter. <p>IMPORTANT: Before you touch the module RTB, verify that power is not applied to the adapter. Once the module RTB is properly seated, turn on power.</p> Verify that the RJ45 cables are properly seated in the adapter and connected devices. If there is power to the device but no link exists, troubleshoot the issue and remedy the cause. If the port is administratively disabled, confirm that is the desired state. If the port is disabled due to rapid ring faults, troubleshoot the cause of the fault and remedy it.
	Flashing green	Activity exists on the port.	None
	Steady green	Adapter is the supervisor of a Device Level Ring network.	None
MOD Power	Off	There is no Module Power applied to the device.	Apply MOD Power as necessary
	Steady green	Module Power is present.	None
SA Power	Off	Status of SA Power is unknown.	Apply SA Power as necessary
	Steady green	SA Power is present.	None

[Table 15](#) describe the possible messages on the 4-character display for a 5069-AEN2TR adapter.

Table 15 - Messages on 4-character Display

Message Type	Example Message on 4-character Display	Description
TEST	TEST	Message appears while power-up tests run.
PASS	PASS	Message appears when power-up tests complete.
Embedded software version	Rev 2.003	Message appears once, after the power-up tests complete successfully.
OK	OK	The first message in the scrolling message display. Message scrolls continuously during operation.
Port Down	Link 2 - Port Down	Message appears when an EtherNet/IP port does not have a connection. Message scrolls continuously during operation.
Port Rate/Duplex State	Port 1 - 1Gb/FULL	The current port rate and duplex state. Message scrolls continuously during operation. If not connected to a 1 Gb switch, the message shows 100/FULL.
IP Address	192.168.1.17	The IP address of the adapter. Message scrolls continuously during operation.
Link Disabled	Port 2 - Link Disabled	Message appears when you have disabled an EtherNet/IP port. Message scrolls continuously during operation.
Duplicate IP	Duplicate IP - 00:00:BC:02:34:B4	Message appears when the adapter detects a device with the same IP Address on the network. The message shows the MAC ID of the device with the duplicate IP Address. Message scrolls continuously during operation.
Fault	Cycle power to unit.	Message appears, and scrolls continuously, during a fault.

FLEX 5000 EtherNet/IP Adapter Status Indicators

Figure 13 shows the FLEX 5000 EtherNet/IP adapter status indicators.

Figure 13 - FLEX 5000 EtherNet/IP Adapter Status Indicators

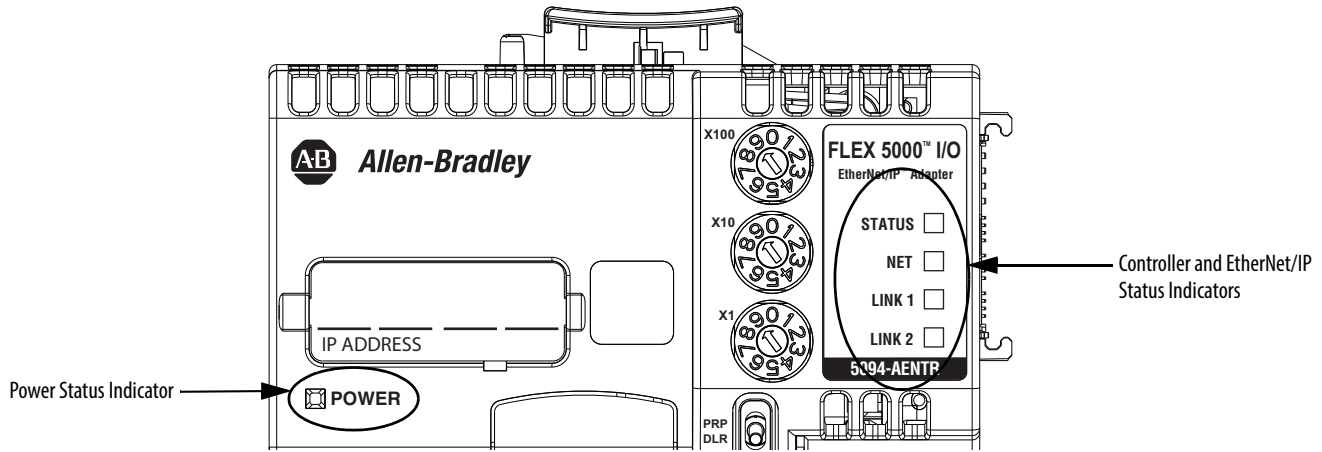

Table 16 describes the FLEX 5000 EtherNet/IP adapter status indicators.

Table 16 - FLEX 5000 EtherNet/IP Adapter Status Indicators

Indicator	State	Description	Recommended Action
STATUS	Off	There is no power applied to the device.	Apply power as necessary
	Flashing green	There is no IP address assigned to or being used by the device.	Set the IP address on the adapter. For more information, see Set the IP Address on the Adapter on page 40 .
	Steady green	The device is operating in a normal condition.	None
	Flashing red	One of the following: <ul style="list-style-type: none"> The device has a recoverable fault. The fault can be read from the diagnostic web pages that are described on page 91. A firmware update is being performed on the device. The adapter has powered up and is in the Factory Default state. In this case, all of the other indicators flash red and green. 	One of the following: <ul style="list-style-type: none"> Cycle power. Wait for the firmware update to finish. Use adapter as necessary. For more information, see Chapter 3, Start to Use the Adapter on page 37.
	Steady red	The device has an unrecoverable fault.	Cycle power. If the fault persists, replace the device.
NET	Off	The device is not configured, or does not have an IP address.	Configure the device or assign an IP address. For more information on how to configure the adapter and assign an IP address, see Chapter 3, Start to Use the Adapter on page 37 .
	Flashing green	The device has an IP address, but no active connections are established.	Establish connections as required by the project.
	Steady green	The device has an IP address and at least one established active connection.	None
	Steady red	There is a Duplicate IP Address condition or invalid configuration.	Troubleshoot the issue and remedy the cause. For example, if a Duplicate IP address condition exists, determine which devices on the network use the same IP address and change the IP addresses to unique values.
	Flashing red and green	The device has powered up and is in the Factory Default state. In this case, the STATUS indicator is flashing red and all of the other indicators flash red and green.	Use adapter as necessary.

Table 16 - FLEX 5000 EtherNet/IP Adapter Status Indicators

Indicator	State	Description	Recommended Action
LINK1	Off	<p>No activity. One of these conditions exists:</p> <ul style="list-style-type: none"> The module is not powered. The RJ45 cables are properly seated in the adapter and connected devices. No link exists on the port. The port is administratively disabled. 	<p>One of the following:</p> <ul style="list-style-type: none"> If there is no power to the device, complete one of the following: <ul style="list-style-type: none"> Turn on power. Verify that the module RTB is properly seated in the adapter. <p>IMPORTANT: Before you touch the module RTB, verify that power is not applied to the adapter. Once the module RTB is properly seated, turn on power.</p> Verify that the RJ45 cables are properly seated in the adapter and connected devices. If there is power to the device but no link exists, troubleshoot the issue and remedy the cause. If the port is administratively disabled, confirm that is the desired state. If not, use RSLinx Classic software or the Logix Designer application to enable the port.
	Flashing green	Activity exists on the port.	None
	Flashing red and green	The device has powered up and is in the Factory Default state. In this case, the STATUS indicator is flashing red and all of the other indicators flash red and green.	Use adapter as necessary. For more information, see Chapter 3, Start to Use the Adapter on page 37 .
LINK2	Off	<p>No activity. One of these conditions exists:</p> <ul style="list-style-type: none"> The module is not powered. The RJ45 cables are properly seated in the adapter and connected devices. No link exists on the port. The port is administratively disabled. The port is disabled due to rapid ring faults. The port configuration is configured in a manner that can result in issues. For example, the port can be configured to Autonegotiate and the port at the other end of the cable is configured such that Autonegotiate is disable. 	<p>One of the following:</p> <ul style="list-style-type: none"> If there is no power to the device, complete one of the following: <ul style="list-style-type: none"> Turn on power. Verify that the module RTB is properly seated in the adapter. <p>IMPORTANT: Before you touch the module RTB, verify that power is not applied to the adapter. Once the module RTB is properly seated, turn on power.</p> Verify that the RJ45 cables are properly seated in the adapter and connected devices. If there is power to the device but no link exists, troubleshoot the issue and remedy the cause. If the port is administratively disabled, confirm that is the desired state. If not, use RSLinx Classic software or the Logix Designer application to enable the port. If the port is disabled due to rapid ring faults, troubleshoot the cause of the fault and remedy it. Check configuration for the links at both ends of the cable and verify that they are correct to perform normal operation.
	Flashing green	Activity exists on the port.	None
	Steady green	Adapter is the supervisor of a Device Level Ring network.	None
	Flashing red and green	The device has powered up and is in the Factory Default state. In this case, the STATUS indicator is flashing red and all of the other indicators flash red and green.	Use adapter as necessary. For more information, see Chapter 3, Start to Use the Adapter on page 37 .

Numerics

4-character display

5069-AEN2TR adapter 106

5069 Compact I/O system

I/O modules 12
 MOD power 16, 18
 power system 16 - 24
 SA power 16, 19 - 24
 track current draw 21

5069-AEN2TR adapter

reset button 99
 status indicators 104 - ??
 4-character display 106
 use SD card 14 - 15

5069-AENTR adapter

Protected Mode 24
 reset tasks 98
 status indicators 101 - 103

5069-FPD field potential distributor

create new SA power bus 22 - 23

A

additional resources 6

B

BOOTP/DHCP

disable with RSLinx Classic software 46

BOOTP/DHCP tool

set network IP address 43 - 45

C

configure

communication drivers 27 - 35
 DHCP server 47
 EtherNet/IP communication driver 29 - 30
 set network IP address 40 - 50
 USB communication driver 33 - 35
 with Logix Designer application 57 - 69
 with RSLinx Classic software ?? - 50, 53 - ??
 workstation 27 - 35

D

Device Level Ring network 73

DHCP server 47

diagnostic web page 95

diagnostics

5069-AENTR adapter reset tasks 98
 access web browser support 92
 adapter web pages 91 - 97
 diagnostic overview web page 93
 Logix Designer application 75 - 84
 connection category 76
 module info category 78
 port configuration category 82

time sync category 84
 network settings web page 94
 ring statistics web page 97
 RSLinx Classic software 86 - 91
 connection manager tab 89
 general tab 86
 port diagnostics tab 87
 USB tab 90
 use to troubleshoot 75 - 99

DNS addressing 52 - 53

domain name 38

drivers

RSLinx Classic software 31 - 32

duplicate address detection 51

E

Ethernet communication driver 29 - 30

Ethernet statistics 95

EtherNet/IP communication driver 29 - 30

EtherNet/IP network

communication driver in RSLinx Classic
 software 31 - 32

example system

5069-AEN2TR adapter 13
 5069-AENTR adapter 13

G

gateway 38

H

host name 38

I

I/O modules

with 5069 Compact EtherNet/IP adapters 12

IP address

definition 38
 duplicate address detection 51
 out-of-box state 40
 set with DHCP server 47
 set with rotary switches 42
 set with RSLinx Classic software 48 - 50

L

Logix Designer application

configure adapter 57 - 69
 diagnostics 75 - 84
 module info category 78
 port configuration category 82
 time sync category 84

M

- memory**
 - SD card 14 - 15
- MOD power** 16, 18
- mode switch** 64
- module diagnostics**
 - use to troubleshoot 75 - 99
- module fault** 76

N

- network parameters**
 - DNS addressing 52 - 53
 - domain name 38
 - gateway 38
 - host name 38
 - IP address 38
 - primary DNS address 38
 - secondary DNS address 38
 - subnet mask 38
- network settings web page** 94

O

- out-of-box state**
 - IP address 40
 - rotary switches 40

P

- power a 5069 Compact I/O system** 16 - 24
 - MOD power 16, 18
 - SA power 16, 19 - 24
 - track current draw 21
- Protected Mode**
 - 5069-AENTR 24

R

- Refresh** 79
- reset button**
 - 5069-AEN2TR adapter 99
- reset tasks**
 - 5069-AENTR adapter 98
- ring statistics web page** 97
- rotary switches** 42
 - out-of-box state 40
 - set IP address 42

RSLinX Classic software

- configure network parameters ?? - 50, 53 - ??
- connection manager tab 89
- diagnostics 86 - 91
- disable BOOTP/DHCP 46
- Ethernet communication driver 29 - 30
- Ethernet devices driver 31 - 32
- general tab 86
- port diagnostics tab 87
- set IP address 48 - 50
- set network IP address 41
- USB communication driver 33 - 35
- USB tab 90

S

- SA power** 16, 19 - 24
 - create new power bus with 5069-FPD field
 - potential distributor 22 - 23
 - track current draw 21
- SD card**
 - with 5069-AEN2TR 14 - 15
- security**
 - Protected Mode
 - 5069-AENTR 24
- set IP address**
 - with RSLinx Classic software ?? - 50, 53 - ??
- set network IP address**
 - BOOTP/DHCP tool 43 - 45
- software**
 - Logix Designer application
 - configure adapter 57 - 69
 - connection category 76
 - diagnostics 75 - 84
 - module info category 78
 - port configuration category 82
 - time sync category 84
 - RSLinX Classic
 - configure network parameters ?? - 50, 53 - ??
 - connection manager tab 89
 - diagnostics 86 - 91
 - Ethernet devices driver 31 - 32
 - general tab 86
 - port diagnostics tab 87
 - USB tab 90
- status indicators**
 - 5069-AEN2TR adapter 104 - ??
 - 4-character display 106
 - 5069-AENTR adapter 101 - 103
- subnet mask** 38

T

- troubleshoot**
 - web browser support 92
 - with adapter diagnostic web pages 91 - 97
 - with module diagnostics 75 - 99

U

- USB communication driver** 33 - 35

W

web browser support 92

Rockwell Automation Support

Use the following resources to access support information.

Technical Support Center	Knowledgebase Articles, How-to Videos, FAQs, Chat, User Forums, and Product Notification Updates.	https://rockwellautomation.custhelp.com/
Local Technical Support Phone Numbers	Locate the phone number for your country.	http://www.rockwellautomation.com/global/support/get-support-now.page
Direct Dial Codes	Find the Direct Dial Code for your product. Use the code to route your call directly to a technical support engineer.	http://www.rockwellautomation.com/global/support/direct-dial.page
Literature Library	Installation Instructions, Manuals, Brochures, and Technical Data.	http://www.rockwellautomation.com/global/literature-library/overview.page
Product Compatibility and Download Center (PCDC)	Get help determining how products interact, check features and capabilities, and find associated firmware.	http://www.rockwellautomation.com/global/support/pcdc.page

Documentation Feedback

Your comments will help us serve your documentation needs better. If you have any suggestions on how to improve this document, complete the How Are We Doing? form at http://literature.rockwellautomation.com/idc/groups/literature/documents/du/ra-du002_-en-e.pdf.

Rockwell Automation maintains current product environmental information on its website at <http://www.rockwellautomation.com/rockwellautomation/about-us/sustainability-ethics/product-environmental-compliance.page>.

Allen-Bradley, Compact I/O, CompactLogix, ControlLogix, FLEX 5000, FactoryTalk, Kinetix, Logix5000, PanelView, PowerFlex, Rockwell Automation, Rockwell Software, RSLinx, Studio 5000, and Studio 5000 Logix Designer are trademarks of Rockwell Automation, Inc.

Trademarks not belonging to Rockwell Automation are property of their respective companies.

Rockwell Otomasyon Ticaret A.Ş., Kar Plaza İş Merkezi E Blok Kat:6 34752 İçerenköy, İstanbul, Tel: +90 (216) 5698400

www.rockwellautomation.com

Power, Control and Information Solutions Headquarters

Americas: Rockwell Automation, 1201 South Second Street, Milwaukee, WI 53204-2496 USA, Tel: (1) 414.382.2000, Fax: (1) 414.382.4444

Europe/Middle East/Africa: Rockwell Automation NV, Pegasus Park, De Kleetlaan 12a, 1831 Diegem, Belgium, Tel: (32) 2 663 0600, Fax: (32) 2 663 0640

Asia Pacific: Rockwell Automation, Level 14, Core F, Cyberport 3, 100 Cyberport Road, Hong Kong, Tel: (852) 2887 4788, Fax: (852) 2508 1846