

ControlNet Network Configuration

1756 ControlLogix, 1756 GuardLogix, 1769 CompactLogix,
1769 Compact GuardLogix, 1789 SoftLogix, Studio 5000 Logix Emulate



Important user information

Read this document and the documents listed in the additional resources section about installation, configuration, and operation of this equipment before you install, configure, operate, or maintain this product. Users are required to familiarize themselves with installation and wiring instructions in addition to requirements of all applicable codes, laws, and standards.

Activities including installation, adjustments, putting into service, use, assembly, disassembly, and maintenance are required to be carried out by suitably trained personnel in accordance with applicable code of practice. If this equipment is used in a manner not specified by the manufacturer, the protection provided by the equipment may be impaired.

In no event will Rockwell Automation, Inc. be responsible or liable for indirect or consequential damages resulting from the use or application of this equipment.

The examples and diagrams in this manual are included solely for illustrative purposes. Because of the many variables and requirements associated with any particular installation, Rockwell Automation, Inc. cannot assume responsibility or liability for actual use based on the examples and diagrams.

No patent liability is assumed by Rockwell Automation, Inc. with respect to use of information, circuits, equipment, or software described in this manual.

Reproduction of the contents of this manual, in whole or in part, without written permission of Rockwell Automation, Inc., is prohibited.

Throughout this manual, when necessary, we use notes to make you aware of safety considerations.



WARNING: Identifies information about practices or circumstances that can cause an explosion in a hazardous environment, which may lead to personal injury or death, property damage, or economic loss.



ATTENTION: Identifies information about practices or circumstances that can lead to personal injury or death, property damage, or economic loss. Attentions help you identify a hazard, avoid a hazard, and recognize the consequence

Important: Identifies information that is critical for successful application and understanding of the product.

Labels may also be on or inside the equipment to provide specific precautions.



SHOCK HAZARD: Labels may be on or inside the equipment, for example, a drive or motor, to alert people that dangerous voltage may be present.



BURN HAZARD: Labels may be on or inside the equipment, for example, a drive or motor, to alert people that surfaces may reach dangerous temperatures.



ARC FLASH HAZARD: Labels may be on or inside the equipment, for example, a motor control center, to alert people to potential Arc Flash. Arc Flash will cause severe injury or death. Wear proper Personal Protective Equipment (PPE). Follow ALL Regulatory requirements for safe work practices and for Personal Protective Equipment (PPE).

Allen-Bradley, Rockwell Software, Rockwell Automation, and TechConnect are trademarks of Rockwell Automation, Inc.

Trademarks not belonging to Rockwell Automation are property of their respective companies.

Summary of Changes

This manual includes new and updated information. Use these reference tables to locate changed information.

Grammatical and editorial style changes are not included in this summary.

Global changes

This table identifies changes that apply to all information about a subject in the manual and the reason for the change. For example, the addition of new supported hardware, a software design change, or additional reference material would result in changes to all of the topics that deal with that subject.

Subject	Reason
Updated screen shots throughout.	The Studio 5000 Logix Designer® interface has been modified in versions 31 and later.

New or enhanced features

None in this release.

Preface	Studio 5000 environment.....	7
	Additional Resources.....	8
	Legal notices.....	8
 Chapter 1		
ControlNet Overview	Use ControlNet Communication Modules in a Control System.....	11
	Bridge Across Networks.....	13
	Exchange Information on a ControlNet Network.....	16
	Network Update Time (NUT).....	17
	Requested Packet Interval (RPI).....	18
	Actual Packet Interval (API).....	18
	Understand the Effect of the NUT on the API.....	18
	Schedule the Network.....	19
	Control of Scheduled I/O.....	19
	Understand the Network Keeper.....	20
	Default Parameters.....	21
	ControlNet Network Capacity and Topology.....	22
	Topology.....	22
	Number of Nodes.....	24
	Lengths.....	24
 Chapter 2		
Connect a Computer to the ControlNet Network	Configure the ControlNet Communication Driver in RSLinx Classic Software.....	28
 Chapter 3		
Configure a ControlNet Module	Use Logix Designer Application.....	31
	Configure the I/O Configuration Tree in Your Project.....	31
	Add and Configure a Local ControlNet Module.....	31
	Add and Configure a Remote ControlNet Module.....	35
	Communication Format.....	36
	Download the Project to the Logix 5000 Controller.....	38
	Electronic Keying.....	40
	Exact Match.....	41
	Compatible Keying.....	42
	Disabled Keying.....	44
	Use RSNetWorx for ControlNet Software.....	46
	Schedule a ControlNet Network for the First Time.....	46
	Schedule the Network Offline.....	47
	Schedule the Network Online.....	52
	Reschedule a ControlNet Network that has Previously been Scheduled.....	56

Chapter 4	
Control I/O	Set Up the Hardware..... 60
	Requested Packet Interval (RPI)..... 60
	Communication Format 60
	Direct or Rack-optimized Connections 62
	Direct Connections for I/O Modules 63
	Rack-optimized Connections for I/O Modules 64
	Ownership 65
	Choose the Type of Ownership for a Module..... 65
	Add a Remote Adapter 66
	Add Distributed I/O 67
	Distributed I/O Communication Formats..... 68
	Access Distributed I/O..... 69
	Validate Connections..... 71
	Chapter 5
Produce and Consume Tags (interlock controllers)	Terminology 75
	Set Up the Hardware..... 76
	Determine Connections for Produced and Consumed Tags 77
	Organize Tags for Produced or Consumed Data 78
	Adjust for Bandwidth Limitations 79
	Produce a Tag 80
	Consume a Tag 83
Chapter 6	
Messaging	Set Up the Hardware..... 87
	Guidelines for MSG Instructions 88
	Determine Connections for Messages 89
	Guidelines for Caching Message Connections..... 90
	Enter Message Logic 90
	Add the ControlNet Modules and Remote Devices to the Local Controller's I/O Configuration..... 90
	Enter a Message 91
	Configure a Message Instruction 92
	Stagger the Messages..... 93
	Chapter 7
Communicate with PanelView Terminals	Set Up the Hardware..... 95
	Determine Connections to PanelView Terminals..... 96
	Add a PanelView Terminal..... 97
	Organize Controller Data for a PanelView Terminal 100

Index

This manual describes how you can use ControlNet communication modules with your Logix 5000™ controller.

Use this manual if you program applications that use a ControlNet network with one of these Logix 5000 controllers:

- CompactLogix controller
- ControlLogix controller
- PowerFlex 700S with DriveLogix controller
- SoftLogix5800 controller

Also be familiar with the following:

- Networking concepts
- Logix Designer software
- FactoryTalk® Linx™ or RSLinx Classic software
- RSNetWorx for ControlNet software

Studio 5000 environment

The Studio 5000 Automation Engineering & Design Environment® combines engineering and design elements into a common environment. The first element is the Studio 5000 Logix Designer® application. The Logix Designer application is the rebranding of RSLogix 5000® software and will continue to be the product to program Logix 5000™ controllers for discrete, process, batch, motion, safety, and drive-based solutions.



The Studio 5000® environment is the foundation for the future of Rockwell Automation® engineering design tools and capabilities. The Studio 5000 environment is the one place for design engineers to develop all elements of their control system.

Additional Resources

These documents contain additional information concerning related products from Rockwell Automation.

Resource	Description
ControlNet Modules Installation Instructions, publication CNET-IN005	Describes how to install 1756-CN2, 1756-CN2R, 1756-CN2RXT, 1756-CNB, 1756-CNBR, 1768-CNB, and 1768-CNBR ControlNet modules.
Industrial Automation Wiring and Grounding Guidelines, publication 1770-4.1	Provides general guidelines for installing a Rockwell Automation industrial system.
Product Certifications website, http://www.ab.com	Provides declarations of conformity, certificates, and other certification details.

You can view or download publications at <http://www.rockwellautomation.com/literature>. To order paper copies of technical documentation, contact your local Rockwell Automation distributor or sales representative.

Legal notices

Copyright notice

Copyright © 2018 Rockwell Automation Technologies, Inc. All Rights Reserved. Printed in USA.

This document and any accompanying Rockwell Software products are copyrighted by Rockwell Automation Technologies, Inc. Any reproduction and/or distribution without prior written consent from Rockwell Automation Technologies, Inc. is strictly prohibited. Please refer to the license agreement for details.

End User License Agreement (EULA)

You can view the Rockwell Automation End-User License Agreement ("EULA") by opening the License.rtf file located in your product's install folder on your hard drive.

Other Licenses

The software included in this product contains copyrighted software that is licensed under one or more open source licenses. Copies of those licenses are included with the software. Corresponding Source code for open source packages included in this product can be located at their respective web site(s).

You may alternately obtain complete Corresponding Source code by contacting Rockwell Automation via our Contact form on the Rockwell Automation website: <http://www.rockwellautomation.com/global/about-us/contact/contact.page>.

Please include "Open Source" as part of the request text.

The following open source software is used in this product:

Software	Copyright	License Name	License Text
AngularJS	Copyright 2010-2017 Google, Inc.	MIT License	AngularJS 1.5.9 License
Bootstrap	Copyright 2011-2017 Twitter, Inc. Copyright 2011-2017 The Bootstrap Authors	MIT License	Bootstrap 3.3.7 License
jQuery	Copyright 2005, 2014 JS Foundation and other contributors	MIT License	jQuery 2.1.1 License
OpenSans	Copyright 2017 Google, Inc.	Apache License, Version 2.0	OpenSans License

Trademark Notices

Allen-Bradley, ControlBus, ControlFLASH, Compact GuardLogix, Compact I/O, ControlLogix, CompactLogix, DCM, DH+, Data Highway Plus, DriveLogix, DPI, DriveTools, Explorer, FactoryTalk, FactoryTalk Administration Console, FactoryTalk Alarms and Events, FactoryTalk Batch, FactoryTalk Directory, FactoryTalk Security, FactoryTalk Services Platform, FactoryTalk View, FactoryTalk View SE, FLEX Ex, FlexLogix, FLEX I/O, Guard I/O, High Performance Drive, Integrated Architecture, Kinetix, Logix5000, Logix 5000, Logix5550, MicroLogix, DeviceNet, EtherNet/IP, PLC-2, PLC-3, PLC-5, PanelBuilder, PowerFlex, PhaseManager, POINT I/O, PowerFlex, Rockwell Automation, RSBizWare, Rockwell Software, RSEmulate, Historian, RSFieldbus, RSLinx, RSLogix, RSNetWorx for DeviceNet, RSNetWorx for EtherNet/IP, RSMACC, RSView, RSView32, Rockwell Software Studio 5000 Automation Engineering & Design Environment, Studio 5000 View Designer, SCANport, SLC, SoftLogix, SMC Flex, Studio 5000, Ultra 100, Ultra 200, VersaView, WINTelligent, XM, SequenceManager are trademarks of Rockwell Automation, Inc.

Any Rockwell Automation logo, software or hardware product not mentioned herein is also a trademark, registered or otherwise, of Rockwell Automation, Inc.

Other Trademarks

CmFAS Assistant, CmDongle, CodeMeter, CodeMeter Control Center, and WIBU are trademarks of WIBU-SYSTEMS AG in the United States and/or other countries. Microsoft is a registered trademark of Microsoft Corporation in the United States and/or other countries. ControlNet is a trademark of ControlNet International. DeviceNet is a trademark of the Open DeviceNet Vendors Association (ODVA). Ethernet/IP is a trademark of ControlNet International under license by ODVA.

All other trademarks are the property of their respective holders and are hereby acknowledged.

Warranty

This product is warranted in accordance with the product license. The product's performance may be affected by system configuration, the application being performed, operator control, maintenance, and other related

factors. Rockwell Automation is not responsible for these intervening factors. The instructions in this document do not cover all the details or variations in the equipment, procedure, or process described, nor do they provide directions for meeting every possible contingency during installation, operation, or maintenance. This product's implementation may vary among users.

This document is current as of the time of release of the product; however, the accompanying software may have changed since the release. Rockwell Automation, Inc. reserves the right to change any information contained in this document or the software at any time without prior notice. It is your responsibility to obtain the most current information available from Rockwell when installing or using this product.

Environmental compliance

Rockwell Automation maintains current product environmental information on its website at

<http://www.rockwellautomation.com/rockwellautomation/about-us/sustainability-ethics/product-environmental-compliance.page>

Contact Rockwell Automation

Customer Support Telephone — 1.440.646.3434

Online Support — <http://www.rockwellautomation.com/support/>

ControlNet Overview

The ControlNet network provides high-speed transmission of time-critical I/O and interlocking data and messaging data. This data transfer capability enhances I/O performance and peer-to-peer communication in any system or application.

The ControlNet network is highly deterministic and repeatable and remains unaffected as devices are connected or disconnected from it. This ensures dependable, synchronized, and coordinated real-time performance.

The ControlNet network is most often used in these ways:

- As the default network for the ControlLogix platform
- As a backbone to multiple distributed DeviceNet networks
- As a peer interlocking network

This chapter describes how you can use ControlNet modules in a network control system.

Topic	Page
Use ControlNet Communication Modules in a Control System on page 11	9 on page 11
Bridge Across Networks on page 13	11 on page 13
Exchange Information on a ControlNet Network on page 16	14 on page 16
ControlNet Network Capacity and Topology on page 22	21 on page 22

Use ControlNet Communication Modules in a Control System

You can fit various ControlNet modules into your control system.

Figure 1 on page 10 shows the following:

- The controllers produce and consume tags among themselves.
- The controllers initiate MSG instructions that send/receive data or configure devices.
- The computer uploads and downloads projects to the controllers.
- The computer configures devices on the ControlNet network and configures the network itself.

Figure 1 - ControlNet Modules and the Control System Overview

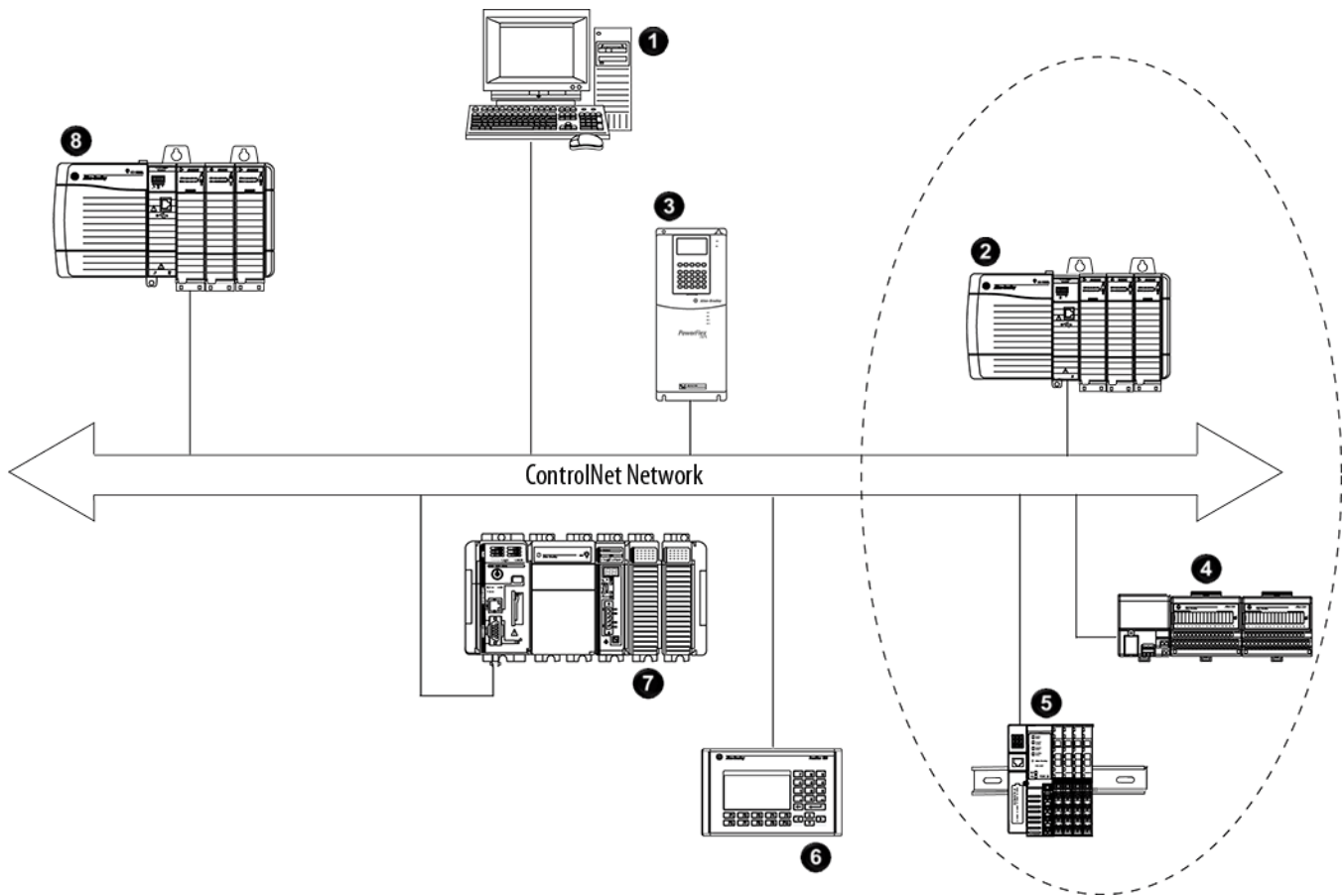

Item	Description
1	Personal computer running SoftLogix5800 controller with 1784-PCICS card
2	1756-CNB module (as an adapter) with 1756 I/O modules
3	PowerFlex 700S drive
4	1794-ACN15 adapter with 1794 I/O modules
5	1734-ACNR adapter with 1734 I/O modules
6	PanelView terminal
7	CompactLogix 1769-L35CR controller with local 1769 I/O modules
8	ControlLogix controller with 1756-CN2, 1756-CN2R, 1756-CNB, or 1756-CNBR module as the scanner

Important: For an enhanced redundancy system, you must use a 1756-CNB, 1756-CNBR, 1756-CN2 series B, or 1756-CN2R series B communication module. The 1756-CN2 or 1756-CN2R series A module does not support enhanced redundancy. For more information, refer to the ControlLogix Enhanced Redundancy System User Manual, publication [1756-UM535](#).

Bridge Across Networks

Some ControlNet modules support the ability to bridge or route communication to and from different networks, depending on the capabilities of the platform and communication devices.

Important: You can only bridge across networks to communicate with devices. You cannot bridge across networks to control I/O, even though Logix Designer software can accept such a configuration in the I/O Configuration folder. All I/O control must originate and end on the same physical network.

The following table describes how communication can bridge across networks.

Table 1 - Bridging Across Networks

A device on this network	Can communicate with a device on this network			
	EtherNet/IP	ControlNet	DeviceNet	RS-232(1)
EtherNet/IP	Yes	Yes	Yes	Yes
ControlNet	Yes	Yes	Yes	Yes
DeviceNet	No	No	Yes	No
RS-232	Yes	Yes(2)	Yes	Yes

In Figure 2, a workstation configures a drive on the DeviceNet network. The workstation bridges from the ControlNet network to the DeviceNet network to reach the drive. The bridge is a ControlLogix chassis with ControlNet and DeviceNet modules.

Figure 2 - Drive Configuration on a DeviceNet Network

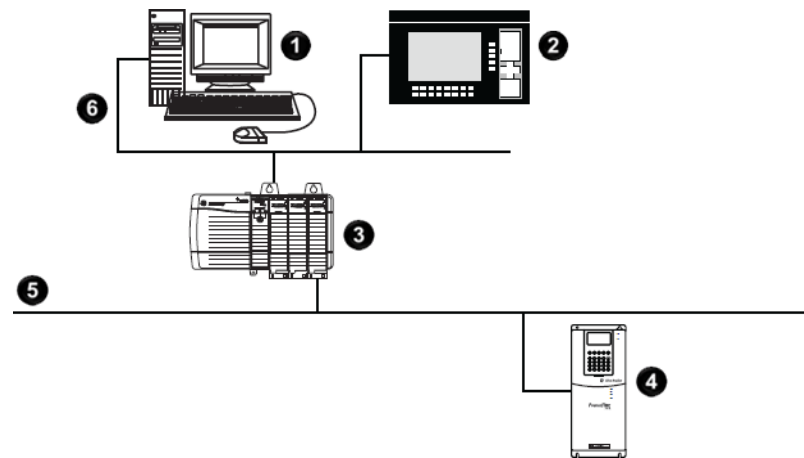

Item	Description	Item	Description
1	Workstation	4	Drive

Item	Description	Item	Description
2	PanelView terminal	5	DeviceNet network
3	Bridge	6	ControlNet network

Important: The performance of a CompactLogix controller on a ControlNet network degrades significantly if you use the controller as a bridge. Target bridging over a CompactLogix controller on a ControlNet network toward applications that are not real-time dependent, such as Logix Designer software program downloads.

In the example shown above, you can transfer messages from the DeviceNet network through the Logix 5000 controller to an RSView32 operator interface. With a CompactLogix controller as a bridge, you can map the data into the DeviceNet I/O image and then use RSLinx OPC to send the data to the Logix 5000 controller over the ControlNet network. This method conserves the limited bridging resources of your CompactLogix controller.

The following example shows how a DeviceNet bridge links to an EtherNet/IP network in RSLinx Classic software.

Figure 3 - EtherNet/IP Bridge Linking to a ControlNet Network

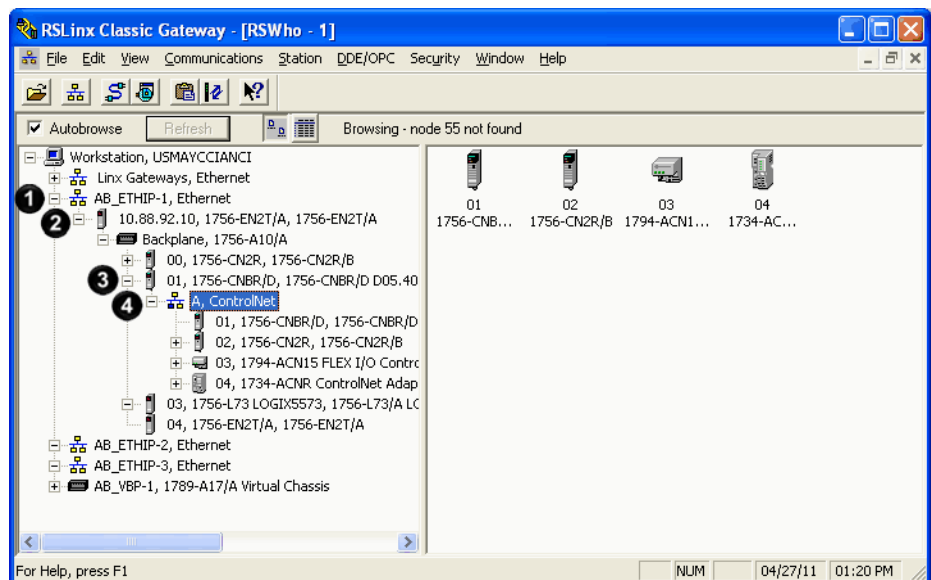

Item	Description	Item	Description
1	EtherNet/IP network	3	ControlNet Bridge in 1756 system
2	EtherNet/IP bridge in 1756 system	4	ControlNet network

The following tables list the possible bridges between communication networks. Note that you can bridge from a ControlNet network to an Ethernet network and from an Ethernet network to a ControlNet via a SoftLogix virtual chassis. However, the products and methods you must use to do so are more detailed than can be effectively described in the following tables. For more information on how to bridge from one network to another via a

SoftLogix virtual chassis, see the *SoftLogix5800 System User Manual*, publication [1789-UM002](#).

Table 2 - Bridges from a ControlNet Network

Destination Network	Modules for a 1768 CompactLogix System	Modules for a 1769 CompactLogix System	Modules for a ControlLogix Chassis
DeviceNet	<ul style="list-style-type: none"> • 1768-L43 or 1768-L45 controller • 1768-CNB(R) module • 1769-SDN scanner 	<ul style="list-style-type: none"> • 1769-L32C or 1769-L35CR controller • 1769-SDN scanner or 1788-CN2DN module(1) 	<ul style="list-style-type: none"> • 1756-CN2 module • 1756-CN2R module • 1756-CNB module • 1756-CNBR module • 1756-DNB module
EtherNet/IP	<ul style="list-style-type: none"> • 1768-L43 or 1768-L45 controller • 1768-CNB(R) module • 1768-ENBT module 	Not applicable	<ul style="list-style-type: none"> • 1756-CN2 module • 1756-CN2R module • 1756-CNB module • 1756-CNBR module • 1756-ENBT module • 1756-EN2T module • 1756-EN2TR module • 1756-EN3TR module

Table 3 - Bridges from an EtherNet/IP Network

Destination Network	Modules for a 1768 CompactLogix System	Modules for a 1769 CompactLogix System	Modules for a ControlLogix Chassis	Modules for a 1769 CompactLogix Packaged Controller System
ControlNet	<ul style="list-style-type: none"> • 1768-L43 or 1768-L45 controller • 1768-ENBT module • 1768-CNB(R) module 	Not applicable	<ul style="list-style-type: none"> • 1756-CN2 module • 1756-CN2R module • 1756-CNB module • 1756-CNBR module • 1756-ENBT module • 1756-EN2T module • 1756-EN2TR module • 1756-EN3TR module 	Not applicable
DeviceNet	<ul style="list-style-type: none"> • 1768-L43 or 1768-L45 controller • 1768-ENBT module • 1769-SDN scanner 	<ul style="list-style-type: none"> • 1769-L32E or 1769-L35E controller • 1769-SDN scanner or 1788-EN2DN module(1) 	<ul style="list-style-type: none"> • 1756-DNB module • 1756-ENBT module • 1756-EN2T module • 1756-EN2TR module • 1756-EN3TR module 	<ul style="list-style-type: none"> • 1769-L23E-QB1B controller • 1769-L23E-QBFC1B controller • 1769-L23-QBFC1B controller • 1769-SDN scanner

Exchange Information on a ControlNet Network

ControlNet communication modules use a message-based protocol that implements a relative path to send a message from the producing module in a system to the consuming modules. This protocol also lets you communicate between devices on a ControlNet, DeviceNet, or EtherNet/IP network without writing additional application code.

With unscheduled data, the device from which a message originates, such as a Logix 5000 controller, contains the path information that makes sure the message reaches its consumers.

For a full explanation of unscheduled and scheduled data, see [Network Update Time \(NUT\) on page 16](#) on [page 17](#).

Because the producing module holds this information, other modules along the path simply pass the information along and do not need to store it. The significant benefits include the following:

- You do not need to configure routing tables in the bridging module, which greatly simplifies maintenance and module replacement.
- You maintain full control over the route taken by each message, which enables you to select alternative paths for the same end module.

Scheduled data in Logix-based systems use the producer/consumer networking model instead of a source/destination (master/slave) model. The producer/consumer model reduces network traffic and increases transmission speed.

In traditional I/O systems, controllers poll input modules to obtain their input status. In a Logix system, digital input modules are not polled by a controller. Instead, they produce (multicast) their data either upon a change of state (COS) or periodically. The frequency of update depends upon the options chosen during configuration and where on the network the input module resides. The input module, therefore, is a producer of input data and the controller is a consumer of the data.

The controller can also produce data for other controllers to consume. The produced and consumed data is accessible by multiple controllers over the Logix backplane and the ControlNet network. This data exchange conforms to the producer/consumer model.

A ControlNet network link's most important function is to transport time-critical control information, such as I/O data and control interlocking. Other information that is not time-critical, such as program uploads and downloads, is also transported but does not interfere with time-critical messages because a ControlNet network can transmit scheduled and unscheduled data.

On a ControlNet network link, nodes transfer information by establishing connections. Each message sent by a producer contains a Connection ID (CID). Nodes that have been configured to recognize the CID consume the message, becoming consumers themselves.

Media access to the network is controlled by a time-slice access algorithm, Concurrent Time Domain Multiple Access (CTDMA), which regulates a node's opportunity to transmit in each network update interval (NUI). You configure how often the NUI repeats by selecting a network update time (NUT) in milliseconds.

Network Update Time (NUT)

The network update time (NUT) is the shortest interval in which data can be sent on a ControlNet network. It represents the fastest possible update rate for scheduled data transfers on that network. For example, a network that runs with a five ms NUT cannot send scheduled data at a rate faster than five ms. It can, however, send data at a slower rate. The minimum NUT you can specify is two ms. The NUT is divided into a three-part structure.

Table 4 - NUT Structure

Parts of NUT	Functions
Scheduled	On a sequential, rotating basis, every scheduled node can transmit data once per NUT. Time-critical information is sent during this part of the interval.
Unscheduled	All nodes transmit on a sequential, rotating basis, the rotation repeating itself until the time allotted for this portion is used up. The number of scheduled transmissions determines the time available for unscheduled transmissions. On a ControlNet network, at least one node can transmit unscheduled data every NUT. Information that can be delivered without time constraints is sent during this part of the interval.
Maintenance	The node with the lowest address transmits information to keep the other nodes synchronized. This time is automatically subtracted from your NUT. However, the time required for network maintenance is brief (microseconds) when compared to that used for the scheduled and unscheduled portions of the NUT.

Figure 4 - NUT Structure

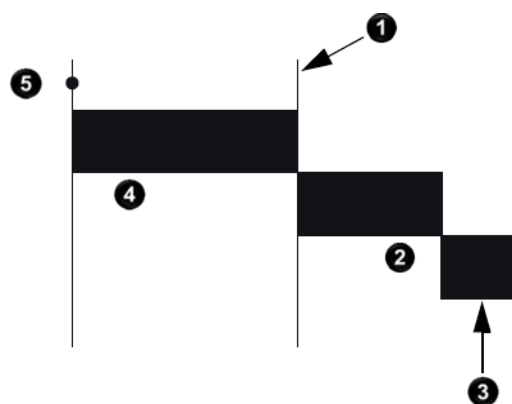

Item	Description
1	Boundary moves according to scheduled traffic load
2	Unscheduled traffic
3	Network maintenance

Item	Description
4	Scheduled traffic. Each device transmits only once
5	Start

Requested Packet Interval (RPI)

The RPI is the update rate specified for a particular piece of data on the network. By using a rack-optimized connection, the RPI can specify the rate for an entire rack of I/O. With a direct connection, the RPI can specify the rate for a particular module or peer-to-peer data. When you add a module to the I/O configuration of a controller, you must configure the RPI, specifying how often to produce data for that module. For example, if you specify an RPI of 50 ms, every 50 ms the I/O module sends its data to the controller or the controller sends its data to the I/O module.

Set the RPI only as fast as needed by the application. The RPI also determines the number of packets per second that the module will handle on a connection. Each module has a limit of how many packets it can handle per second. If you exceed this limit, the module cannot open any more connections.

A faster RPI consumes more network bandwidth. So, to avoid wasting network bandwidth, set the RPI only as fast as is necessary. For example, if your application uses a thermocouple module that has data change every 100 ms, do not set the RPI for that node at 5 ms because the network bandwidth is used to transmit mostly old data.

Important: You cannot set the RPI to a rate faster than the NUT. The network cannot send data at a rate that is faster than the NUT.

When you run RSNetWorx for ControlNet software, an Actual Packet Interval (API) is calculated. The API is equal to or faster than the RPI.

Actual Packet Interval (API)

The API is the actual update rate for a particular piece of data on the network. A ControlNet network sets this rate equal to or faster than the RPI, based on the binary multiple of the NUT, which is the next fastest rate at which a module can send data. If this cannot be done, a ControlNet network provides reports that it cannot support the configuration.

Understand the Effect of the NUT on the API

This example illustrates how the NUT affects the API. A module on the network can produce data only at binary multiples of the NUT to a maximum of the NUT multiplied by 128. These multiples are referred to as rates on a ControlNet network. Therefore, with a NUT of 5 ms, the module can send data at these rates.

Table 5 - NUT Example Data Rates

NUT	Multiple	Rate at Which Module Can Send Data
5 ms	1	5 ms

NUT	Multiple	Rate at Which Module Can Send Data
	2	10 ms
	4	20 ms
	8	40 ms
	16	80 ms
	32	160 ms
	64	320 ms
	128	640 ms

In this example, if you specify an RPI of 25 ms, then the network produces an API of 20 ms, which is the next fastest rate at which the module can send data. The module places the data on the network at every fourth network update interval to produce the 20 ms API. Similarly, if you specify an RPI of 150 ms, the network produces an API of 80 ms.

Schedule the Network

Connections over a ControlNet network can be one of the following:

- Scheduled—Data transferred at specific times.
- Unscheduled—Data transferred when the network can accommodate the transfer.

To use scheduled connections, you must schedule the ControlNet network via RSNetWorx for ControlNet software. For more information on how to schedule a ControlNet network with RSNetWorx for ControlNet software, see the section [Use RSNetWorx for ControlNet Software](#) on [page 46](#) on [page 44](#) on [page 46](#).

You must use RSNetWorx for ControlNet software to enable any connection in a remote chassis. In addition, RSNetWorx software transfers configuration information for the remote modules, verifies and saves NUT and other user-specified network parameters, and establishes a schedule that is compliant with the RPI and other connection options specified for each module.

Important: RSNetWorx for ControlNet software must be run whenever a scheduled connection is added to, removed from, or changed in your system.

Control of Scheduled I/O

Scheduled connections let you send and receive data repeatedly at a predetermined rate. You can use the 1756-CNB or the 1756-CN2 module to control scheduled I/O when you use it in conjunction with a ControlLogix controller. When you place the module in the I/O configuration list of a ControlLogix controller and configure a second ControlLogix chassis with a remote 1756-CNB or 1756-CN2 module on the same ControlNet network, you can perform remote control operations on the I/O, or to a second controller in the second chassis.

Understand the Network Keeper

In this case, the ControlLogix controller and the 1756-CN2 module in the local chassis together act as a scanner, while the 1756-CN2 module in the remote chassis with the I/O plays the role of an adapter.

Every ControlNet network requires at least one module to store programmed parameters for the network and configures the network with those parameters when the module is started. This module is called a keeper because it keeps the network configuration. RSNetWorx for ControlNet software configures the keeper.

To avoid a single point of failure, a ControlNet network supports multiple redundant keepers. These ControlNet communication modules are keeper-capable devices:

- 1756-CN2 and 1756-CN2R modules
- 1756-CNB and 1756-CNBR modules
- 1768-CNB and 1768-CNBR modules
- 1769-L32C and 1769-L35CR controllers
- 1784-PCICS and 1784-PKTCS cards
- 1788-CN x cards
- PLC-5C module

On a multi-keeper network, any keeper-capable module can keep the network at any legal node address (01...99). The multi-keeper-capable node with the lowest node address becomes the active keeper provided it is valid. It has been configured by RSNetWorx for ControlNet software and that configuration is the same as that of the first keeper that became active after the network was formed or reconfigured by RSNetWorx software.

If the active keeper is taken off the network, a valid back-up keeper can take over for it and continue to act as keeper. As long as at least one valid multi-keeper device is present on the network, new scheduled connections can be established.

To review the valid keeper devices on your network, follow this procedure in RSNetWorx for ControlNet software.

1. From the Network menu, choose **Keeper Status**.

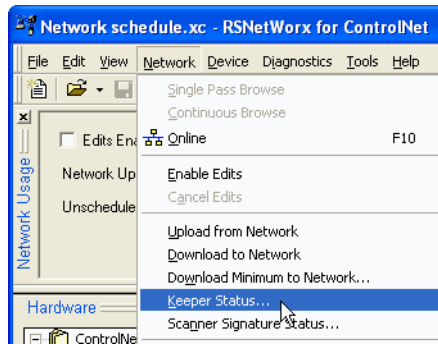

2. Review the keeper devices on the Keeper Status dialog box.

On a typical network, the following must be true:

- There must be only one active valid keeper.
- All other keepers must be valid. If a keeper is not valid, it cannot perform any scheduled communication. However, all unscheduled communication occurs as expected.
- The keeper signature, shown in hex, must be the same for all nodes.

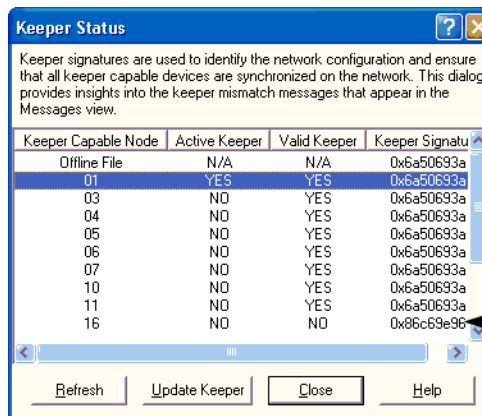

Default Parameters

When a ControlNet network is first established, it relies on a default set of parameters capable of sending only unscheduled data. Default parameters in all ControlNet devices include the following:

- Network Update Time (NUT) = 100 ms
- Scheduled Maximum Node Address (SMAX) = 1

The SMAX is the highest network address of a node that can use the scheduled service.

- Unscheduled Maximum Node Address (UMAX) = 99

The UMAX is the highest network address of a node that can communicate on a ControlNet network. The UMAX must be set equal to or higher than the SMAX.

- Assumed maximum cable lengths and maximum number of repeaters

With this default ControlNet network, you can have unscheduled communication between the various devices on the network by using Logix Designer application and RSLinx software.

Important: To improve performance, configure a ControlNet network with RSNetWorx for ControlNet software. We recommend these settings:

- Set the Unscheduled Maximum Node Address (UMAX) equal to the highest node address on the network. Leaving this parameter at the default value of 99 wastes bandwidth and reduces system performance.
- Set the Scheduled Maximum Node Address (SMAX) to a value three or four above the highest scheduled node address, so you can expand the network in the future.

Also, be aware that each skipped node will subtract a small amount of bandwidth from the network.

ControlNet Network Capacity and Topology

When planning a ControlNet network, consider these factors:

- Topology
- Number of nodes
- Distances
- Connections

Topology

A ControlNet network supports a variety of topologies, including trunkline/dropline, star, tree, and ring redundancy. In its simplest form, a ControlNet network is a trunkline to which you connect nodes with a tap and a one-meter dropline.

Figure 5 - Example ControlNet Network Trunkline/Dropline Topology

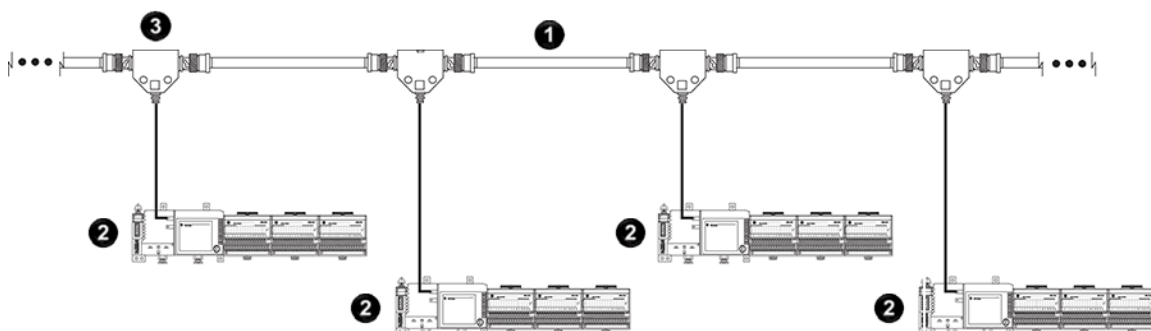

Item	Description
1	Trunkline
2	Node
3	Tap with dropline

Figure 6 - Example ControlNet Network Star Topology

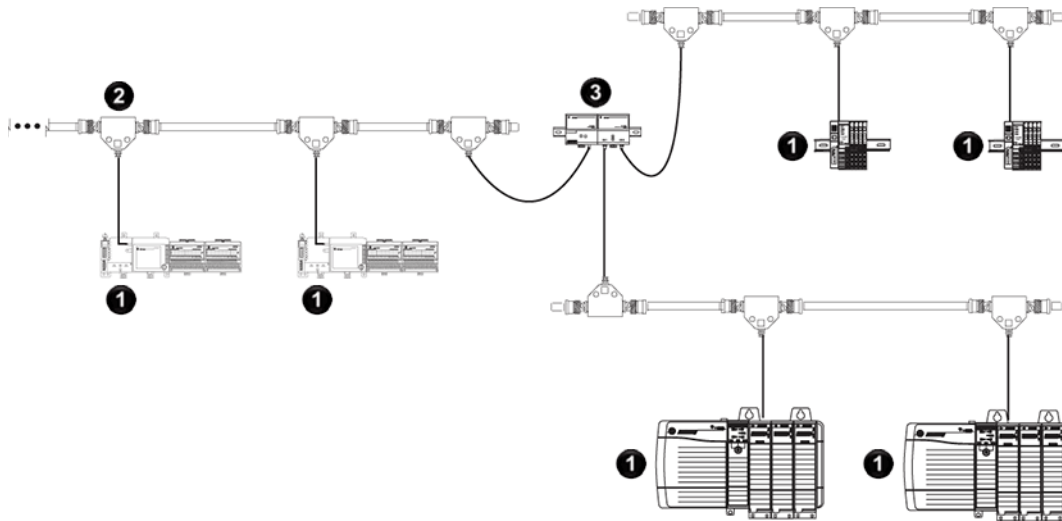

Item	Description
1	Node
2	Tap with 1 m (3.28 ft) dropline
3	Coaxial repeater

Tip: Coax repeaters are typically used in trunkline and star topologies. See the ControlNet Coax Media Planning and Installation Guide, publication [CNET-IN002](#), for more specific information on coax topologies you can create. With fiber media, you can configure your network in trunkline, star, and ring topologies. Only the 1786-RPFRL and 1786-RPFRXL repeaters support a ring topology. For more information, consult the ControlNet Fiber Media Planning and Installation Guide, publication [CNET-IN001](#).

Figure 7 - Example ControlNet Network Ring Topology

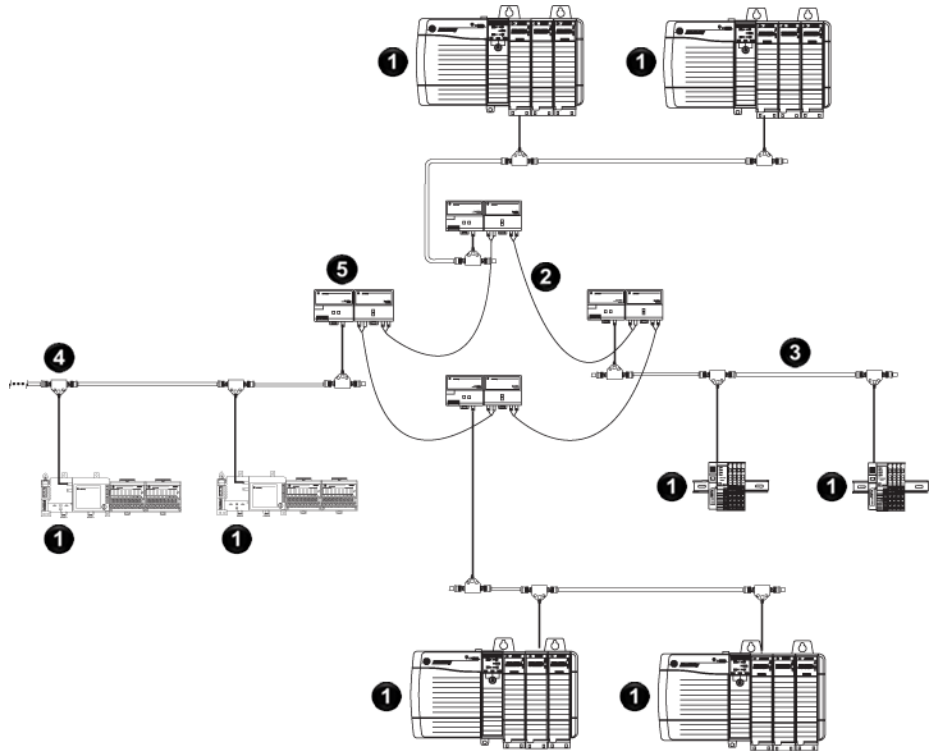

Item	Description
①	Node
②	Fiber cables
③	Coaxial cable
④	Tap with 1 m (3.28 ft) dropline
⑤	ControlNet Repeater Adapter and Fiber Ring Module

Number of Nodes

Each ControlNet network supports up to 99 nodes. Logix 5000 controllers support multiple ControlNet networks, providing the flexibility to add nodes to a ControlNet network or boost performance.

Lengths

In a ControlNet network, the maximum length depends on the number of nodes on a segment; a segment is a section of trunk between two terminators. Use repeaters to add segments or increase length.

Figure 8 - Maximum Length of a ControlNet Network

Maximum Allowable Segment Length = 1000 m (3280 ft) -
16.3 m (53.4 ft) X [Number of Taps - 2]

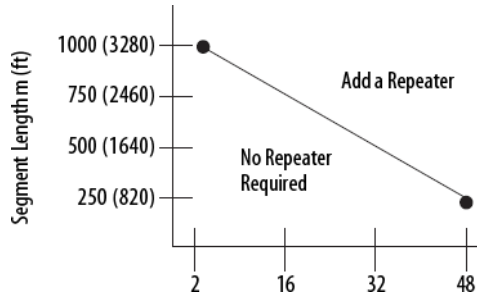

This graph assumes that a 1786-RG6 cable is being used.

Connect a Computer to the ControlNet Network

This chapter explains how to set up a computer to operate on a ControlNet network.

Topic	Page
Configure the ControlNet Communication Driver in RSLinx Classic Software on page 28	26 on page 28

You need to load a ControlNet communication driver for a computer to communicate with other devices on a ControlNet network. A computer uses this driver to do the following:

- Upload and download controller projects over ControlNet using Logix Designer software.
- Schedule the ControlNet network via RSNetWorx for ControlNet software.
- Operate an HMI type application.

Depending on the connection device, you can use one of these drivers:

- 1784-PCIC or 1784-PCICS card—You must configure the driver in RSLinx Classic software, as described on [page 26](#) on [page 28](#).
- USBCIP driver—Use only with a 1784-U2CN USB-to-ControlNet cable. You are **not** required to configure the driver in RSLinx Classic software.

Important: If you are running RSLinx Classic software, version 2.51, 2.52, or 2.53, you must manually install the USBCIP driver. To obtain the driver installation package, refer to answer ID 55431 on the Rockwell Automation Knowledgebase at <http://support.rockwellautomation.com/Knowledgebase>.
If you are running RSLinx Classic software, version 2.54 or later, the USBCIP driver is already installed on the computer.

After preparing the driver for use, connect the card or cable to the computer, and then connect the computer to the network.

Configure the ControlNet Communication Driver in RSLinx Classic Software

To configure a ControlNet communication driver, perform this procedure in RSLinx Classic software.

Important: If you are using a 1794-U2CN cable to connect to the network, you are not required to configure the driver.

1. From the Communications menu, choose **Configure Drivers**.

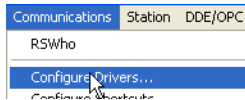

2. From the Available Driver Types pull-down menu, choose a driver for a ControlNet device.

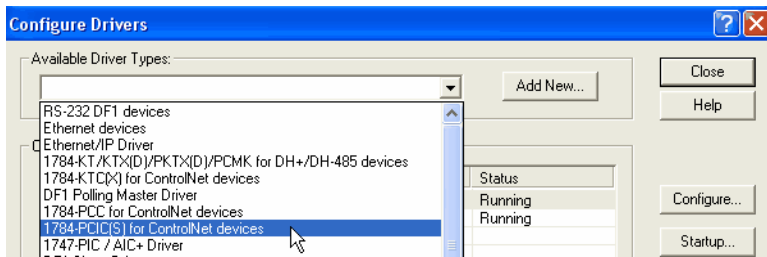

3. Click **Add New**.

The Add New RSLinx Driver dialog box appears. The driver name defaults to AB_xxx.

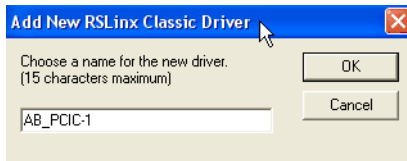

4. Type the name of the new ControlNet driver.
5. Click **OK**.

The Configure Device dialog box appears. The appearance of this screen varies, depending on the type of card used.

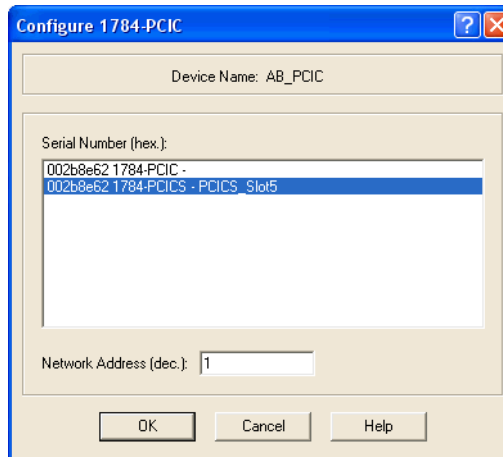

6. If your computer contains multiple cards, from the Serial Number (hex) field, choose the correct card.
7. In the Network Address (dec) box, type the correct network address.
8. Click **OK**.

The driver is now available and you can choose the ControlNet port from Who Active in the Logix Designer application.

Configure a ControlNet Module

This chapter explains how to configure a ControlNet communication module to operate on a ControlNet network.

Topic	Page
Use Logix Designer Software on page 31	29 on page 31
Use RSNetWorx for ControlNet Software on page 46	44 on page 46

Important: The example configuration process shown in this chapter uses a 1756-CN2R/B ControlLogix ControlNet bridge module in a ControlLogix controller project. However, the overall configuration process, described in [Configure the I/O Configuration Tree in Your Project](#) on [page 31](#), generally applies to any of the ControlNet communication modules covered in this manual.

Use Logix Designer Application

Use the Logix Designer application to configure the I/O tree in your project.

Configure the I/O Configuration Tree in Your Project

When you use the Product_Name_RSL5K> application to configure a ControlNet communication module, you must perform these tasks.

1. [Add and Configure a Local ControlNet Module](#) on [page 31](#).
2. [Add and Configure a Remote ControlNet Module](#) on [page 35](#).

Important: There are some differences between configuring a local ControlNet communication module and configuring a remote ControlNet communication module. Those differences are covered later in this chapter.

3. [Download the Project to the Logix 5000 Controller](#) on [page 38](#).

Add and Configure a Local ControlNet Module

After you have started the Logix Designer application and created a controller project, you can add ControlNet communication modules. A local ControlNet module is a module that resides in the same chassis as the controller.

Important: When you create a new Logix Designer project with the CompactLogix 1769-L32C or 1769-L35CR controller, the Controller Organizer creates a ControlNet port in the local chassis. In this case, you do not need to add a separate local communication module.

To add a local ControlNet module, follow this procedure.

1. In the Logix Designer application, expand the I/O Configuration folder, right-click the backplane, and select **New Module**.

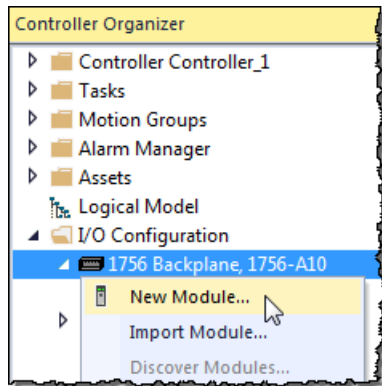

2. On the **Select Module Type** dialog box, type **ControlNet** in the **Enter Search Text for Module Type** box, choose the local ControlNet communication module, and then click **Create**.

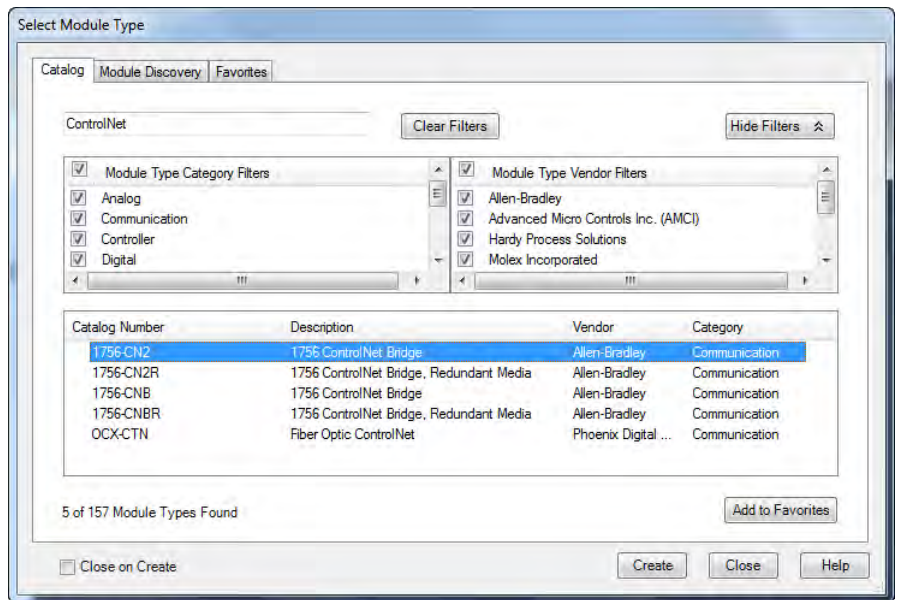

Important: This procedure shows the New Module dialog box for a 1756-CN2R/B. However, various dialogs appear during configuration depending on the ControlNet module you select. For help configuring a module, refer to the online help in the Logix Designer application.

This table lists the ControlNet communication modules available locally in the local chassis, computer, or controller with each Logix 5000 controller.

Table 6 - ControlNet Communication Modules Available Locally

Logix 5000 Controller	Local ControlNet Communication Module
1768 CompactLogix	1768-CNB, 1768-CNBR
1769 CompactLogix	1769-L32C and 1769-L35CR controllers have a built-in ControlNet port
ControlLogix	1756-CN2, 1756-CN2R, 1756-CNB, 1756-CNBR
SoftLogix	1784-PCIC, 1784-PCICS

- Complete the fields on the **New Module** dialog box and then click **OK**.

Field	Action
Name	Type a name for the local ControlNet module.
Node	Enter the module's node number on the network.
Description	Type a description of the local ControlNet module.
Slot	Enter the module's slot number in the chassis.
Revision	Choose a major and minor revision of Logix Designer software.
Electronic Keying	Choose a keying option, as described in Electronic Keying on page 37 on page 40 .

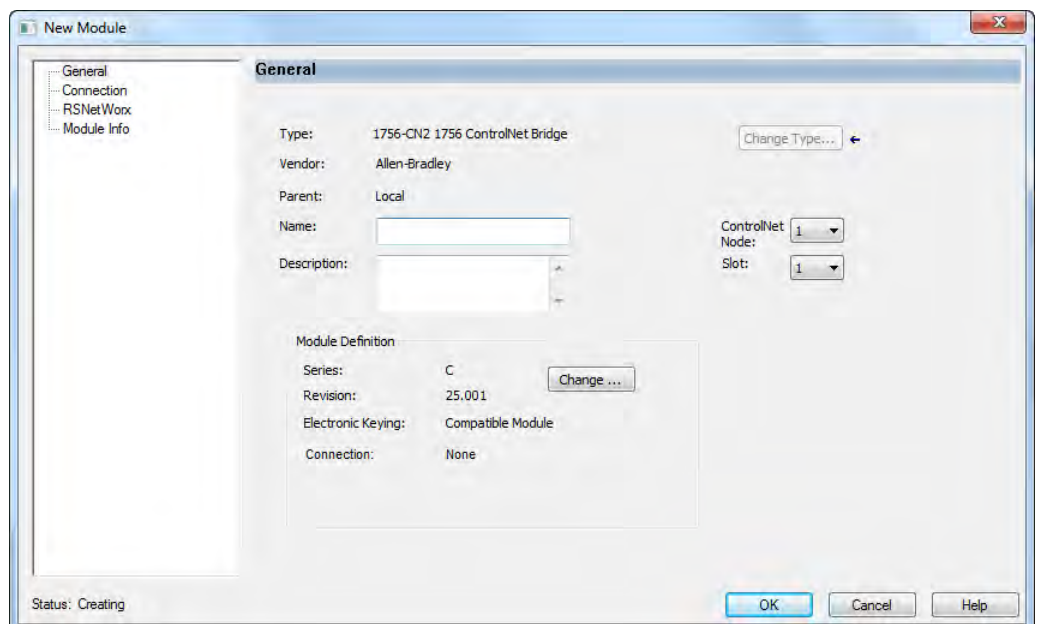

- On the **Module Properties** dialog box, configure the connection properties and then click **Apply**.

Connection Property	Action
Inhibit Module	If the module does not need to communicate with the controller, check the checkbox. or If the module needs to communicate with the controller, leave the checkbox cleared. IMPORTANT: When you test this portion of the system, leave the checkbox cleared.
Major Fault On Controller If Connection Fails While In Run Mode	If you want the controller to produce a major fault if the connection to the local communication module fails in Run mode, check the checkbox. or If you want the controller to continue operating if the connection to the local communication module fails in Run mode, leave the checkbox cleared. Use ladder logic to monitor the connection.

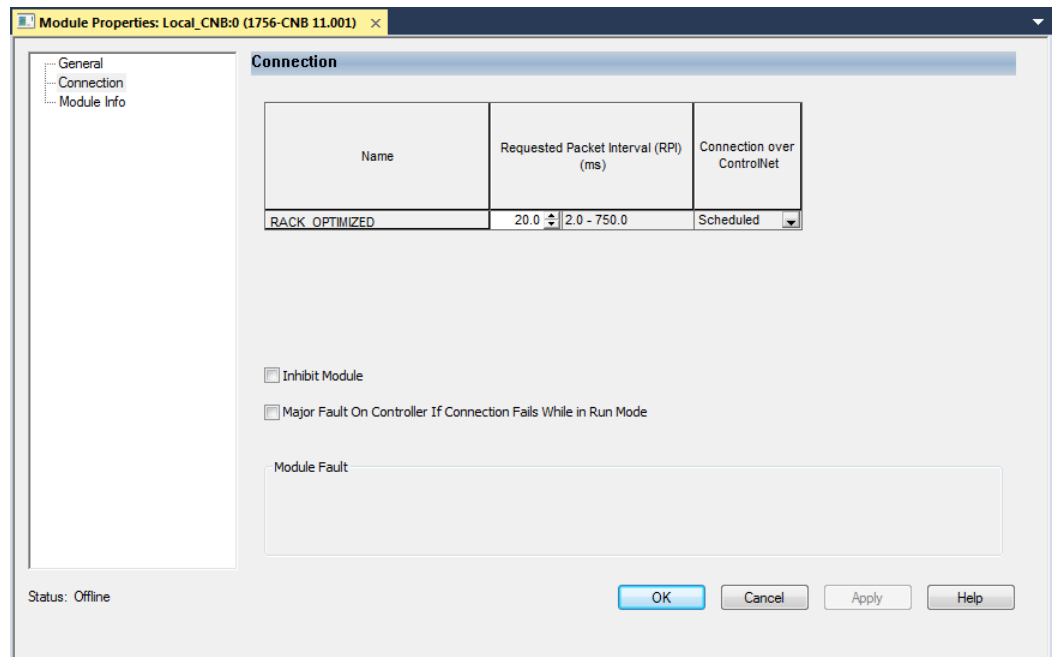

Add and Configure a Remote ControlNet Module

After you have added the local ControlNet communication module, you must add remote ControlNet communication modules. A remote ControlNet module is a module that resides in a chassis separate from the controller.

To add a remote ControlNet module, perform this procedure.

1. In the Logix Designer application, right-click the local ControlNet communication module and choose **New Module**.

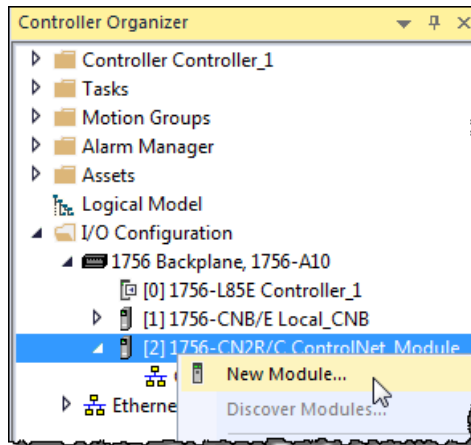

2. On the **Select Module Type** dialog box, type **ControlNet** in the **Enter Search Text for Module Type** box, select a remote ControlNet communication module, and then click **OK**.

You can connect any remote ControlNet communication module to a local ControlNet communication module.

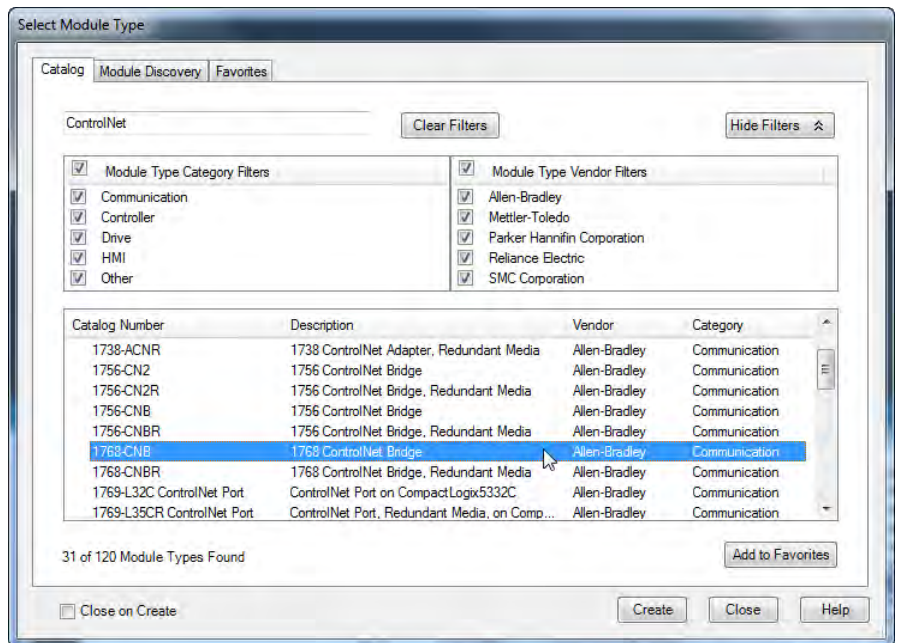

Important: This procedure shows the New Module dialog box for a 1756-CN2. However, various dialogs appear during configuration depending on the ControlNet module you select. For help configuring a module, refer to the online help in the Logix Designer application.

- Complete the fields on the New Module dialog box and then click **OK**.

Field	Action
Name	Type a name for the local ControlNet module.
Node	Enter the module's node number on the network.
Description	Type a description of the local ControlNet module.
Chassis Size	Enter the total number of slots in the chassis.
Comm Format	Choose a communication format, as described in Communication Format on page 60 below. You do not need to assign a communication format for 1784-PCIC, 1784-PCICS, or 1788-CNx cards.
Slot	Enter the module's slot number in the chassis.
Revision	Choose a major and minor revision of Logix Designer software.
Electronic Keying	Choose a keying option, as described in Electronic Keying on page 37 on page 40 .

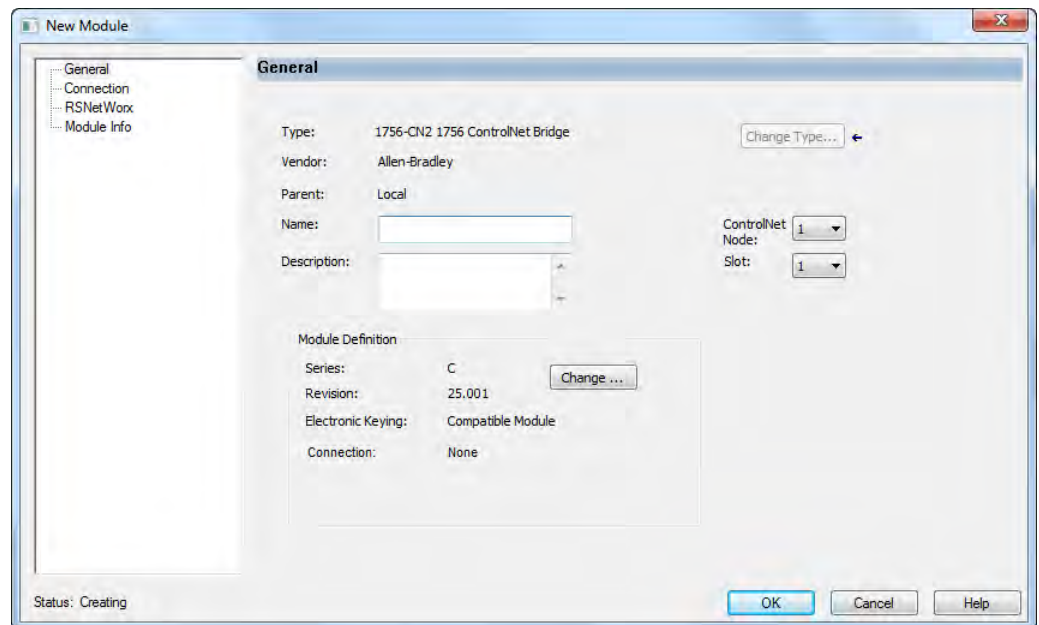

Communication Format

The communication format determines the following:

- What configuration options are available

For example, if the module uses None, then you do not have to configure an RPI rate on the Module Properties dialog box.

- What type of data is transferred between the owner-controller and I/O connected via the communication module

- What tags are generated when configuration is complete
- The type of connection between the owner-controller and the I/O connected via the communication module

The communication format setting also affects the RPI rate.

Table 7 - Communication Formats

Communication Format	Function	Effect on RPI												
Rack-optimized	The communication module creates a rack image and returns I/O data in the rack image to the owner-controller. This option is available only for digital I/O modules. Remember that diagnostic I/O modules will not return diagnostic data when you use this format.	You can specify an RPI that meets this criteria: <ul style="list-style-type: none"> • Equal to or greater than the NUT • In the range permitted by Logix Designer programming software, for example 2...750 ms When you set the RPI for a remote ControlNet communication module, we recommend you use a rate that is a power of two times the NUT. For example, if your NUT = 5 ms, we recommend these RPI values.												
Listen-only rack-optimized (not available on all ControlNet communication modules)	The communication module creates a rack image and returns I/O input data in the rack image to the owner-controller. The difference between this choice and rack-optimized is that the I/O data in the rack image is returned to a controller that does not control the outputs but is listening only to its input data.	<table border="1"> <thead> <tr> <th>NUT = 5m</th> <th>x 2⁰</th> <th>x 2¹</th> <th>x 2²</th> <th>x 2³</th> <th>x 2⁴</th> </tr> </thead> <tbody> <tr> <td>Optimal RPI values</td> <td>5 ms</td> <td>10 ms</td> <td>20 ms</td> <td>40 ms</td> <td>80 r</td> </tr> </tbody> </table>	NUT = 5m	x 2 ⁰	x 2 ¹	x 2 ²	x 2 ³	x 2 ⁴	Optimal RPI values	5 ms	10 ms	20 ms	40 ms	80 r
NUT = 5m	x 2 ⁰	x 2 ¹	x 2 ²	x 2 ³	x 2 ⁴									
Optimal RPI values	5 ms	10 ms	20 ms	40 ms	80 r									
None	No RPI is required.	The RPI field is dimmed.												

4. On the Module Properties dialog box, configure the connection properties and then click **Apply**.

Connection Property	Action
Requested Packet Interval (RPI)	Type the requested packet interval between 2.0...750.0 ms. If your module uses one of the rack-optimized communication formats, the RPI must be equal to or greater than the ControlNet Network Update Time (NUT).
Inhibit Module	If the module does not need to communicate with the controller, check the checkbox. or If the module needs to communicate with the controller, leave the checkbox cleared. IMPORTANT: When you test this portion of the system, leave the checkbox cleared.
Major Fault On Controller If Connection Fails While In Run Mode	If you want the controller to produce a major fault if the connection to the local communication module fails in Run mode, check the checkbox. or If you want the controller to continue operating if the connection to the local communication module fails in Run mode, leave the checkbox cleared. Use ladder logic to monitor the connection.

Connection Property	Action
Use Scheduled Connection over ControlNet	<p>Check the box if you want to explicitly schedule the network connection. Note the following:</p> <ul style="list-style-type: none"> • The checkbox is enabled when the connection for the module crosses ControlNet and the module supports unscheduled connections. • The checkbox is checked and disabled when the connection to the module crosses ControlNet, and the module does not support unscheduled connections, and therefore, must be scheduled. • The checkbox is cleared and disabled when the connection to the module does not cross ControlNet, or the connection crosses ControlNet but does not need to be scheduled.

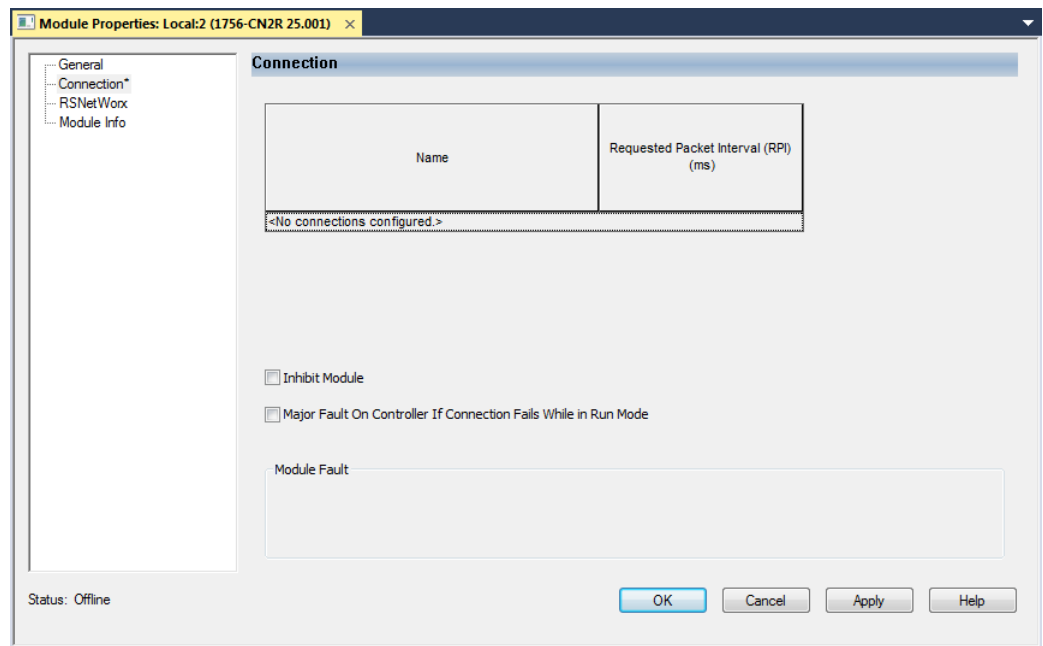

Download the Project to the Logix 5000 Controller

When you have added the local and remote ControlNet communication modules to your Logix Designer project, download the new configuration to your Logix 5000 controller.

- Important:** Before you download your Logix Designer project to your ControlNet modules, consider whether you will schedule the ControlNet network offline or online:
- If you are going to schedule the network offline, complete the procedure in the section [Schedule the Network Offline on page 45](#) on [page 47](#).
 - If you are going to schedule the network online, complete the procedure in this section and then proceed to the section [Schedule the Network Online on page 49](#) on [page 52](#).

To download a project to a Logix 5000 controller, follow this procedure.

1. Because you must schedule the ControlNet network before by using the new configuration, switch your Logix 5000 controller to Program mode using one of these methods:
 - Turn the controller keyswitch to PROG.
 - Turn the controller keyswitch to REM and use Logix Designer software.
2. In the Logix Designer application, from the Communications menu, choose **Who Active**.

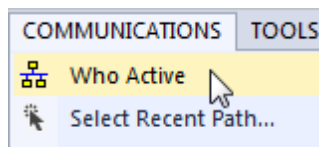

3. From the **Who Active** dialog box, browse to and select the controller to which to download a project and click **Download**.

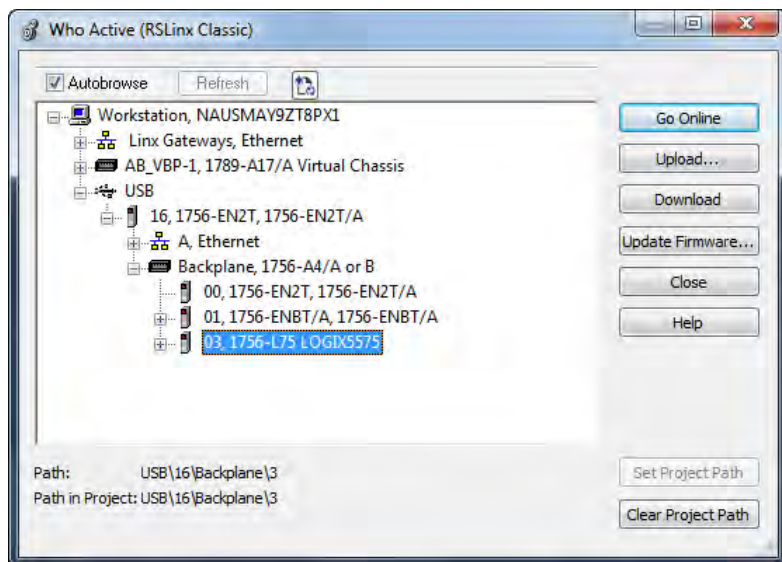

4. When the Download dialog box appears, click **Download**.

Electronic Keying

Electronic Keying reduces the possibility that you use the wrong device in a control system. It compares the device defined in your project to the installed device. If keying fails, a fault occurs.

The following attributes are compared:

Attribute	Description
Vendor	The device manufacturer.
Device Type	The general type of the device, for example, digital I/O module.
Product Code	The specific type of device. The Product Code maps to a catalog number.
Major Revision	A number that represents the functional capabilities of a device.
Minor Revision	A number that represents behavior changes in the device.

The following **Electronic Keying** options are available:

Keying Option	Description
Compatible Module	<p>Lets the installed device accept the key of the device that is defined in the project when the installed device can emulate the defined device. With Compatible Module, you can typically replace a device with another device that has the following characteristics:</p> <ul style="list-style-type: none"> • Same catalog number • Same or higher Major Revision • Minor Revision as follows: <ul style="list-style-type: none"> • If the Major Revision is the same, the Minor Revision must be the same or higher. • If the Major Revision is higher, the Minor Revision can be any number.
Disable Keying	<p>Indicates that the keying attributes are not considered when attempting to communicate with a device. With Disable Keying, communication can occur with a device other than the type specified in the project.</p> <p>ATTENTION: Be extremely cautious when using Disable Keying; if used incorrectly, this option can lead to personal injury or death, property damage, or economic loss.</p> <p>We strongly recommend that you do not use Disable Keying.</p> <p>If you use Disable Keying, you must take full responsibility for understanding whether the device being used can fulfill the functional requirements of the application.</p>
Exact Match	<p>Indicates that all keying attributes must match to establish communication. If any attribute does not match precisely, communication with the device does not occur.</p>

Carefully consider the implications of each keying option when selecting one.

Important: Changing Electronic Keying parameters online interrupts connections to the device and any devices that are connected through the device. Connections from other controllers can also be broken.
If an I/O connection to a device is interrupted, the result can be a loss of data.

Exact Match

Exact Match keying requires all keying attributes, that is, Vendor, Product Type, Product Code (catalog number), Major Revision, and Minor Revision, of the physical module and the module created in the software to match precisely in order to establish communication. If any attribute does not match precisely, I/O communication is not permitted with the module or with modules connected through it, as in the case of a communication module.

Use Exact Match keying when you need the system to verify that the module revisions in use are exactly as specified in the project, such as for use in highly-regulated industries. Exact Match keying is also necessary to enable Automatic Firmware Update for the module via the Firmware Supervisor feature from a Logix 5000 controller.

Example In the following scenario, Exact Match keying prevents I/O communication.

The module configuration is for a 1756-IB16D module with module revision 3.1. The physical module is a 1756-IB16D module with module revision 3.2. In this case, communication is prevented because the Minor Revision of the module does not match precisely.

Module Configuration:

Vendor = Allen-Bradley
 Product Type = Digital Input Module
 Catalog Number = 1756-IB16D
 Major Revision = 3
Minor Revision = 1

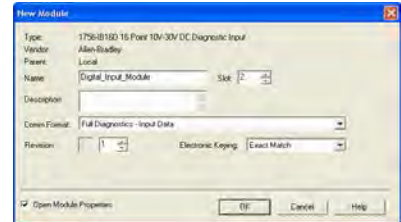

Communication is prevented.

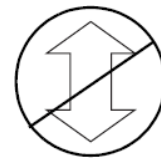

Physical Module:

Vendor = Allen-Bradley
 Product Type = Digital Input Module
 Catalog Number = 1756-IB16D
 Major Revision = 3
Minor Revision = 2

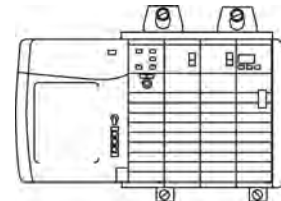

Important: Changing electronic keying selections online may cause the I/O Communication connection to the module to be disrupted and may result in a loss of data.

Compatible Keying

Compatible Keying indicates that the module determines whether to accept or reject communication. Different module families, communication adapters, and module types implement the compatibility check differently based on the family capabilities and on prior knowledge of compatible products.

Compatible Keying is the default setting. Compatible Keying allows the physical module to accept the key of the module configured in the software, provided that the configured module is one the physical module is capable of

emulating. The exact level of emulation required is product and revision specific.

With Compatible Keying, you can replace a module of a certain Major Revision with one of the same catalog number and the same or later, that is higher, Major Revision. In some cases, the selection makes it possible to use a replacement that is a different catalog number than the original. For example, you can replace a 1756-CNBR module with a 1756-CN2R module. Release notes for individual modules indicate the specific compatibility details.

When a module is created, the module developers consider the module’s development history to implement capabilities that emulate those of the previous module. However, the developers cannot know future developments. Because of this, when a system is configured, we recommend that you configure your module by using the earliest, that is, lowest, revision of the physical module that you believe will be used in the system. By doing this, you can avoid the case of a physical module rejecting the keying request because it is an earlier revision than the one configured in the software.

Example

In the following scenario, **Compatible Keying prevents I/O communication:**

The module configuration is for a 1756-IB16D module with module revision 3.3. The physical module is a 1756-IB16D module with module revision 3.2. In this case, communication is prevented because the minor revision of the module is lower than expected and may not be compatible with 3.3.

Module Configuration:

- Vendor = Allen-Bradley
- Product Type = Digital Input Module
- Catalog Number = 1756-IB16D
- Major Revision = 3
- Minor Revision = 3**



Communication is prevented.

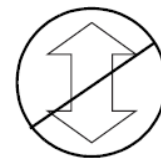

Physical Module:

- Vendor = Allen-Bradley
- Product Type = Digital Input Module
- Catalog Number = 1756-IB16D
- Major Revision = 3
- Minor Revision = 2**

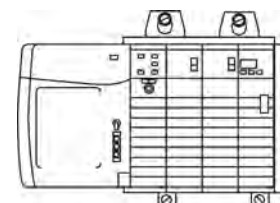

Example

In the following scenario, **Compatible Keying allows I/O communication**: The module configuration is for a 1756-IB16D module with module revision 2.1. The physical module is a 1756-IB16D module with module revision 3.2. In this case, communication is allowed because the major revision of the physical module is higher than expected and the module determines that it is compatible with the prior major revision.

Module Configuration:

Vendor = Allen-Bradley

Product Type = Digital Input Module

Catalog Number = 1756-IB16D

Major Revision = 2

Minor Revision = 1

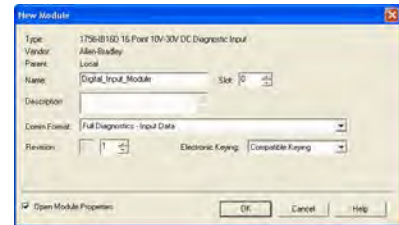

Communication is allowed.

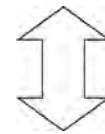
**Physical Module:**

Vendor = Allen-Bradley

Product Type = Digital Input Module

Catalog Number = 1756-IB16D

Major Revision = 3

Minor Revision = 2

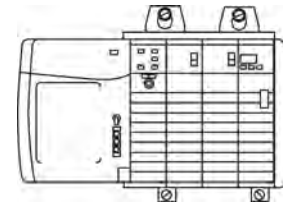

Important: Changing electronic keying selections online may cause the I/O communication connection to the module to be disrupted and may result in a loss of data.

Disabled Keying

Disabled Keying indicates the keying attributes are not considered when attempting to communicate with a module. Other attributes, such as data size and format, are considered and must be acceptable before I/O communication is established. With Disabled Keying, I/O communication may occur with a module other than the type specified in the I/O Configuration tree with unpredictable results. We generally do not recommend using Disabled Keying.



ATTENTION: Be extremely cautious when using Disabled Keying; if used incorrectly, this option can lead to personal injury or death, property damage, or economic loss.

If you use Disabled Keying, you must take full responsibility for understanding whether the module being used can fulfill the functional requirements of the application.

Example

In the following scenario, **Disable Keying prevents I/O communication:**

The module configuration is for a 1756-IA16 digital input module. The physical module is a 1756-IF16 analog input module. In this case, communication is prevented because the analog module rejects the data formats that the digital module configuration requests.

Module Configuration:

Vendor = Allen-Bradley
 Product Type = Digital Input Module
 Catalog Number = 1756-IA16
Major Revision = 3
Minor Revision = 1



Communication is prevented.

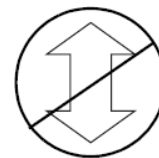

Physical Module:

Vendor = Allen-Bradley
 Product Type = Analog Input Module
 Catalog Number = 1756-IF16
Major Revision = 3
Minor Revision = 2

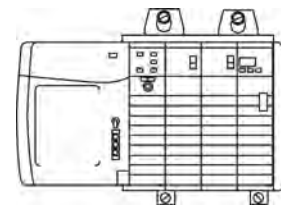

Example

In the following scenario, **Disable Keying allows I/O communication:**

The module configuration is for a 1756-IA16 digital input module. The physical module is a 1756-IB16 digital input module. In this case, communication is allowed because the two digital modules share common data formats.

Module Configuration:

Vendor = Allen-Bradley
 Product Type = Digital Input Module
 Catalog Number = 1756-IA16
Major Revision = 2
Minor Revision = 1

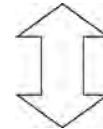

Communication is allowed.

**Physical Module:**

Vendor = Allen-Bradley
 Product Type = Digital Input Module
 Catalog Number = 1756-IB16
Major Revision = 3
Minor Revision = 2

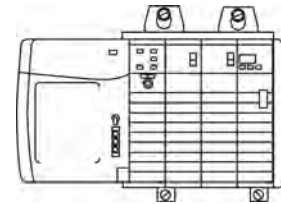

Important: Changing electronic keying selections online may cause the I/O communication connection to the module to be disrupted and may result in a loss of data.

Use RSNetWorx for ControlNet Software

You must use RSNetWorx for ControlNet software to schedule the network in order to activate the configured I/O devices in your application. You must also reschedule the network if a change is made to an already-scheduled network.

Schedule a ControlNet Network for the First Time

RSNetWorx for ControlNet software stores information in keeper devices. These ControlNet communication modules are keeper-cable devices:

- 1756-CN2 and 1756-CN2R modules
- 1756-CNB and 1756-CNBR modules
- 1768-CNB and 1768-CNBR module
- 1769-L32C and 1769-L35CR controllers

- 1784-PCICS and 1784-PKTCS cards

If you configure a keeper on one network and then use it on another network, the conflicting information can make it difficult to use RSNetWorx for ControlNet software to schedule the new network. In extreme cases, it may be difficult to go online:

- For more information on the network keeper, see the section [Understand the Network Keeper](#) on [page 20](#) on [page 19](#) on [page 20](#).
- For more information on how to reset valid keepers to an unconfigured state to resolve mismatches, refer to the RSNetWorx for ControlNet software online help.
- For more information on how to clear the memory or keeper information in a ControlNet communication module, refer to the Knowledgebase at <http://www.rockwellautomation.com/support>.

Schedule the Network Offline

Scheduling a project offline is most useful in the design phase of your project. Scheduling off line can be used to predict performance and measure bandwidth.

Tip: To learn more about using Logix Designer and RSNetWorx software offline to predict performance, refer to answer ID 54793 on the Rockwell Automation Knowledgebase at <http://support.rockwellautomation.com/Knowledgebase>.

Before scheduling a network offline, make sure of the following:

- Your Logix Designer software project uses one controller and one network. We recommend that you use only one 1756-CN2, 1756-CNB, or 1768-CNB module in the local chassis when scheduling the network offline.
- Your Logix Designer software project is complete but has not been downloaded to the controller.

If your network has already been scheduled and you made a change to it, you must reschedule it. For more information, refer to [Reschedule a ControlNet Network that has Previously been Scheduled on page 53](#) on [page 56](#).

To schedule a network offline, perform this procedure.

1. In your Logix Designer software project, right-click your local ControlNet module and choose **Properties**.

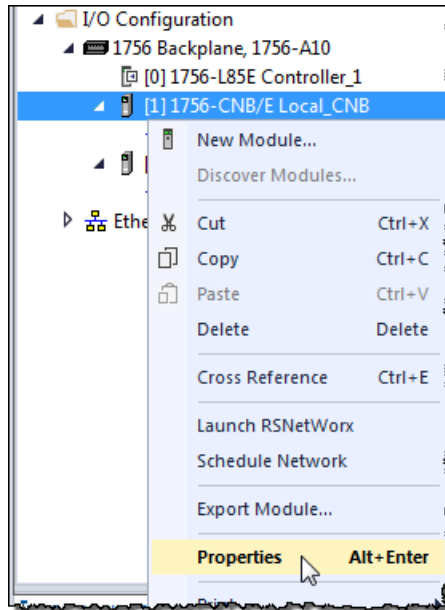

2. From the Module Properties dialog box, click the **RSNetWorx** tab.

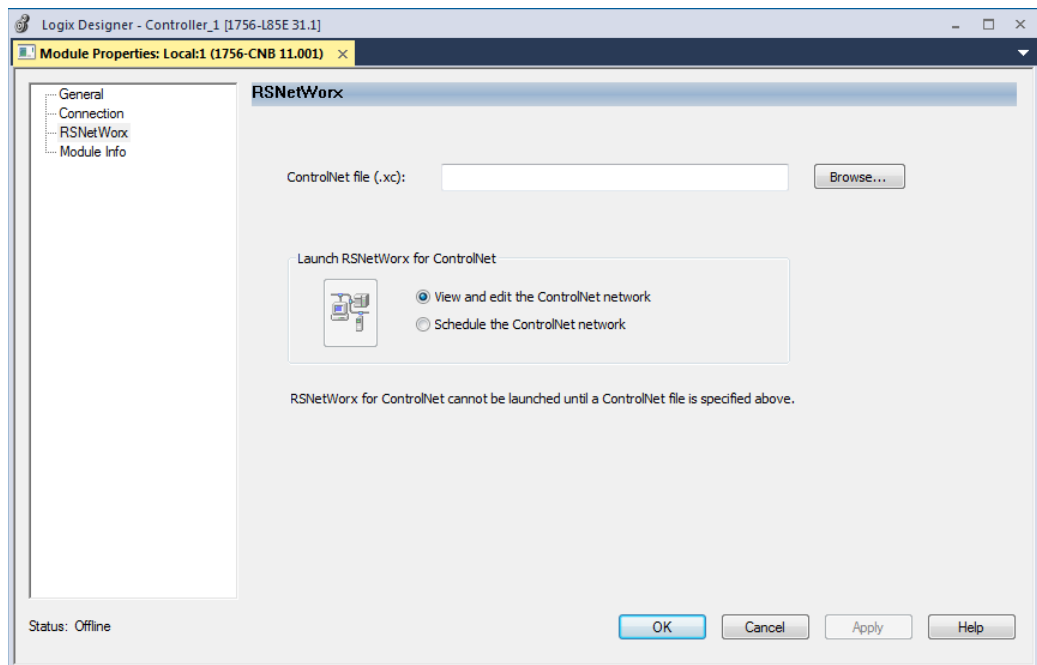

3. In the ControlNet file field, type a name for a new ControlNet file.
4. Click **Apply**.
5. When a message appears prompting you to create the file, click **Yes**.

This action creates the file that RSNetWorx for ControlNet software uses offline to browse and schedule the network.

6. Select **Schedule the ControlNet network**.
7. Click the icon circled below to launch RSNetWorx for ControlNet software.

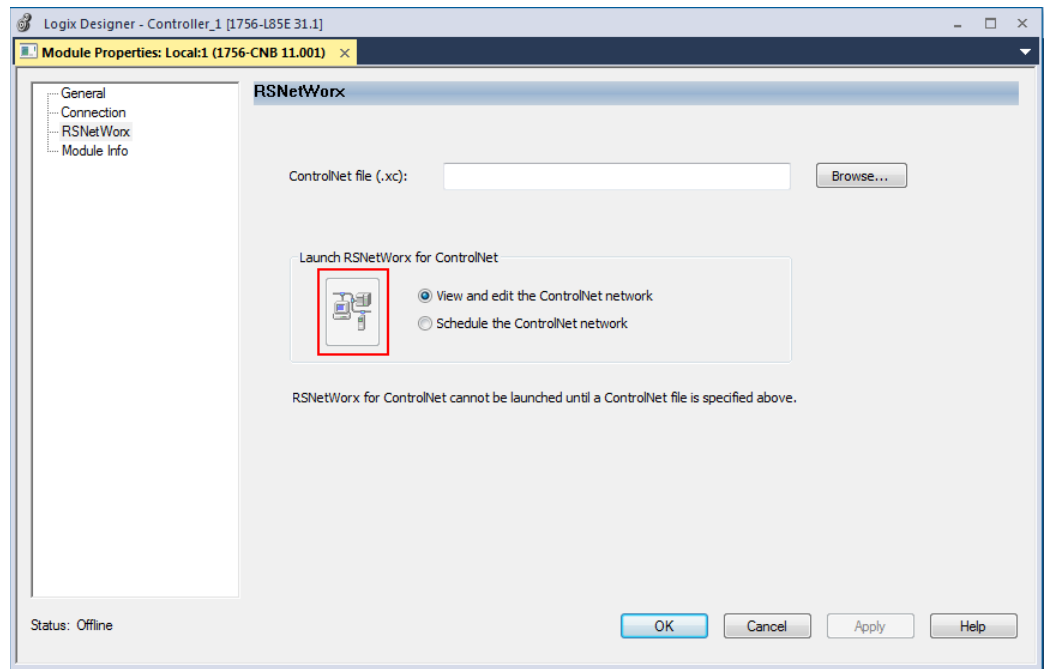

8. To enable edits in the schedule, in RSNetWorx for ControlNet software, select **Edits Enabled**.

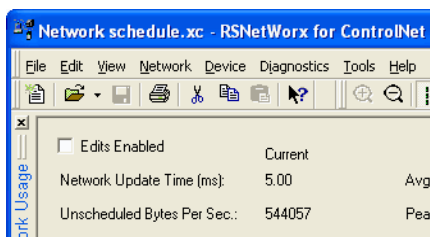

9. To change the network properties from default settings to those that best fit your network, from the Network menu, choose **Properties**.

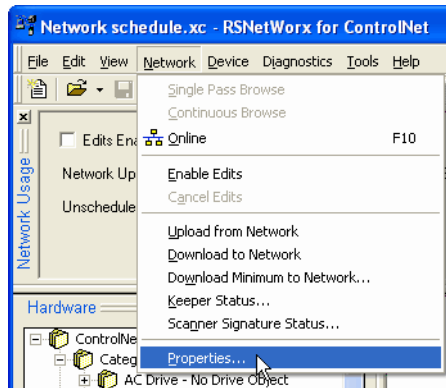

10. On the Network Parameters tab, configure the network parameters, as described in the table below, and click **OK**.

Parameter	Description
Network Update Time (ms)	The smallest user-configurable repetitive time cycle at which data can be sent on a ControlNet network.
Max Scheduled Address	This is the node with the highest network address that can use scheduled time on a ControlNet link. I/O data is transferred during scheduled time. RSNetWorx for ControlNet software sets this value. We recommend that you not change it.
Max Unscheduled Address	Node with the highest network address that can use unscheduled time on a ControlNet link. Messaging data is transferred during unscheduled time. Nodes set at addresses higher than the maximum unscheduled node do not communicate on the network. For example, they will not display in FactoryTalk Linx software.
Media Redundancy	Designates if the network uses media redundancy.
Network Name	User-defined name of the network.

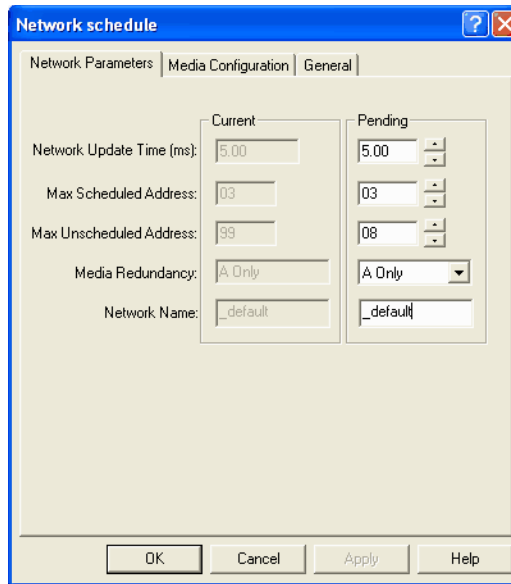

11. Click the **Media Configuration** tab.

Generally, you can use the default media configuration.

12. Adjust the configuration if your network is longer or uses repeaters.

If the media configuration does not accurately represent the maximum propagation delay between any two nodes, your network may experience errors.

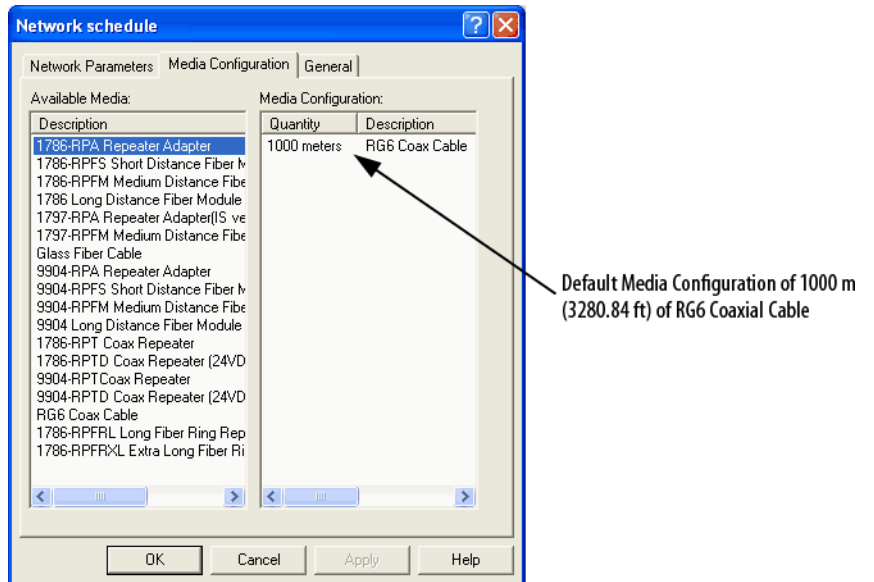

13. Click **OK**.

14. On the Save Configuration dialog box, select **Optimize and rewrite the schedule for all connections**.

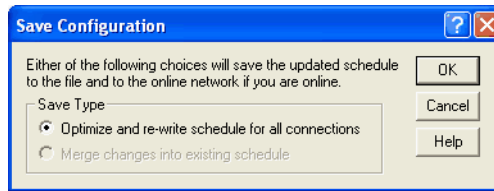

15. Click **OK**.

16. Return to your Logix Designer software project.

- a. Save your project to update the network file in your Logix Designer project.
- b. Download your project as described in [Download the Project to the Logix 5000 Controller on page 36](#) on [page 38](#).

Schedule the Network Online

Prior to scheduling a network online, make sure that all keepers are unconfigured or do not conflict with the current network. If your network has already been scheduled and you made a change to it, you must reschedule it.

Refer to [Reschedule a ControlNet Network that has Previously been Scheduled on page 56](#) on [page 53](#) on [page 56](#) for more information.

To schedule a network online, follow this procedure in RSNetWorx for ControlNet software.

1. From the **File** menu, choose **New**.

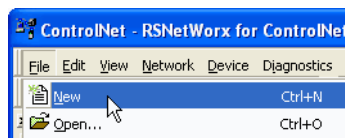

2. From the **New File** dialog box, select a ControlNet configuration for the new file and click **OK**.

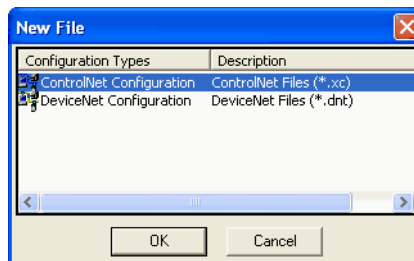

- From the **Network** menu, choose **Online**.



- From the **Browse for Network** dialog box, expand the tree to find and select a communication path to the ControlNet network and click **OK**.

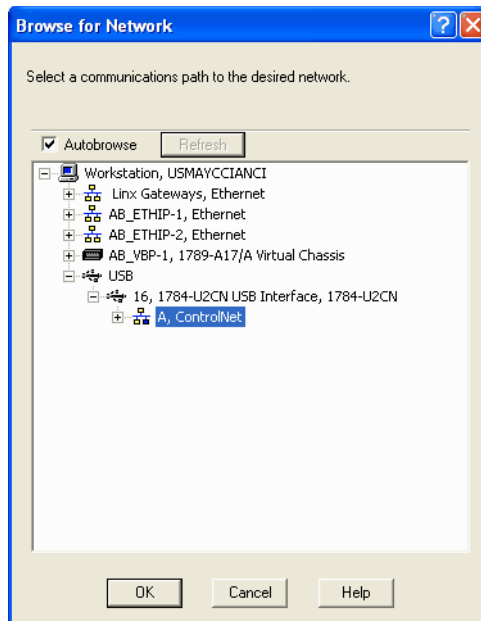

This example uses a previously configured communication path to the controller. Here, the computer is connected to the ControlNet network via a 1784-PCIC card. The driver was previously configured via RSLinx software, as described in [Connect a Computer to the ControlNet Network on page 25](#) on [page 27](#).

- From the **Network** menu, choose **Single Pass Browse**.



- Check **Edits Enabled**.

When you enable edits, RSNetWorx for ControlNet software reads data in the ControlNet modules and builds a schedule for the network.

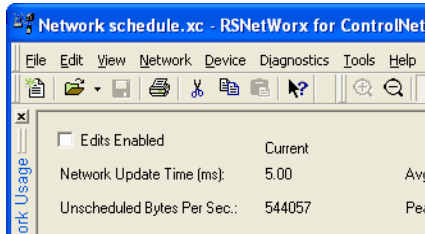

- To change the network properties from default settings to those that best fit your network, from the **Network** menu, choose **Properties**.

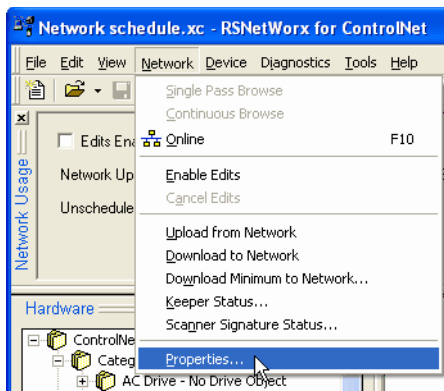

- On the **Network Parameters** tab, configure the network parameters as described in the table below.

Parameter	Description
Network Update Time	The smallest user-configurable repetitive time cycle in milliseconds at which data can be sent on a ControlNet link.
Max Scheduled Address	The node with the highest network address that can use scheduled time on a ControlNet link. I/O data is transferred during scheduled time. RSNetWorx for ControlNet software sets this value. We recommend that you do not change it.
Max Unscheduled Address	The node with the highest network address that can use unscheduled time on a ControlNet link. Messaging data is transferred during unscheduled time. Nodes set at addresses higher than the maximum unscheduled node do not communicate on the network. For example, they will not display in RSLinx software.
Media Redundancy	Designates if the network uses media redundancy on any of the network communication modules.
Network Name	A user-defined name for the network.

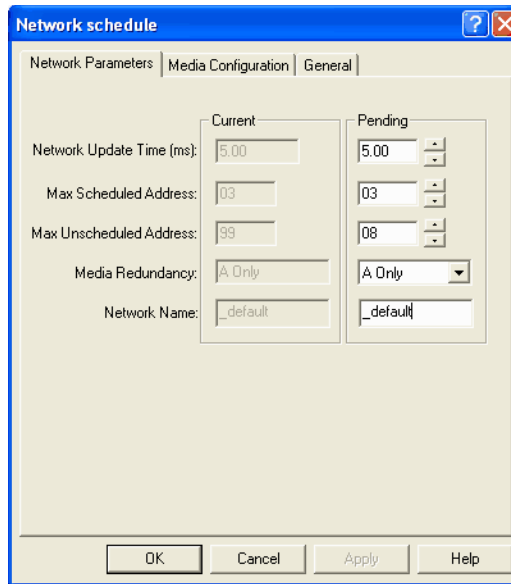

- Click the **Media Configuration** tab, modify the settings if needed, and click **OK**.

Generally, you can use the default media configuration. Adjust the configuration if your network is longer or uses repeaters.

Important: If the media configuration does not accurately represent the maximum propagation delay between any two nodes, your network may experience errors.

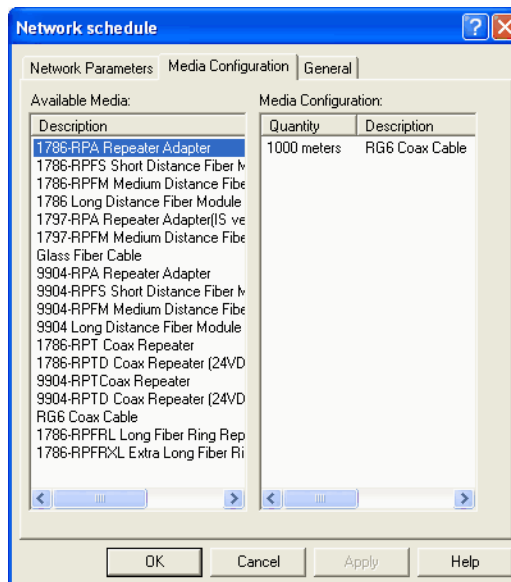

- From the **File** menu, choose **Save**.

- From the **Save Configuration** dialog box, select **Optimize and rewrite the schedule for all connections**.

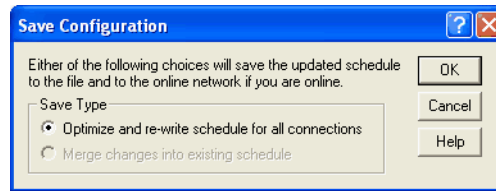

- Click **OK**.

Important: It is better to optimize connections. However, in some cases involving multiple controllers, the **Merge changes into existing schedule** option is available. This option lets controllers whose connections have not changed to continue uninterrupted operation. When you merge changes into the existing schedule, those controllers whose connections have not changed remain in Run mode rather than changing to Program mode.

- In the Logix Designer application, save the online project.

Reschedule a ControlNet Network that has Previously been Scheduled

If you change a previously scheduled network, you must reschedule the network to apply the changes. For example, if you add I/O to an existing ControlNet network, you must reschedule the network for the I/O to become active.

To reschedule an already scheduled ControlNet network, follow this procedure in RSNetWorx for ControlNet software.

- From the **File** menu, choose **Open**.

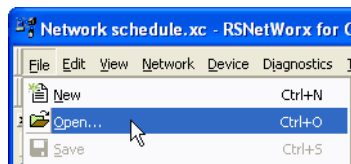

- From the **Open** dialog box, select the ControlNet file that matches the existing network and click **Open**.

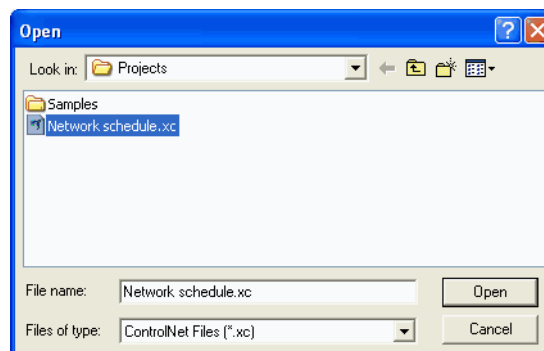

- From the **Network** menu, choose **Online**.



- Check **Edits Enabled**.

When you enable edits, RSNetWorx for ControlNet software reads data in the ControlNet modules and builds a schedule for the network.

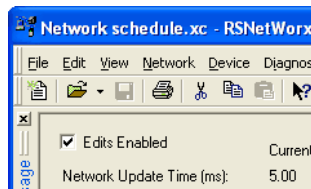

- Save the file.
- From the **Save Configuration** dialog box, select **Optimize and rewrite the schedule for all connections**.

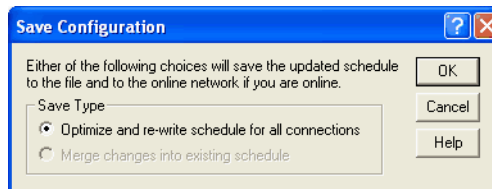

- Click **OK**.

Important: It is better to optimize connections. However, in some cases involving multiple controllers, the **Merge changes into existing schedule** option is available. This option lets controllers whose connections have not changed to continue uninterrupted operation. When you merge changes into the existing schedule, those controllers whose connections have not changed remain in Run mode rather than changing to Program mode.

- In the Logix Designer application, save the online project.

Control I/O

This chapter explains how a controller controls distributed I/O over a ControlNet network.

Topic	Page
Set Up the Hardware on page 95	56 on page 95
Requested Packet Interval (RPI) on page 60	56 on page 60
Communication Format on page 60	57 on page 60
Add a Remote Adapter on page 66	63 on page 66
Add Distributed I/O on page 67	63 on page 67
Access Distributed I/O on page 69	65 on page 69
Validate Connections on page 71	68 on page 71

To control distributed I/O over a ControlNet network, you must do the following:

- Add local and remote ControlNet communication modules to your Logix Designer project.

When you create a new Logix Designer project with the CompactLogix 1769-L32C or 1769-L35CR controller, the Controller Organizer creates a ControlNet port in the local chassis. In this case, you do not need to add a separate local communication module.

- Add distributed I/O to your Logix Designer project.
- Schedule the ControlNet network via RSNetWorx for ControlNet software.
- Use the I/O information in the Logix Designer application.

You can also validate connections to distributed I/O when controlling it over a ControlNet network. This task is particularly useful when one or more of the connections are not working but is not required, especially when all connections appear to work normally.

Set Up the Hardware

In this example, the Logix 5000 controller uses a ControlNet communication module in the local chassis to connect to the ControlNet network. The distributed (remote) I/O has a ControlNet adapter to connect it to the ControlNet network.

Figure 10 - Overview of ControlNet I/O Distribution

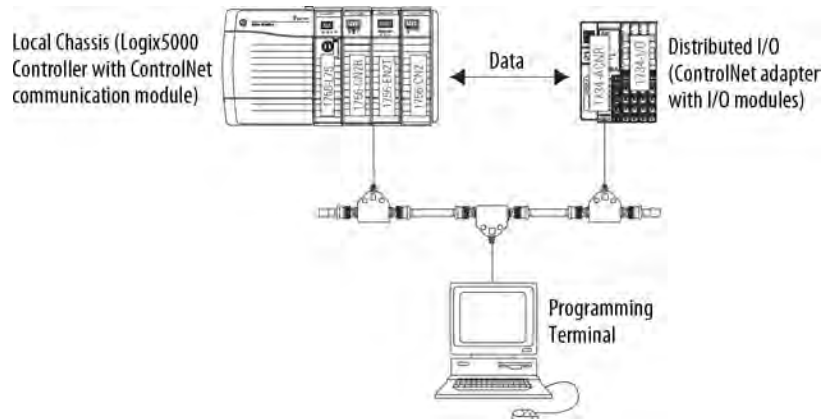

Make sure of the following:

- All wiring and cabling are properly connected.
- The communication driver is configured for the programming workstation.

Requested Packet Interval (RPI)

When you configure an I/O module, you define the RPI for the module. The RPI specifies the interval at which data updates over a connection. For example, an input module sends data to a controller at the RPI that you assign to the module. Configure the RPI in milliseconds.

RPI is used only for a module that produces or consumes data. For example, a local ControlNet communication module does not require an RPI because it is not a data-producing member of the system, but only a bridge.

In Logix 5000 controllers, I/O values update at an interval that you configure via the I/O configuration folder of the project. The values update asynchronously to the execution of logic. At the specified interval, the controller updates a value independently from the execution of logic.

Communication Format

When you configure a remote ControlNet communication module or an I/O module, you choose a communication format. The chosen communication format determines the data structure for tags associated with the module. Many I/O modules support different formats. Each format uses a different data structure.

The chosen communication format also determines the following:

- Direct or rack-optimized connection
- Ownership of outputs

Table 9 - Communication Formats

Communication Format with a Remote ControlNet Communication Module	Criteria for Use
None	<ul style="list-style-type: none"> • When all of the remote I/O communicating with a controller via the remote ControlNet communication module use a Direct Connection communication format • When the connection is used for scheduled peer interlocking • When I/O will be mostly direct connections • When multiple controllers control the outputs in the chassis
Rack-optimized	<ul style="list-style-type: none"> • When some or all of the remote I/O communicating with a controller via the remote ControlNet communication module use a rack-optimized communication format • To minimize ControlNet network bandwidth when using large volume of digital I/O • If only one controller will control the I/O
Rack-optimized—Listen only	When some or all of the remote I/O communicating with a controller via the remote ControlNet communication module use a rack-optimized communication format

I/O module type determines the available communication formats.

Table 10 - Communication Format for Module Types

I/O Module Type	Desired Connection	Required Communication Format
Digital module	Rack-optimized connection	Rack-optimized
	Direct connection or to use specialty features of the module, such as diagnostics, timestamps, or electronic fuses or Connection for listening to data from the module	<ul style="list-style-type: none"> • The data your controller needs from the I/O module. For example, if your application uses a 1756-IA16I module in a remote chassis that must provide timestamped input data, choose the CST Timestamped Input Data communication format. • A listen-only communication format that matches the data the I/O module is broadcasting to other controllers.
Analog module	Direct connection or to use specialty features of the module, such as diagnostics, timestamps, or electronic fuses or Connection for listening to data from the module	<ul style="list-style-type: none"> • The data your controller needs from the I/O module. For example, if your application uses a 1756-OF6CI module in a remote chassis that must provide floating point output data, choose the Float Data communication format. • A listen-only communication format that matches the data the I/O module is broadcasting to other controllers.

Direct or Rack-optimized Connections

Logix 5000 controllers use connections to transmit I/O data. These connections can be direct or rack-optimized connections.

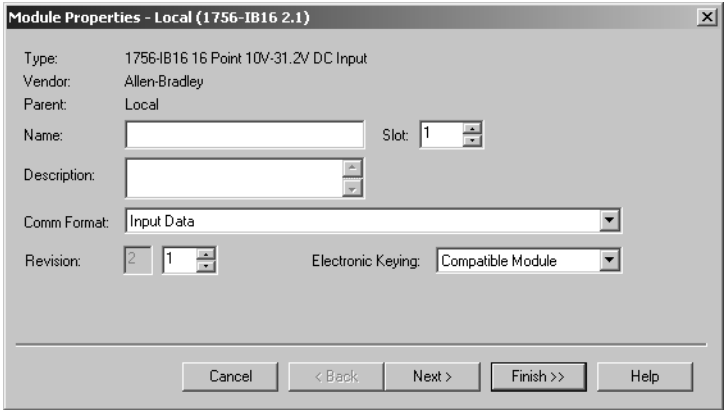
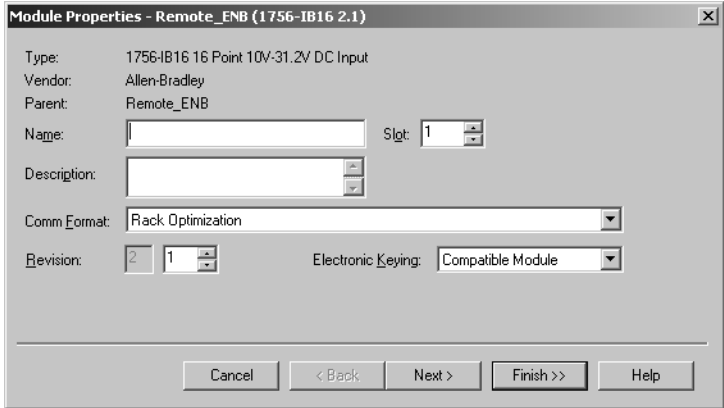
Term	Definition
<p>Direct connection</p>	<p>A direct connection is a real-time, data-transfer link between the controller and an analog or digital I/O module that enables your controller to collect more data from an I/O module. For example, with a direct connection, the controller can collect diagnostic status data from a 1756-IA8D module that would not be collected in a rack-optimized connection.</p> <p>The controller maintains and monitors the connection with the I/O module. Any break in the connection, such as a module fault or the removal of a module while under power, sets fault bits in the data area associated with the module.</p> <p>A direct connection is any connection that does not use the Rack Optimization communication format.</p>  <p>The screenshot shows the 'Module Properties - Local (1756-IB16 2.1)' dialog box. It includes fields for Type (1756-IB16 16 Point 10V-31.2V DC Input), Vendor (Allen-Bradley), Parent (Local), Name, Slot (1), Description, Comm Format (Input Data), Revision (2, 1), and Electronic Keying (Compatible Module). Buttons for Cancel, < Back, Next >, Finish >>, and Help are at the bottom.</p>
<p>Rack-optimized connection</p>	<p>(Digital I/O modules only). A rack-optimized connection consolidates connection usage between the controller and all the digital I/O modules in the chassis or DIN rail. Instead of a direct connection for each I/O module, the entire chassis or DIN rail has one connection.</p> <p>Anytime a remote chassis houses I/O modules that use rack-optimized connections, the remote ControlNet communication module connecting these modules to their owner-controller must also use a rack-optimized connection. However, you can use both direct and rack-optimized connections to the same remote chassis. For example, if your remote chassis houses six digital I/O modules and your application requires direct connections for three and rack-optimized connections for the others, you can choose direct connections for the first three and rack-optimized connections for the second three. In this case, even though you must use a rack-optimized connection for the remote ControlNet communication module, the owner-controller still makes direct connections with the three I/O modules configured as such.</p> <p>Each remote ControlNet communication module is limited to five rack-optimized connections.</p> <p>Rack-optimized Connection.</p>  <p>The screenshot shows the 'Module Properties - Remote_ENB (1756-IB16 2.1)' dialog box. It includes fields for Type (1756-IB16 16 Point 10V-31.2V DC Input), Vendor (Allen-Bradley), Parent (Remote_ENB), Name, Slot (1), Description, Comm Format (Rack Optimization), Revision (2, 1), and Electronic Keying (Compatible Module). Buttons for Cancel, < Back, Next >, Finish >>, and Help are at the bottom.</p>

Direct Connections for I/O Modules

In this example, assume that each distributed I/O module is configured for a direct connection to the controller.

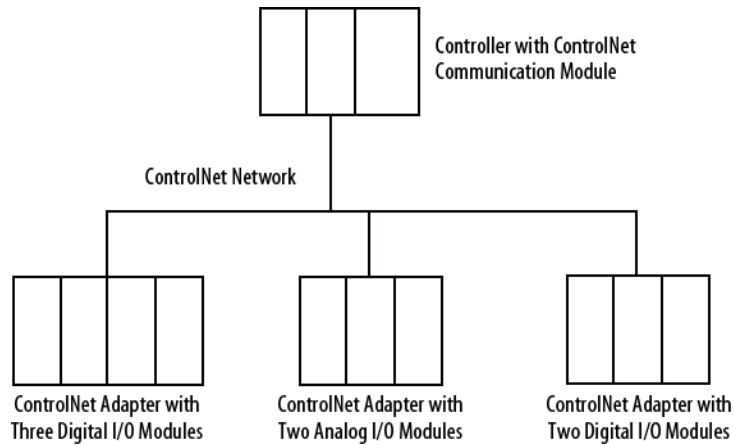

The table below calculates the connections in this example.

Table 11 - Connection Calculations

System Connections	Amount
Controller to local ControlNet communication module	0
Controller to ControlNet adapter(1)	0
Direct connection for digital I/O modules	5 digital
Direct connection for analog I/O modules	2 analog
Total connections used	7

Tip: Direct connections to many modules may not be feasible because the module supports a finite number of connections, and direct connections may require more resources than the module has available. In this case, use rack-optimized connections. Refer to [Rack-optimized Connections for I/O Modules on page 60](#) on [page 64](#) for more information on how to limit connection use and network traffic.

Rack-optimized Connections for I/O Modules

In this example, assume that each digital I/O module is configured for a rack-optimized connection to the controller. Analog modules must be configured for direct connections.

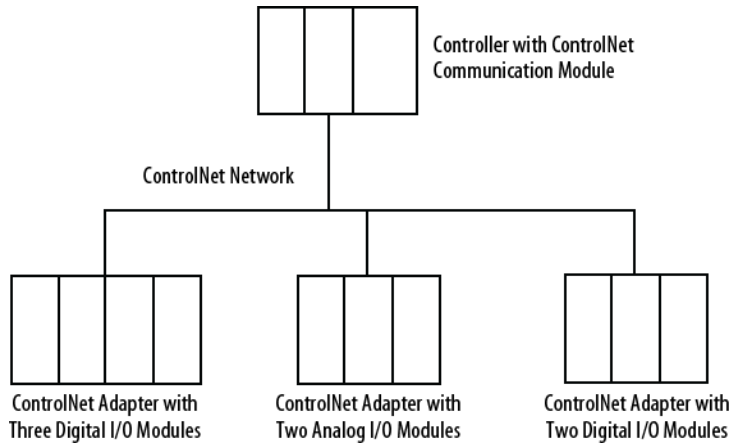

This table calculates the connections in this example.

Table 12 - Connection Calculations

System Connections	Amount
Controller to local ControlNet communication module	0
Controller to ControlNet adapters with digital modules (rack-optimized connection to each adapter)	2
Controller to ControlNet adapter with analog modules (direct connection for each analog I/O module)	2
Total connections used	4

The rack-optimized connection limits connections, but can also limit the status and diagnostic information that is available from the digital I/O modules.

To increase the number of available connections, use a rack-optimized connection to any remote adapter with multiple digital I/O modules that permit rack-optimized connections, instead of direct connections to those I/O modules.

Ownership

In a Logix 5000 system, modules multicast data. This means that multiple controllers can receive the same data at the same time from a single module. When you choose a communication format, you have to choose whether to establish an owner or listen-only relationship with the module.

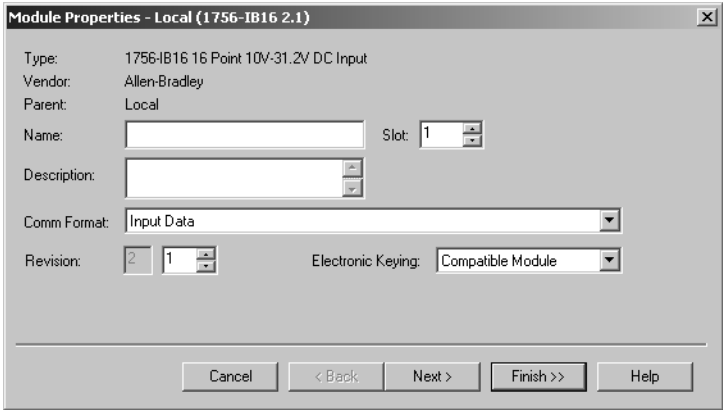
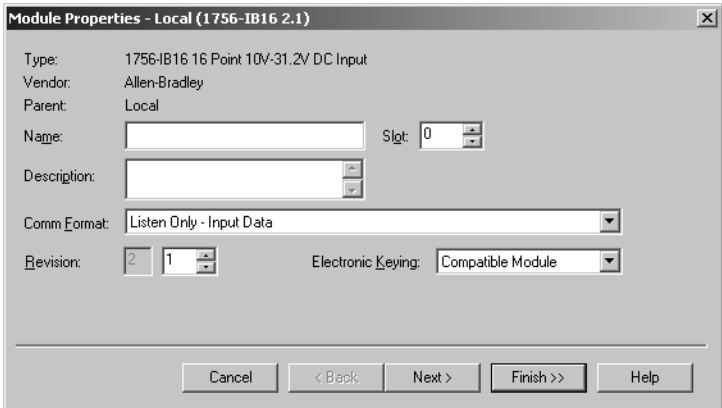
Type of Ownership	Definition
<p>Owner controller</p>	<p>The controller that creates the primary configuration and communication connection to a module. The owner controller writes configuration data and can establish a connection to the module. The owner controller is the only device that controls the outputs.</p> <p>An owner connection is any connection that does not include listen-only in its communication format.</p> 
<p>Listen-only connection</p>	<p>An I/O connection where another controller provides the configuration data for the I/O module. A controller using a listen-only connection only monitors the module. It does not write configuration data and can maintain a connection to the I/O module only when the owner controller is actively controlling the I/O module.</p> <p>Listen-only Connection.</p> 

Choose the Type of Ownership for a Module

Table 13 - Module Ownership

Module Type	Controller	Desired Function	Required Connection Type
Input module	Does not own the module	----->	Owner, such as not listen-only
	Owns the module	Maintain communication with the module if it loses communication with the other controller.	Owner, such as not listen-only Use the same configuration as the other owner controller.

Module Type	Controller	Desired Function	Required Connection Type
		Stop communication with the module if it loses communication with the other controller.	Listen-only
Output module	Does not own the module	----->	Owner, such as not listen-only
	Owens the module	----->	Listen-only

Controlling input modules differs from controlling output modules.

Table 14 - Module Ownership Control

Module Type	Ownership	Description
Input modules	Owner	The controller that establishes an owner connection to an input module configures that module. This configuring controller is the first controller to establish an owner connection. Once a controller owns and configures an input module, other controllers can establish owner connections to that module. This lets additional owners continue to receive multicasted data if the original owner-controller's connection to the module breaks. All other additional owners must have the identical configuration data and communication format as the original owner controller, or the connection attempt is rejected.
	Listen-only	Once a controller owns and configures an input module, other controllers can establish a listen-only connection to that module. These controllers can receive multicast data while another controller owns the module. If all owner controllers break their connections to the input module, controllers with listen-only connections no longer receive multicast data.
Output modules	Owner	The controller that establishes an owner connection to an output module configures that module. Only one owner connection is allowed for an output module. If another controller attempts to establish an owner connection, the connection attempt is rejected.
	Listen-only	Once a controller owns and configures an output module, other controllers can establish listen-only connections to that module. These controllers can receive multicast data while another controller owns the module. If the owner controller breaks its connection to the output module, all controllers with listen-only connections no longer receive multicast data.

Add a Remote Adapter

The type of distributed I/O determines your choice of a remote ControlNet adapter. Before choosing a remote adapter, you must add local and remote ControlNet modules to a Logix Designer project. For more information on adding ControlNet modules to a project, see [Add and Configure a Local ControlNet Module on page 30](#) on [page 31](#) and [Add and Configure a Remote ControlNet Module on page 33](#) on [page 35](#).

Table 15 - Remote Adapter Options

Type of Distributed I/O	Required Remote Adapter	Configuration Method
1756 ControlLogix I/O	1756-CN2, 1756-CN2R 1756-CNB, 1756-CNBR	Logix Designer application
1768 CompactLogix I/O	1768-CNB, 1768-CNBR	
1794 FLEX I/O	1794-ACN15, 1794-ACNR15	
1797 FLEX Ex I/O	1797-ANCR	
1734 POINT I/O	1734-ACNR	
1738-ArmorPOINT	1738-ACNR	

Add Distributed I/O

To communicate with I/O modules in your system, you add a bridge, adapter, and I/O modules to the I/O Configuration folder of the controller. Within the folder, you organize modules into a hierarchy of tree/branch and parent/child.

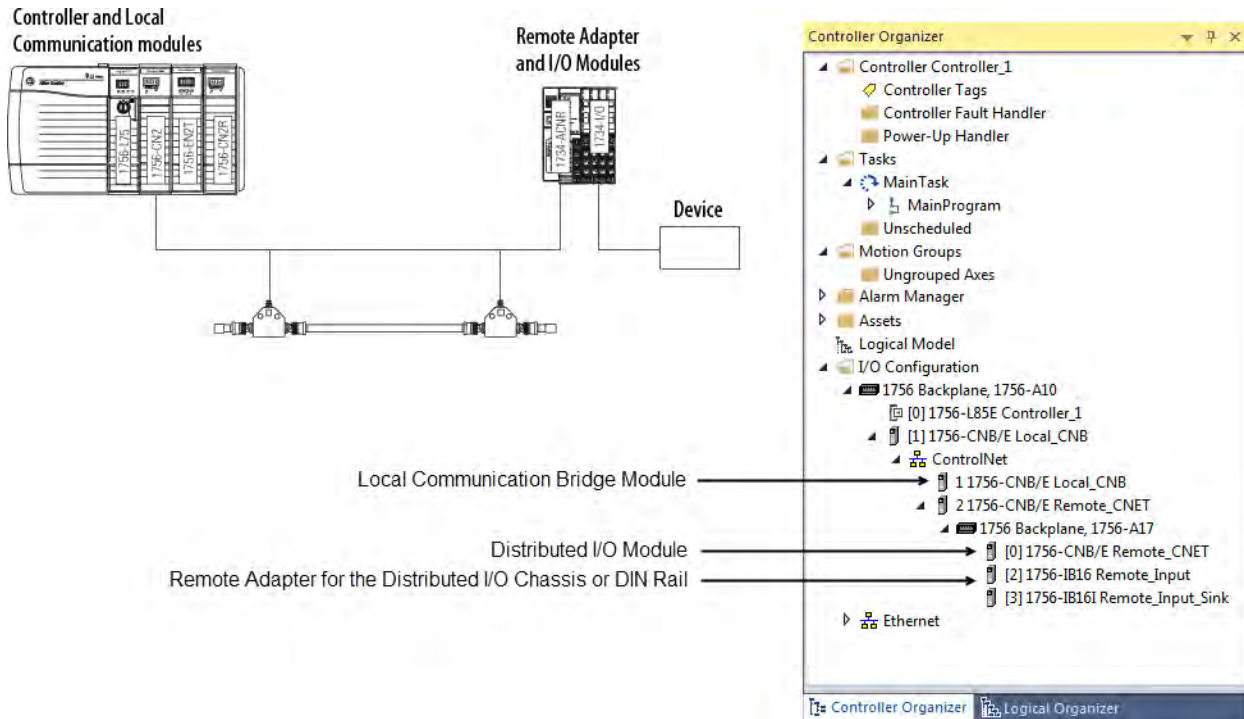

To add distributed I/O to your Logix Designer project, perform this procedure.

1. Add the local and remote ControlNet communication modules.

For more information, refer to [Add and Configure a Local ControlNet Module on page 30](#) on [page 31](#) and [Add and Configure a Remote ControlNet Module on page 33](#) on [page 35](#).

2. In Logix Designer application, right-click your remote ControlNet communication module and choose **New Module**.

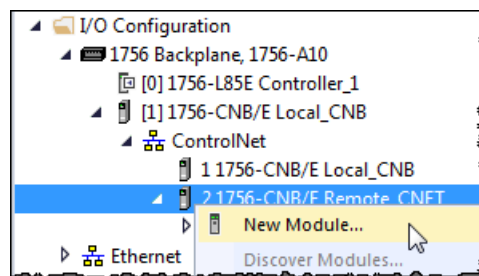

3. From the **Module Properties** dialog box, configure the distributed I/O module.

Important: This procedure shows the Module Properties dialog box for a 1794-IB16XOB16P/A digital combo module. However, various dialogs appear during configuration depending on the type of distributed I/O. For help configuring a module, refer to the online help in Logix Designer application.

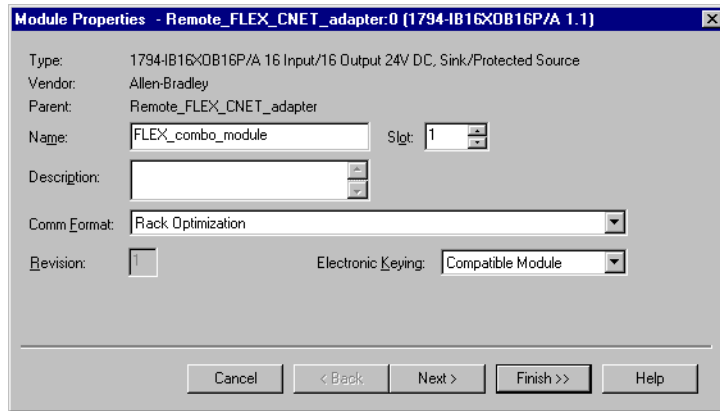

To	Then
Use the module's default configuration	<ul style="list-style-type: none"> Type the module name, communication format, and RPI. Click Finish.
Customize the configuration	<ul style="list-style-type: none"> Type the module name, communication format, and RPI. Click Next to proceed through subsequent screens to configure additional parameters, such as filter times and fault actions.

Distributed I/O Communication Formats

Your selection of communication format when you add distributed I/O modules is based on whether you want rack-optimized or direct connections to each distributed I/O module and corresponds directly with the communication format you chose for your remote adapter.

Remote Adapter Communication Format	Distributed I/O Communication Format
Rack Optimization	Rack Optimization
None	An appropriate direct-connection format

Access Distributed I/O

I/O information is presented as a structure of multiple fields dependent on the specific features of the I/O module. The name of the structure is based on the location of the I/O module in the system. Each I/O tag is automatically created when you configure the I/O module in Logix Designer software. Each tag name follows this format:

Location:SlotNumber:Type.MemberName.SubMemberName.Bit

Address Variable	Definition
Location	Identifies the network location by using one of these values: <ul style="list-style-type: none"> • LOCAL—Local DIN rail or chassis • ADAPTER_NAME—Remote adapter or bridge that you specify
SlotNumber	Slot number of I/O module location in its chassis.
Type	Identifies one of these types of data: <ul style="list-style-type: none"> • I—Input • O—Output • C—Configuration • S—Status
MemberName	Specific data from the I/O module depending on the type of data the module can store. For example, Data and Fault are possible fields of data for an I/O module. Data is the common name for values that are sent to or received from I/O points.
SubMemberName	Specific data related to a MemberName.
Bit (optional)	Specific point on the I/O module depending on the size of the I/O module (0...31 for a 32-point module).

I/O information is available in the Controller Tags portion of your Logix Designer project. You can monitor or edit the tags.

To access distributed I/O, within the Controller Organizer of Logix Designer application, double-click **Controller Tags**.

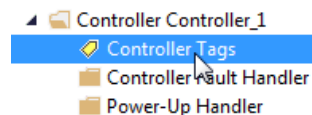

The Controller Tags dialog box appears.

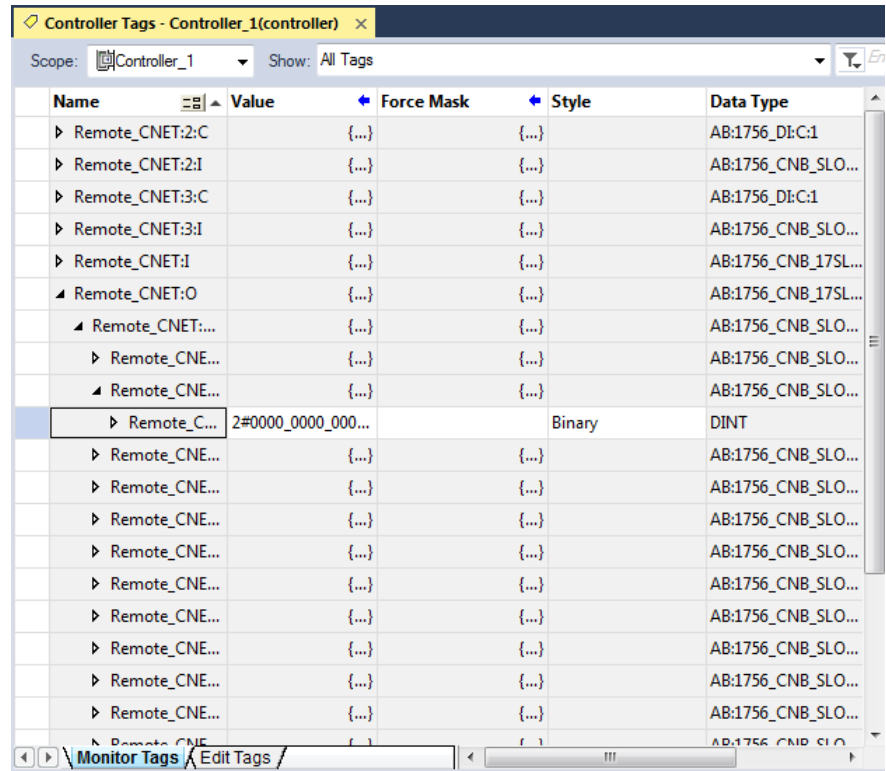

This example contains a tag named Remote_FLEX_CNET_adapter:1:C.Filter_0.

Address Variable	Definition
Location	Remote_FLEX_CNET_adapter
SlotNumber	1
Type	Configuration
MemberName	Filter_0

This example shows an I/O tree configured with a remote FLEX I/O adapter and two remote FLEX I/O modules.

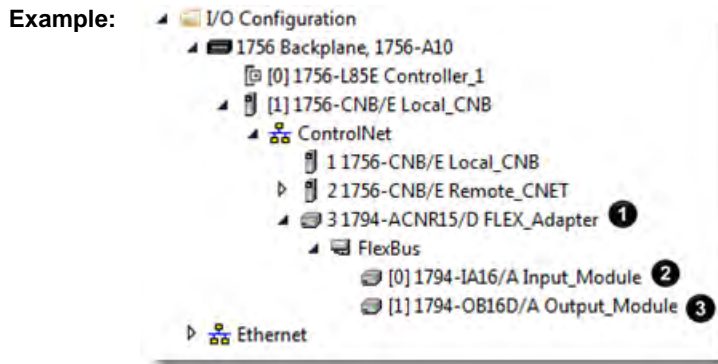
Table 16 - Example Tag Names¹

Example	Example Tag	Module	Example Tag Names Created by Logix Designer Software
1	Example 1	Remote 1794-ACN15 adapter FLEX_adapter	FLEX_adapter:I FLEX_adapter:I.SlotStatusBits FLEX_adapter:I.Data FLEX_adapter:O FLEX_adapter:O.Data
2	Example 2	Remote 1794-IA16 Input_module in slot 1 rack-optimized connection	FLEX_adapter:1:C FLEX_adapter:1:C.Config FLEX_adapter:1:C.DelayTime_0 FLEX_adapter:1:I
3	Example 3	Remote 1794-OB16D Output_module in slot 2 rack-optimized connection	FLEX_adapter:2:C FLEX_adapter:2:C.SSData FLEX_adapter:2:O FLEX_adapter:2:O

Validate Connections

You need to verify that the controller can communicate with the devices that you have just configured.

To validate connections, perform this procedure.

1. Determine if communication has been established with the devices.

If a warning symbol	Then
Appears over the I/O Configuration folder	The controller cannot communicate with the device.
Does not appear over the I/O Configuration folder	The controller can communicate with the device and connections are valid.

¹ The tags listed are not a complete list of the tags created for each module type. For a full list of the tags created for each module, see the Tag Monitor tool in the Logix Designer application.

2. Identify any faults in communication modules by working down through the I/O configuration tree.

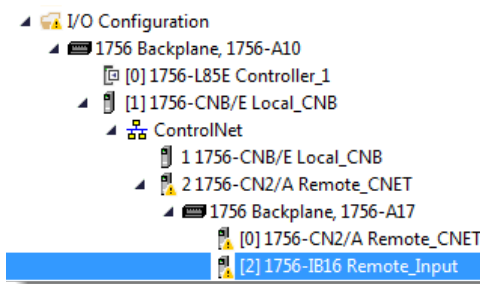

In this example, faults occurred at the remote 1756-CN2/A module and the I/O modules added below it.

3. Identify the fault codes, specifically the fault at the module that is highest in the I/O tree.
4. Right-click the module and choose **Properties**.

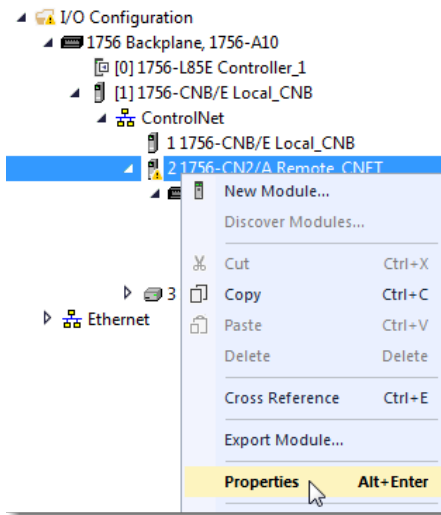

- From the Module Properties dialog box, click the **Connection** tab.

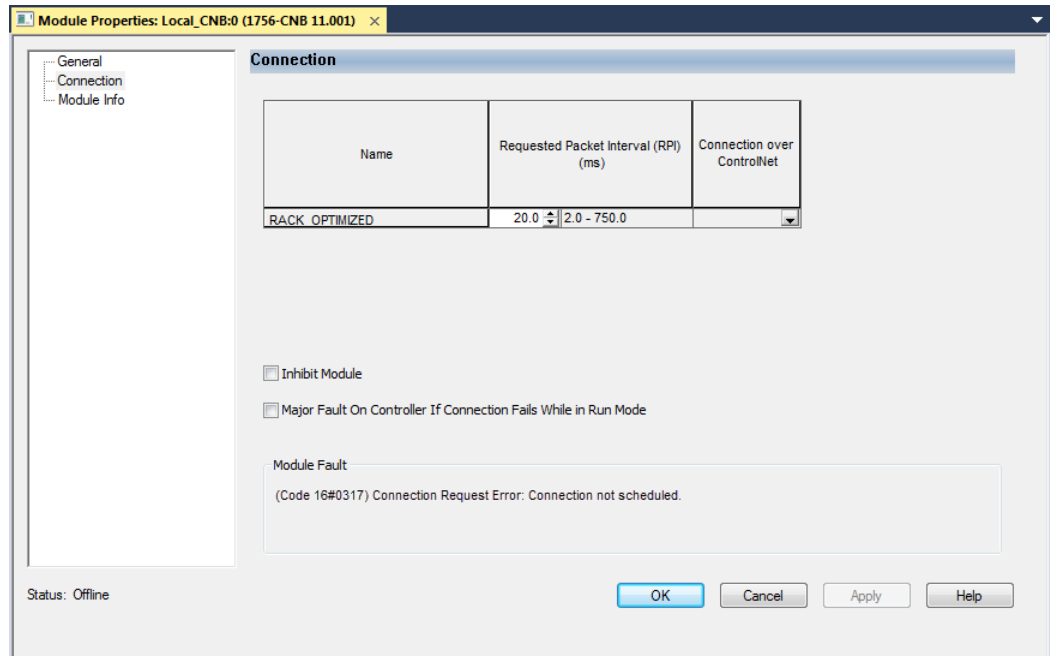

- Identify the fault in the Module Fault area.
- To interpret the fault codes, return to the Logix Designer application and from the Help menu, choose **Contents**.

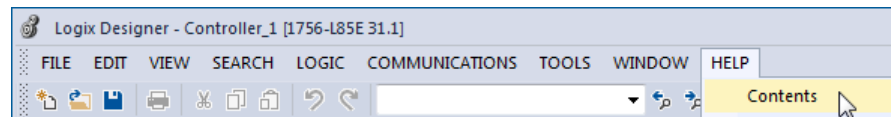

- In the **Search** box, type **module fault**.
- In the list of search results, click range for the module fault codes you just identified.
- Follow the recommendations for your fault code.

Produce and Consume Tags (interlock controllers)

This chapter explains how to interlock (produce and consume tags) controllers via a ControlNet network.

Topic	Page
Terminology on page 75	71 on page 75
Set Up the Hardware on page 95	72 on page 95
Determine Connections for Produced and Consumed Tags on page 77	73 on page 77
Organize Tags for Produced or Consumed Data on page 78	75 on page 78
Adjust for Bandwidth Limitations on page 79	76 on page 79
Produce a Tag on page 80	77 on page 80
Consume a Tag on page 83	79 on page 83

Interlocking controllers is the preferred method of sharing scheduled data between controllers when data needs to be delivered regularly, quickly and at a set interval.

Terminology

A Logix 5000 controller lets you produce (broadcast) and consume (receive) system-shared tags.

Term	Definition
Produced tag	A tag that a controller makes available for use by other controllers. Multiple controllers can simultaneously consume (receive) the data. A produced tag sends its data to one or more consumed tags (consumers) without using logic. The produced tag sends its data at the RPI of the fastest consuming tag.
Consumed tag	A tag that receives a produced tag's data. The data type of the consumed tag must match the data type, including any array dimensions, of the produced tag. The RPI of the fastest consumed tag determines the rate at which the produced tag is produced.

For two controllers to share produced or consumed tags, they must reside on the same ControlNet network.

Set Up the Hardware

In this example, the controller in the first chassis produces a tag that is consumed by the controller in the second chassis.

Figure 11 - Interlocking Controllers Example

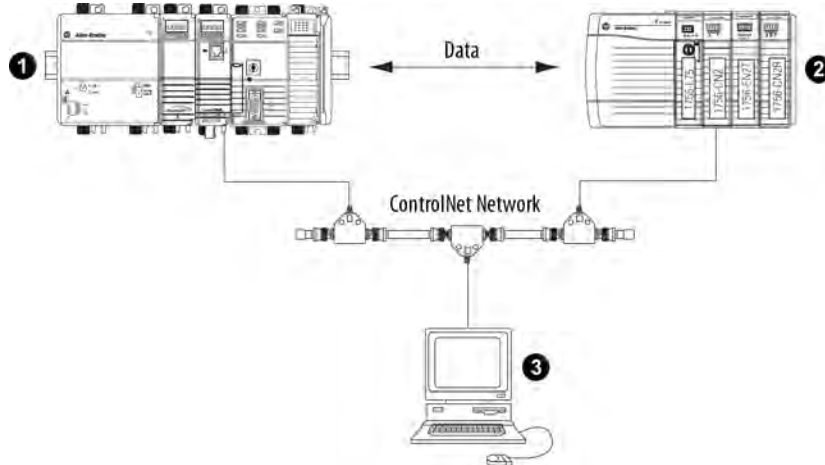

Item	Description
1	<p>Chassis 1 can contain any of these combinations:</p> <ul style="list-style-type: none"> • 1756 ControlLogix controller with a 1756-CN2 or 1756-CN2R communication module in the chassis. • 1756 ControlLogix controller with a 1756-CNB or 1756-CNBR communication module in the chassis. • 1768-L43 CompactLogix controller with a 1768-CNB or 1768-CNBR communication module in the chassis. • 1769-L32C or 1769-L35CR CompactLogix controller. • 1789 SoftLogix controller with a 1784-PCICS communication card. • PowerFlex 700S with DriveLogix controller and a 1788-CNx ControlNet communication card. • Non-Logix 5000 controller or other device connected to ControlNet via a ControlNet scanner card.
2	<p>Chassis 2 can contain any of these combinations:</p> <ul style="list-style-type: none"> • 1756 ControlLogix controller with a 1756-CN2 or 1756-CN2R communication module in the chassis. • 1756 ControlLogix controller with a 1756-CNB or 1756-CNBR communication module in the chassis. • 1768-L43 CompactLogix controller with a 1768-CNB or 1768-CNBR communication module in the chassis. • 1769-L32C or 1769-L35CR CompactLogix controller. • 1789 SoftLogix controller with a 1784-PCICS communication card. • PowerFlex 700S with DriveLogix controller and a 1788-CNx ControlNet communication card. • Non-Logix 5000 controller or other device connected to ControlNet via a ControlNet scanner card.
3	Programming terminal

Make sure of the following:

- The ControlNet communication modules are connected to a scheduled ControlNet network.
- All wiring and cabling are properly connected.
- The communication driver is configured for the programming workstation.

Tip: If you are sharing tags only between ControlLogix controllers, the controllers are not controlling any I/O modules. You can set the communication format of the 1756-CN2, 1756-CN2R, 1756-CNB, or 1756-CNBR modules in the remote chassis to None. This limits connection usage and network traffic.

Determine Connections for Produced and Consumed Tags

Logix controllers can produce (broadcast) and consume (receive) system-shared tags that are sent and received via the ControlNet communication module. Each produced and consumed tag requires connections.

Table 17 - Tag Type and Connections

Tag Type	Required Connections
Produced	The produced tag requires two connections. The producing controller must have one connection for the produced tag and the first consumer and one connection for each additional consumer (heartbeat). The heartbeat is a small scheduled packet the consumer sends to indicate that it is getting the produced data. As you increase the number of controllers that can consume a produced tag, you also reduce the number of available controller connections for other operations, such as communication and I/O.
Consumed	Each consumed tag requires one connection for the controller that is consuming the tag.

All ControlNet modules support at least 32 connections. The number of available connections limits the number of tags that can be produced or consumed. If the communication module uses all of its connections for I/O and other communication modules, no connections are left for produced and consumed tags.

Table 18 - Produced and Consumed Tags and Number of Connections

Controller	Available Connections	Connections Used by a Produced Tag	Connections Used by a Consumed Tag
CompactLogix PowerFlex 700S with DriveLogix software	100	Number of consumers + 1	1
ControlLogix SoftLogix5800	250		

Communication Card	Available Connections	Connections Used by a Produced Tag	Connections Used by a Consumed Tag
ControlNet port on the CompactLogix controller	32	Number of consumers	1
1768-CNB and 1768-CNBR CompactLogix ControlNet modules	48		
1788-CNx card in PowerFlex 700S with DriveLogix controller	32 total ControlNet connections, 22 of which can be scheduled and used for producing and consuming tags.		
1756-CN2 and 1756-CN2R series B ControlNet modules in the local chassis of a ControlLogix controller	131 Note that 3 of the 131 connections are always reserved for redundant control. Therefore, 128 connections are available for standard use.		
1756-CNB and 1756-CNBR ControlNet modules in the local chassis of a ControlLogix controller	64 We recommend that you do not use more than 40...48 scheduled connections.		
1784-PCICS card in a SoftLogix5800 controller	127		

Organize Tags for Produced or Consumed Data

Follow these guidelines as you organize your tags for produced or consumed data (shared data).

Table 19 - Guidelines for Produced or Consumed Data Tags

Function	Guidelines
Create the tags at the controller scope.	You can produce and consume only controller-scoped tags.
Produce and consume specific tags.	You cannot produce or consume these types: <ul style="list-style-type: none"> • Alias • Axis type • BOOL • Consumed • I/O • INT • Message

Function	Guidelines		
Use one of these data types: <ul style="list-style-type: none"> • DINT • REAL • Array of DINTs or REALs • User-defined 	To share other data types, create a user-defined data type that contains the required data. Use the same data type for the produced tag and corresponding consumed tag or tags.		
Limit the size of the tag to ≤ 480 bytes.	If you must transfer more than 480 bytes, create logic to transfer the data in smaller packets or create multiple produce/consume tags.		
To share tags with a PLC-5C controller, use a user-defined data type.	To	This	Then
	Produce	Integers, BOOLS or combinations of both	Create a user-defined data type that contains an array of INTs with an even number of elements, such as INT[2].
		Only one REAL value	Use the REAL data type.
		More than one REAL value	Create a user-defined data type that contains an array of REALs.
	Consume	Integers	Create a user-defined data type that contains these members:
			Data type
DINT			Status BIT 0 <ul style="list-style-type: none"> • 0 PLC5 in PROG mode • 1 PLC5 in RUN mode
	INT[x], where x is the output size of the data from the PLC-5C controller. If you are consuming only one INT, omit x.	Data produced by a PLC-5C controller	
Use the highest permissible RPI for your application.	If the controller consumes the tag over a ControlNet network, use a binary multiple of the ControlNet network update time (NUT). For example, if the NUT is 5 ms, use an RPI of 5, 10, 20, or 40 ms.		
Combine data that goes to the same controller.	If you are producing several tags for the same controller, group the data in these ways: <ul style="list-style-type: none"> • To reduce the number of connections, group the data into one or more user-defined data types. • To conserve network bandwidth, group the data according to similar update intervals. 		

Adjust for Bandwidth Limitations

When you share a tag over a ControlNet network, the tag must fit within the bandwidth of the network:

- As the number of connections over a ControlNet network increases, several connections, including produced or consumed tags, may need to share a network update time (NUT).
- A ControlNet node can transmit approximately 500 bytes of scheduled data in a single NUT.

Depending on system size, your ControlNet network may lack the bandwidth for large tags. If a tag is too large for your ControlNet network, make one or more of these adjustments.

Table 20 - Tag Adjustments

Adjustment	Description	
Increase the requested packet interval (RPI) of your connections. This is the recommended method.	At higher RPIs, connections can take turns sending data during an update period.	
Reduce your network update time (NUT).	At a faster NUT, fewer connections have to share an update period.	
For a ControlNet 1756-CN2, 1756-CN2R, 1756-CNB, or 1756-CNBR bridge module in a remote chassis, choose the most efficient communication format for that chassis.	Are most of the modules in the chassis non-diagnostic, digital I/O modules?	Then choose this communication format for the remote 1756-CN2 or 1756-CNB module
	Yes	Rack optimization
	No	None
	The rack optimization format uses an additional eight bytes for each slot in its chassis. Analog modules or modules that are sending or receiving diagnostic, fuse, timestamp, or schedule data require direct connections and cannot take advantage of the rack-optimized form. Selecting None frees up the eight bytes per slot for other uses, such as produced or consumed tags.	
Separate the tag into two or more smaller tags.	<ol style="list-style-type: none"> 1. Group the data according to similar update rates. For example, you could create one tag for data that is critical and another tag for data that is not as critical. 2. Assign a different RPI to each tag. 	
Create logic to transfer the data in smaller sections (packets).	For information on how to do this, see the Logix 5000 Controllers Common Procedures Programming Manual, publication 1756-PM001 .	

Produce a Tag

A Logix 5000 controller can produce only controller-scoped, user-created tags in the local controller's tag structure. Logix 5000 controllers cannot produce I/O tags or tags aliased to I/O tags.

To produce a tag, perform this procedure.

1. Open the Logix Designer project containing the tag you want to produce.

Important: You can create produced tags only when your Logix Designer project is offline.

- In the Controller Organizer of the Logix Designer application, right-click **Controller Tags** and choose **Edit Tags**.

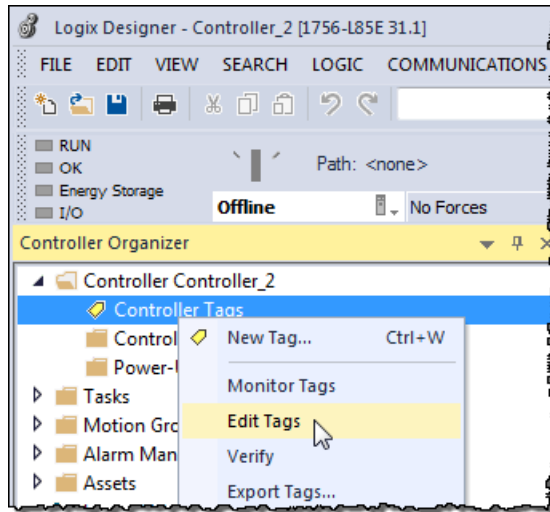

- From the **Controller Tags** dialog box, type the name of the new tag in an available **Tag Name** field.

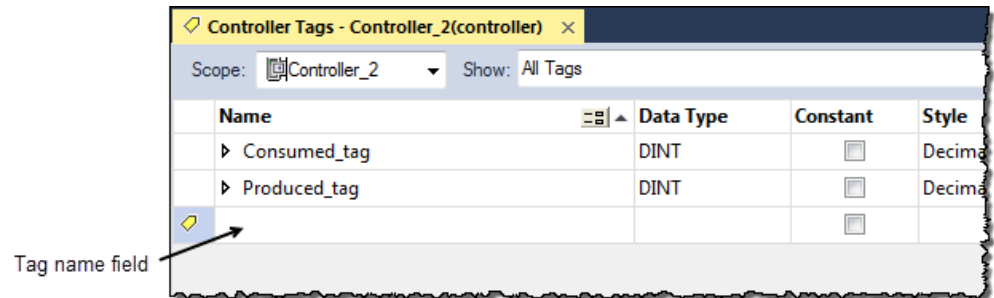

- Right-click the new tag name and choose **Edit Tag Properties**.

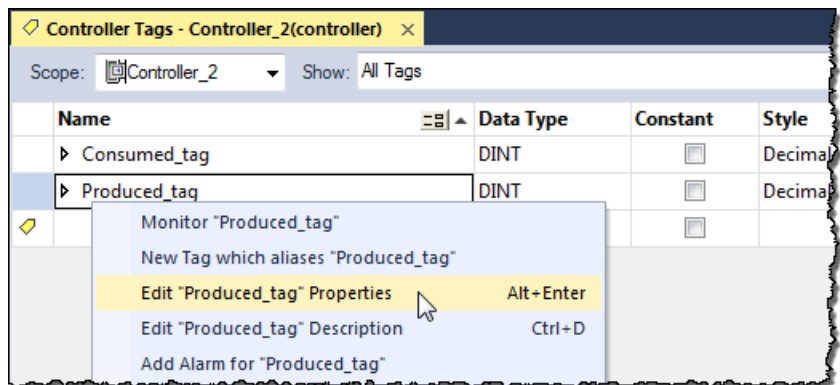

5. On the **Tag Properties** dialog box, from the **Type** menu, choose **Produced**.

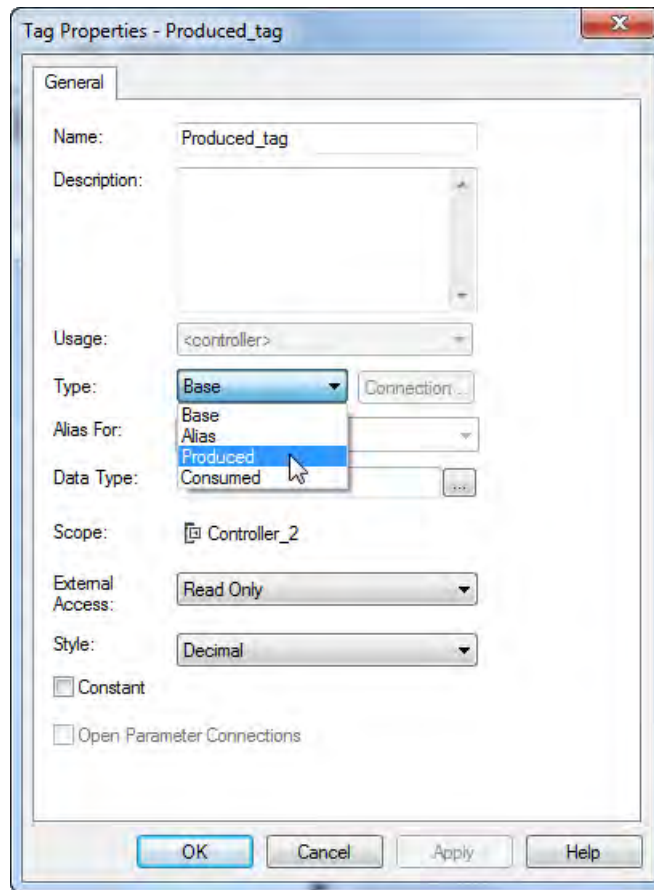

6. In the **Data Type** field, type a data type that the controller can produce.
A controller cannot produce a tag by using MSG or INT data types.
7. Click the **Connection** tab.

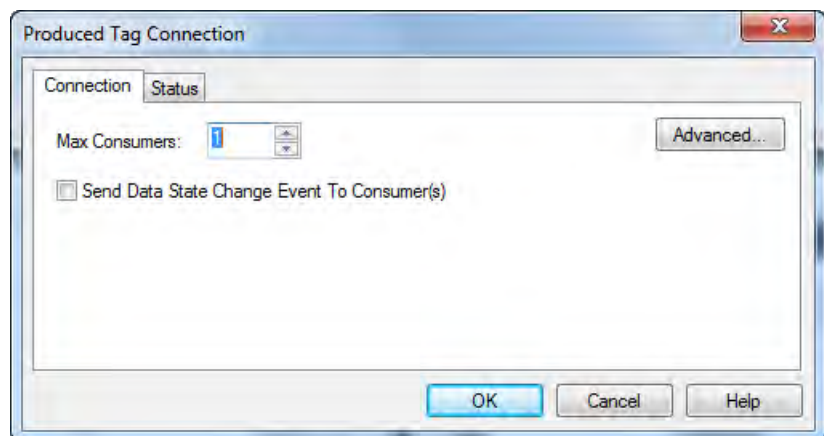

8. In the **Max Consumers** field, type a number of consumers.

If you are unsure of the maximum number of consumers, use a number higher than the actual number of consumers. Unused connections are deducted from the number of available controller connections.

9. Click **OK**.

Important: When your controller produces a tag, any device that interfaces with a ControlNet network can consume the tag. However, when a non-Logix controller, such as a personal computer using a 1784-PKTCS card, consumes the tag produced by a Logix controller, you must perform additional tasks in RSNetWorx for ControlNet software.

Consume a Tag

Logix 5000 controllers can consume only controller-scoped user-created tags from another controller's tag structure. The Logix 5000 controllers cannot consume I/O tags or tags aliased to I/O tags.

Important: You can create consumed tags only when your Logix Designer project is offline.

To consume a tag, perform this procedure.

1. Open the Logix Designer project that contains the controller that you want to consume the produced tag.
2. Make sure the controller producing the tag to be consumed is in the consuming controller's I/O configuration, as shown in this example.

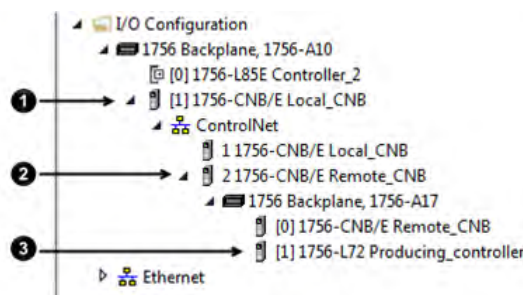

- 1 Local ControlNet module in consuming controller's chassis
- 2 Remote ControlNet module
- 3 Producing controller

3. Make sure the communication format for the remote ControlNet module is None.

- In the Controller Organizer of the Logix Designer application, right-click **Controller Tags** and choose **Edit Tags**.

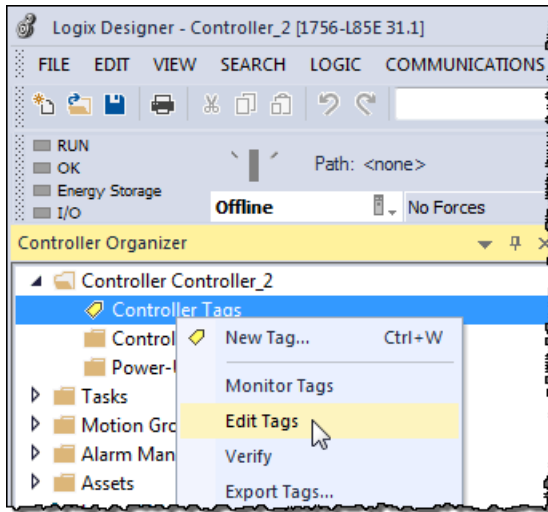

- From the **Controller Tags** dialog box, type the name of the new tag in an available **Tag Name** field.

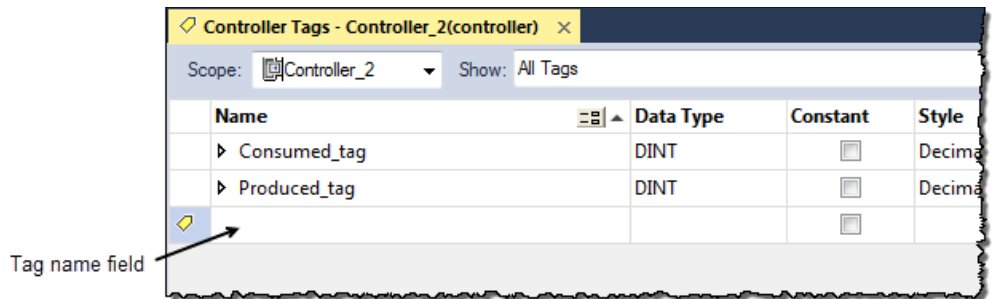

- Right-click the new tag name and choose **Edit Properties**.

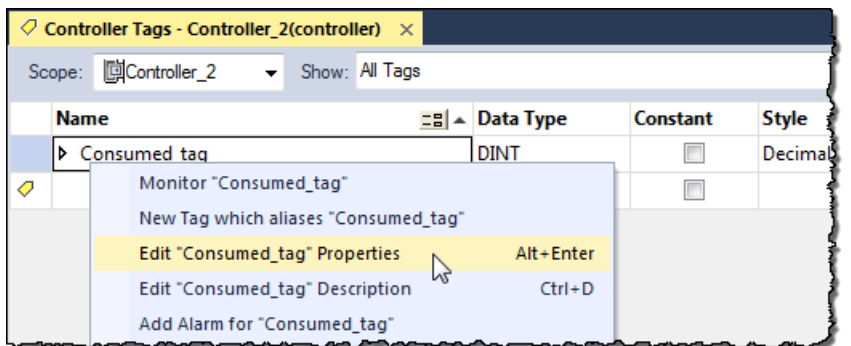

- From the **Tag Properties** dialog box, complete these fields:

- From the **Type** pull-down menu, choose **Consumed**.
- In the **Data Type** field, type a data type that the controller can produce. A controller cannot produce a tag by using the MSG or INT data types.

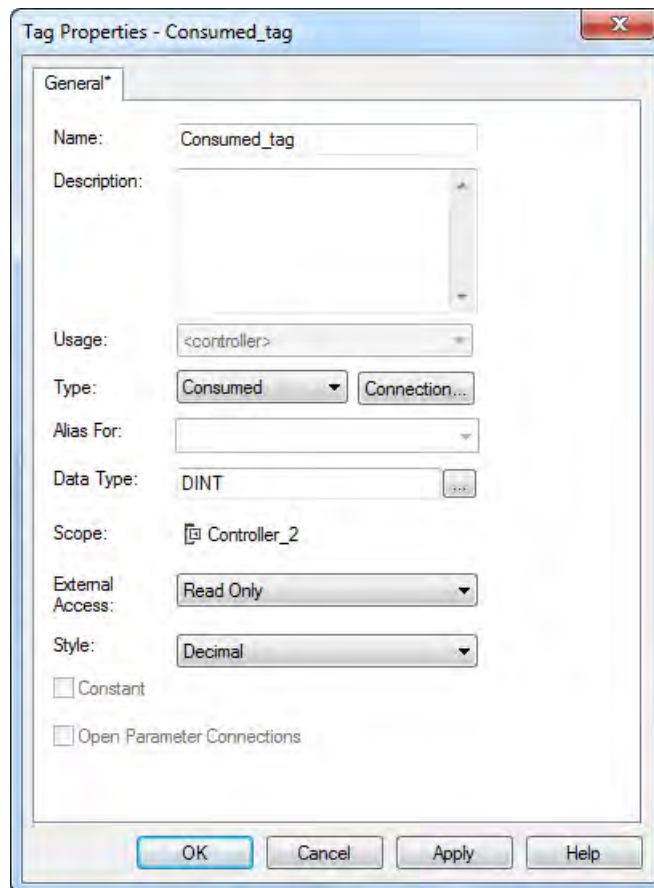

8. Click **Connection**.

9. From the **Consumed Tag Connection** dialog box, complete these fields:
 - From the **Producer** pull-down menu, choose Producing_controller. This menu contains all possible paths to previously configured controllers in the I/O tree.
 - In the **Remote Data** field, type the name of the produced tag in the producing controller.
 - In the **RPI** field, enter the rate at which the tag will be produced.

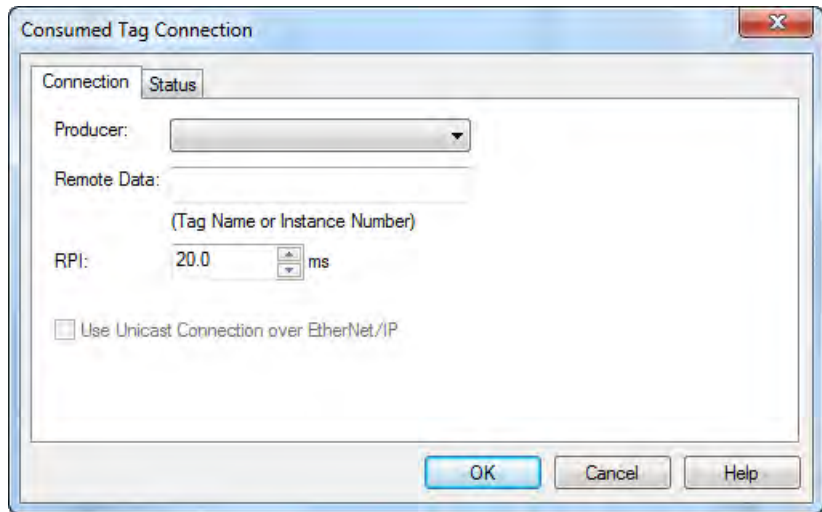

10. Click **OK**.
11. Use RSNetWorx for ControlNet software to schedule the network.

Messaging

This chapter explains how to use MSG instructions to send data to and receive data from other modules on a ControlNet network.

Topic	Page
Set Up the Hardware on page 95	84 on page 95
Guidelines for MSG Instructions on page 88	85 on page 88
Determine Connections for Messages on page 89	86 on page 89
Enter Message Logic on page 90	86 on page 90
Configure a Message Instruction on page 92	88 on page 92
Stagger the Messages on page 93	90 on page 93

Use peer-to-peer messaging when these conditions apply:

- Data is sent when a specific condition occurs in your application.
- Data is sent at a slower rate than is required by produced and consumed tags.
- Data is sent to devices that communicate only with unscheduled data.

Set Up the Hardware

In this example, the controller in the local chassis uses a MSG instruction to send a message to another module, which can be a controller, on the ControlNet network.

Figure 12 - Peer-to-Peer Messaging Example

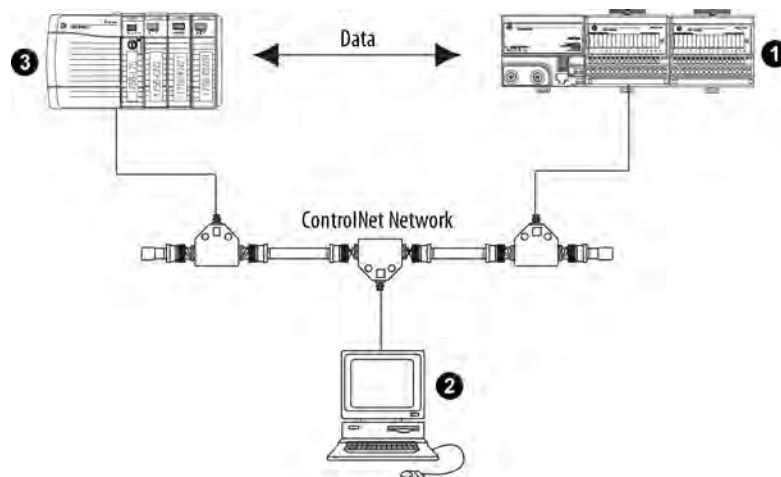

Item	Description
1	Remote chassis with any of these configurations: <ul style="list-style-type: none"> • PLCs, SLC, or Logix 5000 controllers on a ControlNet or other network • I/O modules, such as ControlLogix analog module configuration data on a ControlNet or other network • 1771 block transfer modules
2	Programming terminal
3	Local chassis with any of these combinations: <ul style="list-style-type: none"> • 1756 ControlLogix controller with a 1756-CN2 or 1756-CN2R communication module in the chassis • 1756 ControlLogix controller with a 1756-CNB or 1756-CNBR communication module in the chassis • 1768-L43 CompactLogix controller with a 1768-CNB or 1768-CNBR communication module in the chassis • 1769-L32C or 1769-L35CR CompactLogix controller • 1789 SoftLogix controller with a 1784-PCICS communication card • PowerFlex 700S with DriveLogix controller and a 1788-CNx ControlNet communication card • Non-Logix 5000 controller or other device connected to ControlNet via a ControlNet scanner card

Important: The 1769-L32C and 1769-L35CR controllers can produce and consume tags over a ControlNet network to other Logix 5000 controllers. However, Compact I/O modules that are local to the 1769-L32C and 1769-L35CR controllers are not accessible to other Logix 5000 controllers.

Make sure of the following:

- The ControlNet modules are connected to a ControlNet network.
- All wiring and cabling are properly connected.
- The communication driver is configured for the programming workstation.

Guidelines for MSG Instructions

Follow these guidelines as you work with message instructions.

Table 21 - Guidelines for MSG Instructions

Function	Guidelines
For each MSG instruction, create a control tag.	Each MSG instruction requires its own control tag. This tag contains control elements for messages, such as DN and EN, error codes, and information to execute the message, such as destination path and number of words to transfer: <ul style="list-style-type: none"> • Data type = MESSAGE • Scope = controller • The tag cannot be part of an array or a user-defined data type
Keep the source or destination data at the controller scope.	A MSG instruction can access only tags that are in the Controller Tags folder (controller scope).

Function	Guidelines
If your MSG is to a module that uses 16-bit integers, use a buffer of INTs in the MSG and DINTs throughout the project.	If your message is to a module that uses 16-bit integers, such as an SLC 500 controller, and it transfers integers, not REALs, use a buffer of INTs in the message and DINTs throughout the project. This increases the efficiency of your project because Logix 5000 controllers execute more efficiently and use less memory when working with 32-bit integers (DINTs).
If you want to enable more than 16 MSGs at one time, use some type of management strategy.	If you enable more than 16 MSGs at one time, some MSG instructions may experience delays in entering the queue. To guarantee the execution of each message, you can take these actions: <ul style="list-style-type: none"> • Enable each message in sequence. • Enable the messages in smaller groups. • Program a message to communicate with multiple modules. • Program logic to coordinate the execution of messages.
Cache connected MSGs that execute most frequently.	Cache the connection for those MSG instructions that execute most frequently, up to the maximum number permissible for your controller revision. This optimizes execution time because the controller does not have to open a connection each time the message executes.
Limit the number of unconnected and uncached MSGs to fewer than the number of unconnected buffers.	The controller can have 10..40 unconnected outgoing buffers: <ul style="list-style-type: none"> • The default number is 10. • If all the unconnected buffers are in use when an instruction leaves the message queue, the instruction errors and does not transfer the data. • You can increase the number of unconnected buffers to a maximum of 40.

For more information on programming MSG instructions, see the Logix 5000 Controllers General Instructions Reference Manual, publication [1756-RM003](#). The individual system user manuals for Logix 5000 controllers also provide MSG examples unique to specific controller platforms.

Determine Connections for Messages

Messages transfer data to other modules, such as other controllers, I/O modules or operator interfaces. Each message uses one connection, regardless of how many modules are in the message path. To conserve connections, you can configure one message to read from or write to multiple modules. Also, you can configure multiple messages for the same path and use only one connection if only one message is active at a time; however, this requires that you write your ladder logic correctly to make sure that only one message is active at any time.

These connected messages can leave the connection open (cache) or close the connection when the message has finished transmitting.

Table 22 - Message Connections and Communication Methods

Message Type	Communication Method	Connection Required
CIP data table read or write	CIP	Yes
CIP generic	CIP	Optional(1)
Block-transfer read or write	Not applicable	Yes

Guidelines for Caching Message Connections

Follow these guidelines to determine whether to cache a connection.

Message Execution	Appropriate Action
Repeated	Cache the connection. This keeps the connection open and optimizes message completion time. Opening a connection during the execution of each message increases execution time.
Infrequent	Do not cache the connection. This closes the connection upon completion of the message, freeing up that connection for other uses.

Enter Message Logic

To send or receive data from a ControlNet module via a message, you must program a MSG instruction in the local controller's logic. If the target module is configured in the I/O Configuration folder of the controller, browse to choose the module or manually type the message path in the MSG instruction.

Add the ControlNet Modules and Remote Devices to the Local Controller's I/O Configuration

Browse to choose the target device of a MSG instruction and add that remote device to the I/O configuration folder of the local controller. Within the I/O configuration folder, organize the local and remote devices into a hierarchy of tree/branch and parent/child.

Figure 13 - I/O Configuration Order for MSG Instruction

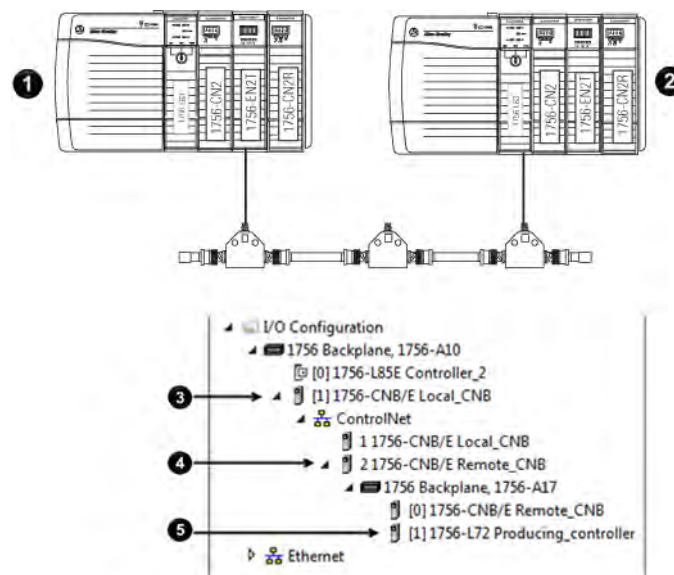

Item	Description
1	Local controller and communication module
2	Remote controller and communication modules
3	Local communication module for the local controller

Item	Description
4	Remote communication module for the remote controller
5	Remote controller

For more information on how to add ControlNet modules and remote devices to the local controller's I/O configuration, see Chapter 4.

Enter a Message

Use relay ladder logic to enter a MSG instruction. Click  to configure the MSG instruction, as shown in the example below.

Example: Enter a MSG instruction as shown below.

ATTENTION: If user_bit and count_messages.EN = 0 (MSG instruction is not already enabled), then execute a MSG instruction that sends data to another controller.

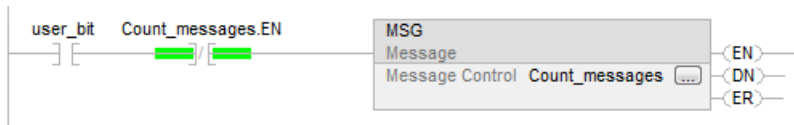

Tip: We recommend an XIO of the MSG control block tag.en, such as the count_messages.EN portion of this rung, as an in-series precondition for all message instructions.
Do not manipulate the control bits of a message instruction.

Configure a Message Instruction

To configure a MSG instruction, perform this procedure.

1. Click  in the MSG box.

The Module Configuration dialog box appears.

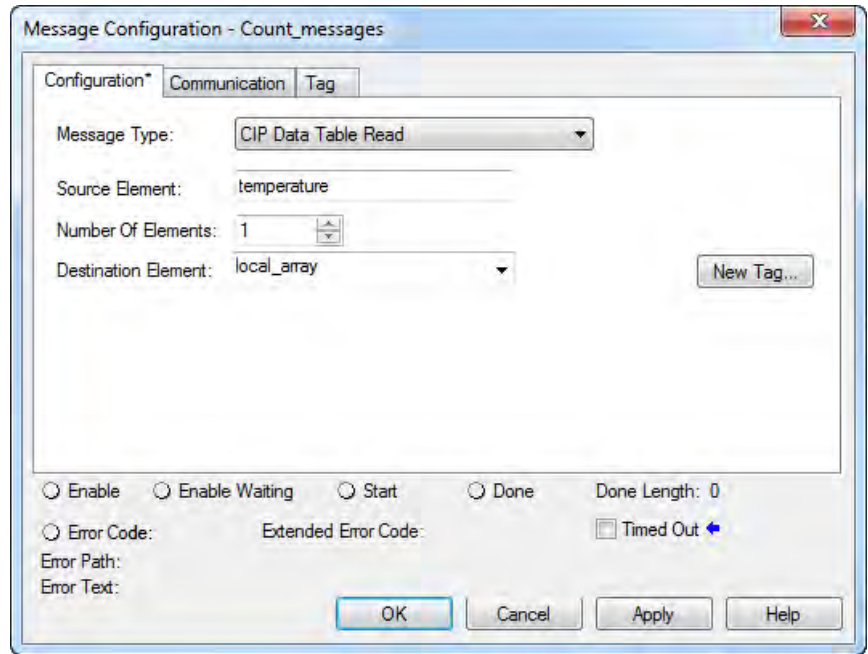

2. From the **Message Type** pull-down menu, choose a message type.
3. In the **Source Element** field, type the appropriate information.
4. In the **Number of Elements** field, enter the number of elements.
5. From the **Destination Element** pull-down menu, choose the instruction's destination element.

The message instruction's destination determines how the message is configured.

Function	Configuration Box	Required Information
Read (receive) the data	Message Type	CIP Data Table Read
	Source Element	First element of the tag that contains data in the other controller
	Number of Elements	Number of elements to transfer
	Destination Tag	First element of the controller-scoped tag in this controller for the data
Write (send) the data	Message Type	CIP Data Table Write
	Source Tag	First element of the controller-scoped tag in this controller that contains the data
	Number of Elements	Number of elements to transfer
	Destination Element	First element of the tag for the data in the other controller

6. Click the **Communication** tab.



7. Specify the path of the module for which you sent the message instruction to the I/O configuration tree:

- If the module has been added, click **Browse** to choose the path.
- If the module has not been added, type the path in the **Path** field.

8. Click **OK**.

Stagger the Messages

As you add messages to your project, you may have to coordinate the execution of the messages. To avoid errors and assure that each message is processed, follow these rules.

Rule 1	Enable no more than 16 messages at one time, including block transfers.
Rule 2	Enable no more than 10 of these types of messages at one time: <ul style="list-style-type: none"> • CIP data table reads or writes that are not cached • CIP generic • PLC-2, PLC-3, PLC-5, or SLC (all types) • Block transfer reads or writes that are not cached

If the number of messages in your application exceeds rules 1 and 2, then stagger the execution of your messages. Here are some options:

- Send each message in sequence.
- Send the messages in groups that are within the limits of rules 1 and 2.
- Program a message to communicate with multiple devices.

Communicate with PanelView Terminals

This chapter explains how a controller uses a ControlNet communication module to communicate with PanelView software products over a ControlNet network.

Topic	Page
Set Up the Hardware on page 95	92 on page 95
Determine Connections to PanelView Terminals on page 96	93 on page 96
Add a PanelView Terminal on page 97	94 on page 97
Organize Controller Data for a PanelView Terminal on page 100	96 on page 100

Set Up the Hardware

In this example, the controller in the local chassis shares data with an HMI application on a ControlNet network. This application could be running any of these:

- PanelView terminal
- PanelView Plus terminal
- Workstation running RSVIEW 32 software
- Workstation running an RSVIEW Enterprise application, such as RSVIEW Machine Edition software or RSVIEW Supervisory Edition software

Figure 14 - Example of Communication with PanelView and RSVIEW Products

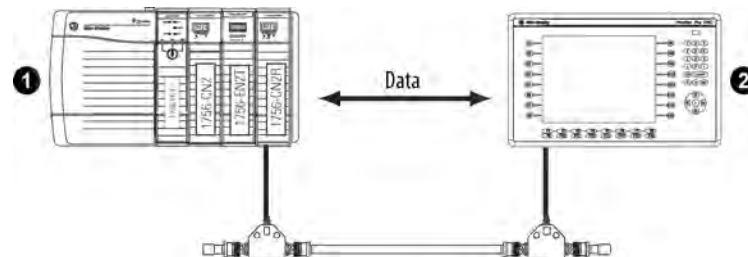

Item	Description
1	Local controller in any of these combinations: <ul style="list-style-type: none"> • 1756 ControlLogix controller with a 1756-CN2 or 1756-CN2R communication module in the chassis • 1756 ControlLogix controller with a 1756-CNB or 1756-CNBR communication module in the chassis • 1768-L43 CompactLogix controller with a 1768-CNB or 1768-CNBR communication module in the chassis • 1769-L32C or 1769-L35CR CompactLogix controller • 1789 SoftLogix controller with a 1784-PCICS communication card • PowerFlex 700S with DriveLogix controller and a 1788-CNx ControlNet communication card
2	HMI terminal

Make sure of the following:

- The ControlNet communication modules are connected to a scheduled ControlNet network.
- All wiring and cabling are properly connected.

Determine Connections to PanelView Terminals

How you establish communication between a PanelView or PanelView Plus terminal and a Logix 5000 controller over a ControlNet network depends on how you want to use controller connections.

Communication Type	PanelView Standard	PanelView Plus
Scheduled (always connected)	Supported	Supported in revision 3.2 and later
Unscheduled (connected)	Not supported	Supported
Unscheduled (unconnected)	Supported	Not supported

A Logix controller supports up to 40 outgoing and 3 incoming unconnected buffers. This limited number of incoming unconnected buffers limits how many PanelView Standard terminals can request data from a controller.

When you use PanelView terminals with Logix 5000 controllers over a ControlNet network, remember these limitations:

- A maximum of four PanelView Standard terminals can request data from a Logix 5000 controller.
- The number of PanelView Plus terminals that can request data from a Logix 5000 controller is dependent on the number of available unconnected buffers in the Logix 5000 controller.

A typical PanelView Plus application uses 5 unconnected buffers in a Logix 5000 controller. With 32 unconnected buffers available at any time in a Logix 5000 controller, a maximum of 6 PanelView Plus terminals can request data from a Logix 5000 controller. Keep in mind, however, that if 6

PanelView Plus terminals are requesting data from a single Logix 5000 controller, few unconnected buffers remain for anything else.

For scheduled connected communication, you must add the PanelView or PanelView Plus terminal to the I/O configuration tree for the controller project.

Add a PanelView Terminal

To add a PanelView terminal, perform this procedure.

1. If your application is online, go offline.
2. In the Logix Designer application, right-click the **Backplane** and choose **New Module**.

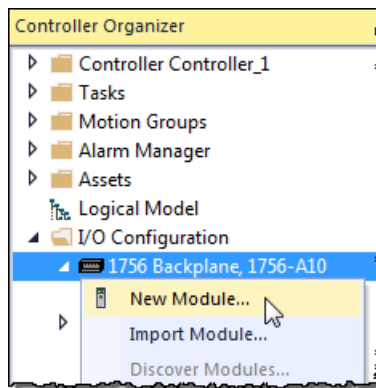

3. From the **Select Module** dialog box, select a local ControlNet communication module type and click **OK**.

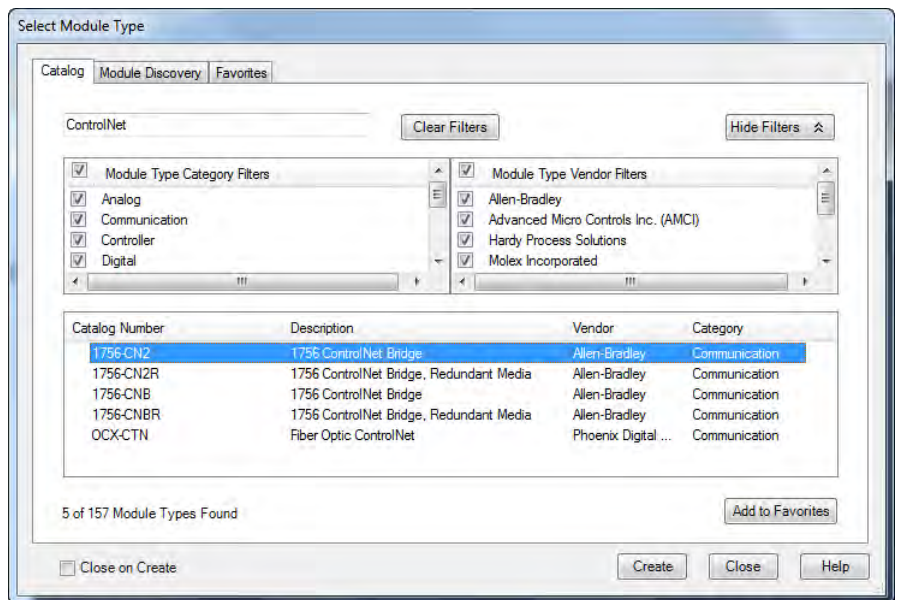

Logix 5000 Controller	Local ControlNet Communication Modules
1768 CompactLogix	1768-CNB, 1768-CNBR

Logix 5000 Controller	Local ControlNet Communication Modules
1769 CompactLogix	1769-L32C, 1769-L35CR (built-in ControlNet port)
ControlLogix	1756-CN2, 1756-CN2R, 1756-CNB, 1756-CNBR
SoftLogix	1784-PCIC (unscheduled data only) or 1784-PCICS (unscheduled data only)

- From **Module Properties** dialog box, configure the local ControlNet module.

For information on configuring local ControlNet communication modules, refer to [Configure a ControlNet Module on page 29](#) on [page 31](#).

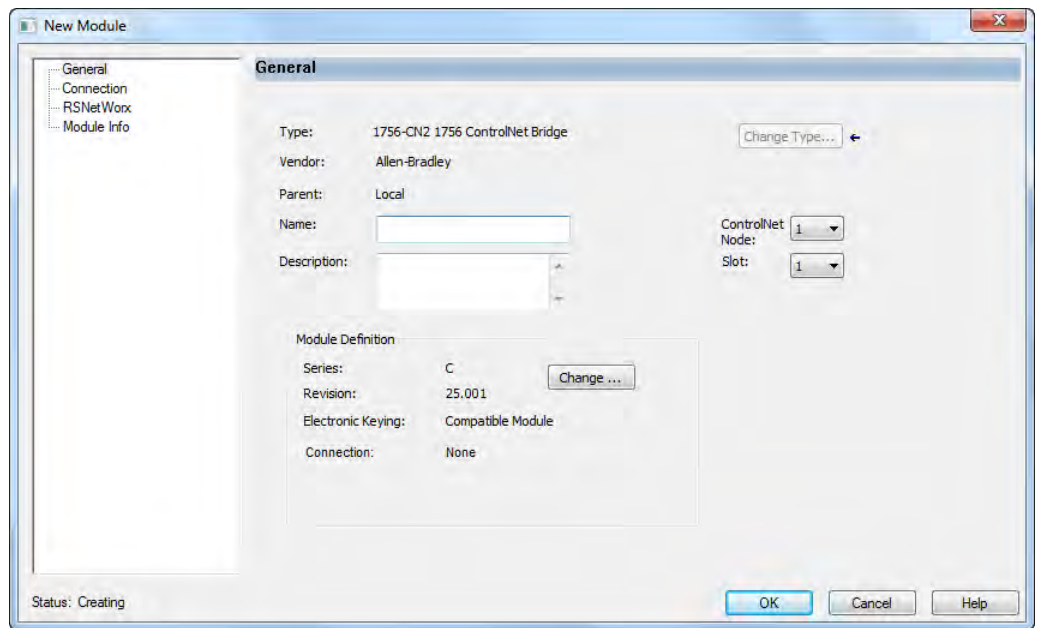

- Right-click the local communication module and choose **New Module**.

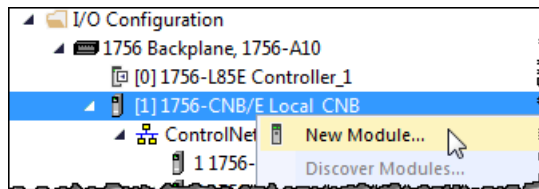

- From the **Select Module** dialog box, select the PanelView terminal and click **OK**.

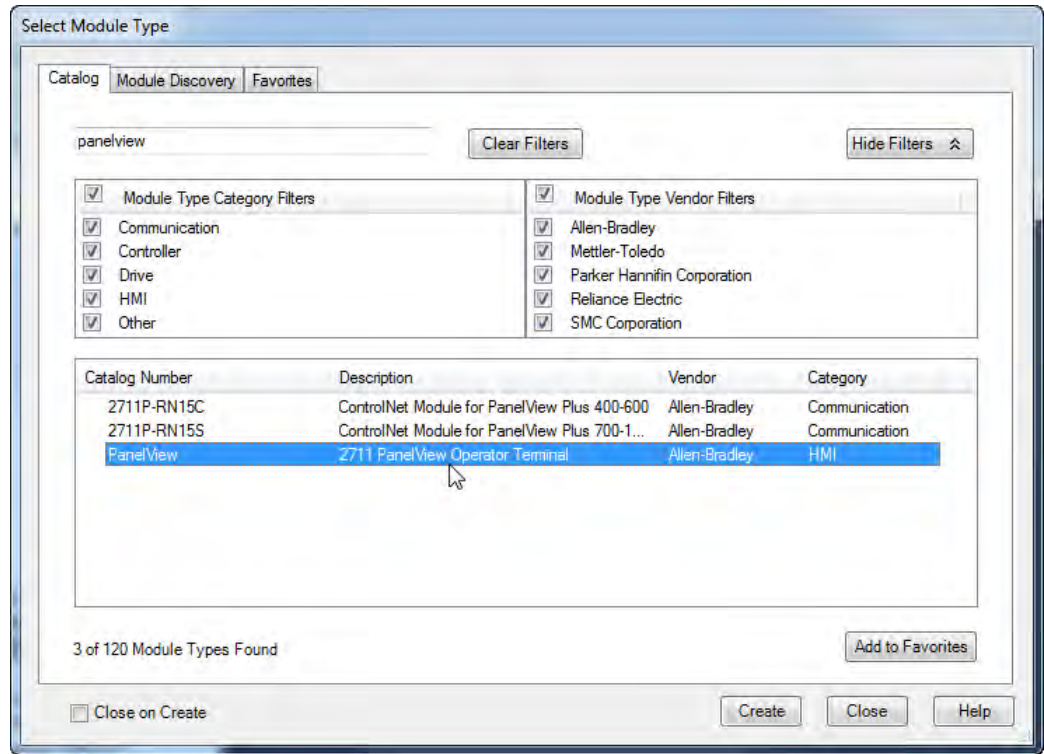

- From the **Module Properties** dialog box, configure the terminal.

For information on configuring local ControlNet communication modules, refer to [Configure a ControlNet Module on page 29](#) on [page 31](#).

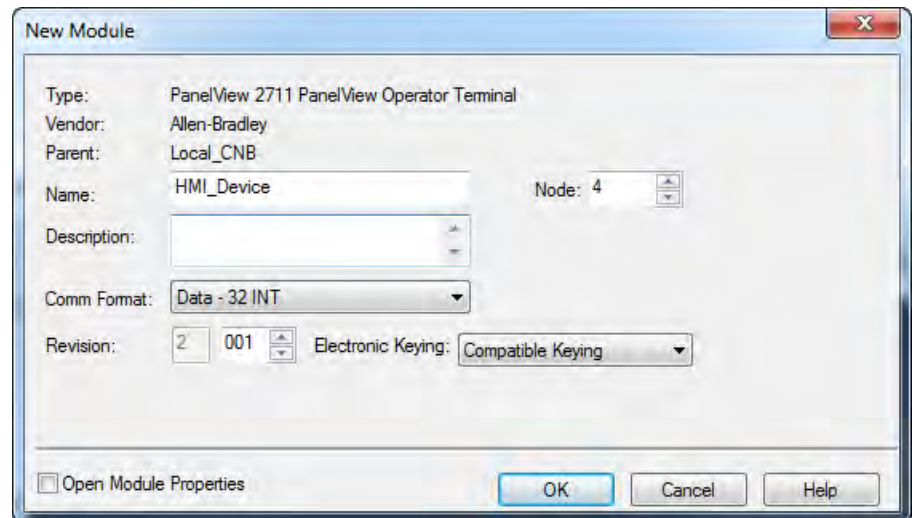

Organize Controller Data for a PanelView Terminal

Organize data for a PanelView or PanelView Plus terminal based on how the data is used.

Data Type	Required Actions
Time-critical scheduled data (PanelView terminals only)	Use the I/O tags of the terminal. The terminal supports a maximum of 32 input tags and 32 output tags. The tags for this data were created when you added the PanelView terminal to the I/O configuration of the controller. They are similar to the tags of I/O modules.
Not time-critical (PanelView or PanelView Plus terminals)	Create arrays to store the data. 1. For each screen, create a BOOL array with enough elements for the bit-level objects on the screen. For example, the BOOL[32] array gives you 32 bits for push buttons and indicators. 2. For each screen, create a DINT array with enough elements for the word-level objects on the screen. For example, the DINT[28] array gives you 28 values for numeric entry controls and numeric displays.

To access the scheduled I/O tags of the PanelView terminal, use these address formats.

Terminal Function	Address Definition
Writes the data	name_of_terminal:I.Data[x].y
Reads the data	name_of_terminal:O.Data[x].y

Address Variable	Definition
name_of_terminal	Name of the instance in the I/O configuration of the controller
x	Element of the input (I) or output (O) structure.
y	Bit number within the input or output element

A

access

- access data 66
- produced and consumed data 16
- scheduled I/O tags 98

actual packet interval 18

adjust

- media configuration 46, 51
- tags for bandwidth limitations 77

API. See actual packet interval 18

B

bandwidth

- limitations 77
- rack-optimized communication format 58
- requested packet interval rate 58
- unscheduled maximum node address 21

bridge across networks 13

C

cache message connections 88

capacity of ControlNet network 24

communicate

- between computer and devices 27
- between controller and devices 69
- communicate across networks 13
- with I/O modules 65
- with PanelView products 93

communication driver 28

communication format

- distributed I/O 66
- effect on requested packet interval 58
- rack optimized 61
- select 58, 66

communication path 51

configure

- configure ControlNet module 31
- ControlNet communication driver 28
- message instructions 89

connection

- between computer and ControlNet network 27
- for produced and consumed tags 75
- validate 69

consumed tags

creating in Logix Designer software 81

defined 73

determine connections 75

guidelines 76

organize tag data 76

control I/O 57

ControlNet module

- bridge across networks 13
- configure 31
- overview 11

ControlNet network

- capacity 24
- connect a computer 27
- IX ControlNet network topology 22
- schedule 19
- scheduleIXControlNetnetworkschedule 45

D

data types 73, 76, 78, 81

distributed I/O

- access data 66
- communication formats 66

download Logix Designer project 38

E

electronic keying 39

enter message logic 88

I

I/O

- control 57
- rack optimized connections 61
- scheduled 19

interlocking controllers. See produced tags or consumed tags 73

K

keeper, network 20

keying, electronic 39

L

local ControlNet module 31

Logix 5000 controller

- consumed tags 81
- direct or rack-optimized connections 59
- local ControlNet module 31
- produced tags 78
- remote ControlNet module 34

Logix Designer software

- add PanelView terminal 95
- communication format 58
- create consumed tag 81
- create produced tag 78
- download project 38

M

- media configuration 46, 51
- message instructions
 - cache message connections 88
 - configure 89
 - guidelines 86
 - staggering messages 91
- message logic 88

N

- network keeper 20
- network update time 16, 21, 58, 76, 77
- NUT. See network update time 17

O

- ownership types 62, 63

P

PanelView terminal

- connection to Logix 5000 controller 94
- controller data 98
- hardware setup 93
- Logix Designer software setup 95
- select 95

peer-to-peer messaging 85

produced tags

- defined 73
- determine connections 75
- guidelines 76
- organize tag data 76
- produced tags 78

R

- rack-optimized communication format 61
- remote ControlNet module 34
- requested packet interval 58
- RPI. See requested packet interval 58
- RSLinx Classic software 28
- RSNetWorx for ControlNet software
 - configure network keeper 20
 - schedule network 45
- RSView software 93

S

- schedule ControlNet network 19, 45
- scheduled I/O 19
- scheduled maximum node address 21
- select
 - communication driver 28
 - communication format 58, 66
 - communication path 51
 - local communication module 31, 95
 - PanelView terminal 95
 - remote communication module 34
- set
 - communication format 58
 - network schedule parameters 46, 51
 - requested packet interval 58
 - scheduled maximum node address 21
 - unscheduled maximum node address 21
- SMAX. See scheduled maximum node address 21
- staggering messages in Logix Designer 91

T

- tags. See produced tags or consumed tags 73
- topology of ControlNet network 22

U

- UMAX. See unscheduled maximum node address 21
- unscheduled maximum node address 21

V

- validate connections 69

Rockwell Automation support

Rockwell Automation provides technical information on the web to assist you in using its products. At <http://www.rockwellautomation.com/support> you can find technical and application notes, sample code, and links to software service packs. You can also visit our Support Center at <https://rockwellautomation.custhelp.com> for software updates, support chats and forums, technical information, FAQs, and to sign up for product notification updates.

In addition, we offer multiple support programs for installation, configuration, and troubleshooting. For more information, contact your local distributor or Rockwell Automation representative, or visit <http://www.rockwellautomation.com/services/online-phone>.

Installation assistance

If you experience a problem within the first 24 hours of installation, review the information that is contained in this manual. You can contact Customer Support for initial help in getting your product up and running.

United States or Canada	1.440.646.3434
Outside United States or Canada	Use the Worldwide Locator available at http://www.rockwellautomation.com/locations , or contact your local Rockwell Automation representative.

New product satisfaction return

Rockwell Automation tests all of its products to ensure that they are fully operational when shipped from the manufacturing facility. However, if your product is not functioning and needs to be returned, follow these procedures.

United States	Contact your distributor. You must provide a Customer Support case number (call the phone number above to obtain one) to your distributor to complete the return process.
Outside United States	Please contact your local Rockwell Automation representative for the return procedure.

Documentation feedback

Your comments will help us serve your documentation needs better. If you have any suggestions on how to improve this document, complete the feedback form, publication [RA-DU002](#).

Rockwell Otomasyon Ticaret A.Ş., Kar Plaza İş Merkezi E Blok Kat:6 34752 İçerenköy, İstanbul, Tel: +90 (216) 5698400

www.rockwellautomation.com

Power, Control and Information Solutions Headquarters

Americas: Rockwell Automation, 1201 South Second Street, Milwaukee, WI 53204-2496 USA, Tel: (1) 414.382.2000, Fax: (1) 414.382.4444
Europe/Middle East/Africa: Rockwell Automation NV, Pegasus Park, De Kleedaan 12a, 1831 Diegem, Belgium, Tel: (32) 2 663 0600, Fax: (32) 2 663 0640
Asia Pacific: Rockwell Automation, Level 14, Core E, Cyberport 3, 100 Cyberport Road, Hong Kong, Tel: (852) 2887 4788, Fax: (852) 2508 1846

Rockwell Automation Publication CNET-UM001F-EN-P - February 2018