

Specifications*

Electrical Ratings		
Contact ratings	Refer to the contact ratings tables on page 10-4.	
Dielectric strength	2200V for one minute, 1300V for one minute (Logic Reed)	
Electrical design life cycles	1 000 000 at max. rated load, 200 000 at max. rated load (Logic Reed)	
Mechanical Ratings		
Vibration	10...2000 Hz, 1.52 mm displacement (peak-to-peak) max./ 10 G max. (except Logic Reed)	
Shock	1/2 cycle sine wave for 11 ms \geq 25 G (contact fragility) and no damage at 100 G	
Degree of protection	Type 1/4/12/13 (800T); Type 1/4/4X/12/13 (800H); EN/IEC 60529 IP66/65	
Mechanical design life cycles		
Push buttons	(Momentary, non-illuminated)	10 000 000 min.
	(Momentary, illuminated)	250 000 min.
	(Push-pull/twist-to-release)	250 000 min.
Selector switches	(Non-illuminated)	1 000 000 min.
	(Illuminated, key-operated)	200 000 min.
Potentiometers	25 000 min.	
All other devices	200 000 min.	
Contact operation	Shallow, mini, and low-voltage contact blocks: Slow, double make and break Logic Reed and sealed switch contact blocks: Single break magnetic	
Wire gauge/Terminal screw torque	#18...14 AWG (#18...10 Max Duty) / 6...8 lb•in	
Typical operating forces		
Operators without contact blocks	Flush, extended button, standard mushroom, jumbo plastic mushroom: 2 lbs max. Jumbo and extended aluminum mushroom head: 3.95 lbs max. Maintained selector switch: 3.6 in•lb max.	
Spring return selector switches	3.6 in•lb to stop, 0.2 in•lb to return	
Illuminated push buttons and push-to-test pilot lights	5 lb max.	
2-position push-pull	8.0 lb max. push or pull	
3-position push-pull	8 lb max. push to in position or pull to center position (15 lb max. pull to out position)	
Twist-to-release or push-pull	9 lbs max. push or pull 30 in•oz max. twist, 6 in•oz minimum return	
Potentiometer	Rotational torque 3...12 in•oz; stopping torque 12 in•lb (minimum)	
Contact blocks	Standard	1 lb
	Logic Reed	1 lb max.
	Sealed switch	3 lb max. at 0.205 in. plunger travel
	Stackable sealed switch	1 lb max.
	MaxDuty	1.4 lb max.
	PenTUFF	1.4 lb max.
Self Monitoring	1.6 lb	
Environment		
Temperature range	Operating	-40...+131 °F (-40...+55 °C)
	Storage	-40...+185 °F (-40...+85 °C)
Note: Operating temperatures below freezing are based on the absence of moisture and liquids. Consult your local Rockwell Automation sales office or Allen-Bradley distributor for use in lower temperature applications.		
Humidity	50...95% RH from 77...140 °F (25...60 °C) per Procedure IV of MIL-STD-810C, Method 507.1 cycling test	

* Performance Data — See Important- 3.

30.5 mm Push Buttons

Specifications

Standard Contact Ratings

Minimum: 24V, 24 mA

Maximum thermal continuous current I_{th} 10 A AC/2.5 A DC. Bulletin 800T units with 800T-XA contacts have ratings as follows:

Max. Operntl. Volts U_e	Utilization Category		Rated Operational Currents		
	IEC	NEMA	Volts U_e	Make	Break
AC 600	AC-15	A600	120...600	7200VA	720VA
			72...120	60 A	720VA
			24...72	60 A	10 A
DC 600	DC-13	Q600	28...600	69VA	
			24...28*	2.5 A	

* For applications below 24V/24 mA, PenTUFF or Logic Reed contacts are recommended.

Sealed Switch Contact Ratings

Minimum: 5V, 1 mA

Maximum continuous current I_{th} 5 A. Bulletin 800T units have control circuit ratings with sealed switch contact blocks as follows:

Max. Operntl. Volts U_e	Utilization Category		Rated Operational Currents		
	IEC	NEMA	Volts U_e	Make	Break
AC 600	AC-15	B600	120...600	3600VA	360VA
			0...120	30 A	3 A
DC 300	DC-13	P300	24...300	138VA	
			0...24	5.0 A	

Stackable Sealed Switch Contact Ratings

Minimum: 5V, 10 mA (digital); 24V, 1 mA (analog)

Maximum continuous current I_{th} 2.5 A. Bulletin 800T units have control circuit ratings with sealed switch contact blocks as follows:

Max. Operntl. Volts U_e	Utilization Category		Rated Operational Currents		
	IEC	NEMA	Volts U_e	Make	Break
AC 300	AC-15	C300	120...300	1800VA	180VA
			0...120	15 A	1.5 A
DC 150	DC-13	Q150	24...150	69VA	
			0...24	2.5 A	

Logic Reed Contact Ratings

Minimum — DC: 5V, 1 mA

Maximum — DC: 30V, 0.06 A, AC: 150V, 0.15 A

Should only be used with resistive loads.

Materials Used in 800H Type 4X Operators Thermoplastic Polyester (Fiberglass Reinforced)

- Bushings
- Mounting Rings
- Sockets

Thermoplastic Polyester

- Non-illuminated button caps

Transparent Amorphous Nylon

- Pilot light lens cap
- Illuminated button caps

Glass Filled Crystalline Nylon

- Thrust washer

Mineral Filled Nylon

- Trim washer

Nitrile (Synthetic Rubber)

- Gaskets and internal seals

PenTUFF™ (Low Voltage) Contact Ratings

Minimum DC: 5V, 1 mA

Maximum thermal continuous current I_{th} 2.5 A AC/1.0 A DC. Bulletin 800T units with 800T-XAV contacts have ratings as follows:

Max. Operntl. Volts U_e	Utilization Category		Rated Operational Currents		
	IEC	NEMA	Volts U_e	Make	Break
AC 300	AC-15	C300	120...300	1800VA	180VA
			0...120	15 A	1.5 A
DC 150	DC-13	R150	24...150	28VA	
			0...24	1.0 A	

Snap Action Contact Ratings

Max. Operntl. Volts U_e	Contact Rating Designation	Rated Operational Currents		
		Volts U_e	Make	Break
AC 300	A300	120...300	7200VA	720VA
		24...72	60 A	10 A
DC 250	—	230...250	0.2 A	
		115...125	0.4 A	

MaxDuty Contact Rating

Maximum thermal continuous current I_{th} 24 A.

Pilot Duty — 120V AC, 12 A; 24V DC, 10 A

Motor Ratings — 120V AC, 1.5 Hp; 240V AC, 3 Hp; 24V DC, 10 A FLA/60 A LRA

Time Delay Contacts

Max. Operntl. Volts U_e	Contact Rating Designation	Rated Operational Currents		
		Volts U_e	Make	Break
AC 120	B150	120	3600VA	360VA

Note: This device is not rated for DC applications.

Adjustment range: 0.5...15 s \pm 25% I_{th} = 5 A

Product Selection
 Assembled Stations



Die Cast Aluminum
 Cat. No. **800T-2TAR**



Booted Operator – Stainless Steel
 Cat. No. **800H-1HA4T**



Booted Operator – Glass Polyester
 Cat. No. **800H-1HA4R**

Operator	Contact Symbol	Contact Action	Button Type	Button Color	Legend Marking	Type 4/13	Type 4/4X/13	
						Die Cast Aluminum Cat. No.	Booted Operator – Stainless Steel Cat. No.*	Booted Operator – Glass Polyester Cat. No.*
One Push Button		Momentary	Extended	Red	STOP	800T-1TA	800H-1HA4T	800H-1HA4R
		Momentary	Flush	Green	START	800T-1TB	800H-1HB4T	800H-1HB4R
		Momentary	Flush	Black	No Legend	800T-1TX	800H-1HX4T	800H-1HX4R
Two Push Buttons		Momentary	Flush Extended	Green Red	START STOP	800T-2TA	800H-2HA4T	800H-2HA4R
		Momentary	Flush Flush	Black Black	No Legend	800T-2TX	800H-2HX4T	800H-2HX4R
One Pilot Light, Two Push Buttons		Momentary	120V AC Flush Extended	Red Green Red	No Legend START STOP	800T-2TAR	800H-2HAR4T	800H-2HAR4R
		Momentary	120V AC Flush Flush	Red Black Black	No Legend	800T-2TXR	800H-2HXR4T	800H-2HXR4R
3-Position Selector Switch		Maintained	Knob Lever	Black with white insert	HAND-OFF-AUTO	800T-R3TA	—	—
		Maintained	Knob Lever	Black with white insert	No Legend	800T-R3TX	—	—
One Push Button		Maintained	Push-Pull/Twist	Red	EMERG STOP	800T-1TYM*	—	—
Two Push Buttons		Maintained	Flush Extended	Green Red	START STOP	800T-2TAM	800H-2HAM4T	800H-2HAM4R
		Maintained	Flush Flush	Black Black	No Legend	800T-2TXM	800H-2HXM4T	800H-2HXM4R

* Boot material is chlorosulfonated polyethylene. Add suffix **L** to the cat. no. for station with bootless operators. Example: **Cat. No. 800H-1HB4T** becomes **Cat. No. 800H-1HB4TL**.

* Supplied with yellow legend plate to comply with IEC 60947-5-5 and NFPA79 E-Stop standards that require yellow background.

DeviceNet Stations

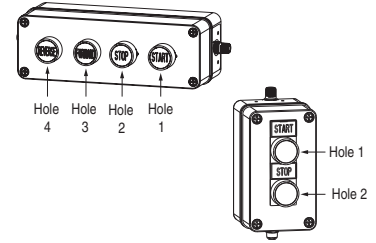

Two-Unit

800T –

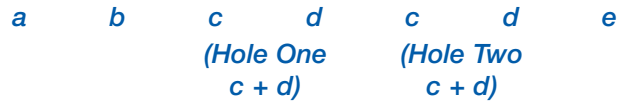

Three-Unit

800T –

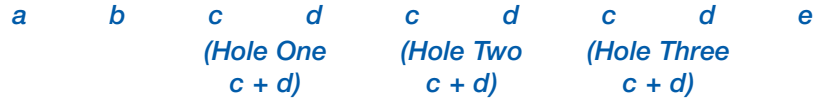

Four-Unit

800T –

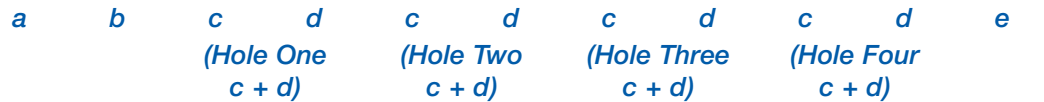

a

Orientation	
Code	Description
V	Vertical
H	Horizontal

b

Enclosure Style		
Grey Code	Description	Yellow Code
A	2-hole	K
B	3-hole	L
C	4-hole	M
G	E-stop only§	N

c

Operator Types	
Code	Description
A	Non-illuminated flush (800T-A*)
B	Non-illuminated extended (800T-B*)
C	Non-illuminated mushroom (800T-D*)
D	Illuminated mushroom (800T-QM*)
E	Illuminated extended (800T-QB*)
F	Illuminated guarded (800T-QA*)
G	2-position SS maintained (800T-H2*)
H	3-position SS maintained (800T-J2*)
J	Enhanced pilot light (800T-QH*)
K	Non-illuminated 2-position push/pull (800T-FX*)‡
L	Non-illuminated push/pull twist-to-release (800T-FXT*)‡
M	Illuminated 2-position push/pull (800T-FXQH*)
N	2-position key SS (800T-H33*)*
P	3-position key SS (800T-J44*)*
Q	2-position SS spring return from right (800T-H5*)
R	3-position SS spring return from all (800T-J91*)
T	Illuminated 2-position SS maintained (800T-24H*H*)
U	Illuminated 3-position SS maintained (800T-24J*H*)
V	Non-illuminated 3-position push/pull (800T-FXM*)
W	Potentiometer‡

d

Color/Text	
Code	Description
1	Green
2	Black (non-illuminated only)
3	Orange (non-illuminated only)
4	Grey (non-illuminated only)
5	White
6	Red
7	Blue
8	Clear (illuminated only)
9	Yellow (non-illuminated)/amber (illuminated)
A	Green with Start legend
B	Red with Stop legend
C	Red with E-Stop legend
D	Black with Off/On legend
E	Black with Hand/Off/Auto legend
F	Red with Push to Stop/Pull to Start legend
G	Blue with Reset legend
H	Red with Power On legend
X	N/A (i.e. key ss)

e

External I/O Version>	
Code	Description
Blank	No external I/O
A	1 input/1 output (sinking)
B	1 input/1 output (sourcing)
C	2 input
D	2 output (sinking)
E	2 output (sourcing)
F	1 E-stop block*
G	2 E-stop blocks*
H	2 input + 2 output
J	2 input + 2 output (sinking)
K	2 input + 2 output (sourcing)
L	1 input/1 output (sinking) + 1 E-stop block*
M	1 input/1 output (sourcing) + 1 E-stop block*
N	1 input/1 output (sinking) + 2 E-stop blocks*
P	1 input/1 output (sourcing) + 2 E-stop blocks*
Q	2 input + 1 E-stop block*
R	2 input + 2 E-stop blocks*
T	2 output (sinking) + 1 E-stop block*
U	2 output (sourcing) + 1 E-stop block*
V	2 output (sinking) + 2 E-stop blocks*
W	2 output (sourcing) + 2 E-stop blocks*
X	2 input + 1 input/1 output (sinking)
Y	2 input + 1 input/1 output (sourcing)

* Operator Types N and P from Table c must choose Color/Text option X from Table d.
 ‡ Operator Types K and L from Table c may be used as Emergency Stops. To be valid as an E-Stop, the operators must use Color/Text option C from Table d and it must be placed in the last hole position in the enclosure. An E-Stop connector also must be chosen from Table e.
 § Enclosure Style option G from Table b can only select one operator from Table c. Valid options are K and L with E-Stop.
 * External I/O Versions F, L, M, Q, T and U receive only one contact block for the external E-Stop string. These connectors are rated to 3 A. If more than 3 A of current is needed or if there are two E-Stop strings, use External I/O Versions G, N, P, R, V, and W. These versions receive two contact blocks. This allows for 6 A of switching or for two E-Stop strings.
 > This is an 8-in/4-out device. 2-in/1-out is assigned to each hole position in the enclosure. If a 2-hole enclosure is selected, 4-in and 2-out are assigned internally and up to 4 unassigned I/O points can be assigned to external connectors. This device contains up to two physical external I/O connectors. The "+" symbol in the Description field of Table e indicates that two external connectors exist. If an E-Stop connector is used, 2 unassigned I/O points can be assigned to the other connector.
 ‡ Available for certain applications, please contact your local Allen-Bradley distributor.

2-Position Red Trigger Action Twist-to-Release, Non-Illuminated

- Tamper resistant – front-of-panel mounting and non-removable operator head
- Compliant with global E-stop standards, including EN ISO 13850 and EN 60947-5-5



Cat. No. 800T-TFXJET6



Cat. No. 800T-TFXLET6



Cat. No. 800T-TFXK6



Cat. No. 800H-TFRXT6

Contact Type	Operator Position		Type 4/13			Type 4/4X/13
			45 mm Plastic	63 mm Metal	Key Release	45 mm Plastic
	Out	In	Cat. No.* ‡	Cat. No.* §	Cat. No.* ♣	Cat. No.* ‡
No contacts	—	—	800T-TFXT6	800T-TFXLT6	800T-TFXK6	800H-TFRXT6
1 N.C.	X	O	800T-TFXT6D2	800T-TFXLT6D2	800T-TFXK6D2	800H-TFRXT6D2
1 N.O. - 1 N.C.	O X	X O	800T-TFXT6A	800T-TFXLT6A	800T-TFXK6A	800H-TFRXT6A
1 S.M.C.B.➤	X	O	800TC-TFXT6D4S	800TC-TFXLT6D4S	800TC-TFXK6D4S	800HC-TFRXT6D4S

- * For finger-safe contact block terminals, add a **C** to the cat. no. Example: Cat. No. 800TC-TFXT6 or 800HC-TFRXT6.
- ‡ To order a device with a jumbo (60 mm) plastic head add the letter **J** after **X**. Example: Cat. No. 800T-TFXJT6A or 800H-TFRXT6A.
- § To order a device with "E-STOP" engraved on the cap add the letter **E** after **L**. Example: Cat. No. 800TC-TFXLET6D4S.
- ♣ Provided with two DO18 keys.
- Self-monitoring contact block.



Protection Rating	
Code	Description
T	Metal, Type 4/13
H	Plastic, Type 4/4X/13

Finger-Safe Guards	
Code	Description
Blank	No guards
C	Guards on terminals

Head Type [‡]		
800T Type 4/13	Description	800H Type 4/4X/13
Code		Code
FX	Standard (45 mm) mushroom head	FRX
FXJ	Jumbo (60 mm) mushroom head	FRXJ
FXJE	Jumbo (60 mm) mushroom head with "E-STOP"	FRXJE
FXK	45 mm mushroom head key release	—
FXL	63 mm anodized aluminum head	—
FXLE	63 mm anodized aluminum head with "E-STOP"	—

Release Function	
Code	Color
Blank	Key release [♣]
T	Twice release

Note: X = Closed/O = Open
[♣] Configurable only with **FXK** head type.

Contact Block(s)			
Code	Operator Position		Description
Blank	—	—	No contacts on operator
Standard			
D1	O	X	1 N.O.
D2	X	O	1 N.C.
D4	X	O	1 N.C.L.B.
A	O X	X O	1 N.O. - 1 N.C.
A1	O X	X O	1 N.O. - 1 N.C.L.B.
A5	X X	O O	2 N.C.L.B.
PenTUFF (Low Voltage)			
D1V	O	X	1 N.O.
D2V	X	O	1 N.C.
D4V	X	O	1 N.C.L.B.
AV	O X	X O	1 N.O. - 1 N.C.
Class 1, Div. 2/Zone 2			
Logic Reed			
D1R	O	X	1 N.O.
D2R	X	O	1 N.C.
AR	O X	X O	1 N.O. - 1 N.C.
Sealed Switch			
D1P	O	X	1 N.O.
D2P	X	O	1 N.C.
AP	O X	X O	1 N.O. 1 N.C.
Stackable Sealed Switch			
D1Y	O	X	1 N.O.
D2Y	X	O	1 N.C.
AY	O X	X O	1 N.O. - 1 N.C.

Bulletin 800T/H
30.5 mm Push Buttons
 Emergency Stop Operators

2-Position Red Trigger Action Twist-to-Release, Illuminated

- Tamper resistant – front-of-panel mounting and non-removable operator head
- Compliant with global E-stop standards, including EN ISO 13850 and EN 60947-5-5
- LED illumination provided as standard

Type	Volts	Contacts	Operator Position		Type 4/13		Type 4/4X/13			
			Out	In	45 mm*	60 mm*‡	45 mm*	60 mm*‡		
Operator only‡					No contacts		800T-TFXTS00R	800T-TFXJTS00R	800H-TFRXTS00R	800H-TFRXJTS00R
Universal	12...130V AC/DC	N.O. - N.C.	O	X	800T-TFXTQH2RA	800T-TFXJTQH2RA	800H-TFRXTQH2RA	800H-TFRXJTQH2RA		
Transformer	120V AC 50/60 Hz		X	O	800T-TFXTPH16RA	800T-TFXJTPH16RA	800H-TFRXTPH16RA	800H-TFRXJTPH16RA		

Note: X = Closed/O = Open

* For finger-safe contact block terminals, add a **C** to the cat. no. Example: Cat. No. 800TC-TFXTS00R or 800HC-TFRXTS00R.

‡ To order a device with "E-STOP" printed on the cap add the letter **E** after **J**. Example: Cat. No. 800T-TFXJETQH2RA or 800H-TFRXJETQH2RA.

‡ Operator-only supplied without power module, lamp, or contact blocks.

800 **T** **-** **T** **FXT** **QH** **2** **R** **A**
 a **b** **c** **d** **e** **f**

a

Protection Rating	
Code	Description
T	Metal, Type 4/13
H	Plastic, Type 4/4X/13

b

Finger-Safe Guards	
Code	Description
Blank	No guards
C	Guards on terminals

c

Head Type§		
800T Type 4/13	Description	800H Type 4/4X/13
Code		Code
FXT	Standard (45 mm) mushroom head	FRXT
FXJT	Jumbo (60 mm) mushroom head	FRXJT
FXJET	Jumbo (60 mm) mushroom head with "E-STOP"	FRXJET



d

Illumination Option	
Code	Description
PH	Transformer with LED lamp
QH	Universal with LED lamp

e

Voltage	
Transformer	
Code	Description
16	120V AC 50/60 Hz
26	240V AC 50/60 Hz
46	480V AC 50/60 Hz
56	600V AC 50/60 Hz
Universal	
Code	Description
2	12...130V AC/DC

f

Target		
Contact		
N.O.	O	X
N.C./N.C.L.B.	X	O
Contact Blocks		
Code	Description	
Blank	No contacts	
Standard		
D1	1 N.O.	
D2	1 N.C.	
D4	1 N.C.L.B.	
A	1 N.O. - 1 N.C.	
A1	1 N.O. - 1 N.C.L.B.	
A5	2 N.C.L.B.	
PenTUFF (Low Voltage)		
D1V	1 N.O.	
D2V	1 N.C.	
D4V	1 N.C.L.B.	
AV	1 N.O. - 1 N.C.	
Class 1, Div. 2/Zone 2		
Logic Reed		
D1R	1 N.O.	
D2R	1 N.C.	
AR	1 N.O. - 1 N.C.	
Sealed Switch		
D1P	1 N.O.	
D2P	1 N.C.	
AP	1 N.O. - 1 N.C.	
Stackable Sealed Switch		
D1Y	1 N.O.	
D2Y	1 N.C.	
AY	1 N.O. - 1 N.C.	

Momentary Contact Push Button Devices, Non-Illuminated



Flush Head Unit
 Cat. No. 800T-A1A



Extended Head Unit
 Cat. No. 800T-B6A



Booted Unit
 Cat. No. 800H-R2A



Bootless Flush Head Unit
 Cat. No. 800H-AR1A

Contact Type	Button Color	Type 4/13		Type 4/4X/13	
		Flush Head	Extended Head	Booted*	Bootless Flush Head
		Cat. No.	Cat. No.	Cat. No.	Cat. No.
No Contact	Green	800T-A1	800T-B1	800H-R1	800H-AR1
	Black	800T-A2	800T-B2	800H-R2	800H-AR2
	Red	800T-A6	800T-B6	800H-R6	800H-AR6
1 N.O.	Green	800T-A1D1	800T-B1D1	800H-R1D1	800H-AR1D1
	Black	800T-A2D1	800T-B2D1	800H-R2D1	800H-AR2D1
	Red	800T-A6D1	800T-B6D1	800H-R6D1	800H-AR6D1
1 N.C.	Green	800T-A1D2	800T-B1D2	800H-R1D2	800H-AR1D2
	Black	800T-A2D2	800T-B2D2	800H-R2D2	800H-AR2D2
	Red	800T-A6D2	800T-B6D2	800H-R6D2	800H-AR6D2
1 N.O. - 1 N.C.	Green	800T-A1A	800T-B1A	800H-R1A	800H-AR1A
	Black	800T-A2A	800T-B2A	800H-R2A	800H-AR2A
	Red	800T-A6A	800T-B6A	800H-R6A	800H-AR6A

800 T - A 1 A
 a b c d e f

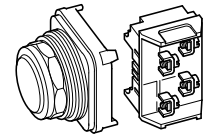

a

Protection Rating	
Code	Description
T	Metal, Type 4/13
H	Plastic, Type 4/4X/13

b

Finger-Safe Guards	
Code	Description
Blank	No guards
C	Guards on terminals

c

Operator Type		
800T Type 4/13	Description	800H Type 4/4X/13
Code		Code
A	Flush head	AR
B	Extended head	BR
D	Mushroom head	DR
DX	Mushroom head less color cap	DRX
—	Bootless guarded head	GR
—	Booted head	R*

d

Color Cap	
Code	Description
Blank	Used only when ordering Operator Type DX/DRX
1	Green
2	Black
3	Orange*

d (cont'd)

Color Cap	
Code	Description
4	Grey*
5	White*
6	Red
7	Blue
9	Yellow

e

Special Mushroom Head	
Code	Description
J§	Jumbo mushroom head — plastic
L§	Jumbo mushroom head — metal

Note: Special mushroom head options only apply to mushroom head operator type code D/DR (Table c).

f

Contact Block(s)	
Code	Description
Blank	No contacts
Standard	
D1	1 N.O.
D2	1 N.C.
D3	1 N.O.E.M.
D4	1 N.C.L.B.
D5	1 N.O. (Mini)
D6	1 N.C. (Mini)
A1	1 N.C.L.B. - 1 N.O.
A2	2 N.O.‡
A4	2 N.C.
A7	1 N.C.L.B. - 1 N.C.
A	1 N.O. - 1 N.C.
B	2 N.O. - 2 N.C.

f (cont'd)

Contact Block(s)	
Code	Description
PenTUFF (Low Voltage)	
D1V	1 N.O.
D2V	1 N.C.
D3V	1 N.O.E.M.
D4V	1 N.C.L.B.
AV	1 N.O. - 1 N.C.
BV	2 N.O. - 2 N.C.

f (cont'd)

Time Delay	
Code	Description
T	1 N.O. Depress close, delayed opening
S	1 N.C. Depress open, delayed closure

f (cont'd)

Snap Action	
Code	Description
M	1 N.O. - 1 N.C.
N	2 N.O. - 2 N.C.
Class 1, Div. 2/Zone 2 Logic Reed	
D1R	1 N.O.
D2R	1 N.C.
A2R	2 N.O.‡
A4R	2 N.C.
AR	1 N.O. - 1 N.C.
BR	2 N.O. - 2 N.C.

f (cont'd)

Contact Block(s)	
Code	Description
Class 1, Div. 2/Zone 2 Sealed Switch	
D1P	1 N.O.
D2P	1 N.C.
AP	1 N.O. - 1 N.C.
BP	2 N.O. - 2 N.C.
Stackable Sealed Switch	
D1Y	1 N.O.
D2Y	1 N.C.
A2Y	2 N.O.
A4Y	2 N.C.
AY	1 N.O. - 1 N.C.
BY	2 N.O. - 2 N.C.

Time Delay Contacts

Series C field installable kits can only be used with Series T or later operators. Adjustable range of 0.5 to 15 s + 25%. Maximum continuous current I_{th} 5 A.

Snap Action Contacts

Snap-action contacts feature a quick make, quick break snap-action mechanism that is only available on factory assembled units. Maximum continuous current I_{th} 10 A.

* Underlying operators are "flush head" type, except red which are "extended head". Boot material is chlorosulfonated polyethylene.
 † Not available for booted operators.
 ‡ A2 and A2R contact blocks cannot be stacked upon, but can stack on other contact blocks.
 § Jumbo mushroom heads not available in white color.



Bulletin 800T/H
30.5 mm Push Buttons
 Push Button Operators

Momentary Contact Push Button Devices, Illuminated



Extended Head Without Guard
Cat. No. 800T-PB16R



Extended Head with Guard
Cat. No. 800H-PRB16R

Type	Lamp Type	Volts	Color	Type 4/13		Type 4/4X/13	
				Extended Head Without Guard*	Extended Head With Guard*	Extended Head without Guard*	Extended Head with Guard*
				Cat. No.	Cat. No.	Cat. No.	Cat. No.
Operator Only*				800T-SB00XX	800T-SA00XX	800H-SRB00XX	800H-SRA00XX
Full Voltage	Incandescent	24V AC/DC	Red	800T-QB24R	800T-QA24R	800H-QRB24R	800H-QRA24R
			Green	800T-QB24G	800T-QA24G	800H-QRB24G	800H-QRA24G
			Amber	800T-QB24A	800T-QA24A	800H-QRB24A	800H-QRA24A
	No Lamp	0...250V AC/DC	No Lens	800T-QBN25	800T-QAN25	800H-QRBN25	800H-QRAN25
Universal	LED	12...130V AC/DC	Red	800T-QBH2R	800T-QAH2R	800H-QRBH2R	800H-QRAH2R
			Green	800T-QBH2G	800T-QAH2G	800H-QRBH2G	800H-QRAH2G
			Amber	800T-QBH2A	800T-QAH2A	800H-QRBH2A	800H-QRAH2A
Transformer	Incandescent	120V AC, 50/60 Hz	Red	800T-PB16R	800T-PA16R	800H-PRB16R	800H-PRA16R
			Green	800T-PB16G	800T-PA16G	800H-PRB16G	800H-PRA16G
			Amber	800T-PB16A	800T-PA16A	800H-PRB16A	800H-PRA16A
	LED		Red	800T-PBH16R	800T-PAH16R	800H-PRBH16R	800H-PRAH16R
	Green		800T-PBH16G	800T-PAH16G	800H-PRBH16G	800H-PRAH16G	
	Amber		800T-PBH16A	800T-PAH16A	800H-PRBH16A	800H-PRAH16A	
	No Lamp		No Lens	800T-PBN16	800T-PAN16	800H-PRBN16	800H-PRAN16

* Includes as standard one Cat. No. 800T-XA (1 N.O. - 1 N.C.) contact block.

* Operator only supplied without power module, lamp, lens cap, or contact blocks.

800 **T** **-** **P** **B** **H** **16** **R**
a b c d e f g h

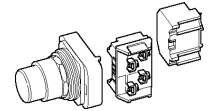

a

Protection Rating	
Code	Description
T	Metal, Type 4/13
H	Plastic, Type 4/4X/13

b

Finger-Safe Guards	
Code	Description
Blank	No guards
C	Guards on terminals

c

Power Module Type		
800T Type 4/13	Description	800H Type 4/4X/13
Code		Code
P	Transformer (or dual input)	PR
Q	Full voltage/ Universal	QR

d

Head Type	
Code	Description
A	Extended head with guard
B	Extended head without guard
M	Mushroom
MJ	Jumbo mushroom

e

Illumination Options	
Code	Description
Blank	Incandescent
H	LED
Dual Input	
D	Diode type ‡
T	Transformer — relay type
TH	Transformer — relay type LED

f

Voltage	
Transformer	
Code	Description
16	120V AC, 50/60 Hz
26	240V AC, 50/60 Hz
46	480V AC, 50/60 Hz
56	600V AC, 50/60 Hz
Full Voltage — Incandescent	
12	12V AC/DC
24	24V AC/DC
48	48V AC/DC
10	120V AC/DC
20	240V AC/DC
Universal — LED	
2	12...130V AC/DC
Dual Input	
16	120V AC
24	24V AC/DC ➤

g

Lens Color	
Code	Description
Blank	No lens with standard contacts 1 N.O. - 1 N.C.
X	No lens if ordering any contacts other than standard 1 N.O. - 1 N.C.
A	Amber
B	Blue
C	Clear
G	Green
R	Red
W	White

h

Contact Block(s)	
Code	Description
X	No contacts
Standard	
Blank	1 N.O. - 1 N.C.
D1	1 N.O.
PenTUFF (Low Voltage)	
AV	1 N.O. - 1 N.C.
Class 1, Div. 2/Zone 2	
Logic Reed	
AR	1 N.O. - 1 N.C.
Sealed Switch	
AP	1 N.O. - 1 N.C.
Stackable Sealed Switch	
AY	1 N.O. - 1 N.C.

‡ Diode type dual input provides circuit isolation via opposing diodes. Not recommended for use with solid-state outputs.
 ➤ Dual input diode only.



Momentary Contact Push Button Devices, Non-Illuminated — With Two-Color Molded Legend Caps

Operator Only

- Less legend cap
- Less contact blocks

Button Type	Type 4/13	Type 4/4X/13
	Cat. No.	Cat. No.
Flush	800T-A00	800H-AR00
Extended	800T-B00	800H-BR00



Cat. No. 800T-A00 with
 Cat. No. 800T-LC103W
 installed



Cat. No. 800H-BR00 with
 Cat. No. 800T-LC604
 installed

Legend Caps

Text	Cap Color	Text Color	Cat. No.
	Green	White	800T-LC101W
START			800T-LC103W
ON			800T-LC105W
START / I			800T-LC121W
O			800T-LC202W
STOP	Black	White	800T-LC204W
RESET			800T-LC207W
↑			800T-LC208W
FORWARD			800T-LC209W
REVERSE			800T-LC210W
JOG			800T-LC212W
UP			800T-LC213W
DOWN			800T-LC214W
RAISE			800T-LC215W
LOWER			800T-LC216W

Text	Cap Color	Text Color	Cat. No.
IN	Black	White	800T-LC217W
OUT			800T-LC218W
HIGH			800T-LC219W
LOW			800T-LC220W
STOP / O			800T-LC222W
	White	Black	800T-LC501B
START			800T-LC503B
↑			800T-LC508B
START / I			800T-LC521B
O	Red	White	800T-LC602W
STOP			800T-LC604W
OFF			800T-LC606W
STOP / O			800T-LC622W
RESET	Blue	White	800T-LC707W
R			800T-LC711W

Note: Package Qty. = 1

800 T - A 103W A

a b c d e

a

Protection Rating	
Code	Description
T	Metal, Type 4/13
H	Plastic, Type 4/4X/13

b

Finger-Safe Guards	
Code	Description
Blank	No guards
C	Guards on terminals

c

Operator Type		
800T Type 4/13	Description	800H Type 4/4X/13
Code		Code
A	Flush head	AR
B	Extended head	BR

d

Cap Text/Color			
Code	Text	Color	
		Cap	Text
101W		Green	White
103W	START		
105W	ON		
121W	START / I		
202W	O		
204W	STOP	Black	White
207W	RESET		
208W	↑		
209W	FORWARD		
210W	REVERSE		
212W	JOG		
213W	UP		
214W	DOWN		
215W	RAISE		
216W	LOWER		
217W	IN		
218W	OUT		
219W	HIGH		
220W	LOW		
222W	STOP / O		
501B		Red	White
503B	START		
508B	↑		
521B	START / I		
602W	O	Blue	White
604W	STOP		
606W	OFF		
622W	STOP / O		
707W	RESET	Blue	White
711W	R		

e

Contact Block(s)	
Code	Description
Blank	No contacts
Standard	
D1	1 N.O.
D2	1 N.C.
D3	1 N.O.E.M.
D4	1 N.C.L.B.
D5	1 N.O. (Mini)
D6	1 N.C. (Mini)
A1	1 N.C.L.B. - 1 N.O.
A2	2 N.O.‡
A4	2 N.C.
A7	1 N.C.L.B. - 1 N.C.
A	1 N.O. - 1 N.C.
B	2 N.O. - 2 N.C.
Class 1, Div. 2/Zone 2	
Sealed Switch	
D1P	1 N.O.
D2P	1 N.C.
AP	1 N.O. - 1 N.C.
BP	2 N.O. - 2 N.C.
Stackable Sealed Switch	
D1Y	1 N.O.
D2Y	1 N.C.
A2Y	2 N.O.
A4Y	2 N.C.
AY	1 N.O. - 1 N.C.
BY	2 N.O. - 2 N.C.

e (cont'd)

Contact Block(s)	
Code	Description
PenTUFF (Low Voltage)	
D1V	1 N.O.
D2V	1 N.C.
D3V	1 N.O.E.M.
D4V	1 N.C.L.B.
AV	1 N.O. - 1 N.C.
BV	2 N.O. - 2 N.C.
Time Delay	
T	1 N.O. Depress close, delayed opening
S	1 N.C. Depress open, delayed closure
Snap Action	
M	1 N.O. - 1 N.C.
N	2 N.O. - 2 N.C.
Class 1, Div. 2/Zone 2	
Logic Reed	
D1R	1 N.O.
D2R	1 N.C.
A2R	2 N.O.‡
A4R	2 N.C.
AR	1 N.O. - 1 N.C.
BR	2 N.O. - 2 N.C.

‡ A2 and A2R contact blocks cannot be stacked upon, but can stack upon other contact blocks.



Bulletin 800T/H
30.5 mm Push Buttons
 Selector Switches

2-Position Selector Switch Devices, Non-Illuminated



Standard Knob Operator
 Cat. No. 800T-H2A



Knob Lever Operator
 Cat. No. 800T-H17A



Standard Knob Operator
 Cat. No. 800H-HR2A

Contact Type	Side	Contact	Operator Position		M = Maintained S = Spring Return	Type 4/13		Type 4/4X/13
						Standard Knob	Knob Lever	Standard Knob
			Cat. No.	Cat. No.		Cat. No.		
No Contacts	—	—	—	—	M M	800T-H2	800T-H17	800H-HR2
					S→M	800T-H4	800T-H18	800H-HR4
					M←S	800T-H5	800T-H19	800H-HR5
1 N.O.	White	A	O	X	M M	800T-H2D1	800T-H17D1	800H-HR2D1
					S→M*	800T-H4D1	800T-H18D1	800H-HR4D1
					M←S	800T-H5D1	800T-H19D1	800H-HR5D1
1 N.O. - 1 N.C.	White	A B	O X	X O	M M	800T-H2A	800T-H17A	800H-HR2A
					S→M*	800T-H4A	800T-H18A	800H-HR4A
					M←S	800T-H5A	800T-H19A	800H-HR5A

Note: X = Closed/O = Open

* Target tables are reversed from those shown.

800 T - HA 2 A

a b c d e

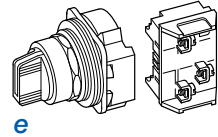

Protection Rating	
Code	Description
T	Metal, Type 4/13
H	Plastic, Type 4/4X/13

Finger-Safe Guards	
Code	Description
Blank	No guards
C	Guards on terminals

Knob Insert Colors		
800T Type 4/13	Description	800H Type 4/4X/13
Code		Code
H	White	HR
HX	Packet of colored inserts*	HRX
Metal Wing Lever Colors§		
Code	Color	Code
HA	Red	—
HG	Grey	—

Operator Type and Function	
Standard Knob	
Code	Operator Function
2	Maintained
4	Spring return from left‡
5	Spring return from right
Knob Lever§	
Code	Operator Function
17	Maintained
18	Spring return from left‡
19	Spring return from right
Metal Wing Lever§	
Code	Operator Function
11	Maintained
15	Spring return from left‡
16	Spring return from right
Coin Slot§	
Code	Operator Function
6	Maintained
7	Spring return from left
8	Spring return from right

Contact Block(s)			
Code	Contact Configuration	Description	
		2-Position	
Blank	No contacts	—	—
Standard			
D1	1 N.O.	O	X
D2	1 N.C.	X	O
A	1 N.O. - 1 N.C.	O	X
		X	O
B	2 N.O. - 2 N.C.	O	X
		X	O
		O	X
		X	O
Max Duty (Horsepower Rated)*			
D1M	1 N.O.		
D2M	1 N.C.		
PenTUFF (Low Voltage)*			
D1V	1 N.O.		
D2V	1 N.C.		
AV	1 N.O. - 1 N.C.		
BV	2 N.O. - 2 N.C.		
Class1, Div. 2/Zone 2			
Logic Reed*			
D1R	1 N.O.		
D2R	1 N.C.		
AR	1 N.O. - 1 N.C.		
BR	2 N.O. - 2 N.C.		
Sealed Switch*			
D1P	1 N.O.		
D2P	1 N.C.		
AP	1 N.O. - 1 N.C.		
BP	2 N.O. - 2 N.C.		
Stackable Sealed Switch*			
D1Y	1 N.O.		
D2Y	1 N.C.		
AY	1 N.O. - 1 N.C.		
BY	2 N.O. - 2 N.C.		

10

* One insert of each color (blue, green, orange, red, and yellow).
 ‡ Target tables are reversed from those shown.
 § Only available on Bul. 800T, Type 4/13 operators.
 * Contact target tables same as those listed for standard contact blocks.

2-Position Selector Switch Devices, Non-Illuminated (Bul. 800T only)



2-Position Cylinder Lock Operator
 Cat. No. 800T-H33A

Contact Type	Side	Contact	Operator Position		M = Maintained S = Spring Return	Type 4/13 Cylinder Lock		
						Key Removal — Left*	Key Removal — Right*	Key Removal — Both*
						Cat. No.	Cat. No.	Cat. No.
No Contacts	—	—	—	—	M M	800T-H31	800T-H32	800T-H33
					M←S	800T-H48	—	—
1 N.O.	White	A	O	X	M M	800T-H31D1	800T-H32D1	800T-H33D1
					S→M*	—	800T-H42D1	—
					M←S	800T-H48D1	—	—
1 N.O. - 1 N.C.	White	A B	O X	X O	M M	800T-H31A	800T-H32A	800T-H33A
					S→M*	—	800T-H42A	—
					M←S	800T-H48A	—	—

Note: X = Closed/O = Open

800 T - H31 A

a b c d e

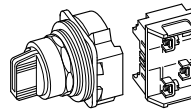

Protection Rating	
Code	Description
T	Metal, Type 4/13

Finger-Safe Guards	
Code	Description
Blank	No guards
C	Guards on terminals

Key Removal Position	
Maintained	
Code	Operator Function
H31	Key removal — left
H32	Key removal — right
H33	Key removal — both
Spring Return From Left	
Code	Operator Function
H42	Key removal — right*
Spring Return From Right	
Code	Operator Function
H48	Key removal — left

Key Options for Cylinder Locks*			
Code	T Series Key No.	Code	T Series Key No.
Blank	D018 (Std. Key)	15	T112
03	D020	16	T115
04	D025	17	T324
05	D335	18	T382
06	D429	19	T404
07	D461	20	T171
08	D111	21	T484
09	D587	22	T547
10	D682	23	T569
11	D713	24	T692
12	D900	25	T752
13	D992	26	T178
14	D118	—	—

Contact Block(s)			
Code	Contact Configuration	Description	
		2-Position	
Blank	No contacts	—	—
Standard			
D1	1 N.O.	O	X
D2	1 N.C.	X	O
A	1 N.O. - 1 N.C.	O	X
		X	O
B	2 N.O. - 2 N.C.	O	X
		X	O
		O	X
		X	O
Max Duty (Horsepower Rated)			
D1M	1 N.O.		
D2M	1 N.C.		
PenTUFF (Low Voltage)			
D1V	1 N.O.		
D2V	1 N.C.		
AV	1 N.O. - 1 N.C.		
BV	2 N.O. - 2 N.C.		
Class1, Div. 2/Zone 2			
Logic Reed§			
D1R	1 N.O.		
D2R	1 N.C.		
AR	1 N.O. - 1 N.C.		
BR	2 N.O. - 2 N.C.		
Sealed Switch§			
D1P	1 N.O.		
D2P	1 N.C.		
AP	1 N.O. - 1 N.C.		
BP	2 N.O. - 2 N.C.		
Stackable Sealed Switch§			
D1Y	1 N.O.		
D2Y	1 N.C.		
AY	1 N.O. - 1 N.C.		
BY	2 N.O. - 2 N.C.		

* Target tables are reversed from those shown.
 * Keys removable from maintained positions only.
 § Contact target tables same as those listed for standard and PenTUFF contact blocks.
 § Device supplied with 2 keys. Replacement key part no. for standard D018 key is X-181170. See page 10-46 for additional replacement key numbers.

3-Position Selector Switch Devices, Non-Illuminated (Bul. 800T only)



3-Position Cylinder Lock Operator
 Cat. No. 800T-J41A

Contact Type	Operator Position			M = Maintained S = Spring Return	Type 4/13 Cylinder Lock§		
					Key Removal — Left *	Key Removal — Center *	Key Removal — All *
					Cat. No.	Cat. No.	Cat. No.
No Contacts	—	—	—	M M M	800T-J41	800T-J42	800T-J44
				S→M M	—	800T-J50	—
				M M←S	800T-J69	800T-J38	—
				S→M←S	—	800T-J631	—
 1 N.O. - 1 N.C.	O X	O O	X O	M M M	800T-J41A	800T-J42A	800T-J44A
				S→M M	—	800T-J50A	—
				M M←S	800T-J69A	800T-J38A	—
				S→M←S	—	800T-J631A	—

Note: X = Closed/O = Open

800 T — J41 KC1 A
 a b c d e f

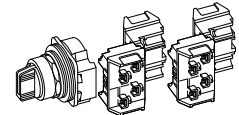

a

Protection Rating	
Code	Description
T	Metal, Type 4/13

b

Finger-Safe Guards	
Code	Description
Blank	No guards
C	Guards on terminals

c

Key Removal Position	
Maintained	
Code	Operator Function
J41	Key removal — left
J42	Key removal — center
J43	Key removal — right
J44	Key removal — all
J45	Key removal — left and center
J46	Key removal — right and left
J47	Key removal — right and center
Spring Return from Left	
J50	Key removal — center
J52	Key removal — right
J51	Key removal — right and center

c (cont'd)

Key Removal Position	
Spring Return from Right	
Code	Operator Function
J69	Key removal — left
J38	Key removal — center
J73	Key removal — left and center
Spring Return from Both	
J631	Key removal — center

d

Key Options for Cylinder Locks§	
Code	Key No.
Blank	D018 (standard key)
03	D020
04	D025
05	D335
06	D429

Note: Refer to page 10-13 for additional key option codes.

e

Cam Option*	
Code	Description
Blank	KB7 cam (std.)
KA1	KA1 cam
KA7	KA7 cam
KC1	KC1 cam

Note: See Table 1 on page 10-14 for cam selections.

e (cont'd)

Cam Option*	
Code	Description
KC7	KC7 cam
KD7	KD7 cam
KE7	KE7 cam
KQ1	KQ1 cam
KQ7	KQ7 cam
KR1	KR1 cam
KR7	KR7 cam
KT1	KT1 cam
KT7	KT7 cam
KU7	KU7 cam

f

Contact Blocks	
Code	Description
Blank	No contacts
Standard	
A	1 N.O. - 1 N.C. 1-800T-XA on white side 2 N.O. - 2 N.C.
B	2-800T-XAs — 1 on white side/1 on black side
PenTUFF (Low Voltage)	
AV	1 N.O. - 1 N.C. 1-800T-XAV on white side
BV	2 N.O. - 2 N.C. 2-800T-XAVs — 1 on white side/1 on black side

f (cont'd)

Contact Blocks	
Class 1, Div. 2/Zone 2	
Logic Reed	
Code	Description
AR	1 N.O. - 1 N.C. 1-800T-XAR on white side
BR	2 N.O. - 2 N.C. 2-800T-XARs — 1 on white side/1 on black side
Sealed Switch	
AP	1 N.O. - 1 N.C. 1-800T-XAP on white side
BP	2 N.O. - 2 N.C. 2-800T-XAPs — 1 on white side/1 on black side
Stackable Sealed Switch	
AY	1 N.O. - 1 N.C. 1-800T-XAY on white side
BY	2 N.O. - 2 N.C. 2-800T-XAYs — 1 on white side/1 on black side

* Key removable in maintained positions only.

‡ If an overlapping cam is required, consult your local Rockwell Automation sales office or Allen-Bradley distributor.

§ Device supplied with 2 keys. Replacement key part no. for standard D018 key is X-181170. See page 10-46 for additional replacement key numbers.

Bulletin 800T/H
30.5 mm Push Buttons
 Selector Switches

4-Position Selector Switch Devices, Non-Illuminated

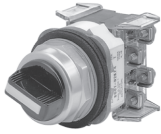

Standard Knob Operator
 Cat. No. 800T-N2KN4B



Knob Lever Operator
 Cat. No. 800T-N17KN4B



Standard Knob Operator
 Cat. No. 800H-NR2KF4AAXX

Contact Type	Operator Position				M = Maintained S = Spring Return	Type 4/13		
						Standard Knob	Knob Lever	Standard Knob
	Cat. No.	Cat. No.	Cat. No.	Cat. No.		Cat. No.	Cat. No.	Cat. No.
No Contacts	—	—	—	—	M M M M	800T-N2KF4	800T-N17KF4	800H-NR2KF4
					S→M M M	800T-N3KF4	800T-N29KF4	800H-NR3KF4
					M M M←S	800T-N9KF4	800T-N30KF4	800H-NR9KF4
 2 N.O. - 2 N.C.	X	O	O	O	M M M M	800T-N2KF4B	800T-N17KF4B	800H-NR2KF4AAXX
	O	X	O	O	S→M M M	800T-N3KF4B	800T-N29KF4B	800H-NR3KF4AAXX
	O	O	X	X	M M M←S	800T-N9KF4B	800T-N30KF4B	800H-NR9KF4AAXX

Note: X = Closed/O = Open

800 T - N 2 KF4 B
 a b c d e f

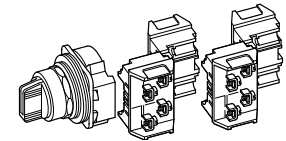

a

Protection Rating	
Code	Description
T	Metal, Type 4/13
H	Plastic, Type 4/4X/13

b

Finger-Safe Guards	
Code	Description
Blank	No guards
C	Guards on terminals

c

Knob Insert Colors		
800T Type 4/13	Description	800H Type 4/4X/13
Code		Code
N	White	NR
NX	Packet of colored inserts*	NRX
Metal Wing Lever Colors		
Code	Color	Code
NA	Red	—
NG	Grey	—

d

Operator Function and Knob Type	
Standard Knob	
Code	Operator Function
2	Maintained
3	Spring return from position 1 to position 2
9	Spring return from position 4 to position 3
Knob Lever§	
Code	Operator Function
17	Maintained
29	Spring return from position 1 to position 2
30	Spring return from position 4 to position 3
Metal Wing Lever§	
Code	Operator Function
11	Maintained
13	Spring return from position 1 to position 2
14	Spring return from position 4 to position 3

e

Cam Option*	
Code	Description
KF4	F cam
KG4	G cam
KK4	K cam
KM4	M cam
KP4	P cam
KN4	Overlapping cam*

f

Contact Blocks*		
800T Type 4/13	Description	800H Type 4/4X/13
Code		Code
Blank	No contacts	Blank
Standard		
B	2 N.O. - 2 N.C. 2-800T-XAs — 1 on white side/ 1 on black side	AAXX
H	3 N.O. - 3 N.C. 3-800T-XAs — 2 on white side/ 1 on black side	AAAX
C	4 N.O. - 4 N.C. 4-800T-XAs — 2 on white side/ 2 on black side	AAAA

f (cont)

Contact Blocks		
800T Type 4/13	Description	800H Type 4/4X/13
Code		Code
PenTUFF (Low Voltage)		
BV	2 N.O. - 2 N.C.	FFXX
HV	3 N.O. - 3 N.C.	FFFX
CV	4 N.O. - 4 N.C.	FFFF
Class 1, Di. 2/Zone 2		
Logic Reed‡		
BR	2 N.O. - 2 N.C.	TTXX
HR	3 N.O. - 3 N.C.	TTTX
CR	4 N.O. - 4 N.C.	TTTT
Sealed Switch‡		
BP	2 N.O. - 2 N.C.	PPXX
Stackable Sealed Switch§		
BY*	2 N.O. - 2 N.C.	TTXX
HY*	3 N.O. - 3 N.C.	TTTX
CY*	4 N.O. - 4 N.C.	TTTT

- * One insert of each color (blue, green, orange, red, and yellow).
- † Overlapping cam. See Publication 800T-2.8 for overlap specifications.
- ‡ Contact block mounting same as listed for standard and PenTUFF contact blocks.
- § Only available on Bul. 800T, Type 4/13 operators.
- * See Table 1 for proper cam/contact selection.
- Not available with wing levers.

Table 1. Cam and Contact Block Functionality Table

Contact Block Suffix Code	Contact Block Side	Circuits	Cam Codes																						
			KF4		KG4		KK4		KM4		KP4		KN4*												
C	White	A	X	O	O	O	X	X	O	O	O	O	X	X	X	O	O	O	O	O	X	O	X	O	O
		B	O	X	O	O	O	O	X	X	O	O	X	X	O	O	X	X	O	O	X	O	O	O	X
	Black	A	O	O	O	X	X	O	O	X	O	O	X	O	O	X	O	X	O	X	O	X	O	O	X
		B	O	O	X	O	O	O	X	O	X	X	O	O	X	O	X	O	X	O	X	O	O	O	X
C	White	A	X	O	O	O	X	X	O	O	O	O	X	X	X	O	O	O	O	O	X	O	X	O	O
		B	O	X	O	O	O	O	X	O	X	X	O	O	X	X	O	O	X	O	X	O	O	O	X
	Black	A	O	O	O	X	X	O	O	O	X	O	O	X	O	O	X	O	X	O	X	O	X	O	O
		B	O	O	X	O	O	O	X	O	X	X	O	O	X	O	X	O	X	O	X	O	O	O	X

Note: X = Closed/O = Open



4-Position Selector Switch Devices, Non-Illuminated (800T only)



Cylinder Lock Operator
 Cat. No. 800T-N32KF4B

Contact Type	Operator Position				M = Maintained S = Spring Return	Cylinder Lock – Type 4/13§		
						Key Removal — Position 2*	Key Removal — Position 3*	Key Removal — All*
					Cat. No.	Cat. No.	Cat. No.	
No Contacts	—	—	—	—	M M M M	800T-N32KF4	800T-N33KF4	800T-N61KF4
					S→M M M	800T-N132KF4	800T-N133KF4	—
					M M M←S	800T-N232KF4	800T-N233KF4	—
	X O O O	O X O O	O O X O	O O O X	M M M M	800T-N32KF4B	800T-N33KF4B	800T-N61KF4B
					S→M M M	800T-N132KF4B	800T-N133KF4B	—
					M M M←S	800T-N232KF4B	800T-N233KF4B	—

Note: X = Closed/O = Open

800 T — N31 — KM4 C
 a b c d e f

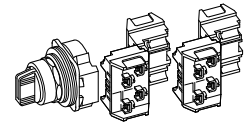

a

Protection Rating	
Code	Description
T	Metal, Type 4/13

b

Finger-Safe Guards	
Code	Description
Blank	No guards
C	Guards on terminals

c

Key Removal Position and Operator Function	
Maintained	
Code	Operator Function
N31	Key removal position 1
N32	Key removal position 2
N33	Key removal position 3
N34	Key removal position 4
N61	Key removal all positions

c (cont'd)

Key Removal Position and Operator Function	
Spring Return From Position 1 to Position 2	
Code	Description
N132	Key removal position 2
N133	Key removal position 3
N134	Key removal position 4
N154	Key removal positions 2, 3, and 4
Spring Return From Position 4 to Position 3	
Code	Operator Function
N231	Key removal position 1
N232	Key removal position 2
N233	Key removal position 3
N251	Key removal positions 1, 2, and 3

d

Key Options for Cylinder Locks§	
D Series	
Code	Key No.
Blank	D018 (standard key)
03	D020
04	D025
05	D335
06	D429

Note: Refer to page 10-13 for additional key option codes.

e

Cam Option	
Code	Description
KF4	F cam
KG4	G cam
KK4	K cam
KM4	M cam
KP4	P cam
KN4	Overlapping cam*

Note: See Table 1 for proper cam selection.

f

Contact Blocks	
Code	Description
Blank	No contacts
Standard	
B	2 N.O. - 2 N.C. 2- 800T-XAs — 1 on white side/1 on black side
H	3 N.O. - 3 N.C. 3- 800T-XAs — 2 on white side/1 on black side
C	4 N.O. - 4 N.C. 4- 800T-XAs — 2 on white side/2 on black side
PenTUFF (Low Voltage)	
BV	2 N.O. - 2 N.C. 2- 800T-XAVs — 1 on white side/1 on black side
HV	3 N.O. - 3 N.C. 3- 800T-XAVs — 2 on white side/1 on black side
CV	4 N.O. - 4 N.C. 4- 800T-XAVs — 2 on white side/2 on black side
Class 1, Div. 2/Zone 2	
Logic Reed†	
BR	2 N.O. - 2 N.C.
HR	3 N.O. - 3 N.C.
CR	4 N.O. - 4 N.C.
Sealed Switch‡	
BP	2 N.O. - 2 N.C.
Stackable Sealed Switch‡	
BY	2 N.O. - 2 N.C.
HY	3 N.O. - 3 N.C.
CY	4 N.O. - 4 N.C.

Note: Associated targets shown in Table 1.

Table 1. Cam and Contact Block Functionality Table

Contact Block Suffix Code	Contact Block Side	Circuits	Cam Codes																							
			KF4				KG4				KK4				KM4				KP4				KN4*			
C	White	A	X	O	O	O	X	X	O	O	O	O	X	X	X	O	O	O	O	O	X	O	X	O	O	
		B	O	X	O	O	O	O	X	O	X	X	O	O	O	X	X	O	O	X	O	O	O	O	O	X
		A	O	O	O	X	X	O	O	O	X	O	O	X	O	O	X	O	O	X	X	O	O	X	O	O
		B	O	O	X	O	O	O	O	X	O	X	X	O	O	X	O	O	X	O	O	X	O	O	O	O
	Black	A	X	O	O	O	X	X	O	O	O	O	X	X	X	O	O	O	O	X	O	X	O	O	O	O
		B	O	X	O	O	O	O	X	O	X	X	O	O	O	X	O	O	X	O	O	O	O	O	O	X
		A	O	O	O	X	X	O	O	O	X	O	O	X	O	O	X	O	O	X	X	O	O	X	O	O
		B	O	O	X	O	O	O	O	X	O	X	X	O	O	X	O	O	X	O	O	X	O	O	O	O

Note: X = Closed/O = Open

* Key removable in maintained positions only.

† Overlapping cam. One layer of contact blocks allowed, no stacking. See Publication 800T-2.8 for overlap specifications.

‡ Contact block mounting same as listed for standard and PenTUFF contact blocks.

§ Device supplied with 2 keys. Replacement key part no. for standard D018 key is X-181170. See page 10-46 for additional replacement key numbers.

Bulletin 800T/H
30.5 mm Push Buttons
 Selector Switches

2-Position Knob/Lever Type Selector Switch Devices, Illuminated



Standard Knob Operator
 Cat. No. 800T-16HR2KB6AX



Knob Lever Operator
 Cat. No. 800H-16HRR17KB6AX

Type	Lamp Type	Volts	Knob Color	Operator Position		M = Maintained S = Spring Return	Type 4/13	Type 4/4X/13	
							Standard Knob	Standard Knob	
Operator Only*				No Contacts			Cat. No.	Cat. No.	
Full Voltage	Incandescent	24V AC/DC	Red	X	O	M M	800T-00HX2KB6	800H-00HRX2KB6	
						M M	800T-24HR2KB6AX	800H-24HRR2KB6AX	
	S→M*	800T-24HR4KL8AX	800H-24HRR4KL8AX						
	M←S	800T-24HR5KL8AX	800H-24HRR5KL8AX						
Universal	No Lamp	0...250V AC/DC	No Knob	O	X	M M	800T-25HXN2KB6AX	800H-25HRXN2KB6AX	
						M M	800T-2HRH2KB6AX	800H-2HRRH2KB6AX	
	S→M*	800T-2HRH4KL8AX	800H-2HRRH4KL8AX						
	M←S	800T-2HRH5KL8AX	800H-2HRRH5KL8AX						
Transformer	Incandescent	120V AC 50/60 Hz	Red	X	O	M M	800T-16HR2KB6AX	800H-16HRR2KB6AX	
						S→M*	800T-16HR4KL8AX	800H-16HRR4KL8AX	
						M←S	800T-16HR5KL8AX	800H-16HRR5KL8AX	
						M M	800T-16HRH2KB6AX	800H-16HRRH2KB6AX	
	S→M*	800T-16HRH4KL8AX	800H-16HRRH4KL8AX						
	M←S	800T-16HRH5KL8AX	800H-16HRRH5KL8AX						
	LED	120V AC 50/60 Hz	No Knob			No Knob	M M	800T-16HXN2KB6AX	800H-16HRXN2KB6AX
							M M	800T-16HXN2KB6AX	800H-16HRXN2KB6AX

Note: X = Closed/O = Open

* Operator only supplied without power module, lamp, lens cap, or contact blocks.

* Target tables are reversed from those shown.

800 T - 16 H R 2 KB6 A X

a b c d e f g h i j

1st Level 2nd Level

Protection Rating	
Code	Description
T	Metal, Type 4/13
H	Plastic, Type 4/4X/13

Finger-Safe Guards	
Code	Description
Blank	No guards
C	Guards on terminals

Power Module Type and Voltage	
Full Voltage — Incandescent	
Code	Description
12	12V AC/DC
24	24V AC/DC
48	48V AC/DC
Universal — LED	
2	12...130V AC/DC
Transformer	
16	120V AC 50/60 Hz
26	240V AC 50/60 Hz

For other voltages, please contact your local Rockwell Automation sales office or Allen-Bradley distributor.

No. of Positions		
Bul. 800T Type 4/13	Description	Bul. 800H Type 4/4X/13
Code		Code
H	2-position	HR

Knob Color	
Code	Color
A	Amber
B	Blue
C	Clear
G	Green
R	Red
W	White
X	No knob

Illumination Options	
Code	Description
Blank	Incandescent
H	LED

Table 1. Selector Switch Cam Targets

Cam Description (2-Position)		
Target		Contact Block Code*
		D, H, V, R, 5
		E, U, W, S, 6

X = Closed/O = Open

Operator Function and Knob Type	
Standard Knob or No Knob	
Code	Operator Function
2	Maintained
4	Spring return from left
5	Spring return from right
Knob Lever	
17	Maintained
18	Spring return from left
19	Spring return from right

Cam Options	
2-Position	
Code	Operator Function
KB6	Maintained Cam
KL8	Spring Return Cam

Table 2. Contact Block Code Reduction Rules

Contact Block Substitution	
Combination	Code
Standard	
D + E	A
D + D	M
E + E	N

Contact Blocks*	
Code	Description
Blank (both pos.)	No contacts
Standard	
D	1 N.O.
E	1 N.C.
A	1 N.O. - 1 N.C.
X	No contacts in this position
PenTUFF (Low Voltage)	
H	1 N.O.
U	1 N.C.
F	1 N.O. - 1 N.C.
Class 1, Div. 2/Zone 2	
Logic Reed	
V	1 N.O.
W	1 N.C.
T	1 N.O. - 1 N.C.
Sealed Switch	
R	1 N.O.
S	1 N.C.
P	1 N.O. - 1 N.C.
Stackable Sealed Switch	
5	1 N.O.
6	1 N.C.
7	1 N.O. - 1 N.C.

* Contact blocks used on white side only.

* Target tables are reversed for spring return from left operators.

3-Position Knob/Lever Type Selector Switch Devices, Illuminated



Standard Knob Operator
 Cat. No. 800T-16JR2KB7AX



Standard Knob Operator
 Cat. No. 800H-16JRR2KB7AX

Type	Lamp Type	Volts	Color	Operator Position			M = Maintained S = Spring Return	Type 4/13	Type 4/4X/13			
								Standard Knob	Standard Lever			
Operator Only*				No Contacts			Cat. No.	Cat. No.				
Full Voltage	Incandescent	24V AC/DC	Red	X O	O O	O X	M M M	800T-00JX2KB7	—			
							M M M	800T-24JR2KB7AX	800H-24JRR2KB7AX			
	S→M M	800T-24JR4KB7AX	800H-24JRR4KB7AX									
	M M←S	800T-24JR5KB7AX	800H-24JRR5KB7AX									
Universal	LED	12...130V AC/DC	Red	X O	O O	O X	M M M	800T-25JXN2KB7AX	—			
							M M M	800T-2JRH2KB7AX	800H-2JRRH2KB7AX			
							S→M M	800T-2JRH4KB7AX	800H-2JRRH4KB7AX			
							M M←S	800T-2JRH5KB7AX	800H-2JRRH5KB7AX			
Transformer	Incandescent	120V AC 50/60 Hz	Red	X O	O O	O X	M M M	800T-16JR2KB7AX	800H-16JRR2KB7AX			
							S→M M	800T-16JR4KB7AX	800H-16JRR4KB7AX			
							M M←S	800T-16JR5KB7AX	800H-16JRR5KB7AX			
							M M M	800T-16JRH2KB7AX	800H-16JRRH2KB7AX			
	LED	120V AC 50/60 Hz	Red				X O	O O	O X	S→M M	800T-16JRH4KB7AX	800H-16JRRH4KB7AX
										M M←S	800T-16JRH5KB7AX	800H-16JRRH5KB7AX
										M M M	800T-16JXN2KB7AX	—
										M M M	800T-16JXN2KB7AX	—

Note: X = Closed/O = Open

* Operator only supplied without power module, lamp, lens cap, or contact blocks.

800 T - 16 J R 2 KB7 A X

a b c d e f g h i j

a

Protection Rating	
Code	Description
T	Metal, Type 4/13
H	Plastic, Type 4/4X/13

b

Finger-Safe Guards	
Code	Description
Blank	No guards
C	Guards on terminals

c

Power Module Type and Voltage	
Full Voltage — Incandescent	
Code	Description
12	12V AC/DC
24	24V AC/DC
48	48V AC/DC
Universal — LED	
2	12...130V AC/DC
Transformer	
16	120V AC 50/60 Hz
26	240V AC 50/60 Hz

For other voltages, please contact your local Rockwell Automation sales office or Allen-Bradley distributor.

d

No. of Positions		
800T Type 4/13	Description	800H Type 4/4X/13
Code		Code
J	3-position	JR

e

Knob Color	
Code	Color
A	Amber
B	Blue
C	Clear
G	Green
R	Red
W	White
X	No knob

f

Illumination Options	
Code	Description
Blank	Incandescent
H	LED†

g

Operator Function and Knob Type	
Standard Knob or No Knob	
Code	Operator Function
2	Maintained
4	Spring return from left
5	Spring return from right
91	Spring return from both
Knob Lever	
Code	Operator Function
17	Maintained
18	Spring return from left
19	Spring return from right
20	Spring return from both

h

Cam Options	
3-Position	
Code	Operator Function
KB7	B7 cam
KC1	C1 cam
KC7	C7 cam
KE7	E7 cam
KQ1	Q1 cam
KT1	T1 cam

i, j

Contact Blocks§	
Code	Description
Blank (both pos.)	No contacts

i, j (cont'd)

Contact Blocks§	
Code	Description
Standard	
A	1 N.O. - 1 N.C.
X	No contacts in this position
PenTUFF (Low Voltage)	
F	1 N.O. - 1 N.C.
Class 1, Div. 2/Zone 2	
Logic Reed	
T	1 N.O. - 1 N.C.
Sealed Switch	
P	1 N.O. - 1 N.C.
Stackable Sealed Switch	
7	1 N.O. - 1 N.C.

Table 1. Selector Switch Cam Targets

Target			Cam Description (3-Position)					
			KB7	KC1	KC7	KE7	KQ1	KT1
X	O	O	D, H, V, R, 5	—	D, H, V, R, 5	D, H, V	—	E, U, W, S, 6
O	X	O	—	E, U, W, S, 6	E, U, W, S, 6	—	E, U, W, S, 6	—
O	O	X	E, U, W, S, 6	D, H, V, R, 5	—	—	—	D, H, V, R, 5
X	X	O	G, I	J, Q	—	—	—	J, Q
O	X	X	J, Q	—	J, Q	E, U, W, S, 6	—	—
X	O	X	—	G, I	G, I	—	D, H, V, R, 5	—

‡ LED only.

† LEDs available in red, green, amber, blue, and white. White LEDs only available in 6V, 24V, 120V, and 130V full voltage and all transformer units. LED color matches lens color, except clear lens supplied with white LED and white lens supplied with amber LED. All LEDs except 120V have an internal shunt resistor for use with solid-state outputs.

§ Contact blocks used on white side only.

Bulletin 800T/H

30.5 mm Push Buttons

Pilot Lights

Pilot Light Devices*



Transformer Type Pilot Light
Cat. No. 800T-P16R



Push-to-Test Pilot Light
Cat. No. 800T-PT16R

Type	Lamp Type	Volts	Color	Type 4/13		Type 4/4X/13	
				Pilot Light	Push-to-Test*	Pilot Light	Push-to-Test*
				Cat. No.	Cat. No.	Cat. No.	Cat. No.
Operator Only*				800T-S00	800T-SB00XX	800H-SR00	800H-SRB00XX
Full Voltage†	Incandescent	24V AC/DC	Red	800T-Q24R	800T-QT24R	800H-QR24R	800H-QRT24R
			Green	800T-Q24G	800T-QT24G	800H-QR24G	800H-QRT24G
			Amber	800T-Q24A	800T-QT24A	800H-QR24A	800H-QRT24A
	No Lamp	0...250V AC/DC	No Lens	800T-QN25	800T-QTN25	—	—
Universal†	LED	12...130 V AC/DC	Red	800T-QH2R	800T-QTH2R	800H-QRH2R	800H-QRTH2R
			Green	800T-QH2G	800T-QTH2G	800H-QRH2G	800H-QRTH2G
			Amber	800T-QH2A	800T-QTH2A	800H-QRH2A	800H-QRTH2A
Transformer†	Incandescent	120V AC, 50/60 Hz	Red	800T-P16R	800T-PT16R	800H-PR16R	800H-PRT16R
			Green	800T-P16G	800T-PT16G	800H-PR16G	800H-PRT16G
			Amber	800T-P16A	800T-PT16A	800H-PR16A	800H-PRT16A
	LED		Red	800T-PH16R	800T-PTH16R	800H-PRH16R	800H-PRTH16R
			Green	800T-PH16G	800T-PTH16G	800H-PRH16G	800H-PRTH16G
			Amber	800T-PH16A	800T-PTH16A	800H-PRH16A	800H-PRTH16A
			No Lamp	No Lens	800T-PN16	800T-PTN16	—

* Includes one standard Cat. No. 800T-XA (1 N.O. - 1 N.C.) contact block. For typical pilot light wiring diagrams, see page 10-65.

* Operator only supplied without power module, lamp, lens cap, or contact blocks.

† All pilot lights except push-to-test without sealed contacts and dual input transformer relay, are rated for Class 1, Division 2 applications.

800 T - P T 16 G AR (Push-to-Test)

a b c d e f g h

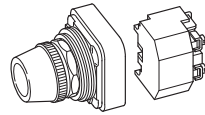

Protection Rating	
Code	Description
T	Metal, Type 4/13
H	Plastic, Type 4/4X/13

Finger-Safe Guards	
Code	Description
Blank	No guards
C	Guards on terminals

Power Module Type		
800T Type 4/13	Description	800H Type 4/4X/13
Code		Code
P	Transformer (or dual input)	PR
Q	Full voltage/Universal	QR

Lamp Test Options	
Code	Description
Blank	No test option
T	Push-to-test
D	Dual input — diode*
DT	Dual input — transformer relay

Note: Push-to-test supplied with factory jumpered contact block.

Illumination Options	
Code	Description
Blank	Incandescent
H	LED*

Voltage	
Transformer	
Code	Description
16	120V AC 50/60 Hz
26	240V AC 50/60 Hz
46	480V AC 50/60 Hz
56	600V AC 50/60 Hz
Full Voltage — Incandescent	
12	12V AC/DC
24	24V AC/DC
48	48V AC/DC
10	120V AC/DC
20	240V AC/DC
Universal — LED	
2	12...130V AC/DC
Dual Input	
16	120V AC
24	24V AC/DC (Dual input diode only)

Lens Color		
Code	Color	Glass Code
Blank	No lens	Blank
A	Amber	D
B	Blue	E
C	Clear	F
G	Green	H
R	Red	J
W	White	K

Contact Blocks (Push-to-test units only)	
Code	Description
Standard	
Blank	1 N.O. - 1 N.C.
PenTUFF (Low Voltage)	
AV	1 N.O. - 1 N.C.
Class 1, Div. 2/Zone 2	
Logic Reed	
AR	1 N.O. - 1 N.C.
Sealed Switch	
AP	1 N.O. - 1 N.C.
Stackable Sealed Switch	
AY	1 N.O. - 1 N.C.

- * LED illumination option is not available with diode type dual input.
- * Diode type dual input provides circuit isolation via opposing diodes. Not recommended for use with solid-state outputs.
- * Glass lens available on 800T pilot lights only. Not available on push-to-test units.

2-Position Red Push-Pull and Push-Pull/Twist Release Devices, Non-Illuminated

Note: A jumbo or large legend plate is recommended, if space allows.



2-Position Push-Pull
 Cat. No. 800T-FX6D4



2-Position Metal Push-Pull
 Cat. No. 800T-FXLE6D4S



2-Position Push-Pull / Twist
 Cat. No. 800T-FXT6D4



2-Position Push-Pull / Twist
 Cat. No. 800H-FRXT6D4

Contact Type	Operator Position		Type 4/13		Type 4/4X/13	
			Push-Pull — 40 mm	Push-Pull — 63 mm Metal	Push-Pull/Twist Release	Push-Pull/Twist Release
	Out	In	Cat. No.	Cat. No.	Cat. No.	Cat. No.
N.C.L.B.*	X	O	800T-FX6D4	800T-FXLE6D4	800T-FXT6D4	800H-FRXT6D4
N.O. - N.C.L.B.*	O	X	800T-FX6A1	800T-FXLE6A1	800T-FXT6A1	800H-FRXT6A1
N.C.L.B. - N.C.L.B.*	X	O	800T-FX6A5	800T-FXLE6A5	800T-FXT6A5	800H-FRXT6A5
S.M.C.B.*†	X	O	800TC-FX6D4S	800TC-FXLE6D4S	800TC-FXT6D4S	800HC-FRXT6D4S
N.O. - S.M.C.B.*†	O	X	800TC-FX6A1S	800TC-FXLE6A1S	800TC-FXT6A1S	800HC-FRXT6A1S
S.M.C.B. - S.M.C.B.*†	X	O	800TC-FX6A5S	800TC-FXLE6A5S	800TC-FXT6A5S	800HC-FRXT6A5S

Note: X = Closed/O = Open

Note: These caps are only available in plastic.

Note: Emergency stop push buttons are compliant with EN ISO 13850 and EN/IEC 60947-5-5 Standards when using N.C.L.B. contact blocks.

* The Self Monitoring Contact Block (S.M.C.B.) is composed of a N.C.L.B. contact wired in series with a N.O. monitoring contact. The N.O. monitoring contact automatically closes when the S.M.C.B. is properly installed onto the E-stop operator. If the S.M.C.B. is separated from the E-stop operator, the N.O. monitoring contact will automatically open.

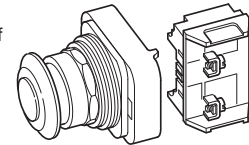

800 T - FX 1 A1

a b c d e

Protection Rating	
Code	Description
T	Metal, Type 4/13
H	Plastic, Type 4/4X/13

Finger-Safe Guards	
Code	Description
Blank	No guards
C	Guards on terminals

Head Type‡		
800T Type 4/13	Description	800H Type 4/4X/13
Code		Code
FX	Mushroom head (push-pull)	—
FXC	90 mm anodized aluminum head (push-pull)	—
FXJ	Jumbo mushroom head (push-pull)	—
FXJE	Jumbo mushroom head (push-pull) with "E-Stop"	—
FXL	63 mm anodized aluminum head (push-pull)	—
FXLE	63 mm anodized aluminum head (push-pull) with "E-Stop"	—
FXT	Push-pull/twist-to-release	FRXT
FXJT	Jumbo head push-pull with twist-to-release	FRXJT

Color Cap	
Code	Color
Blank	No cap§
1	Green
2	Black
3	Orange
4	Grey
5	White
6	Red
7	Blue
9	Yellow

Contact Block(s)				
Code	Operator Position		Description	
Blank	—	—	No contacts on operator	
Standard				
D1	O	X	1 N.O.	
D2	X	O	1 N.C.	
D4	X	O	1 N.C.L.B.	
A	O	X	1 N.O. - 1 N.C.	
A1	O	X	1 N.O. - 1 N.C.L.B.	
A5	X	O	2 N.C.L.B.	

Contact Block(s)			
Code	Operator Position		Description
Blank	—	—	No contacts
PenTUFF (Low Voltage)			
D1V	O	X	1 N.O.
D2V	X	O	1 N.C.
D4V	X	O	1 N.C.L.B.
AV	O	X	1 N.O. - 1 N.C.
X	X	O	
Class 1, Div. 2/Zone 2			
Logic Reed			
D1R	O	X	1 N.O.
D2R	X	O	1 N.C.
AR	O	X	1 N.O. - 1 N.C.
X	X	O	
Sealed Switch			
D1P	O	X	1 N.O.
D2P	X	O	1 N.C.
AP	O	X	1 N.O.
X	X	O	1 N.C.
Stackable Sealed Switch			
D1Y	O	X	1 N.O.
D2Y	X	O	1 N.C.
AY	O	X	1 N.O. - 1 N.C.
X	X	O	

Note: X = Closed/O = Open

* Normally closed late break contact. When button is pushed from the OUT to IN position, the mechanical detent action of the operator occurs before electrical contacts change state. When the button is pulled from the IN in the OUT position, the electrical contacts change state before the mechanical detent occurs.

‡ Devices with N.C.L.B. contacts meet EN ISO 13850 and IEC 60947-5-5 standards for emergency stop applications.

§ Not valid with head Type J or JT.

Bulletin 800T/H
30.5 mm Push Buttons
 Push-Pull Operators

3-Position Push-Pull Devices, Non-Illuminated

Note: A jumbo or large legend plate is recommended, if space allows.



3-Position Push-Pull
 Cat. No. 800T-FXM6A7



3-Position Push-Pull
 Cat. No. 800H-FRXM6A7

Contact Type	Operator Position			Operator Position		
	Momentary	Maintained	Maintained	Momentary	Maintained	Momentary
	Out	Center	In	Out	Center	In
N.C.-	X	O	O	X	O	O
N.C.L.B.*	X	X	O	X	X	O

Button Color	Type 4/13	Type 4/4X/13	Type 4/13	Type 4/4X/13
	Push-Pull*	Push-Pull*	Push-Pull*	Push-Pull*
	Cat. No.	Cat. No.	Cat. No.	Cat. No.
Red	800T-FXM6A7	800H-FRXM6A7	800T-FXN6A7	800H-FRXN6A7

Note: X = Closed/O = Open

* Normally closed late break contact. When button is pushed from the OUT to IN position, the mechanical detent action of the operator occurs before electrical contacts change state. When the button is pulled from the IN to the OUT position, the electrical contacts change state before the mechanical detent occurs.

* Devices with N.C.L.B. contacts meet EN ISO 13850 and IEC 60947-5-5 standards for emergency stop applications.

800 **T** **- FX** **M** **1** **A7**
 a **b** **c** **d** **e** **f**

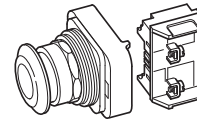

a

Protection Rating	
Code	Description
T	Metal, Type 4/13
H	Plastic, Type 4/4X/13

b

Finger-Safe Guards	
Code	Description
Blank	No guards
C	Guards on terminals

c

Head Type*		
800T Type 4/13	Description	800H Type 4/4X/13
Code		Code
FX	Mushroom head (push-pull)	FRX
FXC	90 mm anodized aluminum head (push-pull)	—
FXJ	Jumbo mushroom head (push-pull)	FRXJ
FXL	63 mm anodized aluminum head (push-pull)	—

d

Operator Function			
Code	Operator Position		
	Out	Center	In
M	Momentary	Maintained	Maintained
N	Momentary	Maintained	Momentary

e

Color Cap	
Code	Color
Blank	No cap†
1	Green
2	Black
3	Orange
4	Grey
5	White
6	Red
7	Blue
9	Yellow

f

Contact Block(s)				
Code	Operator Position			Description
	Out	Ctr.	In	
Blank	—	—	—	No contacts
Standard				
A	O	O	X	1 N.O. - 1 N.C.
	X	O	O	
A1	O	O	X	1 N.O. - 1 N.C.L.B.
	X	X	O	
A7	X	O	O	1 N.C. - 1 N.C.L.B.
	X	X	O	
B6	X	O	O	2 N.C. - 2 N.C.L.B.
	X	X	O	
	X	O	O	
	X	X	O	
PenTUFF (Low Voltage)				
AV	O	O	X	1 N.O. - 1 N.C.
	X	O	O	

f (cont'd)

Contact Block(s)				
Code	Operator Position			Description
	Out	Ctr.	In	
Class 1, Div. 2/Zone 2				
Logic Reed				
AR	O	O	X	1 N.O. - 1 N.C.
	X	O	O	
Sealed Switch				
AP	O	O	X	1 N.O. - 1 N.C.
	X	O	O	
Stackable Sealed Switch				
AY	O	O	X	1 N.O. - 1 N.C.
	X	O	O	

Note: X = Closed/O = Open

* Devices with N.C.L.B. contacts meet EN ISO 13850 and IEC 60947-5-5 standards for emergency stop applications.

† Not valid with head Type J.



2-Position Red Push-Pull and Push-Pull/Twist Release Devices, Illuminated

Note: A jumbo or large legend plate is recommended, if space allows.



Illuminated 2-Position Push-Pull
 Cat. No. 800T-FXP16RA1



2-Position Push-Pull
 Cat. No. 800T-FXJEP16RA1



Illuminated 2-Position Push-Pull/Twist
 Cat. No. 800T-FXTP16RA1



Illuminated 2-Position Push-Pull/Twist
 Cat. No. 800H-FRXT16RA1

Type	Lamp Type	Volts	Color	Contacts	Operator Position		Type 4/13			Type 4/4X/13
					Out	In	Push-Pull — 40 mm❖	Push-Pull — 60 mm with "E-Stop"❖	Push-Pull/Twist Release❖	Push-Pull/Twist Release❖
Operator Only*					No Contacts		800T-FXS00X	—	800T-FXTS00X	800H-FRXTS00X
Full Voltage	Incan.	24V AC/DC	Red	N.O. - N.C.L.B. ❖	O	X	800T-FXQ24RA1	800T-FXJEQ24RA1	800T-FXTQ24RA1	800H-FRXTQ24RA1
	No Lamp	0...250V AC/DC	No Lens				800T-FXQN25XA1	—	800T-FXTQN25XA1	800H-FRXTQN25XA1
Universal	LED	12...130V AC/DC	Red	❖	O	X	800T-FXQH2RA1	800T-FXJEQH2RA1	800T-FXTQH2RA1	800H-FRXTQH2RA1
Transformer	Incan.	120V AC	Red	N.O. - N.C.L.B. ❖	O	X	800T-FXP16RA1	800T-FXJEP16RA1	800T-FXTP16RA1	800H-FRXT16RA1
		240V AC					800T-FXP26RA1	800T-FXJEP26RA1	800T-FXTP26RA1	800H-FRXT26RA1
	120V AC	800T-FXPH16RA1					800T-FXJEPH16RA1	800T-FXTPH16RA1	800H-FRXTPH16RA1	
	240V AC	800T-FXP26RA1					800T-FXJEPH26RA1	800T-FXTPH26RA1	800H-FRXTPH26RA1	
Transformer	No Lamp	120V AC	No Lens	❖	O	X	800T-FXPN16XA1	—	800T-FXTPN16XA1	800H-FRXTPN16XA1

Note: X = Closed/O = Open Note: Emergency stop push buttons are compliant with EN ISO 13850 and EN/IEC 60947-5-5 Standards when using N.C.L.B. contact blocks.

* Operator only supplied without power module, lamp, lens cap, or contact blocks.

❖ Normally closed late break contact. When button is pushed from the OUT to IN position, the mechanical detent action of the operator occurs before electrical contacts change state. When the button is pulled from the IN to the OUT position, the electrical contacts change state before the mechanical detent occurs.

❖ Consult your local Rockwell Automation sales office or Allen-Bradley distributor for availability of illuminated E-stops with Self Monitoring Contact Blocks (SMCBs).

800 T - FX T PH 16 R A1

a b c d e e f g h

Protection Rating	
Code	Description
T	Metal, Type 4/13
H	Plastic, Type 4/4X/13

Finger-Safe Guards	
Code	Description
Blank	No guards
C	Guards on terminals

Head Type§		
800T Type 4/13	Description	800H Type 4/4X/13
Code		Code
FX	Mushroom head	FRX
FXJ	Jumbo mushroom	FRXJ
FXJE	Jumbo mushroom (push-pull) with "E-Stop"	—

Operator Function	
Code	Description
Blank	Push-pull▲
T	Push-pull/twist

Illumination Options	
Transformer	
Code	Description
P	Incandescent
PH	LED
Full Voltage	
Q	Incandescent
QH	Universal LED
Dual Input	
D	Diode type
DT	Transformer — relay type
DTH	Transformer — relay type LED

Voltage‡	
Transformer	
Code	Description
16	120V AC 50/60 Hz
26	240V AC 50/60 Hz
Full Voltage	
24	24V AC/DC
10	120V AC/DC
20	240V AC/DC
Universal LED	
2	12...130V AC/DC
Dual Input	
16	120V AC
24	24V AC/DC (dual input diode only)

Color Cap	
Code	Color
X	No cap (not valid with head Type J)
A	Amber
B	Blue
C	Clear
G	Green
R	Red
W	White

Target		
Contact	O	X
N.O.		
N.C./N.C.L.B.	X	O

Contact Blocks	
Code	Description
Blank	No contacts
Standard	
D1	1 N.O.
D2	1 N.C.
D4	1 N.C.L.B.
A	1 N.O. - 1 N.C.
A1	1 N.O. - 1 N.C.L.B.
A5	2 N.C.L.B.
PenTUFF (Low Voltage)	
D1V	1 N.O.
D2V	1 N.C.
D4V	1 N.C.L.B.
AV	1 N.O. - 1 N.C.

h (cont'd)

Contact Blocks	
Code	Description
Class 1, Div. 2/Zone 2	
Logic Reed	
D1R	1 N.O.
D2R	1 N.C.
AR	1 N.O. - 1 N.C.
Sealed Switch	
D1P	1 N.O.
D2P	1 N.C.
AP	1 N.O. - 1 N.C.
Stackable Sealed Switch	
D1Y	1 N.O.
D2Y	1 N.C.
AY	1 N.O. - 1 N.C.

‡ See page 10-20 for additional voltage code options.

§ Devices with N.C.L.B. contacts meet EN ISO 13850 and IEC 60947-5-5 standards for emergency stop applications.

▲ Push-Pull is available only with Bul. 800T.

❖ Diode type dual input provides circuit isolation via opposing diodes. Not recommended for use with solid-state outputs.

Bulletin 800T/H
30.5 mm Push Buttons
 Push-Pull Operators

3-Position Push-Pull Devices, Illuminated



Illuminated 3-Position Push-Pull
 Cat. No. 800T-FXMP16RA7



Illuminated 3-Position Push-Pull
 Cat. No. 800H-FRXMP16A7

				Operator Position			Operator Position		
				Momentary	Maintained	Maintained	Momentary	Maintained	Momentary
Contacts				Out	Center	In	Out	Center	In
N.C.-				X	O	O	X	O	O
N.C.L.B.*				X	X	O	X	X	O

Type	Lamp Type	Volts	Color	Type 4/13	Type 4/4X/13	Type 4/13	Type 4/4X/13
				Cat. No.‡	Cat. No.‡	Cat. No.‡	Cat. No.‡
Operator Only*				800T-FXMS00X	800H-FRXMS00X	800T-FXNS00X	800H-FRXNS00X
Full Voltage	Incandescent	24V AC/DC	Red	800T-FXMQ24RA7	800H-FRXMQ24RA7	800T-FXNQ24RA7	800H-FRXNQ24RA7
	No Lamp	0...250V AC/DC	No Lens	800T-FXMQN25XA7	800H-FRXMQN25XA7	800T-FXNQN25XA7	800H-FRXNQN25XA7
Universal	LED	12...130V AC/DC	Red	800T-FXMQH2RA7	800H-FRXMQH2RA7	800T-FXNQH2RA7	800H-FRXNQH2RA7
Transformer	Incandescent	120V AC	Red	800T-FXMP16RA7	800H-FRXMP16RA7	800T-FXNP16RA7	800H-FRXNP16RA7
	LED	120V AC		800T-FXMPH16RA7	800H-FRXMPH16RA7	800T-FXNPH16RA7	800H-FRXNPH16RA7
	No Lamp	120V AC	No Lens	800T-FXMPN16XA7	800H-FRXMPN16XA7	800T-FXNPN16XA7	800H-FRXNPN16XA7

Note: X = Closed/O = Open

* Normally closed late break contact. When button is pushed from the OUT to IN position, the mechanical detent action of the operator occurs before electrical contacts change state. When the button is pulled from the IN to the OUT position, the electrical contacts change state before the mechanical detent occurs.

* Operator only supplied without power module, lamp, lens cap, or contact blocks.

‡ Devices with N.C.L.B. contacts meet EN ISO 13850 and EN/IEC 60947-5-5 standards for emergency stop applications.

800 T - FX M PH 16 R A1
 a b c d e f g h

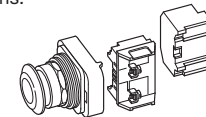

a

Protection Rating	
Code	Description
T	Metal, Type 4/13
H	Plastic, Type 4/4X/13

b

Finger-Safe Guards	
Code	Description
Blank	No guards
C	Guards on terminals

c

Head Type‡		
800T Type 4/13	Description	800H Type 4/4X/13
Code		Code
FX	Mushroom head	FRX
FXJ	Jumbo mushroom	FRXJ

d

Operator Function			
Code	Operator Position		
M	Mom.	Main.	Main.
N	Mom.	Main.	Mom.

Mom. – Momentary, Main. – Maintained.

e

Illumination Options	
Transformer	
Code	Description
P	Incandescent
PH	LED
Full Voltage	
Q	Incandescent
QH	Universal LED
Dual Input	
D	Diode type
DT	Transformer — relay type
DTH	Transformer — relay LED

f

Voltage§	
Transformer	
Code	Description
16	120V AC 50/60 Hz
26	240V AC 50/60 Hz
Full Voltage	
24	24V AC/DC
10	120V AC/DC
20	240V AC/DC
Universal LED	
2	12...130V AC/DC
Dual Input	
16	120V AC
24	24V AC/DC▲

g

Color Cap	
Code	Color
X	No cap (not valid with head Type J)
A	Amber
B	Blue
C	Clear
G	Green
R	Red
W	White

h

Target			
Contact			
N.O.	O	O	X
N.C.	X	O	O
N.C.L.B.	X	X	O
Contact Blocks			
Code	Description		
Blank	No contacts on operator		
Standard			
A	1 N.O. - 1 N.C.		
A1	1 N.O. - 1 N.C.L.B.		
A7	1 N.C. - 1 N.C.L.B.		
PenTUFF (Low Voltage)			
AV	1 N.O. - 1 N.C.		
Class 1, Div. 2/Zone 2			
Logic Reed			
AR	1 N.O. - 1 N.C.		
Sealed Switch			
AP	1 N.O. - 1 N.C.		
Stackable Sealed Switch			
AY	1 N.O. - 1 N.C.		

§ See page 10-20 (Table f) for additional voltage code options.

‡ Devices with N.C.L.B. contacts meet EN ISO 13850 and EN/IEC 60947-5-5 standards for emergency stop applications.

¶ Diode type dual input provides circuit isolation via opposing diodes. Not recommended for use with solid-state outputs.

▲ Dual input diode only.

Potentiometer Devices*❄



Cat. No. 800T-U24



Cat. No. 800H-UR4

Resistance	Type 4/13	Type 4/4X/13	Resistance	Type 4/13	Type 4/4X/13
	Potentiometer‡	Potentiometer‡		Potentiometer‡	Potentiometer‡
	Cat. No.	Cat. No.		Cat. No.	Cat. No.
Operator Only without Resistive Element	800T-N37§	800H-N102§	25 kΩ	800T-U37	800H-UR37
150 Ω	800T-U4	800H-UR4	50 kΩ	800T-U41	800H-UR41
500 Ω	800T-U12	800H-UR12	75 kΩ	800T-U46	800H-UR46
1000 Ω	800T-U13	800H-UR13	100 kΩ	800T-U49	800H-UR49
1500 Ω	800T-U16	800H-UR16	150 kΩ	800T-U50	800H-UR50
2500 Ω	800T-U19	800H-UR19	400 kΩ	800T-U54	800H-UR54
5000 Ω	800T-U24	800H-UR24	500 kΩ	800T-U55	800H-UR55
10 kΩ	800T-U29	800H-UR29	1 MΩ	800T-U57	800H-UR57
15 kΩ	800T-U34	800H-UR34	2 MΩ	800T-U59	800H-UR59
20 kΩ	800T-U35	800H-UR35	3 MΩ	800T-U62	800H-UR62
			4 MΩ	800T-U64	800H-UR64

* Single turn operation with 312° rotation.

❄ Does not meet Class 1 Div. 2 applications.

‡ Rated for 300V AC/DC, 2 W maximum (6V DC minimum). Specify Bulletin 800TC or 800HC for finger-safe potentiometers. Example: Cat. No. 800T-U29 becomes Cat. No. 800TC-U29.

§ For use with Type J potentiometers having a shaft length of 7/8 in. (22.2 mm) and a shaft diameter of 1/4 in. (6.3 mm).

Mechanically Interlocked Maintained Push Button Devices



Cat. No. 800T-FA22A



Cat. No. 800T-FB16A



Cat. No. 800T-FC16F



Cat. No. 800H-CRA22A

Contact Arrangement		Type 4/13			Type 4/4X/13	
		Button Position: Button Type/Color➤			Bootless♣	
Contact Type	Configuration/ Position	Upper: Flush/Black Lower: Flush/Black	Upper: Flush/Green Lower: Extended/ Red	Upper: Flush/Green Lower: Mushroom/ Red	Upper: Flush/Green Lower: Extended/ Red	Upper: Flush/Black Lower: Flush/Black
		Cat. No.	Cat. No.	Cat. No.	Cat. No.	Cat. No.
1 N.O. - 1 N.C.		800T-FA22A	800T-FB16A	800T-FC16A	800H-CRB16A	800H-CRA22A
2 N.O. - 2 N.C.		800T-FA22F	800T-FB16F	800T-FC16F	800H-CRB16F	800H-CRA22F
No Contact	—	800T-FA22	800T-FB16	800T-FC16	800H-CRB16	800H-CRA22

➤ Consult your local Rockwell Automation sales office or Allen-Bradley distributor for other operator types and combinations.

♣ If booted operators are desired, refer to page 10-39 to order boots separately.

Bulletin 800T/H
30.5 mm Push Buttons
 Specialty Operators



Cluster Pilot Light Devices (Bul. 800T Only)*



Color Cap Only With Lamps
 Cat. No. 800T-N249



Complete Unit
 Cat. No. 800T-PC416

Type	Lamp Type	Volts	Type 4/13	
			Color Cap With Lamps Cat. No.	Complete Unit Cat. No.
2-Light Color Cap with Lamps 2 Light 	Incandescent	24V AC/DC Full Voltage	800T-N257	800T-QC224
	LED	24V AC/DC Full Voltage	800T-N257L	800T-QCL224
	Incandescent	120V AC, 50/60 Hz Transformer	800T-N52	800T-PC216
3-Light Color Cap with Lamps 3 Light 	Incandescent	24V AC/DC Full Voltage	800T-N254	800T-QC324
	LED	24V AC/DC Full Voltage	800T-N254L	800T-QCL324
	Incandescent	120V AC, 50/60 Hz Transformer	800T-N51	800T-PC316
4-Light Color Cap with Lamps 4 Light 	Incandescent	24V AC/DC Full Voltage	800T-N251	800T-QC424
		120V AC, 50/60 Hz Transformer	800T-N50	800T-PC416

800T - PC 3 16 W R X R
 a b c d e f g h
 Position 1 Position 2 Position 3 Position 4

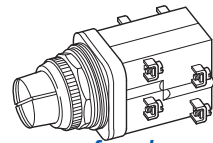

a

Finger-Safe Guards	
Code	Description
Blank	No guards
C	Guards on terminals

b

Power Module Type	
Code	Description
QC	Full voltage
PC	Transformer

c

Illumination Options and No. of Units	
Incandescent	
Code	Description
2	2 unit cluster
3	3 unit cluster
4	4 unit cluster
LED*†‡§	
L2	2 unit cluster
L3	3 unit cluster
L4	4 unit cluster

d

Voltage Options	
Full Voltage	
Code	Description
06	6V AC/DC
12	12V AC/DC
24	24V AC/DC
Transformer	
16	120V AC, 50/60 Hz

e, f, g, h

Color Options	
Code	Color
Blank (All 4 Positions)	Standard unit ▶
X	No color
A	Amber
B	Blue
C	Clear
G	Green
R	Red
W	White

Custom Lens Caps for Cluster Pilot Lights

800T - N249 R G A W
 a b c d e f
 Position 1 Position 2 Position 3 Position 4

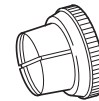

a

No. of Lamps/Voltage	
Transformer	
Code	Description
N50	4 lamps, 120V AC, 50/60 Hz
N51	3 lamps, 120V AC, 50/60 Hz
N52	2 lamps, 120V AC, 50/60 Hz
N249	4 lamps, 6V AC/DC
N250	4 lamps, 12V AC/DC
N251	4 lamps, 24V AC/DC
N252	3 lamps, 6V AC/DC
N253	3 lamps, 12V AC/DC
N254	3 lamps, 24V AC/DC
N255	2 lamps, 6V AC/DC
N256	2 lamps, 12V AC/DC
N257	2 lamps, 24V AC/DC

b

Illumination Options	
Code	Description
Blank	Incandescent
L	LED*

c, d, e, f

Code	Description
Blank (All Positions)	Standard unit ▶
A	Amber
B	Blue
C	Clear
G	Green
R	Red
W	White
X	No color

* Rated Type 4/13 indoor only.
 * LEDs are available in red, green and amber only; lens color matches LED color. Exception: the white lens is supplied with an amber LED.
 † White lenses use amber LEDs.
 ‡ LEDs could be adversely affected when used with solid-state outputs.
 § 6V and 12V are positive polarity. 24V LEDs are bipolar.
 ▶ See table above for standard unit colors.



18 mm Small Pilot Lights Type 4/13, Class I, Division 2

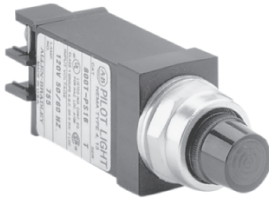

18 mm Pilot Light
 Cat. No. 800T-PS16R

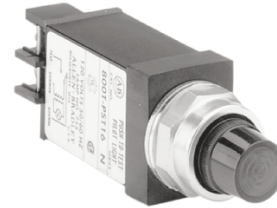

18 mm Push-to-Test Pilot Light
 Cat. No. 800T-PST16R

Type	Lamp	Voltage	Color	Pilot Light	Push-To-Test
				Cat. No.	Cat. No.
Transformer	Incandescent	120V AC 50/60 Hz	Red	800T-PS16R	800T-PST16R
	LED			800T-PSH16R	800T-PSTH16R
Dual Input Diode	Incandescent	120V AC		800T-PSD16R	—
		24V AC/DC		800T-PSD24R	—
Dual Input Transformer	Incandescent	120V AC/DC 50/60 Hz		800T-PSDT16R	—
Full Voltage	Incandescent	24V AC/DC		800T-QS24R	800T-QST24R
		24V AC/DC		800T-QSH24R	800T-QSTH24R
	LED	120V AC		800T-QSH10R	800T-QSTH10R
		Neon		120V AC/DC	800T-RS10A

800T – PS D c 16 R
 a b c d e

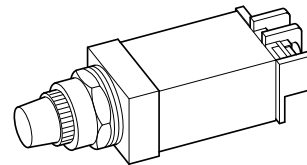

a

Power Module Type	
Code	Description
PS	Transformer (or dual input)
QS	Full voltage
RS	Neon*

b

Lamp Test Options	
Code	Description
Blank	No test option
D	Dual input diode
DT	Dual input transformer relay➤
T	Push-to-test➤

- * Neon is only available in amber or clear.
- ‡ LEDs available in red, green, amber, blue, and white. LED color matches lens color, except clear lens supplied with white LED and white lens supplied with amber LED. All LEDs except 120V have an internal shunt resistor for use with solid-state outputs.
- ♣ Dual input diode only.
- Class 1, Division 2 rating not available. Push-to-test rated for Type 13 only.

c

Illumination Options	
Transformer/Full Voltage/Dual Input	
Code	Description
Blank	Incandescent
H	LED‡
Neon	
Blank	No options

d

Voltage	
Transformer	
Code	Description
16	120V AC 50/60 Hz
26	240V AC 50/60 Hz
Full Voltage Incandescent	
12	12V AC/DC
24	24V AC/DC
Full Voltage LED	
10	120V AC
13	130V AC/DC
24	24V AC/DC
Neon	
10	120V AC/DC
20	240V AC/DC
Dual Input	
16	120V AC 50/60 Hz
24	24V AC/DC♣

e

Lens Color	
Plastic	
Code	Description
Blank	No lens
A	Amber
B	Blue
C	Clear
G	Green
R	Red
W	White

Bulletin 800T/H
30.5 mm Push Buttons
 Specialty Operators

1-, 2-, 3-, 4-Way Toggle Switches (Bul. 800T only)

Switch Type	Lever Movement	Handle Position					Type 4/13	
		Up	Left	Center	Right	Down	Spring Return Operation	Maintained Operation
2 Way	↕	●	○	○	○	○	800T-T2H3EEXX	800T-T2H1EEXX
		○	○	○	○	○		
	↔	○	●	○	○	○	800T-T2F3DDXX	800T-T2F1DDXX
		○	○	○	○	○		
4 Way	⬆️⬇️⬇️⬆️	●	○	○	○	○	800T-T4T8AAXX	800T-T4R1AAXX
		○	○	○	○	○		
		○	○	○	○	○		
		○	○	○	○	○		

Note: X = Closed/O = Open

800T **-** **T2** **H2** **E** **E** **X** **X**
a *b* *c* *d* *e* *f* *g*
 Right Left Right Left

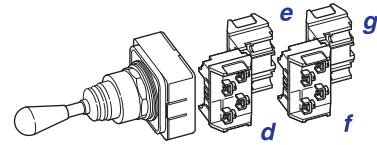

a

Finger-Safe Guards	
Code	Description
Blank	No guards
C	Guards on terminals

b

Operator Type	
Code	Description
T1	1-way toggle
T2	2-way toggle
T3	3-way toggle
T4	4-way toggle

Table 1. Contact Block Code

Contact Block Substitution	
Combination	Code
Standard	
D + E	A
D + D	* M
E + E	N
J + D	B
J + E	C

Table 2. 1-2-3-4 Way Toggle Switch Cam Targets

Contact Configuration					Suffix Code	
Position					Contact/Side	
Up	Left	Center	Right	Down	Right Side	Left Side
O	X	O	O	O	D, H, V, R, 5	—
O	O	O	O	X	E, U, W, S, 6	—
X	O	X	X	X	J, Q	—
X	X	X	X	O	G, I	—
X	O	O	O	O	—	E, U, W, S, 6
O	O	O	X	O	—	D, H, V, R, 5
O	X	X	X	X	—	G, I
X	X	X	O	X	—	J, Q

c

Lever Movement and Function		
Type	Function Code	Description
		↑ ← → ↓
1-Way	↑ A	1 M — — —
		2 S — — —
	← B	1 — M — —
		2 — S — —
→ C	1 — — M —	
	2 — — S —	
2-Way	↓ D	1 — — — M
		2 — — — S
	↖ E	1 M M — —
		2 M S — —
3-Way	↔ F	1 — M M —
		2 — M S —
	↕ G	1 — — M S
		2 — — S S
4-Way	↕ H	1 M — — M
		2 M — — S
	↔ I	1 M — M —
		2 M — S —
2-Way	↖ J	1 M — — M
		2 M — S —
	↕ K	1 — M — M
		2 — M — S

c (cont'd)

Lever Movement and Function		
Type	Function Code	Description
		↑ ← → ↓
3-Way	↕ L	1 M M M —
		2 M M S —
		3 M S M —
		4 M S S —
	↕ N	1 — M M M
		2 — M M S
		3 — M S M
		4 — M S S
3-Way	↕ P	1 M — M M
		2 M — M S
		3 M — S M
		4 M — S S
	↕ Q	1 M M — M
		2 M M — S
		3 M S — M
		4 M S — S
4-Way	↕ R	1 M M M M
		2 M M M S
		3 M M S M
		4 M M S S
	↕ T	1 M S M M
		2 S M M S
		3 S M S M
		4 S M S S

Contact Blocks	
Code	Description
Blank (all pos.)	No contacts
Standard	
D	1 N.O.
E	1 N.C.
G	1 N.O.E.M.
J	1 N.C.L.B.
A	1 N.O. - 1 N.C.
X	No contacts in this position
PenTUFF (Low Voltage)	
H	1 N.O.
U	1 N.C.
I	1 N.O.E.M.
Q	1 N.C.L.B.
F	1 N.O. - 1 N.C.
Class 1, Div. 2/Zone 2	
Logic Reed	
V	1 N.O.
W	1 N.C.
T	1 N.O. - 1 N.C.
Sealed Switch	
R	1 N.O.
S	1 N.C.
P	1 N.O. - 1 N.C.
Stackable Sealed Switch	
5	1 N.O.
6	1 N.C.
7	1 N.O. - 1 N.C.

Note: M = Maintained, S = Spring Return
 * XA2 and XA2R contact blocks cannot be stacked upon, but they can stack on other contact blocks.

Selector Push Button Devices (Bul. 800T only)



Selector Push Button
 Cat. No. 800T-K2AAXX

Contact Type	Button Color	Button Type	Contact Position	Selector Sleeve Left		Selector Sleeve Right		Type 4/13 Selector Push Button
				Button Free	Button Depressed	Button Free	Button Depressed	Cat. No.
 1 N.O. - 1 N.C.	Black	Flush	Right	O	X	O	O	800T-KE2DEXX
			Left	O	O	X	O	
 2 N.O. - 2 N.C.	Black	Flush	Right	O	X	O	X	800T-K2AAXX
			Left	O	X	O	X	
 2 N.O. - 2 N.C.	Black	Flush	Right	O	X	O	X	800T-KC2AAXX
			Left	O	O	X	X	

Note: X = Closed/O = Open

800T **- KD** **2** **G** **J** **D** **E**
a *b* *c* *d* *e* *f* *g*
 Right Left Right Left

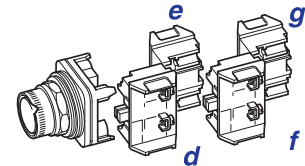

d, e, f, g (cont'd)

Finger-Safe Guards	
Code	Description
Blank	No guards
C	Guards on terminals

Cam and Head Type	
Code	Description
K	A cam with flush operator
KA	A cam with extended operator
KB	B cam with flush operator
KC	C cam with flush operator
KD	D cam with flush operator
KE	E cam with flush operator

Note: See Table 1 for Target description of each cam.

Color Cap	
Code	Color
1	Green
2	Black
6	Red

Contact Blocks	
Code	Description
Blank (all pos.)	No contacts on operator
Standard	
D	1 N.O.
E	1 N.C.
G	1 N.O.E.M.
J	1 N.C.L.B.
A	1 N.O. - 1 N.C.
X	No contacts in this position
PenTUFF (Low Voltage)	
H	1 N.O.
U	1 N.C.
I	1 N.O.E.M.
Q	1 N.C.L.B.
F	1 N.O. - 1 N.C.

Contact Blocks	
Code	Description
Class 1, Div. 2/Zone 2	
Logic Reed	
V	1 N.O.
W	1 N.C.
T	1 N.O. - 1 N.C.
Sealed Switch	
R	1 N.O.
S	1 N.C.
P	1 N.O. - 1 N.C.
Stackable Sealed Switch	
5	1 N.O.
6	1 N.C.
7	1 N.O. - 1 N.C.

Table 2. Contact Block Reduction Rules

Contact Block Substitution	
Standard	
Combination	Substitute Code
D + E	A
D + D	M*
E + E	N
J + D	B
J + E	C

Table 1. Selector Push Button Cam Targets (Note: X = Closed/O = Open)

Sleeve Position				Cam Description									
Right		Left		KA/K		KB		KC		KD		KE	
Button Free	Button Pressed	Button Free	Button Pressed	Right	Left	Right	Left	Right	Left	Right	Left	Right	Left
O	O	O	X	—	—	—	D, H, V, R, 5	—	D, H, V, R, 5	—	—	—	—
O	O	X	O	E, U, W, S, 6	E, U, W, S, 6	—	—	—	—	—	E, U, W, S, 6	—	E, U, W, S, 6
O	O	X	X	—	—	—	—	—	—	E, U, W, S, 6	—	E, U, W, S, 6	—
O	X	O	O	—	—	—	—	D, H, V, R, 5	—	D, H, V, R, 5	—	D, H, V, R, 5	—
O	X	O	X	D, H, V, R, 5	D, H, V, R, 5	D, H, V, R, 5	—	—	—	—	D, H, V, R, 5	—	D, H, V, R, 5
O	X	X	O	—	—	—	—	—	—	—	—	—	—
X	O	X	O	J or Q	J or Q	E, U, W, S, 6	—	—	—	—	J or Q	—	J or Q
X	X	O	O	—	—	—	—	—	—	G or I	—	G or I	—
X	X	O	X	G or I	G or I	—	—	—	—	—	G or I	—	G or I
X	O	X	X	—	—	—	—	E, U, W, S, 6	—	J or Q	—	J or Q	—
X	X	X	O	—	—	—	E, U, W, S, 6	—	E, U, W, S, 6	—	—	—	—

Bulletin 800T/H
30.5 mm Push Buttons
 Specialty Operators

Cylinder Lock Push Button Devices (Bul. 800T only)



Cylinder Lock Push Button
 Cat. No. 800T-E15A



Mushroom Style Cylinder Lock
 Cat. No. 800T-E15M6A

Type of Cylinder Lock	Lock Position	Type 4/13	
		Standard Cylinder Lock	Red Mushroom Cylinder Lock
		Cat. No.*	Cat. No.*❖
Spring Bolt — Lock can be set with key when button is in the OUT position. Button will lock when depressed. Key removable in any position. 1 N.O. - 1 N.C.	IN	800T-E15A	800T-E15M6A
Dead Bolt A — Button can only be operated with the key in the lock. Key removable in locked position only. 1 N.O. - 1 N.C.	IN	800T-E24A	800T-E24M6A
	OUT	800T-E14A	800T-E14M6A
Dead Bolt B — Button can be operated with or without the key inserted in the lock. Key removable in any position. 1 N.O. - 1 N.C.	IN	800T-E12A	800T-E12M6A
	OUT	800T-E11A	800T-E11M6A

* Each device supplied with 2 keys. Replacement key part no. for standard E158 is X-144218.

❖ For jumbo size mushroom cap, change **M** to **J**. Example: Cat. No. 800T-E15M6A becomes Cat. No. 800T-E15J6A.

Momentary Padlocking Mushroom Head Devices (Bul. 800T only) ‡



Padlocking Mushroom Button
 Cat. No. 800T-D6QA



Padlocking Jumbo Mushroom Button
 Cat. No. 800T-D6LQA

Contact Type	Button Color	Type 4/13	
		Standard Size Metal Mushroom Head	Jumbo Size Metal Mushroom Head
		Cat. No.§	Cat. No.§
No Contact	Red	800T-D6Q	800T-D6LQ
1 N.O.		800T-D6QD1	800T-D6LQD1
1 N.C.		800T-D6QD2	800T-D6LQD2
1 N.O. - 1 N.C.		800T-D6QA	800T-D6LQA

‡ Allows locking in the depressed position. Will hold N.C. contacts open, but might not hold N.O. contacts closed.

§ To order without the padlocking attachment, change **Q** to **F**. Example: Cat. No. 800T-D6QA becomes Cat. No. 800T-D6FA

Momentary Wobble Stick Push Button Devices (Bul. 800T Type 13 only)

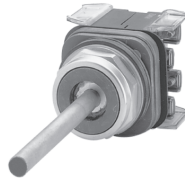





Wobble Stick Unit
 Cat. No. 800T-M1B

Contact Type	Wobble Stick♣
No Contacts	Cat. No. 800T-M1
1 N.O.	800T-M1D1
1 N.O. - 1 N.C.	800T-M1A
2 N.O. - 2 N.C.	800T-M1B







♣ Can be operated from any angle.

Bulletin 800T/H
30.5 mm Push Buttons
 Specialty Operators

Break-Glass Push Button Stations (Bul. 800T only)
 Complete Station

	Description	Contact Type	Cat. No.
 <i>Cat. No. 800T-NX114</i>	Break-Glass Push Button Station Red push button station in a Type 4/13 enclosure incorporates either one or two snap-action contact blocks, which are operated when the small glass window is broken. Includes STOP legend.	 1 N.O. - 1 N.C.	800T-NX114
		  2 N.O. - 2 N.C.	800T-NX115

Miscellaneous Kits

	Description	Contact Type	Cat. No.
 <i>Cat. No. 800T-S6M</i>	Unit Only Kit The break-glass unit less the enclosure is available as a kit to install into the customer's enclosure. The kit includes the contact unit, the hammer and chain and five extra glass discs with one button tack. This kit does not include legend plate. For legend plates, see page 10-48.	 1 N.O. - 1 N.C.	800T-S6M
		 2 N.O. - 2 N.C.	800T-S6N
 <i>Cat. No. 800T-NXM</i>	Replacement Snap Action Contact Block Kit This kit is used to replace the snap action contact block.	 1 N.O. - 1 N.C.	800T-NXM
		 2 N.O. - 2 N.C.	800T-NXN
 <i>Cat. No. 800T-N28</i>	Description		Cat. No.
	Glass Disc Kit Each replacement kit for break-glass push button units or stations consists of six glass discs and one button tack.		800T-N28

10

Approximate Dimensions

Dimensions in inches (millimeters). Dimensions are not intended to be used for manufacturing purposes.

Break-Glass Station

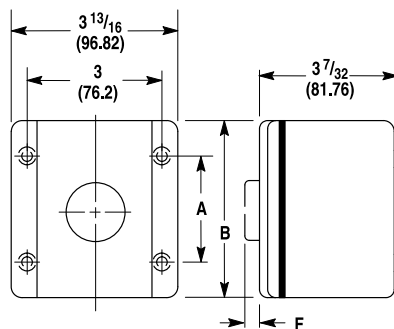

A = $2 \frac{3}{4}$ (69.85)
 B = $4 \frac{3}{16}$ (106.38)
 F = $9 \frac{9}{16}$ (14.28)



Custom-Built Stations



Description

The table on page 10-5 lists the most commonly used Bulletin 800T/800H push button stations. Stations not listed in this table may be ordered as custom-built stations.

Cat. No.





The cat. no. used to identify custom-built Bulletin 800T push button stations will be cat. no. listed for enclosure only. The letter **Z** will be substituted for the letter **W** and a station serial no. will be added.

Ordering Information

The following information is required when ordering custom-built push button stations.

1. Cat. no. of enclosure.
2. Cat. no. of control units.
3. Legend plate cat. no. and/or marking for each unit.
4. Specify vertical/horizontal mounting.
5. Specify desired operator mounting sequence. Inclusion of a sketch is recommended. If no information is given, standard configuration will be used.

Enclosures

No. of Operator Openings	Surface Mount*		Flush Mount	Pendant Type	
	Die Cast* (Type 4/13)	Sheet Metal (Type 13)	Die Cast Face Plate (Type 4/13)	One Hole in Bottom (Type 13)	Openings in Cover (Type 13)
	 Cat. No. 800T-2TZ	 Cat. No. 800T-6TJZ	 Cat. No. 800T-2ZT	 Cat. No. 800T-2PZ	 Cat. No. 800T-2PY
	Cat. No.	Cat. No.	Cat. No.	Cat. No.	Cat. No.
1	800T-1TZ*	—	800T-1ZT	—	—
2	800T-2TZ*	—	800T-2ZT	800T-2PZ	800T-2PY
3	800T-3TZ*	—	800T-3ZT	800T-3PZ	800T-3PY
4	800T-4TZ*	—	800T-4ZT	800T-4PZ	800T-4PY
5	—	—	—	800T-5PZ	800T-5PY
6‡	800T-6TZ*	—	800T-6ZT	800T-6PZ	800T-6PY
6§	800T-6THZ*	800T-6TJZ	800T-6ZTH	—	—
7	—	—	—	800T-7PZ	800T-7PY
8	—	—	—	800T-8PZ	800T-8PY
9	800T-9TZ	800T-9TJZ	800T-9ZT	800T-9PZ	800T-9PY
10	—	—	—	800T-10PZ	800T-10PY
12	800T-12TZ	800T-12TJZ	800T-12ZT	—	—
16	800T-16TZ	800T-16TJZ	800T-16ZT	—	—
20	—	800T-20TJZ	—	—	—
25	—	800T-25TJZ	—	—	—

Note: Specialty enclosures available. Please refer to KB Q69259778.

Note: Enclosure and conduit dimensions are detailed on page 10-61.

* Bottom conduit entry. Grounding provision provided.

* Enclosure depth will accommodate one shallow and one mini-contact block stacked.

* Add suffix **Y** to the cat. no. for yellow painted enclosure. Example: **Cat. No. 800T-1TZY**.

‡ One vertical row.

§ Two vertical rows of three holes.

Custom-Built Stations (800H only)



Cat. No.

The cat. no. used to identify custom-built Bulletin 800H push button stations will be cat. no. listed for enclosure only. The letter **W** is substituted for the letter **Z** and a station serial no. will be added.

Ordering Information

The following information is required when ordering custom-built push button stations:

1. Cat. no. of enclosure.
2. Cat. no. of control units.
3. Legend plate cat. no. and/or marking for each unit.
4. Specify vertical/horizontal mounting.
5. Specify operator mounting sequence that you want. Including a sketch is recommended. If information not given, standard configuration will be used.

Enclosures (800H only)

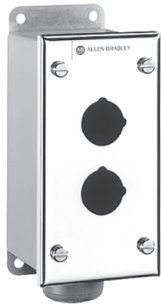

Stainless Steel
Cat. No. 800H-2HZ4



Rosite Glass Polyester
Cat. No. 800H-2HZ4R



Fiberglass
Cat. No. 800H-2HZ4Y



Thermoplastic Polyester
Cat. No. 800H-2HZ4C

No. of Operator Openings	Conduit Hubs		Stainless Steel (#304) Type 4/4X/13*	Rosite Glass Polyester Type 4/4X/13	No. of Operator Openings	Conduit Openings		Fiberglass* Type 4/4X/13	Thermoplastic Polyester* Type 4/4X
	No.	Dia. [in.]	Cat. No.	Cat. No.		No.	Dia. [in.]‡	Cat. No.	Cat. No.
0§	1	3/4	800H-0HZ4	—	1	1	3/4	800H-1HZ4Y	800H-1HZ4C
1	1	3/4	800H-1HZ4	800H-1HZ4R	2	1	1	800H-2HZ4Y	800H-2HZ4C
1	2	3/4	—	800H-1HZ4RM1	3	1	1	800H-3HZ4Y	800H-3HZ4C
1	1	1	—	800H-1HZ4RM2	4	—	—	—	800H-4HZ4C
2	1	3/4	800H-2HZ4	800H-2HZ4R	—	—	—	—	—
2	2	3/4	800H-2HZ4M1	800H-2HZ4RM1	—	—	—	—	—
2	1	1	800H-2HZ4M2	800H-2HZ4RM2	—	—	—	—	—
3	1	3/4	800H-3HZ4	800H-3HZ4R	—	—	—	—	—
3	2	3/4	800H-3HZ4M1	800H-3HZ4RM1	—	—	—	—	—
4	1	3/4	800H-4HZ4	800H-4HZ4R	—	—	—	—	—
4	2	3/4	800H-4HZ4M1	800H-4HZ4RM1	—	—	—	—	—
5	1	1	800H-5HZ4	—	—	—	—	—	—
6	1	1	800H-6HZ4	800H-6HZ4R	—	—	—	—	—
7	1	1	800H-7HZ4	—	—	—	—	—	—
8	1	1	800H-8HZ4	—	—	—	—	—	—

Note: Other combinations of conduit hub sizes are available upon request. Enclosure and conduit dimensions are detailed on page 10-61.

* Grounding screw provided with stainless steel enclosure.

⊗ Extra deep. Accommodates two levels of stackable sealed switch contact blocks.

‡ Conduit hubs must be ordered separately. For 3/4 in. hub, order **Cat. No. 1490-N9**. For 1 in. hub, order **Cat. No. 1490-N10**.

§ Identical to **Cat. No. 800H-1HZ4** but without mounting holes.

♣ No conduit openings provided.

➤ Yellow thermoplastic enclosures may be ordered by adding a **Y** to the cat. no. Example: **Cat. No. 800H-1HZ4C** becomes **Cat. No. 800H-1HZ4CY**.



Contact Blocks

Packaged in kit form for field installation. All necessary mounting hardware is provided with each contact block kit. **Contact ratings are listed on page 10-4.**

Note: It is not recommended to mount more than four contact blocks on any one non-illuminated operator (maximum two blocks deep). Contact blocks cannot be stacked onto power modules, so illuminated operators are limited to two contact blocks. Sealed switch contact blocks are not stackable and are limited to two blocks per operator. Time delay contacts are only available as one circuit per operator.



Shallow Block

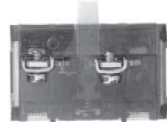

PenTUFF™ (Low Voltage) Contact Block



Logic Reed Block



Sealed Switch Block

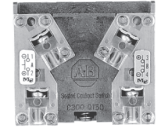

Stackable Sealed Switch Block

Contact Type	Shallow Block**		PenTUFF (Low Voltage) Block**		Logic Reed Block‡		Sealed Switch Block‡		Stackable Sealed Switch Block‡	
	Cat. No.	Code	Cat. No.	Code	Cat. No.	Code	Cat. No.	Code	Cat. No.	Code
1 N.O.	800T-XD1	D	800T-XD1V	H	800T-XD1R	V	800T-XD1P	R	800T-XD1Y	5
1 N.C.	800T-XD2	E	800T-XD2V	U	800T-XD2R	W	800T-XD2P	S	800T-XD2Y	6
1 N.O.E.M.	800T-XD3	G	800T-XD3V	I	—	—	—	—	—	—
1 N.C.L.B.	800T-XD4	J	800T-XD4V	Q	—	—	—	—	—	—
1 N.O. - N.C.	800T-XA	A	800T-XAV	F	800T-XAR	T	800T-XAP	P	800T-XAY	7
2 N.O.	800T-XA2§	M	—	—	800T-XA2R§	Y	—	—	800T-XA2Y	8
2 N.C.	800T-XA4	N	—	—	800T-XA4R	Z	—	—	800T-XA4Y	9
1 N.C.L.B. - 1 N.O.	800T-XA1	B	—	—	—	—	—	—	—	—
1 N.C.L.B. - 1 N.C.	800T-XA7	C	—	—	—	—	—	—	—	—

Note: Modular suffix codes can be used when specifying selector switches with multiple contact blocks.



Self Monitoring Contact Block

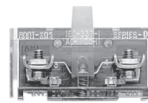

Mini Block

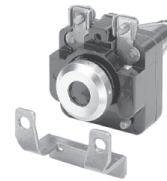

Time Delay Block



MaxDuty Block

Contact Type	S.M.C.B.*>	
	Cat. No.	Code
1 N.C.L.B. (wired in series with 1 N.O. monitoring contact)	800TC-XD4S	3

Contact Type	Mini Block*		Time Delay Block*	MaxDuty Block	
	Cat. No.	Code	Cat. No.	Cat. No.	Code
1 N.O.	800T-XD5	K	800T-XT	800T-XD1M	1
1 N.C.	800T-XD6	L	800T-XS	800T-XD2M	2
1 N.C.L.B.	—	—	—	800T-XD4M	4

Note: Modular suffix codes can be used when specifying selector switches with multiple contact blocks.

* Contact blocks with normally closed contacts meet direct drive positive opening standard requirements when properly fused to IEC 269-1 and 269-2. Shallow/mini contacts: 10 A gl or N type cartridge fuse. PenTUFF contacts: 6 A gl or N type cartridge fuse.

** Specify Bulletin 800TC for finger-safe contact blocks. Example: **Cat. No. 800T-XA** becomes **Cat. No. 800TC-XA**.

‡ 800T operator using sealed switch and logic reed contact blocks and installed in a suitable enclosure are UL Listed as suitable for use in Class I, Division 2/Zone 2 hazardous locations.

§ Additional contacts cannot be stacked on XA2 and XA2R contact blocks.

♣ For contact ratings, see page 10-4.

> For use with 2-position push-pull or push-pull/twist operators only. Must be mounted on the first level of the operator. The N.O. monitoring contact automatically closes when the S.M.C.B. is properly installed onto the operator. If the S.M.C.B. is separated from the operator, the N.O. monitoring contact automatically opens.

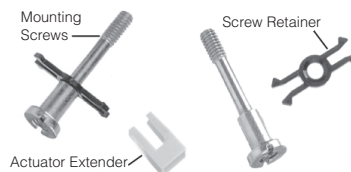

Shallow Contact Block Hardware

Description	Cat. No.
Contact Block Mounting Screw	800T-N335
Screw Retainer	800T-N336
Actuator Extender	800T-N337

Bulletin 800T/H
30.5 mm Push Buttons
 Accessories

Power Modules

Packaged in kit form for field installation. Lamps are listed on page 10-45.

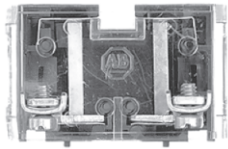

Full Voltage Power Module
 Cat. No. 800T-N330



Transformer Power Module
 Cat. No. 800T-N326

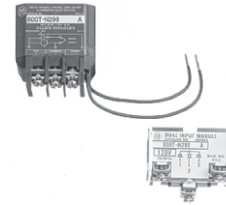

Dual Input Power Modules
 Cat. No. 800T-N296 (Transformer)
 Cat. No. 800T-N290N (Diode)

Full Voltage§		Transformer§		Dual Input		
Lamp Voltage	Cat. No.	Voltage	Cat. No.	Type	Voltage	Cat. No.
6...130V AC/DC	800T-N330	48V AC 50/60 Hz	800T-N325	Transformer*	120V AC	800T-N296
		120V AC 50/60 Hz	800T-N326	Diode Type*	24V AC/DC	800T-N291N
		240V AC 50/60 Hz	800T-N327		120V AC/DC	800T-N290N
		277V AC 50/60 Hz	800T-N327Y		—	—
		480V AC 50/60 Hz	800T-N328	—	—	
240V AC/DC‡	800T-N331	600V AC 50/60 Hz	800T-N329	—	—	—

* Transformer type dual input provides circuit isolation via a miniature type relay. This module is used in conjunction with a 120V transformer.

* Diode type dual input provides circuit isolation via opposing diodes. Not recommended for use with solid-state outputs and neon indicators.

‡ 240V full voltage module contains 50% dropping resistors for use with a 120V incandescent lamp.

§ Specify Bulletin 800TC for finger-safe power modules. Example: **Cat. No. 800T-N330** becomes **Cat. No. 800TC-N330**.

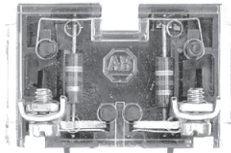

Resistor Power Module
 Cat. No. 800T-N332

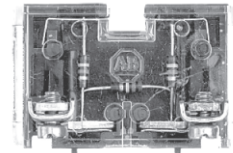

Neon Power Module
 Cat. No. 800T-N333

Resistor (10% Drop)➤		Neon♣➤	
Voltage	Cat. No.	Voltage	Cat. No.
120V AC/DC	800T-N332	120V AC/DC	800T-N333
		240V AC/DC	800T-N334

♣ Neon modules contain resistors.

➤ Specify Bulletin 800TC for finger-safe power modules. Example: **Cat. No. 800T-N332** becomes **Cat. No. 800TC-N332**.

Universal LED Module



Voltage	Cat. No.
12...130V AC/DC	800TC-N374

10

Trigger Action E-Stop Latches



Cat. No. 800T-N380



Cat. No. 800T-N379

Description	Cat. No.
Illuminated type	800T-N380
Non-illuminated type	800T-N379

Replacement Color Caps

Color caps listed below are for field replacement on installed devices or for completion of devices ordered with color caps omitted.



Push-Pull



Push-Pull/Twist



Push-Pull Jumbo



Push-Pull/Twist Jumbo

Push-Pull Color Caps, Illuminated

Color	800T Push-Pull	800H Push-Pull	800T/H Push-Pull/Twist	800T/H Push-Pull Jumbo	800T/H Push-Pull/Twist Jumbo
	Cat. No.	Cat. No.	Cat. No.	Cat. No.	Cat. No.
Amber	800T-N159A	800H-N112A	800T-N301A	800T-N209A	800T-N306A
Blue	800T-N159B	800H-N112B	800T-N301B	800T-N209B	800T-N306B
Clear	800T-N159C	800H-N112C	800T-N301C	800T-N209C	800T-N306C
Green	800T-N159G	800H-N112G	800T-N301G	800T-N209G	800T-N306G
Red	800T-N159R	800H-N112R	800T-N301R	800T-N209R	800T-N306R
White	800T-N159W	800H-N112W	800T-N301W	800T-N209W	800T-N306W



Illuminated Mushroom



Illuminated Jumbo Mushroom

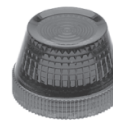

Standard

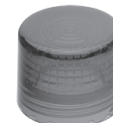

Push-to-Test



Glass Caps for Pilot Lights

Color	800T/H Push Button Color Caps, Illuminated		800T/H Pilot Light Color Caps			Glass Caps for 800T Pilot Lights
	Mushroom	Jumbo Mushroom	Standard*	Push-to-Test*	18 mm	
	Cat. No.	Cat. No.	Cat. No.	Cat. No.	Cat. No.	
Amber	800T-N304A	800T-N305A	800T-N26A	800T-N42	800T-N122A	800T-N22
Blue	800T-N304B	800T-N305B	800T-N26B	800T-N43	800T-N122B	800T-N23
Clear	800T-N304C	800T-N305C	800T-N26C	800T-N45	800T-N122C	800T-N25
Green	800T-N304G	800T-N305G	800T-N26G	800T-N41	800T-N122G	800T-N21
Red	800T-N304R	800T-N305R	800T-N26R	800T-N40	800T-N122R	800T-N20
White	800T-N304W	800T-N305W	800T-N26W	800T-N44	800T-N122W	800T-N24

* Available in bulk quantities of 20. Add suffix (-BP) to the cat. no. and order in multiples of 20.



Plastic Mushroom



Plastic Jumbo Mushroom



Padlocking Metal Mushroom



Metal Jumbo Mushroom

Push Button Color Caps, Non-Illuminated

Button Color	800T Plastic Mushroom	800H Plastic Mushroom	800T Plastic Jumbo Mushroom	800H Plastic Jumbo Mushroom	800T Padlocking Metal Mushroom	800T Metal Jumbo Mushroom
	Cat. No.	Cat. No.	Cat. No.	Cat. No.	Cat. No.	Cat. No.
Red	800T-N246R	800H-N114A	800T-N247R	800H-N115A	800T-N311R	* 800T-N248R
Green	800T-N246G	800H-N114B	800T-N247G	800H-N115B	800T-N311G	* 800T-N248G
Black	800T-N246B	800H-N114H	800T-N247B	800H-N115H	800T-N311B	* 800T-N248B
Orange	800T-N246O	800H-N114F	800T-N247O	800H-N115F	800T-N311O	⊛ 800T-N248O
Grey	800T-N246GR	800H-N114G	800T-N247GR	800H-N115G	800T-N311GR	800T-N248GR
Blue	800T-N246BL	800H-N114C	800T-N247BL	800H-N115C	800T-N311BL	* 800T-N248BL
Yellow	800T-N246Y	800H-N114E	800T-N247Y	800H-N115E	800T-N311Y	* 800T-N248Y
Natural	—	—	—	—	—	‡ 800T-N248
White	800T-N246W	800H-N114L	—	800H-N115L	—	—

For padlocking jumbo mushroom style:

* change listed cat. no. from **248** to **313**. Example: **Cat. No. 800T-N248G** becomes **Cat. No. 800T-N313G**.

⊛ change listed cat. no. from **Cat. No. 800T-N248O** to **Cat. No. 800T-N313**.

‡ change listed cat. no. from **Cat. No. 800T-N248** to **Cat. No. 800T-N313GR**.

Replacement Color Caps, Continued

Color caps listed below are for field replacement on installed devices or for completion of devices ordered with color caps omitted.



Push-Pull



Push-Pull/Twist



Push-Pull Jumbo



Push-Pull/Twist Jumbo

Button Color	800T/H Push-Pull Color Caps, Non-Illuminated			
	Push-Pull	Push-Pull/Twist	Push-Pull Jumbo	Push-Pull/Twist Jumbo
	Cat. No.	Cat. No.	Cat. No.	Cat. No.
Red	800T-N160A	800T-N302A	800T-N208A	800T-N307A
Green	800T-N160B	800T-N302B	800T-N208B	800T-N307B
Blue	800T-N160C	800T-N302C	800T-N208C	800T-N307C
Yellow	800T-N160E	800T-N302E	800T-N208E	800T-N307E
Orange	800T-N160F	800T-N302F	800T-N208F	800T-N307F
Grey	800T-N160G	800T-N302G	800T-N208G	800T-N307G
Black	800T-N160H	800T-N302H	800T-N208H	800T-N307H
White	800T-N160L	800T-N302L	800T-N208L	800T-N307L

Selector Switch Knobs, Illuminated





Standard Knob



Knob Lever

Color	800T Knob Type		800H Knob Type	
	Standard Knob	Knob Lever	Standard Knob	Knob Lever
	Cat. No.	Cat. No.	Cat. No.	Cat. No.
Amber	800T-N297A	800T-N298A	800H-N154A	800H-N155A
Blue	800T-N297B	800T-N298B	800H-N154B	800H-N155B
Clear	800T-N297C	800T-N298C	800H-N154C	800H-N155C
Green	800T-N297G	800T-N298G	800H-N154G	800H-N155G
Red	800T-N297R	800T-N298R	800H-N154R	800H-N155R
White	800T-N297W	800T-N298W	800H-N154W	800H-N155W

Selector Switches

		Description	Item	Color	Cat. No.		
	<p>800T Knobs and Actuators for Selector Switches Selector switch knobs can be changed in the field. Standard knob and knob levers can be ordered with white inserts or with a packet of colored inserts which includes one insert of each color.</p>		Standard Knob	White	800T-N230F		
			Knob Lever	Kit	800T-N230		
				White	800T-N231F		
			Wing Lever	Kit	800T-N231		
				Grey	800T-N238		
				Red	800T-N238A		
			Coin Slot	Black Only	800T-N239		
		800H Knob	Standard Knob	White	800H-N145F		
			Description	Color	Cat. No.		
							
						Red	800T-N124
						Green	800T-N125
						Blue	800T-N126
						Yellow	800T-N127
						White	800T-N128
						Orange	800T-N286
			All	800T-N123			

Booted Selector Switch Knobs, Non-Illuminated (800H only)



Cat. No. 800H-NR5

Insert Material	Material			
	Chlorosulfonated Polyethylene ‡	Silicone • ‡	Urethane •• ‡	Ethylene • Propylene •• ‡
	Cat. No.	Cat. No.	Cat. No.	Cat. No.
Brass *	* 800H-NR5	* 800H-NR101	* 800H-NR100	* 800H-NR103
Stainless Steel	800HS-NR5	800HS-NR101	800HS-NR100	800HS-NR103

* Color insert packet (Cat. No. 800T-N123) is included in each kit.
 ‡ Dots printed on the inside of the boot identify the boot material.

Protective Boots

Protective Boot for Illuminated Push Buttons



Cat. No. 800H-N11



Cat. No. 800H-N12

Description	Type	Cat. No.
May be added to guarded units, units without guard or Push-to-Test devices. This protective boot guards against the entrance of foreign materials reaching the opening between the button and locking ring.	Boot without Guard	800H-N11
	Boot with Guard	800H-N12

Protective Boots for Non-Illuminated Push Buttons*

Boots supplied with control stations and components are made of a chlorosulfonated polyethylene material with stainless steel insert ring. To order boots with silicone, urethane, or ethylene propylene material, see the table below. Material application information shown below.



Cat. No. 800H-N5A

Insert Material	Boot Color	Material			
		Chlorosulfonated Polyethylene ‡	Silicone • ‡	Urethane •• ‡	Ethylene • Propylene •• ‡
		Cat. No.	Cat. No.	Cat. No.	Cat. No.
Stainless steel §	Red	800H-N5A	800H-N101R	800H-N100R	800H-N103R
	Green	800H-N5B	800H-N101G	800H-N100G	800H-N103G
	Black	800H-N5H	800H-N101B	800H-N100B	800H-N103B
	Yellow	800H-N5E	800H-N101Y	800H-N100Y	—
	Blue	800H-N5C	800H-N101BL	800H-N100BL	—

* May be added to flush or extended head push button units to protect against foreign materials reaching the opening between the button and the locking ring.
 § Series B boots incorporate a stainless steel insert as standard.
 ‡ Dots printed on the inside of the boot identify the boot material.

Protective Boot Application Information

– **Chlorosulfonated Polyethylene (synthetic rubber)**

Very resistant to attack by oxidizing chemicals such as concentrated sulfuric acid and hypochlorite solutions. Also resistant to attack by oils and performs well in a wide range of other chemicals and solvents. Good flex and high impact resistance. This is the standard boot material supplied with 800H NEMA Type 4/4X push buttons unless otherwise specified.

– **Silicone**

Superior high temperature resistance. Particularly suited for use where organic acids or vegetable oils may be present. Also superior resistance to the effects of outdoor use, such as oxygen, ozone, and weather.

– **Urethane**

Excellent resistance to mechanical failure. Most durable boot material. Particularly suited for use where lubricating oils and automotive fuels may be present. Also well-suited for outdoor use.



– **Ethylene-propylene**

Particularly suited for high temperature applications. Resistant to attack by many acids and alkalis, detergents, phosphate esters, ketones, alcohols, and glycols. Outstanding service in areas with hot water and steam wash downs.





Potentiometer Replacement Knobs

Description	Cat. No.
Type 4/13 (800T)	40274-073-55
Type 4/4X/13 (800H)	40274-073-54





Push Buttons

	Description	Cat. No.
 Cat. No. 800T-N179 <i>(Operators not included)</i>	Bul. 800T/H Mechanical Interlock Used on momentary contact push button units. Guards against closing the N.O. contacts of one button while the other button's N.O. contacts are closed. Buttons remain momentary. For maintained units, see page 10-25.	800T-N179
 Cat. No. 800T-N12	Bul. 800T Rocker Arm Operating Lever The rocker arm lever operates two flush head or one flush with one extended head momentary contact push button units spaced 1-27/32 in. (46.8 mm) center-to-center. Legend plates must be ordered separately and should be inverted 180° prior to engraving and installation.	800T-N12

Miscellaneous

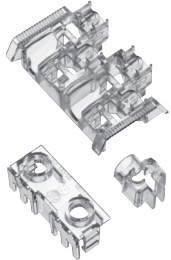



	Description	Cat. No.
 Cat. No. 800T-N245	Bul. 800T/H Mounting Ring Wrench This wrench will simplify tightening or loosening the octagonal mounting ring used on Bul. 800T units. This wrench is double-ended and can be used for 18 mm and 30 mm pilot light mounting rings.	800T-N245
 Cat. No. 800T-N209RE1	Bul. 800T/H Jumbo Push-Pull Cap For use on Bul. 800T or 800H push-pull operators. Fits on illuminated and non-illuminated devices.	800T-N209RE1
	Bul. 800T 63 mm Red Anodized Aluminum Cap For use on Bul. 800T non-illuminated push-pull devices.	800T-N210R
	Bul. 800T 63 mm Red Anodized Aluminum Cap with "E-Stop" For use on Bul. 800T non-illuminated push-pull devices.	800T-N210RE
	Bul. 800T 90 mm Gold Anodized Aluminum Cap For use on Bul. 800T non-illuminated push-pull devices.	800T-N211GL
 Cat. No. 800T-N300	Bul. 800T Bonding Bracket The bonding bracket establishes an electrical circuit between the mounting surface and metal operator bushing for grounding purposes; recommended for installations which require CSA approval. Necessary mounting hardware is included. Order Cat. No. 800T-N300 for back-of-panel bracket. Order Cat. No. 800T-N300F for front-of-panel bracket.	800T-N300
		800T-N300F
 Cat. No. 800E-ALR1	Bul. 800T/H Lens/Bulb Removal Tool The small end of this tool provides quick and easy removal of any incandescent or LED lamp.	800F-ALR1

Miscellaneous, Continued







		Description	Cat. No.	
 Cat. No. 800T-N324 Cat. No. 800T-N323 IEC Finger-Safe Accessories	Cat. No. 800T-N323 Cat. No. 800T-N322	Bul. 800T/H IEC Finger-Safe Terminal Guards Snap-on accessories which provide IEC, IP2X and VGB finger-safe protection. Single terminal guards for single circuit contact blocks, full voltage modules, LED modules, etc. (800T-XD1, -XD2, -XD3, -XD4, -XD5, -XD6, -XAP, -XD1P, -XD2P, -PC..., and -QC...)* Note: Must be ordered in multiples of 100 pieces.	800T-N322	
	Transformer covers for transformer only. Note: Must be ordered in multiples of 25 pieces.	800T-N324		
	Multi-terminal side cover for use on single or double circuit contact blocks. (800T-XA, -XA1, -XA2, -XA4, -XA7, -XAR, -XA2R, -XA4R, -XD1R, and -XD2R) Note: Must be ordered in multiples of 25 pieces.	800T-N323		
 Cat. No. 800T-N292		Grey Bul. 800T Trim Washer Used to mount the operator properly when a legend plate is not being used. Note: Must be ordered in multiples of 10 pieces.	800T-N292	
		Plastic Bul. 800H Trim Washer Used to mount the operator properly when a legend plate is not being used. Note: Must be ordered in multiples of 10 pieces.	800H-N148	
 Cat. No. 800T-N293		Metal Bul. 800T Thrust Washer Used to prevent rotation of operators in a keyed or notched hole. Note: Must be ordered in multiples of 10 pieces.	800T-N293	
		Plastic Bul. 800H Thrust Washer Used to prevent rotation of operators in a keyed or notched hole. Note: Must be ordered in multiples of 10 pieces.	800H-N146	
 Cat. No. 800T-N188		Bul. 800T Etching Fluid Used to blacken freshly engraved aluminum legend plates.	800T-N188	
		Description	Color	Cat. No.
 Cat. No. 800T-N1		Bul. 800T/H Closing Button Where an enclosure or flush plate with more than the required number of openings is used, this neat-appearing button can be supplied to close the unused openings.	Grey	800T-N1
			Black	800T-N1B

* Power modules excluding transformers and dual inputs

Locking Attachments









	Description	Cat. No.
 Cat. No. 800T-N2 (Padlock not included)	Bul. 800T Extended Head Push Button Padlocking Attachments Permits locking in the depressed position. Locks the normally closed contact in the open position. For extended head non-illuminated momentary push buttons.	800T-N2
 Cat. No. 800T-N10 (Padlock not included)	Bul. 800T Flush Head Push Button Padlocking Attachments Permits locking in the depressed position. Locks the normally closed contact in the open position. For flush head push button.	800T-N10
 Cat. No. 800T-N315 (Padlock not included)	Bul. 800T Momentary Mushroom Padlocking Attachments For Bul. 800T non-illuminated momentary mushroom push button. Requires use of Cat. No. 800T-N311 mushroom cap. This device is used to lock the mushroom button in a depressed position.	800T-N315
 Cat. No. 800T-N314 (Padlock not included)	Bul. 800T/H Push-Pull Padlocking Attachment For 2-position push-pull and push-pull/twist release illuminated and non-illuminated operators. Use on standard head only (40 mm dia.). Locks the normally closed contacts open only. Conversion of normally closed late break contacts to standard normally closed contacts are recommended when using this accessory. Made of stainless steel.	800T-N314
 Cat. No. 800T-N163 (Padlock not included)	Bul. 800T/H Padlocking Cover Guards against unauthorized operation for non-illuminated, standard knob selector switches and potentiometers. Stainless steel and clear plastic construction.	800T-N163
	Bul. 800T/H Trigger Action Padlocking Attachment For 2-position trigger action E-stops with 45 mm heads.	800T-N378

Locking Attachments, Continued

	Description		Cat. No.																										
 Cat. No. 800H-N140 (Padlock not included)	Bul. 800T/H Padlocking Cover Guards against unauthorized operation. For non-illuminated push buttons, 2-position push-pull or twist-release units, and standard knob selector switches. When applying Cat. No. 800H-N140 on 2-position maintained push-pull units, cover will lock only when the button is in depressed position. Padlocking cover includes blank legend plate for customer marking. Note: A pre-marked legend plate is available. The words OPEN COVER TO OPERATE are on the front and PULL-TO-START-PUSH-TO-STOP are on the rear. To order legend plate only, specify Cat. No. 800H-W174L.		800H-N140																										
 Cat. No. 800T-NX446 (Padlock not included)	Bul. 800T 2- and 3-Position Non-illuminated Selector Switch Padlocking Attachment — Standard Knob Padlocking guard for 2- and 3-position selector switches with standard knob operators only. Locks selector switch in any maintained position.*		800T-NX446																										
 Cat. No. 800H-N141R (Padlock not included)	<table border="1"> <thead> <tr> <th data-bbox="532 701 1065 730">Description</th> <th data-bbox="1065 701 1333 730">Position</th> <th data-bbox="1333 701 1481 730">Cat. No.</th> </tr> </thead> <tbody> <tr> <td data-bbox="532 730 1065 787" rowspan="4"> Bul. 800H 2- and 3-Position Selector Switch with Padlocking Guards Padlocking guard for 2- and 3-position selector switches with standard knob operators only. </td> <td data-bbox="1065 730 1333 760">Left</td> <td data-bbox="1333 730 1481 760">800H-N141L</td> </tr> <tr> <td data-bbox="1065 760 1333 787">Center</td> <td data-bbox="1333 760 1481 787">800H-N141C</td> </tr> <tr> <td data-bbox="1065 787 1333 903">Right</td> <td data-bbox="1333 787 1481 903">800H-N141R</td> </tr> <tr> <td data-bbox="1065 903 1333 947">All</td> <td data-bbox="1333 903 1481 947">800H-N141A</td> </tr> </tbody> </table>	Description	Position	Cat. No.	Bul. 800H 2- and 3-Position Selector Switch with Padlocking Guards Padlocking guard for 2- and 3-position selector switches with standard knob operators only.	Left	800H-N141L	Center	800H-N141C	Right	800H-N141R	All	800H-N141A																
Description	Position	Cat. No.																											
Bul. 800H 2- and 3-Position Selector Switch with Padlocking Guards Padlocking guard for 2- and 3-position selector switches with standard knob operators only.	Left	800H-N141L																											
	Center	800H-N141C																											
	Right	800H-N141R																											
	All	800H-N141A																											
 Cat. No. 800T-NX446A (Padlock not included)	Bul. 800T 4-Position Selector Switch Attachment — Standard Knob Kit includes selector switch and guard (padlock not included). Padlocking guard for 4-position selector switches with standard knob operators only. Locks selector switch in any maintained position.*		800T-NX446A																										
 Cat. No. 800H-N316J (Padlock not included)	<table border="1"> <thead> <tr> <th data-bbox="532 1173 1065 1203">Description</th> <th data-bbox="1065 1173 1333 1203">Position</th> <th data-bbox="1333 1173 1481 1203">Cat. No.</th> </tr> </thead> <tbody> <tr> <td data-bbox="532 1203 1065 1570" rowspan="12"> Bul. 800T/H Non-Illuminated Selector Switch Padlocking Attachment 2-, 3-, and 4-position selector switch padlocking attachments. Can be used to lock operators in a desired position. For 3-position selector switches, this device can also be used to lock out a left or right position as shown in the photo to the left. </td> <td colspan="2" data-bbox="1065 1203 1333 1232">For 2- and 3-Position Selector Switches</td> </tr> <tr> <td data-bbox="1065 1232 1333 1262">Left</td> <td data-bbox="1333 1232 1481 1262">800T-N316L</td> </tr> <tr> <td data-bbox="1065 1262 1333 1291">Center</td> <td data-bbox="1333 1262 1481 1291">800T-N316C</td> </tr> <tr> <td data-bbox="1065 1291 1333 1320">Right</td> <td data-bbox="1333 1291 1481 1320">800T-N316R</td> </tr> <tr> <td data-bbox="1065 1320 1333 1350">Window Center through Right - Prevent Left Operation</td> <td data-bbox="1333 1320 1481 1350">800T-N316J</td> </tr> <tr> <td data-bbox="1065 1350 1333 1379">Window Center through Left - Prevent Right Operation</td> <td data-bbox="1333 1350 1481 1379">800T-N316K</td> </tr> <tr> <td colspan="2" data-bbox="1065 1379 1333 1409">For 4-Position Selector Switches</td> </tr> <tr> <td data-bbox="1065 1409 1333 1438">Left (Pos. 1)</td> <td data-bbox="1333 1409 1481 1438">800T-N317L</td> </tr> <tr> <td data-bbox="1065 1438 1333 1467">Center Left (Pos. 2)</td> <td data-bbox="1333 1438 1481 1467">800T-N317CL</td> </tr> <tr> <td data-bbox="1065 1467 1333 1497">Center Right (Pos. 3)</td> <td data-bbox="1333 1467 1481 1497">800T-N317CR</td> </tr> <tr> <td data-bbox="1065 1497 1333 1526">Right (Pos. 4)</td> <td data-bbox="1333 1497 1481 1526">800T-N317R</td> </tr> </tbody> </table>	Description	Position	Cat. No.	Bul. 800T/H Non-Illuminated Selector Switch Padlocking Attachment 2-, 3-, and 4-position selector switch padlocking attachments. Can be used to lock operators in a desired position. For 3-position selector switches, this device can also be used to lock out a left or right position as shown in the photo to the left.	For 2- and 3-Position Selector Switches		Left	800T-N316L	Center	800T-N316C	Right	800T-N316R	Window Center through Right - Prevent Left Operation	800T-N316J	Window Center through Left - Prevent Right Operation	800T-N316K	For 4-Position Selector Switches		Left (Pos. 1)	800T-N317L	Center Left (Pos. 2)	800T-N317CL	Center Right (Pos. 3)	800T-N317CR	Right (Pos. 4)	800T-N317R		
Description	Position	Cat. No.																											
Bul. 800T/H Non-Illuminated Selector Switch Padlocking Attachment 2-, 3-, and 4-position selector switch padlocking attachments. Can be used to lock operators in a desired position. For 3-position selector switches, this device can also be used to lock out a left or right position as shown in the photo to the left.	For 2- and 3-Position Selector Switches																												
	Left	800T-N316L																											
	Center	800T-N316C																											
	Right	800T-N316R																											
	Window Center through Right - Prevent Left Operation	800T-N316J																											
	Window Center through Left - Prevent Right Operation	800T-N316K																											
	For 4-Position Selector Switches																												
	Left (Pos. 1)	800T-N317L																											
	Center Left (Pos. 2)	800T-N317CL																											
	Center Right (Pos. 3)	800T-N317CR																											
	Right (Pos. 4)	800T-N317R																											
	 Cat. No. 800H-N4162L (Padlock not included)	<table border="1"> <thead> <tr> <th data-bbox="532 1570 1333 1600">Description</th> <th data-bbox="1065 1570 1333 1600">Position</th> <th data-bbox="1333 1570 1481 1600">Cat. No.</th> </tr> </thead> <tbody> <tr> <td data-bbox="532 1600 1333 1875" rowspan="10"> Bul. 800T/H Illuminated Selector Switch Padlocking Attachment 2- and 3-position selector switch padlocking attachments for illuminated selector switches. Stainless steel material </td> <td colspan="2" data-bbox="1065 1600 1333 1629">For 2-Position Selector Switches</td> </tr> <tr> <td data-bbox="1065 1629 1333 1659">Left</td> <td data-bbox="1333 1629 1481 1659">800T-N4162L</td> </tr> <tr> <td data-bbox="1065 1659 1333 1688">Right</td> <td data-bbox="1333 1659 1481 1688">800T-N4162R</td> </tr> <tr> <td colspan="2" data-bbox="1065 1688 1333 1717">For 3-Position Selector Switches</td> </tr> <tr> <td data-bbox="1065 1717 1333 1747">Left</td> <td data-bbox="1333 1717 1481 1747">800T-N4163L</td> </tr> <tr> <td data-bbox="1065 1747 1333 1776">Center</td> <td data-bbox="1333 1747 1481 1776">800T-N4163C</td> </tr> <tr> <td data-bbox="1065 1776 1333 1806">Right</td> <td data-bbox="1333 1776 1481 1806">800T-N4163R</td> </tr> <tr> <td data-bbox="1065 1806 1333 1835">Window Center through Right - Prevent Left Operation</td> <td data-bbox="1333 1806 1481 1835">800T-N4163J</td> </tr> <tr> <td data-bbox="1065 1835 1333 1864">Window Center through Left - Prevent Right Operation</td> <td data-bbox="1333 1835 1481 1864">800T-N4163K</td> </tr> </tbody> </table>		Description	Position	Cat. No.	Bul. 800T/H Illuminated Selector Switch Padlocking Attachment 2- and 3-position selector switch padlocking attachments for illuminated selector switches. Stainless steel material	For 2-Position Selector Switches		Left	800T-N4162L	Right	800T-N4162R	For 3-Position Selector Switches		Left	800T-N4163L	Center	800T-N4163C	Right	800T-N4163R	Window Center through Right - Prevent Left Operation	800T-N4163J	Window Center through Left - Prevent Right Operation	800T-N4163K				
Description	Position	Cat. No.																											
Bul. 800T/H Illuminated Selector Switch Padlocking Attachment 2- and 3-position selector switch padlocking attachments for illuminated selector switches. Stainless steel material	For 2-Position Selector Switches																												
	Left	800T-N4162L																											
	Right	800T-N4162R																											
	For 3-Position Selector Switches																												
	Left	800T-N4163L																											
	Center	800T-N4163C																											
	Right	800T-N4163R																											
	Window Center through Right - Prevent Left Operation	800T-N4163J																											
	Window Center through Left - Prevent Right Operation	800T-N4163K																											



* Diameter of hasp is 11/32 in. (8.73 mm)

Guards

	Description	Type	Cat. No.
 Cat. No. 800T-N13	Bul. 800T Push Button Guards Momentary push button guards to reduce the risk of accidental operation.	1 in. guard for non-illuminated	800T-N13
		1/2 in. guard for non-illuminated	800T-N143
		1-1/2 in. guard for illuminated	800T-N93
		1-1/2 in. guard for non-illuminated with locking attachment	800T-N39
 Cat. No. 800H-N152	Bul. 800H Illuminated Push Button Guard This guard provides additional protection against accidental operation of the push button unit. 1-1/2 in. (38.1 mm) guard for illumination units.		800H-N152
 Cat. No. 800T-N226	Bul. 800T 18 mm Guard Provides side protection for 18 mm pilot lights.		800T-N226
 Cat. No. 800H-N153	Bul. 800H Stainless Steel Guard Used on non-illuminated push buttons that have protective boots as shown on page 10-39.		800H-N153
 Cat. No. 800T-N129	Bul. 800T Mushroom Push Button Guards Momentary mushroom guards for standard and jumbo mushroom push buttons. Reduces the risk of accidental operation.	Standard guard	800T-N129
		Standard guard with set screw	800T-N165
		Jumbo guard	800T-N151
		Jumbo guard with set screw	800T-N154
 Cat. Nos. 800T-N310 and 800T-NX1320	Bul. 800T/H Protective Guard Protective ring for Bul. 800T 2-position push-pull operators. Illuminated or non-illuminated. Often used to avoid unintentional tripping of E-stop operators. This guard is used with standard size button (40 mm dia.).	Stainless steel	800T-N310
		Black	800T-NX1320
 Cat. No. 800T-N310J	Bul. 800T/H Jumbo Protective Guard Protective ring for Bul. 800T 2-position push-pull operators. Illuminated or non-illuminated. Often used to avoid unintentional tripping of E-stop operators.	60 mm (Jumbo)	800T-N310J
		63 mm	800T-N310L
Cat. No. 800T-N381	Bul. 800T/H Protective Guard Protective ring for Bul. 800T trigger action E-stop operators.	45 mm	800T-N381
 Cat. No. 800T-N339		Bul. 800T/H Ramp Guard For Bul. 800T/800H 2- and 3-position illuminated and non-illuminated push-pull units. Standard size button only (40 mm dia.).	60/63 mm

Replacement Lamps

Pilot Lights, Illuminated Push Buttons, Illuminated Push-Pull, Illuminated Push-Pull/Twist to Release, and Illuminated Selector Switches

Lamp	Type	Current, Typical	Lamp Voltage	ANSI No.	Catalog Voltage Code	Cat. No.
	Full Voltage Transformer	150 mA/250 mA	6.3V AC	755/1866	6, 16, 26, 36, 46, 56, 76	* 800T-N65
	Full Voltage	80 mA	14V AC/DC	756	12	* 800T-N141
		70 mA	24V AC/DC	757	24	* 800T-N157
		50 mA	48V AC/DC	1835	48	* 800T-N365
	Full Voltage Resistor	22 mA	120V AC/DC	949	10, 11	* 800T-N169
	Flashing	150 mA	6V AC/DC	267	6	* 800T-N212
		57 mA	24V AC/DC	24 MB	24	* 800T-N180
Dual Input Diode	21 mA	120V AC	90 MB	16	* 800T-N261	
Neon 	—	2 mA	120V AC/DC	B2A	10, 20	609-N9
Lamp	Type	Current, Typical*	Lamp Voltage	Leakage Current	Code	Cat. No.*
	Universal	13 mA @ 24V DC 8.5 mA @ 120V AC†	3V‡	3 mA	2	800T-N376x
	Transformer	60	6V	14 mA	16, 26, 46, 56	800T-N377x



- * Item is sold in multiples of 5. Order quantity of 5 to receive package of 5 pieces.
- * To complete the cat. no. replace the **x** with the first letter of the desired color: **Green**, **Red**, or **White**.
- † Typical current consumption values indicated are relative to the input of the power module.
- ‡ Lamp is intended for use with power module Cat. No. 800TC-N374 which has an input voltage rating of 12 ...130V AC/DC.

Legacy LED Lamps*

Lamp	Type	Current, Typical>	Lamp Voltage	Leakage Current	Catalog Voltage Code	Cat. No.*
	Full Voltage	13 mA/22 mA	12V AC/DC	3 mA	12	800T-N362x
		20 mA/21 mA	24V AC/DC	3 mA	24	800T-N319x
		12 mA/17 mA	32V AC/DC	3 mA	32	800T-N363x
		9 mA/14 mA	48V AC/DC	3 mA	48	800T-N364x
		3.3 mA/6 mA	120V AC	—	10	800T-N320x
		4.5 mA/6.2 mA	130V AC/DC	3 mA	13	800T-N321x
	Transformer	50 mA	6V AC	14 mA	6, 16, 26, 36, 46, 56, 76	800T-N318x
Flashing	18 mA	24V AC/DC	—	N/A	+ 800T-N319Fx	

- * In full voltage applications, these lamps are intended to be used with power module Cat. No. 800T-N330.
- ❖ All LEDs except 120V have an internal shunt resistor for use with solid-state outputs. LEDs will not illuminate below listed leakage current.
- > Typical current draw varies with LED color. The first mA value is for a green or blue LED and the second mA value is for a red or amber LED.
- * To complete the cat. no. replace the **x** with the first letter of the desired color: **Amber**, **Green**, **Red**, **Blue**, or **White**. White LEDs only available in 6V, 24V, 120V, and 130V.
- + Flashing rate is 2 Hz.

Cluster Pilot Lights

Lamp	Type	Current, Typical	Lamp Voltage	ANSI No.	Cat. No.*
	Full Voltage Transformer	195 mA	6V AC/DC	381	800T-N258
	Full Voltage	73 mA	12V AC/DC	382	800T-N259
		37 mA	24V AC/DC	387	800T-N260
Lamp	Type	Current, Typical	Lamp Voltage	Polarity	Cat. No.*
	Full Voltage Transformer	45 mA	6V AC/DC	Positive	800T-N340x
	Full Voltage	36 mA	12V AC/DC	Positive	800T-N341x
		14 mA	28V AC/DC	Bi-Polar	11 800T-N80x

- * Item is sold in multiples of 5. Order quantity of 5 to receive package of 5 pieces.
- * To complete the cat. no., replace the **x** with the first letter of the desired color: **Amber**, **Green**, or **Red** only.
- 11 For use with 24V AC/DC rated devices.

Replacement Keys for Cylinder Lock 2-, 3-, and 4-Position Selector Switches (800T only)

Cylinder Lock Key Option Code	Series Key Number	Cat. No.	Cylinder Lock Key Option Code	Series Key Number	Cat. No.
Blank (standard key)	D018 (standard key)	X-181170	15	T112*	40269-087-01
03	D020*	X-307922	16	T115*	40269-087-02
04	D025*	X-307923	17	T324*	40269-087-03
05	D335*	X-307924	18	T382*	40269-087-04
06	D429*	X-307925	19	T404*	40269-087-05
07	D461*	X-307926	20	T171*	40269-087-06
08	D111*	X-307927	21	T484*	40269-087-07
09	D587*	X-307928	22	T547*	40269-087-08
10	D682*	X-307929	23	T569*	40269-087-09
11	D713*	X-307930	24	T692*	40269-087-10
12	D900*	X-307931	25	T752*	40269-087-11
13	D992*	X-307932	26	T178*	40269-087-12
14	D118*	X-307933			

* Uses master key DM81, AB Cat. No. X-433358.

* Uses master key 15T, AB Cat. No. X-433359.

Replacement Keys for Push Button Switches with Cylinder Locks (800T only)

Lock Key Option Code			Series Key Number	Cat. No.
Spring Bolt	Dead Bolt A	Dead Bolt B		
Blank (standard key)	Blank (standard key)	Blank (standard key)	E158 (standard key)	X-144218
44	32	20	E109	X-386233
45	33	21	E131	X-386234
46	34	22	E100	X-386235
47	35	23	E115	X-386236
48	36	24	E120	X-386237
49	37	25	E104	X-386238
50	38	26	E108	X-386239
51	39	27	E132	X-386240
52	40	28	E144	X-386241
53	41	29	E157	X-386242
54	42	30	E101	X-386243
55	43	31	E102	40274-250-01
66	61	56	E106	40274-250-07
67	62	57	E111	40274-250-02
68	63	58	E117	40274-250-14
69	64	59	E125	40274-250-21
70	65	60	E130	40274-250-26



Blank and Custom Legend Plates — Aluminum, Type 4/13 (800T)

Blank/Custom Legend Plates



Standard Legend Plate



Jumbo Legend Plate

Legend Plate Color	Standard	Jumbo
	Cat. No.	Cat. No.
Grey	800T-X559	800T-X559J
Red	800T-X621	800T-X621J
Yellow	800T-X679	800T-X679J
Grey (with custom text)	800T-X559E	800T-X559JE
Red (with custom text)	800T-X621E	800T-X621JE
Yellow (with custom text)	800T-X679E	800T-X679JE

Specialty Legend Plates

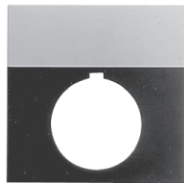

Automotive Legend Plate

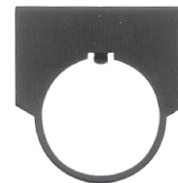

Half Round Legend Plate

Legend Plate Color	Automotive	Half Round*
	Cat. No.	Cat. No.
Grey (blank)	800T-X700	800T-X59
Red (blank)	800T-X701	800T-X121
Grey (with custom text)	800T-X700E	800T-X59E
Red (with custom text)	800T-X701E	800T-X121E

Note: Include text with custom legends.

* All half round legend plates must be ordered in quantities of 25.

Custom Text Guidelines

Legend Size	No. of Lines	Max. No. of Characters per Line
Standard	1 line of	14
	2 lines of	14
Jumbo	5 lines	14
Automotive	4 lines	20

Custom Legend Plates for 4-Way Toggle and Cluster Pilot Lights

Legend Size	Cat. No.‡	Color	Text Options*
Standard	800T-X619E	Aluminum (with custom text)	2 lines of up to 14 characters on top 1 line of up to 14 characters on bottom
			1 vertical line of up to 7 characters on left side 1 vertical line of up to 7 characters on right side
			1 vertical line of up to 9 characters on left side 1 vertical line of up to 9 characters on right side

* Rule sets listed are mutually exclusive; only one can be chosen.

‡ For blank toggle or cluster pilot legend, order Cat. No. 800T-X619.

Blank and Custom Legend Plates — Aluminum, Type 4/13 (800T), Continued
 Specialty Legend Plates



Cat. No. **800T-X618**



Cat. No. **800T-X647Y**



Cat. No. **800T-X646**

Type	Start/Stop Legend Plates		Emergency Stop Legend Plates	
	Grey	Yellow	Yellow (Large Size)	Yellow IEC Ring
	Cat. No.	Cat. No.	Cat. No.	Cat. No.
Push-to-Stop Pull-to-Start or Push-to-Stop Twist or Pull Release	800T-X618	800T-X618Y	800T-X647Y	—
Blank	—	—	800T-X645Y	800T-X646
Custom	—	—	800T-X645YE	—
Emergency Stop	—	—	—	800T-X646EM

Potentiometer Legend Plates



Cat. No. **800T-X609**

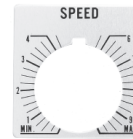

Cat. No. **800T-X608**

Type	Cat. No.
Potentiometer with graduated markings	* 800T-X609
SPEED	800T-X608

* For graduated markings with a custom text, order Cat. No. 800T-X609E and specify up to two lines of text, 14 characters per line.

18 mm Legend Plates



Type A Legend Plate
 Cat. No. **800T-N515**

Description	Cat. No.
Blank	
Type A	800T-N515
Type B	800T-N516
With Custom Marking*	
Type A with Text	800T-N515E
Type B with Text	800T-N516E

* Text must be supplied.

Custom Text Guidelines

Legend Type	Number of Lines	Maximum Number of Characters per Line
A	1	9
B	2	13

Standard Legend Plates – Aluminum, Type 4/13 (Bul. 800T)

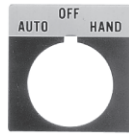

Standard Legend Plate



Jumbo Legend Plate

Marking	Standard	Jumbo	Marking	Standard	Jumbo
	Cat. No.	Cat. No.		Cat. No.	Cat. No.
AUTO-OFF-HAND	800T-X501	800T-X501J	ON-OFF	800T-X622	800T-X622J
AUTO-MAN-OFF	800T-X625	800T-X625J	OPEN	800T-X531	800T-X531J
CLOSE	800T-X502	800T-X502J	OPEN-CLOSE	800T-X532	800T-X532J
CYCLE START	800T-X562	800T-X562J	OPEN-OFF-CLOSE	800T-X533	800T-X533J
DOWN	800T-X503	800T-X503J	OUT	800T-X534	800T-X534J
EMERG. STOP (Yellow)	800T-X504Y	—	POWER ON	800T-X639	800T-X639J
EMERG. STOP (Red)*	800T-X504	800T-X504J	RAISE	800T-X535	800T-X535J
EMERGENCY STOP (Red)*	800T-X648	800T-X648J	RAISE-LOWER	800T-X536	800T-X536J
FAST	800T-X505	800T-X505J	RAISE-OFF-LOWER	800T-X537	800T-X537J
FEED START	800T-X566	800T-X566J	RESET	800T-X538	800T-X538J
FEED STOP	800T-X567	800T-X567J	REVERSE	800T-X539	800T-X539J
FOR.-REV.	800T-X506	800T-X506J	RUN	800T-X540	800T-X540J
FOR.-OFF-REV.	800T-X507	800T-X507J	RUN-INCH	800T-X634	800T-X634J
FORWARD	800T-X508	800T-X508J	RUN-JOG	800T-X541	800T-X541
FOURTH SPEED	800T-X624	800T-X624J	SAFE-RUN	800T-X542	800T-X542J
FULL SPEED	800T-X509	800T-X509J	SECOND SPEED	800T-X543	800T-X543J
HAND-AUTO	800T-X510	800T-X510J	SPEED*	800T-X608	—
HAND-OFF-AUTO	800T-X511	800T-X511J	SLOW	800T-X544	800T-X544J
HIGH	800T-X512	800T-X512J	SLOW-FAST	800T-X545	800T-X545J
HIGH-LOW	800T-X513	800T-X513J	SLOW-OFF-FAST	800T-X546	800T-X546J
HIGH-OFF-LOW	800T-X514	800T-X514J	START	800T-X547	800T-X547J
IN	800T-X515	800T-X515J	START-JOG	800T-X548	800T-X548J
INCH	800T-X516	800T-X516J	START-STOP	800T-X549	800T-X549J
JOG	800T-X517	800T-X517J	STOP (Red)	800T-X550	800T-X550J
JOG FORWARD	800T-X518	800T-X518J	STOP-START	800T-X551	800T-X551J
JOG REVERSE	800T-X519	800T-X519J	SUMMER-OFF-WINTER	800T-X553	800T-X553J
JOG RUN	800T-X520	800T-X520J	SUMMER-WINTER	800T-X552	800T-X552J
JOG-SAFE-RUN	800T-X522	800T-X522J	TEST	800T-X554	800T-X554J
JOG-STOP-RUN	800T-X521	800T-X521J	THIRD SPEED	800T-X555	800T-X555J
LEFT-RIGHT	800T-X523	800T-X523J	UP	800T-X556	800T-X556J
LOCAL-REMOTE	800T-X638	800T-X638J	UP-DOWN	800T-X557	800T-X557J
LOW	800T-X524	800T-X524J	UP-OFF-DOWN	800T-X558	800T-X558J
LOW SPEED	800T-X525	800T-X525J	O (Red)	800T-X640	800T-X640J
LOWER	800T-X526	800T-X526J	I	800T-X641	800T-X641J
OFF	800T-X527	800T-X527J	O I	800T-X642	800T-X642J
OFF-COOLANT-ON	800T-X528	800T-X528J	I O II	800T-X643	800T-X643J
OFF-ON	800T-X529	800T-X529J	—	—	—
ON	800T-X530	800T-X530J	—	—	—

* These legend plates do not comply with E-Stop standards that specify a yellow background, such as IEC 60947-5-5 and NFPA 79.

* Potentiometer type with graduated markings.

Legend Plates – Plastic, Type 4/4X/13 (800H)



Standard Legend Plate
 Cat. No. 800H-W100



Jumbo Legend Plate
 Cat. No. 800H-W100J

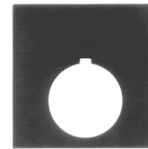

Automotive Legend Plate
 Cat. No. 800H-W100A

Blank/Custom Legend Plates Type 4/4X

Legend Plate Color	Standard	Jumbo	Automotive
	Cat. No.	Cat. No.	Cat. No.
Grey (Blank)	800H-W100	800H-W100J	800H-W100A
Red (Blank)	800H-W300	800H-W300J	800H-W300A
White (Blank)	800H-W500	800H-W500J	800H-W500A
Yellow (Blank)	800H-W700	800H-W700J	800H-W700A
Grey (with Custom Text)	800H-W100E	800H-W100JE	800H-W100AE
Red (with Custom Text)	800H-W300E	800H-W300JE	800H-W300AE
White (with Custom Text)	800H-W500E	800H-W500JE	800H-W500AE
Yellow (with Custom Text)	800H-W700E	800H-W700JE	800H-W700AE

Note: Include text with custom legends.

Custom Text Guidelines

Legend Size	Number of Lines	Maximum Number of Characters per Line
Standard	1 Line of	13
	2 Lines of	13
Jumbo	5 Lines	13
Automotive	4 Lines	16



Potentiometer Legend Plate
 Cat. No. 800H-W080

Potentiometer Legends

Legend Marking	Cat. No.
Graduated Markings Only	800H-W080
SPEED	800H-W081
Custom Legend with Graduated Marking	800H-W080E



Cat. No. **800H-W196**



Cat. No. **800H-W797A**



Cat. No. **800H-W690**

Type	Start/Stop Legend Plates	Emergency Stop Legend Plates	
	Grey Cat. No.	Yellow (Large Size) Cat. No.	Yellow IEC Ring Cat. No.
Push-to-Stop Pull-to-Start	800H-W196	800H-W797A	—
Blank	—	800H-W700A	800H-W690
Custom	800H-W100E	800H-W700AE	—

Standard Legend Plates – Plastic, Type 4/4X/13 (800H)

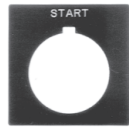

Grey Legend Plate
Type 4/4X

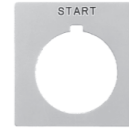

White Legend Plate
Type 4/4X

Marking	Grey Type 4/4X	White Type 4/4X	Marking	Grey Type 4/4X	White Type 4/4X
	Cat. No.	Cat. No.		Cat. No.	Cat. No.
AUTO OFF HAND	800H-W154	800H-W554	LOWER	800H-W115	800H-W515
AUTO MAN OFF	800H-W059	800H-W459	MAN AUTO	800H-W031	800H-W431
CLOSE	800H-W101	800H-W501	MAN OFF AUTO	800H-W062	800H-W462
CYCLE START	800H-W006	800H-W406	MOTOR RUN	800H-W008	800H-W408
CYCLE STOP (Red)	800H-W376	—	MOTOR STOP (Red)	800H-W375	—
DECREASE	800H-W002	800H-W402	OFF	800H-W116	800H-W516
DOWN	800H-W102	800H-W502	OFF COOLANT ON	800H-W052	800H-W452
EMERG. STOP (Red)*	800H-W372	—	OFF LOC REMOTE	800H-W061	—
EMERGENCY STOP (Red)*	800H-W373	—	OFF MAN AUTO	800H-W060	800H-W460
FAST	800H-W104	800H-W504	OFF ON	800H-W133	800H-W533
FEED START	800H-W007	—	ON	800H-W117	800H-W517
FEED STOP (Red)	800H-W377	—	OPEN	800H-W118	800H-W518
FOR. REV.	800H-W132	800H-W532	OPEN CLOSE	800H-W134	800H-W534
FOR. OFF REV.	800H-W152	800H-W552	OPEN OFF CLOSE	800H-W153	800H-W553
FORWARD	800H-W105	800H-W505	OUT	800H-W119	800H-W519
FOURTH SPEED	800H-W010	—	POWER ON	800H-W001	800H-W401
FULL SPEED	800H-W106	800H-W506	PULL-TO-START	800H-W198	—
HAND AUTO	800H-W131	800H-W531	PUSH-TO-STOP (Red)	800H-W378	—
HAND OFF AUTO	800H-W151	800H-W551	RAISE	800H-W120	800H-W520
HIGH	800H-W107	800H-W507	RAISE LOWER	800H-W034	—
HIGH LOW	800H-W030	—	RAISE OFF LOWER	800H-W156	800H-W556
HIGH LOW OFF	800H-W058	—	RESET	800H-W121	800H-W521
HIGH OFF LOW	800H-W155	800H-W555	REVERSE	800H-W122	800H-W522
IN	800H-W108	800H-W508	RIGHT	800H-W005	800H-W405
INCH	800H-W109	800H-W509	RUN	800H-W123	800H-W523
INCREASE	800H-W003	—	RUN INCH	800H-W037	—
JOG	800H-W110	800H-W510	RUN JOG	800H-W032	—
JOG FORWARD	800H-W111	800H-W511	SAFE RUN	800H-W033	—
JOG REVERSE	800H-W112	800H-W512	SECOND SPEED	800H-W124	800H-W524
JOG RUN	800H-W135	800H-W535	SLOW	800H-W125	800H-W525
JOG SAFE RUN	800H-W051	—	SLOW FAST	800H-W136	800H-W536
JOG STOP RUN	800H-W057	—	SLOW OFF FAST	800H-W157	800H-W557
LEFT	800H-W004	800H-W404	SPEED*	800H-W081	800H-W481
LEFT RIGHT	800H-W036	—	SPEED*	800H-W182	—
LOC OFF REMOTE	800H-W055	800H-W455	START	800H-W126	800H-W526
LOW	800H-W113	800H-W513	START JOG	800H-W138	800H-W538
LOW HIGH	800H-W035	—	START JOG STOP	800H-W158	800H-W558
LOW OFF HIGH	800H-W056	—	START RUN STOP	800H-W054	—
LOW SPEED	800H-W114	800H-W514	START STOP	800H-W137	800H-W537

* These legend plates do not comply with E-Stop standards that specify a yellow background, such as IEC 60947-5-5 and NFPA 79.

* Potentiometer type with graduated markings.

Standard Legend Plates – Plastic, Type 4/4X/13 (800H)

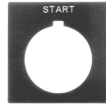

Grey Legend Plate
Type 4/4X

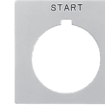

White Legend Plate
Type 4/4X

Marking	Grey Type 4/4X	White Type 4/4X	Marking	Grey Type 4/4X	White Type 4/4X
	Cat. No.	Cat. No.		Cat. No.	Cat. No.
UP	800H-W009	800H-W409	STOP (Red)	800H-W371	—
UP DOWN	800H-W039	—	STOP RUN START	800H-W053	—
UP OFF DOWN	800H-W160	800H-W560	STOP START	800H-W038	800H-W438
O (Red)	800H-W184	—	SUMMER OFF WINTER	800H-W159	800H-W559
O I	800H-W185	800H-W582	SUMMER WINTER	800H-W139	800H-W539
I	800H-W181	800H-W581	TEST	800H-W128	800H-W528
I O II	800H-W183	800H-W583	THIRD SPEED	800H-W129	800H-W529

Flip Lever Legend Plates (for use with Series D operators)

Marking	Grey — Type 4/4X	Marking	Grey — Type 4/4X	Marking	Grey — Type 4/4X
	Cat. No.		Cat. No.		Cat. No.
Blank	800H-W200	LOW	800H-W213	RUN	800H-W223
Customer-Specified*	800H-W200E	BAS	800H-W213F	EN MARCHE	800H-W223F
CLOSE	800H-W201	LOW SPEED	800H-W214	SECOND SPEED	800H-W224
FERMER	800H-W201F	VITESSE MIN	800H-W214F	VITESSE 2	800H-W224F
DOWN	800H-W202	LOWER	800H-W215	SLOW	800H-W225
DESCENDRE	800H-W202F	ABAISSER	800H-W215F	LENT	800H-W225F
FAST	800H-W204	OFF	800H-W216	START	800H-W226
RAPIDE	800H-W204F	ARRÊTER	800H-W216F	MARCHE	800H-W226F
FORWARD	800H-W205	ON	800H-W217	TEST	800H-W228
AVANT	800H-W205F	DÉMARRER	800H-W217F	ESSAI	800H-W228F
FULL SPEED	800H-W206	OPEN	800H-W218	THIRD SPEED	800H-W229
VITESSE MAX	800H-W206F	OUVRIER	800H-W218F	VITESSE 3	800H-W229F
HIGH	800H-W207	OUT	800H-W219	I	800H-W281
HAUT	800H-W207F	SORTIR	800H-W219F	O	800H-W284
IN	800H-W208	RAISE	800H-W220	LEFT	800H-W286
ENTRER	800H-W208F	ÉLEVER	800H-W220F	GAUCHE	800H-W286F
INCH	800H-W209	RESET	800H-W221	RIGHT	800H-W287
POUCE	800H-W209F	RÉARMER	800H-W221F	DROITE	800H-W287F
JOG	800H-W210	REVERSE	800H-W222	UP	800H-W288
À COUPS	800H-W210F	ARRIERE	800H-W222F	EN HAUT	800H-W288F

* 12 characters max.

10

Marking	Red — Type 4/4X
	Cat. No.
Blank	800H-W400
Customer-Specified*	800H-W400E
EMERG. STOP	800H-W472
ARRÊT URGENT	800H-W472F
STOP	800H-W471
ARRET	800H-W471F
O	800H-W484

* 12 characters max.

Approximate Dimensions

Dimensions in inches (millimeters). Dimensions are not intended to be used for manufacturing purposes.

Mounting Instructions for Push Buttons with Shallow Blocks, Mini Blocks, Logic Reed Blocks, Sealed Switch Blocks, and Time Delay Blocks (see footnotes for exceptions)

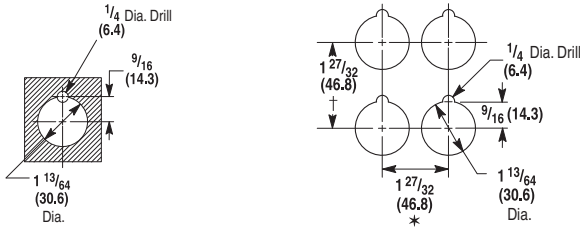

Sketch illustrates the minimum distance between centerlines when mounting Bulletin 800T/H controls either side-by-side, facing each other, or one above the other. When control units are mounted so that the contact block terminals face each other, the 2-1/4 in. (57.2 mm) dimension must be used in order to get proper electrical clearance. When control units are mounted so that the contact block terminals do not face each other, the 1-27/32 in. (46.8 mm) dimension can be used.

Typical Panel Cut-Out

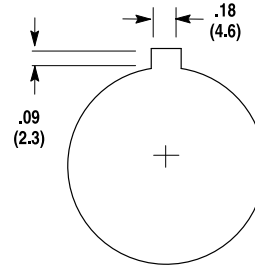

- * Change to 2-1/4 in. (57.2 mm) for transformer type pilot light, push-to-test pilot lights, illuminated selector switches, and all push-pull buttons.
Note: Large legend plate requires minimum horizontal spacing of 2-15/32 in. (62.7 mm).
- ⊛ Vertical minimum spacing dimension changes for the following legend plates: jumbo 2-15/32 in. (62.7 mm); large 2-7/16 in. (61.9 mm); cluster pilot light and 2-, 3-, 4-way switches 2-1/16 in. (52.4 mm).

Panel Thickness — Kits are shipped with three 1/16 in. (1.58 mm) gaskets. Refer to table below for number of washers required for various panel thicknesses.

	1/16 in. (1.6 mm) (16 Gauge)	7/64 in. (2.8 mm) (12 Gauge) 9/64 in. (3.6 mm) (10 Gauge)	3/16 in. (4.8 mm) Panel	Thicker Than 3/16 in. (4.8 mm) Panel	Thicker Than 1/4 in. (6.4 mm) Panel
800T	3 washers	2 washers	1 washer	Counterbore to 3/16 in. (4.8 mm)	Counterbore to 3/16 in. (4.8 mm)
800H	4 washers	3 washers	2 washers	1 washer	Counterbore to 1/4 in. (6.4 mm)

Mounting Instructions for 18 mm Small Pilot Lights

Type A Legend Plate

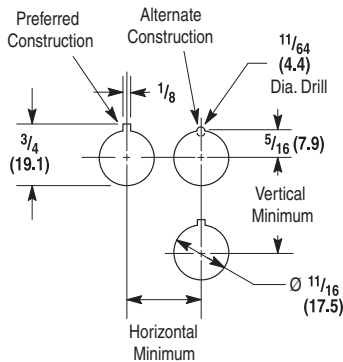

Cat. No. 800T-N515

Type B Legend Plate

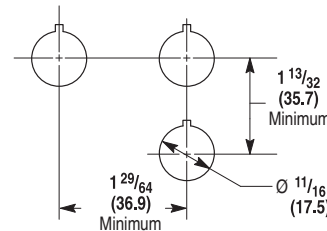

Device	Dimensions	
	Horizontal	Vertical
800T-PS, PSD, PST, QS, QST and RST	31/32 (24.6)	1-5/32 (29.4)
800T-PSDT	1-3/64 (26.6)	1-15/64 (31.4)

30.5 mm Push Buttons

Approximate Dimensions

Dimensions in inches (millimeters). Dimensions are not intended to be used for manufacturing purposes.

Legend Plate Dimensions (Bul. 800T Only)

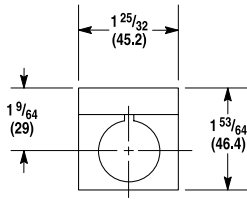

Standard Legend Plate

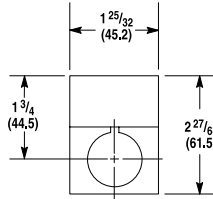

Jumbo Legend Plate

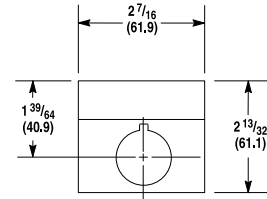

Large Legend Plate
(Automotive Industry Type)

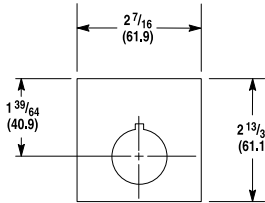

Large Size
Push-Pull/Twist Legend Plate
Cat. No. 800T-X647*

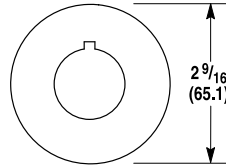

Round
Cat. No. 800T-X646*

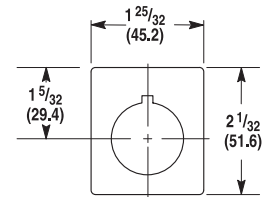

Cluster Pilot Light and
2-3-4 Way Switch
Silver Legend Plate
Cat. No. 800T-X619

* For panel mounting only. Not for use with Allen-Bradley enclosures.

Legend Plate Dimensions (Bul. 800H Only)

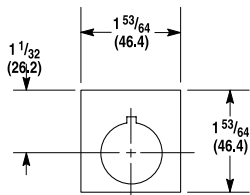

Type 4/4X
Standard Legend Plate

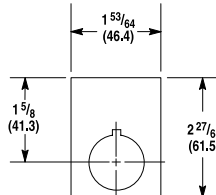

Type 4/4X
Jumbo Legend Plate

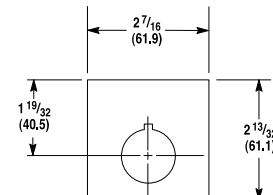

Type 4/4X
Large Legend Plate
(Automotive Industry Type)

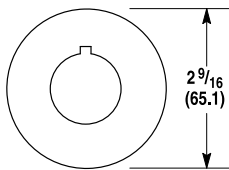

Type 4/4X
Round

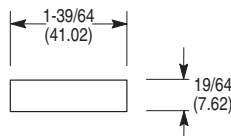

Type 4/4X
Standard Legend Plate
(Flip Lever Operators)

Legend Plate Dimensions (Bul. 800T 18 mm Pilot Lights Only)

Legend Plate for Small Pilot Light Type A Legend

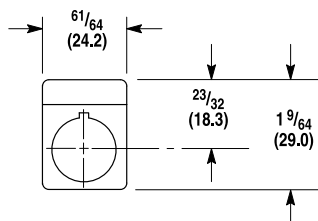

Cat. No. 800T-N515

Legend Plate for Small Pilot Light Type B Legend

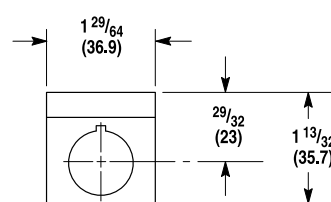

Cat. No. 800T-N516
(Automotive Industry Type)

Dimensions in inches (millimeters). Dimensions are not intended to be used for manufacturing purposes.

Blocks (Bul. 800T Only)

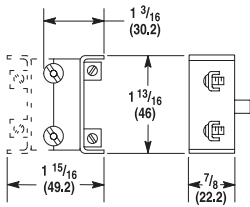

Mini Contact Block
 7/8 (22.2) Deep

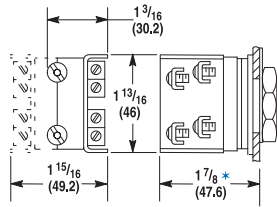

**Shallow, PenTUFF,
 and Logic Reed Contact Blocks**
 1-1/8 (28.6) Deep

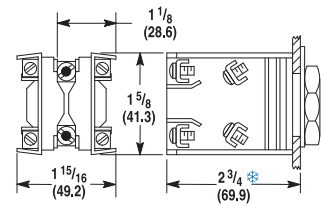

Sealed Switch Block
 2 (50.8) Deep

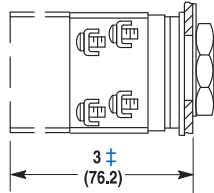

Tandem Mounting
 (2 shallow contact
 blocks stacked)

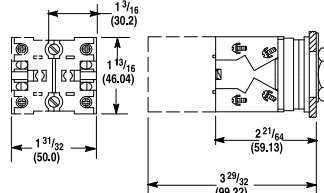

Stackable Sealed Switch Block
 1.58 (40.1) Deep

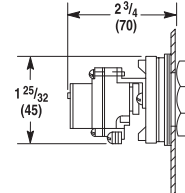

Time Delay Contact Block
 (For Push Buttons Only)

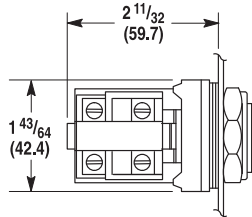
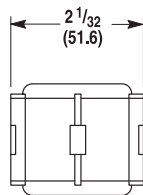

Snap Action Contact Block (For Push Button Only)

- * Dimension shown is for push buttons. Selector switch dimension is 2-1/32 in. (51.6 mm).
- ⊛ Dimension shown is for push buttons. Selector switch dimension is 2-27/32 in. (72.2 mm).
- ‡ Dimension shown is for push buttons. Selector switch dimension is 3-5/32 in. (80.2 mm).

Blocks (Bul. 800H Only)

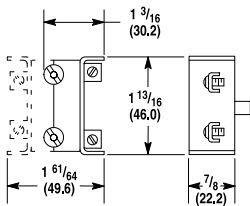

Mini Contact Block

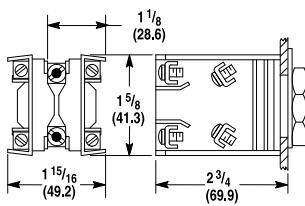

Sealed Switch Block
 2 (50.8) Deep

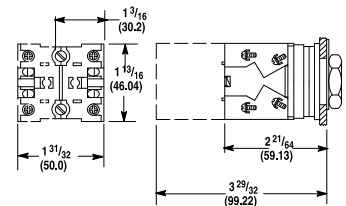

Stackable Sealed Switch Block
 1.58 (40.1) Deep

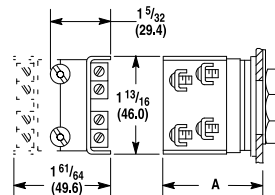

**Shallow, PenTUFF and Logic
 Reed Contact Blocks**

Dim.	Momentary Push Button	Maintained Push Button	Selector Switch
A	2 (50.8)	2 (50.8)	1-29/32 (48.4)

Operator Extension Behind Panel — When mounted with thrust washer, trim washer, or notched legend plate and correct number of rubber washers.

30.5 mm Push Buttons

Approximate Dimensions

Dimensions in inches (millimeters). Dimensions are not intended to be used for manufacturing purposes.

Push Buttons and Switches (Bul. 800T Only)

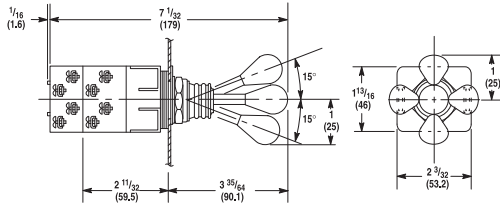

2-3-4 Way Switch
Shipping Wt. with 2 Contact Blocks 6 oz (0.17 kg)
Shipping Wt. with 4 Contact Blocks 8-1/2 oz (0.24 kg)

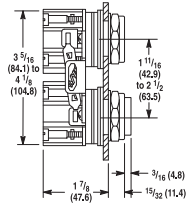

Mechanically Interlocked Maintained Contact Push Button
Shipping Wt. 1 lb (0.45 kg)

Push Buttons and Pilot Lights

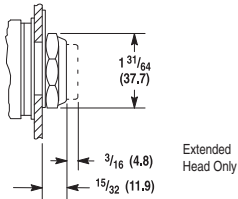

Flush and Extended Head Push Button
Shipping Wt. 5-1/2 oz (0.15 kg)

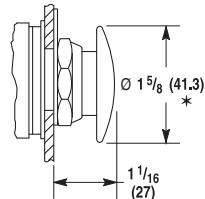

Mushroom Head Push Button
Shipping Wt. 7-1/2 oz (0.21 kg)

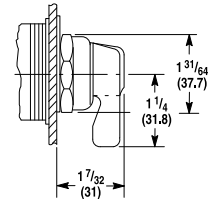

Non-Illuminated Knob Lever and Standard Knob Selector Switch
Shipping Wt. 6 oz (0.17 kg)

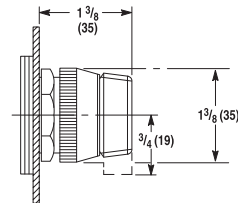

Illuminated Knob Lever and Standard Knob Selector Switch
Shipping Wt. 6 oz (0.17 kg)

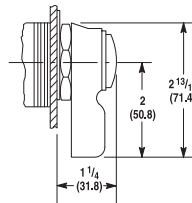

Wing Lever Selector Switch
Shipping Wt. 8 oz (0.22 kg)

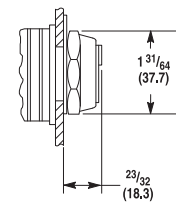

Coin Slot Selector Switch
Shipping Wt. 6 oz (0.17 kg)

* Except jumbo which is 2-1/4 (57.2).

Operator Extension in Front of Panel (Bul. 800T Only)

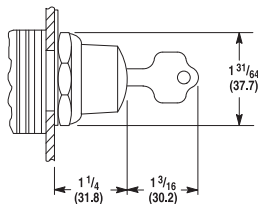

Key Operated Selector Switch
Shipping Wt. 12 oz (0.34 kg)

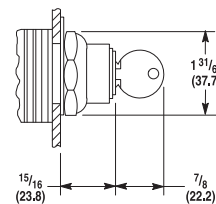

Push Button with Cylinder Lock
Shipping Wt. 12 oz (0.34 kg)

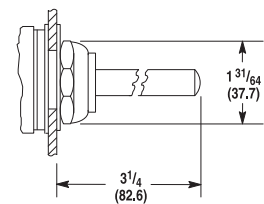

Wobble Stick
Shipping Wt. 9 oz (0.25 kg)

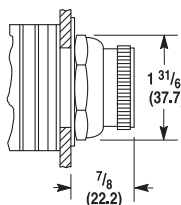

Selector Push Button
Shipping Wt. 6 oz (0.17 kg)

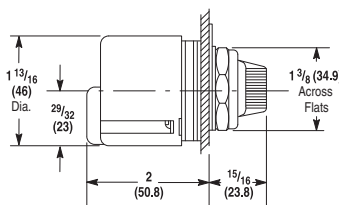

Type J Potentiometer Unit
Shipping Wt. 4 oz (0.11 kg)

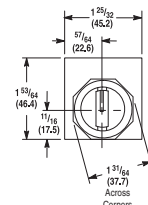

Dimensions in inches (millimeters). Dimensions are not intended to be used for manufacturing purposes.

Push Buttons and Switches (Bul. 800H Only)

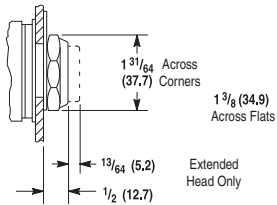

Bootless Flush and Extended Head Momentary Contact Push Button
Shipping Weight. 5-1/2 oz (0.16 kg)

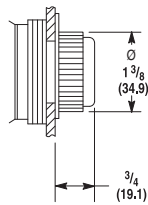

Booted Flush and Extended Head Momentary Contact Push Button
Shipping Weight. 5-1/2 oz (0.16 kg)

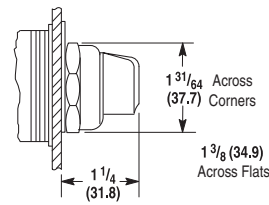

Standard Knob Selector Switch Non-Illuminated
Shipping Weight. 6 oz (0.17 kg)

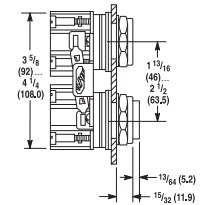

Bootless Maintained Contact Push Buttons

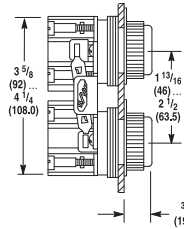

Booted Maintained Contact Push Buttons
Shipping Weight. 1 lb (0.45 kg)

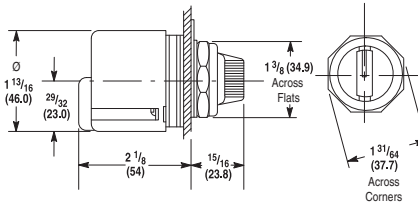

Type J Potentiometer Unit
Shipping Weight. 7 oz (0.20 kg)

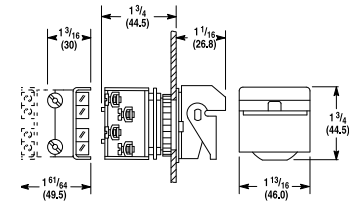

Type 4 Flip Lever
Shipping Weight. 8 oz (0.14 kg)

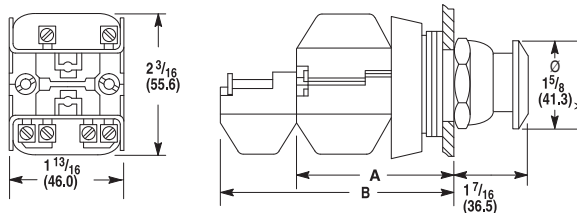

Mushroom Head — Maintained and Momentary

Non-Illuminated Mushroom and Push-Pull Push Buttons

Cat. No. Suffix	Description	Dimensions		Shipping Weights
D4	One Shallow Block	A	2-1/32 (51.6)	5 oz (0.14 kg)
A1, A5 and A7	Two Shallow blocks	A	2-1/32 (51.6)	6 oz (0.17 kg)
B6	Two Shallow Blocks and Two Mini Blocks	B	2-7/8 (73.0)	8 oz (0.22 kg)

* Jumbo versions are 2-1/4 (57.2).

30.5 mm Push Buttons

Approximate Dimensions

Dimensions in inches (millimeters). Dimensions are not intended to be used for manufacturing purposes.

Pilot Light and Illuminated Devices (Bul. 800T Only)

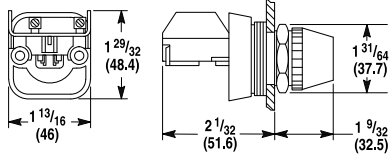

Full Voltage, Neon and Dual Input Pilot Light
Shipping Wt. 5 oz (0.14 kg)

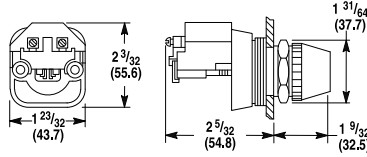

Transformer Type Pilot Light
Shipping Wt. 8 oz (0.22 kg)

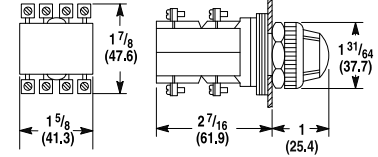

Cluster Pilot Light
Shipping Wt. 12 oz (0.34 kg)

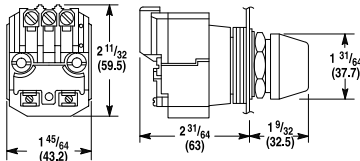

Dual Input Transformer Type Pilot Light

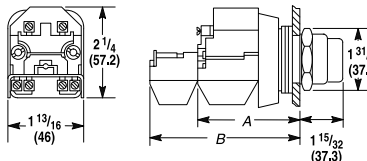

Transformer Type (Push-to-Test Pilot Light and Illuminated Push Button)

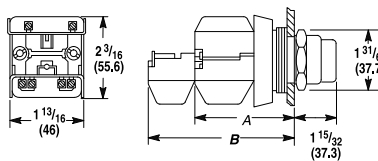

Full Voltage, Neon and Dual Input Type (Push-to-Test Pilot Light and Illuminated Push Button)

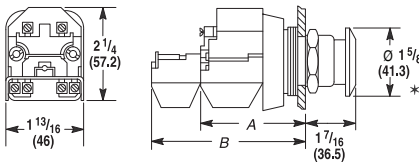

Push-Pull and Twist or Pull Release Units (Transformer Type Illuminated)

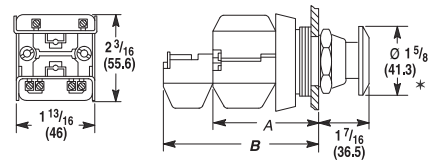

Push-Pull and Twist or Pull Release Units (Full Voltage, Neon and Dual Input Illuminated and All Non-Illuminated)

* Jumbo mushroom versions are 2-1/4 in. (57.2 mm) diameter.

Push-to-Test Pilot Lights Illuminated Push Buttons and Illuminated Push-Pull Buttons							Non-Illuminated Push-Pull Buttons					
Cat. No. Suffix*	Description	Transformer Type		Full Voltage or Neon Type		Cat. No. Suffix	Description	Transformer Type				
		Dim.	Ship. Wt.	Dim.	Ship. Wt.			Dim.	Ship. Wt.			
D4	Transformer or Terminal Module and One Shallow Contact Block	A	2-5/32 (54.8)†	9 oz. (0.25 kg)	A	2-1/32 (51.6)	7 oz. (0.25 kg)	D4	One Shallow Contact Block	A	2-1/32 (51.6)	5 oz. (0.14 kg)
A1 and A7	Transformer or Terminal Module and One Shallow Block and One Mini Contact Block	B	2-7/8 (73)	10 oz. (0.28 kg)	B	2-7/8 (73)	8 oz. (0.22 kg)	A4 A5 A7	Two Shallow Contact Blocks	A	2-1/32 (51.6)	6 oz. (0.17 kg)
AP D1P D2P	Transformer or Terminal Module and One Sealed Switch Contact Block	A	3-1/32 (77)	10 oz. (0.28 kg)	A	2-29/32 (73.8)	8 oz. (0.22 kg)	B6	Two Shallow Blocks and Two Mini Contact Blocks	B	2-7/8 (73)	8 oz. (0.22 kg)

* Applies to illuminated push-pull push buttons only.

† Dual input type pilot light dimension is 2-13/32 in. (61.1 mm).

10

18 mm Small Pilot Lights

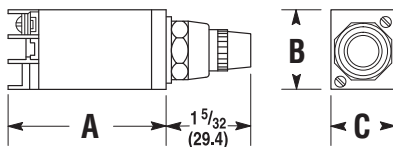

Small Pilot Light Including Push-To-Test
Shipping Weight 3 oz (0.08 kg)

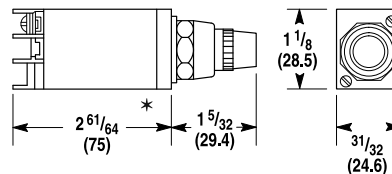

Small Pilot Light Dual Input (Diode)
Shipping Weight 3 oz (0.08 kg)

Device	A	B	C
800T-PS, -PSD, -PST, -QS, -QST, and -RST	2-1/4 (57.2)	1-1/16 (27)	27/32 (21.4)
800T-PSDT	2-61/64 (75)	1-15/64 (31.4)	31/32 (24.6)

* Transfer dual input pilot light dimension is 2-31/32 in. (75.4 mm).



Dimensions in inches (millimeters). Dimensions are not intended to be used for manufacturing purposes.

Push-to-Test Pilot Light and Illuminated Devices (Bul. 800H Only)

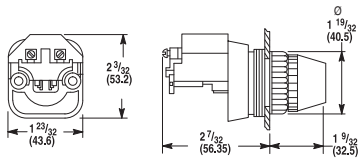

Transformer Type Pilot Light
 (Incandescent and LED)
Shipping Weight. 12 oz (0.34 kg)

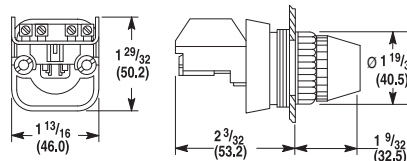

Full Voltage and Dual Input Diode Type
 Pilot Light (Incandescent, Neon, LED)
Shipping Weight. 5 oz (0.14 kg)

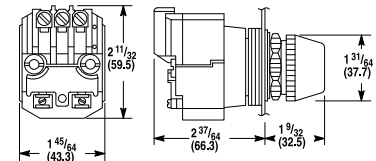

Dual Input Transformer Type Pilot Light
Shipping Weight. 14 oz (0.40 kg)

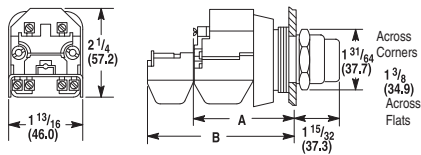

Push-to-Test Pilot Light and Illuminated
 Push Button
 (Transformer Type: Incandescent, LED)

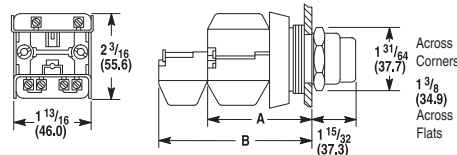

Push-to-Test Pilot Light and
 Illuminated Push Button
 (Full Voltage: Incandescent, LED, Neon;
 and Dual Input Type)

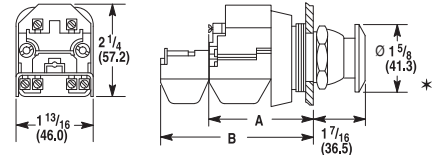

Momentary Mushroom, Push-Pull and Twist or
 Pull Release Units
 (Transformer Type: Incandescent, LED; Illuminated)

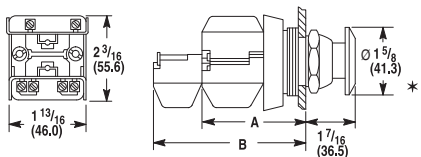

Momentary Mushroom, Push-Pull and
 Twist or Pull Release Units
 (Full Voltage: Incandescent, LED, Neon;
 and Dual Input Illuminated)

Push-to-Test Pilot Lights
Illuminated Push Buttons, Illuminated Push-Pull and Twist or Pull Release Push Buttons

Cat. No. Suffix*	Description	Transformer Type			Full Voltage or Neon Type		
		Dimension	Shipping Weight	Dimension	Shipping Weight		
D4	Transformer or Terminal Module and One Shallow Contact Block	A	2-5/32 (54.8)‡	9 oz. (0.25 kg)	A	2-1/32 (51.6)§	7 oz. (0.20kg)
A1 and A7	Transformer or Terminal Module, One Shallow Block and One Mini Contact Block	B	2-7/8 (73)	10 oz. (0.28 kg)	B	2-7/8 (73)	8 oz. (0.22 kg)
AP	Transformer or Terminal Module and One Sealed Switch Contact Block	B	2-29/32 (73.8)	10 oz. (0.28 kg)	B	2-29/32 (73.8)	8 oz. (0.22 kg)

* Jumbo mushroom versions are 2-1/4 in. (57.2 mm) diameter.

‡ Applies to illuminated push-pull push buttons only.

‡ Dual input type pilot light dimension is 2-13/32 in. (61.1 mm).

§ Dual input type pilot light dimension is 2-9/32 in. (57.9 mm).

Bulletin 800T/H
30.5 mm Push Buttons
 Approximate Dimensions

Dimensions in inches (millimeters). Dimensions are not intended to be used for manufacturing purposes.

Accessories

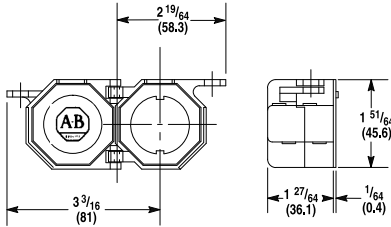

Push Button Padlocking Cover
 (not for use with Jumbo Mushroom Head devices)
Shipping Wt. 1 oz (0.03 kg)

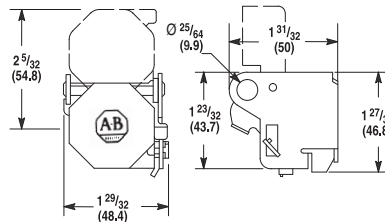

Selector Switch and Potentiometer Unit Padlocking Cover

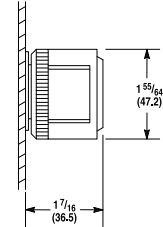

Protective Ring and Push-Pull Illuminated or Non-Illuminated Operators

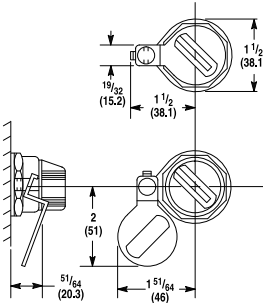

Selector Switch Padlocking Attachment

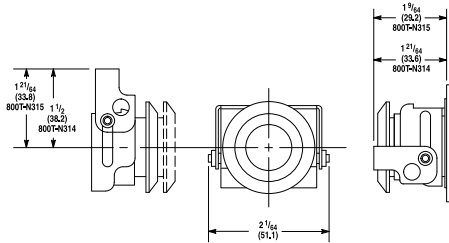

Push-Pull Padlocking Attachment and Metal Mushroom Push Button Padlocking Attachment

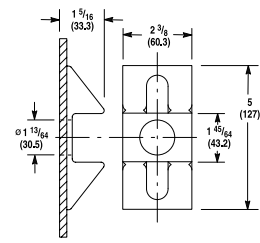

Ramp Guard for Push-Pull Illuminated or Non-Illuminated Operators

Accessories (Bul. 800H Only)

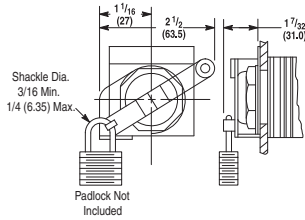

Locking Attachment for Extended, Non-Illuminated Push Buttons

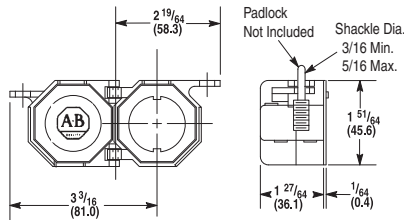

800H-N140 Locking Cover for 2-Position Non-Illuminated Maintained Twist or Pull Release and Standard Knob Selector Switch (1-5/8 (41.3) Mushroom Head only)

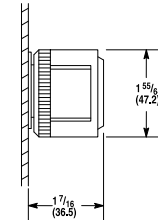

Protective Ring for 2-Position Push-Pull/Twist Illuminated or Non-Illuminated Operators

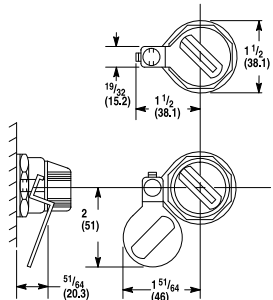

Non-Illuminated Selector Switch Padlocking Adjustment

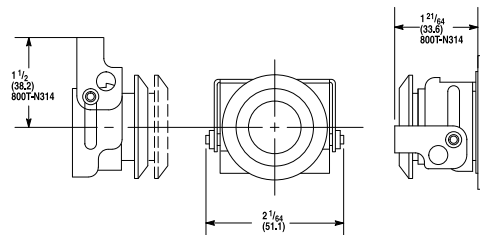

Push-Pull/Twist Padlocking Attachment

Dimensions in inches (millimeters). Dimensions are not intended to be used for manufacturing purposes.

Die Cast Enclosures (Bul. 800T Only)

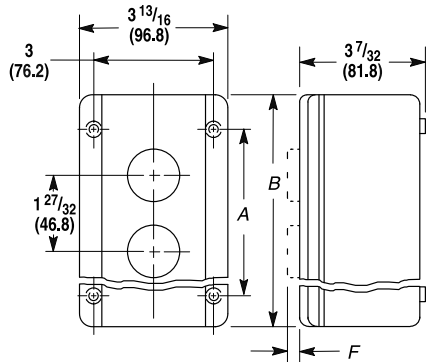

Enclosure Dimensions					
Dim.	No. of Units				
	1	2	3	4	6
A	2-3/4 (69.9)	4-1/2 (114.3)	6-1/4 (158.8)	8 (203.2)	12-1/8 (308)
B	4-3/16 (106.4)	5-7/8 (144.2)	7-9/16 (192.1)	9-1/2 (241.3)	13-1/2 (342.4)

Note: Mounting holes (4) — Screw shaft 13/64 in. (5.16 mm) max. diameter.

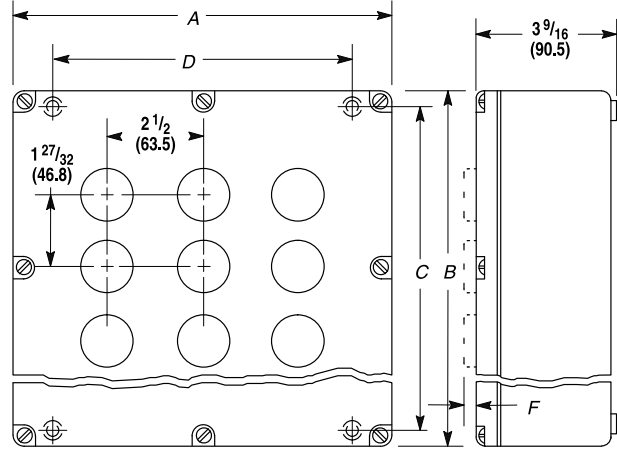

Enclosure Dimensions				
Dim.	No. of Units			
	6	9	12	16
A	7-1/4 (184.2)	9-3/4 (247.7)	9-3/4 (247.7)	12-1/2 (317.5)
B	9 (228.6)	9 (228.6)	11 (279.4)	11 (279.4)
C	8-1/4 (209.6)	8-1/4 (209.6)	10-1/8 (257.2)	10-1/8 (257.2)
D	5-3/8 (136.5)	7-7/8 (200)	7-7/8 (200)	10-5/8 (269.9)

Note: Mounting holes (4) — Screw shaft 7/32 in. (5.56 mm) max. diameter.

F Dimension

Type of Unit		Dimension F
Push Buttons	Flush Extended	15/32 (11.9)
	Extended	21/32 (16.7)
	Mushroom	1 (25.4)
	Selector	7/8 (22.2)
	Cylinder Lock	1-13/16 (46)
Selector Switches	Standard	1-7/32 (30.9)
	Cylinder Lock	2-7/16 (61.9)
	Coin Slot	3/4 (19.1)
Pilot Light		1-1/8 (28.6)
Potentiometers		1-1/16 (27)

Conduit Openings

General Class	Description	No. of Units*						
		1...4	6	9	12	16	20	25
Surface Mounted Enclosure	Die Cast	3/4 in. 14 N.P.T.	1 in. 11-1/2 N.P.T.	1 in. 11-1/2 N.P.T.	1 in. 11-1/2 N.P.T.	1-1/2 in. 11-1/2 N.P.T.	—	—

* Number of units that can be mounted in the enclosure.

Bulletin 800T/H
30.5 mm Push Buttons
 Approximate Dimensions

Dimensions in inches (millimeters). Dimensions are not intended to be used for manufacturing purposes.

Enclosures (Bul. 800T Only), Continued
Pendant Stations

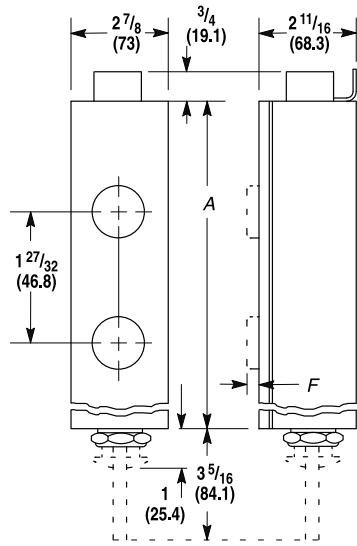

No. of Units	Dimension A
2	5-13/16 (147.6)
3	7-21/32 (194.5)
4	9-1/2 (241.3)
5	11-11/32 (288.1)
6	13-3/16 (335)
7	15-1/32 (381.7)
8	16-7/8 (428.6)
9	18-23/32 (475.4)
10	20-9/16 (522.3)

Sheet Metal Enclosures

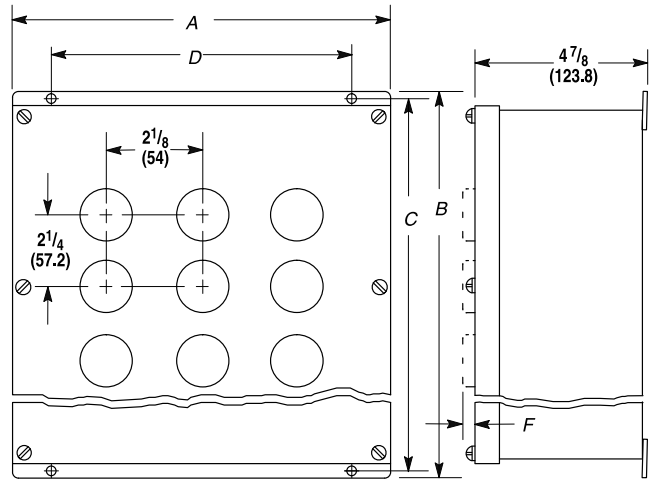

Dim.	Enclosure Dimensions					
	No. of Units					
	6	9	12	16	20	25
A	6-15/16 (176.2)	8-11/16 (220.7)	8-11/16 (220.7)	10-7/16 (265.1)	10-7/16 (265.1)	12-1/2 (317.5)
B	11-1/8 (282.6)	11-1/8 (282.6)	13-1/2 (342.9)	13-1/2 (342.9)	15-7/8 (403.2)	15-7/8 (403.2)
C	10-1/2 (266.7)	10-1/2 (266.7)	12-7/8 (370)	12-7/8 (370)	15-1/4 (387.4)	15-1/4 (387.4)
D	5 (127)	6-3/4 (171.5)	6-3/4 (171.5)	8-1/2 (215.9)	8-1/2 (215.9)	10-1/4 (260.4)

Note: Mounting holes (4) — Screw shaft 7/32 in. (5.56 mm) max. diameter.

F Dimension

Type of Unit		Dimension F
Push Buttons	Flush Extended	15/32 (11.9)
	Extended	21/32 (16.7)
	Mushroom	1 (25.4)
	Selector	7/8 (22.2)
	Cylinder Lock	1-13/16 (46)
Selector Switches	Standard	1-7/32 (30.9)
	Cylinder Lock	2-7/16 (61.9)
	Coin Slot	3/4 (19.1)
Pilot Light		1-1/8 (28.6)
Potentiometers		1-1/16 (27)

10 Conduit Openings

General Class	Description	No. of Units*					
		1...4	6	9	12	16	20
Surface Mounted Enclosure	Sheet Metal	None — Drilled to suit by customer.					
Pendant Type Enclosure	with Opening in Bottom	2...5			6...10		
		1 (25.4) Conduit Hub			1-1/4 (31.8) Conduit Hub		
	with Opening in Cover	1 (25.4) Conduit Hub			1-1/4 (31.8) Conduit Hub		

* Number of units that can be mounted in the enclosure.

Dimensions in inches (millimeters). Dimensions are not intended to be used for manufacturing purposes.

Enclosures (Bul. 800H Only)

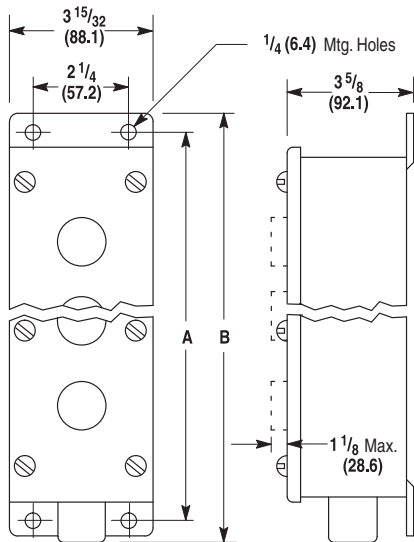

Type 4/4X/13 Stainless Steel
 Watertight, Oiltight, Corrosion Resistant Enclosure

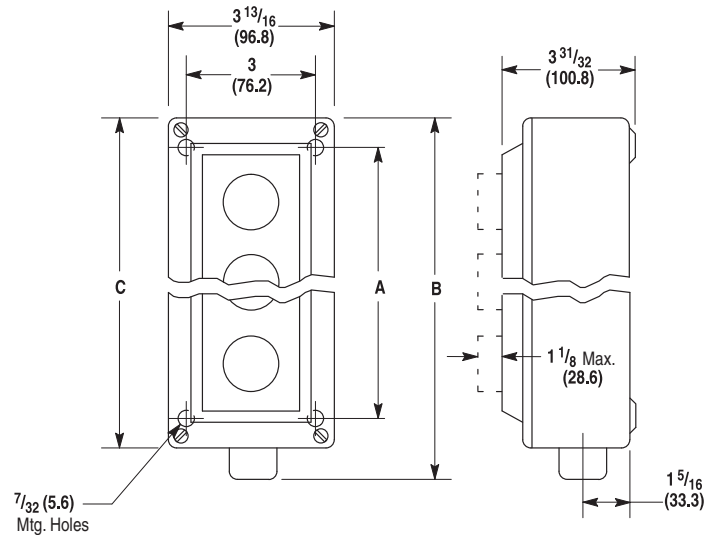

Type 4/4X/13 Rosite Glass Polyester
 Watertight, Oiltight, Corrosion Resistant Enclosure

Dimension	Type 4/4X/13 Stainless Steel							
	Number of Units							
	1	2	3	4	5	6	7	8
A	5-5/32 (131)	7 (177.8)	8-27/32 (224.6)	10-11/16 (271.5)	12-17/32 (318.3)	14-3/8 (365.1)	16-7/32 (412)	18-1/16 (458.8)
B	6-13/32 (162.7)	8-1/4 (209.6)	10-1/8 (257.2)	11-31/32 (304)	14-1/32 (356.4)	15-7/8 (403.2)	17-3/4 (450.8)	19-19/32 (497.7)
C	—				—			
Conduit Knockout Size	—				—			
Pipe Tap Size	3/4 (19.1)				1 (25.4)			
Approximate Shipping Wt. [lbs (kg)]	2-3/4 (1.3)	3-3/4 (1.7)	4-3/4 (2.2)	5-3/4 (2.6)	6-3/4 (3.1)	7-3/4 (3.5)	8-3/4 (4)	9-3/4 (4.4)

Dimension	Type 4/4X/13 Rosite					
	Number of Units					
	1	2	3	4	5	6
A	4-1/2 (114.3)	4-1/2 (114.3)	6-1/4 (158.8)	8 (203.2)	12-1/8 (308)	12-1/8 (308)
B	7-1/32 (178.6)	7-1/32 (178.6)	8-23/32 (221.5)	10-21/32 (270.7)	14-7/8 (377.8)	14-7/8 (377.8)
C	5-7/8 (149.2)	5-7/8 (149.2)	7-9/16 (192)	9-1/2 (241.8)	13-1/2 (342.9)	13-1/2 (342.9)
Conduit Knockout Size	—			—		
Pipe Tap Size	3/4 (19.1)			1 (25.4)		
Approximate Shipping Wt. [lbs (kg)]	2 (0.9)	2 (0.9)	2-1/2 (1.1)	3 (1.4)	4 (1.8)	4 (1.8)

30.5 mm Push Buttons

Approximate Dimensions

Dimensions in inches (millimeters). Dimensions are not intended to be used for manufacturing purposes.

Enclosures (Bul. 800H Only), Continued

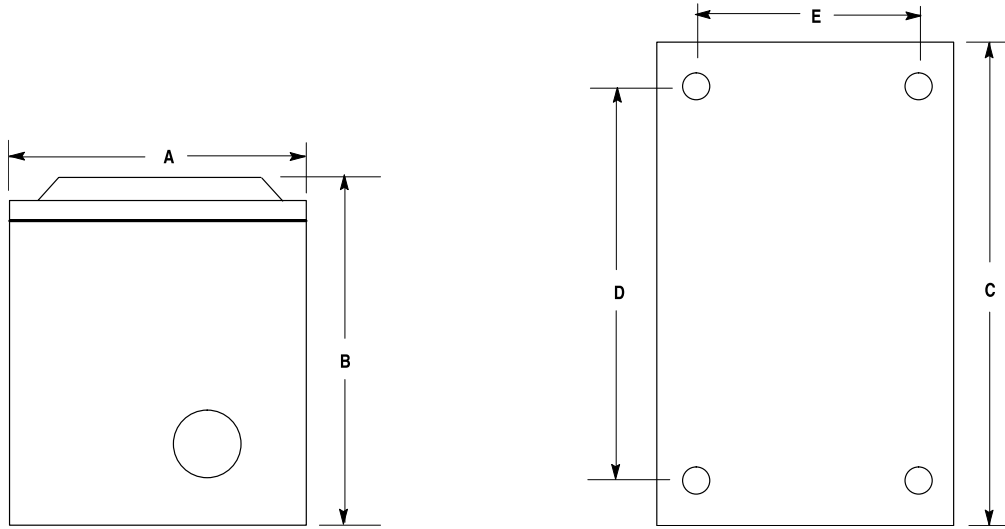

Dimension	Fiberglass Type 4/4X/12/13		
	Number of Units		
	1	2	3
A x B x C	4-1/2 x 5-3/16 x 6 (114.3 x 131.8 x 152.4)	4-1/2 x 5-3/16 x 8 (114.3 x 131.8 x 203.2)	6-1/2 x 5-7/16 x 8 (165.1 x 138.1 x 203.2)
D x E	4-3/4 x 2 (120.7 x 50.8)	6-3/4 x 2 (171.5 x 50.8)	6-3/4 x 4 (171.5 x 101.6)
Conduit Knockout Size	3/4 (19.1)	1 (25.4)	1 (25.4)
Approximate Shipping Wt. [lb (kg)]	2 (0.9)	1/4 (1.0)	3 (1.4)

Dimensions are shown in millimeters (inches). Dimensions are not intended to be used for manufacturing purposes.

Enclosures (Bul. 800H Only), Continued

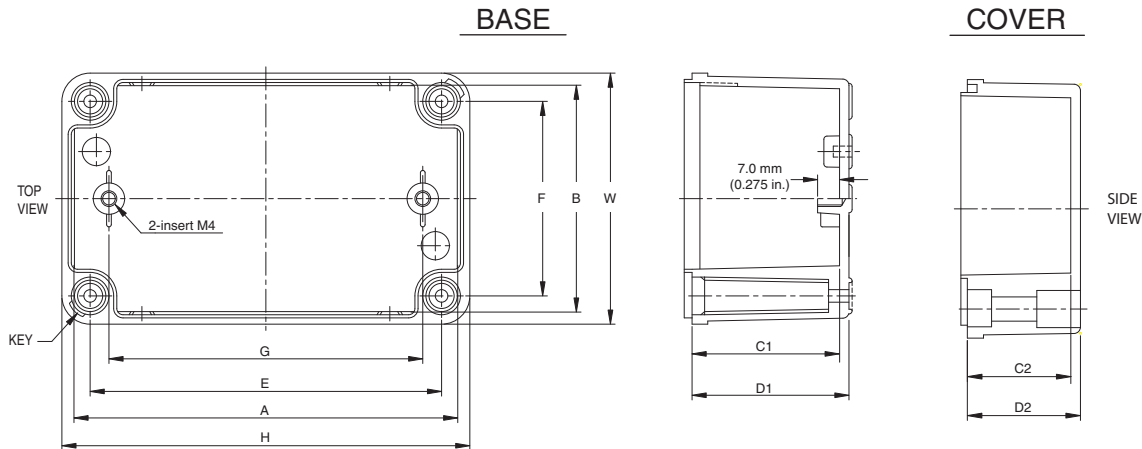

Thermoplastic Polyester Type 4/4X

Cat. No.	Overall Dimension				Inside Dimension				Enclosure Mounting Dimension		Mounting Plate Mounting Dim.
	H	W	D1	D2	A	B	C1	C2	E	F	
800H-1HZ4	110 (4.33)	80 (3.15)	50 (1.97)	20 (0.79)	104 (4.09)	74 (2.91)	46.5 (1.83)	16.5 (0.65)	92 (3.62)	62 (2.44)	80 (3.15)
800H-2HZ4	130 (5.12)	80 (3.15)	50 (1.97)	35 (1.38)	120 (4.72)	70 (2.76)	46.5 (1.83)	31.5 (1.24)	112 (4.41)	62 (2.44)	100 (3.94)
800H-3HZ4	180 (7.09)	80 (3.15)	50 (1.97)	35 (1.38)	170 (6.69)	70 (2.76)	46.5 (1.83)	31.5 (1.24)	162 (6.38)	62 (2.44)	150 (5.91)
800H-4HZ4	250 (9.84)	80 (3.15)	50 (1.97)	35 (1.38)	240 (9.45)	70 (2.76)	46.5 (1.83)	31.5 (1.24)	232 (9.13)	62 (2.44)	220 (8.66)

Typical Pilot Light Wiring Diagrams

See applicable codes and laws

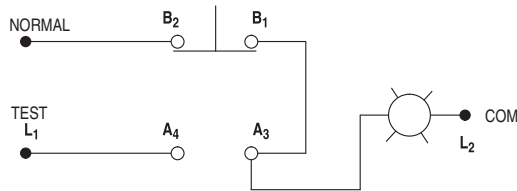

Push-to-Test Pilot Light Device Schematic

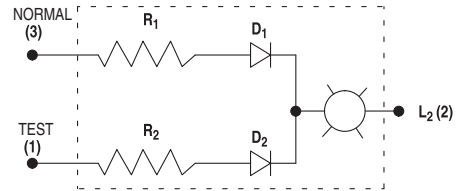

Dual Input Diode Pilot Light Device Schematic

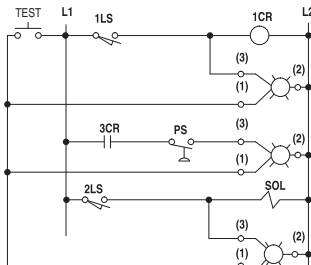

Dual Input Pilot Light Typical Application Wiring Diagram

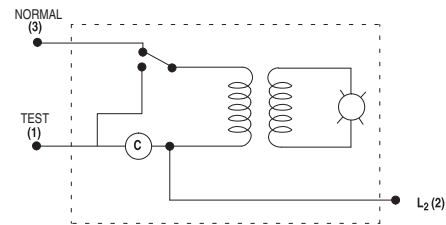

Dual Input Pilot Light Transformer Type Device Schematic