

440P Safety Limit Switches

30mm Metal Position Switches



The 30mm metal safety limit switches conform to EN 50041 and have been developed to provide a range of options including metal or plastic cases in various sizes, a choice of snap acting, slow break/make with 2, 3 or 4 contact configurations and a choice of actuator heads.

The Senator range offers the option of rotating the head in 90° increments before installation to allow ease of mounting.

Allen-Bradley/Guardmaster limit switches can be used in other applications other than guard doors, for example on moving machine beds, crane arms, lifts, elevators, etc.

Operation of these limit switches is achieved by the sliding action of the guard or other moving object deflecting the plunger or lever. For safety applications it is important that upon actuation, the guard or other moving objects should not pass completely over the switch and allow the plunger or lever to return to its original position.

Specifications

Standards	EN954-1, ISO13849-1, IEC/EN60204-1, NFPA79, EN1088, ISO14119, IEC/ EN60947-5-1, ANSI B11.19, AS4024.1			
Category	Cat. 1 Device per EN954-1 Dual channel interlocks suitable for Cat. 3 or 4 systems			
Approvals	cULus, TUV and CE marked for all applicable directives			
Safety Contacts	1 N.C. snap acting, 2 N.C., 3 N.C. or 4 N.C. slow acting			
Auxiliary Contacts	1 N.O. (with 2 N.C.)			
Designation/Utilization Cat.				
A600/AC-15	(Ue)	600V	500V	240V
	(Ie)	1.2A	1.4A	3A
N600/DC-13	(Ue)	600V	500V	250V
	(Ie)	0.4A	0.55A	1.1A
Min Current	5V, 5mA, DC			
Thermal Current (Ith)	10A			
Rated Insulation Voltage	600V AC			
Rated Impulse withstand Volt	2500V			
Travel for Positive Opening	Various (see Product Selection table)			
Max Switching Speed	250mm/s			
Min Switching Speed	100mm/min			
Max Switching Frequency	6000 operation per hour			
Case Material	Die cast alloy			
Actuator Material	See "Product Selection" table			
Enclosure Protection	IP 66			
Operating Temperature	Min -25°C (-18°F) Max 80°C (+176°F)			
Pollution Degree ①	3			
Mechanical Life Expectancy	1 x 10 ⁷			
Conduit Entry	M20 or 1/2in NPT			
Fixing	2 x M5			
Mounting	Any position			
Color	Red			

① Conductive pollution occurs, or dry, nonconductive pollution occurs which becomes conductive due to condensation.

Features

- Large selection of actuator heads
- Positive operation, forced disconnection of contacts
- Snap-acting, slow make before break or slow break before make contact blocks
- Contacts 1 N.C. + 1 N.O., 2 N.C. + 1 N.O. 3 N.C., 2 N.C. + 2 N.O., 3 N.C. + 1 N.O., or 4 N.C.
- Conforms to EN 50041, EN 1088, EN 60947-5-1, EN 292 and EN 60204-1





Safety Limit Switches

Product Selection	page 5-118
Wiring	page 5-121
Dimensions	page 5-121

440P Safety Limit Switches

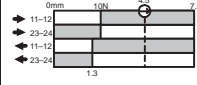
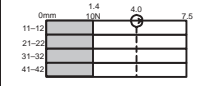
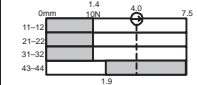
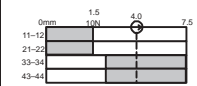

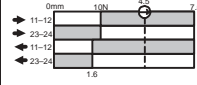
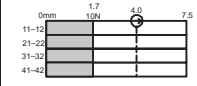
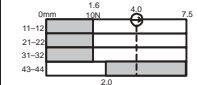
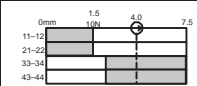
30mm Metal Position Switches

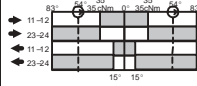
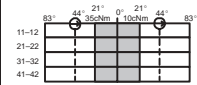
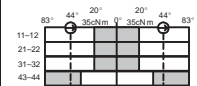
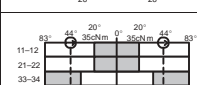
Product Selection

Operator Type	Contacts		Contact Type	Typical Force/ Torque to Operate	Contact Opening Characteristics □ Open ■ Closed ● Positive Opening Point	Catalog Number		
	Safety	Aux.				1/2in NPT Conduit	M20 Conduit	Quick Disconnect ●
	1 N.C.	1 N.O.	Snap Acting	13N		440P-MRPS11E	440P-MRPS11B	440P-MRPS11N5
	4 N.C.	—	—	11N		440P-MRPB04E	440P-MRPB04B	440P-MRPB04M9
	3 N.C.	1 N.O.	BBM	11N		440P-MRPB13E	440P-MRPB13B	440P-MRPB13M9
	2 N.C.	2 N.O.	BBM	11N		440P-MRPB22E	440P-MRPB22B	440P-MRPB22M9
	1 N.C.	1 N.O.	Snap Acting	13N		440P-MDPS11E	440P-MDPS11B	440P-MDPS11N5
	4 N.C.	—	—	11N		440P-MDPB04E	440P-MDPB04B	440P-MDPB04M9
	3 N.C.	1 N.O.	BBM	11N		440P-MDPB13E	440P-MDPB13B	440P-MDPB13M9
	2 N.C.	2 N.O.	BBM	11N		440P-MDPB22E	440P-MDPB22B	440P-MDPB22M9
	1 N.C.	1 N.O.	Snap Acting	0.34Nm		440P-MSLS11E	440P-MSLS11B	440P-MSLS11N5
	4 N.C.	—	—	0.20Nm		440P-MSLB04E	440P-MSLB04B	440P-MSLB04M9
	3 N.C.	1 N.O.	BBM	0.34Nm		440P-MSLB13E	440P-MSLB13B	440P-MSLB13M9
	2 N.C.	2 N.O.	BBM	0.34Nm		440P-MSLB22E	440P-MSLB22B	440P-MSLB22M9
Recommended standard cordset, 2m, 5-pin mini connector. See page ___ for additional lengths.						889N-F5AE-6F		
Recommended standard cordset, 2m, 12-pin 9 wire. See page ___ for additional lengths.						889M-F12X9AE-2		

● N5 = 5-pin mini connector.
M9 = 12-pin M23 connector (use 9 wire).

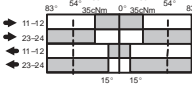
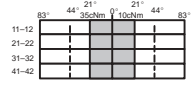
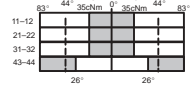
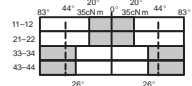
Product Selection (continued)

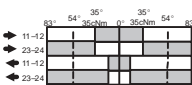
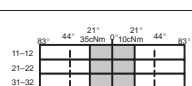
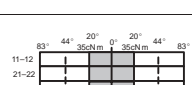
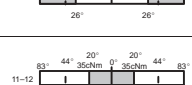
Operator Type	Contacts		Contact Type	Typical Force/Torque to Operate	Contact Opening Characteristics <input type="checkbox"/> Open <input type="checkbox"/> Closed ⊕ Positive Opening Point	Catalog Number		
	Safety	Aux.				1/2in NPT Conduit	M20 Conduit	Quick Disconnect ⊕
 Metal Adjustable Lever ⊕	1 N.C.	1 N.O.	Snap Acting	0.34Nm		440P-MALS11E	440P-MALS11B	440P-MALS11N5
	4 N.C.	—	—	0.20Nm		440P-MALB04E	440P-MALB04B	440P-MALB04M9
	3 N.C.	1 N.O.	BBM	0.34Nm		440P-MALB13E	440P-MALB13B	440P-MALB13M9
	2 N.C.	2 N.O.	BBM	0.34Nm		440P-MALB22E	440P-MALB22B	440P-MALB22M9
 Metal Rod Lever ⊕	1 N.C.	1 N.O.	Snap Acting	0.34Nm		440P-MARS11E	440P-MARS11B	440P-MARS11N5
	4 N.C.	—	—	0.20Nm		440P-MARB04E	440P-MARB04B	440P-MARB04M9
	3 N.C.	1 N.O.	BBM	0.34Nm		440P-MARB13E	440P-MARB13B	440P-MARB13M9
	2 N.C.	2 N.O.	BBM	0.34Nm		440P-MARB22E	440P-MARB22B	440P-MARB22M9
Recommended standard cordset, 2m, 5-pin mini connector. See page ___ for additional lengths.						889N-F5AE-6F		
Recommended standard cordset, 2m, 12-pin 9 wire. See page ___ for additional lengths.						889M-F12X9AE-2		



- ⊕ N5 = 5-pin mini connector.
- M9 = 12-pin M23 connector (use 9 wire).
- ⊕ Not positive opening

Limit Switches

440P Safety Limit Switches

30mm Metal Position Switches

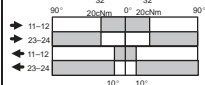
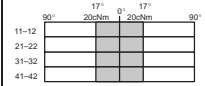
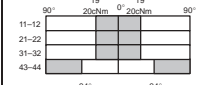
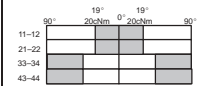
Product Selection (continued)

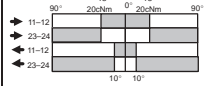
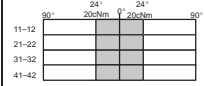
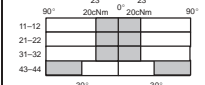
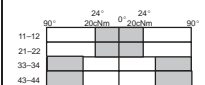
Operator Type	Contacts		Contact Type	Typical Force/Torque to Operate	Contact Opening Characteristics □ Open ■ Closed ⊕ Positive Opening Point	Catalogue Number	Catalogue Number	Catalogue Number
	Safety	Aux.				1/2in NPT Conduit	M20 Conduit	Quick Disconnect ①
 <p>Metal Spring Rod ⊕</p>	1 N.C.	1 N.O.	Snap Acting	0.20Nm		440P-MSRS11E	440P-MSRS11B	440P-MSRS11N5
	4 N.C.	—	—	0.20Nm		440P-MSRB04E	440P-MSRB04B	440P-MSRB04M9
	3 N.C.	1 N.O.	BBM	0.20Nm		440P-MSRB13E	440P-MSRB13B	440P-MSRB13M9
	2 N.C.	2 N.O.	BBM	0.20Nm		440P-MSRB22E	440P-MSRB22B	440P-MSRB22M9
 <p>Telescope Arm ⊕</p>	1 N.C.	1 N.O.	Snap Acting	0.20Nm		440P-MTAS11E	440P-MTAS11B	440P-MTAS11N5
	4 N.C.	—	—	0.20Nm		440P-MTAB04E	440P-MTAB04B	440P-MTAB04M9
	3 N.C.	1 N.O.	BBM	0.20Nm		440P-MTAB13E	440P-MTAB13B	440P-MTAB13M9
	2 N.C.	2 N.O.	BBM	0.20Nm		440P-MTAB22E	440P-MTAB22B	440P-MTAB22M9
Recommended standard cordset, 2m, 5-pin mini connector. See page ___ for additional lengths.							889N-F5AE-6F	
Recommended standard cordset, 2m, 12-pin 9 wire. See page ___ for additional lengths.							889M-F12X9AE-2	

① N5 = 5-pin mini connector.
M9 = 12-pin M23 connector (use 9 wire).
⊕ Not positive opening

Typical Wiring Diagram

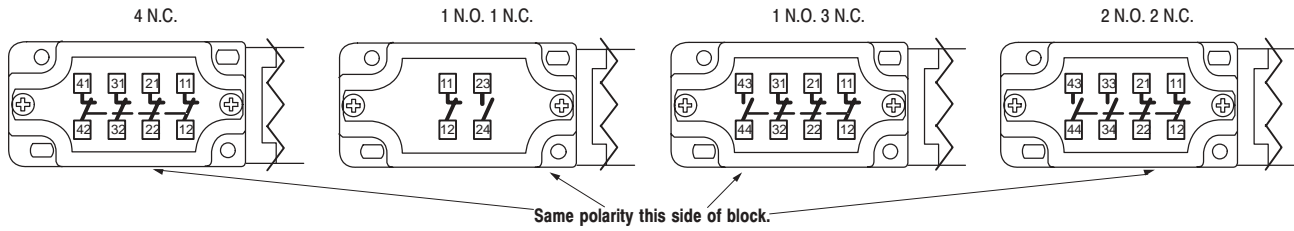

N5 Connector 2 Circuit 5-Pin Mini Connector

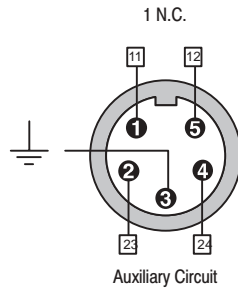

M9 12-Pin M23 Connector

Connector Pinout	4 N.C.		3 N.C. 1 N.O.		2 N.C. 2 N.O.		
	Terminal	Contact	Terminal	Contact	Terminal	Contact	
	1	11	N.C.	11	N.C.	11	N.C.
	3	12	N.C.	12	N.C.	12	N.C.
	4	21	N.C.	21	N.C.	21	N.C.
	6	22	N.C.	22	N.C.	22	N.C.
	7	31	N.C.	31	N.C.	33	N.O.
	8	32	N.C.	32	N.C.	34	N.O.
	9	41	N.C.	43	N.O.	43	N.O.
	10	42	N.C.	44	N.O.	44	N.O.
	12	Ground					

Approximate Dimensions—mm (inches)

Dimensions are not intended to be used for installation purposes.

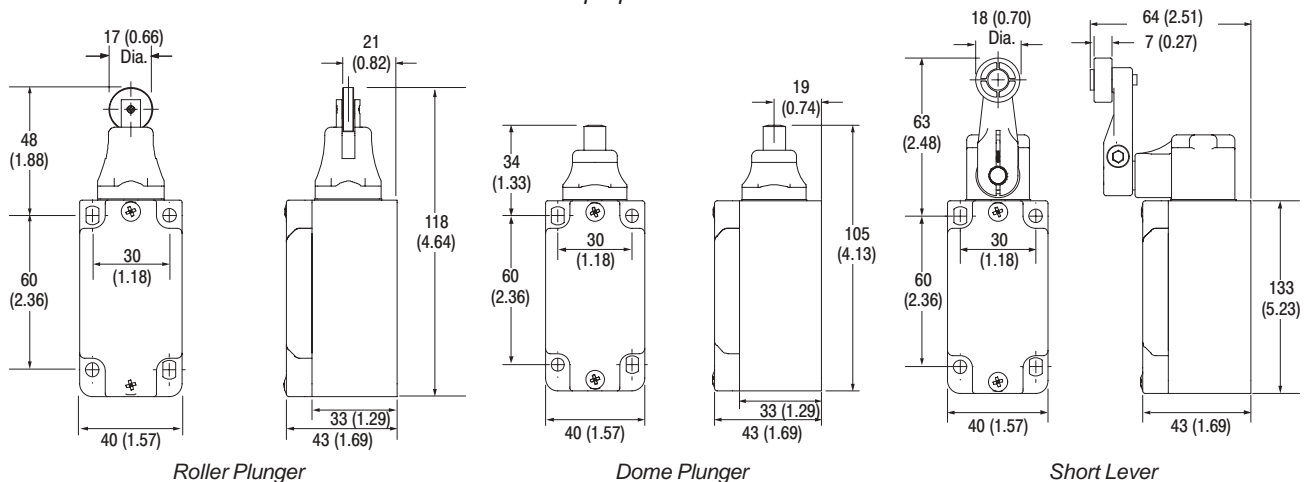

440P Safety Limit Switches

30mm Metal Position Switches

Approximate Dimensions—mm (inches)

Dimensions are not intended to be used for installation purposes.

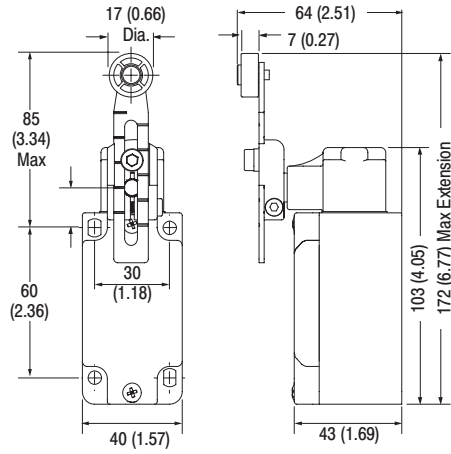

Adjustable Lever

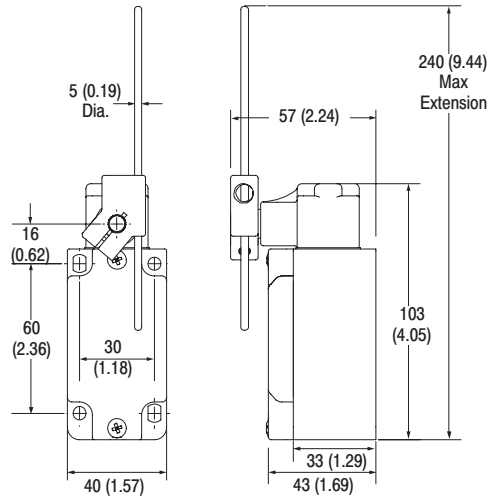

Rod Lever

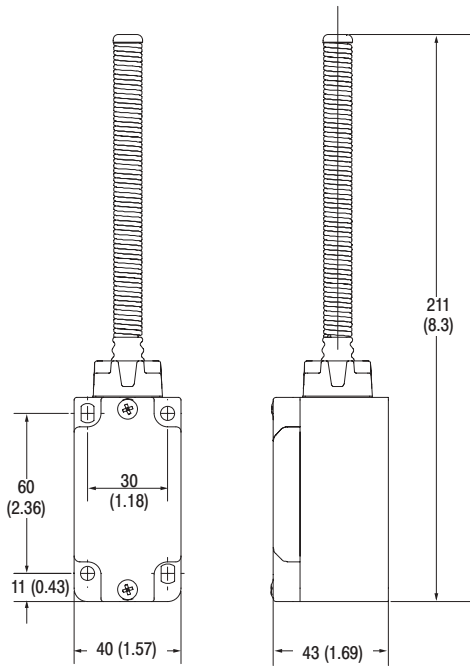

Spring Rod

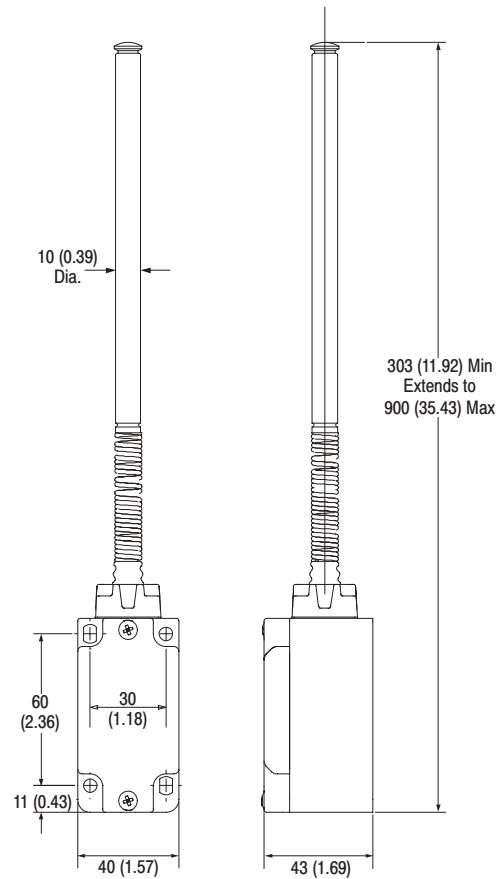

Telescopic Arm