









Operator Interface  
**Cable Pull Switches**  
 Lifeline™ 4 Stainless Steel

Accessories

	Description	Eye Bolts	Cat. No.
	Stainless steel installation kit—5 m (16.4 ft)—polypropylene	4	440E-A13194
	Stainless steel installation kit—10 m (32.8 ft)—polypropylene	4	440E-A13195
	Stainless steel installation kit—15 m (49.2 ft)—polypropylene	7	440E-A13196
	Stainless steel installation kit—20 m (65.6 ft)—polypropylene	8	440E-A13197
	Stainless steel installation kit—30 m (98.4 ft)—polypropylene	12	440E-A13198
	Stainless steel installation kit—50 m (164 ft)—polypropylene	20	440E-A13199
Polypropylene Covered Steel Cable	Stainless steel installation kit—75 m (246 ft)—polypropylene	30	440E-A13200
	Stainless steel installation kit—5 m (16.4 ft)—UV resistant	4	440E-A13220
	Stainless steel installation kit—10 m (32.8 ft)—UV resistant	4	440E-A13221
	Stainless steel installation kit—15 m (49.2 ft)—UV resistant	7	440E-A13222
	Stainless steel installation kit—20 m (65.6 ft)—UV resistant	8	440E-A13223
	Stainless steel installation kit—30 m (98.4 ft)—UV resistant	12	440E-A13224
	Stainless steel installation kit—50 m (164 ft)—UV resistant	20	440E-A13225
	UV Resistant Polypropylene-Covered Steel Cable	Stainless steel installation kit—75 m (246 ft)—UV resistant	30
	Stainless steel turn buckle kit (no cable)		440E-A13227
	Stainless steel 304 eyebolt complete M8 x 1.25 thread size, 58 mm (2.28 in) threaded length, 12 mm (0.47 in) dia. eye 95 mm (3.74 in) overall length		<b>440E-A13201</b>
	Stainless steel 316 tensioner spring, 19 mm (0.75 in) dia. 210 mm (8.27 in) overall length		<b>440E-A13202</b>
	Replacement Cover		440E-A13203
	Replacement cover no E-Stop		440E-A13204
	Stainless steel 316 inside corner pulley		440E-A13205
	Stainless steel outside corner pulley		440E-A13206

**Note: Installation Kits** include the following parts: one rope, one turnbuckle tensioner, four thimbles, eight rope grips and eyebolts, nuts and washers depending on the length of the rope.

Approximate Dimensions

Dimensions are shown in mm (in.). Dimensions are not intended to be used for installation purposes.

Standard Model

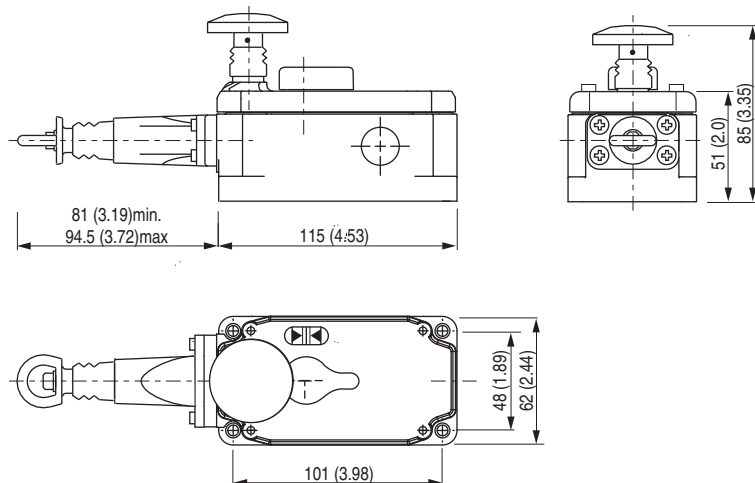

**Note:** 2D, 3D and electrical drawings are available on [www.ab.com](http://www.ab.com).