









Bulletin 194E/194L Handles (for use with Bulletin 194E Switches)

Color	Handles (Includes Legend Plate and Control Knob)			
Red/Yellow (Emergency Stop colors)	 Type I (IP66, UL Type 3/3R/12)	 Type L (IP66, UL Type 3/3R/12) With Locking For One Padlock (Padlock Not Included)	 Type N (IP66, UL Type 3/3R/12)	Bulletin 194L handles are available in both screw fixing and 22.5 mm mounting hole style.
Black/Grey (Standard Operation colors)	 Type A (IP66, UL Type 3/3R/12)	 Type E (IP66, UL Type 3/3R/12) With Locking For One Padlock (Padlock Not Included)	 Type G (IP66, UL Type 3/3R/12)	

Cat. No. Explanation

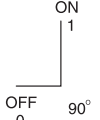
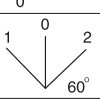
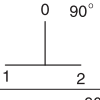
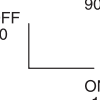
194L - HE 6 N - 175
 a b c d

a		c		d			
Code	Installation Type	Code	Legend Plate Type	Color	Code	Description	Legend Marking
HC	22.5 mm Mounting Hole Style Handle* (for use with front-mounted switches)	A	Square	Grey/Black	175	O-I	
HE	Screw-Mounting Handle (for use with front- and base-mounted switches)	I	Square	Red/Yellow	175I	OFF-ON	
4	A, E, I, L*	48 mm x 48 mm (1-57/64 in. x 1-57/64 in.)	48 mm x 62 mm (1-57/64 in. x 2-7/16 in.)	194E-16...63 A	350	1-0-2 (Reversing)	
	S	48 mm x 62 mm (1-57/64 in. x 2-7/16 in.)	194E-25...63 A	375		0-1-2 (90 degrees) (Changeover)	
6	A, E, I, L	64 mm x 64 mm (2-33/64 in. x 2-33/64 in.)	67 mm x 67 mm (2-41/64 in. x 2-41/64 in.)		194E-25...100 A	178	O-I
	G, N*‡	67 mm x 67 mm (2-41/64 in. x 2-41/64 in.)	194E-25...100 A	178I	OFF-ON		
8	A, I	88 mm x 88 mm (3-15/32 in. x 3-15/32 in.)	90 mm x 90 mm (3-35/64 in. x 3-35/64 in.)		194E-40...100 A		
	G, N	90 mm x 90 mm (3-35/64 in. x 3-35/64 in.)	194E-40...100 A				

* For 22.5 mm mounting hole style handle (code HC), select either handle type A, E, I, or L with 48 x 48 mm legend plate size (code 4) only or handle type G or N with 64 x 64 mm legend plate size (code 6) only.
 † Order 194E- 16A Type G and N handles as Cat. No. 194E-HE4N-175 or 194E-HE4G-175
 ‡ Use Type G and N with ON-OFF function only (selection "d", code -175)

Frequently Ordered 194L Handles — OFF-ON Base/Front-Mounted 3- and 6-Pole Switch Handles (Switch Body listed on page 2-357)

Handle Type	Degree of Protection	Handle Color	Bezel Plate Size	For Use With	Legend Plate Marking	Cat. No.
E	IP66 (UL Type 1) (UL Type 3/3R/12)	Black/Grey	48 mm x 48 mm (1-57/64 in. x 1-57/64 in.)	194E-16...63 A	0-1	194L-HE4E-175
				194L-E12...40 A, -1753 194L-A12...40 A, -1753	OFF-ON	194L-HE4E-175I
L	IP66 (UL Type 1) (UL Type 3/3R/12)	Red/Yellow	48 mm x 48 mm (1-57/64 in. x 1-57/64 in.)	194E-16...63 A	0-1	194L-HE4L-175
				194L-E12...40 A, -1753 194L-A12...40 A, -1753	OFF-ON	194L-HE4L-175I
G	IP66 (UL Type 3/3R/12)	Black/Grey	54 mm x 54 mm (2-1/8 in. x 2-1/8 in.)	194E-16 A	0-1 OFF-ON	194E-HE4G-175
				194E-25...100 A 194L-E12...40 A, -1753 194L-A12...40 A, -1753	0-1 OFF-ON	194L-HE6G-175
				194E-40...100 A	0-1 OFF-ON	194L-HE8G-175
				194E-16 A	0-1 OFF-ON	194E-HE4N-175
N	IP66 (UL Type 3/3R/12)	Red/Yellow	67 mm x 67 mm (2-41/64 in. x 2-41/64 in.)	194E-25...100 A 194L-E12...40 A, -1753 194L-A12...40 A, -1753	0-1 OFF-ON	194L-HE6N-175
				194E-40...100 A	0-1 OFF-ON	194L-HE8N-175
L	IP66 (UL Type 3/3R/12)	Red/Yellow	48 mm x 48 mm (1-57/64 in. x 1-57/64 in.)	194L-E12...40 A, -1753	0-1	194L-HC4L-175
					OFF-ON	194L-HC4L-175I

Bulletin 194E Open and Enclosed Switch Kits

Cat. No. Explanation

194E - Y 32 - 1753 - 6N
 a b c d



a		b		c		d	
Code	Installation Type	Code	Load Size	Code	Configuration	Code	Handle Style
A	Base/DIN Mounting, open type switch	16	16 A*	1753	3-Pole OFF/ON (90°)	4N	194E-HE4N-175 (use with 16 A Switch)
E	Front/Door Mounting, open type switch	25	25 A	1756	6-Pole OFF/ON (90°)	4G	194E-HE4G-175 (use with 16 A Switch)
Y	Enclosed Base Mounting Switch With Handle (Uses IP66 ABS thermoplastic enclosure)	32	32 A			4A	194L-HE4A-175 (use with 16...100 A Switch)
		40	40 A			6N	194L-HE6N-175 (use with 25...100 A Switch)
		63	63 A			6G	194L-HE6G-175 (use with 25...100 A Switch)
		80	80 A			6A	194L-HE6A-175 (use with 25...100 A Switch)
		100	100 A				

* For 16 A Enclosed Switch: use "16M" (3-pole enclosure has M16/20 knockouts, 6-pole 16 A enclosure has M25/32 knockouts). For 25/32 A Enclosed Switch with M20/25 metric knockouts: use "25M" or "32M".

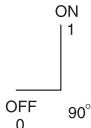

Frequently Ordered Switch Kits — OFF-ON Front- and Base-Mounted 3-Pole Switch With Cat. No. 194L-HE6N-175 Red/Yellow Handle

	Function Switching Angle	Rated Current [A]	AC23A Rated Power [kW] at 690V AC	HP @ 480V AC 60 Hz, 3 Ø	Base-Mounted Cat. No.	Front-Mounted Cat. No.
		25	7.5	10	194E-A25-1753-6N	194E-E25-1753-6N
		32	11	15	194E-A32-1753-6N	194E-E32-1753-6N
		63	18.5	25	194E-A63-1753-6N	194E-E63-1753-6N

Base-Mounting Distribution Switches (handles are pre-assembled to switch)

	Function Switching Angle	No. of Circuits	Contact Target		Handle Color	Legend Plate Marking	Lockable (One Padlock)	Rated Current [A]	AC23A Rated Power [kW] at 690V AC	Hp @ 480V AC 60 Hz, 3 Ø	Cat. No.
			OFF/0	ON/1							
		1 2 3	O O O	X X X	Red/Yellow	0-1	Yes	25	11	—	194E-A25-1753-R
					Black/Grey	0-1	No				194E-A25-1753-Q
					Red/Yellow	0-1	Yes	32	15	—	194E-A32-1753-R
					Black/Grey	0-1	No				194E-A32-1753-Q

Frequently Ordered Enclosures — 3- and 6-Pole Enclosed Switches With Cat. No. 194L-HE6N-175 Red/Yellow Operating Handles

	No. of Poles	Function Switching Angle	Rated Current [A]	Handle Color	Cat. No.
 <p>Uses Base-Mounted Switches</p>	3		16	Red/Yellow	194E-Y16-1753-4N
			25		194E-Y25-1753-6N
			32		194E-Y32-1753-6N
			40		194E-Y40-1753-6N
	6		25	Red/Yellow	194E-Y25-1756-6N



Bulletin 194E
IEC Load Switches
 Product Selection, Continued

Bulletin 194E Enclosed Disconnect Load Switches with 194R Handles (with Defeater, suitable for 3 padlocks)



2

Cat. No. Explanation *✱

194E – FA 32 E – P11 – P11 – 6

a b c d d e

a

Code	Enclosure Type
FA	UL Type 3/4/12, IP66 Painted Steel, Hinged, for 16...100 A switches
GA	UL Type 3/4/12, IP66 Painted Steel, Hinged, in 6 x 6 x 4 in. size, for 16...32 A 3-pole switches ‡
CA	UL Type 4/4X, IP66 Stainless Steel, Hinged, for 16...100 A switches
DA	UL Type 4/4X, IP66 Stainless Steel, Hinged, in 6 x 6 x 4 in. size, for 16...32 A 3-pole switches ‡
KA	UL Type 3/4/4X, IP66 Non-Metallic, for 16...100 A switches
AA	UL Type 1, IP54 Painted Steel, Hinged, for 16...100 A switches (Same enclosure as FA without gasketing)

b

Code	Load Size
16	16 A
20	25 A
32	32 A
40	40 A
63	63 A
80	80 A
00	100 A

c

Code	Handle Color (194R-HS _ _)
Blank	Grey/Black
E	Red/Yellow

d

Code	Left Side + Right Side Modifications*
Blank	No Option
-P11	1 N.O. + 1 N.C. Auxiliary Contacts
-PL11	1 N.O. + 1 N.C.L.B. Auxiliary Contacts
-P22	2 N.O. + 2 N.C. Auxiliary Contacts
-PD10	1 N.O. E.B.
-NP	Additional Pole
-PE	Grounding Pole
-TN	Neutral Pole

e

Code	Switch Type
Blank	3-pole switch
-6	6 Pole switch§

* Modifications: Up to two suffix codes may be added to an enclosed disconnect load switch. See Guidelines, page 6-73. If only one accessory is chosen, it is mounted on the left side of the switch.

✱ To order the cat. no. 194E-FA40/FA63 or 194E-CA40/CA63 in the larger 80/100A sized enclosure, add an "X" after the handle color. For example, Cat. No. **194E-FA40E** becomes Cat. No. **194E-FA40EX**.

‡ GA and DA type enclosures: use with 3-pole 16...32 A switches only.

§ Special order; allow for longer delivery time.

Frequently Ordered Bulletin 194E Enclosed Switches with Bulletin 194R Handle

Description	Rated Current (A)	Dimension Reference	Handle Color	Cat. No.*
Stainless steel enclosure, IP66/Type 4/4X	25	A1	Black	194E-CA20
			Red/Yellow	194E-CA20E
	32	A1	Black	194E-CA32
			Red/Yellow	194E-CA32E
	63	A1	Black	194E-CA63
			Red/Yellow	194E-CA63E
	25	A1	Black	194E-FA20
			Red/Yellow	194E-FA20E
	32	A1	Black	194E-FA32
			Red/Yellow	194E-FA32E
	40	A1	Black	194E-FA40
			Red/Yellow	194E-FA40E
	25	C1	Black	194E-KA20
			Red/Yellow	194E-KA20E

* Modifications: Up to two suffix codes may be added to an enclosed disconnect load switch. See Guidelines, page 2-361. If only one accessory is chosen, it is mounted on the left side of the switch.

IEC Load Switch Accessories

194E-E16...100 A, Front/Door Mounting

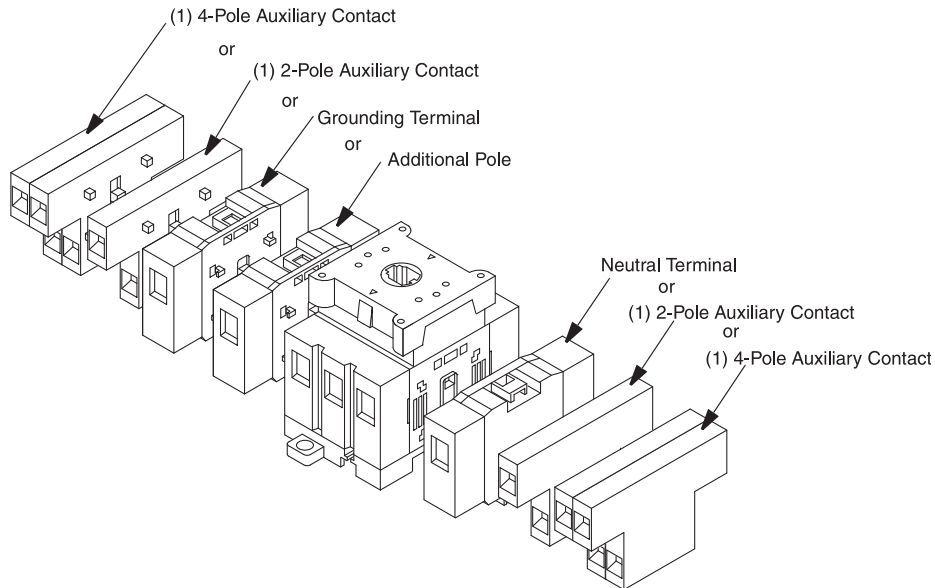

194E-A16...100 A, Base/DIN Rail Mounting

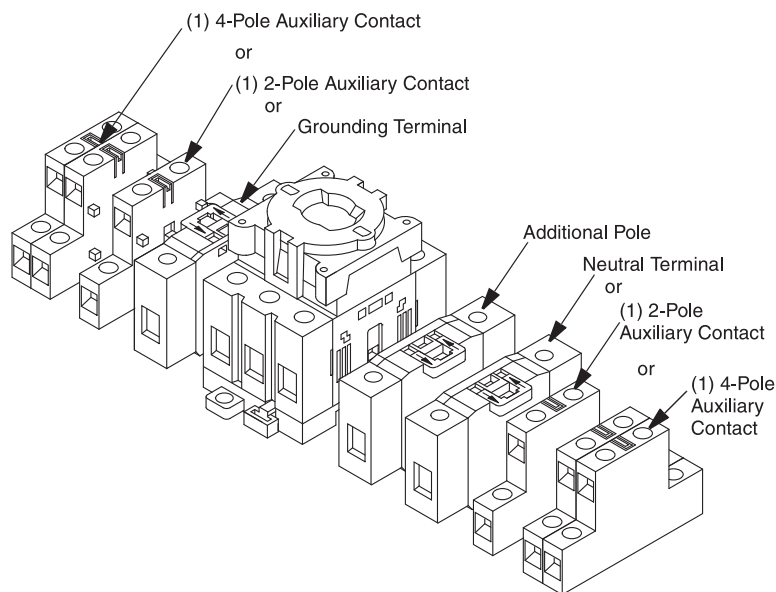



Accessory Configuration Guidelines

Accessory drawings represent modular, snap-on features of Bulletin 194E accessories. They are not suggesting possible accessory configurations. Use the following guidelines for choosing 194E accessory configurations.

- Up to two accessories may be added to the Bulletin 194E switch body.
- For the 194E 25, 32, 40, or 63 A switches, the early break auxiliary contact (-PD10) may only be used in the following configurations:
 - As a single unit on either side of the switch
 - As a single unit on a side when used with a switch + 4th pole (-NP)
 - As a single unit on a side when used with a switch + ground terminal (-PE)
 - As a single unit on a side when used with a switch + neutral terminal (-TN)
- No other auxiliary contact may be used in combinations with an early break auxiliary contact (-PD10)
- Other combinations of auxiliary contacts are permissible.
- For the 194E 80 and 100 A switches, any combination of auxiliary contacts, 4th pole, ground terminal, neutral terminal, and -PD10 is permissible.

Auxiliary Contacts	No. of Auxiliary Contacts	For Use With	Cat. No.*
	1 N.O. + 1 N.C.	194E-A16...100	194E-A-P11
		194E-E16...100	194E-E-P11
	1 N.O. + 1 N.C.L.B.	194E-A16...100	194E-A-PL11
		194E-E16...100	194E-E-PL11
	2 N.O. + 2 N.C.	194E-A16...100	194E-A-P22
		194E-E16...100	194E-E-P22
	1 N.O.E.B.	194E-A16	194E-A16-PD10
		194E-A25...100	194E-A-PD10
		194E-E16	194E-E16-PD10
		194E-E25...100	194E-E-PD10

Additional Pole, 1 N.O.	For Use With	Cat. No.*
	194E-A16	194E-A16-NP
	194E-A25	194E-A25-NP
	194E-A32	194E-A32-NP
	194E-A40	194E-A40-NP
	194E-A63	194E-A63-NP
	194E-A80	194E-A80-NP
	194E-A100	194E-A100-NP
	194E-E16	194E-E16-NP
	194E-E25	194E-E25-NP
	194E-E32	194E-E32-NP
	194E-E40	194E-E40-NP
	194E-E63	194E-E63-NP
	194E-E80	194E-E80-NP
	194E-E100	194E-E100-NP

Earthing/Grounding Terminal	For Use With	Cat. No.*
	194E-A16	194E-A16-PE
	194E-A25/32	194E-A32-PE
	194E-A40/63	194E-A63-PE
	194E-A80/100	194E-A100-PE
	194E-E16	194E-E16-PE
	194E-E25/32	194E-E32-PE
	194E-E40/63	194E-E63-PE
	194E-E80/100	194E-E100-PE

Neutral Terminal	For Use With	Cat. No.*
	194E-A16	194E-A16-TN
	194E-A25/32	194E-A32-TN
	194E-A40/63	194E-A63-TN
	194E-A80/100	194E-A100-TN
	194E-E16	194E-E16-TN
	194E-E25/32	194E-E32-TN
	194E-E40/63	194E-E63-TN
	194E-E80/100	194E-E100-TN



* A maximum of two side-mount accessories may be added to a 194E switch (one on each side).

6-Pole Mechanical Coupling**	For Use With	Cat. No.
	194E-16	194E-G3821
	194E-25/32	194E-G3660
	194E-40/63	194E-G3661
	194E-80/100	194E-G3662

ABS Thermoplastic Enclosure — IP66, For High-Impact Applications (grounding screw included)	No. of Poles	For Use With	Cat. No.
	3...4	194EA-25/32	194L-G3572
	3...4	194EA-40/63	194E-G3663
	6	194EA-25/32	
	6	194EA-40/63	194E-G3665
	3...4	194EA-80/100	

Noryl Thermoplastic Enclosures — IP66, For Corrosion-Prone Applications (grounding screw included)	No. of Poles	For Use With	Cat. No.
	3...4	194EA-25/32	194L-G3576
	6	194EA-25/32	194E-G3664
	3...4	194EA-40/63	
	6	194EA-40/63	194E-G3666
	3...4	194EA-80/100	



Description	For Use With	Pkg. Qty.	Cat. No.
Additional Earth/Ground and Neutral Terminals — For Thermoplastic Enclosure	194L-G3663, G3664, G3665, G3666	5	194E-G3673
	194L-G3572 and G3676	5	194E-G3653

Terminal Covers	No. of Poles	For Use With	Cat. No.
	1	194E-16	194E-16-C1
	3	194E-16	194E-16-C3
		194E-25/32	194E-25-C3
		194E-40/63	194E-40-C3
	4	194E-80/100	194E-80-C3
		194E-25/32	194E-25-C4
		194E-40/63	194E-40-C4
	194E-80/100	194E-80-C4	

* User must order (2) Bulletin 194E 3-Pole Switches separately.

** Coupling for changeover switch not available. Changeover switch must be ordered as a factory-assembled device (e.g., 194E-A25-3753).

Operating Shafts

	Length	Construction	Pkg. Qty.	Cat. No.
 Standard Shaft (for front-mount switches)	34 mm (1-11/32 in.)	Plastic	5	194L-G3380
		Metal	5	194E-G3688
 Interlock Shaft (for base-mount switches)	44 mm (1-47/64 in.) (Standard Length)	Plastic	5	194L-G2830
		Metal		194E-G3687
	52 mm (2-3/64 in.)	Plastic		194L-G3194
		Metal		194E-G3707
57 mm (2-15/64 in.)	Plastic	194L-G3195		

Bulletin 194E Load Switch Cat. No. Shaft Selection for use with 194E and 194L Thermoplastic Enclosures

Rated Current [A]	3-Pole Switches (-1753 suffix)		6-Pole Switches (-1756 suffix)		Changeover Switches (-3753 suffix)	
	194E-E...	194E-A...	194E-E...	194E-A...	194E-E...	194E-A...
16	plastic shaft (Cat. No. 194L-G3380)	plastic shaft (Cat. No. 194L-G2830)	metallic shaft (Cat. No. 194E-G3688)	metallic shaft (Cat. No. 194E-G3687)	metallic shaft (Cat. No. 194E-G3688)	metallic shaft (Cat. No. 194E-G3687)
25	plastic shaft (Cat. No. 194L-G3380)	plastic shaft (Cat. No. 194L-G2830)	metallic shaft (Cat. No. 194E-G3688)	metallic shaft (Cat. No. 194E-G3687)	metallic shaft (Cat. No. 194E-G3688)	metallic shaft (Cat. No. 194E-G3687)
32	plastic shaft (Cat. No. 194L-G3380)	plastic shaft (Cat. No. 194L-G2830)	metallic shaft (Cat. No. 194E-G3688)	metallic shaft (Cat. No. 194E-G3687)	metallic shaft (Cat. No. 194E-G3688)	metallic shaft (Cat. No. 194E-G3687)
40	plastic shaft (Cat. No. 194L-G3380)	plastic shaft (Cat. No. 194L-G2830)	metallic shaft (Cat. No. 194E-G3688)	metallic shaft (Cat. No. 194E-G3687)	metallic shaft (Cat. No. 194E-G3688)	metallic shaft (Cat. No. 194E-G3687)
63	plastic shaft (Cat. No. 194L-G3380)	plastic shaft (Cat. No. 194L-G2830)	metallic shaft (Cat. No. 194L-G3688)	metallic shaft (Cat. No. 194E-G3687)	metallic shaft (Cat. No. 194E-G3688)	metallic shaft (Cat. No. 194E-G3687)
80	metallic shaft (Cat. No. 194E-G3688)	metallic shaft (Cat. No. 194E-G3687)	metallic shaft (Cat. No. 194E-G3688)	metallic shaft (Cat. No. 194E-G3687)	metallic shaft (Cat. No. 194E-G3688)	metallic shaft (Cat. No. 194E-G3687)
100	metallic shaft (Cat. No. 194E-G3688)	metallic shaft (Cat. No. 194E-G3687)	metallic shaft (Cat. No. 194E-G3688)	metallic shaft (Cat. No. 194E-G3687)	metallic shaft (Cat. No. 194E-G3688)	metallic shaft (Cat. No. 194E-G3687)



Shaft Extension Kits

	Length	For Use With	Pkg. Qty.	Cat. No.
 Shaft Extension	24 mm (15/16 in.) Per Extension	194E-A...	10	194L-G2853

Metal Shaft Extensions — With Padlock Provision in OFF Position





	Length	For Use With	Pkg. Qty.	Cat. No.
	110...235 mm (4-21/64...9-1/4 in.)	194E-A...	1	194L-G3393
	230...350 mm (9-3/64...13-51/64 in.)			194L-G3394

Metal Shaft Adaptor Kits — For use with 194R Type 4/4X Handles



		For Use With	Pkg. Qty.	Cat. No.
	Metal shaft adaptor kits — for use with 194R Type 4/4X handles kit includes bezel adapter and 194R-R1 operating shaft. Operating handle (Cat. No. 194R-HS4) must be ordered separately.	194E-A...	1	194E-G3675
	Metal Shaft Extension For modification of Cat. No. 194L-G3393/ G3394 when used with any switches other than 2-position, 90° rotation.	194E-A...	10	194L-G3399



Other Accessories

194L/194E 22.5 mm Mounting Hole Style Handles (Type B, D) (For Front-Mounted Switches)

	Description	Cat. No.
 Type B	22.5 mm Mounting Hole Style Handles (IP65) Handle Style: Knob Lever with Latch (For Use With 194E-E25...100 A, -1753) or 194L-E12...40 A	194L-HCB-001
 Type D	22.5 mm Mounting Hole Style Handles Key Removal Position (Includes Latch) For Use With 194L-E 12...40 A, 194E-E16...63 A, -1753	 194L-HCDC-001
	22.5 mm Mounting Hole Style Handles Key Removal Position (Includes Latch) For Use With 194L-E 12...40 A, 194E-E16...63 A, -1753	 194L-HCDD-001
	22.5 mm Mounting Hole Style Handles Key Removal Position (Includes Latch) For Use With 194L-E 12...40 A, 194E-E16...63 A, -1753	 194L-HCDG-001

2

Accessory Description	Pkg. Qty.	Cat. No.
 Locking Ring Wrench For 22.5 mm Mounting Hole Style Handles (For use with front-mounted switches)	1	800E-AW2
 Control Knob, Black, with Locking Facility (Use 1/4 in. max. hasp lock.) (Locks in 0°, 90°, 180°, and 270° positions)	10	194L-G2864N
Control Knob, Red, with Locking Facility (Use 1/4 in. max. hasp lock)		194L-G2864R

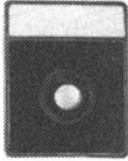
Accessory Description	Pkg. Qty.	Cat. No.
 Control Knob, Type P Control Knob, Black, 31 mm (1-7/32 in.) Diameter	5	194L-G2888N
Control Knobs, Type P Control Knob, Red, 31 mm (1-7/32 in.) Diameter		194L-G2888R
 Standard Black Control Knob	5	194L-G3154N
 Rectangular Front Frame		194L-G3155N
Control Knob, Black, L = 48 mm (1-57/64 in.)		194L-G3154R
Control Knob, Red, L = 48 mm (1-57/64 in.)		194L-G3155R
Rectangular front frame with blank nameplate L = 48 mm x 62 mm (1-57/64 in. x 2-7/16 in.)	10	194L-G3196
Rectangular front frame with blank nameplate L = 64 mm x 78 mm (2-33/64 in. x 3-5/64 in.)		194L-G3197

Additional Legend Plates/Frames

2



Color	Legend Size	For Use With	Pkg. Quantity	Legend Plate Marking	Cat. No.
Black/Grey	19.2 mm x 49 mm 3/4 in. x 1-59/64 in.	Size 6 Type G and N style handles, Cat. Nos. 194L-HE6G/N	5	(Blank)	194L-G3667
				MAIN SWITCH	194L-G3667A
				HAUPSCHALTER	194L-G3667B
				INTERR. PRINCIPALE	194L-G3667C
				INTERR. PRINCIPAUX	194L-G3667D
				INTERR. PRINCIPAL	194L-G3667E
				HUVUDBRYTARE	194L-G3667F
				WAHLSCHALTER	194L-G3667G
EMERGENCY OFF	194L-G3667H				
Black/Grey	18 mm x 84 mm 11/16 in. x 3-5/16 in.	Size 8 Type G and N style handles, Cat. Nos. 194L-HE8G/N	5	(Blank)	194L-G3515
				MAIN SWITCH	194L-G3515A
				HAUPTSCHALTER	194L-G3515B
				INTERR. PRINCIPALE	194L-G3515C
				INTERR. PRINCIPAUX	194L-G3515D
				INTERR. PRINCIPAL	194L-G3515E
				HUVUDBRYTARE	194L-G3515F
				WAHLSCHALTER	194L-G3515G
EMERGENCY OFF	194L-G3515H				

Legend Plates with Bezel	Legend Plate Color	Pkg. Quantity	Legend Plate Marking *		
			0-1	OFF-ON	Blank Legend Plate
			Cat. No.	Cat. No.	Cat. No.
	Silver	10	194L-A4-175	194L-A4-175I	194L-A4-000
			194L-A6-175	194L-A6-175I	194L-A6-000
			194L-A8-175	194L-A8-175I	194L-A8-000
	Yellow		194L-I4-175	194L-I4-175I	194L-I4-000
			194L-I6-175	194L-I6-175I	194L-I6-000
			194L-I8-175	194L-I8-175I	194L-I8-000

* Custom-Engraved legend plates available. To order, use publication 194L-PP002_-EN-P.

Shaft for Enclosures

Enclosure Type	Suitable For			Suitable For		
	194L (Base-Mounted Switches)	No. of Contacts	Shaft	Use with 194E Switch	No. of Poles	Shaft Required
194L-G3572	194L-A12(16)	1/2	194L-G3195	194E-A25(32)	3 and 4	194L-G3194
194L-G3576	194L-A12(16)	3/4	Standard			
(95 x 150 x 86 mm)	194L-A20(25)	1/2	194L-G3194			
	194L-A20(25)	3/4	Standard			
194L-G3573	194L-A12(16)	5/6	194L-G3195			
194L-G3577	194L-A12(16)	7/8	194L-G3194			
(95 x 150 x 111 mm)	194L-A12(16)	9/10	Standard	—	—	—
	194L-A20(25)	5/6	194L-G3194			
	194L-A20(25)	7/8	Standard			
194E-G3663				194E-A40(63)	3 and 4	194L-G3194
194E-G3664	—	—	—	194E-A25(32)	6	Standard
(125 x 180 x 105 mm)						
194E-G3665				194E-A80(100)	3 and 4	194E-G3707
194E-G3666	—	—	—	194E-A40(63)	6	Standard
(175 x 230 x 120 mm)						

2

Accessory Combinations in Enclosure

Enclosure Type	Switch	No. of Poles	Shaft	Aux. Contacts (single or double)	Additional Pole Block	On Switch		On Enclosure	
						Neutral Terminal Block	Ground Terminal Block	Neutral Terminal Block	Ground Terminal Block
194L-G3572 (ABS) 194L-G3576 (Noryl)	194E-A25(32)	3	194L-G3194	X	X				
				X		X			
				X			X		
					X		X		
						X	X		
				X				X	
				X					X
(95 x 150 x 86 mm)								X	X
	194E-G3663 (ABS) 194E-G3664 (Noryl)	3	194L-G3194	X	X			X	X
				X		X		X	X
				X			X		X
					X		X		X
						X	X		X
					X		X		X
					X	X		X	
(125 x 180 x 105 mm)	194E-A25(32)	6	194E-G3707					X	X
	194E-G3665 (ABS) 194E-G3666 (Noryl)	3	194E-G3707	X	X			X	X
X					X		X	X	
X						X		X	
				X		X		X	
					X	X		X	
				X		X		X	
					X	X		X	
(175 x 230 x 120 mm)	194E-A40(63)	6	194E-G3707	1L+1R				X	X

Bulletin 194E
IEC Load Switches
 Specifications

Electrical Ratings

Performance Data				16 A	25 A	32 A	40 A	63 A	80 A	100 A	Aux. Contacts	
IEC Applications												
Rated operational voltage (U_e): IEC*				[V]	690	690	690	690	690	690	690	690
Rated operational voltage (U_e): UL, CSA				[V]	600	600	600	600	600	600	600	600
Rated isolation voltage (U_i): IEC/UL, CSA				[V]	690/600	690/600	690/600	690/600	690/600	690/600	690/600	690/600
Rated impulse voltage (U_{imp}): UL, CSA				[kV]	8	8	8	8	8	8	8	8
Test voltage, (U_i) 1 minute				[kV]	2.5	2.5	2.5	2.5	2.5	2.5	2.5	2.5
Lost power per pole				[W]	0.58	1.0	1.5	1.6	2.4	3.6	5.5	0.4
Rated frequency				[Hz]	50/60	50/60	50/60	50/60	50/60	50/60	50/60	50/60
Conventional free air thermal current I_{th} *				[A]	25	40	50	63	75	100	120	12
Conventional enclosed thermal current I_e *				[A]	20	32	40	50	63	80	100	10
Rated current I_e*												
AC-1/	Non-inductive or only slightly inductive loads			[A]	16	25	32	40	63	80	100	10
AC-21A	Switching of resistive loads with slight overload											
Rated power P_e												
AC-23A	Occasional switching of 3Ø motors and other highly inductive loads (criterion for selecting main switches)	230V	[kW]	5.5	7.5	7.5	15	18.5	22	30	—	
		400V	[kW]	7.5	11	15	22	30	37	55	—	
		690V	[kW]	7.5	11	15	18.5	22	37	45	—	
AC-3	Squirrel-cage motors; starting and stopping of running motors	230V	[kW]	4	5.5	7.5	11	15	18.5	22	—	
		400V	[kW]	5.5	7.5	11	15	18.5	30	37	—	
		690V	[kW]	5.5	7.5	11	15	18.5	30	22	—	
Short circuit current (co-ordination type 2)				[kA]	20	20	15	20	15	30	25	—
Rated conditional short-circuit current				[A]	20	25	35	50	63	80	100	—
Maximum fuse rating of circuit (type g,G)				[A]	800	900	900	1300	1300	2500	2500	—
Rated short-time current I_{cw} (1 s)				[A]	800	900	900	1300	1300	2500	2500	—
Rated breaking capacity AC23A (cosφ 0.45)				[A]	156	296	296	484	484	780	780	—
				[A]	120	256	256	504	504	800	800	—
				[A]	70	136	136	196	196	376	376	—
DC switching capacity												
Rated current I_e	1 pole	48V	[A]	20	25	32	40	63	80	100	—	
		110V	[A]	5	5	6	8	10	16	20		
		220V	[A]	1	1	1	1.5	15	3	3		
		440V	[A]	0.5	0.5	0.5	0.6	0.6	0.7	0.7		
	2 poles in series	96V	[A]	20	25	32	40	63	80	100	—	
		110V	[A]	20	23	25	32	50	70	80		
		220V	[A]	5	5	6	8	10	16	20		
		440V	[A]	1	1	1	1.5	1.5	3	3		
	3 poles in series	110V	[A]	20	25	32	40	63	80	100	—	
		220V	[A]	13	13	15	20	28	50	63		
		440V	[A]	2.2	2.2	2.2	3.6	3.6	6.5	6.5		
		600V	[A]	1.3	1.5	1.5	2	2	3	3		
Rated power P_e												
DC-23A, DC-3, DC-5	For inductive loads, T ≤ 15 ms	90V	[kW]	1	1.3	1.5	2.9	4.1	5.1	7.2	—	
		110V	[kW]	1	1.1	1.3	2.2	3.3	5.5	7		
		220V	[kW]	0.8	0.9	1.1	1.7	2	3.5	4.4		
		440V	[kW]	0.6	0.6	0.6	0.9	0.9	1.1	1.1		
		600V	[kW]	0.4	0.4	0.4	0.5	0.5	0.9	0.9		

* See standards compliance listed on page 2-356.

* Suitable also for SEV 500.

Electrical Ratings, Continued

Performance Data			16 A	25 A	32 A	40 A	63 A	80 A	100 A	Aux. Contacts	
UL/CSA Applications											
Single-phase (2 poles)	Continuous current	[A]	16	25	32	40	63	80	100	—	
		Heavy Pilot Duty	[AC]	A600	A600	A600	—	—	—	—	A600
		Standard Duty	[DC]	—	—	—	—	—	—	—	Q600
	Motor rating 60 Hz	120V, 1P	FLA	16	16	16	24	34	56	80	—
			Hp	1	1	1	2	3	5	7.5	
		240V, 1P	FLA	12	12	17	17	28	50	68	
			Hp	2	2	3	3	5	10	15	
		480V, 1P	FLA	8.5	8.5	14	21	26	34	68	
			Hp	3	3	5	7.5	10	15	30	
	600V, 1P	FLA	11.2	11.2	11.2	16	20	27	44		
		Hp	5	5	5	7.5	10	15	25		
	Three-phase	120V, 3P	FLA	13.6	13.6	19.2	30.4	40	56	84	—
Hp			2	2	3	5	7.5	10	15		
240V, 3P		FLA	9.6	15.2	22	28	42	68	80		
		Hp	3	5	7.5	10	15	25	30		
480V, 3P		FLA	11	14	21	27	34	52	65		
		Hp	7.5	10	15	20	25	40	50		
600V, 3P	FLA	11	11	17	22	27	52	52			
	Hp	10	10	15	20	25	50	50			



Mechanical Data

Performance Data			16 A	25...32 A	40...63 A	80...100 A	Aux. Contacts
Protection class according to IEC 529							
Motor rating 60 Hz							
handles			IP66	IP66	IP66	IP66	IP66
switch bodies			IP20	IP20	IP20	IP20	IP20
Mechanical life	[million operations]		0.2	0.2	0.2	0.2	0.2
Max wire gauges							
Terminal size per IEC 947-1							
rigid wire	1/2 conductor	AWG	(1)16...10/(2)16...12	(1)14...8/(2)14...10	(1)12...4/(2)12...8	(1)10...1/(2)10...4	18...14
		mm ²	(1)1...10/(2)1...4	(1)1.5...16/(2)1.5...6	(1)2.5...25/(2)2.5...16	(1)4...50/(2)4...25	0.75...2.5
fine strands	1/2 conductor	AWG	(1)16...8/(2)16...12	(1)14...8/(2)14...10	(1)12...4/(2)12...8	(1)10...1/(2)10...6	18...14
		mm ²	(1)1.5...6/(2)1.5...4	(1)1.5...10/(2)1...6	(1)2.5...16/(2)2.5...10	(1)4...35/(2)4...16	0.5...2.5

Environmental Data

Storage	–40...+80 °C (–40...+176 °F)
Operation	–25...+60 °C (–13...+140 °F)

Bulletin 194E
IEC Load Switches
 Approximate Dimensions

Dimensions are shown in millimeters (inches). Dimensions are not intended to be used for manufacturing purposes.

Front Installation Cat. No. 194E-E...

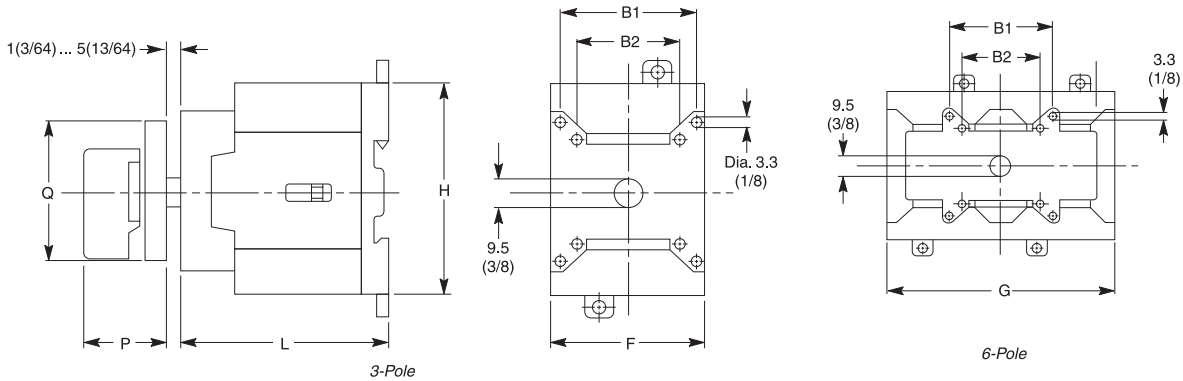

2

Handles		
Cat. No.	P	Q
194L-HE4A	28 (1-7/64)	48 x 48 (1-57/64 x 1-57/64)
194L-HE4I	28 (1-7/64)	48 x 48 (1-57/64 x 1-57/64)
194L-HE4S	28 (1-7/64)	48 x 62 (1-57/64 x 2-7/16)
194E-HE4N	34 (1-11/32)	54 x 54 (2-1/8 x 2-1/8)
194E-HE4G	34 (1-11/32)	54 x 54 (2-1/8 x 2-1/8)
194L-HE6A	28 (1-7/64)	64 x 64 (2-33/64 x 3-5/64)
194L-HE6I	28 (1-7/64)	64 x 64 (2-33/64 x 3-5/64)
194L-HE6S	28 (1-7/64)	64 x 78 (2-33/64 x 3-5/64)
194L-HE6N	34 (1-11/32)	67 x 67 (2-41/64 x 2-41/64)
194L-HE6G	34 (1-11/32)	67 x 67 (2-41/64 x 2-41/64)

Switch Body						
Use with Cat. No.	B1*	B2	F	H	L*	G
194E-E16	28 (1-7/64)	N/A	36 (1-37/64)	63 (2-31/64)	51 (2)	90 (3-35/64)
194E-E25/32	36 (1-27/64)	N/A	45 (1-25/32)	64 (2-33/64)	60 (2-3/8)	90 (3-1/2)
194E-E40/63	48 (1-57/64)	36 (1-27/64)	54 (2-1/8)	72 (2-27/32)	74 (2-29/32)	108 (4-1/4)
194E-E80/100	48 (1-57/64)	36 (1-27/64)	72 (2-27/32)	90 (3-35/64)	90 (3-35/64)	144 (5-11/16)

* Does not apply to 194E-40/63A, 6-Pole Switches. Use B2 dimensions for 6-pole devices.
 * For 6-pole switches, add 1 in. to the "L" dimension.

Cat. No. 194E-E Switch Body with Cat. No. 194L-HC4A Handle for 22.5 mm Hole Mounting Style

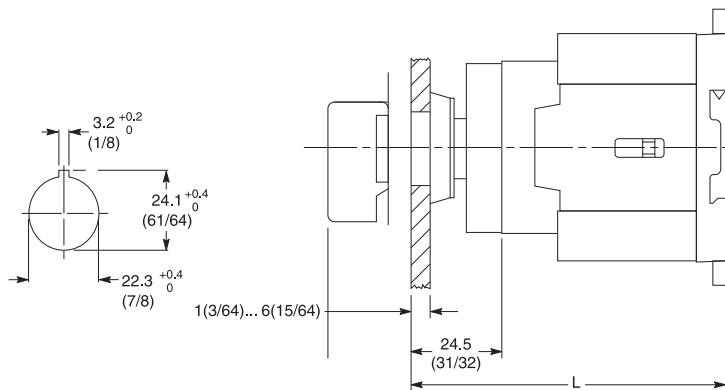

Type	L
194E-E16	76 (3)
194E-E25/32	84.5 (3-21/64)
194E-E40/63	98.5 (3-7/8)
194E-E80/100	114.5 (4-33/64)

Dimensions are shown in millimeters (inches). Dimensions are not intended to be used for manufacturing purposes.

Base Mounting Cat. No. 194E-A...

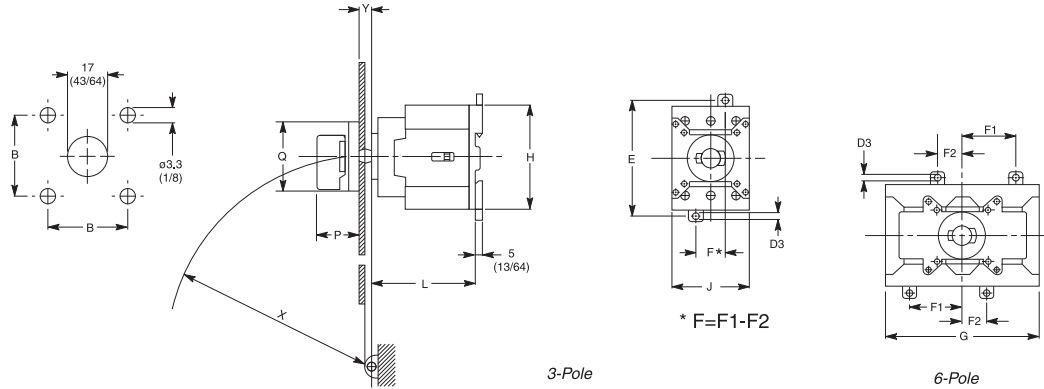

Handles		
Cat. No.	P	Q
194L-HE4A	28 (1-7/64)	48 x 48 (1-57/64 x 1-57/64)
194L-HE4I	28 (1-7/64)	48 x 48 (1-57/64 x 1-57/64)
194L-HE4S	28 (1-7/64)	48 x 62 (1-57/64 x 2-7/16)
194E-HE4N	34 (1-11/32)	54 x 54 (2-1/8 x 2-1/8)
194E-HE4G	34 (1-11/32)	54 x 54 (2-1/8 x 2-1/8)
194L-HE6A	28 (1-7/64)	64 x 64 (2-33/64 x 3-5/64)
194L-HE6I	28 (1-7/64)	64 x 64 (2-33/64 x 3-5/64)
194L-HE6S	28 (1-7/64)	64 x 78 (2-33/64 x 3-5/64)
194L-HE6N	34 (1-11/32)	67 x 67 (2-41/64 x 2-41/64)
194L-HE6G	34 (1-11/32)	67 x 67 (2-41/64 x 2-41/64)

Cover Requirements				
For Use With	Y min.	X ≥	Y max.	X ≥
194E-A16	5 (13/64)	142 (5-19/32)	9.5 (3/8)	90 (3-35/64)
194E-A25/32	5 (13/64)	142 (5-19/32)	9.5 (3/8)	90 (3-35/64)
194E-A40/63	2.5 (7/64)	150 (5-29/32)	9.5 (3/8)	90 (3-35/64)
194E-A80/100	2.5 (7/64)	150 (5-29/32)	9.5 (3/8)	90 (3-35/64)

Switch Body								
Use With Cat. No.	D3	E	F1	F2	G	H	L*	J
194E-A16	4.5 (3/16)	70 (2-49/64)	45 (1-25/32)	12.5 (31/64)	90 (3-35/64)	63 (2-31/64)	80 (3-5/32)	36 (1-27/64)
194E-A25/32	4.5 (3/16)	70 (2-49/64)	30 (1-3/16)	15 (19/32)	90 (3-1/2)	64 (2-33/64)	59 (2-5/16)	45 (1-25/32)
194E-A40/63	4.5 (3/16)	80 (3-5/32)	37 (1-15/32)	17 (43/64)	108 (4-1/4)	72 (2-27/32)	73 (2-55/64)	54 (2-1/8)
194E-A80/100	5.6 (7/32)	95 (3-3/4)	48.5 (1-29/32)	23.5 (59/64)	144 (5-11/16)	90 (3-35/64)	89 (3-1/2)	72 (2-27/32)

* For 6-pole switches, add 1 in. to the "L" dimension.

Base Mounting Cat. No. 194E-A...

Cat. No. 194E-A... Switch Body with Cat. No. 194L-G2853 Shaft Extension

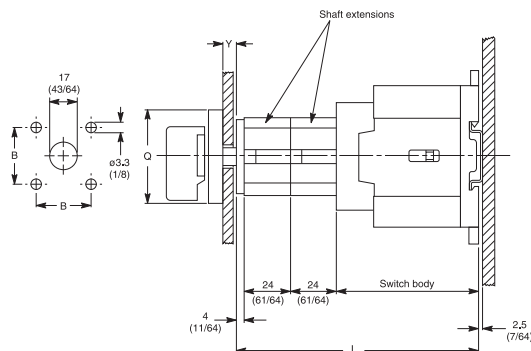

Switch Body

L *	Cat. No.			
	194E-A 16	194E-A 25/32	194E-A 40/63	194E-A 80/100
With 1 shaft extension	79 (3-7/64)	88 (3-15/32)	102 (4-1/32)	118 (4-21/32)
With 2 shaft extensions	103 (4-37/64)	112 (4-27/64)	126 (4-31/32)	142 (5-19/32)
With 3 shaft extensions	127 (5)	136 (5-23/64)	150 (5-29/32)	166 (6-35/64)
With 4 shaft extensions	151 (6-61/64)	160 (6-5/16)	174 (6-55/64)	190 (7-31/64)
With 5 shaft extensions	175 (7-57/64)	184 (7-1/4)	198 (7-51/64)	214 (8-7/16)
With 6 shaft extensions	199 (8-27/32)	208 (8-13/64)	222 (8-3/4)	238 (9-3/8)

* For 6-pole switches, add 1 in. to the "L" dimension.

Shaft	Y
194L-G2830	2.5...9.5 (7/64...3/8)
194L-G3194	9...18 (23/64...23/32)
194L-G3195	14...23 (9/16)...(29/32)

Type	Handles		
	B	Q	P
194L-HE4A	36 (1-27/64)	48 x 48 (1-57/64 x 1-57/64)	28 (1-7/64)
194L-HE4I	36 (1-27/64)	48 x 48 (1-57/64 x 1-57/64)	28 (1-7/64)
194E-HE4G	28 (1-7/64)	54 x 54 (2-1/8 x 2-1/8)	34 (1-11/32)
194E-HE4N	28 (1-7/64)	54 x 54 (2-1/8 x 2-1/8)	34 (1-11/32)
194L-HE6A	48 (1-57/64)	64 x 64 (2-33/64 x 2-33/64)	28 (1-7/64)
194L-HE6I	48 (1-57/64)	64 x 64 (2-33/64 x 2-33/64)	28 (1-7/64)
194L-HE6N	48 (1-57/64)	67 x 67 (2-41/64 x 2-41/64)	34 (1-11/32)
194L-HE6G	48 (1-57/64)	67 x 67 (2-41/64 x 2-41/64)	34 (1-11/32)

Dimensions are shown in millimeters (inches). Dimensions are not intended to be used for manufacturing purposes.

Base Installation Cat. No. 194E-A...

Cat. No. 194E-A Switch Body with Metal Shaft Extension

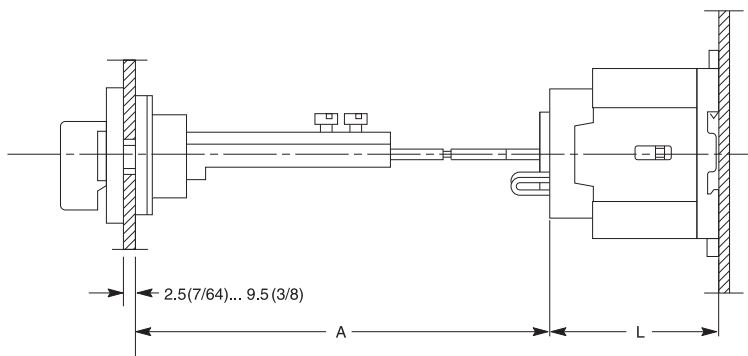

Cat. No.	A
194L-G3393	110...235 (4-11/32...9-1/4)
194L-G3394	230...350 (9-1/16...13-25/32)

Cat. No.	L*
194E-A16	51 (2)
194E-A25/32	60 (2-3/8)
194E-A40/63	74 (2-59/64)
194E-A80/100	90 (3-35/64)

* For 6-pole switches, add 1 in. to the "L" dimension.

Base and Front Installation

Cat. No. 194E... with Auxiliary Contact Block Installed

Contacts	M
1 N.O. + 1 N.C.	9 (23/64)
2 N.O. + 2 N.C.	18 (23/32)

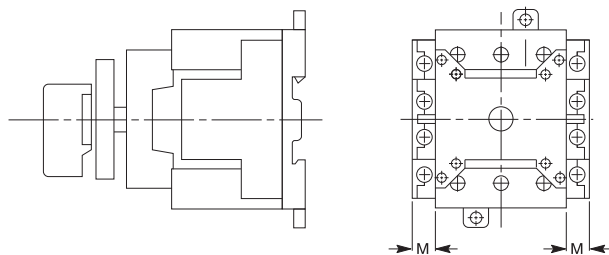

Cat. No. 194E... with 4-Pole, Ground and Neutral Terminals

Cat. No.	M
194E-16	12.5 (31/64)
194E-25/32	14 (9/16)
194E-40/63	17.5 (11/16)
194E-80/100	22 (7/8)

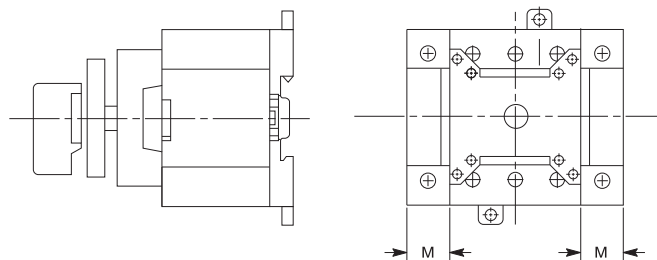

Bulletin 194E
IEC Load Switches
 Approximate Dimensions, Continued

Dimensions are shown in millimeters (inches). Dimensions are not intended to be used for manufacturing purposes.

Base Mounting Cat. No. 194E-A...

Thermoplastic Enclosures

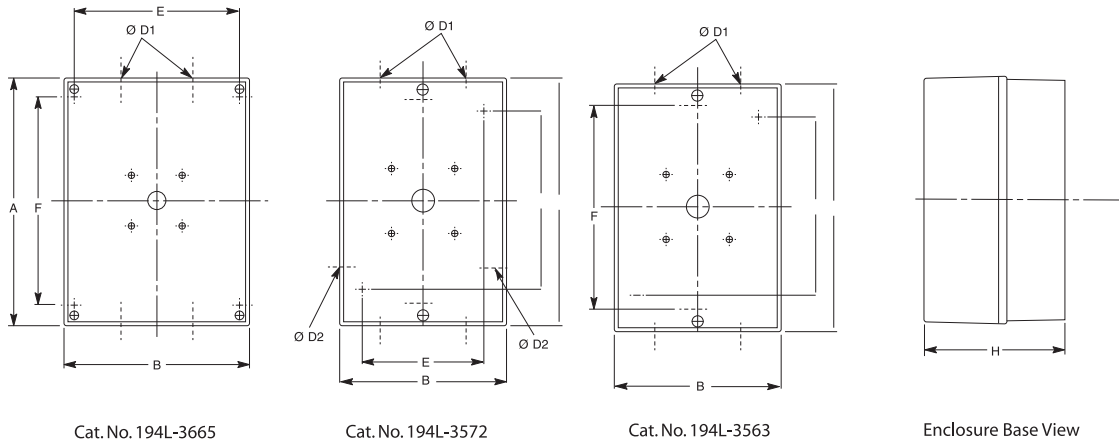

2

Complete Switches		Enclosures		Height A	Width B	Knockouts*		Mounting Holes†		Depth H
Cat. No.	Poles	ABS Cat. No.	Noryl Cat. No.			ØD1	ØD1	E	F	
194E-Y16	3 and 4	*	*	118 (4-21/32)	66 (2-19/32)	M16/M20 16/20 mm	PG11/PG16 18.5/22.5 mm	50 (1-31/32)	105 (4-9/65)	70 (2-49/65)
	6	194E-G3663	194E-G3664	180 (7-3/32)	125 (4-59/64)	M25/M30 25/30 mm	PG21/PG29 28.5/37.5 mm	On Center	145 (5-23/32)	105 (4-1/8)
194E-Y25/32	3 and 4	194L-G3572	194L-G3576	150 (5-29/32)	95 (3-3/4)	PG16/PG21 22.5/28.5 mm		60 (2-3/8)	115 (4-17/32)	86 (3-3/8)
	6	194E-G3663	194E-G3664	180 (7-3/32)	125 (4-59/64)	PG21/PG29 28.5/37.5 mm		On Center	145 (5-23/32)	105 (4-1/8)
194E-Y40/63	3 and 4	194E-G3663	194E-G3664	180 (7-3/32)	125 (4-59/64)	PG21/PG29 28.5/37.5 mm		On Center	145 (5-23/32)	105 (4-1/8)
	6	194E-G3665	194E-G3666	230 (9-1/16)	175 (6-57/64)	PG29/PG36 37.5/47.5 mm		155 (6-3/32)	195 (4-11/16)	120 (4-47/64)
194E-Y80/100	3 and 4	194E-G3665	194E-G3666	230 (9-1/16)	175 (6-57/64)	PG29/PG36 37.5/47.5 mm		155 (6-3/32)	195 (4-11/16)	120 (4-47/64)

* Empty enclosures not available for purchase.
 * Cat. No. 194E-A16 units have 1 knockout on each end, all others have 2 knockouts on each end. A letter "M" in the catalog number indicates metric knockouts; the unit is otherwise supplied with PG knockouts.
 † All mounting holes have a 4.2 mm (5/32 in.) diameter.

No. of Extensions	Cat. No. 194E-A 20/32...	Cat. No. 194E-A 40/63...	Cat. No. 194E-A 80/00...
With 1 extension	96 (3-25/32)	107 (4-7/32)	114 (4-31/64)
With 2 extensions	120 (4-23/32)	131 (5-5/32)	138 (5-7/16)
With 3 extensions	144 (5-43/64)	155 (6-7/64)	162 (6-3/8)
With 4 * extensions	168 (6-39/64)	179 (7-3/64)	186 (7-21/64)
With 5 * extensions	192 (7-9/16)	203 (8)	210 (8-17/64)
With 6 * extensions	216 (8-1/2)	227 (8-15/16)	234 (9-7/32)

* When more than 4 modules are used, attach the first one to the switch body using the screws supplied with the extension (Cat. No. 194L-G2853).

Dimensions are shown in millimeters (inches). Dimensions are not intended to be used for manufacturing purposes.

194E Enclosed Switches with 194R Handles

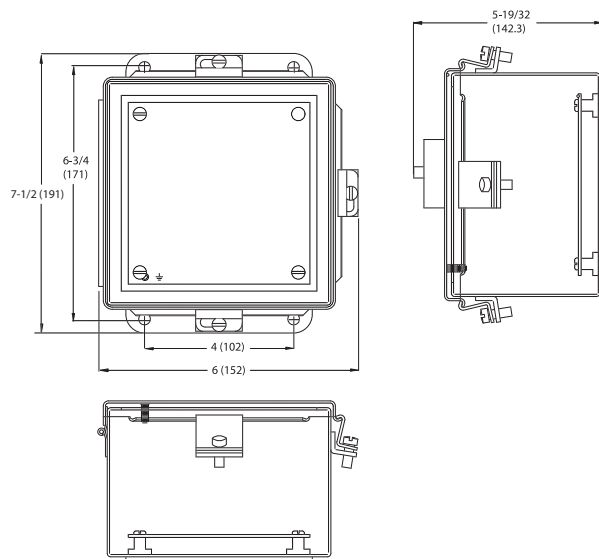
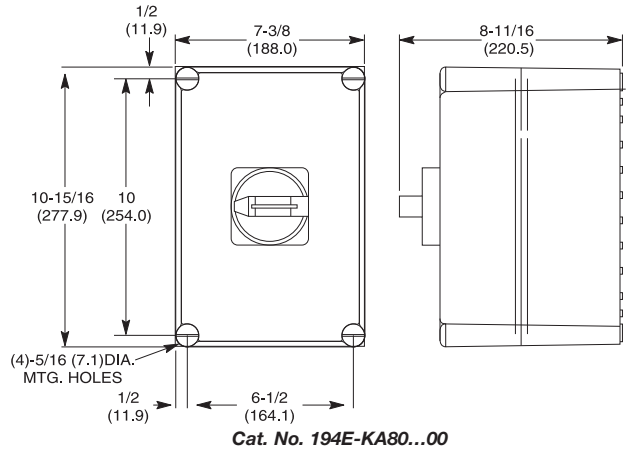
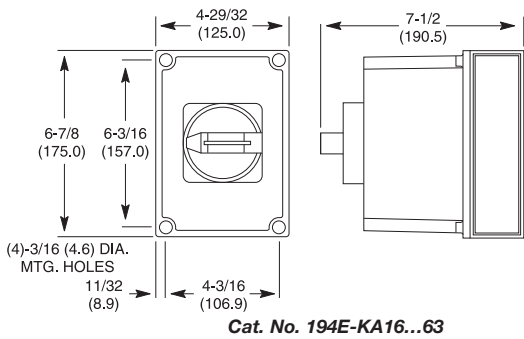
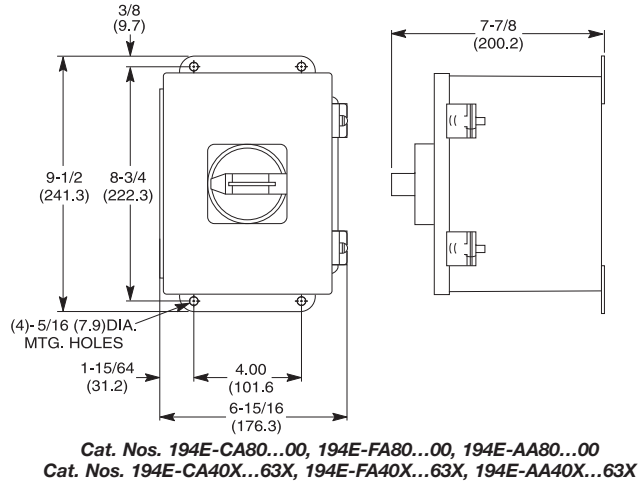
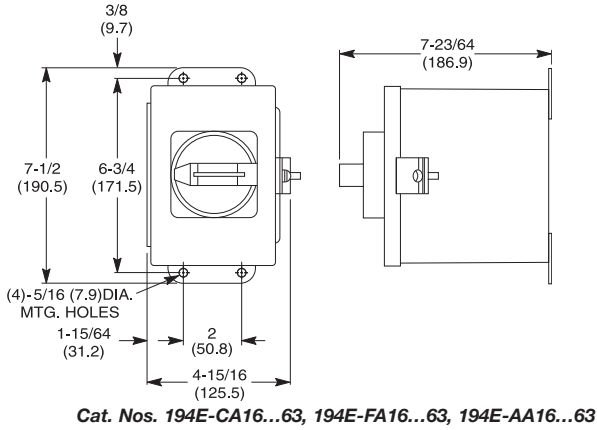

Bulletin 194E
IEC Load Switches
 Overview



Bulletin 194E IEC Load Switches

- At-Motor Disconnect Switch (UL508)
- 125, 160, 250, 315 A Versions of Inductive Load-Rated Switches
- IP66/UL Type 1/3/3R/12 Operating Handles
- IP2LX Finger-Safe Terminals
- 3- and 4-Pole Versions
- Front/Door or DIN/Base Mounting Configurations
- OFF-ON Configurations
- Box Lug and Bolt-on Terminals Available
- Switches Include Operating Shaft
- Suitable as Motor Disconnect

Bulletin 194E load switches are designed for use as local motor isolation and for disconnect switch applications. They are available in 3- and 4-pole versions with add-on grounding and neutral terminals and auxiliary contacts. Bulletin 194E switches are offered in two mounting styles, Front/Door and Base/DIN configurations, for a variety of installations. Switch body styles for Bulletin 194E base-mounted switches include standard interlock shaft; Bulletin 194E front-mounted switches include standard shaft.

Table of Contents

Product Selection..... this page
 Accessories..... 2-377
 Specifications..... 2-379
 Approximate
 Dimensions..... 2-381







Standards Compliance

IEC 207
 IEC 60947-1
 IEC 60947-3 Low-voltage
 switchgear and control gear part 3
 UL 508
 CSA C22.2, No. 14

Certifications

cULus Listed (Box Lug Version)
 (UL File No. E14841, Guide
 NLRV, NLRV7)
 UR Recognized (Bolt-on
 Version) (UL File No. E 14841
 NLRV2, NLRV8)
 CE

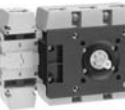
Bulletin 194E Switches — 125...315 A

OFF-ON Switch — with Box Lugs (UL Listed)		OFF-ON Switch — with Bolt-on Wiring (UR Recognized)	
 3-pole Base Mounted	 3-pole Front Mounted	 3-pole Base Mounted	 3-pole Front Mounted
 4-pole Base Mounted	 4-pole Front Mounted	 4-pole Base Mounted	 4-pole Front Mounted

Cat. No. Explanation

194E – A 125 – 1753
 a b c

a

Installation Type	
Code	Description
A	Base Mounting w/Box Lugs — UL Listed*
B	Base Mounting w/Bolt-on Wiring — UR Recognized*
E	Front Mounting w/Box Lugs — UL Listed
F	Front Mounting w/Bolt-on Wiring — UR Recognized

b

Load Size	
Code	Description
125	125 A
160	160 A
250	250 A
315	315 A

c

Configuration			
Code	Function	Description	Circuit Diagram Ref. No.
1753	OFF-ON	3-Pole, 2-position (90 degrees)	1753
1754	OFF-ON	4-Pole, 2-position (90 degrees)	1754

Frequently Ordered 194E Switches





(see Cat. No. Explanation for additional load sizes in 3- and 4-pole configurations)

Description	No. of Poles	Rated Current	AC23 Rated kw 690V AC 50 Hz	Hp @ 480V AC 60 Hz 3 Ø	Cat. No.	
Base-mounting switch w/ box lugs — 125 A	3	125	45	60	*	194E-A125-1753
Base-mounting switch w/ box lugs — 160 A		160	55	60	*	194E-A160-1753
Base-mounting switch w/ box lugs — 250 A		250	90	75	*	194E-A250-1753
Base-mounting switch w/ box lugs — 315 A	4	315	110	100	*	194E-A315-1754
Base-mounting switch w/ bolt-on wiring — 250 A	3	250	45	75	*	194E-B250-1753
Base-mounting switch w/ bolt-on wiring — 315 A		315	45	100	*	194E-B315-1753
Front-mounting switch w/ box lugs — 160 A		160	37	60		194E-E160-1753
Front-mounting switch w/ bolt-on wiring — 160 A	4	160	37	60		194E-F160-1754
Front-mounting switch w/ bolt-on wiring — 250 A		250	45	75		194E-F250-1754
Front-mounting switch w/ bolt-on wiring — 315 A		315	45	100		194E-F315-1754

* 20 cm shaft included with switch.

Accessories

Handles 194E - 125...315 A

Handles with Screw Fixing (Includes Legend Plate and Control Knob)	Degree of Protection	Color	Legend Plate Size	For Use With	Legend Marking	Cat. No.	
 Type A	IP65 (UL Type 3/3R/12)	Black/Grey	88 mm x 88 mm 3-15/32 in. x 3-15/32 in.	194E-125...315 A		194E-HE8A-175	
			130 mm x 130 mm 5-1/8 in. x 5-1/8 in.			194E-HE13A-175	
Red/Yellow		88 mm x 88 mm 3-15/32 in. x 3-15/32 in.	194E-HE8I-175				
		130 mm x 130 mm 5-1/8 in. x 5-1/8 in.	194E-HE13I-175				
 Type G		Black/Grey	90 mm x 90 mm 3-35/64 in. x 3-35/64 in.			194E-125...315 A	194E-HE8G-175
			135 mm x 135 mm 5-5/16 in. x 5-5/16 in.				194E-HE13G-175
 Type N		Red/Yellow	90 mm x 90 mm 3-35/64 in. x 3-35/64 in.				194E-HE8N-175
			135 mm x 135 mm 5-5/16 in. x 5-5/16 in.				194E-HE13N-175

2

Accessories 194E - 125...315 A

Auxiliary Contacts - 2 N.O. / 1 N.C.	For Use With	Cat. No.
	194E-A125-160,194E-B125-160	194E-AB-P21-160
	194E-A250-315,194E-B250-315	194E-AB-P21-315
	194E-E125-160,194E-F125-160	194E-EF-P21-160
	194E-E250-315,194E-F250-315	194E-EF-P21-315

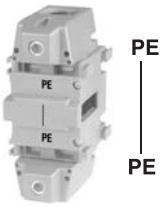
Earthing/Grounding Terminal	For Use With	Cat. No.
	194E-A125-160,194E-E125-160	194E-AE160-PE
	194E-A250-315,194E-E250-315	194E-AE315-PE
	194E-B125-160,194E-F125-160	194E-BF160-PE
	194E-B250,194E-F250	194E-BF250-PE
	194E-B315,194E-F315	194E-BF315-PE

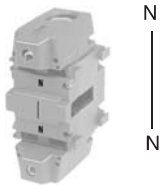
Neutral Terminal	For Use With	Cat. No.
	194E-A125-160,194E-E125-160	194E-AE160-TN
	194E-A250-315,194E-E250-315	194E-AE315-TN
	194E-B125-160,194E-F125-160	194E-BF160-TN
	194E-B250,194E-F250	194E-BF250-TN
	194E-B315,194E-F315	194E-BF315-TN

IEC Load Switches

Accessories, Continued

Shaft Extension	Length	For Use With	Cat. No.
	40 cm	194E-A or 194E-B 125...315 A Base-Mounted Switches	194E-AB40

2

Terminal Cover	For Use With		Cat. No.
	194E-A125-160 194E-E125-160	2 covers per pole	194E-AE125-C1
	194E-A250-315 194E-E250-315	2 covers per pole	194E-AE250-C1
	194E-B125-160 194E-F125-160	2 covers per pole	194E-BF125-C1
	194E-B250-315 194E-F250-315	2 covers per pole	194E-BF250-C1

Legend

Additional Name Plate and Frame

	Color	Legend Size	For Use With	Legend Marking	Pkg. Qty.	Cat. No.
	Black/Grey	18 mm x 84 mm 11/16 in. x 3-5/16 in.	Size 8 Type G and N Style Handles, Cat. Nos. 194L-HE8G/N 88 mm x 88 mm 90 mm x 90 mm 130 mm x 130 mm 135 mm x 135 mm legend frames	MAIN SWITCH	5	194L-G3515A
				HAUPTSCHALTER		194L-G3515B
	INTERR. PRINCIPALE			194L-G3515C		
	INTERR. PRINCIPAUX			194L-G3515D		
	INTERR. PRINCIPAL			194L-G3515E		
	HUVUDBRYTARE			194L-G3515F		
	WAHLSCHALTER			194L-G3515G		
	EMERGENCY OFF			194L-G3515H		
Red/Yellow						



Specifications

IEC Performance Data for 194E

		194E-125	194E-160	194E-250	194-315	
Rated insulation voltage U_i : *	[V]	1000	1000	1000	1000	
Rated impulse withstand voltage U_{imp}	[kV]	8	8	8	8	
Test voltage 1 min	[kV]	3.5	3.5	3.5	3.5	
Rated voltage U_e **	[V]	1000	1000	1000	1000	
Rated frequency	[Hz]	50/60	50/60	50/60	50/60	
Rated thermal current I_{th} open	[A]	125	160	250	315	
Rated thermal current I_{the} enclosed	[A]	125	160	250	315	
Rated current I_e						
AC-1 / Non-inductive or slightly induct. load						
AC-21A Switching of resistive loads with slight overload	[A]	125	160	250	315	
Rated power P_e						
AC-23A Occasional switching of motor and other highly inductive loads	230V	[kW]	30	30	37	55
	400V	[kW]	45	55	90	110
	690V	[kW]	37	37	45	45
AC-3 Squirrel-cage motors: starting and stopping of running motors	230V	[kW]	22	30	37	45
	400V	[kW]	37	45	55	75
	690V	[kW]	30	37	45	45
Conditional rated short-circuit current	400/415V	[kA]	30	30	30	30
Max. fuse rating of circuit (type gG)		[A]	125	160	250	315
Rated short-time current I_{cw} 1S		[A]	2500	3000	4600	5800
Rated breaking capacity	230V	[A]	800	900	1600	1800
	400V	[A]	750	850	1380	1650
AC-23A (cos ϕ 0.45)	690V	[A]	340	340	400	400

* Valid for line with grounded common neutral termination, overvoltage category III, pollution degree 3. Other values on request.

** Not suitable for load-switching applications (AC-20A) above 690V.

DC Switching Capacity

		194E-125	194E-160	194E-250	194E-315
Rated current I_e	Rated voltage [V] No. Poles in series				
DC-21A	60 3 [A]	125	160	250	315
For resistive loads $T \leq 1$ ms	110 3 [A]	110	140	220	280
	220 3 [A]	45	55	85	110
	Rated voltage [V] No. Poles in series				
	110 4 [A]	125	160	250	315
	220 4 [A]	80	100	150	200
	440 4 [A]	16	20	32	40
Rated power P_e	Rated voltage [V] No. Poles in series				
DC-22A, DC-3	24 4 [kW]	3	3.8	6	7.5
For Inductive loads $T \leq 2.5$ ms	48 4 [kW]	6	7.5	12	15
	60 4 [kW]	7.5	9.5	15	19
	110 4 [kW]	10	12.5	20	25
	220 4 [kW]	4.5	5.5	8	10
Rated Power P_e	Rated voltage [V] No. Poles in series				
DC-23A, DC-5	24 4 [kW]	3	3.8	6	7.5
For Inductive loads $T \leq 15$ ms	48 4 [kW]	6	7.5	12	15
	60 4 [kW]	7.5	9.5	15	19
	110 4 [kW]	8.8	11	17.5	22
	220 4 [kW]	2.5	3.5	5.5	7

Bulletin 194E
IEC Load Switches
 Specifications, Continued

UL CSA Performance Data for 194E

			194E-125	194E-160	194E-250	194E-315
Rated Insulation Voltage	[V]		600	600	600	600
Rated voltage	[V]		600	600	600	600
Continuous current	[A]		150	200	250	300
Ampere rating for general use	[A]		150	200	250	300
Heavy Pilot Duty	[AC]					
Standard Duty	[DC]					
Motor rating 60Hz						
1-phase (2 poles)	120V, 1 P	[FLA]	80	100	135	180
		[Hp]	7.5	10	15	20
	240V, 1 P	[FLA]	88	110	136	155
		[Hp]	20	25	30	35
	480V, 1 P	[FLA]	78	88	99	108
		[Hp]	35	40	45	50
3-Phase	600V, 1 P	[FLA]	62	70	86	104
		[Hp]	35	40	50	60
	120V, 3 P	[FLA]	84	108	160	208
		[Hp]	15	20	30	40
	240V, 3 P	[FLA]	8	104	154	192
		[Hp]	30	40	60	75
3-Phase	480V, 3 P	[FLA]	77	77	96	124
		[Hp]	60	60	75	100
	600V, 3 P	[FLA]	62	62	77	99
		[Hp]	60	60	75	100

Mechanical Data

			194E-125	194E-160	194E-250	194E-315
Handles			IP66	IP66	IP66	IP66
Protection class according to IEC 529			—	—	—	—
Front side Front unit			IP66	IP66	IP66	IP66
Box lugs*			IP20	IP20	IP20	IP20
Bolt-on	straight version*		IP20	IP20	IP20	IP20
	bent version		—	—	—	—
Mechanical life		[Million operations]	0.1	0.1	0.075	0.075
Box lugs — max. wire gauges			—	—	—	—
Terminal sizes according to IEC 947-1		Gauge No.	B11	B11	B14	B14
Fine strands, 1 conductor	Max.	mm ²	70	70	150	150
	Min.	mm ²	16	16	25	25
Rigid wire, 1 conductor	Max.	mm ²	95	95	185	185
	Min.	mm ²	10	10	16	16
Wire gauges according to UL/CSA	Max.	AWG	3/0	3/0	—	—
		MCM	—	—	350	350
	Min.	AWG	8	8	4	4

* When provided with terminal covers.

Certifications

Catalog No. or Designation		UL-Listed (marked with UL)	UR-Recognized (marked with UR)	UL-Listed for Canada (marked with cUL)	UR-Recognized for Canada (marked with cUR)	CE
194E-A125	194E-E125	A	—	A	—	A
194E-A160	194E-E160	A	—	A	—	A
194E-A250	194E-E250	A	—	A	—	A
194E-A315	194E-E315	A	—	A	—	A
194E-B125	194E-F125	—	A	—	A	A
194E-B160	194E-F160	—	A	—	A	A
194E-B250	194E-F250	—	A	—	A	A
194E-B315	194E-F315	—	A	—	A	A
Aux. switch blocks		Z	Z	Z	Z	Z
Ground terminal		Z	Z	Z	Z	Z
Neutral terminal		Z	Z	Z	Z	Z

A = Certified

Z = accessories are covered by the approval for the switch

Dimensions are shown in millimeters (inches). Dimensions are not intended to be used for manufacturing purposes.

Front-Installation Box Lugs, 3- and 4-Pole

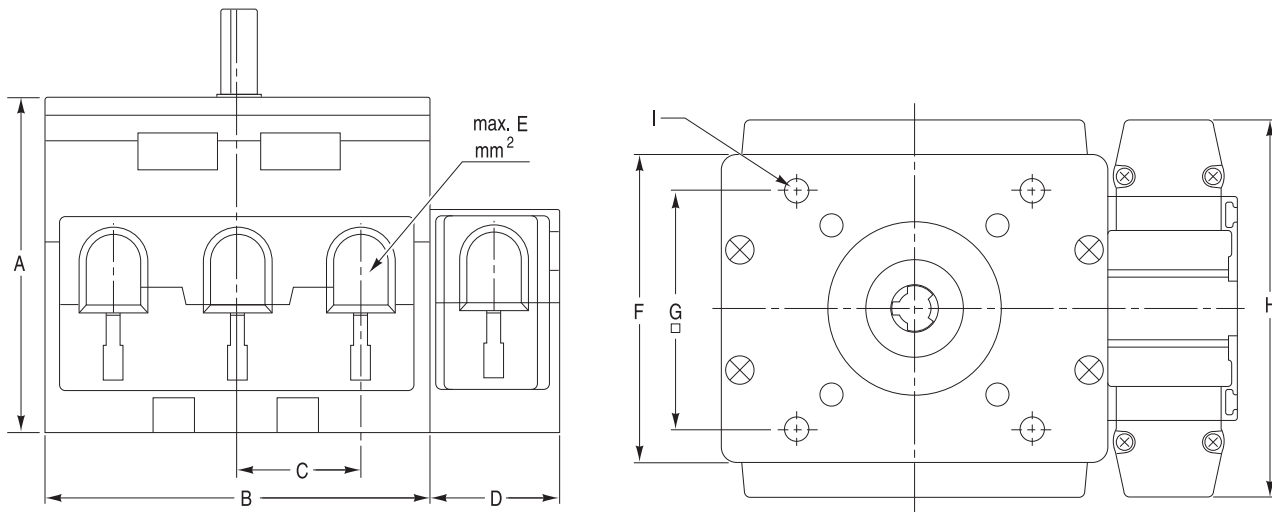

Switch Body 194E-E

[A]	A	B	C	D	E	F	G	H	I*
125	91 (3-19/32)	112 (4-13/32)	36 (1-13/32)	38 (1-1/2)	95 (3-23/64)	88 (3-7/16)	68 (2-11/16)	108 (4-1/4)	M5*
160	91 (3-19/32)	112 (4-13/32)	36 (1-13/32)	38 (1-1/2)	95 (3-23/64)	88 (3-7/16)	68 (2-11/16)	108 (4-1/4)	M5*
250	103 (4-3/64)	145 (5-23/32)	44 (1-23/32)	52.5 (2-1/16)	185 (7-9/32)	88 (3-7/16)	68 (2-11/16)	120 (4-11/16)	M5*
315	103 (4-3/64)	145 (5-23/32)	44 (1-23/32)	52.5 (2-1/16)	185 (7-9/32)	88 (3-7/16)	68 (2-11/16)	120 (4-11/16)	M5*

* M5 x 0.8 bolts supplied with switch. Threaded hole.

Front-Installation Bolt-on Terminals, 3- and 4-Pole

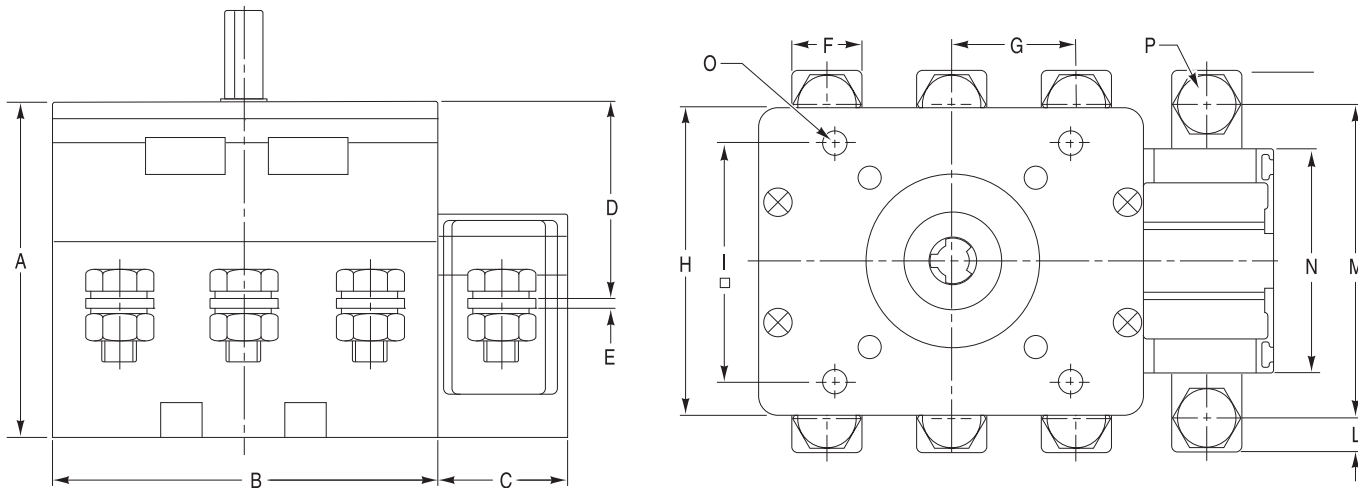

Switch Body 194E-F

[A]	A	B	C	D	E	F	G	H	I	L	M	N	O*	P*
125	91 (3-19/32)	112 (4-3/32)	38 (1-1/2)	65.5 (2-9/16)	3 (1/8)	2 (3/32)	36 (1-13/32)	88 (3-7/16)	68 (2-11/16)	10 (13/32)	90 (3-17/32)	64 (2-17/32)	M5*	M10*
160	91 (3-19/32)	112 (4-3/32)	38 (1-1/2)	65.5 (2-9/16)	3 (1/8)	2 (3/32)	36 (1-13/32)	88 (3-7/16)	68 (2-11/16)	10 (13/32)	90 (3-17/32)	64 (2-17/32)	M5*	M10*
250	103 (4-3/64)	145 (5-23/32)	52.5 (1-22/32)	60.4 (2-3/8)	4 (5/32)	2 (3/32)	44 (1-23/32)	88 (3-7/16)	68 (2-11/16)	13 (1/2)	100 (3-15/16)	70 (2-3/4)	M5*	M12*
315	103 (4-3/64)	145 (5-23/32)	52.5 (1-22/32)	60.4 (2-3/8)	4 (5/32)	2 (3/32)	52 (2-1/16)	88 (3-7/16)	68 (2-11/16)	13 (1/2)	100 (3-15/16)	70 (2-3/4)	M5*	M12*

* M5 x 0.8 bolts supplied with switch. Threaded hole.
 * Bolts and nuts supplied with switch. Through-hole.

IEC Load Switches

Approximate Dimensions, Continued

Dimensions are shown in millimeters (inches). Dimensions are not intended to be used for manufacturing purposes.

Base-Mounting Box Lugs, 3- and 4-Pole

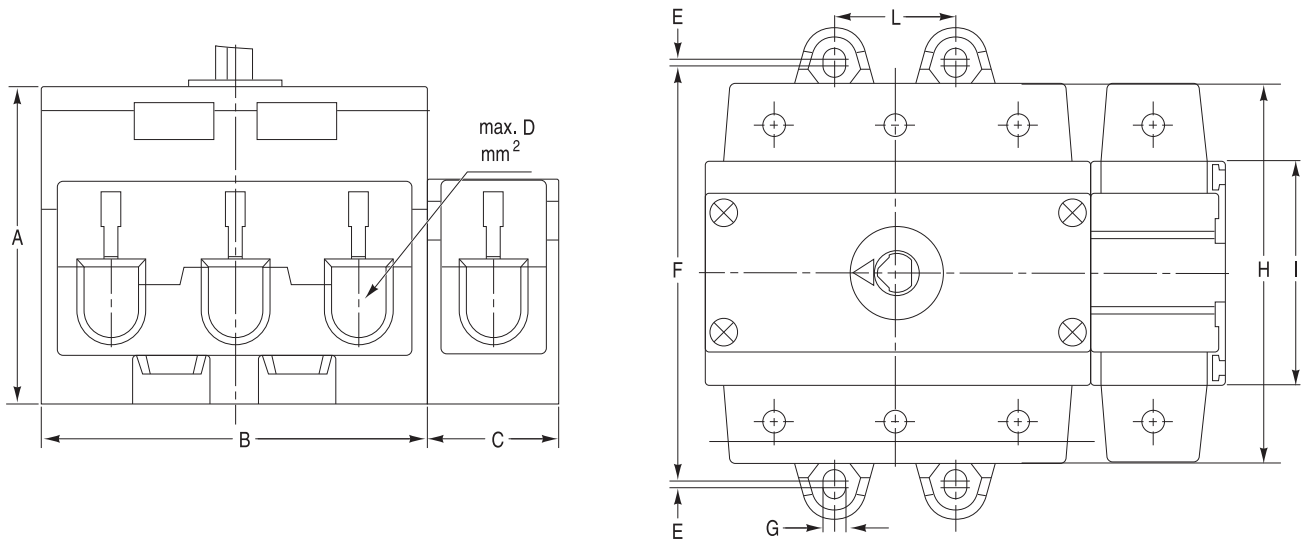

Switch Body 194E-A

[A]	A	B	C	D	E	F	G	H	I	L
125	91 (3-19/32)	112 (4-13/32)	38 (1-1/2)	95 (3-23/64)	2 (3/32)	118 (4-5/8)	6.4 (1/4)	108 (4-1/4)	64 (2-17/32)	36 (1-13/32)
160	91 (3-19/32)	112 (4-13/32)	38 (1-1/2)	95 (3-23/64)	2 (3/32)	118 (4-5/8)	6.4 (1/4)	108 (4-1/4)	64 (2-17/32)	36 (1-13/32)
250	98 (3-27/32)	145 (5-23/32)	52.5 (1-23/32)	185 (7-9/32)	2 (3/32)	140 (5-1/2)	6.4 (1/4)	126 (4-15/16)	70 (2-3/4)	44 (2-1/16)
315	98 (3-27/32)	145 (5-23/32)	52.5 (1-23/32)	185 (7-9/32)	2 (3/32)	140 (5-1/2)	6.4 (1/4)	126 (4-15/16)	70 (2-3/4)	44 (2-1/16)

Base-Mounting Bolt-on Terminals, 3- and 4-Pole

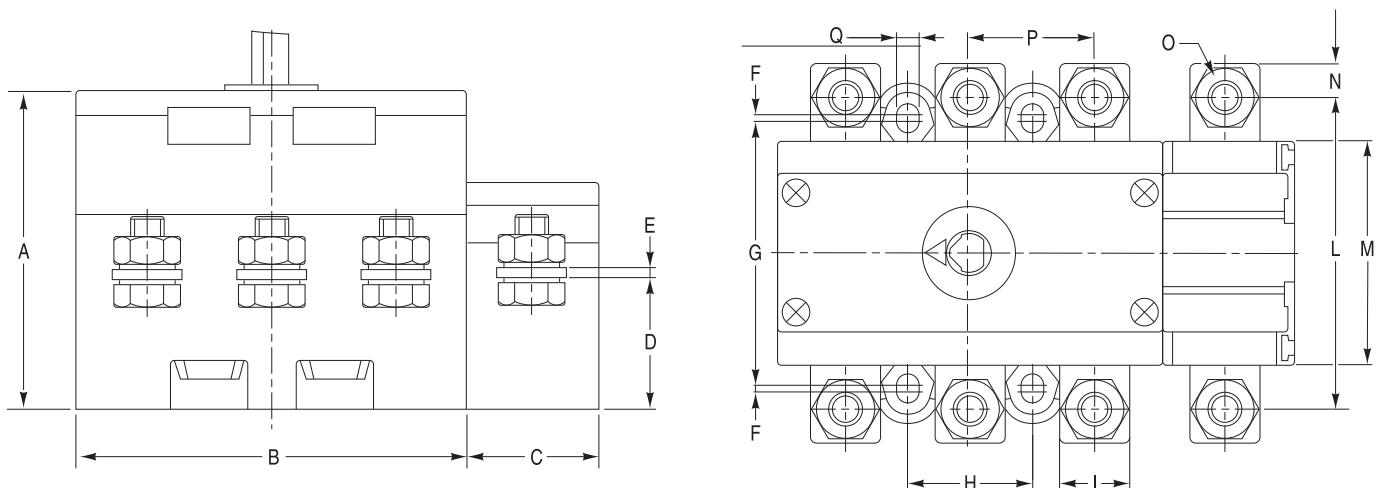

Switch Body 194E-B

[A]	A	B	C	D	E	F	G	H	I	L	M	N	O	P	Q
125	91 (3-19/32)	112 (4-3/32)	38 (1-1/2)	36.5 (1-7/16)	3 (1/8)	2 (3/32)	76 (3)	36 (1-13/32)	20 (3/4)	90 (3-17/32)	64 (2-17/32)	10 (13/32)	M10 (3/8)	36 (1-13/32)	6.4 (1/4)
160	91 (3-19/32)	112 (4-3/32)	38 (1-1/2)	36.5 (1-7/16)	3 (1/8)	2 (3/32)	76 (3)	36 (1-13/32)	20 (3/4)	90 (3-17/32)	64 (2-17/32)	10 (13/32)	M10 (3/8)	36 (1-13/32)	6.4 (1/4)
250	98 (3-27/64)	145 (5-23/32)	52.5 (1-22/32)	38.6 (1-1/2)	4 (5/32)	2 (3/32)	80 (3-1/8)	44 (1-23/32)	26 (1-1/64)	100 (3-15/16)	70 (2-3/4)	13 (1/2)	M12 (15/32)	44 (1-23/32)	6.4 (1/4)
315	98 (3-27/64)	145 (5-23/32)	52.5 (1-22/32)	38.6 (1-1/2)	4 (5/32)	2 (3/32)	80 (3-1/8)	44 (1-23/32)	26 (1-1/64)	100 (3-15/16)	70 (2-3/4)	13 (1/2)	M12 (15/32)	52 (2-1/16)	6.4 (1/4)

Dimensions are shown in millimeters (inches). Dimensions are not intended to be used for manufacturing purposes.

Box Ground and Neutral Terminal

2

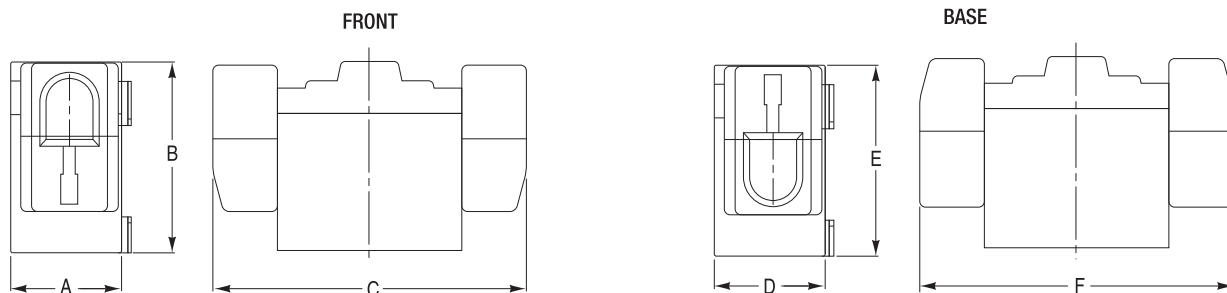

Switch Body 194E-F

[A]	A	B	C	D	E	F
125	37.8 (1-1/2)	64 (2-17/32)	108 (4-1/4)	37.8 (1-1/2)	64 (2-17/32)	108 (4-1/4)
160	37.8 (1-1/2)	64 (2-17/32)	108 (4-1/4)	37.8 (1-1/2)	64 (2-17/32)	108 (4-1/4)
250	52.3 (2-1/16)	71.1 (2-25/32)	126 (4-15/16)	52.3 (2-1/16)	80.6 (3-1/8)	126 (4-15/16)
315	52.3 (2-1/16)	71.1 (2-25/32)	126 (4-15/16)	52.3 (2-1/16)	80.6 (3-1/8)	126 (4-15/16)

Bolt Ground and Neutral Terminal

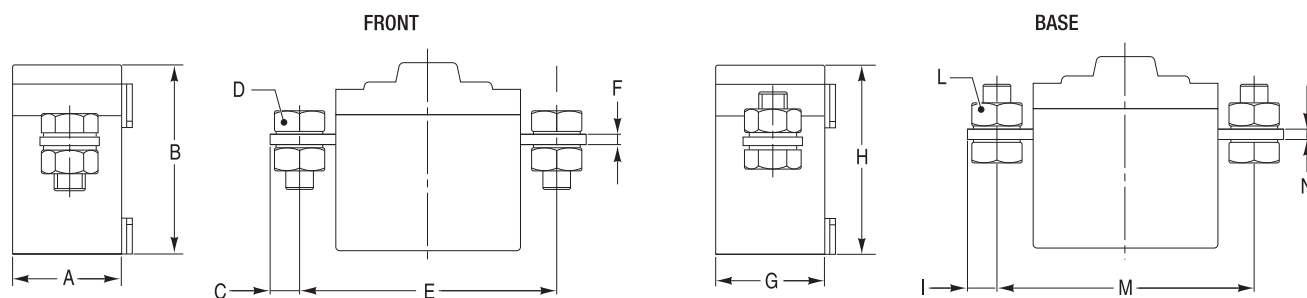

Switch Body 194E-F

[A]	A	B	C	D	E	F	G	H	I	L	M	N
125	37.8 (1-1/2)	64 (2-17/32)	10 (13/32)	M10 (13/32)	90 (3-17/32)	3 (1/8)	37.8 (1-1/2)	64 (2-17/32)	10 (13/32)	M10 (13/32)	90 (3-17/32)	3 (1/8)
160	37.8 (1-1/2)	64 (2-17/32)	10 (13/32)	M10 (13/32)	90 (3-17/32)	3 (1/8)	37.8 (1-1/2)	64 (2-17/32)	10 (13/32)	M10 (13/32)	90 (3-17/32)	3 (1/8)
250	52.3 (2-1/16)	68 (2-21/32)	13 (1/2)	M12 (15/32)	100 (3-15/16)	4 (5/32)	52.3 (2-1/16)	68 (2-21/32)	13 (1/2)	M12 (15/32)	100 (3-15/16)	4 (5/32)
315	52.3 (2-1/16)	68 (2-21/32)	13 (1/2)	M12 (15/32)	100 (3-15/16)	4 (5/32)	52.3 (2-1/16)	68 (2-21/32)	13 (1/2)	M12 (15/32)	100 (3-15/16)	4 (5/32)

Auxiliary Contacts

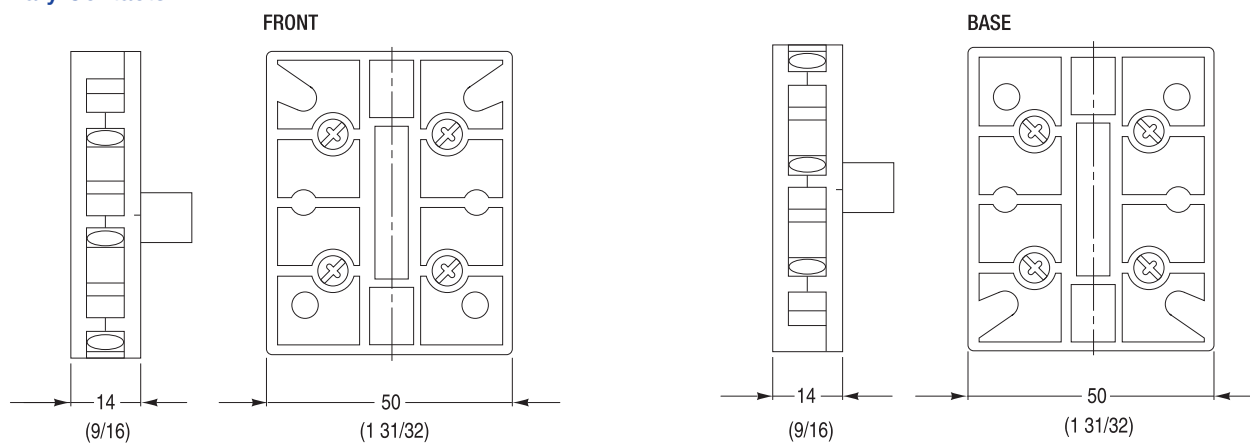

IEC Load Switches

Approximate Dimensions, Continued

Dimensions are shown in millimeters (inches). Dimensions are not intended to be used for manufacturing purposes.

Terminal Cover

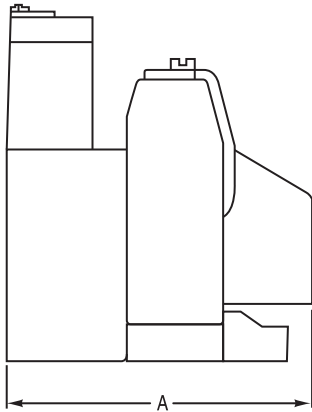

Switch Body 194E-F

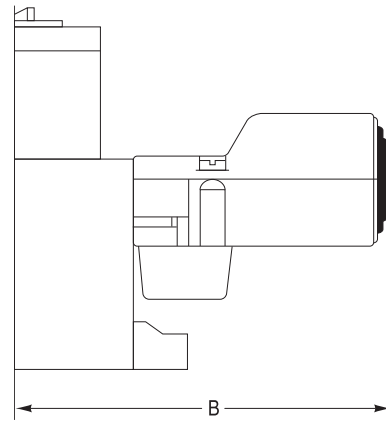

[A]	A	B
125	76.2 (3)	95 (3-3/4)
160	76.2 (3)	95 (3-3/4)
250	88 (3-15/32)	109.5 (4-5/16)
315	88 (3-15/32)	109.5 (4-5/16)

Door Clutches

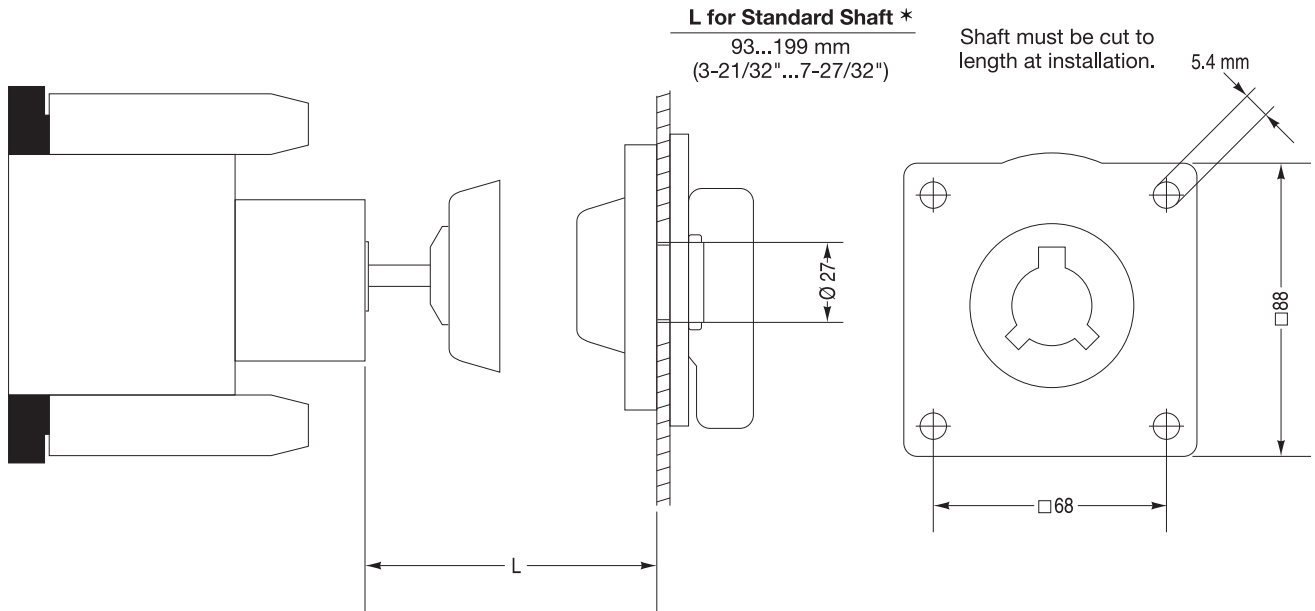

* Use Cat. No. 194E-AB40 shaft extension accessory to extend beyond the standard shaft length.

Dimensions are shown in millimeters (inches). Dimensions are not intended to be used for manufacturing purposes.

Handles (Type 194E-HE-8A-8I-8G-8N)

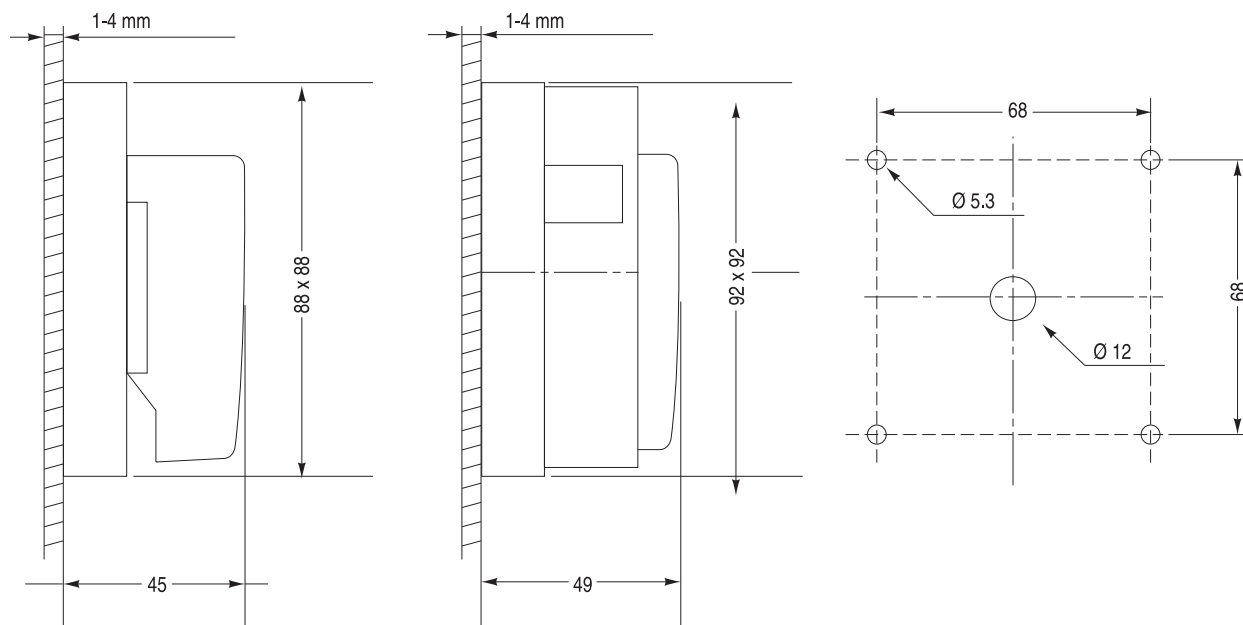

2

Handles (Type 194E-HE-13A-13I-13G-13N)

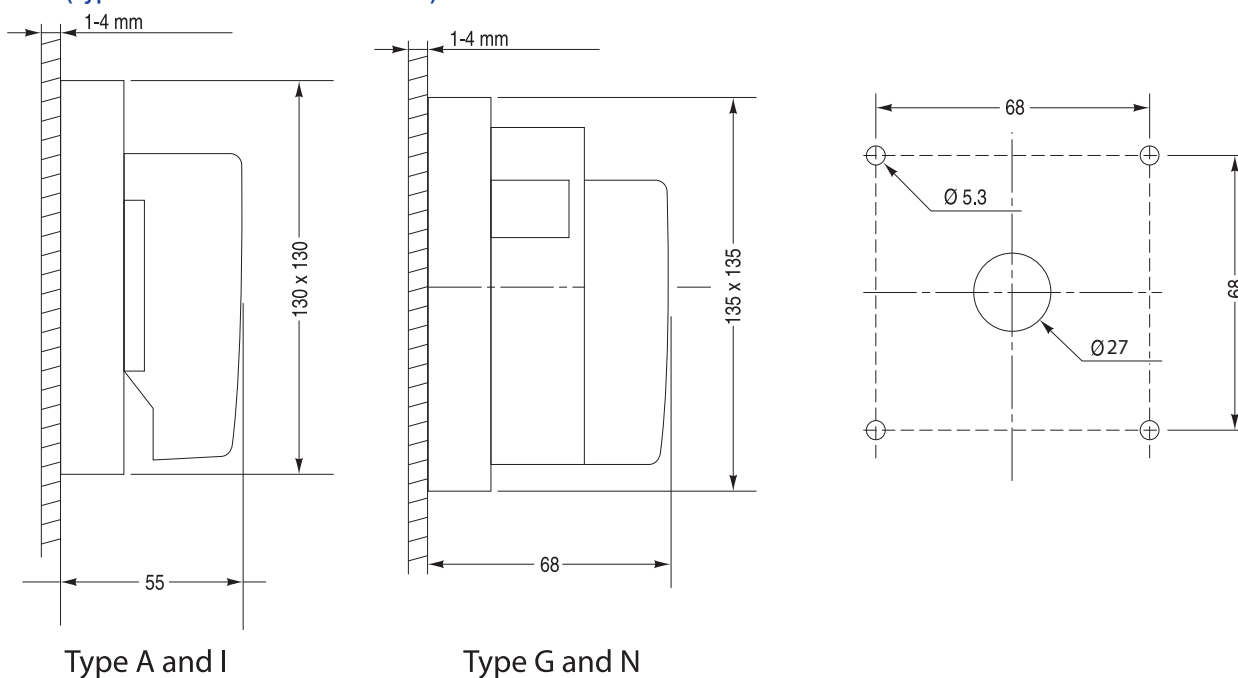

Type A and I

Type G and N

Additional Name Plate

Frame and legend snaps on to handle bezel. Fits size 8 and 13 handles.

