

Bulletin 193-T1
Bimetallic Overload Relays
 Product Selection

Thermal Overload Relays

For Use With*	Setting Range [A]‡	Max. Back-up fuse [A]			Cat. No.
		gL/gG		UL Class K5	
		50 kA, 690V AC		5 kA, 600V AC	
		IEC/EN 60947-4-1 Coordination			
		Type 1	Type 2	UL 508	
100-C09...100-C23	0.1...0.16	50	—	1	193-T1AA16
	0.16...0.25	50	—	1	193-T1AA25
	0.25...0.40	50	2	1	193-T1AA40
	0.35...0.50	50	2	2	193-T1AA50
	0.45...0.63	50	2	2	193-T1AA63
	0.55...0.80	50	4	3	193-T1AA80
	0.75...1.0	50	4	3	193-T1AB10
	0.90...1.3	50	6	4	193-T1AB13
	1.1...1.6	50	6	5	193-T1AB16
	1.4...2.0	50	10	8	193-T1AB20
	1.8...2.5	50	16	10	193-T1AB25
	2.3...3.2	50	16	12	193-T1AB32
	2.9...4.0	50	16	15	193-T1AB40
	3.5...4.8	50	16	15	193-T1AB48
	4.5...6.3	50	20	20	193-T1AB63
5.5...7.5	50	25	25	193-T1AB75	
7.2...10	50	25	35	193-T1AC10	
9.0...12.5	50	35	50	193-T1AC12	
100-C12...100-C23	11.3...16	50	35	60	193-T1AC16
100-C16...100-C23	15...20	80	40	80	193-T1AC20
	17.5...21.5	80	50	80	193-T1AC21
100-C23	21...25	80	50	100	193-T1AC25
100-C30...100-C37	15...20	80	40	80	193-T1BC20
	17.5...21.5	80	50	80	193-T1BC21
	21...25	80	50	100	193-T1BC25
	24.5...30	100	63	100	193-T1BC30
	29...36	125	63	125	193-T1BC36
100-C37	33...38	125	63	150	193-T1BC38
100-C43	17...25	100	50	100	193-T1CC25
	24.5...36	125	80	125	193-T1CC36
	35...47	160	100	175	193-T1CC47
100-C60...100-C97	35...47	160	100	175	193-T1DC47
	45...60	200	125	250§	193-T1DC60
100-C72...100-C97	58...75	200	125	300§	193-T1DC75
100-C85...100-C97	72...90	250	160	350§	193-T1DC90
Separate mounting required (Panel-mounted device)	35...47	160	100	175	193-T1DC47P
	45...60	200	125	250§	193-T1DC60P
	58...75	200	125	300§	193-T1DC75P
	72...90	250	160	350§	193-T1DC90P

* Bulletin 193-T1 overload relays shall not be used with 100-C09...100-C43 conventional DC coil-controlled contactors. Use electronic controlled DC coil versions.

‡ To select the setting range for use in Y-Δ Starters, multiply the rated operating current of the motor by a factor of 0.58.







‡ For motors with service factor of 1.15 or greater, use motor nameplate full load current. For motors with service factor of 1.0, use 90% of the motor nameplate full load current.

§ Max. Back-up fuse [A], UL Class K5, 10 kA, 600V AC



	<p>Bulletin 193-T1 — Bimetallic Overload Relays</p> <ul style="list-style-type: none"> Overload protection trip class 10 / 10A Phase loss protection Ambient temperature compensation Auxiliary contacts (1 N.O. and 1 N.C.) Manual/automatic reset mode selectable Test function for auxiliary contacts Stop button Trip indicator Optional remote reset solenoid and external reset accessories <p>The 193-T1 bimetallic overload relays are ambient temperature compensated, ensuring that the tripping characteristic of the relay remains constant over an ambient temperature range of -20...+60 °C. These class 10 / 10A overload relays include a differential mechanism for high sensitivity to phase loss conditions and provide reliable motor protection in normal duty applications. In addition, they can be used to protect against overloads in DC-motor and variable frequency drive applications.</p>	<p>Table of Contents</p> <p>Product Selection 1</p> <p>Accessories..... 2</p> <p>Specifications..... 3</p> <p>Approximate Dimensions..... 7</p> <p>Standards Compliance</p> <p>IEC/EN 60497-1, -4-1, -5-1 UL508 CSA C22.2 No.14</p> <p>Certifications</p> <p>cULus (File No. E33916, Guide NKCR, NKCR7), CE marked</p>
---	---	--

Add-On Modules

	Description	For Use With	Pkg. Quantity *	Cat. No.
	DIN Rail/Panel Mounting Adapter For separate mounting of overload relays Snaps on to 35 mm top hat rail	193-T1AA, 193-T1AB, 193-T1AC, 193-T1BC	1	193-T1APM
	Screw Adapter For screw fixing of the 193-T1APM panel adapter (1 required per adapter)	193-T1APM	10	140M-C-N45
	Remote Reset Solenoid For remote reset of 193-K and 193-T1 overload relays	193-K, 193-T1 (not for 193-T1DC_P)	1	193-T1R⊗
	External Reset Button For enclosed, through-the-door reset applications. Metal construction, IP66, non-illuminated. Refer to the 800F selection information for additional types.	All	1	800FM-R611
	Reset Rod Length 142 mm, adjustable range 141...159 mm	All	1	800F-ATR08
	Reset Adapter Expands the reset target area when using an external reset	193-K, 193-T1 (not for 193-T1DC_P)	1	193-RA3



* Must be ordered in multiples of package quantity.

⊗ **Coil Voltage Codes for Remote Reset Solenoid**

[M]	24	48	110	120	125	220...240
50 Hz	—	—	D	—	—	—
60 Hz	—	—	—	D	—	—
50/60 Hz	KJ	KY	—	—	—	KF
DC	ZJ	ZY	ZD	—	ZS	—

Marking System

Uniform labeling materials for contactors, motor starting equipment, timing relays, and circuit breakers

	Description	Pkg. Quantity*	Cat. No.
	Label Sheet 105 self-adhesive paper labels each, 6 x 17 mm	10	100-FMS
	Marking Tag Sheet 160 perforated paper labels each, 6 x 17 mm, to be used with a transparent cover	10	100-FMP
	Transparent Cover To be used with marking tag sheets	100	100-FMC

* Must be ordered in multiples of package quantities.

Thermal Overload Relays







Main Circuits

Cat. No.		193-T1...	
Rated isolation voltage U_i		690V AC	
Rated impulse withstand voltage U_{imp} (between main poles and between main poles and auxiliary circuits)		6kV AC	
Rated impulse withstand voltage U_{imp} (between auxiliary circuits)		4kV AC	
Rated operating voltage U_e	IEC	690V AC	440V DC
	UL, CSA	600V AC	
Rated frequencies		[Hz]	50/60
Operational frequencies		DC...400 Hz	
Power dissipation	193-T1A, 193-T1B	up to 0.4 A	7 W
		0.5...36 A	6 W
		38 A	12 W
	193-T1C	25...47 A	12 W
	193-T1D	47...90 A	18 W

Control Circuits

Cat. No.		193-T1...	
Rated operating current I_e			
AC-15	24V	[A]	4
	240V	[A]	2
	400V	[A]	1.6
	690V	[A]	0.15
DC-13	24V	[A]	2
	110V	[A]	0.4
	220V	[A]	0.25
	440V	[A]	0.08
Thermal Current I_{th}			5
Short-circuit withstand, Fuse	IEC, gL/gG	[A]	6
Short-circuit withstand, circuit breaker \leq 1 kA prospective short-circuit-current			4
Min. contact load for reliable operation			15V, 2 mA
UL Rating			A600/Q300

Terminations

Cat. Nos.	Main Circuits						Control Circuits	Remote Reset		
	193-T1A...	193-T1BC20... T1BC25	193-T1BC30... T1BC38	193-T1C...	193-T1D...	193-T1APM	193-T1... all	193-T1R...		
Wiring cross section Terminal type										
Terminal screws	M4	M4	M4	M5	M6	M4	M3.5	M3.5		
	Fine stranded with ferrule	1 conductor [mm ²]	1.5...4	1.5...4	2.5...10	2.5...16	10...35	1.5...10	1...2.5	
		2 conductors [mm ²]	1.5...4	1.5...4	-	-	-	-	1...4	-
	Solid or coarse stranded	1 conductor [mm ²]	1.5...6	1.5...6	2.5...16	2.5...25	10...35	1.5...16	1...2.5	
		2 conductors [mm ²]	1.5...6	1.5...6	-	-	-	-	1...4	-
		1 conductor [AWG]	No. 16...10	No. 14...10	No. 10...6	No. 10...6	No. 8...1	No. 16...6	No. 18...12	No. 16...12
		2 conductors [AWG]	No. 16...10	No. 14...10	-	-	-	-	No. 18...12	-
Recommended torque	[N•m]	1.5 ... 2.2	1.5 ... 2.2	2.5 ... 3.5	2.5 ... 3.5	4.5 ... 6	1.8...2.8	1.2	1.2	
	[lb•in]	13 ... 20	13 ... 20	22 ... 31	22 ... 31	40 ... 53	16...25	10.6	10.6	
Pozidrive screwdriver No.	Size	2	2	2	2	-	2	2	2	
Slotted screwdriver	[mm]	0.8 x 5.5	0.8 x 5.5	0.8 x 5.5	0.8 x 5.5	-	0.8 x 5.5	0.8 x 5.5	0.8 x 5.5	
Hexagon socket screw	Size	-	-	-	-	4	-	-	-	

Bulletin 193-T1
Bimetallic Overload Relays
 Specifications

193-T1R Remote Reset

Operating Limits		
Maximum Command Impulse		5s
AC 50/60 Hz	Pick-up [$x U_s$]	0.8...1.1
	Drop-out [$x U_s$]	
DC	Pick-up [$x U_s$]	0.7...1.25
	Drop-out [$x U_s$]	
Coil Consumption		
AC 50/60 Hz	Pick-up [VA/W]	
	Hold-in [VA/W]	
DC	Pick-up [W]	17 (24, 110, 125V) 25 (48V)
	Hold-in [W]	17 (24, 110, 125V) 25 (48V)

General

Cat. No.		193-T1...	
Type of Overload Relay	Bimetallic, Ambient Compensated, Phase Loss Sensitive		
Trip Rating (ultimate tripping current)	120% FLA		
Phase loss sensitivity: Trip rating at phase loss	115% FLA		
Trip Class		193-T1A/-T1B	193-T1C/-T1D
		10A	10
	IEC/EN 60947-4-1		
	UL		
Reset Mode	Automatic or Manual		
Test release	Manual release of auxiliary contacts		
Trip indication	By means of a flag visible through an opening in the relay front		
Compensation temperature range	-20...+60 °C (-4...+140 °F)		
Climatic Conditions	Release Tolerance at -20 °C	1.05...1.4 $x I_n$	
	Storage Temperature Range	-55...+80 °C (-67...+176 °F)	
	Operating Temperature Range	-20...+60 °C (-4...+140 °F)	
	Air moisture (Storage/Operating)	5...95% rel.humidity, non-condensing	
Vibration	(per IEC/EN 60068-2-6), service	3g	
	IEC/EN 61373 (vibration railways)	category 1, class B	
Shock	IEC/EN 60092-504 (vibration ships), service	0.7 g, all axes, 2...200 Hz	
	(per IEC/EN 68000-2-27), transport	30 g	
	IEC/EN 60068-2-27 (Shock half-sinus), service	11 ms > 5 g all axes	
	IEC/EN 61373 (shock railways)	category 1, class B, 5g 30 ms	
Max. Altitude	2000 m		
Pollution Degree	3		
Degree of Protection, with wires connected	IP2X		
Approximate Weight (unpacked)	193-T1A, 193-T1B	0.16...25 A	0.115 kg
	193-T1B	30...38 A	0.155 kg
	193-T1C	25...47 A	0.330 kg
	193-T1D	47...90 A	0.360 kg
	193-T1...P	47...90 A	0.415 kg
Standards	IEC/EN 60497-1, -4-1, -5-1, UL508, CSA C22.2 No.14		
Certifications	CE, cULus		

2

Circuit Diagrams

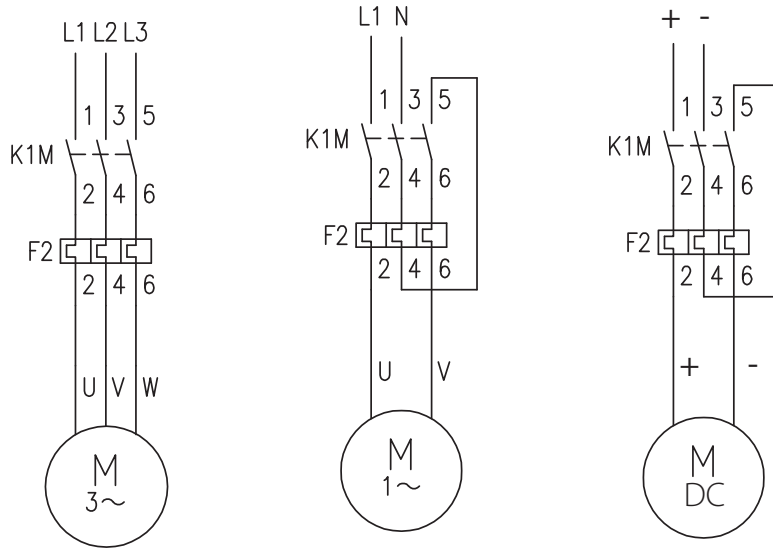

Wiring Schematic

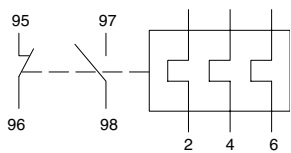

Typical IEC Wiring Schematic

Trip Characteristics

These trip characteristics refer to IEC/EN 60947-4-1 and are average values from cold start at an ambient temperature of 20 °C. Trip time is pictured as a function of operating current. With the device at max. operating temperature, the trip time decreases to approximately 25% of the shown value.

- (a) Tripping characteristics 3-poles from the cold state
- (b) Tripping characteristics 2-poles from the cold state

Cat. Nos. 193-T1AA16...AA40 Overload Relays

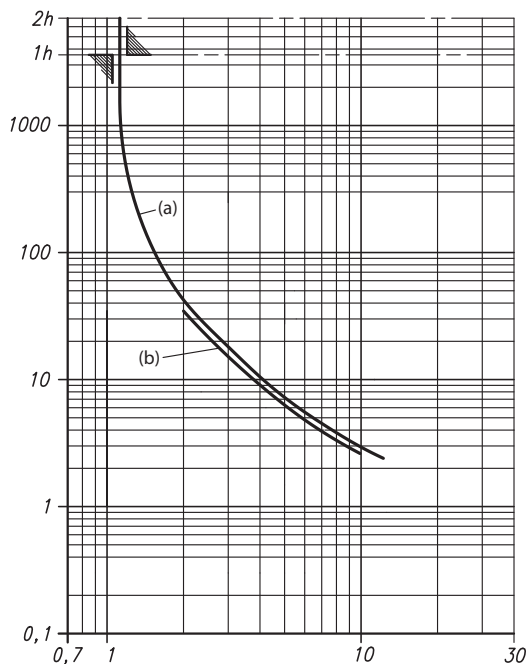

Cat. Nos. 193-T1AA50...AB40 Overload Relays

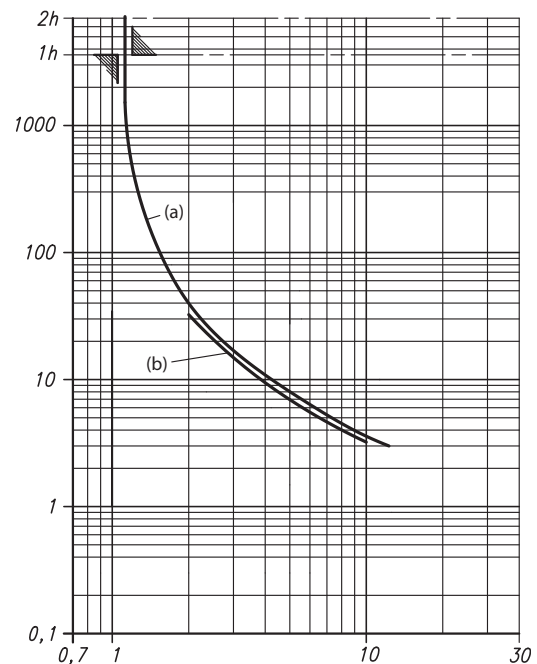

Bimetallic Overload Relays

Specifications

2

Cat. Nos. 193-T1AB48...AC25 Overload Relays

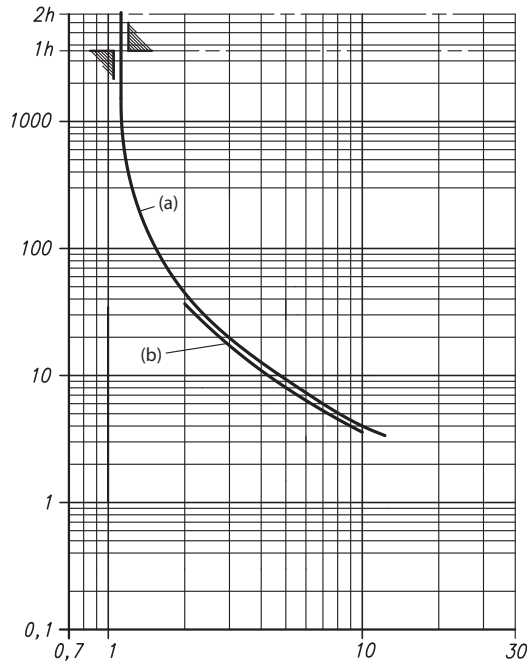

Tripping Time [s]
Multiple of the set current [I_e]

Cat. Nos. 193-T1BC20...BC25 Overload Relays

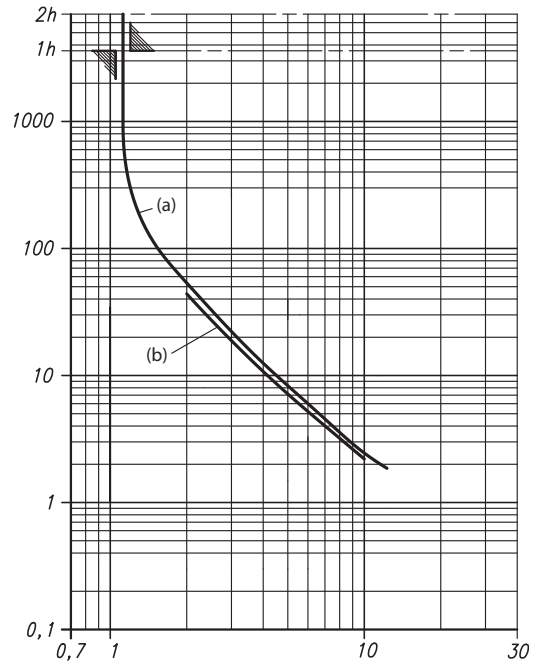

Cat. Nos. 193-T1BC30...BC38 Overload Relays

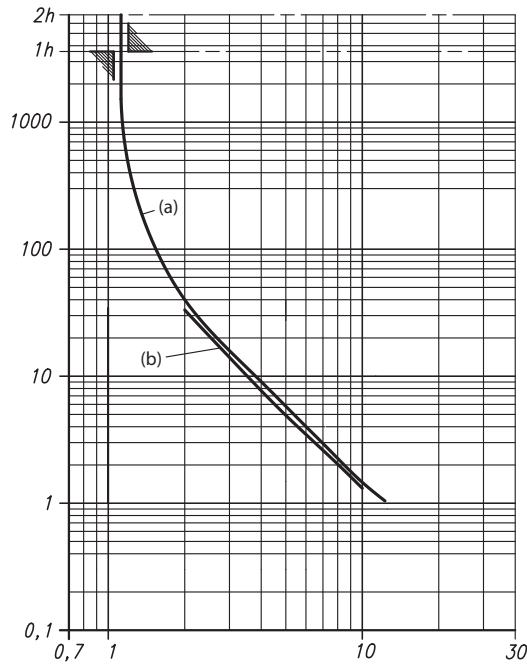

Cat. Nos. 193-T1CC25...CC47 Overload Relays

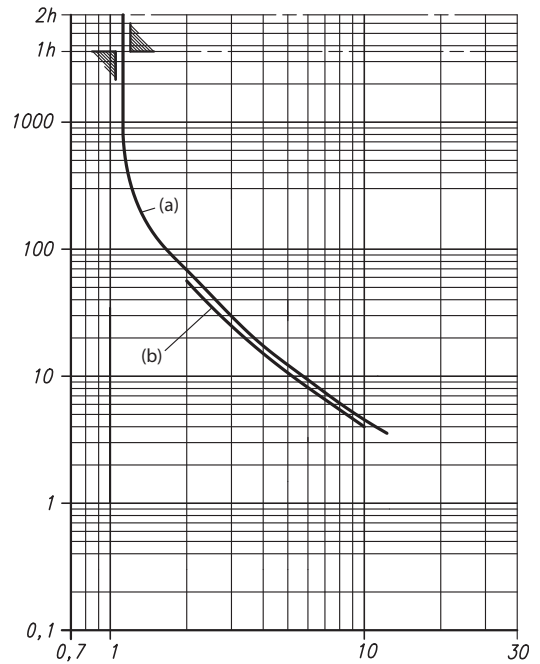

Cat. Nos. 193-T1DC47...DC90 Overload Relays

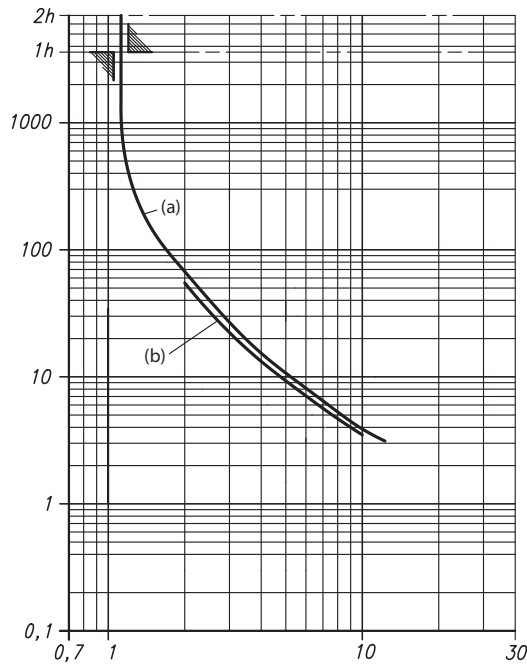

Approximate Dimensions

Dimensions are shown in millimeters (inches). Dimensions are not intended for manufacturing purposes.

Cat. Nos. 193-T1AA16...AC25 Overload Relays

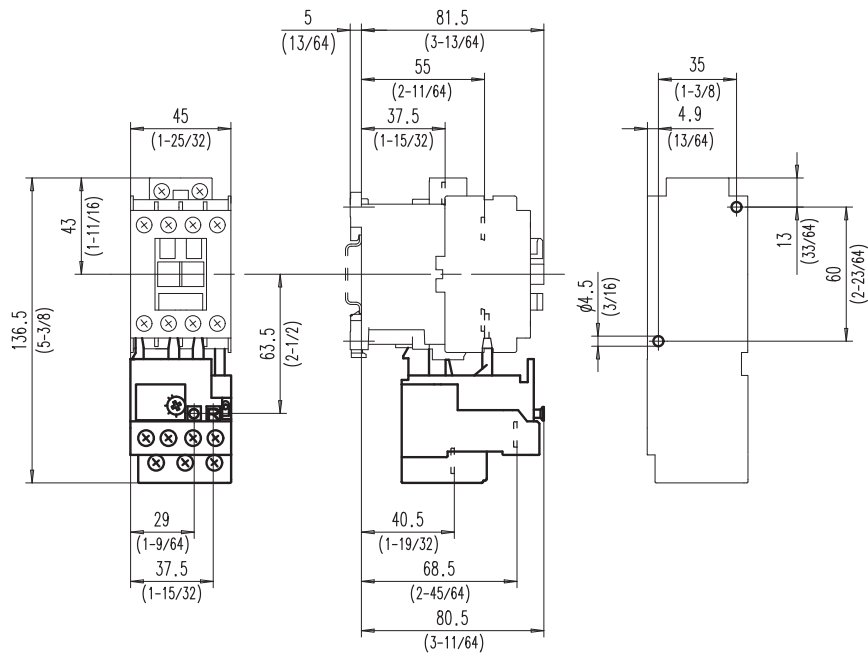

Bimetallic Overload Relays

Approximate Dimensions

Dimensions are shown in millimeters (inches). Dimensions are not intended for manufacturing purposes.

Cat. Nos. 193-T1BC20...25 Overload Relays

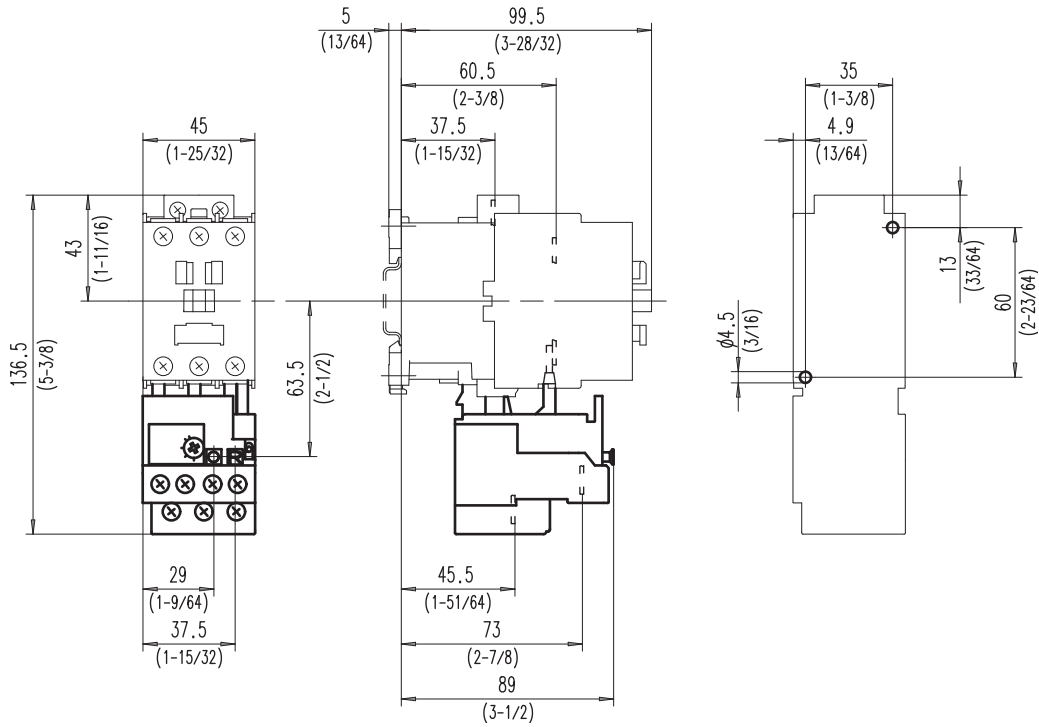

Cat. Nos. 193-T1BC30...38 Overload Relays

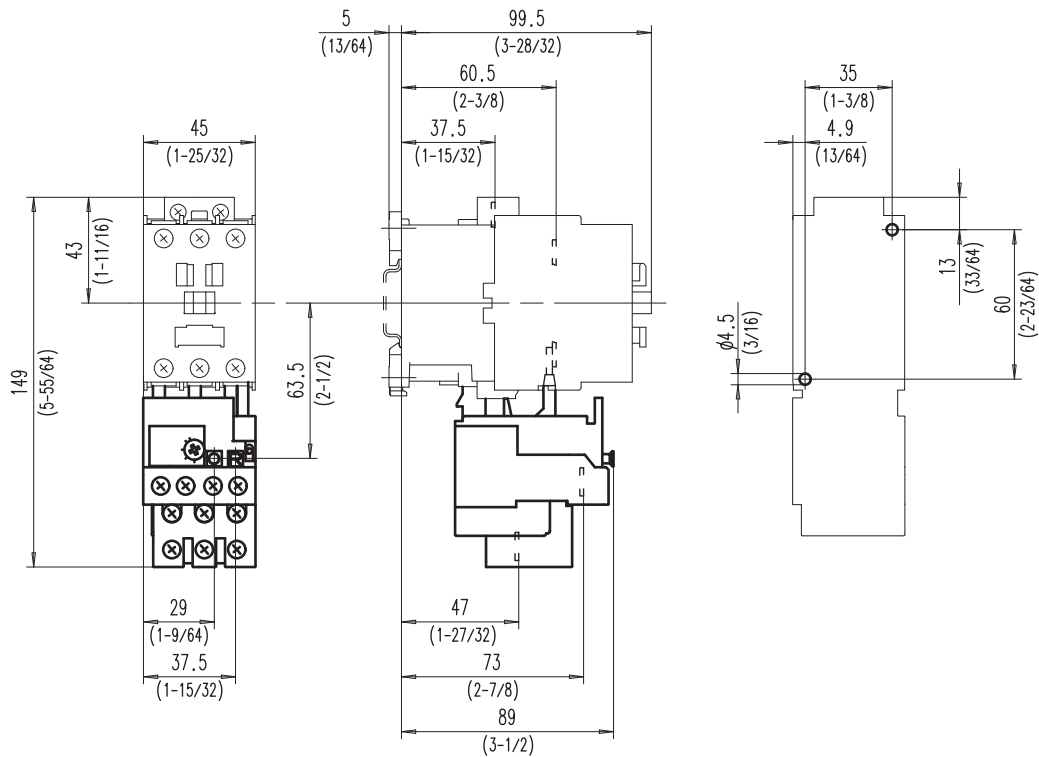

Dimensions are shown in millimeters (inches). Dimensions are not intended for manufacturing purposes.

Cat. Nos. 193-T1CC25...47 Overload Relays

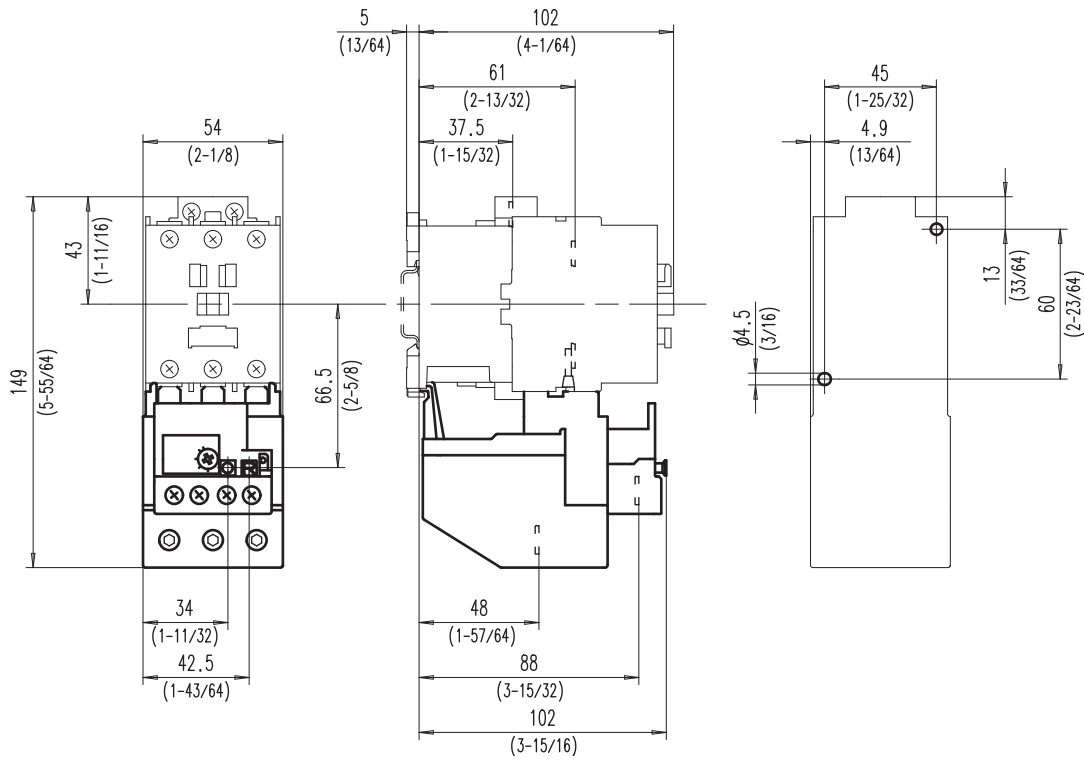

Cat. Nos. 193-T1DC47...90 Overload Relays

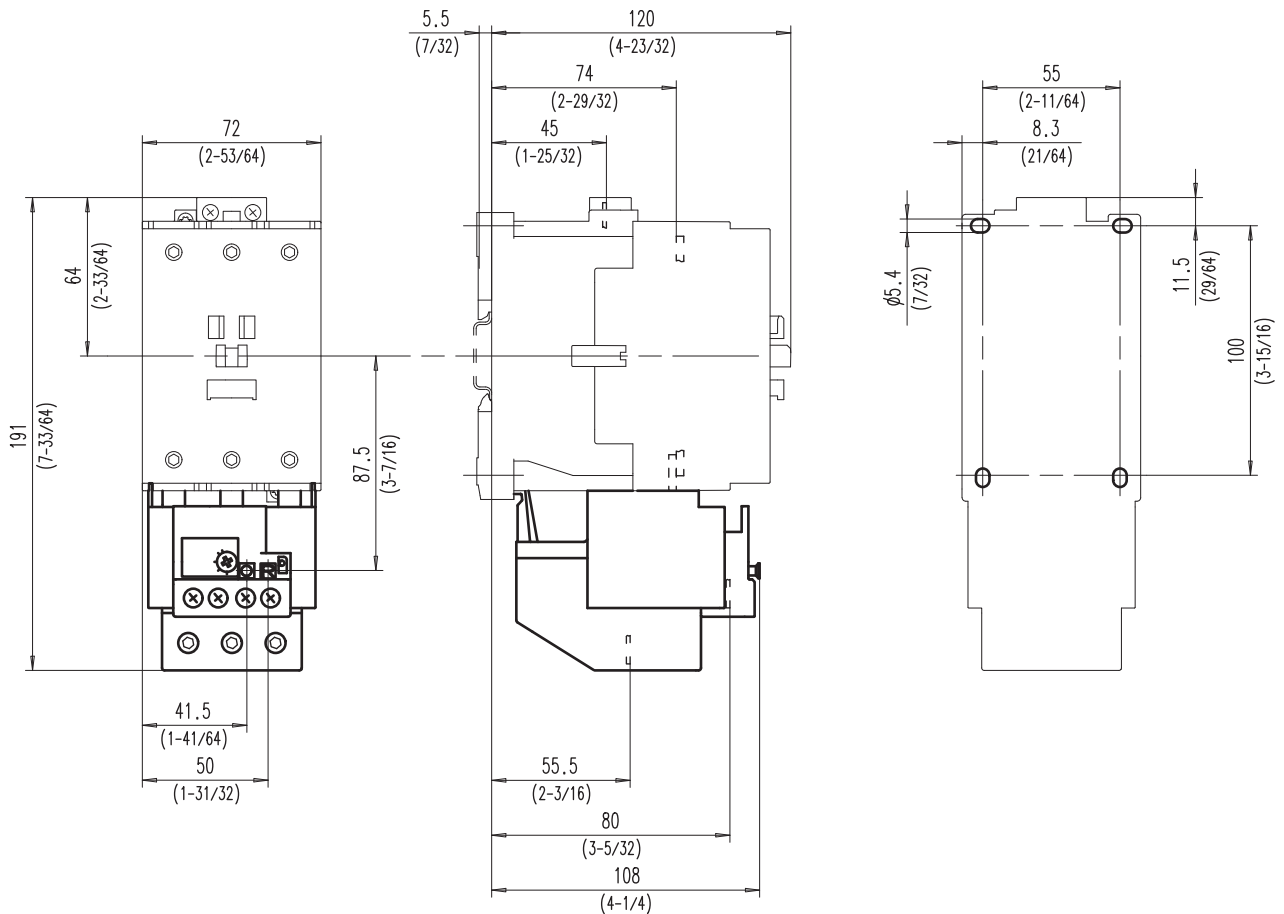

Bimetallic Overload Relays

Approximate Dimensions

Dimensions are shown in millimeters (inches). Dimensions are not intended for manufacturing purposes.

Cat. Nos. 193-T1DC47P...90P Overload Relays

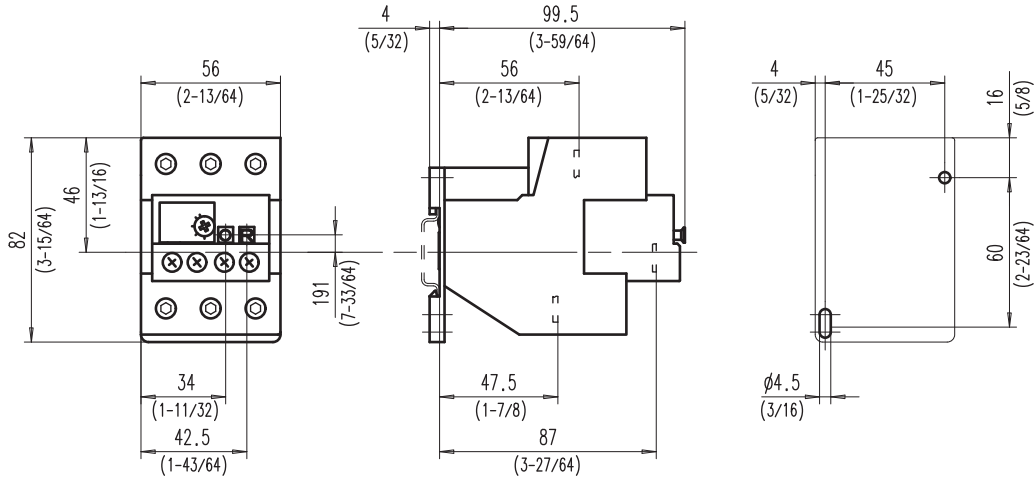

Cat. No. 193-T1APM DIN Rail/Panel Mounting Adapter (for use with Cat. Nos. 193-T1AA16...AC25 and 193-T1BC20...25 Overload Relays)

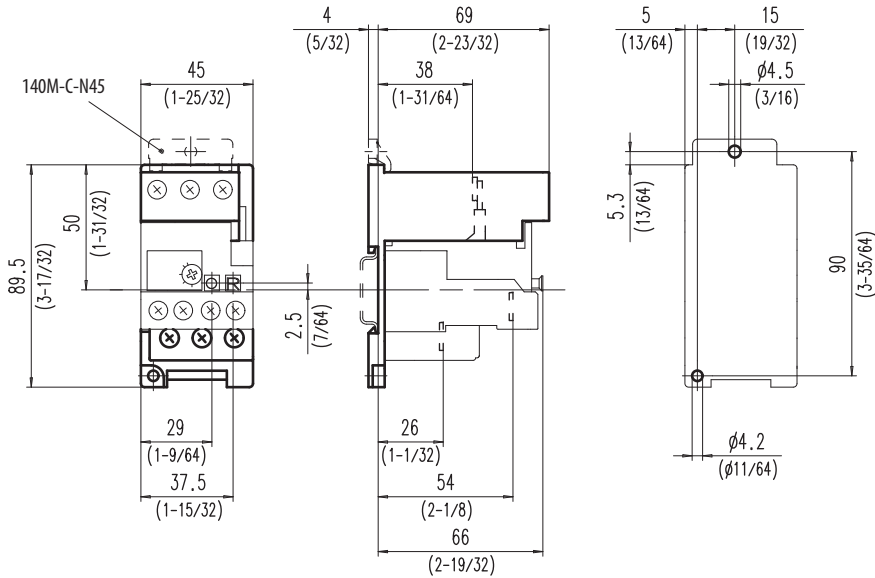

Dimensions are shown in millimeters (inches). Dimensions are not intended for manufacturing purposes.

Cat. No. 193-T1APM DIN Rail/Panel Mounting Adapter
 (for use with Cat. No. 193-T1BC30...38 Overload Relays)

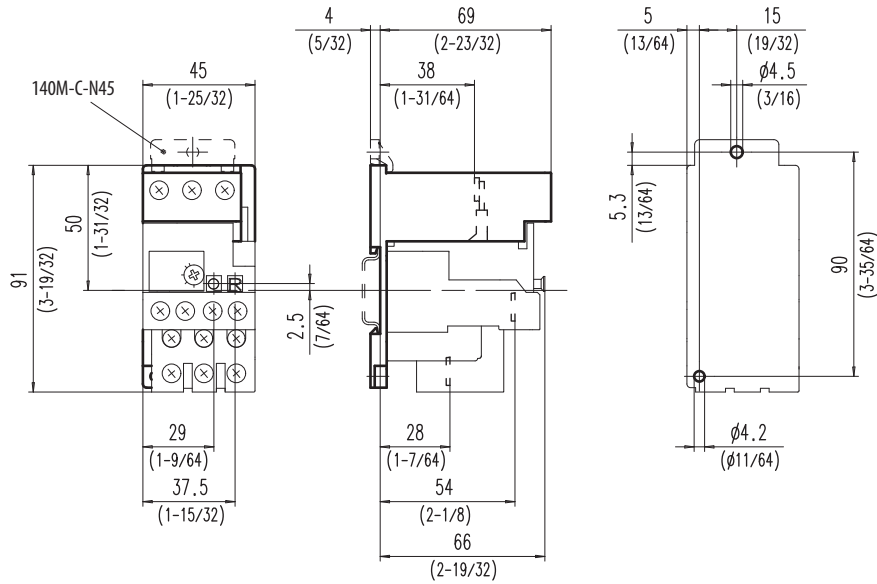

Cat. No. 193-RA3 Reset Adapter

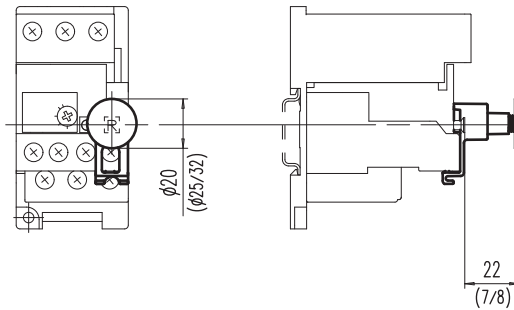

Cat. No. 193-T1R Remote Reset Solenoid

