

440P Safety Limit Switches

30mm Metal Position Switches



The 30 mm metal safety limit switches conform to EN 50041 and have been developed to provide a range of options including a choice of snap-acting, slow-acting, and break before make (BBM) with 2-, 3-, and 4-circuit configurations and a choice of actuator heads. The distance between the horizontal mounting holes is 30 mm.

The operator heads can be rotated in 90° increments for easy mounting.

Allen-Bradley/Guardmaster limit switches can be used in other applications other than guard doors, for example on moving machine beds, crane arms, lifts, elevators, etc.

Operation of these limit switches is achieved by the sliding action of the guard or other moving object deflecting the plunger or lever.

ATTENTION



For safety applications it is important that upon actuation, the guard or other moving objects should not pass completely over the switch and allow the plunger or lever to return to its original position.

Specifications

Standards	EN954-1, ISO13849-1, IEC/EN60204-1, NFPA79, EN1088, ISO14119, IEC/ EN60947-5-1, ANSI B11.19, AS4024.1				
Category	Cat. 1 Device per EN954-1 Dual channel interlocks suitable for Cat. 3 or 4 systems				
Approvals	cULus, TÜV, CE and CCC Marked for all applicable directives				
Safety Contacts	1 N.C. snap acting, 2 N.C., 3 N.C. or 4 N.C. slow acting				
Auxiliary Contacts	1 N.O. (with 2 N.C.)				
Designation/Utilization Cat.	Contact Specifications^⓪				
A600/AC-15	(Ue)	600 V	500 V	240 V	120 V
	(Ie)	1.2 A	1.4 A	3 A	6 A
Q600/DC-13	(Ue)	600 V	500 V	250 V	125 V
	(Ie)	0.1 A	0.13 A	0.27 A	09.55 A
Thermal Current (Ith)	8 A				
Rated Insulation Voltage	600 V AC				
Rated Impulse withstand Volt	2500 V				
Travel for Positive Opening	Various (see Product Selection table)				
Max Switching Speed	250 mm/s				
Min Switching Speed	100 mm/min				
Max Switching Frequency	6000 operation per hour				
Case Material	Die cast alloy				
Actuator Material	See Product Selection table				
Enclosure Protection	IP66				
Operating Temperature [C (F)]	-25...+65° (-13...+149°)				
Pollution Degree ^⓪	3				
Mechanical Life Expectancy	1 x 10 ⁷ operations with no electrical load				
Conduit Entry	M20 or 1/2 inch NPT				
Fixing	2 x M5				
Mounting	Any position				
Color	Red				

⓪ Maximum for:

Two-Circuit N5 5-Pin Mini Connector	
AC	DC
300V, 2.5 A	300V, 2.5 A
Four-Circuit M9 12-Pin M23 Connector	
AC	DC
60V, 2.5 A	60V, 2.5 A

⓪ Conductive pollution occurs, or dry, nonconductive pollution occurs which becomes conductive due to condensation.

Features

- Large selection of actuator heads
- Positive operation, forced disconnection of contacts
- Snap-acting, slow make before break or slow break before make contact blocks
- Contacts 1 N.C. + 1 N.O., 2 N.C. + 1 N.O. 3 N.C., 2 N.C. + 2 N.O., 3 N.C. + 1 N.O., or 4 N.C.
- Conforms to EN 50041, EN 1088, EN 60947-5-1, EN 292 and EN 60204-1







Safety Limit Switches

Product Selection page 5-123
 Wiring page 5-126
 Dimensions page 5-126

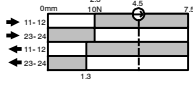
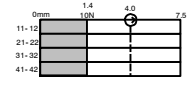
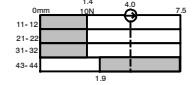
440P Safety Limit Switches

30mm Metal Position Switches

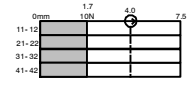
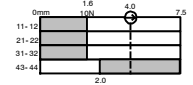
Product Selection

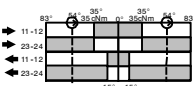
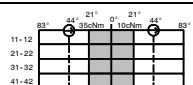
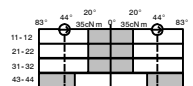
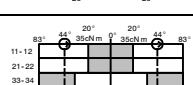
Operator Type	Contacts		Contact Type	Typical Force/Torque to Operate	Contact Opening Characteristics □ Open ■ Closed ⊙ Positive Opening Point	Cat. No.		
	Safety	Aux.				1/2 inch NPT Conduit	M20 Conduit	Quick Disconnect ①
	1 N.C.	1 N.O.	Snap Acting	13 N		440P-MRPS11E	440P-MRPS11B	440P-MRPS11N5
	4 N.C.	—	—	11 N		440P-MRPB04E	440P-MRPB04B	440P-MRPB04M9
	3 N.C.	1 N.O.	BBM	11 N		440P-MRPB13E	440P-MRPB13B	440P-MRPB13M9
	2 N.C.	2 N.O.	BBM	11 N		440P-MRPB22E	440P-MRPB22B	440P-MRPB22M9
	1 N.C.	1 N.O.	Snap Acting	13 N		440P-MDPS11E	440P-MDPS11B	440P-MDPS11N5
	4 N.C.	—	—	11 N		440P-MDPB04E	440P-MDPB04B	440P-MDPB04M9
	3 N.C.	1 N.O.	BBM	11 N		440P-MDPB13E	440P-MDPB13B	440P-MDPB13M9
	2 N.C.	2 N.O.	BBM	11 N		440P-MDPB22E	440P-MDPB22B	440P-MDPB22M9
	1 N.C.	1 N.O.	Snap Acting	0.34 N•m		440P-MSLS11E	440P-MSLS11B	440P-MSLS11N5
	4 N.C.	—	—	0.20 N•m		440P-MSLB04E	440P-MSLB04B	440P-MSLB04M9
	3 N.C.	1 N.O.	BBM	0.34 N•m		440P-MSLB13E	440P-MSLB13B	440P-MSLB13M9
	2 N.C.	2 N.O.	BBM	0.34 N•m		440P-MSLB22E	440P-MSLB22B	440P-MSLB22M9
Recommended standard cordset, 2 m, 5-pin mini connector (see page 8-1 for additional lengths).						889N-F5AE-6F		
Recommended standard cordset, 2 m, 12-pin 9 wire (see page 8-1 for additional lengths).						889M-F12X9AE-2		





① N5 = 5-pin mini connector.
M9 = 12-pin M23 connector (use 9 wire).

Limit Switches

440P Safety Limit Switches

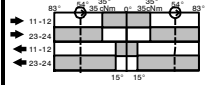
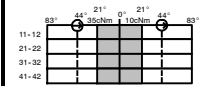
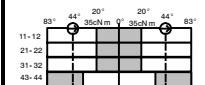
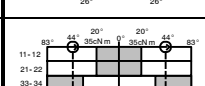
30mm Metal Position Switches

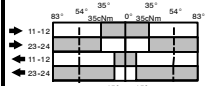
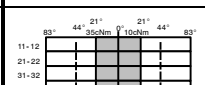
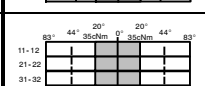
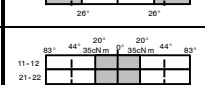

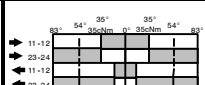
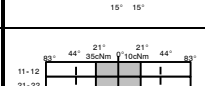
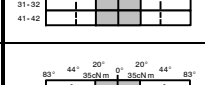
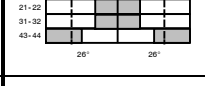
Product Selection (continued)

Operator Type	Contacts		Contact Type	Typical Force/ Torque to Operate	Contact Opening Characteristics □ Open ■ Closed ⊙ Positive Opening Point	Cat. No.		
	Safety	Aux.				1/2 inch NPT Conduit	M20 Conduit	Quick Disconnect ①
 Metal Short Lever, Metal Roller	1 N.C.	1 N.O.	Snap Acting	0.34 N•m		440P-MMHS11E	440P-MMHS11B	440P-MMHS11N5
	4 N.C.	—	—	0.20 N•m		440P-MMHB04E	440P-MMHB04B	440P-MMHB04M9
	3 N.C.	1 N.O.	BBM	0.34 N•m		440P-MMHB13E	440P-MMHB13B	440P-MMHB13M9
	2 N.C.	2 N.O.	BBM	0.34 N•m		440P-MMHB22E	440P-MMHB22B	440P-MMHB22M9
 Metal Adjustable Lever ②	1 N.C.	1 N.O.	Snap Acting	0.34 N•m		440P-MALS11E	440P-MALS11B	440P-MALS11N5
	4 N.C.	—	—	0.20 N•m		440P-MALB04E	440P-MALB04B	440P-MALB04M9
	3 N.C.	1 N.O.	BBM	0.34 N•m		440P-MALB13E	440P-MALB13B	440P-MALB13M9
	2 N.C.	2 N.O.	BBM	0.34 N•m		440P-MALB22E	440P-MALB22B	440P-MALB22M9
 Metal Rod Lever ②	1 N.C.	1 N.O.	Snap Acting	0.34 N•m		440P-MARS11E	440P-MARS11B	440P-MARS11N5
	4 N.C.	—	—	0.20 N•m		440P-MARB04E	440P-MARB04B	440P-MARB04M9
	3 N.C.	1 N.O.	BBM	0.34 N•m		440P-MARB13E	440P-MARB13B	440P-MARB13M9
	2 N.C.	2 N.O.	BBM	0.34 N•m		440P-MARB22E	440P-MARB22B	440P-MARB22M9
Recommended standard cordset, 2 m, 5-pin mini connector (see page 8-1 for additional lengths).						889N-F5AE-6F		
Recommended standard cordset, 2 m, 12-pin 9 wire (see page 8-1 for additional lengths).						889M-F12X9AE-2		

① N5 = 5-pin mini connector.
 M9 = 12-pin M23 connector (use 9 wire).
 ② Not positive opening

Limit Switches
440P Safety Limit Switches
 30 mm Metal Position Switches

Product Selection (continued)

Description	Safety Contacts	Auxiliary Contacts	Contact Type	Typical Force/Torque to Operate	Contact Opening Characteristics	Cat. No.		
					<input type="checkbox"/> Open <input checked="" type="checkbox"/> Closed ☉ Positive Opening Point	1/2 inch NPT Conduit	M20 Conduit	Connector ★
 Metal Spring Rod ‡	1 N.C.	1 N.O.	Snap Acting	0.20 N•m (1.77 lb•in)		440P-MSRS11E	440P-MSRS11B	440P-MSRS11N5
	4 N.C.	—	—	0.20 N•m (1.77 lb•in)		440P-MSRB04E	440P-MSRB04B	440P-MSRB04M9
	3 N.C.	1 N.O.	BBM	0.20 N•m (1.77 lb•in)		440P-MSRB13E	440P-MSRB13B	440P-MSRB13M9
	2 N.C.	2 N.O.	BBM	0.20 N•m (1.77 lb•in)		440P-MSRB22E	440P-MSRB22B	440P-MSRB22M9
 Telescopic Arm ‡	1 N.C.	1 N.O.	Snap Acting	0.20 N•m (1.77 lb•in)		440P-MTAS11E	440P-MTAS11B	440P-MTAS11N5
	4 N.C.	—	—	0.20 N•m (1.77 lb•in)		440P-MTAB04E	440P-MTAB04B	440P-MTAB04M9
	3 N.C.	1 N.O.	BBM	0.20 N•m (1.77 lb•in)		440P-MTAB13E	440P-MTAB13B	440P-MTAB13M9
	2 N.C.	2 N.O.	BBM	0.20 N•m (1.77 lb•in)		440P-MTAB22E	440P-MTAB22B	440P-MTAB22M9
 Large Rubber Roller ‡	1 N.C.	1 N.O.	Snap Acting	0.20 N•m (1.77 lb•in)		440P-MRRS11E	440P-MRRS11B	440P-MRRS11N5
	4 N.C.	—	—	0.20 N•m (1.77 lb•in)		440P-MRRB04E	440P-MRRB04B	440P-MRRB04M9
	3 N.C.	1 N.O.	BBM	0.34 N•m (3.01 lb•in)		440P-MRRB13E	440P-MRRB13B	440P-MRRB13M9
	2 N.C.	2 N.O.	BBM	0.34 N•m (3.01 lb•in)		440P-MRRB22E	440P-MRRB22B	440P-MRRB22M9
Recommended standard cordset, 2 m, 5-pin mini connector.								889N-F5AE-6F
Recommended standard cordset, 2 m, 12-pin 9-wire.								889M-F12X9AE-2

★ N5 = 5-pin mini connector.
 M9 = 12-pin M23 connector (use 9 wire).
 ‡ Not positive opening

Limit Switches

440P Safety Limit Switches

30 mm Metal Position Switches

Typical Wiring Diagrams

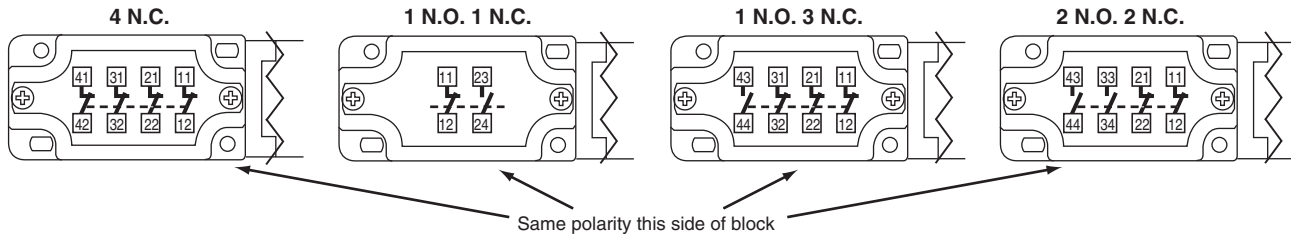

N5 Connector 2 Circuit 5-Pin Mini Connector

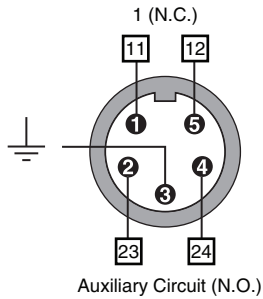

Connector Ratings

	Max. Ratings		Applicable Standards
	AC	DC	
5-Pin Mini (M12)	300V, 2.5 A	300V, 2.5 A	IEC 61076-2-101:2003
12-Pin (M23)	60V, 2.5 A	60V, 2.5 A	

M9 12-Pin M23 Connector

Connector Pinout	4 N.C.		3 N.C. 1 N.O.		3 N.C.	
	Terminal	Contact	Terminal	Contact	Terminal	Contact
1	11	N.C.	11	N.C.	11	N.C.
3	12	N.C.	12	N.C.	12	N.C.
4	21	N.C.	21	N.C.	21	N.C.
6	22	N.C.	22	N.C.	22	N.C.
7	31	N.C.	31	N.C.	33	N.O.
8	32	N.C.	32	N.C.	34	N.O.
9	41	N.C.	43	N.O.	43	N.O.
10	42	N.C.	44	N.O.	44	N.O.
12	Ground					

Approximate Dimensions—mm (inches)

Dimensions are not intended to be used for installation purposes.

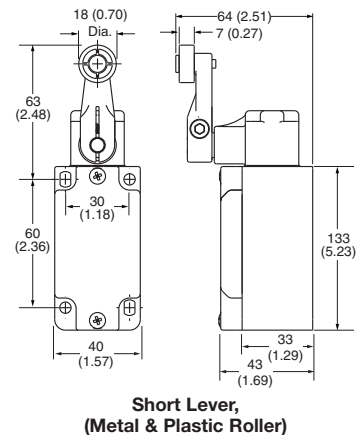
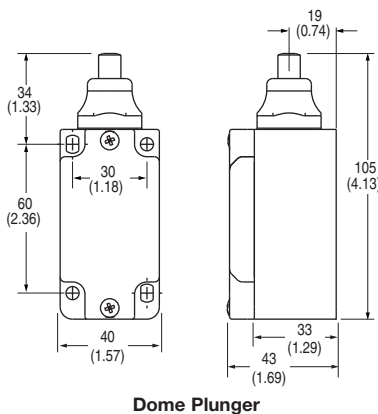
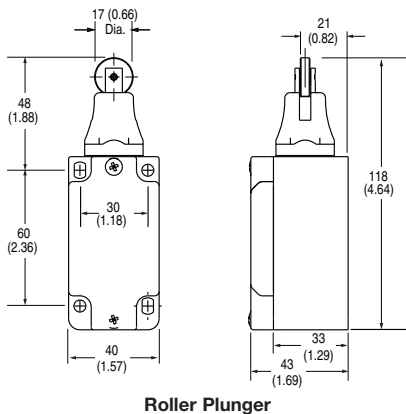

Approximate Dimensions—mm (inches) (continued)

Dimensions are not intended to be used for installation purposes.

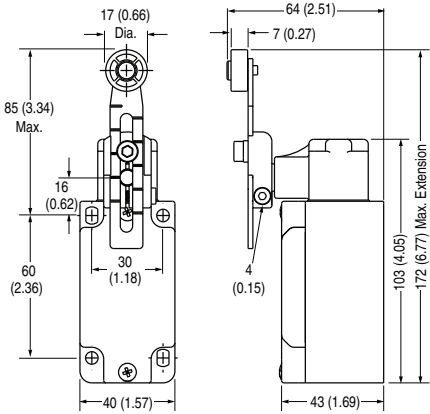

Adjustable Lever

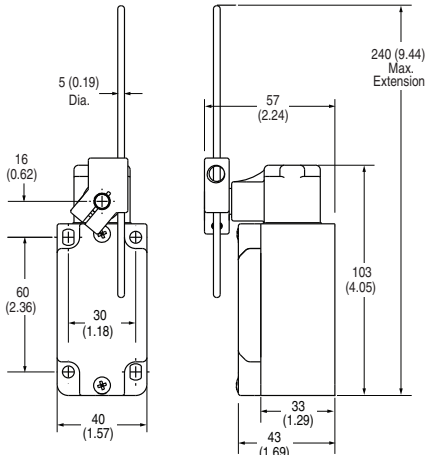

Rod Lever

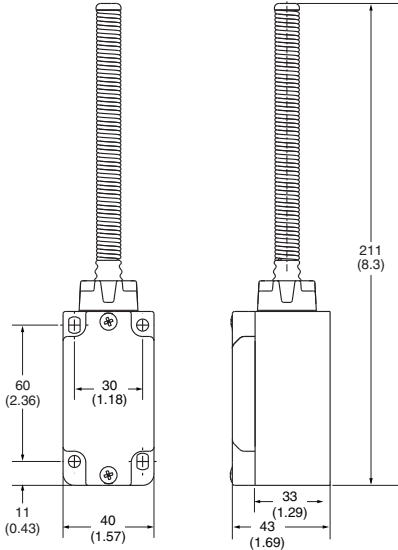

Spring Rod

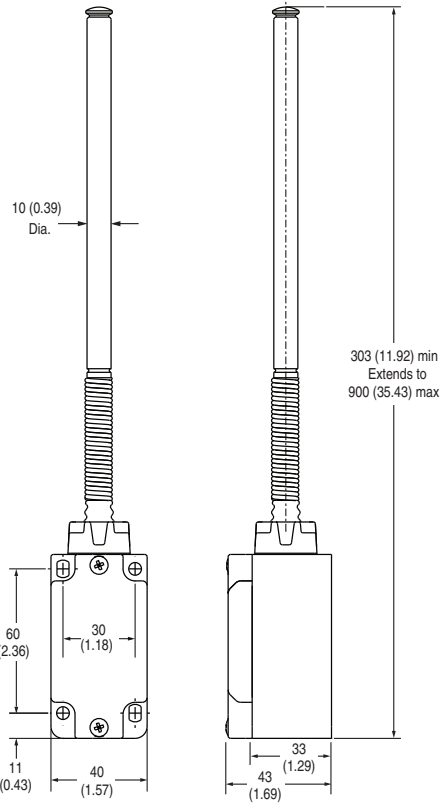

Telescopic Arm

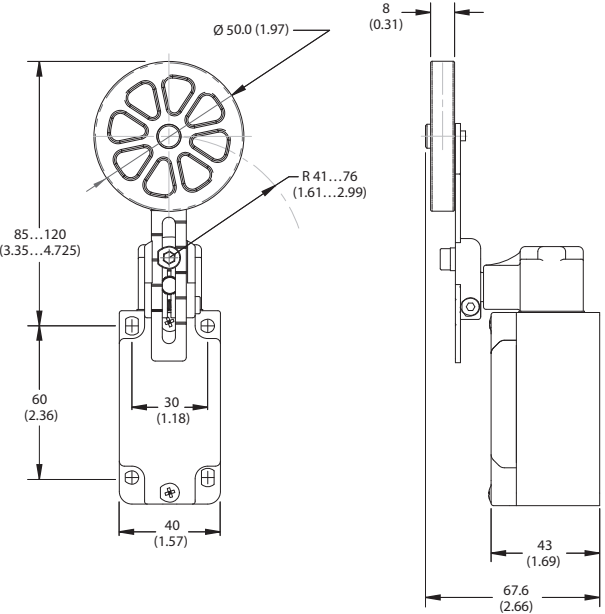

Adjustable Lever with Rubber Roller