

## Operator Interface

### Emergency Stop Devices

#### Cable Pull Switches

Overview .....	4-2
Lifeline™ Rope Tensioner System (LRTS) .....	4-4
Lifeline™ 3 .....	4-6
Lifeline™ 4 .....	4-10
Lifeline™ 4 Stainless Steel .....	4-16

#### Enabling Switches

GripSwitch .....	4-24
------------------	------

#### Push Button Switches

22.5 mm .....	4-29
30 mm .....	4-41

### Two-Hand Control Devices

#### Touch Buttons

800Z Zero-Force Touch Buttons .....	4-48
-------------------------------------	------

# Operator Interface

## Cable Pull Switches

### Overview

#### Cable Pull Switches Overview

For machinery such as conveyors, it is often more convenient and effective to use a cable pull device along the hazard area (as shown in the figure below) as the emergency stop device. These devices use a steel wire rope connected to latching pull switches so that pulling on the rope in any direction at any point along its length will trip the switch to cut off the machine power.

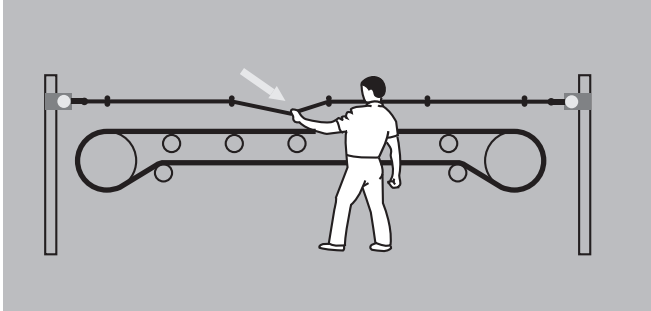

The cable pull switches must detect both a pull on the cable as well as when the cable goes slack. Slack detection ensures that the cable is not cut and is ready for use.

Rockwell Automation developed a unique Lifeline Rope Tensioner System (LRTS) which helps enable quicker installations.

A dedicated stainless steel installation kit must be used with the stainless steel Lifeline 4 instead of the LRTS.

#### Selection Guide

Description	Lifeline 3	Lifeline 4	Stainless Steel Lifeline 4
Material	Painted Zinc Alloy	Painted Aluminum Alloy	Stainless Steel 316
Reset	Yes	Yes	Yes
E-Stop	No	Yes	Yes
Cable Span	30 m (98.42 ft)	75 m (246 ft) 125 m (410 ft) extended model	75 m (246 ft)

#### Typical Applications

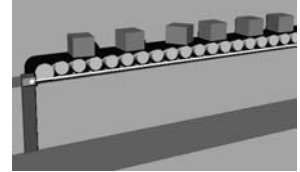
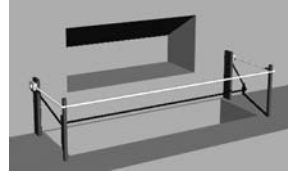

#### Mounting Specifications for Extended Length Models

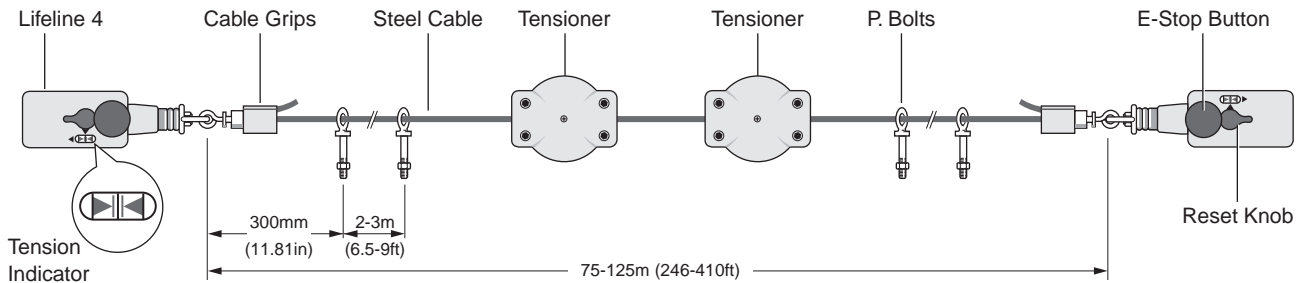

#### Notes:

1. The first and last **P. bolt/eye bolt** must be located as close as possible to the switch eyelet while maintaining adequate clearance (125 mm/5 in) from the cable grips to allow free movement. This provides for a straight and efficient pulling action on the switches.
2. Additional **P. bolts/eye bolts**, spaced 2-3 m (6-9 ft) apart, help keep the perpendicular pull force,  $F$ , and distance,  $d$ , within IEC60947-5-5 specifications of 200 N (45 lbs) and 400 mm (15.75 in).
3. We recommend using a switch at both cable ends, especially in applications with long cable runs or cable runs going around bends. This helps ensure that the safety function is fulfilled upon actuation of the cable in any direction.
4. ISO 13850 requires that the full length of cable to be within view when the reset is turned to the run position or the machine must be inspected over the whole length of the cable, both before and after resetting.
5. On shorter cable runs (max 10 m), a Lifeline tensioner spring may be used at one end of the span. The installation must be such that the above requirements can be met. When a spring is used, the last **P. Bolt/eye bolt** must be located as close as possible to the spring while maintaining adequate clearance (125 mm/5 in) from the cable grips to allow free movement. This is intended to help to ensure that a pull near the end of the cable will be between **P. Bolts/eye bolts**. This should result in operation of the switch contacts instead of only the spring moving.
6. Careful attention is required for the design of the installation to ensure that the cable is not likely to become trapped or snagged. This is especially important when using a tensioner spring because a cable snag between the location of the pull and the switch could prevent the actuation of the safety function.
7. It is essential that when the installation is complete, a thorough functional test is made. This should include checking all types and directions of pull over the length of the cable as well as checking for slack-cable tripping.

**Mounting Specifications for Standard Rope Length Models**

Lifeline 4

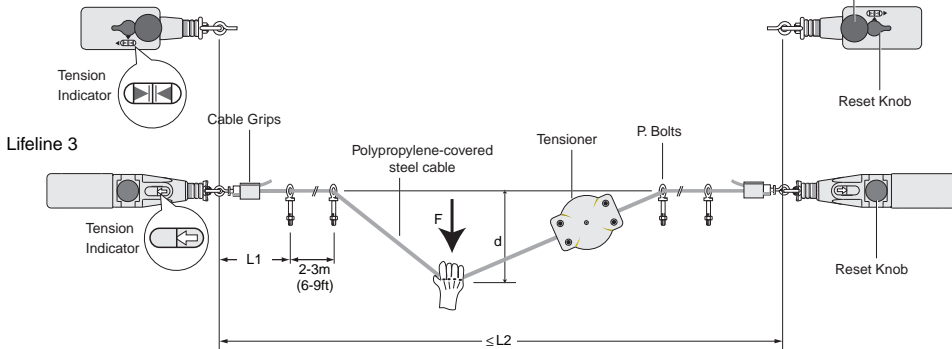

	L1	L2
Lifeline 4	300 mm (11.81 in)	75 m (246 ft)
Lifeline 3	125 mm (5 in)	30 m (98 ft)

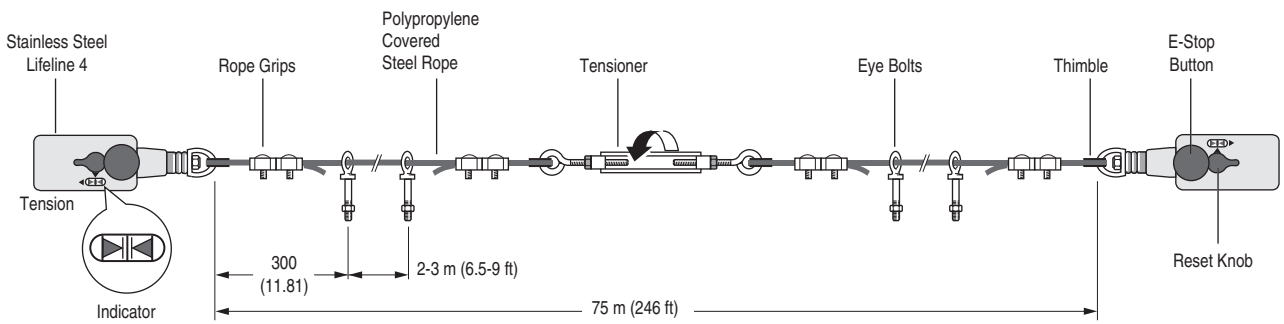

**Mounting Specifications with Spring Tensioner**

Lifeline 4

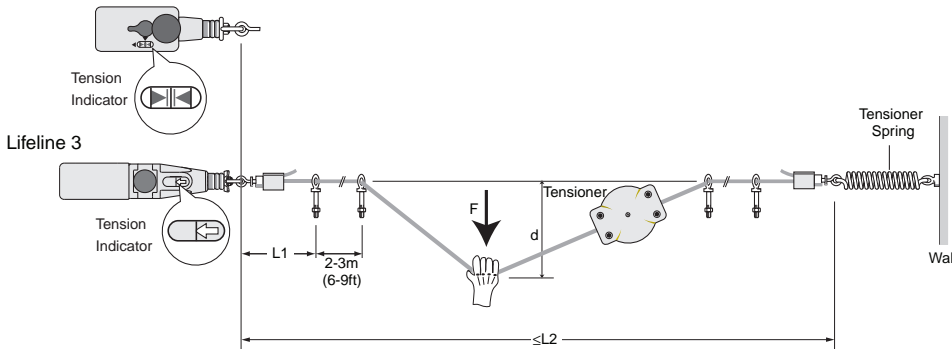

	L1	L2
Lifeline 4	300 mm (11.81 in)	75 m (246 ft)
Lifeline 3	125 mm (5 in)	30 m (98 ft)

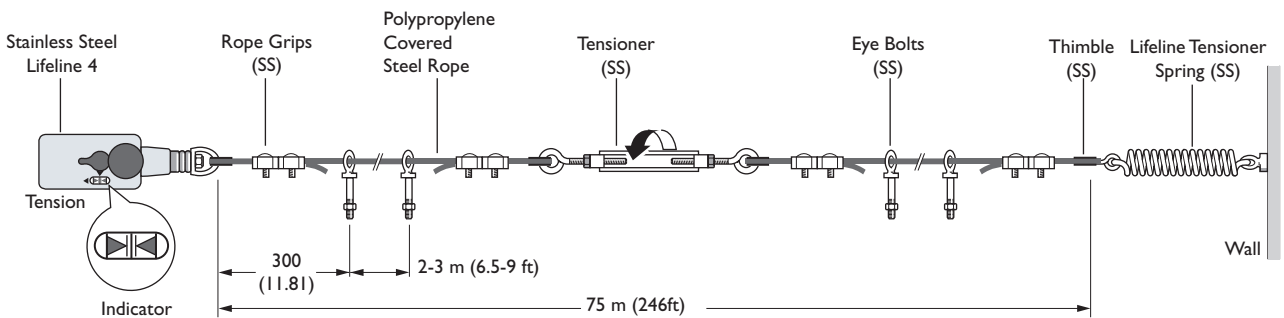

The choice between using two switches or one switch and a spring is a matter of a risk assessment taking into consideration the probability of a trapped rope along the span. See also notes 3 and 6 on the previous page.

4-Emergency Stop Devices

## Cable Pull Switches

### Lifeline™ Rope Tensioner System (LRTS)



#### Description

The LRTS is a unique cable (rope) tensioning system which enables quicker installation of cable actuated systems. Other methods are traditionally time consuming and sometimes awkward to fit. Features of the system include:

1. Cable adjustment up to 300 mm (11.8 in) (150 mm (5.9 in) either side of tensioner)
2. Quick thread and grip of cable with cable grip
3. Cable tidy incorporated into the cable grips
4. Simple tensioning via the tensioner with allen key.

Due to the appeal of quick installation and universal use, the LRTS can also be used for applications other than cable actuated emergency stop systems.

#### Features

- Unique cable grip system
- Can be installed and commissioned in approximately 3 minutes
- Ease of installation, no specialty tools required
- Up to 300 mm (11.8 in) of cable adjustment
- Cable tidy incorporated into cable grips

#### Specifications

Material	Tensioner: Glass-filled nylon Cable gripper: Acetal, zinc alloy, stainless steel Cable gripper gears: Stainless steel Cable: Cable to BS 302:1987, wire Ø4.0 Steel Core with polypropylene sheath P. Bolt: Stainless steel
Color	Tensioner: Yellow Cable gripper: Yellow/natural Cable: Red P. Bolt: Natural
Weight [g (lb)]	Tensioner: 140 (0.31) Cable gripper: 80 (0.17)
Operating Temperature [C (F)]	-25...80° (-13...176°)
Cable O.D.	4 mm (0.15 in.)
Cable Adjustment Range, Max.	300 mm (11.8 in.)
Tensioner Holding Force, Max.	500 N (112.5 lbf)
Gripper Holding Force, Max.	280 N (63.0 lbf)
Enclosure Type Rating	IP30
Tensioner Adjustment Tool	5 mm A/F Allen key

#### Four Steps to Install

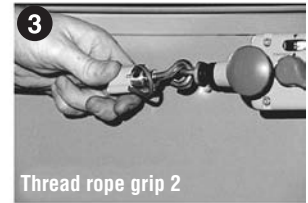
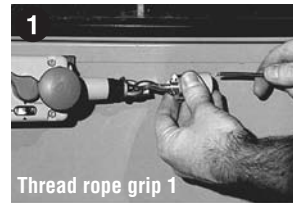





**Product Selection**

Description	No. of P-Bolts	Cat. No.
	Installation Kit—5 m (16.4 ft)	3 <b>440E-A13079</b>
	Installation Kit—10 m (32.8 ft)	6 440E-A13080
	Installation Kit—15 m (49.2 ft)	8 <b>440E-A13081</b>
	Installation Kit—20 m (65.6 ft)	10 440E-A13082
	Installation Kit—30 m (98.4 ft)	14 440E-A13083
	Installation Kit—50 m (164 ft)	22 440E-A13084
	Installation Kit—75 m (246 ft)	32 440E-A13085

A stainless steel tensioner kit is available for use with the Lifeline 4 Stainless Steel, see page 4-18.

**Accessories**

Description	Cat. No.
	Lifeline tensioner and Allen key only <b>440E-A17105</b>
	Lifeline gripper two pack 440E-A17107
	Lifeline gripper 20 pack 440E-A17106
	Lifeline tensioner, two grippers and Allen wrench <b>440E-A17112</b>
	Two Lifeline tensioners, two grippers and Allen wrench 440E-A17140
	15 m (49.2 ft) 440E-A17026
	30 m (98.4 ft) 440E-A17027
	100 m (328 ft) 440E-A17028
	125 m (410 ft) 440E-A17129
	300 m (984 ft) 440E-A17095
	500 m (1640 ft) 440E-A17032
	UV resistant polypropylene covered steel cable
300 m (984 ft) 440E-A14740	

Red Cable

**Approximate Dimensions**

Dimensions are shown in mm (in.). Dimensions are not intended to be used for installation purposes.

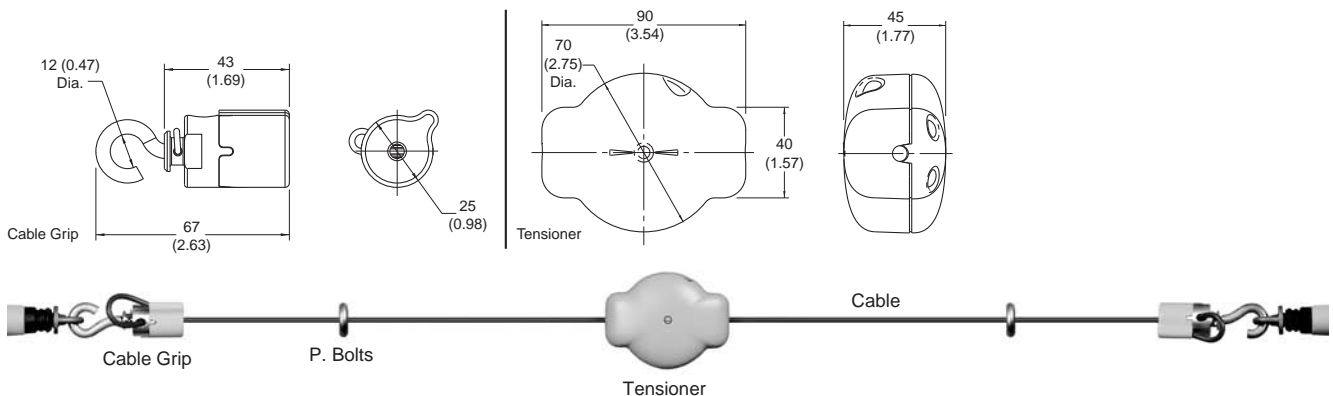

**Note:** 2D, 3D and electrical drawings are available on [www.ab.com](http://www.ab.com).



### Description

The Lifeline 3 is a cable (rope) operated emergency stop device designed to meet the stringent requirements of ISO 13850 (Safety of Machinery—Emergency Stop Equipment). The Lifeline 3 system can be installed along or around awkward machinery such as conveyors and provides a constant-access emergency-stop facility.

1. The positive-mode mechanism helps ensure that the contacts are immediately latched open on actuation and can only be reset by the intentional action of turning the blue reset knob. The design also protects against nuisance tripping and the effects of thermal expansion.
2. The cable-status indicator makes the system easy to set up and maintain for spans up to 30 m (98 ft).
3. Four sets of contacts are provided: 2 N.C. + 2 N.O., or 3 N.C. + 1 N.O. contacts.
4. Sealed to IP 67 with rugged construction using die-cast alloy and stainless steel to withstand harsh conditions.

### Features

- Switches up to 30 m (98 ft) span
- Universal mounting and operation
- Switch lockout on cable pulled and cable slack
- Cable-status indicator on switch lid
- Industry standard fixing centers to DIN/EN 50041
- Quick disconnect styles available

### Specifications

Safety Ratings					
Standards	ISO 13850, EN ISO 12100, IEC 60947-5-1, IEC 60947-5-5				
Safety Classification	Cat. 1 device per EN 954-1 May be suitable for use in Cat 3 or Cat 4 systems depending on the architecture and application characteristics				
Functional Safety Data *	B10d: > 2 x 10 <sup>6</sup> operations at min. load PFH <sub>D</sub> : < 3 x 10 <sup>-7</sup> MTTFd: > 385 years May be suitable for use in performance levels Pl <sub>e</sub> or Pl <sub>d</sub> systems (according to ISO 13849-1:2006) and for use in SIL2 or SIL3 systems (according to IEC 62061) depending on the architecture and application characteristics				
Certifications	CE Marked for all applicable directives, cULus, TÜV, and CCC				
Outputs					
Safety Contacts *	2 N.C. direct-opening action	3 N.C. direct-opening action			
Auxiliary Contacts	2 N.O. direct-opening action	1 N.O. direct-opening action			
Thermal Current/I <sub>th</sub>	10 A				
Rated Insulation Voltage	(U <sub>i</sub> ) 500V				
Switching Current @ Voltage, Min.	5 mA @ 5V DC				
Utilization Category					
A600/AC-15	(U <sub>e</sub> )	600V	500V	240V	120V
	(I <sub>e</sub> )	1.2 A	1.4 A	3 A	6 A
DC-13	(U <sub>e</sub> )	24V			
	(I <sub>e</sub> )	2 A			
Operating Characteristics					
Cable Span Between Switches, Max.	30 m (98 ft)				
Tensioning Force to Run Position	103 N (23.17 lbf) typical				
Tensioning Force to Lockout	188 N (42.3 lbf) typical				
Operating Force, Min.	<125 N (28.1 lb) at 300 mm deflection				
Actuation Frequency, Max.	1 cycle/s				
Operating Life @ 100 mA load	1 x 10 <sup>6</sup>				
Environmental					
Enclosure Type Rating	IP67				
Operating Temperature [C (F)]	-25...80° (-13...176°)				
Physical Characteristics					
Housing Material	Heavy-duty painted zinc-based die-cast alloy				
Indicator Material	Glass-filled nylon				
Eye Nut Material	Stainless steel				
Weight [g (lb)]	610 (1.34)				
Color	Yellow body, blue reset button				

\* Usable for ISO 13849-1:2006 and IEC 62061. Data is based on the B10d value given and:

- Usage rate of 1op/10 mins., 24 hrs/day, 360 days/year, representing 51840 operations per year
- Mission time/Proof test interval of 38 years

\* The safety contacts are described as normally closed (N.C.) i.e., with the guard closed, actuator in place (where relevant) and the machine able to be started.

**Note:** It is recommended that the LRTS (Lifeline Rope Tensioning System) should be used with the Lifeline 3 cable rope switch.

## Product Selection

Contacts		Cat. No.				
Safety	Auxiliary	Conduits		Connectors*		
		M20	1/2 inch NPT	12-Pin M23	8-Pin Micro (M12)*	Connect to ArmorBlock Guard I/O 5-Pin Micro (M12)‡
2 N.C.	2 N.O.	<b>440E-D13118</b>	<b>440E-D13120</b>	440E-D13132	440E-D21BNYH	440E-D2NNNYS
3 N.C.	1 N.O.	<b>440E-D13112</b>	440E-D13114	440E-D13124	—	—

\* For connector ratings, see page 3-9.

\* With an 8-pin micro (M12) connector, not all contacts are connected. See *Typical Wiring Diagram* on page 4-9 for wiring details.

‡ For connection to ArmorBlock Guard I/O. With a 5-pin micro (M12) connector, not all contacts are connected. See *Typical Wiring Diagram* on page 4-9 for wiring details.

## Recommended Logic Interfaces

Description	Safety Outputs	Auxiliary Outputs	Terminals	Reset Type	Power Supply	Cat. Page No.	Cat. No.
<b>Single-Function Safety Relays for 2 N.C. Contact Switch</b>							
MSR127RP	3 N.O.	1 N.C.	Removable (Screw)	Monitored Manual	24V AC/DC	5-26	<b>440R-N23135</b>
MSR127TP	3 N.O.	1 N.C.	Removable (Screw)	Auto./Manual	24V AC/DC	5-26	<b>440R-N23132</b>
MSR126T	2 N.O.	None	Fixed	Auto./Manual	24V AC/DC	5-24	<b>440R-N23117</b>
MSR30RT	2 N.O. Solid State	1 N.O. Solid State	Removable	Auto./Manual or Monitored Manual	24V DC	5-16	440R-N23198
<b>Modular Safety Relays</b>							
MSR210P Base 2 N.C. only	2 N.O.	1 N.C. and 2 PNP Solid State	Removable	Auto./Manual or Monitored Manual	24V DC from the base unit	5-82	440R-H23176
MSR220P Input Module	—	—	Removable	—	24V DC	5-86	440R-H23178
MSR310P Base	MSR300 Series Output Modules	3 PNP Solid State	Removable	Auto./Manual Monitored Manual	24V DC	5-102	440R-W23219
MSR320P Input Module	—	2 PNP Solid State	Removable	—	24V DC from the base unit	5-106	440R-W23218

**Note:** For additional Safety Relays connectivity, see the Safety Relays section (page 5-8) of this catalog.

For additional Safety I/O and Safety PLC connectivity, see the Programmable Safety System section (page 5-115) of this catalog.

For application and wiring diagrams, see the Safety Applications section (page 10-1) of this catalog.

## Connection Systems

Description	5-Pin Micro (M12)*	8-Pin Micro (M12)	12-Pin M23
Cordset	—	889D-F8AB-§	889M-FX9AE-§
Patchcord	889D-F5ACDM-♣	889D-F8ABDM-♣	889M-F12AHMU->

§ Replace symbol with 2 (2 m), 5 (5 m), or 10 (10 m) for standard cable lengths.





♣ Replace symbol with 1 (1 m), 2 (2 m), 3 (3 m), 5 (5 m), or 10 (10 m) for standard cable lengths.

> Replace symbol with 0M3 (0.3 m), 0M6 (0.6 m), 1 (1 m), 2 (2 m) or 3 (3 m) for standard lengths.

\* To connect to ArmorBlock Guard I/O.

Operator Interface  
**Cable Pull Switches**  
 Lifeline™ 3

Accessories

Description		Cat. No.
	Lifeline P. bolt M8 x 1.25 thread size, 58 mm (2.28 in.) threaded length, 12 mm (0.47 in.) dia. eye, 95 mm (3.74 in.) overall length	440E-A17003
	Lifeline tensioner spring 19 mm (0.75 in.) diameter, 210 mm (8.27 in.) overall length, 50 N force	440E-A13078
	Lifeline inside corner pulley Internal diameter 16 mm (0.64 in.) zinc-plated mild steel	440A-A17101
	Lifeline outside corner pulley Outside diameter 38 mm (1.5 in.) zinc-plated mild steel	440A-A17102
	Blanking plug, M20 conduit	440A-A07265
	Cable grip, M20 conduit, accommodates cable diameter 7...10.5 mm (0.27...0.41 in.)	440A-A09028
	Adaptor, conduit, M20 to 1/2 inch NPT, plastic	440A-A09042
	Screwdriver including security bit	440A-A09018

Approximate Dimensions

Dimensions are shown in mm (in.). Dimensions are not intended to be used for installation purposes.

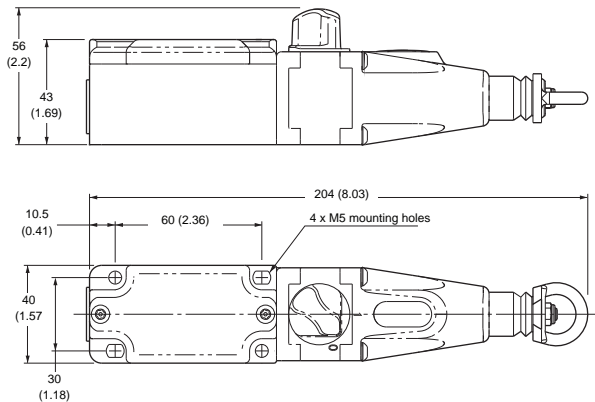

**Note:** 2D, 3D and electrical drawings are available on [www.ab.com](http://www.ab.com).

4-Emergency  
 Stop Devices

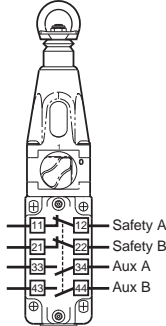
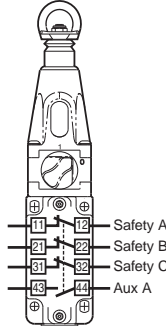
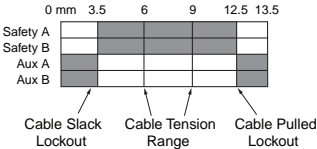
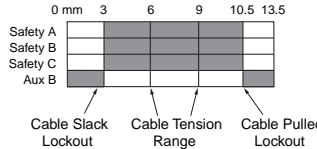
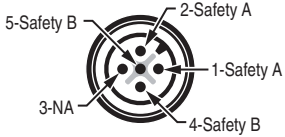
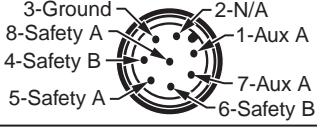
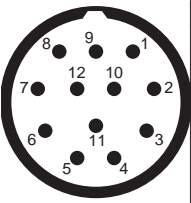

Typical Wiring Diagrams

Description		2 N.C. & 2 N.O.	3 N.C. & 1 N.O.
Contact Configuration			
Contact Action  □ Open ■ Closed			
5-Pin Micro (M12) for ArmorBlock Guard I/O			—
8-Pin Micro (M12)			—
 Pins 2, 5, 11 not connected	1-3	Safety A	Safety A
	4-6	Safety B	Safety B
	7-8	Aux A	Safety C
	9-10	Aux B	Aux A
	12	Ground	Ground
8-Pin Cordset 889D-F8AB-*	Grey Red	Safety A	
	Yellow Pink	Safety B	
	White Blue	Aux A	
	Green	Ground	
	Brown	Not Used	
12-Pin Cordset 889M-FX9AE-*	Brown Blue	Safety A	Safety A
	White Green	Safety B	Safety B
	Yellow Grey	Aux A	Safety C
	Pink Red	Aux B	Aux A
	Green Yellow	Ground	Ground

\* Replace symbol with 2 (2 m), 5 (5 m), or 10 (10 m) for standard cable lengths.  
 \* Replace symbol with 0F5 (0.5 ft) or 1F (1 ft) for standard cable lengths.

4-Emergency Stop Devices



**Description**

The Lifeline 4 cable/push button operated system can be installed along or around awkward machinery such as conveyors and provide a constant emergency stop access.

The Lifeline 4 is the only device of its kind to incorporate the following features in one unit making it the most versatile cable switch on the market.

1. The positive mode mechanism helps ensure that the contacts are immediately latched open on actuation and can only be reset by the intentional action of turning the blue reset knob. The design also protects against nuisance tripping and the effects of thermal expansion.
2. A mushroom head emergency stop button is included on the unit to provide E-Stop access even at the extreme ends of the span.
3. The cable status indicator makes the system easy to set up and maintain for spans up to 125 meters.
4. Four sets of contacts are provided: 2 N.C. + 2 N.O. or 3 N.O. + 1 N.O. contacts
5. Sealed to IP66 with rugged construction using die-cast alloy and stainless steel to withstand harsh conditions.

**Features**

- Switches up to 125 meter span
- Universal mounting and operation
- Lid mounted emergency stop button, designed to conform to ISO 850
- Switch lockout on cable pulled and cable slack
- Cable status indicator on switch lid

**Lid mounted E-Stop button**

A mushroom head emergency stop button is included on the unit to provide total E-Stop access even at the extreme ends of the span.



**Cable status indicator on lid**

The cable status indicator makes the system easy to setup and maintain for spans up to 125 meters.



**Specifications**

Safety Ratings	
Standards	ISO 13850, EN ISO 12100, IEC 60947-5-1, IEC 60947-5-5
Safety Classification	Cat. 1 device per EN 954-1 May be suitable for use in Cat 3 or Cat 4 systems depending on the architecture and application characteristics
Functional Safety Data *	B10d: > 2 x 10 <sup>6</sup> operations at min. load PFH <sub>D</sub> : < 3 x 10 <sup>-7</sup> MTTF <sub>D</sub> : > 385 years May be suitable for use in performance levels Pl <sub>e</sub> or Pl <sub>d</sub> systems (according to ISO 13849-1:2006) and for use in SIL2 or SIL3 systems (according to IEC 62061) depending on the architecture and application characteristics
<b>Note:</b> For up-to-date information, visit <a href="http://www.ab.com/Safety/">http://www.ab.com/Safety/</a>	
Certifications	CE Marked for all applicable directives, cULus, TÜV, and CCC

Outputs		
Safety Contacts *	2 N.C. direct-opening action	3 N.C. direct-opening action
Auxiliary Contacts	2 N.O. direct-opening action	1 N.O. direct-opening action
Thermal Current/I <sub>th</sub>	10 A	
Rated Insulation Voltage	(U <sub>i</sub> ) 500V	
Switching Current @ Voltage, Min.	5 mA @ 5V DC	

Utilization Category					
A600/AC-15	(U <sub>e</sub> )	600V	500V	240V	120V
	(I <sub>e</sub> )	1.2 A	1.4 A	3 A	6 A
DC-13	(U <sub>e</sub> )	24V			
	(I <sub>e</sub> )	2 A			

Operating Characteristics	
Cable Span Between Switches, Max.	75 m (246 ft) standard model and 75...125 m (146...410 ft) extended length model
Tensioning Force to Run Position	103 N (23.16 lbf) typical
Tensioning Force to Lockout	188 N (42.3 lbf) typical
Operating Force, Min.	<125 N (28.1 lbf) at 300 mm deflection
Actuation Frequency, Max.	1 cycle/s
Operating Life @ 100 mA load	1 x 10 <sup>6</sup>

Environmental	
Enclosure Type Rating	IP66
Operating Temperature [C (F)]	-25...80° (-13...176°)

Physical Characteristics	
Housing Material	Heavy-duty painted zinc-based die-cast alloy (LM24)
Indicator Material	Glass-filled nylon
Eye Nut Material	Stainless steel
Weight [g (lb)]	630 (1.38)
Color	Yellow body, blue reset button

- \* Usable for ISO 13849-1:2006 and IEC 62061. Data is based on the B10d value given and:
  - Usage rate of 1op/10 mins., 24 hrs/day, 360 days/year, representing 51840 operations per year
  - Mission time/Proof test interval of 38 years

- \* The safety contacts are described as normally closed (N.C.) i.e., with the guard closed, actuator in place (where relevant) and the machine able to be started.

**Note:** It is recommended that the LRTS (Lifeline Rope Tensioning System) should be used with the Lifeline 4 cable rope switch.

## Product Selection

Cable Span	Safety Contacts	Auxiliary Contacts	Cat. No.				
			Conduits		Connectors*		
			M20	1/2 inch NPT	12-Pin M23	8-Pin Micro*	Connect to ArmorBlock Guard I/O 5-Pin Micro (M12)†
75 m (246 ft)	2 N.C.	2 N.O.	440E-L13137	440E-L13133	440E-L13140	440E-L21BANYH	440E-L2NNNYS
	3 N.C.	1 N.O.	440E-L13042	440E-L13043	440E-L13141	—	—
75...125 m (146...410 ft)	2 N.C.	2 N.O.	440E-L13153	440E-L13155	440E-L13163	440E-L21BTYH	—
	3 N.C.	1 N.O.	440E-L13150	440E-L13152	440E-L13164	—	—

\* For connector ratings, see page 3-9.

† For connection to ArmorBlock Guard I/O. With a 5-pin micro (M12) connector, not all contacts are connected. See page 4-15 for wiring details.

‡ With an 8-pin micro (M12) connector, not all contacts are connected. See page 4-15 for wiring details.

## Recommended Logic Interfaces

Description	Safety Outputs	Auxiliary Outputs	Terminals	Reset Type	Power Supply	Cat. Page No.	Cat. No.
<b>Single-Function Safety Relays for 2 N.C. Contact Switch</b>							
MSR127RP	3 N.O.	1 N.C.	Removable (Screw)	Monitored Manual	24V AC/DC	5-26	440R-N23135
MSR127TP	3 N.O.	1 N.C.	Removable (Screw)	Auto./Manual	24V AC/DC	5-26	440R-N23132
MSR126T	2 N.O.	None	Fixed	Auto./Manual	24V AC/DC	5-24	440R-N23117
MSR30RT	2 N.O. Solid State	1 N.O. Solid State	Removable	Auto./Manual or Monitored Manual	24V DC	5-16	440R-N23198
<b>Modular Safety Relays</b>							
MSR210P Base 2 N.C. only	2 N.O.	1 N.C. and 2 PNP Solid State	Removable	Auto./Manual or Monitored Manual	24V DC from the base unit	5-82	440R-H23176
MSR220P Input Module	—	—	Removable	—	24V DC	5-86	440R-H23178
MSR310P Base	MSR300 Series Output Modules	3 PNP Solid State	Removable	Auto./Manual Monitored Manual	24V DC	5-102	440R-W23219
MSR320P Input Module	—	2 PNP Solid State	Removable	—	24V DC from the base unit	5-106	440R-W23218

**Note:** For additional Safety Relays connectivity, see page 5-4.

For additional Safety I/O and Safety PLC connectivity, see page 5-116.

For application and wiring diagrams, see page 10-1.

## Connection Systems

Description	5-Pin Micro (M12)	8-Pin Micro (M12)	12-Pin M23
Cordset	—	889D-F8AB-§	889M-FX9AE-§
Patchcord	889D-F5ACDM-*	889D-F8ABDM-♣	889M-F12AHMU->

\* Replace symbol with 0M3 (0.3 m), 1 (1 m), 2 (2 m), 3 (3 m), 5 (5 m), or 10 (10 m) for standard lengths.











§ Replace symbol with 2 (2 m), 5 (5 m), or 10 (10 m) for standard cable lengths.

♣ Replace symbol with 1 (1 m), 2 (2 m), 3 (3 m), 5 (5 m), or 10 (10 m) for standard cable lengths.

> Replace symbol with 0M3 (0.3 m), 0M6 (0.6 m), 1 (1 m), 2 (2 m) or 3 (3 m) for standard length.









Operator Interface  
**Cable Pull Switches**  
 Lifeline™ 4

Accessories

	Description	Cat. No.
	Lifeline P. bolt	440E-A17003
	Lifeline tensioner spring	440E-A13078
	Replacement cover for Lifeline 4 cable/push button	440E-A13054
	Replacement cover for Lifeline 4 cable/push button, no E-Stop	440E-A17115
	Lifeline inside corner pulley	440A-A17101
	Lifeline outside corner pulley	440A-A17102
	Mounting bracket for Lifeline 4 cable/push button	440E-A17130
	Blanking plug, M20 conduit	440A-A07265
	Cable grip, M20 conduit, accommodates cable diameter 7...10.5 mm (0.27...0.41 in.)	440A-A09028
	Adaptor, conduit, M20 to 1/2 inch NPT, plastic	440A-A09042
	Screwdriver including security bit	440A-A09018

4-Emergency  
 Stop Devices

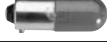
Accessories (continued)

	Description	Cat. No.
	Indicator, M20 Conduit Pilot Light—Amber Lens T-3 1/4 Insert Use T-3 1/4 Bulb (Sold Separately)	440A-A19001
	Indicator, 1/2in NPT Conduit Pilot Light—Amber Lens T-3 1/4 Insert Use T-3 1/4 Bulb (Sold Separately)	440A-A19005
	Indicator, M20 Conduit Pilot Light—Amber Lens Bayonet Style Insert Use LED Bulb (Sold Separately)	440A-A17124
	Indicator, 1/2in NPT Conduit Pilot Light—Amber Lens Bayonet Style Insert Use LED Bulb (Sold Separately)	440A-A17122
	Indicator, M20 Conduit Pilot Light—Red Lens T-3 1/4 Insert Use T-3 1/4 Bulb (Sold Separately)	440A-A19002
	Indicator, 1/2in NPT Conduit Pilot Light—Red Lens T-3 1/4 Insert Use T-3 1/4 Bulb (Sold Separately)	440A-A19007
	Indicator, M20 Conduit Pilot Light—Red Lens Bayonet Style Insert Use LED Bulb (Sold Separately)	440A-A17125
	Indicator, 1/2in NPT Conduit Pilot Light—Red Lens Bayonet Style Insert Use LED Bulb (Sold Separately)	440A-A17123
	Bulb, 24V for Conduit Pilot Light 2.8W T-3 1/4 Bulb, Miniature Screw Base	440A-A09056
	Bulb, 110V for Conduit Pilot Light 2.6W T-3 1/4 Bulb, Miniature Screw Base	440A-A09055
	Bulb, 240V for Conduit Pilot Light 0.75W T-3 1/4 Bulb, Miniature Screw Base	440A-A09054
	Red LED Bulb, 24V AC/DC for Conduit Pilot Light Bayonet Style Insert	800T-N319R
	Amber LED Bulb, 24V AC/DC for Conduit Pilot Light Bayonet Style Insert	800T-N319A
	Red LED Bulb, 120V AC for Conduit Pilot Light Bayonet Style Insert	800T-N320R
	Amber LED Bulb, 120V AC for Conduit Pilot Light Bayonet Style Insert	800T-N320A

Operator Interface  
**Cable Pull Switches**  
 Lifeline™ 4

**Approximate Dimensions**

Dimensions are shown in mm (in.). Dimensions are not intended to be used for installation purposes.

**Standard Model**

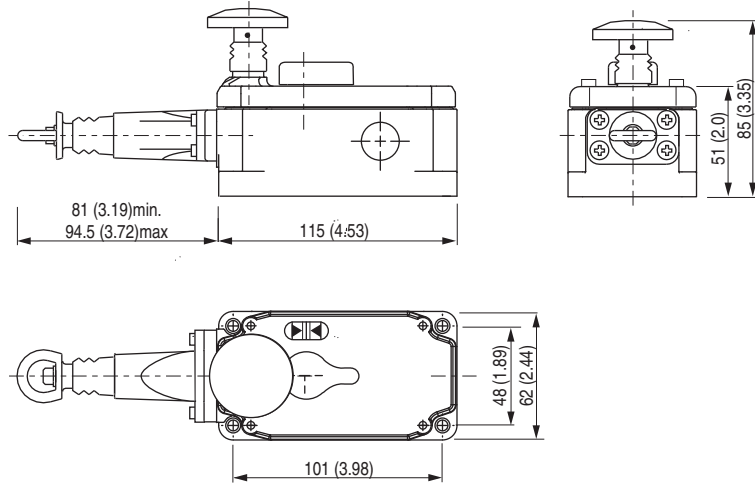

**Extended Length Models (75...125 m cable span)**

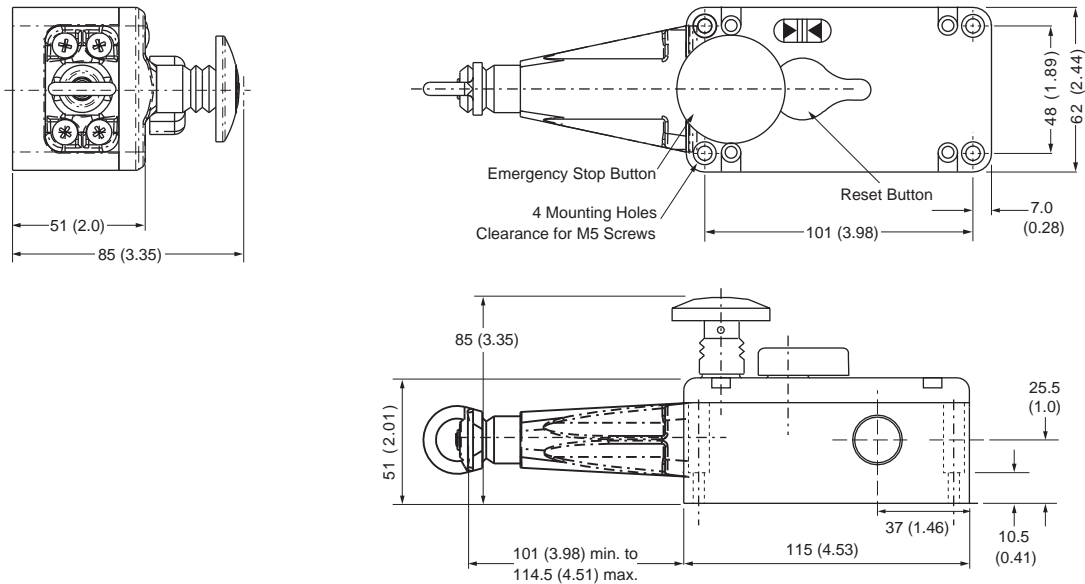

Note: 2D, 3D and electrical drawings are available on [www.ab.com](http://www.ab.com).

4-Emergency Stop Devices

Typical Wiring Diagrams

Description		2 N.C. & 2 N.O.	3 N.C. & 1 N.O.
Contact Configuration			
Contact Action			
8-Pin Micro (M12)			—
12-Pin M23 	1-3	Safety A	Safety A
	4-6	Safety B	Safety B
	7-8	Aux A	Safety C
	9-10	Aux B	Aux A
	12	Ground	Ground
5-Pin Micro for ArmorBlock Guard I/O			—
8-Pin Cordset 889D-F8AB-*	Grey Red	Safety A	—
	Yellow Pink	Safety B	—
	White Blue	Aux A	—
	Green	Ground	—
	Brown	Not Used	
12-Pin Cordset 889M-FX9AE-*	Brown Blue	Safety A	Safety A
	White Green	Safety B	Safety B
	Yellow Grey	Aux A	Safety C
	Pink Red	Aux B	Aux A
	Green Yellow	Ground	Ground

\* Replace symbol with 2 (2 m), 5 (5 m), or 10 (10 m) for standard cable lengths.  
 \* Replace symbol with 0F5 (0.5 ft) or 1F (1 ft) for standard cable lengths.

4-Emergency Stop Devices

# Operator Interface

## Cable Pull Switches

### Lifeline™ 4 Stainless Steel



### Description

The stainless steel Lifeline 4 cable/push button operated system can be installed along or around awkward machinery such as conveyors and provide a constant emergency stop access. This switch is made from stainless steel 316 and is suitable for external use, applications where there are hygiene requirements and other situations where a level of corrosion resistance is required.

The Lifeline 4 is the only device of its kind to incorporate the following features in one unit making it the most versatile cable switch on the market.

1. The positive mode mechanism helps ensure that the contacts are immediately latched open on actuation and can only be reset by the intentional action of turning the blue reset knob. The design also protects against nuisance tripping and the effects of thermal expansion.
2. A mushroom head emergency stop button is included on the unit to provide E-Stop access even at the extreme ends of the span.
3. The cable status indicator makes the system easy to set up and maintain for spans up to 75 meters.
4. Four sets of contacts are provided: 2 N.C. + 2 N.O.
5. Sealed to IP66 and IP69K with rugged construction using stainless steel 316 to withstand harsh conditions.

### Features

- Switches up to 75 m (246 ft) span
- Universal mounting and operation
- Lid mounted emergency stop button, designed to conform to ISO 850
- Switch lockout on cable pulled and cable slack
- Cable status indicator on switch lid
- Made from stainless steel 316

#### Lid mounted E-Stop button

A mushroom head emergency stop button is included on the unit to provide total E-Stop access even at the extreme ends of the span.



#### Cable status indicator on lid

The cable status indicator makes the system easy to set up and maintain for spans up to 75 m (246 ft).

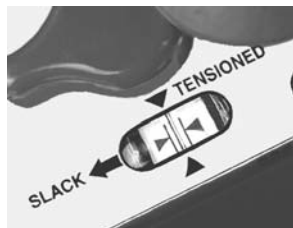

### Specifications

Safety Ratings	
Standards	EN 60947-5-5, ISO 13850, EN ISO 12100, IEC 60947-5-1
Safety Classification	Cat. 1 device per EN 954-1 May be suitable for use in Cat 3 or Cat 4 systems depending on the architecture and application characteristics
Functional Safety Data *	B10d: > 2 x 10 <sup>6</sup> operations at min. load PFH <sub>D</sub> : < 3 x 10 <sup>-7</sup> MTTF <sub>D</sub> : > 385 years May be suitable for use in performance levels Ple or Pld systems (according to ISO 13849-1:2006) and for use in SIL2 or SIL3 systems (according to IEC 62061) depending on the architecture and application characteristics
<b>Note:</b> For up-to-date information, visit <a href="http://www.ab.com/Safety/">http://www.ab.com/Safety/</a>	
Certifications	CE Marked for all applicable directives, cULus Certified and TÜV
Outputs	
Safety Contacts *	2 N.C. direct opening action
Auxiliary Contacts	2 N.O.
Thermal Current I <sub>th</sub>	10 A
Rated Insulation Voltage	(U <sub>i</sub> ) 500V
Switching Current @ Voltage, Min.	5 mA @ 5V DC
Utilization Category	
A600/AC-15	(Ue) 600V 500V 240V 120V (Ie) 1.2 A 1.4 A 3 A 6 A
DC-13	(Ue) 24V (Ie) 2 A
Operating Characteristics	
Cable Span Between Switches, Max.	75 m (246 ft)
Tensioning Force to Run Position	103 N (23.17 lbf) typical
Tensioning Force to Lockout	188 N (42.3 lbf) typical
Operating Force, Min.	<125 N (28.1 lbf) at 300 mm deflection
Actuation Frequency, Max.	1 cycle/s
Operating Life @ 100 mA load	1 x 10 <sup>6</sup>
Environmental	
Enclosure Type Rating	IP66, IP67, IP69K
Operating Temperature [C (F)]	-25...80° (-13...176°)
Physical Characteristics	
Housing Material	Stainless steel 316
Indicator Material	Acetal
Eye Nut Material	Stainless steel
Weight [g (lb)]	1442 (3.17)
Color	Unpainted metal
* Usable for ISO 13849-1:2006 and IEC 62061. Data is based on the B10d value given and: - Usage rate of 1op/10 mins., 24 hrs/day, 360 days/year, representing 51840 operations per year - Mission time/Proof test interval of 38 years	
* The safety contacts are described as normally closed (N.C.) i.e., with the guard closed, actuator in place (where relevant) and the machine able to be started.	
<b>Note:</b> It is recommended that the stainless steel installation kit should be used with the stainless steel Lifeline 4 as it is made of suitable materials for harsh conditions.	



## Product Selection

Cable Span	Safety Contacts	Auxiliary Contacts	Cat. No.		
			Conduits		Connectors§
			M20	1/2 inch NPT	12-Pin M23
Up to 75 m (246 ft)	2 N.C.	2 N.O.	<b>440E-L22BNSM</b>	<b>440E-L22BNST</b>	440E-L22BNSL

§ For connector ratings, see 3-9.

## Recommended Logic Interfaces

Description	Safety Outputs	Auxiliary Outputs	Terminals	Reset Type	Power Supply	Cat. Page No.	Cat. No.
<b>Single-Function Safety Relays for 2 N.C. Contact Switch</b>							
MSR127RP	3 N.O.	1 N.C.	Removable (Screw)	Monitored Manual	24V AC/DC	5-26	<b>440R-N23135</b>
MSR127TP	3 N.O.	1 N.C.	Removable (Screw)	Auto./Manual	24V AC/DC	5-26	<b>440R-N23132</b>
MSR126T	2 N.O.	None	Fixed	Auto./Manual	24V AC/DC	5-24	<b>440R-N23117</b>
MSR30RT	2 N.O. Solid State	1 N.O. Solid State	Removable	Auto./Manual or Monitored Manual	24V DC	5-16	440R-N23198
<b>Modular Safety Relays</b>							
MSR210P Base 2 N.C. only	2 N.O.	1 N.C. and 2 PNP Solid State	Removable	Auto./Manual or Monitored Manual	24V DC from the base unit	5-82	440R-H23176
MSR220P Input Module	—	—	Removable	—	24V DC	5-86	440R-H23178
MSR310P Base	MSR300 Series Output Modules	3 PNP Solid State	Removable	Auto./Manual Monitored Manual	24V DC	5-102	440R-W23219
MSR320P Input Module	—	2 PNP Solid State	Removable	—	24V DC from the base unit	5-106	440R-W23218

**Note:** For additional Safety Relays connectivity, see page 5-4.  
 For additional Safety I/O and Safety PLC connectivity, see page 5-116.  
 For application and wiring diagrams, see page 10-1.









## Connection Systems

Description	12-Pin M23
Cordset	889M-FX9AE-*
Patchcord	889M-F12AHMU-*

\* Replace symbol with 2 (2 m), 5 (5 m), or 10 (10 m) for standard cable lengths.  
 \* Replace symbol with 0M3 (0.3 m), 0M6 (0.6 m), 1 (1 m), 2 (2 m) or 3 (3 m) for standard length.

Operator Interface  
**Cable Pull Switches**  
 Lifeline™ 4 Stainless Steel

Accessories

	Description	Eye Bolts	Cat. No.
 Polypropylene Covered Steel Cable	Stainless steel installation kit—5 m (16.4 ft)—polypropylene	4	440E-A13194
	Stainless steel installation kit—10 m (32.8 ft)—polypropylene	4	440E-A13195
	Stainless steel installation kit—15 m (49.2 ft)—polypropylene	7	440E-A13196
	Stainless steel installation kit—20 m (65.6 ft)—polypropylene	8	440E-A13197
	Stainless steel installation kit—30 m (98.4 ft)—polypropylene	12	440E-A13198
	Stainless steel installation kit—50 m (164 ft)—polypropylene	20	440E-A13199
 UV Resistant Polypropylene-Covered Steel Cable	Stainless steel installation kit—75 m (246 ft)—polypropylene	30	440E-A13200
	Stainless steel installation kit—5 m (16.4 ft)—UV resistant	4	440E-A13220
	Stainless steel installation kit—10 m (32.8 ft)—UV resistant	4	440E-A13221
	Stainless steel installation kit—15 m (49.2 ft)—UV resistant	7	440E-A13222
	Stainless steel installation kit—20 m (65.6 ft)—UV resistant	8	440E-A13223
	Stainless steel installation kit—30 m (98.4 ft)—UV resistant	12	440E-A13224
	Stainless steel installation kit—50 m (164 ft)—UV resistant	20	440E-A13225
 Stainless steel turn buckle kit (no cable)			440E-A13227
 Stainless steel 304 eyebolt complete M8 x 1.25 thread size, 58 mm (2.28 in) threaded length, 12 mm (0.47 in) dia. eye 95 mm (3.74 in) overall length			<b>440E-A13201</b>
 Stainless steel 316 tensioner spring, 19 mm (0.75 in) dia. 210 mm (8.27 in) overall length			<b>440E-A13202</b>
 Replacement Cover			440E-A13203
 Replacement cover no E-Stop			440E-A13204
 Stainless steel 316 inside corner pulley			440E-A13205
 Stainless steel outside corner pulley			440E-A13206

**Note: Installation Kits** include the following parts: one rope, one turnbuckle tensioner, four thimbles, eight rope grips and eyebolts, nuts and washers depending on the length of the rope.

Approximate Dimensions

Dimensions are shown in mm (in.). Dimensions are not intended to be used for installation purposes.

Standard Model

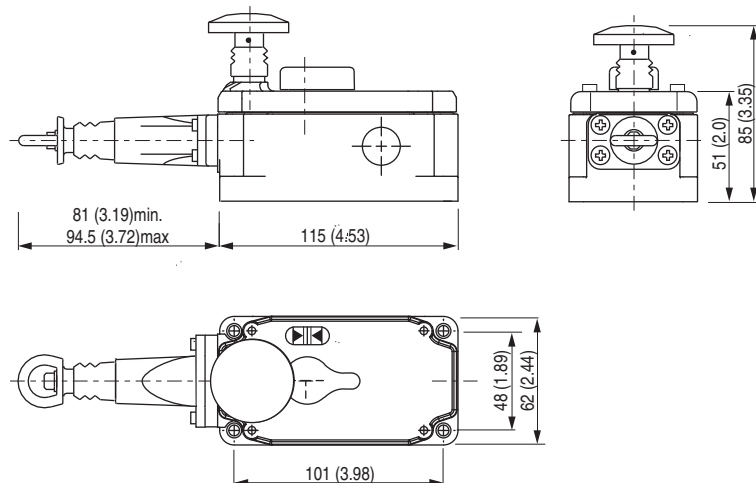

**Note:** 2D, 3D and electrical drawings are available on [www.ab.com](http://www.ab.com).

Typical Wiring Diagrams

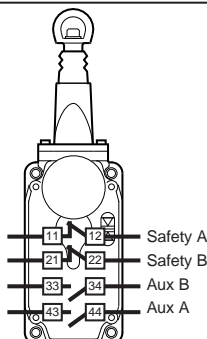
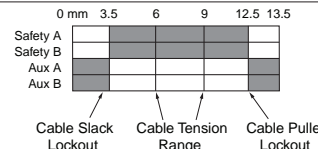
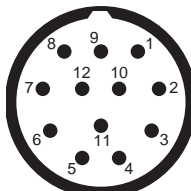
Description		2 N.C. & 2 N.O.
Contact Configuration		
Contact Action	<input type="checkbox"/> Open <input checked="" type="checkbox"/> Closed	
12-Pin M23  Pins 2, 5, 11 not connected	1-3	Safety A
	4-6	Safety B
	7-8	Aux A
	9-10	Aux B
	12	Ground
12-Pin Cordset 889M-FX9AE-*	Brown Blue	Safety A
	White Green	Safety B
	Yellow Grey	Aux A
	Pink Red	Aux B
	Green Yellow	Ground

\* Replace symbol with 0F5 (0.5 ft) or 1F (1 ft) for standard cable lengths.

# Operator Interface

## Enabling Switches

### Overview



#### Overview

An enabling device is a manually operated control device used in conjunction with a start control. The safety function of the enabling switch has two parts: 1) when continuously actuated, the enabling device allows machine operation, and 2) when not actuated, the enabling device initiates a stop command to prevent machine operation.

Historically, many enabling devices used a two-position switch. In the event of an unexpected incident, the two-position switch is designed to open when the muscles relax. The three-position switch provides enhanced performance as it is designed to open when the muscles either relax or contract. The trend in machine safeguarding is towards the use of three-position switches. Various types of devices use the three-position switch as enabling devices. These are typically push buttons, grip switches and foot switches.

The Allen-Bradley Guardmaster 440J is a hand-operated grip style enabling device. Underneath the rubber boot, called the trigger switch, the 440J enabling device has two three-position switches. The contacts are closed when the actuator is in the mid-position (partly depressed). The contacts are open when the actuator is in the rest (released) position and in the fully pressed position. When transitioning from fully pressed to released, the contacts remain open. The 440J meets the requirements of IEC 60947-5-8:2006, which was written to describe the performance and design requirements of three-position enabling devices.

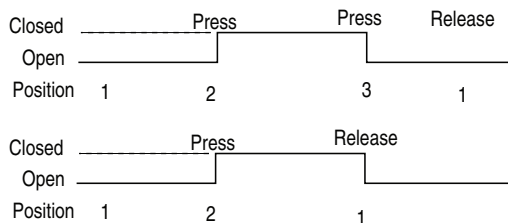
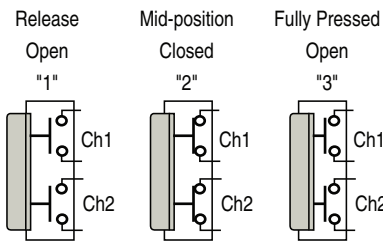

Enabling devices are typically used when access to the hazardous portion of the machine is needed while the machine is running. Visual observations, minor adjustments, troubleshooting, calibration, tool changes, and lubrication are examples of tasks that may utilize an enabling device. Before accessing the machine, the operator must usually place the machine in a reduced performance role. A risk assessment must be performed to determine the level of reduced performance. The concept is that in the event of an unexpected event, the operator will either release or squeeze the actuator of the enabling device and disable the machine, prior to getting injured.

The 440J enabling switches come in three models: 1) standard switch with no additional buttons, 2) switch with an additional single normally open contact, and 3) switch with an additional dual channel e-stop button.

The model with the normally open contact is typically used as a jog or reset function. The safety system design must only allow the use of the jog or reset function when the trigger switch is in the mid-position.

The e-stop button has two normally closed contacts with direct opening action. The e-stop button latches when the contacts open per IEC 60947-5-5 and ISO 13850. When this model is selected with the quick disconnect option, the user must store the enabling switch in an out-of-sight location if it is disconnected.

#### Mounting Considerations

All three 440J enabling switches come with a base plate. All three models are offered with either a cable strain-relief or an M12 micro quick-disconnect connector.

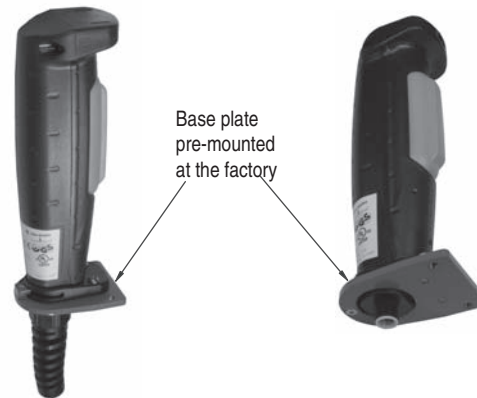

Cable Strain Relief

M12 Micro Quick Disconnect

In some applications, the operation of the switch contacts is all that is needed. In this case, the holding bracket 440J-A00N is used.



440J-A00N



Additional accessory brackets can be added to achieve various arrangements. Cat. No. 440J-A01N right angle bracket is designed to accommodate Cat. No. 440K-A1238 (standard actuator) which is used with the standard Trojan 6 or Trojan T15 and Cat. No. 440G-A27011 (GD2 actuator) which is used with the GD2 interlocks.

4-Emergency Stop Devices



440J-A01N  
 Bracket  
 Shown with  
 GD2 Actuator

With two additional screws, the right angle bracket can be mounted to the 440J enabling switch for horizontal mounting. An actuator can also be mounted for vertical use without the 440J-A01N bracket.



Shown with  
 440G-A27011  
 GD2 Actuator

Horizontal Mounting



Shown with  
 440K-A11095  
 Standard Actuator

Vertical Mounting



Horizontal Mount  
 with MT-GD2



Vertical Mount  
 with Trojan

In some applications, additional contacts are needed when the enabling switch is used. Two additional accessories are used to allow the enabling switch to interact with two interlocks.

Cat. No. 440J-A03N accessory mounts to the enabling switch base plate. This accessory has two sets of holes to accommodate either two standard or two GD2 actuators. This arrangement is used in conjunction with Cat. No. 440K-A04N accessory.

The mounting plate (Cat. No. 440J-A02N) has multiple pre-drilled and tapped holes to facilitate mounting of a single 440K-MT (MT-GD2) or 440K-T (Trojan) interlock. Four additional through-holes at the corners allow mounting of the plate to a flat surface.

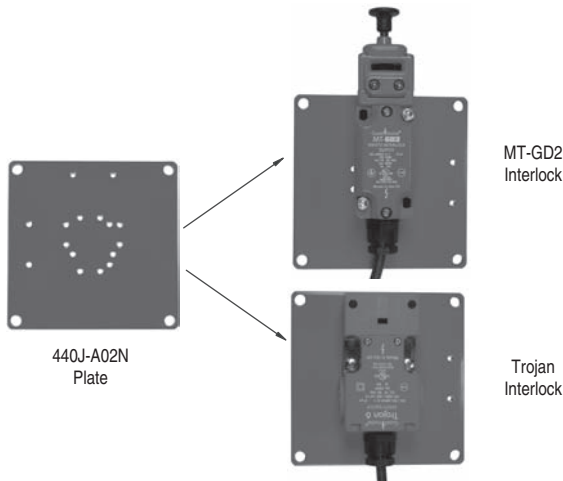

440J-A02N  
 Plate

MT-GD2  
 Interlock

Trojan  
 Interlock



440J-A03N



Enabling Switch mounted on  
 440J-A03N, shown with  
 two standard actuators

The U-shaped 440J-A04N can accommodate two interlocks: either 440K-MT or 440K-T. Using the 440J-A03N plate with dual actuators, a total of eight contacts, four in each switch, can be made available for the safety and control system.

The MT-GD2 with the manual latch release should be used for vertical mounting. The Trojan should only be used with horizontal actuator mounting. To use the 440K-T (Trojan 6 or T15), the head must be rotated 180°. The Trojan GD2 models cannot be used with the 440J-A02N as its head cannot be rotated.

The recommended method for single-switch mounting is to use the 440K-MT (MT-GD2) with the latch release. The latch holds the contacts closed when the enabling switch is bumped or rattled. An alternative is to use the 440K-T (Trojan 6 or T15) with a vertical mounting. The holding force of these interlocks is enough to keep the contacts closed under minor bumps and rattles.

Application Considerations



440J-A04N



Dual Interlock Switches  
 Provide Eight Contacts

Safety system designers will quickly realize that the enabling device by itself is easy to understand; it is simply a set of contacts. The application of the enabling device into a machine safeguarding system is the challenge.

Consideration must be given to the following:

1. Setting the machine in reduced performance mode.

In some cases, the speed or other characteristic of the machine must be reduced to allow the operator to avoid the hazard by releasing or squeezing the trigger switch. The control system must be designed so that the machine is not changed back to normal performance during the enabling task. A key-operated mode selector switch is one method of setting the machine in a reduced performance mode. The operator selects reduced mode and then removes the key from the switch, taking the key with him or her. Holding the trigger switch then allows the hazard to operate in a reduced mode.

2. Knowing the machine is in reduced performance mode

Sensors can be used to determine that reduced performance of the machine is maintained. Position sensors, encoders or other devices, monitored by an appropriated logic device, provide feedback to the control system. If the performance (e.g., operating speed) were to increase beyond a predetermined limit, the control system would execute a stop command. Releasing the enabling device could also be used to execute a stop command.

3. Type of access

The safety system architecture will differ depending on whether partial body or full body access is required.

When partial body access is required, the enabling device must continuously bypass the primary safeguard (e.g. gate interlock, light curtain, safety mat, or safety scanner). Enabling devices must only bypass one primary safeguard—bypassing multiple safeguards with one enabling device must be avoided as access to the hazard may not be detected by the other bypassed safeguards.

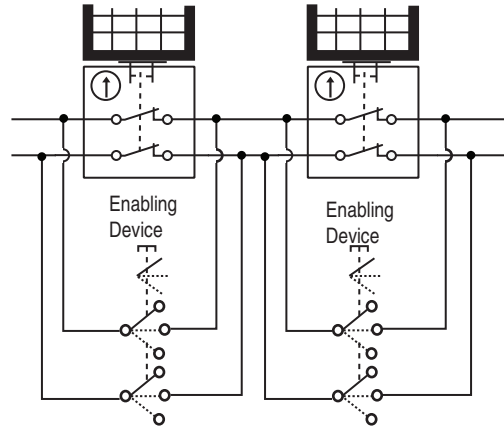

If full body access is required, consideration must be given to whether the primary safeguard can or must be active during the operation of the enabling device. With the primary safeguard active, additional entries into the hazard area will be detected. If the primary safeguard must remain inactive, administrative procedures must ensure that additional personnel do not enter the hazard area.

4. Multiple Personnel Access

When more than one person must access the hazard, all persons must utilize their own enabling device. All enabling devices must be active to energize the hazard.

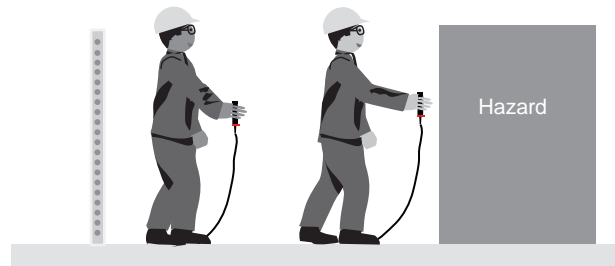

The table below summarizes when additional interlocking devices must be used in conjunction with the enabling device. For partial body access, three cases exist, depending on the type of device being bypassed and the logic unit used by the safety system.

1. The enabling switch can be connected directly across the safeguarding device that has dry contacts.
2. Devices with OSSD outputs, like the GuardShield Light curtain will need a single interlock with four contacts to avoid nuisance faults when a monitoring safety relay is used as the safety system logic device.
3. When a safety PLC is used as the logic device, the enabling device can be connected to separate inputs and internal programming logic can be used to bypass the light curtain when the enabling switch is needed.

For full body access, there are two cases, which depend on the logic device used by the safety system.

1. When a safety PLC is used, a single interlock with four contacts is needed. These four contacts are used to interlock the safety system reset function and the machine start function.
2. When a monitoring safety relay is used, two interlocks with four contacts each are needed. Four contacts are used to bypass the primary safeguarding device. Two contacts are used to reset the safety system. Two contacts are used to interlock the machine start control to prevent starting of the machine from the control panel.

Access Type	Safeguard Type	Logic Device	Interlocks Required
Partial Body	Dry Contact Interlocks (e.g., Elf, Cadet, Trojan, MT-GD2, Sipha, Ferrogard, 440G-MT, TLS-GD2, Atlas)	Monitoring Safety Relay or Safety PLC	None
		Safety PLC	
	Devices with OSSD Outputs (e.g., GuardShield Light Curtain, SensaGuard, SafeZone Multizone)	Monitoring Safety Relay	Single Interlock with Four Contacts
Full Body	All Types	Safety PLC	Single Interlock with Four Contacts
		Monitoring Safety Relay	Dual Interlocks, each with Four Contacts





### Description

The three position enabling switch can be used as part of the conditions required to allow safe working inside a machine guard, e.g., set-up, maintenance, or troubleshooting. It is lightweight and ergonomically designed for easy use. The standard model includes two independent three-position switches which are actuated by squeezing the trigger. Additional models are available with an optional jog button or dual channel e-stop button.

The trigger switch has three positions. The mid-position is the “enabled” position.

Position 1—there is no pressure on the trigger switch, and the safety contacts are open.

Position 2—the trigger switch is squeezed to the mid-position, and the safety contacts are closed. This mid-position is the “enabled” position.

Position 3—the trigger switch is fully pressed and the safety contacts are open.

When the trigger switch is released from position three back to position one, the safety contacts remain open, as it passes through position two.

### Features

- Dual three position enabling switches
- Lightweight and ergonomic
- Optional jog and e-stop functions

### Specifications

Safety Ratings				
Standards	IEC/EN60947-5-8, IEC/EN 60947-5-1, IEC/EN 60204-1, NFPA 79, ANSI B11.19, ANSIR15.06, ISO 10218, ISO 11161			
Safety Classification	Cat. 1 Device per EN954-1; Dual channel suitable for Cat. 3 or 4 systems			
Certifications	CE Marked for all applicable directives, cULus Listed, BG			
Outputs				
Safety Contacts *	2 N.C. direct opening action			
Auxiliary Contacts	1 N.C.			
Jog Contact	1 N.O.			
E-Stop	2 N.C. Direct-Opening Action			
Thermal Current/ $I_{th}$	3 A			
Rated Insulation Voltage	(Ui) 250V (jog button 125V)			
Switching Current @ Voltage, Min.	5 mA @ 3V AC/DC			
Utilization Category		30V DC	125V AC	250V AC
3-Position Switch Terminals 1-2 and 3-4	DC-12 or AC-12 Resistive	2 A	3 A	0.5 A
	DC-13 or AC-15 Inductive	1 A	1.5 A	0.5 A
Monitor Switch Terminals 5-6	DC-12 or AC-12 Resistive	2 A	2 A	1 A
	DC-13 or AC-15 Inductive	1 A	1 A	0.5 A
E-Stop Switch Terminals 5-6 and 7-8	DC-12 or AC-12 Resistive			
	DC-13 or AC-15 Inductive			0.5 A
Operating Characteristics				
Operating Force, Min.	Position 2: 15 N (3.37 lbf) approx. Position 3: 50 N (11.2 lbf) max.			
Direct Opening Force	90 N (20 lbf)			
Actuation Frequency, Max.	1200 operations per hour			
Environmental				
Enclosure Type Rating	IP66 Standard Switch (NEMA 6) IP65 Jog Button and E-Stop Switches			
Relative Humidity	45...85%			
Operating Temperature [C (F)]	-10...+60° (14...140°)			
Vibration	5...55 Hz, 0.5 mm			
Shock	10 g			
Physical Characteristics				
Wire Size	0.14...1.5 mm <sup>2</sup> (24...14 AWG)			
Cable Size	7...13 mm (0.27... 0.51 in.)			
Terminal Screw Torque	0.5...0.6 N•m (4.4...5.3 ibf•in)			
Conduit Type	M20			
Material	Polyamide (Nylon) PA66			
Boot Material	NBR/PVC Nitrile Blended with PVC			
Weight [g (lb)]	250 (0.55) with E-stop 210 (0.46) standard and jog			
Color	Black/grey			

\* The safety contacts are described as normally closed (N.C.) i.e., with the guard closed, actuator in place (where relevant) and the machine able to be started.



## Product Selection

Description	Cat. No.
	M20 Conduit with Cable Strain Relief
Standard Switch (No additional buttons)	440J-N21TNPM
Switch with Jog Button	440J-N21TNPM-NP
Switch with Emergency Stop Button	440J-N2NTNPM-NE

**Note:** Base plate included with all switches.

## Recommended Logic Interfaces

Description	Safety Outputs	Auxiliary Outputs	Terminals	Reset Type	Power Supply	Cat. Page No.	Cat. No.
<b>Single-Function Safety Relays for 2 N.C. Contact Switch</b>							
MSR127RP	3 N.O.	1 N.C.	Removable (Screw)	Monitored Manual	24V AC/DC	5-26	<b>440R-N23135</b>
MSR127TP	3 N.O.	1 N.C.	Removable (Screw)	Auto./Manual	24V AC/DC	5-26	<b>440R-N23132</b>
<b>Modular Safety Relays</b>							
MSR210P Base 2 N.C. only	2 N.O.	1 N.C. and 2 PNP Solid State	Removable	Auto./Manual or Monitored Manual	24V DC from the base unit	5-82	440R-H23176
MSR220P Input Module	—	—	Removable	—	24V DC	5-86	440R-H23178
MSR310P Base	MSR300 Series Output Modules	3 PNP Solid State	Removable	Auto./Manual Monitored Manual	24V DC	5-102	440R-W23219
MSR320P Input Module	—	2 PNP Solid State	Removable	—	24V DC from the base unit	5-106	440R-W23218

**Note:** For additional Safety Relays connectivity, see page 5-4.  
 For additional Safety I/O and Safety PLC connectivity, see page 5-116.  
 For application and wiring diagrams, see page 10-1.







## Connection Systems

Description	Cat. No.		
	4-Pin Micro (M12) Quick Disconnect	5-Pin Micro (M12) Quick Disconnect†	8-Pin Micro (M12) Quick Disconnect
Cordset	889D-F4AC-♣	889D-F5AC-♣	889D-F8AB-♣
Patchcord	889D-F4ACDM-§	889D-F5ACDM-§	889D-F8ABDM-§

♣ Replace symbol with 2 (2 m), 5 (5 m), or 10 (10 m) for standard cable lengths.  
 § Replace symbol with 1 (1 m), 2 (2 m), 5 (5 m), or 10 (10 m) for standard cable lengths.  
 † To connect to ArmorBlock Guard I/O.

Operator Interface  
**Enabling Switches**  
 GripSwitch

Accessories

	Description	Cat. No.
	Mounting bracket suitable for single enabling switch*	440J-A00N
	Mounting bracket suitable for one actuator mounted onto switch* Includes four flat head screws and one resistorx bit.	440J-A01N
	Mounting bracket suitable for single enabling switch and single safety switch*	440J-A02N
	Mounting bracket suitable for two actuators mounted onto switch* Includes six flat head screws and one resistorx bit.	440J-A03N
	Mounting bracket suitable for single enabling switch and two safety switches*	440J-A04N
	NBR/PVC (silicone free) rubber boot kit	440J-A10N

\* The bracket has predrilled holes suitable for mounting either the MT-GD2, Trojan 5, or Trojan 6. Please note that the enabling switch, safety switch, and actuator are not supplied with the mounting bracket and are available separately.

**Approximate Dimensions**

Dimensions are shown in mm (in.). Dimensions are not intended to be used for installation purposes.

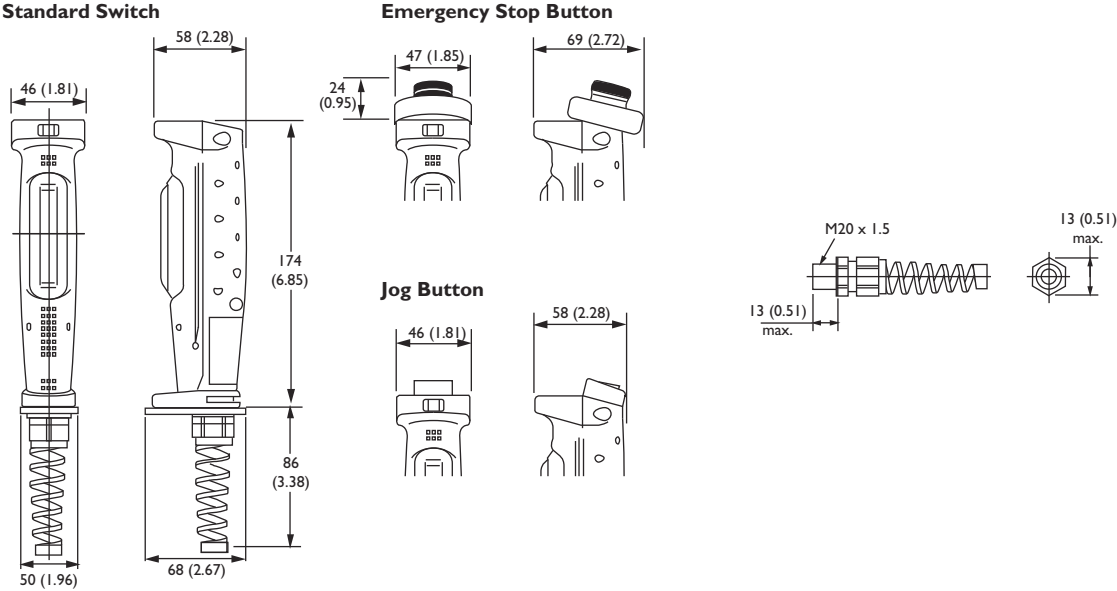

A range of brackets are available to allow the enabling switch to be mounted alone, or with one or two safety switches. A small bracket has already been fitted to the enabling switch onto which the actuator bracket is mounted. An Application Note on the use of the enabling switch in conjunction with a safety switch is available.

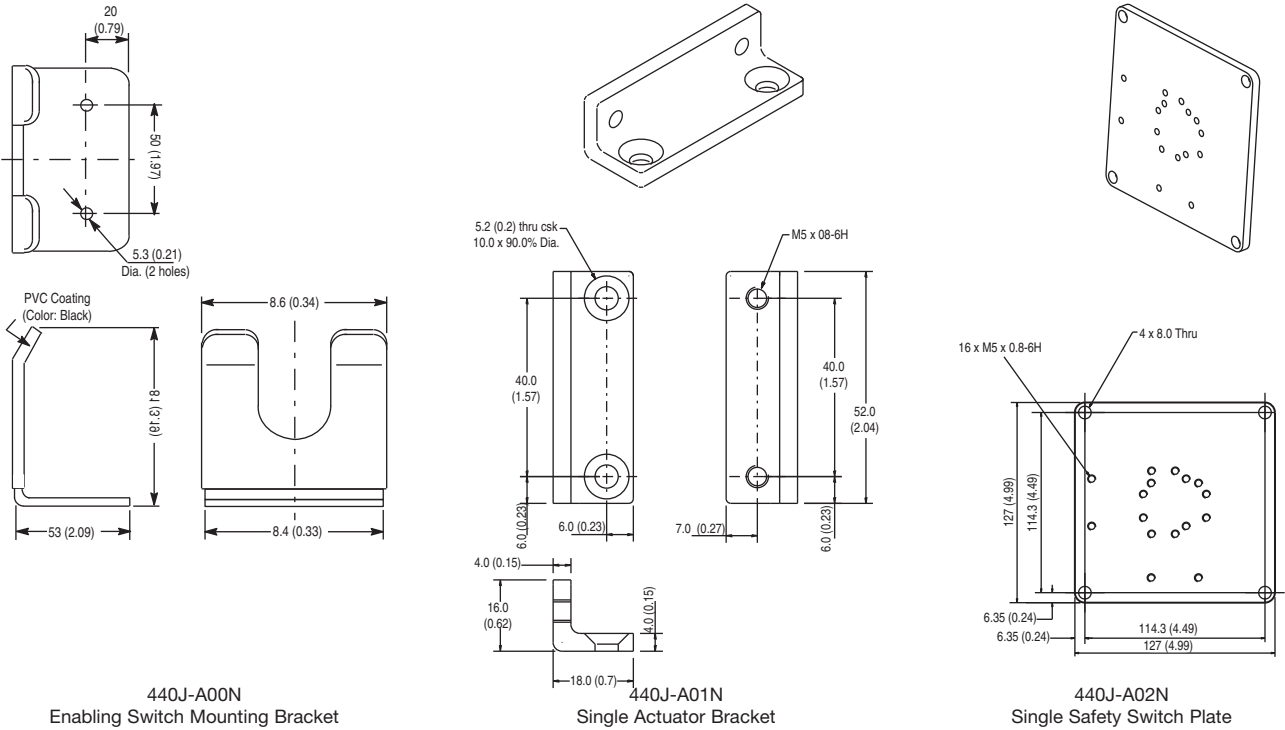

4-Emergency Stop Devices

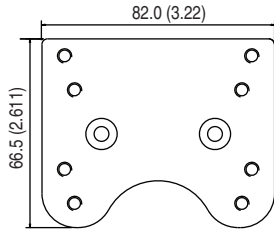
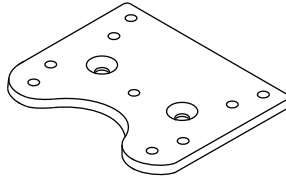

440J-A03N  
 Double Actuator Plate

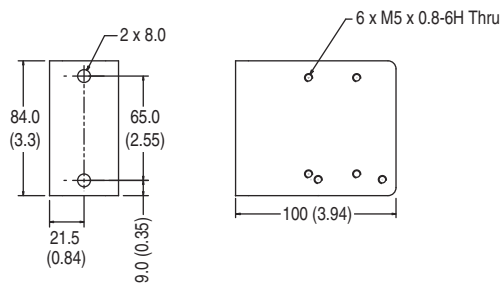
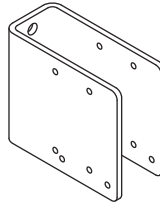

440J-A04N  
 Double Safety Switch Bracket

**Typical Wiring Diagram**

	Standard	With Jog Button	With E-Stop Button
Contact Operation  □ Contact Open   ■ Contact Closed			
Cable Termination			
Quick Disconnect Termination			
Mating Cordsets	889D-F4AC-*	889D-F5AC-*	889D-F8AB-*
	1 Brown    Safety A	1 Brown    Safety A	1 White    Safety A
	2 White	2 White	2 Brown    Safety A
	—	3 Blue    NA	3 Green    Safety B
3 Blue    Safety B	4 Black    Safety B	4 Yellow    Safety B	
4 Black	5 Grey    Aux	5 Grey    E-Stop A	
—	5 Grey    Safety B	6 Pink    E-Stop A	
—	—	7 Blue    Jog	
—	—	8 Red    E-Stop B	

4-Emergency Stop Devices



**Specifications — 22.5 mm\***  
**Front-of-Panel (Operators)**

Description		Mechanical Ratings	
		Plastic (Bulletin 800FP)	Metal (Bulletin 800FM)
Vibration (assembled to panel)		Tested at 10...2000 Hz, 1.52 mm displacement (peak-to-peak) max./10 G max. for 3 hr duration, no damage	
Shock		Tested at 1/2 cycle sine wave for 11 ms; no damage at 100 G	
Degree of protection*		IP65/66 (Type 3/3R/4/4X/12/13)	IP65/66 (Type 3/3R/4/12/13)
Mechanical durability per EN 60947-5-1 (Annex C)	10 000 000 Cycles	Momentary push buttons, momentary mushroom	
	1 000 000 Cycles	Multi-function, selector switch, key selector switch, selector jog, SensEject™ key selector switch	
	500 000 Cycles	Non-illuminated push-pull E-stop	
	300 000 Cycles	Twist-to-release E-stop, illuminated push-pull E-stop, alternate action push buttons	
	100 000 Cycles	Potentiometer, toggle switch	
Operating forces (typical with one contact block)		Flush/extended = 5 N, E-stop = 36 N Mushroom = 9 N	
Operating torque (typical application with one contact block)		Selector switch = 0.25 N•m (2.2 lb•in)	
Mounting torque	Plastic	1.7 N•m (15 lb•in)	
	Metal	4.4 N•m (40 lb•in)	
Environmental			
Temperature range (operating)		-25...+70 °C (-13...158 °F)‡	
Temperature range (short term storage)		-40...+85 °C (-40...185 °F)	
Humidity		50...95% RH from 25...60 °C (77...140 °F)	

\* Performance Data — see page Important-3 of the Industrial Controls catalog.

‡ Momentary mushroom operators are IP65. Plastic keyed operators are IP66, Type 4/13; not Type 4X.

‡ Operating temperatures below 0 °C (32 °F) are based on the absence of freezing moisture and liquids, UL Recognized to 55 °C (131 °F) - Incandescent module Max 40 °C (104 °F).

**Product Certifications**

Certifications	UR/UL, CSA, CCC, CE
Standards Compliance — CE Marked	NEMA ICS-5; UL 508, EN ISO 13850, EN 60947-1, EN 60947-5-1, EN 60947-5-5
Terminal Identification	EN/IEC 60947-1
Shipping Approvals	ABS
RoHS	✓

Operator Interface  
**Push Buttons**  
 Bul. 800F 22.5 mm

Back-of-Panel Components

Electrical Ratings			
Standard contact block ratings		A600, Q600 600V AC AC 15, DC 13 to IEC/EN 60947-5-1 and UL 508, 17V, 5 mA min.	
Low voltage contact block ratings*		5V, 1 mA DC min. C300, R150, AC 15, DC 13 to EN 60947-5-1 and UL 508	
	<b>Nominal Voltage</b>	<b>Range</b>	<b>Current Draw</b>
LED Module Ratings	24V AC	10...29V AC	31 mA
	24V DC	10...30V DC	24 mA
	120V AC	70...132V AC	25 mA
	240V AC	180...264V AC	22 mA
Thermal current		10 A max. enclosed (40 °C ambient) to UL508, EN 60947-5-1	
Insulation voltage (Ui)		Screw terminal = 690V, spring-clamp = 300V	
Wire capacity (screw terminal)‡		#18...12 AWG (0.75...2.5 mm <sup>2</sup> ) Max. (2) #14 AWG or (1) #12 AWG	
Wire capacity (spring-clamp terminal)		#18...14 AWG (0.75...1.5 mm <sup>2</sup> ) One per spring clamp, two spring clamps per terminal	
Recommended tightening torque on screw terminals		0.7...0.9 N•m (6...8 lb•in)	
Dielectric strength (minimum)		2500V for one minute	
External short circuit protection	Standard blocks	10 A type gL/gG cartridge fuse to EN 60269-2-1 or gN (Class J to UL 248-8 or Class C to UL 248-4)	
	Low voltage contact blocks	6 A type gL/gG cartridge fuse to EN 60269-2-1 or gN (Class J to UL 248-8 or Class C to UL 248-4)	
Electrical shock protection		Finger-safe conforming to IP2X	
Mechanical Ratings			
Vibration (assembled to panel)		Tested at 10...2000 Hz, 1.52 mm displacement (peak-to-peak) max./10 G max. 6 hr	
Shock		Tested at 1/2 cycle sine wave for 11 ms and no damage at 100 G max.	
Contact durability per EN 60947-5-1 (Annex C)		10 000 000 cycles	
Contact operation	N.O.	Slow double make and break	
	N.C.	Slow double make and break — positive opening ⊖	
	N.O.E.M.	Double break / double make, early make	
	N.C.L.B.	Double break / double make, late break — positive opening ⊖	
	N.C.E.B.	Double break / double make, early break — positive opening ⊖	
Push button travel to change electrical state	N.C. and N.O.E.M.	1.5 mm (0.060 in.)	
	N.O. and N.C.L.B.	2.5 mm (0.1 in.)	
Operating forces (typical)	Single circuit contact block	3.4 N	
	Dual circuit contact block	5...6.5 N	
Illumination			
LED Dominant Wavelength	Green	525 nm	
	Red	629 nm	
	Yellow	590 nm	
	Blue	470 nm	
	White	—	
LED Luminous Intensity	Green	780 mcd	
	Red	780 mcd	
	Yellow	600 mcd	
	Blue	168 mcd	
	White	360 mcd	
Incandescent maximum wattage		2.6 W	
Materials			
Springs		Stainless steel and zinc coated music wire	
Electrical contacts	Standard	Silver-nickel	
	Low voltage	Gold-plated over silver	
Terminals	Screw	Brass	
	Spring-clamp	Silver-plated brass	

\* Performance Data — see page Important-3 of the Industrial Controls catalog.

\* Low voltage contacts are recommended for applications below 17V, 5 mA.

‡ Wires less than #18 AWG (0.75 mm<sup>2</sup>) may not hold in terminal securely.

4-Emergency Stop Devices



## Material Listing

Component	For Use with	Material Used
Panel gasket	All operators	Nitrile, TPE
Diaphragm seal	Illuminated push button, non-illuminated push button	Automotive industry acceptable silicone
K-seal	Selector switch, key selector switch, push/twist-to-release E-stop, key E-stop, push/pull mushroom	Nitrile
Diaphragm retainer, return spring I	Illuminated push button, non-illuminated push button, momentary mushroom	Stainless steel
Return spring II	Reset, selector switch, key selector switch, alternate action, push/twist-to-release E-stop, key E-stop, push/pull mushroom	Zinc-coated music wire
Button cap/mushroom head	Non-illuminated push button, momentary mushroom, reset, push/twist-to-release E-stop, key E-stop, push/pull mushroom, multi-function	PBT/polycarbonate blend
2-color molded button cap	Non-illuminated push button	PBT/polycarbonate blend
Lens	Multi-function	Acetal
Lens, knob	Illuminated push button, illuminated momentary mushroom, illuminated selector switch	Polyamide
Knob	Non-illuminated selector switch	Glass-filled polyamide
Plastic bezel/bushing I	Non-illuminated push button, illuminated push button, momentary mushroom, selector switch, key selector switch, push/twist-to-release E-stop, key E-stop, push/pull mushroom, multi-function, reset	Glass-filled polyamide
Plastic bezel/bushing II, jam nut	Pilot light, reset jam nut, reset pushers	Glass-filled PBT
Metal bezel/bushing	All metal operators	Zinc
Diffuser	Illuminated push button, pilot light	Polycarbonate
Legend frames	—	Glass-filled polyamide
Plastic mounting ring	All plastic operators	Glass-filled polyamide
Metal mounting ring	All metal operators	Chromated zinc
Plastic latch	—	Glass-filled polyamide
Metal latch	—	Chromated zinc + stainless steel
Plastic enclosure	—	PBT/polycarbonate blend
Metal enclosure	—	Aluminum
Terminal screws	LED module, incandescent module, contact blocks	Zinc-plated steel with chromate
Terminals	LED module, incandescent module, contact blocks	Brass with silver-nickel contacts
Spring clamps	LED module, incandescent module, contact blocks	Stainless steel
Lamp socket	Incandescent module	Brass
Housing	Incandescent module, LED module	Glass-filled polyamide
Low-voltage terminals	Contact blocks	Gold-plated silver-nickel contacts
Low-voltage spanner	Contact blocks	Gold-plated silver-nickel contacts
Spanner	Contact blocks	Brass with silver-nickel contacts
Boot	Toggle Switch, illuminated push button, non-illuminated push button, multi-function illuminated and non-illuminated	Automotive industry acceptable silicone

Operator Interface  
**Push Buttons**  
 Bul. 800F 22.5 mm

Emergency Stop Operators\*

Non-Illuminated Twist-to-Release, Push-Pull



**60 mm Non-Illuminated Twist-to-Release**  
 Cat. No. 800FP-MT64



**40 mm Non-Illuminated Push-Pull**  
 Cat. No. 800FP-MP44

Color	Size	Pkg. Quantity	Twist-to-Release (Trigger Action)		Push-Pull (Trigger Action)	
			Plastic	Metal	Plastic	Metal
			Cat. No.	Cat. No.	Cat. No.	Cat. No.
Red	30	1	800FP-MT34	800FM-MT34	–	–
	40		800FP-MT44	800FM-MT44	800FP-MP44	800FM-MP44
	60		800FP-MT64	800FM-MT64	–	–

Illuminated — Twist-to-Release, Push-Pull‡



**40 mm Illuminated Twist-to-Release**  
 Cat. No. 800FP-LMT44



**40 mm Mushroom Push/Pull**  
 Cat. No. 800FM-LMP44

Color	Size	Pkg. Quantity	Twist-to-Release (Trigger Action)		Push-Pull (Trigger Action)	
			Plastic	Metal	Plastic	Metal
			Cat. No.	Cat. No.	Cat. No.	Cat. No.
Red	30	1	–	–	800FP-LMP34	800FM-LMP34
	40		800FP-LMT44	800FM-LMT44	800FP-LMP44	800FM-LMP44
	60		800FP-LMT64	800FM-LMT64	800FP-LMP64	800FM-LMP64

‡ LED module required for illumination, can not use incandescent module.

Key Release Mushroom Operator



**40 mm Non-Illuminated Key Release**  
 Cat. No. 800FP-MK44

Color	Size	Pkg. Quantity	Ronis Key Lock (Trigger Action)*	
			Plastic	Metal
			Cat. No.	Cat. No.
Red	40 mm	1	800FP-MK44	800FM-MK44

\* All emergency stop operators are EN ISO 13850 compliant with standard NC, NCLB, or self-monitoring contact blocks.

\* For key options, see the Industrial Controls catalog.



2-Position Push-Pull Operators, Non-Illuminated — Twist-to-Release (Trigger Action), Push-Pull (Trigger Action)\*



40 mm Trigger Action  
 Twist-to-Release Mushroom  
 Cat. No. 800FP-MT44



40 mm Trigger Action  
 Push-Pull Mushroom  
 Cat. No. 800FP-MP44



90 mm Half-Dome  
 Cat. No. 800FP-MP94

Color	Pkg. Quantity	40 mm Mushroom (Trigger Action) Twist-to-Release		40 mm Mushroom (Trigger Action) Push-Pull	
		Plastic	Metal	Plastic	Metal
		Cat. No.	Cat. No.	Cat. No.	Cat. No.
Red	1	800FP-MT44	800FM-MT44	800FP-MP44	800FM-MP44

800F **P** - **MT4** **4**   
*a            b            c            d*

*a*

Operator Construction	
Code	Description
P	Round plastic operator (IP66, Type 4/4X/13)
M	Round metal operator (IP66, Type 4/13)

*b*

Operator Type	
Push, Twist-to-Release >	
Code	Type
MT3	30 mm color cap
MT4	40 mm color cap
MT6	60 mm color cap
Push-Pull	
Code	Type
MP4	40 mm color cap
Half-Dome Push-Pull	
Code	Type
MP9	90 mm color cap*

*c*

Color Cap	
Code	Color
2	Black
3	Green
4	Red
5	Yellow
6	Blue

*d* ‡ § ¶

Engraving	
Code	Description
Blank	No engraving on cap
LE	EMO laser engraved
E	EMO printed

- \* All emergency stop operators are EN ISO 13850 compliant with standard NC, NCLB, or self-monitoring contact blocks.
- > Only available with red color cap.
- ‡ For EMO guards, see page 4-45.
- § Only available on 40 mm color cap.
- ¶ Only available on red, 40 mm push, twist-to-release operator type (MT44).
- \* Half-dome operators only available with black, red, and yellow color caps.

Operator Interface  
**Push Buttons**  
 Bul. 800F 22.5 mm

2-Position Push-Pull Operators, Illuminated — Twist-to-Release (Trigger Action), Push-Pull (Trigger Action)\*‡



40 mm Mushroom Trigger Action Twist-to-Release  
 Cat. No. 800FP-LMT44



40 mm Mushroom Push/Pull  
 Cat. No. 800FM-LMP44



90 mm Half-Dome  
 Cat. No. 800FP-LMP94

Color	Pkg. Quantity	40 mm Mushroom (Trigger Action) Twist-to-Release		40 mm Mushroom (Trigger Action) Push-Pull	
		Plastic	Metal	Plastic	Metal
		Cat. No.	Cat. No.	Cat. No.	Cat. No.
Red	1	800FP-LMT44	800FM-LMT44	800FP-LMP44	800FM-LMP44

800F **P** - **LMP4** **3**  
 a b c

a

Operator Construction	
Code	Description
P	Round plastic operator (IP66, Type 4/4X/13)
M	Round metal operator (IP66, Type 4/13)

b

Operator Type	
Push, Twist-to-Release‡§	
Code	Type
LMT4	40 mm color cap
LMT6	60 mm color cap
Push-Pull	
Code	Type
LMP3	30 mm color cap
LMP4	40 mm color cap
LMP6	60 mm color cap
Half-Dome Push-Pull	
Code	Type
LMP9	90 mm color cap‡¶

c

Lens Cap Color	
Code	Color
3	Green
4	Red
5	Yellow➤
6	Blue♣

- \* LED module required for illumination, can not use incandescent module.
- ‡ All emergency stop operators are EN ISO 13850 compliant with standard NC, NCLB, or self-monitoring contact blocks.
- ‡ Only available with red color cap.
- § 60 mm version has black arrows; 30 and 40 mm versions have white arrows.
- When using LED for illumination, a white LED is recommended.
- ♣ Only available with 40 mm Push-Pull color cap (**LMP4** from Table b).
- ¶ Half-dome operators only available with red and yellow lens cap colors.

2-Position Non-Illuminated Operators — Mushroom, Key Release (Trigger Action)\*



40 mm Key Release Mushroom  
 Cat. No. 800FP-MK44

Color	Pkg. Quantity	2-Position (Trigger Action) 40 mm Mushroom Key Release	
		Plastic	Metal
		Cat. No.	Cat. No.
Red	1	800FP-MK44	800FM-MK44

**Note:** For Ronis replacement keys, see the Industrial Controls catalog. Key release mushroom operators use key no. 3825.

800F **P** - **MK4** **4** **d**  
*a b c d*

*a*

Operator Construction	
Code	Description
P	Round plastic operator (IP66, Type 4/13)
M	Round metal operator (IP66, Type 4/13)

*b*

Operator Type	
Key Release Mushroom	
Code	Type
MK4	40 mm

*c*

Lens Cap Color	
Code	Color
4	Red

*d*

Ronis Key Lock**‡§	
Code	Key No.
Blank	3825 (Standard)
R	455
01R	3801
02R	3802
03R	3803
04R	3804
05R	3805
06R	3806
27R	4001
28R	4002
29R	4003
30R	4004
31R	4005
32R	4006
33R	4007

\* All emergency stop operators are EN ISO 13850 compliant with standard NC, NCLB, or self-monitoring contact blocks.

\*\* Keyed operators are IP66, Type 4/13.

‡ Not intended for high security applications. Interoperability is possible with certain key/cylinder lock combinations. Consult your local Rockwell Automation sales office or Allen-Bradley distributor for interoperability information.

§ For Ronis replacement keys, see the Industrial Controls catalog.

Operator Interface  
**Push Buttons**  
 Bul. 800F 22.5 mm

3-Position Push-Pull Operators, Illuminated & Non-Illuminated — Mushroom♣



**Illuminated 3-Position Push-Pull**  
 Cat. No. 800FM-LMP44E3

Target Table and Operator Position*			
Contact Type†			
	Out	Center	In
N.O.	O	O	X
N.C.E.B.	X	O	O
N.C.L.B.	X	X	O

Note: X = Closed/O = Open

† Contact selection is limited to the following options, consult your local Rockwell Automation sales office or Allen-Bradley distributor for other options.

Operator Function	Operator Type	Color	Pkg. Quantity	Cat. No.
Momentary Out, Maintained Center, Momentary In	Non-Illuminated	Black§	1	800FM-MM42E3
		Green		800FM-MM43E3
		Red		800FM-MM44E3
	Illuminated*	Amber‡		800FM-LMM40E3
		Green		800FM-LMM43E3
		Red		800FM-LMM44E3
		Blue‡		800FM-LMM46E3
		Clear‡		800FM-LMM47E3
Momentary Out, Maintained Center, Maintained In	Non-Illuminated	Black§	1	800FM-MP42E3
		Green		800FM-MP43E3
		Red		800FM-MP44E3
	Illuminated*	Amber‡		800FM-LMP40E3
		Green		800FM-LMP43E3
		Red		800FM-LMP44E3
		Blue‡		800FM-LMP46E3
		Clear‡		800FM-LMP47E3

800F **M** - **L** **MM** **4** **4** **E3**  
 a b c d e f

a

Operator Construction	
Code	Description
M	Round metal operator (IP66, Type 4/13)

b

Operator Type	
Code	Description
Blank	Non-Illuminated
L	Illuminated*

c

Operator Function	
Code	Description
MM	Momentary Out, Maintained Center, Momentary In
MP	Momentary Out, Maintained Center, Maintained In

d

Cap Size	
Code	Description
4	40 mm Plastic

e

Cap Color	
Code	Description
0	Amber‡
2	Black§
3	Green
4	Red
6	Blue‡
7	Clear‡

f

Positions	
Code	Description
E3	3-Position

♣ Sold as stand-alone operator only. Not available as a composite catalog number.

\* Cannot use N.C. or N.O.E.M. contact blocks with 3-position push-pull operators. Must use N.O., N.C.E.B., or N.C.L.B. contact blocks.

\* Available in integrated LED version only.

‡ Available in illuminated only.

§ Available in non-illuminated only.

4-Emergency Stop Devices

Momentary Push Button Operators, Non-Illuminated — Mushroom\*



**40 mm Mushroom**  
 Cat. No. 800FP-MM42



**60 mm Mushroom**  
 Cat. No. 800FP-MM63



**90 mm Mushroom**  
 Cat. No. 800FP-MM94

Color	Pkg. Quantity	40 mm Mushroom		60 mm Mushroom	
		Plastic	Metal	Plastic	Metal
		Cat. No.	Cat. No.	Cat. No.	Cat. No.
Black	1	800FP-MM42	800FM-MM42	<b>800FP-MM62</b>	800FM-MM62
Green		800FP-MM43	800FM-MM43	<b>800FP-MM63</b>	800FM-MM63
Red		800FP-MM44	800FM-MM44	<b>800FP-MM64</b>	800FM-MM64
Yellow		800FP-MM45	800FM-MM45	<b>800FP-MM65</b>	800FM-MM65
Blue		<b>800FP-MM46</b>	<b>800FM-MM46</b>	<b>800FP-MM66</b>	800FM-MM66

800F **P** - **MM4** **3**  
           a            b            c

a

Operator Construction	
Code	Description
P	Round plastic operator (IP65, Type 4/4X/13)
M	Round metal operator (IP65, Type 4/13)

b

Size and Operator Type	
Mushroom	
Code	Type
MM4	40 mm momentary
MM6	60 mm momentary
MM9	90 mm momentary*

c

Color Cap	
Code	Color
2	Black
3	Green
4	Red
5	Yellow
6	Blue

\* Momentary mushroom operators are IP65 rated.  
 \* Only available with black, red, and yellow cap colors.

Operator Interface  
**Push Buttons**  
 Bul. 800F 22.5 mm

Momentary Push Button Operators, Illuminated — Mushroom\*



**40 mm Mushroom**  
 Cat. No. 800FP-LMM43

Color	Pkg. Quantity	40 mm Mushroom	
		Plastic	Metal
		Cat. No.	Cat. No.
Green	1	800FP-LMM43	800FM-LMM43
Red		800FP-LMM44	800FM-LMM44
Yellow		800FP-LMM45	800FM-LMM45
Blue		<b>800FP-LMM46</b>	<b>800FM-LMM46</b>
Clear		<b>800FP-LMM47</b>	<b>800FM-LMM47</b>

800F **P** - **LMM4** **3**  
*a* *b* *c*

*a*

Operator Construction	
Code	Description
P	Round plastic operator (IP65, Type 4/4X/13)
M	Round metal operator (IP65, Type 4/13)

*b*

Size and Operator Type	
Mushroom	
Code	Type
LMM4	40 mm momentary

*c*

Lens Cap Color	
Code	Color
3	Green
4	Red
5	Yellow*
6	Blue
7	Clear

\* Momentary mushroom operators are IP65 rated.  
 \* When using LED for illumination, a white LED is recommended.

Back-of-Panel Components

Contact Blocks with Latch — Composite

800F – **P** **X** **0** **1** **E**  
*a* *b* *c* *d* *e*



*a*

Style	
Code	Description
P	Plastic latch
M	Metal latch

*b*

Contact Block(s) Termination Style*	
Code	Description
X	Screw termination
Q	Spring-clamp termination

\* Six circuits maximum allowable.

*c*

N.O. (Normally Open) Circuits	
Code	Description
0	No contact
1	1 N.O.
2	2 N.O.
3	3 N.O.
4	4 N.O.
5	5 N.O.
6	6 N.O.

*d*

N.C. (Normally Closed) Circuits	
Code	Description
0	No contact
1	1 N.C.
2	2 N.C.
3	3 N.C.
4	4 N.C.
5	5 N.C.
6	6 N.C.

*e*

Specialty Contact Block(s)	
Code	Description
Blank	Standard blocks
V	Low voltage — QuadCONNECT™
E	N.O. early make
L	N.C. late break
B	N.C. early break
S	N.C. self-monitoring

Power Modules

Power Modules with Latch — Composite

800F – **M** **N** **3** **G**  
*a* *b* *c* *d*



*a*

Style	
Code	Description
P	Plastic latch
M	Metal latch

*b*

Power Module Type†§	
Code	Description
D	Incandescent module, screw termination
N	Integrated LED module, screw termination
Q	Integrated LED module, spring-clamp termination

*c*

Voltage	
Code	Description
0	No bulb♣
1	6V AC/DC♣
2	12V AC/DC♣
3	24V AC/DC
4	48V AC/DC♣
5	120V AC
7	240V AC➤

*d*

Lamp Color⌘	
Code	Description
C	Incandescent
R	Red LED
G	Green LED
Y	Amber LED
W	White LED
B	Blue LED

† LED modules for use with all illuminated operators. Incandescent module for use with pilot lights, momentary push buttons, and momentary mushroom operators only.

§ Four circuits maximum allowable when power module is used. Do not stack contact block on power module.

♣ Only available for incandescent module.

➤ Only available for integrated LED module.

⌘ For best illumination results, LED color should match lens color. For yellow operator, select a white LED.

Back-of-Panel Components, Continued

Power Modules with Contact Blocks and Latch — Composite

800F – **P** **N** **5** **R** **X** **1** **0** **E**  
*a b c d e f g h*

*a*

Style	
Code	Description
P	Plastic latch
M	Metal latch

*b*

Power Module Type*†	
Code	Description
D	Incandescent module, screw termination
N	Integrated LED module, screw termination
Q	Integrated LED module, spring-clamp termination

*c*

Voltage	
Code	Description
0	No bulb‡
1	6V AC/DC‡
2	12V AC/DC‡
3	24V AC/DC
4	48V AC/DC‡
5	120V AC
7	240V AC§

*d*

Lamp Color*	
Code	Description
C	Incandescent
R	Red LED
G	Green LED
Y	Amber LED
W	White LED
B	Blue LED

*e*

Contact Block(s) Termination Style	
Code	Description
X	Screw termination
Q	Spring-clamp termination

*f*

N.O. (Normally Open) Circuits	
Code	Description
0	No contact
1	1 N.O.
2	2 N.O.
3	3 N.O.
4	4 N.O.

*g*

N.C. (Normally Closed) Circuits	
Code	Description
0	No contact
1	1 N.C.
2	2 N.C.
3	3 N.C.
4	4 N.C.

*h*

Specialty Contact Block(s)	
Code	Description
Blank	Standard blocks
V	Low voltage — QuadCONNECT™
E	N.O. early make
L	N.C. late break
S	N.C. self-monitoring

\* Four circuits maximum allowable when power module is used. Do not stack contact block on power module.

† LED modules for use with all illuminated operators. Incandescent module for use with pilot lights, push buttons, and momentary mushroom operators only.

‡ Only available for incandescent module.

§ Only available for integrated LED module.





♣ For best illuminated results, LED should match lens color. For yellow operator, select a white LED.





Operator Interface  
**Push Buttons**  
 Bul. 800F 22.5 mm

Back of Panel Components, Continued  
 Other

	Description	Volts	Pkg. Quantity	Cat. No.
 Cat. No. 800F-D3C	<b>Incandescent Module</b> For use with pilot lights, push buttons, and momentary mushroom operators. <b>Note:</b> Sold in multiples of 10. Order (quantity of) 10 to receive one package of 10 pieces. Latch not included.	No bulb	10	800F-D0C
		6V AC/DC		800F-D1C
		12V AC/DC		800F-D2C
		24V AC/DC		800F-D3C
		48V AC/DC		800F-D4C
		120V AC/DC		800F-D5C
 Cat. No. 800F-N3G	<b>Integrated LED Module</b> For use with all illuminated devices. For best results, LED should match lens color. For amber operators, use yellow LED. <b>Note:</b> Sold in multiples of 10. Order (quantity of) 10 to receive one package of 10 pieces. Latch not included.	24V AC/DC	10	* 800F-N3x
		120V AC		* 800F-N5x
		240V AC		* 800F-N7x
		24V AC/DC spring-clamp		* 800F-Q3x
		120V AC spring-clamp		* 800F-Q5x
		240V AC spring-clamp		* 800F-Q7x
		24V AC/DC ring lug		*‡ 800F-R3x
	Description	Contact Material	Pkg. Quantity	Cat. No.
 Cat. No. 800F-BX01	<b>Base Mounted Contact Block</b> Base mounted contact blocks can be used in plastic or metal enclosures. <b>Note:</b> Sold only in multiples of 10. Order (quantity of) 10 to receive one package of 10 pieces. Latch not included.	N.O.	10	800F-BX10
		N.C.		800F-BX01
		N.O. low voltage — QuadCONNECT™		800F-BX10V
		N.C. low voltage — QuadCONNECT™		800F-BX01V
		N.O.E.M.		800F-BX10E
		N.C.L.B.		800F-BX01L
		N.O. spring-clamp		800F-BQ10
		N.C. spring-clamp		800F-BQ01
	Description	Volts	Pkg. Quantity	Cat. No.
 Cat. No. 800F-BN3R	<b>Base Mounted Integrated LED Module</b> Base mounted modules can be used in plastic or metal enclosures. For best illumination results, LED should match lens color. <b>Note:</b> Sold in multiples of 10. Order (quantity of) 10 to receive one package of 10 pieces. Latch not included.	24V AC/DC	10	* 800F-BN3x
		120V AC		* 800F-BN5x
		240V AC		* 800F-BN7x
		24V AC/DC spring-clamp		* 800F-BQ3x
		120V AC spring-clamp		* 800F-BQ5x
		240V AC spring-clamp		* 800F-BQ7x

\* To complete the cat. no., replace the x with one of the following letters for the desired color: **Y** = Amber, **R** = Red, **G** = Green, **B** = Blue, **W** = White.

\* Cannot be used in a composite catalog number.

‡ Replacement screws are available (Cat. No. 800F-ARS1)

Assembled Stations



1-Hole Yellow Enclosure E-Stop Station

Cat. No. 800F-1YP4

Enclosure Material	Quick Connect		Operator Type	Illumination Voltage	Contact Configuration	Cat. No.			
						PG Knockouts	Metric Knockouts		
Plastic	N/A		Twist-to-Release 40 mm	Non-Illuminated	1 N.C.	800F-1YP1	800F-1YM1		
					1 N.O. / 1 N.C.	800F-1YP2	800F-1YM2		
					2 N.C.	800F-1YP3	800F-1YM3		
					1 N.C.	800F-1YP4	800F-1YM4		
					1 N.O. / 1 N.C.	800F-1YP5	800F-1YM5		
					2 N.C.	800F-1YP6	800F-1YM6		
			Key Release 40 mm		800F-1YP7	—			
					800F-1YP8	—			
					Twist-to-Release 60 mm	24V AC/DC	—	800F-1YML1	
						120V AC	—	800F-1YML2	
						240V AC	—	800F-1YML3	
					AC Micro*	5-pin		Twist-to-Release 40 mm	Non-Illuminated
	1 N.O. / 2 N.C.	—	800F-1YMQA						
	DC Micro*	4-pin		Twist-to-Release 40 mm	Non-Illuminated/EMO/Guard	1 N.C.	—	800F-NX1	
						1 N.C.	—	800F-1YMQ1	
					Non-Illuminated	1 N.O. / 1 N.C.	—	800F-1YMQ2	
						—	—	800F-1YMQ3	
					Non-Illuminated/EMO/Guard	2 N.C.	—	800F-1YMQ3VEG	
		Non-Illuminated	—		—	800F-1YMQ3V			
		5-pin				Non-Illuminated	1 N.C.	—	800F-1YMQ41
24V AC/DC							1 N.O. / 1 N.C.	—	800F-1YMQ44
24V AC/DC							1 N.O. / 1 N.C.	—	800F-1YMQ4
120V AC							1 N.O. / 1 N.C.	—	800F-1YMQ5
240V AC	1 N.O. / 1 N.C.			—			800F-1YMQ6		
Mini Receptacle*	4-pin		Twist-to-Release 40 mm	24V AC/DC	1 N.O./1 N.C.	—	800F-1MYMQ4		
					1 N.O./1 N.C.	—	800F-1MYMQ5		
				120V AC	1 N.O./1 N.C.	—	800F-1MYMQ5		
	6-pin				240V AC	1 N.O./1 N.C.	—	800F-1MYMQ4	
						1 N.O./1 N.C.	—	800F-1MYMQ5	
						1 N.O./1 N.C.	—	800F-1MYMQ6	
Metal			Twist-to-Release 40 mm	Non-Illuminated	120V AC	—	800F-1MYMQ5		
					240V AC	—	800F-1MYMQ6		

\* Please reference Assembled Station Pin Out Chart on page 4-44

1-Hole Grey Enclosure E-Stop Station

Enclosure Material	Quick Connect		Operator Type	Illumination Voltage	Contact Configuration	Cat. No.	
						PG Knockouts	Metric Knockouts
Metal	N/A		Twist-to-Release 40 mm	Non-Illuminated	1 N.C.	—	800F-1MM1
					1 N.O. / 1 N.C.	—	800F-1MM2
					2 N.C.	—	800F-1MM3
					1 N.C.	—	800F-1MM4
			Key Release 40 mm		1 N.O. / 1 N.C.	—	800F-1MM5
					2 N.C.	—	800F-1MM6

Grey Enclosure Assembled Stations

Enclosure Material	Quick Connect		Operator Type	Illumination Voltage	Contact Configuration	Cat. No.	
						PG Knockouts	Metric Knockouts
1-Hole Plastic	N/A		Non-Illuminated	Black Push Button	1 N.O.	800F-1PP1	800F-1PM1
				"0-1" 2-Position Selector Switch	1 N.O.	800F-1PP2	800F-1PM2
				"OFF-ON" 2-Position Selector Switch	1 N.O. / 1 N.C.	800F-1PP3	800F-1PM3
				↔ (Flush Black)	1 N.O.	800F-1PP4	—
2-Hole Plastic			Start and Stop Push Buttons	1 N.O./1 N.C.	800F-2PP1	—	
3-Hole Plastic			↑ (Flush Black) O (Extended Red) ↓ (Flush Black)	4 N.O./1 N.C.	800F-3PP1	—	

4-Emergency  
Stop Devices

Operator Interface  
**Push Buttons**  
 Bul. 800F 22.5 mm

Assembled Stations, Continued

90 mm Enclosed Stations

Enclosure Material	Quick Connect	Operator Type	Illumination Voltage	Contact Configuration	Cat. No.	
					PG Knockouts	Metric Knockouts
1-Hole, Yellow Plastic	N/A	Red half dome	Non-illuminated	1 N.C.	800F-1YP1HD	800F-1YM1HD
				1 N.O./1 N.C.	800F-1YP2HD	800F-1YM2HD
				2 N.C.	800F-1YP3HD	800F-1YM3HD
			24V AC/DC	—	800F-1YML1HD	
				—	800F-1YML2HD	
				—	800F-1YML3HD	
		Red 90 mm momentary	Non-illuminated	1 N.C.	800F-1YP1M94	800F-1YM1M94
				1 N.O./1 N.C.	800F-1YP2M94	800F-1YM2M94
				2 N.C.	800F-1YP3M94	800F-1YM3M94
1-Hole, Grey Plastic		Black 90 mm momentary		1 N.O./1 N.C.	800F-1PP2M92	800F-1PM2M92



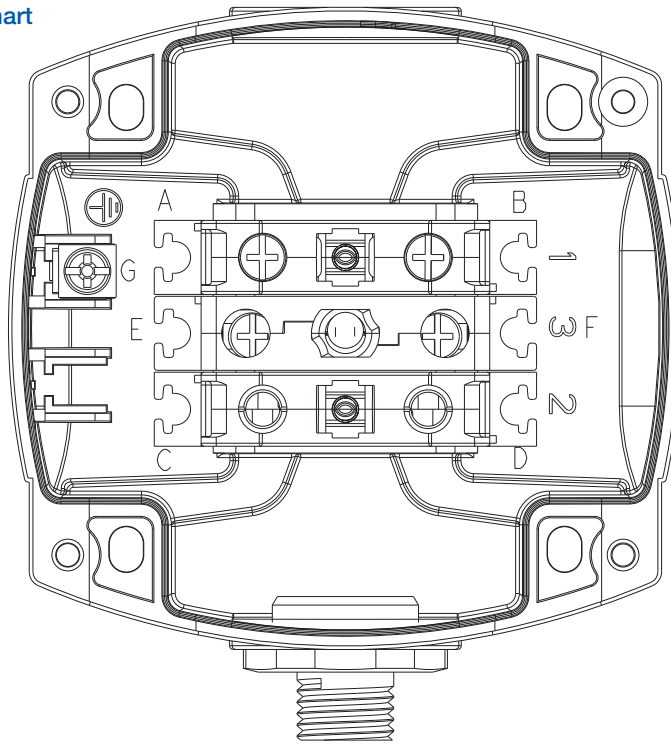

Assembled Station Pin Out Chart





Cat. No.	Connector Style / No. of Pins	Location 1	A to Pin #	B to Pin #	Location 2	C to Pin #	D to Pin #	Location 3	E to Pin #	F to Pin #	G to Pin #
800F-1YMQ53V	AC Micro / 5-pin	BX01V	1	2	BX01V	4	5	—	—	—	3
800F-1YMQA	AC Micro / 6-pin	BX01	1	5	BX01	2	6	BX10	3	4	—
800F-NX1	DC Micro / 4-pin	BX01	1/4	2/3	—	—	—	—	—	—	—
800F-1YMQ1		BX01	1/4	2/3	—	—	—	—	—	—	—
800F-1YMQ2		BX10V	2	4	BX01V	1	3	—	—	—	—
800F-1YMQ3		BX01V	1	3	BX01V	2	4	—	—	—	—
800F-1YMQ3VEG		BX01V	1	3	BX01V	2	4	—	—	—	—
800F-1YMQ3V		DC Micro / 5-pin	BX01V	1	2	BX01V	4	5	—	—	—
800F-1YMQ41	Mini Receptacle / 4-pin	BX01	2	4	—	—	—	—	—	—	—
800F-1YMQ44		BX10	1	J	BX01	2	4	BN3R	3	J	J
800F-1YMQ4	Mini Receptacle / 6-pin	BX10	1	J	BX01	6	5	BN3R	2	J	J
800F-1YMQ5		BX10	1	J	BX01	6	5	BN5R	2	J	J
800F-1YMQ6		BX10	1	J	BX01	6	5	BN7R	2	J	J
800F-1MYMQ4		BX10	1	J	BX01	6	5	BN3R	2	J	J
800F-1MYMQ5		BX10	1	J	BX01	6	5	BN5R	2	J	J
800F-1MYMQ6		BX10	1	J	BX01	6	5	BN7R	2	J	J

J = Jumper

**Guards**

	Description	Type	Cat. No.	Pkg. Quantity
 Cat. No. 800F-AMRG	<b>Protective Ring</b> for use with non-illuminated 2-position momentary and illuminated/non-illuminated 3-position mushroom operators (40 mm only)	Shiny metal	800F-AMRG	1
		Black	800F-AMRGB	
		Yellow Metal	800F-AMRGY	
 Cat. No. 800F-A6PR5	<b>Plastic Guard</b> for use with the following operators: <ul style="list-style-type: none"> <li>• 40 mm E-stop (SEMI Standards Compliant)</li> <li>• 40 mm illuminated/non-illuminated alternate action and momentary operators</li> <li>• 60 mm illuminated/non-illuminated momentary operators</li> <li>• Selector switches (standard knob and key operated)</li> <li>• Potentiometers</li> </ul>	Yellow, round	800F-A6PR5	1
 Cat. No. 800F-AMEGY	<b>Narrow Plastic Guard</b> for use with the following operators: <ul style="list-style-type: none"> <li>• Illuminated and non-illuminated momentary mushroom operators (40 mm) only</li> <li>• Bul. 800FD monolithic E-stops (SEMI standards compliant)</li> <li>• Flush/extended/guarded push buttons</li> <li>• Alternate action operators</li> <li>• Selector switches (standard knob and key operated)</li> <li>• Potentiometers</li> </ul>	Yellow	800F-AMEGY	
 Cat. No. 800F-AMMG	<b>40 mm Protective Guard</b> used with illuminated and non-illuminated momentary mushroom operators (40 mm) only.	Shiny Metal	800F-AMMG	

**Emergency Stop Legend Plates§**

800F – 15YS  

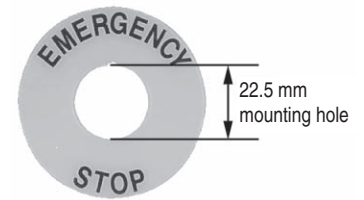

Cat. No. 800F-15YSE112

**b (cont'd)**

Size/Color (Yellow)	
Code	Description
15Y	60 mm round (30.5 mm mounting hole)
15YS	60 mm round (22.5 mm mounting hole)➤
16Y	90 mm round (22.5 mm mounting hole)➤

Text	
Code	Description
Blank	No text
E112	EMERGENCY STOP
F112	ARRÊT D'URGENCE⚡
G112	NOT AUS
T112	ARRESTO EMERGENZA
S112	PARADA DE EMERGENCIA
B112	EMERGENCY STOP, ARRÊT D'URGENCE, PARADA DE EMERGENCIA⚡

Text	
Code	Description
M112	NOT AUS, ARRESTO EMERGENZA, ARRÊT D'URGENCE➤
	EMERGENCY STOP, ARRÊT D'URGENCE, NOT AUS❖
D112	NOODSTOP⚡
N112	NÖDSTOPP, EMERGENCY STOP⚡
W112	NÖDSTOPP, EMERGENCY STOP⚡
A112	NÖDSTOP
L112	NEYÐARSTOPP, NEYÐARSTOPP⚡
H112	NÖD-STOP, HÄTÄ-SEIS, NÖD-STOP⚡

§ Sold only multiples of 10. Order (quantity of) 10 to receive one package of 10 pieces.

➤ Not for use with base mounted contact blocks.

⚡ Not available on 15YS version.

➤ Text printed on the 15Y version only.

❖ Text printed on the 15YS & 16Y versions only.

# Operator Interface

## Push Buttons

Bul. 800T 30.5 mm

### Non-Illuminated



2-Pos. Push-Pull  
Cat. No. 800T-FX6D4



2-Pos. Push-Pull / Twist  
Cat. No. 800H-FRXT6D4



2-Pos. Push-Pull / Twist  
Cat. No. 800T-FXT6D4

### Illuminated



2-Pos. Push-Pull  
Cat. No. 800T-FXP16RA1



2-Pos. Push-Pull/Twist  
Cat. No. 800H-FRXT16RA1



2-Pos. Push-Pull/Twist  
Cat. No. 800T-FXTP16RA1

### Description

The Bulletin 800T and 800H 30.5 mm Emergency Stop devices provide increased reliability. E-stops with normally closed late break contacts comply with EN418 and IEC 947-5-5 standards. This means the operator will latch when actuated before the contacts will change state.

Application flexibility is offered with 2-position push-pull or 2-position push-pull/twist release configurations. Non-illuminated and illuminated operator options are available. Contact block versions are also available that provide IP2X finger-safe protection.

Rockwell Automation also offers Self-Monitoring™ contact blocks (SMCB) which feature enhanced E-stop safety for critical process control applications. The SMCB monitors whether or not it is properly installed on the operator so that the normally closed contacts will open when the E-stop is actuated. If the SMCB is separated from the operator for any reason, the controlled circuit will automatically open.

### Features

- 30.5 mm mounting hole
- Type 4/13 watertight/oiltight (Bul. 800T)
- Type 4/4X/13 corrosion-resistant/watertight/oiltight (Bul. 800H)
- Heavy industrial stations and operators

### Specifications

Electrical Ratings		
Contact ratings	Refer to the contact ratings tables below.	
Dielectric strength	2200V for one minute, 1300V for one minute (Logic Reed)	
Electrical design life cycles	1 000 000 at max. rated load, 200 000 at max. rated load (Logic Reed)	
Mechanical Ratings		
Vibration	10...2000 Hz 1.52 mm displacement (peak-to-peak) max./10 G max. (except Logic Reed)	
Shock	1/2 cycle sine wave for 11 ms ≥ 25 G (contact fragility) and no damage at 100 G	
Degree of protection	Type 1/4/12/13 (Bul. 800T); Type 1/4/4X/12/13 (Bul. 800H); EN/IEC 60529 IP66/65	
Mechanical design life cycles (Push-pull/twist-to-release)	250 000 min.	
Contact operation	Shallow, mini, and low voltage contact blocks: Slow, double make and break Logic Reed and sealed switch contact blocks: Single break magnetic	
Wire gauge/Terminal screw torque	#18...12 AWG / 6...8 lb•in	
Typical operating forces 2-position push-pull	7.5 lbs max. push or pull	
Twist-to-release or push-pull	9 lbs max. push or pull 30 in oz. max. twist, 6 in oz. minimum return	
Contact blocks	Standard	1 lb
	Logic Reed	1 lb max.
	Sealed switch	3 lbs max. at 0.205 in plunger travel
	Stackable sealed switch	1 lb max.
Environment		
Temperature range	Operating	-40...+131 °F (-40...+55 °C)
	Storage	-40...+185 °F (-40...+85 °C)
<b>Note:</b> Operating temperatures below freezing are based on the absence of moisture and liquids. Contact your local Rockwell Automation sales office or Allen-Bradley distributor for use in lower temperature applications.		
Humidity	50...95% RH from 77...140 °F (25...60 °C) per Procedure IV of MIL-STD-BIOC, Method 507.1 cycling test	

### Standard Contact Ratings

Minimum: 24V 24 mA

Maximum thermal continuous current  $I^{th}$  10 A AC/2.5 A DC. Bulletin 800T and 800H units with Cat. No. 800T-XA contacts have ratings as follows:









Max. Operatnl. Volts Ue	Utilization Category		Rated Operational Currents		
	IEC	NEMA	Volts Ue	Make	Break
AC 600	AC-15	A600	120...600	7200VA	720VA
			72...120	60 A	720VA
			24...72	60 A	10 A
DC 600	DC-13	Q600	28...600	69VA	
			24...28*	2.5 A	

\* For applications below 24V/24 mA, PentUFF™ or Logic Reed contacts are recommended.

Self-Monitoring is a trademark of Rockwell Automation, Inc.

### 2-Position Push-Pull and Push-Pull/Twist Release, Non-Illuminated

**Note:** A jumbo or large legend plate is recommended, if space allows.

Contact Type	Operator Position		Button Color	Type 4/13		Type 4/4X/13
				Push-Pull	Push-Pull/Twist Release	Push-Pull/Twist Release
	Out	In		Cat. No.	Cat. No.	Cat. No.
 N.C.L.B.*	X	O	Red	<b>800T-FX6D4</b>	<b>800T-FXT6D4</b>	<b>800H-FRXT6D4</b>
 N.O. - N.C.L.B.*	O X	X O	Red	<b>800T-FX6A1</b>	<b>800T-FXT6A1</b>	<b>800H-FRXT6A1</b>
 N.C.L.B. - N.C.L.B.*	X X	O O	Red	<b>800T-FX6A5</b>	<b>800T-FXT6A5</b>	<b>800H-FRXT6A5</b>
 S.M.C.B.*†	X	O	Red	<b>800TC-FX6D4S</b>	800TC-FXT6D4S	800HC-FRXT6D4S
 N.O. - S.M.C.B.*†	O X	X O	Red	800TC-FX6A1S	800TC-FXT6A1S	800HC-FRXT6A1S
 S.M.C.B. - S.M.C.B.*†	X X	O O	Red	<b>800TC-FX6A5S</b>	800TC-FXT6A5S	800HC-FRXT6A5S



**Note:** X = Closed/O = Open

**Note:** Emergency stop push buttons are compliant with EN 418 and EN/IEC 60947-5-5 Standards when using N.C.L.B. contact blocks.

**Note:** These caps are only available in plastic.

### 2-Position Push-Pull and Push-Pull/Twist Release Units, Illuminated

**Note:** A jumbo or large legend plate is recommended, if space allows.

Type	Lamp Type	Volts	Color	Contacts	Operator Position		Type 4/13		Type 4/4X/13
							Push-Pull Release	Push-Pull/Twist Release	Push-Pull/Twist Release
					Maintained Out	Maintained In	Cat. No.	Cat. No.	Cat. No.
Full Voltage	Incandescent	24V AC/DC	Red	N.O. - N.C.L.B.*†	O	X	<b>800T-FXQ24RA1</b>	<b>800T-FXTQ24RA1</b>	<b>800H-FRXTQ24RA1</b>
	LED	120V AC			X	O	<b>800T-FXQH10RA1</b>	<b>800T-FXTQH10RA1</b>	800H-FRXTQH10RA1
		24V AC/DC			X	O	<b>800T-FXQH24RA1</b>	800T-FXTQH24RA1	800H-FRXTQH24RA1
Transformer	Incandescent	120V AC	Red	N.O. - N.C.L.B.*†	O	X	<b>800T-FXP16RA1</b>	<b>800T-FXTP16RA1</b>	<b>800H-FRXTTP16RA1</b>
		240V AC			X	O	<b>800T-FXP26RA1</b>	800T-FXTP26RA1	800H-FRXTTP26RA1
	LED	120V AC			X	O	<b>800T-FXPH16RA1</b>	<b>800T-FXTPH16RA1</b>	<b>800H-FRXTPH16RA1</b>
		240V AC			X	O	800T-FXPH26RA1	800T-FXTPH26RA1	800H-FRXTPH26RA1

**Note:** X = Closed/O = Open



**Note:** Emergency stop push buttons are compliant with EN 418 and EN/IEC 60947-5-5 Standards when using N.C.L.B. contact blocks.

\* Normally closed late break contact. When button is pushed from the OUT to IN position, the mechanical detent action of the operator occurs before electrical contacts change state. When the button is pulled from the IN to the OUT position, the electrical contacts change state before the mechanical detent occurs.

† The Self Monitoring Contact Block (S.M.C.B.) is composed of a N.C.L.B. contact wired in series with a N.O. monitoring contact. The N.O. monitoring contact automatically closes when the S.M.C.B. is properly installed onto the E-stop operator. If the S.M.C.B. is separated from the E-stop operator, the N.O. monitoring contact will automatically open.

‡ Contact your local Rockwell Automation sales office or Allen-Bradley distributor for availability of illuminated E-stops with Self Monitoring Contact Blocks (S.M.C.B.s).

### Accessories

	Type	Style	Color	Cat. No.
	Emergency Stop Legend Plates	For 800T Buttons	Yellow, Blank	<b>800T-X646</b>
			Yellow, Emergency Stop	<b>800T-X646EM</b>
		For 800H Buttons	Yellow, Emergency Stop	<b>800H-W690</b>



Operator Interface  
**Touch Buttons**  
 Bul. 800Z



**General Purpose**  
 Cat. No. 800Z-GF2Q5



**General Purpose**  
 Cat. No. 800Z-GL3Q5B



**Heavy Industrial**  
 Cat. No. 800Z-HF1



**Heavy Industrial**  
 Cat. No. 800Z-HL1Y

**Description**

Bulletin 800Z Zero-Force Touch Buttons are designed for use by machine control systems requiring the use of two hands. An interlinked sensor surface weaves two capacitive sensors in offset planes for superior product sensitivity.

Bulletin 800Z touch buttons are ergonomically designed for ease of operation. Simply touching the surface of the switch will initiate an output. The Bulletin 800Z line can detect the hand through most industrial gloves.

The contour of Bulletin 800Z touch buttons serves two purposes; it easily conforms to the shape of the hand while helping prevent defeatability when two-hand control is needed.

Two bi-colored diagnostic LEDs provide guidance during operation. The power/fault LED blinks at different rates to provide diagnostic information to the user. The Bulletin 800Z line detects the presence of a hand during power-up, noise, and conductive film build-up over time.

**Features**

- Internationally rated ergonomic touch buttons
- Zero force to operate
- EMC protection
- Diagnostic LEDs
- Replaceable relays (heavy industrial design)

**Load Life Curves for General Purpose Product Line**

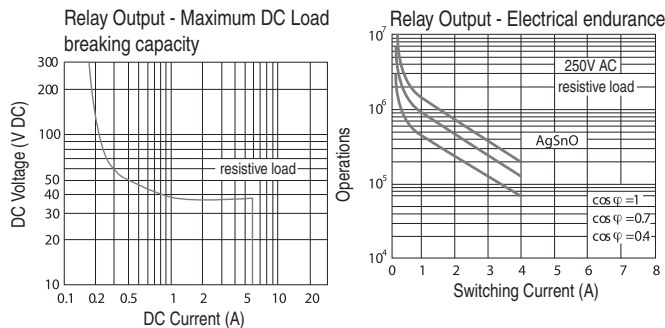

**Specifications**

Description	General Purpose Line (Cat. No. 800Z-G)	Heavy Industrial Line (Cat. No. 800Z-H)
<b>Mechanical Ratings</b>		
Vibration Endurance	Tested @ 10 G, 1.52 mm displacement	
Mechanical Shock	Tested @ 100 G (mechanical durability)	
Degree of Protection	Type 4/4X/13 IP66 1200 psi Washdown	Type 4/13 IP66
Operating Force	Zero	
<b>Electrical Ratings</b>		
Input Voltage (Relay type)	Low Voltage: 10...40V DC, 20...30V AC Full Voltage (800Z-GF): 85...264V AC	
Input Voltage (Solid-State type)	Low Voltage (800Z-GN/GP): 10...30V DC	
Electrical Design Life (Relay type)	Relay Output 200,000 Operations @ 2A inductive 4A resistive	Relay Output 150,000 Operations @ 5A inductive 2.5 A resistive
On-delay/Off-delay	Off 60 ms max. On 76 ms max.	
Current Draw (Solid-State type)	100 mA at 24V DC = 2.23 W (no external load)	
<b>Terminal Block Ratings</b>		
Degree of Protection		IP2X
Wire Range	—	#22...12 AWG (0.5...4 mm <sup>2</sup> )
Tightening Torque		9 lb-in. (1N•m)
<b>Environmental</b>		
Temperature Range (Operating)	-25...+55°C	
Temperature Range (Storage)	-40...+85°C	
Humidity	95% RH from 25...50°C (full operation)	
<b>Materials</b>		
Housing/Guard	Valox 357	
Gasket	BUNA-N	1/16 in. Cork-BUNA-N
Connector	Insulator material (micro connector) = nylon Insulator material (mini connector) = PVC	
<b>Standards and Certifications</b>		
Certifications	cUL <sub>us</sub> , CE, C-TICK, CSA	
Standards Conformity	UL508, CSA 22.2 No. 14, UL50, EN/IEC 60947-5-1, EN50081-2, EN61000-6-2, EN954-1	

**Load Life Curves for Heavy Industrial Line**

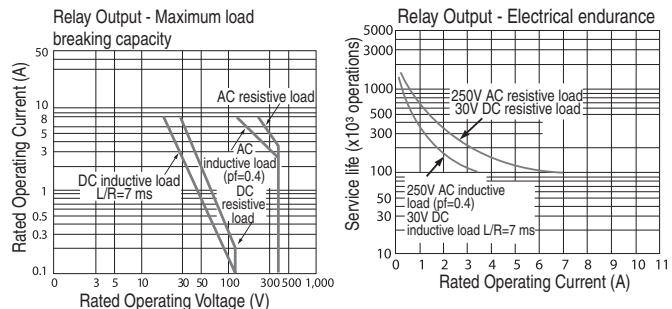



**General Purpose Line — Momentary Touch Buttons**

Mounting Hole Size	Input Voltage	Output Type	Electrical Connection	No Guard	Black Guard
				Cat. No.	Cat. No.
30.5 mm	85...264V AC	Relay Output	5-Pin QD	<b>800Z-GF3Q5</b>	<b>800Z-GF3Q5B</b>
			6 ft Cabled — 5-Wire	<b>800Z-GF3065</b>	<b>800Z-GF3065B</b>
	10...40V DC and 20...30V AC	Relay Output	5-Pin QD	<b>800Z-GL3Q5</b>	<b>800Z-GL3Q5B</b>
			6 ft Cabled — 5-Wire	<b>800Z-GL3065</b>	800Z-GL3065B
22.5 mm	85...264V AC	Relay Output	5-Pin QD	<b>800Z-GF2Q5</b>	<b>800Z-GF2Q5B</b>
			6 ft Cabled — 5-Wire	<b>800Z-GF2065</b>	<b>800Z-GF2065B</b>
	10...40V DC and 20...30V AC	Relay Output	5-Pin QD	<b>800Z-GL2Q5</b>	<b>800Z-GL2Q5B</b>
			6 ft Cabled — 5-Wire	<b>800Z-GL2065</b>	<b>800Z-GL2065B</b>
Recommended standard cordset, 2 m (6.5 ft). See <i>Safety Catalog</i> for additional lengths.			Mini-Plus Style QD Cordset, 5-Pin	889N-F5AE-6F	889D-F5AC-2

Use the configurator below to build a Bulletin 800Z touch button to suit your application.

**800Z - G L 3 065 B -**

a                      b                      c                      d                      e

**a**

Input Voltage and Output Type ‡	
Code	Description
<b>Relay Output</b>	
L	Input: 10...40V DC and 20...30V AC Output: Relay
F	Input: 85...264V AC Output: Relay
<b>Transistor Output</b>	
P	10...30V DC PNP (Sourcing) Output

**c**

Electrical Connection	
Code	Description
<b>Sinking/Sourcing Output *</b>	
Q4	4-Pin QD
064	6 ft (1.8 m) Cabled
244	24 ft (7.2 m) Cabled
<b>Relay Output *</b>	
Q5	5-Pin QD
065	6 ft (1.8 m) Cabled
245	24 ft (7.2 m) Cabled

**d**

Guard Option	
Code	Description
Blank	No Guard
B	Black Guard
Y	Yellow Guard

**b**

Mounting Hole Size §	
Code	Description
2	22.5 mm
3	30.5 mm

- \* These devices are transistor outputs.
- ‡ These devices have separate N.O. and N.C. output relays with a shared common.
- ‡ Safety relays should be used in conjunction with two relay output type Zero-Force Touch Buttons™ in 2-hand control applications. Order separately, safety relay 440R-D23171 for 24V, 440R-D23169 for 120V, 440R-D23168 for 240V.
- § 22.5 mm touch buttons use micro connector, 30.5 mm touch buttons use mini connector.

**Heavy Industrial Line — Momentary Touch Buttons**

Button Type	Input Voltage	Output Type	Electrical Connection	No Guard	Yellow Guard
				Cat. No.	Cat. No.
Flush Mount	10...40V DC and 20...30V AC	Relay Output	Terminal Block	<b>800Z-HL1</b>	<b>800Z-HL1Y</b>
	85...264V AC	Relay Output	Terminal Block	<b>800Z-HF1</b>	<b>800Z-HF1Y</b>

Use the configurator below to build a Bulletin 800Z touch button to suit your application.

**800Z - H L 1 Y -**

a                      b                      c                      d

**a**

Voltage *	
Code	Description
L	Input: 10...40V DC and 20...30V AC Output: Relay
F	Input: 85...264V AC Output: Relay

**b**

Mounting Type *	
Code	Description
1	Flush Mounting

**c**

Guard Option	
Code	Description
Blank	No Guard
Y	Yellow Guard

- \* Heavy industrial devices have an 8-position terminal block connection. See wiring diagrams on page 4-53 for details.
- \* Safety relays should be used in conjunction with two relay output type Zero-Force Touch Buttons in 2-hand control applications. Order separately, safety relay 440R-D23171 for 24V, 440R-D23169 for 120V, 440R-D23168 for 240V.







Operator Interface  
**Touch Buttons**  
 Bul. 800Z

Accessories — General Purpose

Heavy Industrial with Guard

		Description	Cat. No.	
 Cat. No. 800Z-G3AG1	 Cat. No. 800Z-G3AG2	<b>Guards</b> These guards help protect against accidental activation of the touch button surface and protect it from damage. Can be used for both the 22.5 mm and 30.5 mm mounted products.	Yellow Plastic	800Z-G3AG1
			Black Plastic	800Z-G3AG2
 Plastic Mounting Kit Cat. No. 800Z-G2AH1		<b>Mounting Ring Nut for 22.5 mm Holes</b> Used on 22.5 mm devices.		800Z-G2AH1
 Plastic Mounting Kit Cat. No. 800Z-G3AH1		<b>Mounting Ring Nut for 30.5 mm Hole</b> Used on 30.5 mm devices.		800Z-G3AH1
 Swivel Assembly Cat. No. 60-2439		<b>30.5 mm Swivel/Tilt Mounting Assembly</b> This bracket allows you to orient the touch button in any position. It can be mounted on any vertical or horizontal surface. Compatible with 30.5 mm mounting only.	2.25 in. (57 mm)	60-2681
			1.15 in. (29 mm)	60-2439
 Cat. No. 800E-AHA1		<b>30.5 mm to 22.5 mm Hole Size Adapter</b> This adapter allows a 22.5 mm push button operator to be installed in a panel with existing 30.5 mm mounting holes.	Metal	800F-AHA1
			Black Metal	800E-AHA2

Accessories — Heavy Industrial

	Description		Cat. No.
 <p><b>Cat. No. 800Z-HAG1</b></p>	<p><b>Guard</b>                      This guard helps protects against accidental activation of the touch surface and protects it from damage. Mounting screws are included.</p>	<p>Yellow Plastic</p>	<p><b>800Z-HAG1</b></p>
 <p><i>Single Hub Base</i>  <b>Cat. No. 800P-B1</b></p>  <p><i>Double Hub Base</i>  <b>Cat. No. 800P-B2</b></p>	<p><b>Mounting Bases</b>                      The heavy industrial line products mount directly on these bases. The conduit hub(s) come with a 3/4 inch opening.</p>	<p>1</p>	<p><b>800P-B1</b></p>
		<p>2</p>	<p><b>800P-B2</b></p>
 <p><b>Cat. No. 800P-N150</b></p>	<p><b>Adapter</b>                      This adapter is used if mounting touch button onto a 4-1/2 in. x 2-3/8 in. (114.3 x 60.3 mm) enclosure pattern.</p>		<p><b>800P-N150</b></p>
 <p><b>Cat. No. 800Z-N12</b></p>	<p><b>Replacement Relay</b>  <b>Note:</b> Package quantity of 2.</p>	<p>10...264V</p>	<p>800Z-N12</p>
 <p><b>Cat. No. 800Z-HAH1</b></p>	<p><b>Replacement Screws</b></p>	<p>Guard-to-Base Mounting  <b>Note:</b> package quantity of 4</p>	<p>800Z-HAH1</p>
		<p>Base Mounting  <b>Note:</b> package quantity of 4</p>	<p>800Z-HAH2</p>

4-Two-Hand  
 Control Device

Operator Interface  
**Touch Buttons**  
 Bul. 800Z

**Approximate Dimensions**

Dimensions in in. (mm). Dimensions are not intended to be used for manufacturing purposes.

**General Purpose**

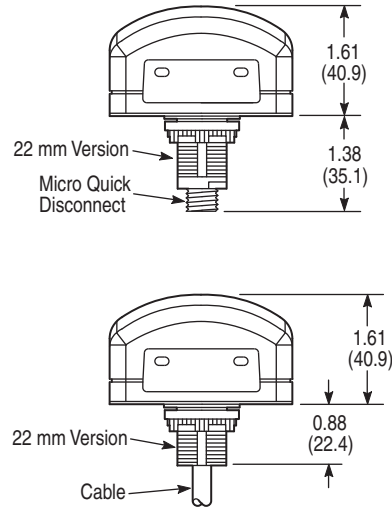
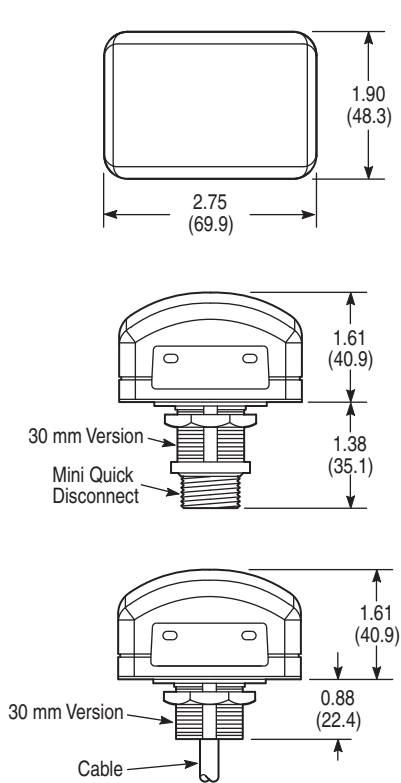

**General Purpose With Guard**

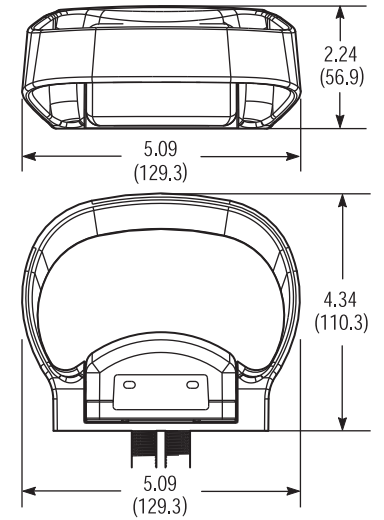

**Heavy Industrial**

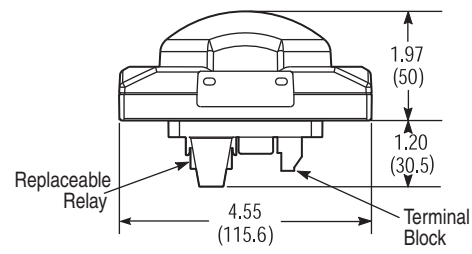
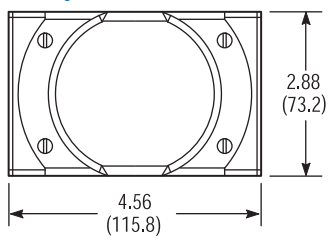

**Heavy Industrial With Guard**

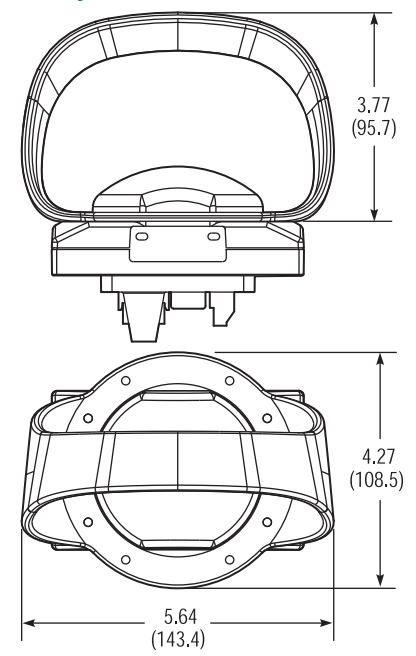

**Cutout and Mounting Screw Locations for a Flush Mounted Cover**

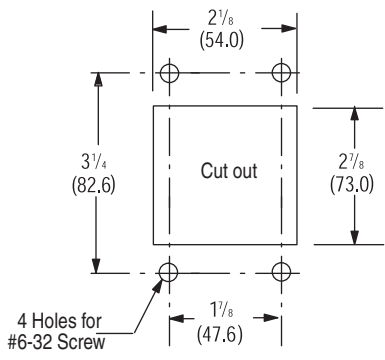

4-Two-Hand Control Device

**Wiring Diagrams — Touch Button Terminations**

**General Purpose Line**

Electrical Connections: 10...40V DC and 20...30V AC Input Voltage (Relay Output); 85...264V AC Input Voltage (Relay Output)

Note: Separate N.O. and N.C. output relays with shared common.

**5-Conductor Cabled (Relay Output)**

For 800Z-GL

For 800Z-GF

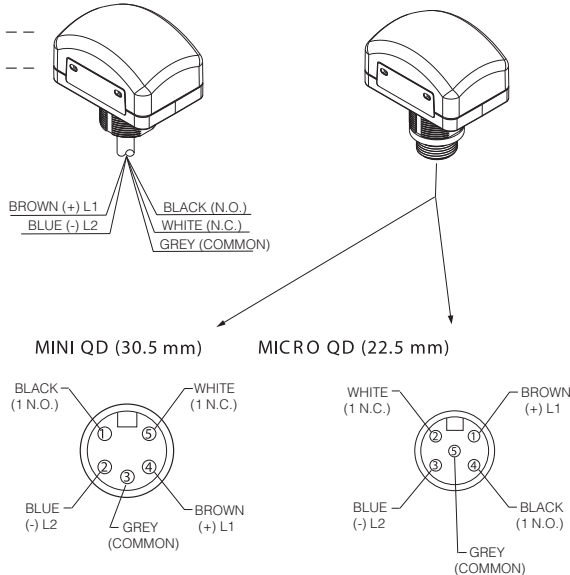

Electrical Connections: 10...30V DC Input Voltage (Transistor Output); 150 mA Max. per Circuit Output

**4-Conductor Cabled**

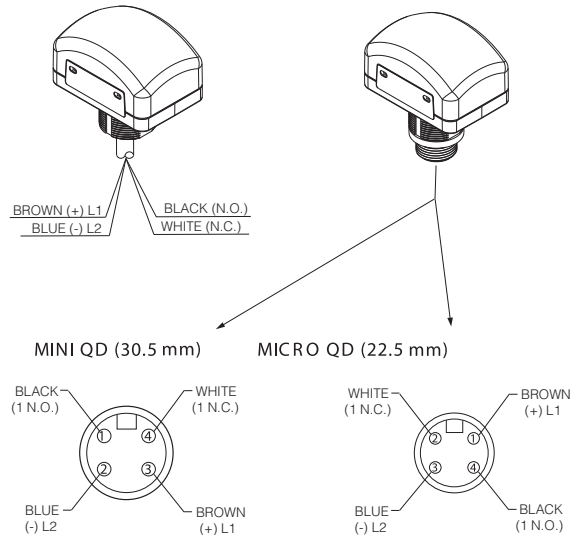

**Heavy Industrial Line**

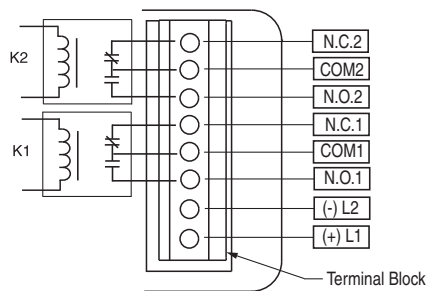

**Applications Detail**

LED Blink Rate	Diagnostic	Description
** ** *	Power Up	Device touched during power up. Device will resume 10 seconds after removal of hand.
*** ** *	Noise Detection	Device detected an unacceptable level of noise (>20 V/m). Device will resume once noise subsides.
**** ** *	Margin Detection	A conductive film is building up on the sensing surface. Device will resume once cleared.

4-Two-Hand Control Device

