

Compact GuardLogix 5380 SIL 2 Controllers

Catalog Numbers 5069-L306ERS2, 5069-L306ERMS2, 5069-L310ERS2, 5069-L310ERMS2, 5069-L320ERS2, 5069-L320ERS2K, 5069-L320ERMS2, 5069-L320ERMS2K, 5069-L330ERS2, 5069-L330ERS2K, 5069-L330ERMS2, 5069-L330ERMS2K, 5069-L340ERS2, 5069-L340ERMS2, 5069-L350ERS2, 5069-L350ERS2K, 5069-L350ERMS2, 5069-L350ERMS2K, 5069-L380ERS2, 5069-L380ERMS2, 5069-L3100ERS2, 5069-L3100ERMS2

Topic	Page
About the Controller	5
Before You Begin	5
Install the Controller onto the DIN Rail	7
Connect External Power Supplies to the Controller	7
Install the End Cap	10
Power the System	10
Set the Network Internet Protocol (IP) Addresses	10
Connect the Controller to an EtherNet/IP Network	11
Remove or Replace the Controller	12
Specifications	13
European Machinery Directive Approval	14
Additional Resources	14

The Compact GuardLogix® 5380 controller is a programmable automation controller with integrated safety. Compact GuardLogix 5380 SIL 2 controllers are for use in functional safety applications up to and including Safety Integrity Level (SIL) 2 and Performance Level (d).

You use the Studio 5000 Logix Designer® application to configure the Compact GuardLogix 5380 controllers.

For more information on how to use the controller after you install it, including safety application requirements, see the publications that are listed in [Additional Resources on page 14](#).

Summary of Changes

This publication was revised to add spacing and operating temperature information. For more information, see [page 5](#) and [page 13](#), respectively.



ATTENTION: Read this document and the documents listed in the Additional Resources section about installation, configuration and operation of this equipment before you install, configure, operate or maintain this product. Users are required to familiarize themselves with installation and wiring instructions in addition to requirements of all applicable codes, laws, and standards.

Activities including installation, adjustments, putting into service, use, assembly, disassembly, and maintenance are required to be carried out by suitably trained personnel in accordance with applicable code of practice.

If this equipment is used in a manner not specified by the manufacturer, the protection provided by the equipment may be impaired.

注意：在安装、配置、操作和维护本产品前，请阅读本文档以及“其他资源”部分列出的有关设备安装、配置和操作的相应文档。除了所有适用规范、法律和标准的相关要求之外，用户还必须熟悉安装和接线说明。

安装、调整、投运、使用、组装、拆卸和维护等各项操作必须由经过适当训练的专业人员按照适用的操作规范实施。

如果未按照制造商指定的方式使用该设备，则可能会损害设备提供的保护。

ATENCIÓN: Antes de instalar, configurar, poner en funcionamiento o realizar el mantenimiento de este producto, lea este documento y los documentos listados en la sección Recursos adicionales acerca de la instalación, configuración y operación de este equipo. Los usuarios deben familiarizarse con las instrucciones de instalación y cableado y con los requisitos de todos los códigos, leyes y estándares vigentes.

El personal debidamente capacitado debe realizar las actividades relacionadas a la instalación, ajustes, puesta en servicio, uso, ensamblaje, desensamblaje y mantenimiento de conformidad con el código de práctica aplicable.

Si este equipo se usa de una manera no especificada por el fabricante, la protección provista por el equipo puede resultar afectada.

ATENÇÃO: Leia este e os demais documentos sobre instalação, configuração e operação do equipamento que estão na seção Recursos adicionais antes de instalar, configurar, operar ou manter este produto. Os usuários devem se familiarizar com as instruções de instalação e fiação além das especificações para todos os códigos, leis e normas aplicáveis.

É necessário que as atividades, incluindo instalação, ajustes, colocação em serviço, utilização, montagem, desmontagem e manutenção sejam realizadas por pessoal qualificado e especializado, de acordo com o código de prática aplicável.

Caso este equipamento seja utilizado de maneira não estabelecida pelo fabricante, a proteção fornecida pelo equipamento pode ficar prejudicada.

ВНИМАНИЕ: Перед тем как устанавливать, настраивать, эксплуатировать или обслуживать данное оборудование, прочитайте этот документ и документы, перечисленные в разделе «Дополнительные ресурсы». В этих документах изложены сведения об установке, настройке и эксплуатации данного оборудования. Пользователи обязаны ознакомиться с инструкциями по установке и прокладке соединений, а также с требованиями всех применимых норм, законов и стандартов.

Все действия, включая установку, наладку, ввод в эксплуатацию, использование, сборку, разборку и техническое обслуживание, должны выполняться обученным персоналом в соответствии с применимыми нормами и правилами.

Если оборудование используется не предусмотренным производителем образом, защита оборудования может быть нарушена.

注意：本製品を設置、構成、稼働または保守する前に、本書および本機器の設置、設定、操作についての参考資料の該当箇所に記載されている文書に目を通してください。ユーザは、すべての該当する条例、法律、規格の要件に加えて、設置および配線の手順に習熟している必要があります。

設置調整、運転の開始、使用、組立て、解体、保守を含む諸作業は、該当する実施規則に従って訓練を受けた適切な作業員が実行する必要があります。

本機器が製造メーカーにより指定されていない方法で使用されている場合、機器により提供されている保護が損なわれる恐れがあります。

ACHTUNG: Lesen Sie dieses Dokument und die im Abschnitt „Weitere Informationen“ aufgeführten Dokumente, die Informationen zu Installation, Konfiguration und Bedienung dieses Produkts enthalten, bevor Sie dieses Produkt installieren, konfigurieren, bedienen oder warten. Anwender müssen sich neben den Bestimmungen aller anwendbaren Vorschriften, Gesetze und Normen zusätzlich mit den Installations- und Verdrahtungsanweisungen vertraut machen.

Arbeiten im Rahmen der Installation, Anpassung, Inbetriebnahme, Verwendung, Montage, Demontage oder Instandhaltung dürfen nur durch ausreichend geschulte Mitarbeiter und in Übereinstimmung mit den anwendbaren Ausführungsvorschriften vorgenommen werden.

Wenn das Gerät in einer Weise verwendet wird, die vom Hersteller nicht vorgesehen ist, kann die Schutzfunktion beeinträchtigt sein.

ATTENTION : Lisez ce document et les documents listés dans la section Ressources complémentaires relatifs à l'installation, la configuration et le fonctionnement de cet équipement avant d'installer, configurer, utiliser ou entretenir ce produit. Les utilisateurs doivent se familiariser avec les instructions d'installation et de câblage en plus des exigences relatives aux codes, lois et normes en vigueur.

Les activités relatives à l'installation, le réglage, la mise en service, l'utilisation, l'assemblage, le démontage et l'entretien doivent être réalisées par des personnes formées selon le code de pratique en vigueur.

Si cet équipement est utilisé d'une façon qui n'a pas été définie par le fabricant, la protection fournie par l'équipement peut être compromise.

주의：본 제품 설치, 설정, 작동 또는 유지 보수하기 전에 본 문서를 포함하여 설치, 설정 및 작동에 관한 참고 자료 섹션의 문서들을 반드시 읽고 숙지하십시오. 사용자는 모든 관련 규정, 법규 및 표준에서 요구하는 사항에 대해 반드시 설치 및 배선 지침을 숙지해야 합니다.

설치, 조정, 가동, 사용, 조립, 분해, 유지보수 등 모든 작업은 관련 규정에 따라 적절한 교육을 받은 사용자를 통해서만 수행해야 합니다.

본 장비를 제조사가 명시하지 않은 방법으로 사용하면 장비의 보호 기능이 손상될 수 있습니다.

ATTENZIONE Prima di installare, configurare ed utilizzare il prodotto, o effettuare interventi di manutenzione su di esso, leggere il presente documento ed i documenti elencati nella sezione "Altre risorse", riguardanti l'installazione, la configurazione ed il funzionamento dell'apparecchiatura. Gli utenti devono leggere e comprendere le istruzioni di installazione e cablaggio, oltre ai requisiti previsti dalle leggi, codici e standard applicabili.

Le attività come installazione, regolazioni, utilizzo, assemblaggio, disassemblaggio e manutenzione devono essere svolte da personale adeguatamente addestrato, nel rispetto delle procedure previste.

Qualora l'apparecchio venga utilizzato con modalità diverse da quanto previsto dal produttore, la sua funzione di protezione potrebbe venire compromessa.

DIKKAT: Bu ürünün kurulumu, yapılandırılması, işletilmesi veya bakımı öncesinde bu dokümanı ve bu ekipmanın kurulumu, yapılandırılması ve işletimi ile ilgili ilave Kaynaklar bölümünde yer listelenmiş dokümanları okuyun. Kullanıcılar yürürlükteki tüm yönetmelikler, yasalar ve standartların gereksinimlerine ek olarak kurulum ve kablolama talimatlarını da öğrenmek zorundadır.

Kurulum, ayarlama, hizmet alma, kullanma, parçaları birleştirme, parçaları sökme ve bakım gibi aktiviteler sadece uygun eğitimleri almış kişiler tarafından yürürlükteki uygulama yönetmeliklerine uygun şekilde yapılabilir.

Bu ekipman üretici tarafından belirlenmiş amaç dışında kullanılırsa, ekipman tarafından sağlanan koruma bozulabilir.

注意事項：在安装、設定、操作或維護本產品前，請先閱讀此文件以及列於「其他資源」章節中有關安裝、設定與操作此設備的文件。使用者必須熟悉安裝和配線指示，並符合所有法規、法律和標準要求。

包括安裝、調整、交付使用、使用、組裝、拆卸和維護等動作都必須交由已經過適當訓練的人員進行，以符合適用的實作法規。

如果將設備用於非製造商指定的用途時，可能會造成設備所提供的保護功能受損。

POZOR: Než začnete instalovat, konfigurovat či provozovat tento výrobek nebo provádět jeho údržbu, přečtěte si tento dokument a dokumenty uvedené v části Dodatečné zdroje ohledně instalace, konfigurace a provozu tohoto zařízení. Uživatelé se musejí vedle požadavků všech relevantních vyhlášek, zákonů a norem nutně seznámit také s pokyny pro instalaci a elektrické zapojení.

Činnosti zahrnující instalaci, nastavení, uvedení do provozu, užívání, montáž, demontáž a údržbu musí vykonávat vhodně proškolený personál v souladu s příslušnými prováděcími předpisy.

Pokud se toto zařízení používá způsobem neodpovídajícím specifikaci výrobce, může být narušena ochrana, kterou toto zařízení poskytuje.

UWAGA: Przed instalacją, konfiguracją, użytkowaniem lub konserwacją tego produktu należy przeczytać niniejszy dokument oraz wszystkie dokumenty wymienione w sekcji Dodatkowe źródła omawiające instalację, konfigurację i procedury użytkowania tego urządzenia. Użytkownicy mają obowiązek zapoznać się z instrukcjami dotyczącymi instalacji oraz oprzewodowania, jak również z obowiązującymi kodeksami, prawami i normami.

Działania obejmujące instalację, regulację, przekazanie do użytkowania, użytkowanie, montaż, demontaż oraz konserwację muszą być wykonywane przez odpowiednio przeszkolony personel zgodnie z obowiązującym kodeksem postępowania.

Jeśli urządzenie jest użytkowane w sposób inny niż określony przez producenta, zabezpieczenie zapewniane przez urządzenie może zostać ograniczone.

OBST! Läs detta dokument samt dokumentet, som står listat i avsnittet Övriga resurser, om installation, konfigurering och drift av denna utrustning innan du installerar, konfigurerar eller börjar använda eller utföra underhållsarbete på produkten. Användare måste bekanta sig med instruktioner för installation och kabeldragning, förutom krav enligt gällande koder, lagar och standarder.

Åtgärder som installation, justering, service, användning, montering, demontering och underhållsarbete måste utföras av personal med lämplig utbildning enligt lämpligt bruk.

Om denna utrustning används på ett sätt som inte anges av tillverkaren kan det hända att utrustningens skyddsanordningar försätts ur funktion.

LET OP: Lees dit document en de documenten die genoemd worden in de paragraaf Aanvullende informatie over de installatie, configuratie en bediening van deze apparatuur voordat u dit product installeert, configureert, bedient of onderhoudt. Gebruikers moeten zich vertrouwd maken met de installatie en de bedravingsinstructies, naast de vereisten van alle toepasselijke regels, wetten en normen.

Activiteiten zoals het installeren, afstellen, in gebruik stellen, gebruiken, monteren, demonteren en het uitvoeren van onderhoud mogen uitsluitend worden uitgevoerd door hiervoor opgeleid personeel en in overeenstemming met de geldende praktijkregels.

Indien de apparatuur wordt gebruikt op een wijze die niet is gespecificeerd door de fabrikant, dan bestaat het gevaar dat de beveiliging van de apparatuur niet goed werkt.

Environment and Enclosure



ATTENTION: This equipment is intended for use in a Pollution Degree 2 industrial environment, in overvoltage Category II applications (as defined in EN/IEC 60664-1), at altitudes up to 2000 m (6562 ft) without derating.

This equipment is not intended for use in residential environments and may not provide adequate protection to radio communication services in such environments.

This equipment is supplied as open-type equipment for indoor use. It must be mounted within an enclosure that is suitably designed for those specific environmental conditions that are present and appropriately designed to prevent personal injury resulting from accessibility to live parts. The enclosure must have suitable flame-retardant properties to prevent or minimize the spread of flame, complying with a flame spread rating of 5VA or be approved for the application if nonmetallic. The interior of the enclosure must be accessible only by the use of a tool. Subsequent sections of this publication may contain more information regarding specific enclosure type ratings that are required to comply with certain product safety certifications.

In addition to this publication, see the following:

- Industrial Automation Wiring and Grounding Guidelines, publication [1770-4.1](#), for more installation requirements.
- NEMA 250 and EN/IEC 60529, as applicable, for explanations of the degrees of protection provided by enclosures.

Waste Electrical and Electronic Equipment (WEEE)



At the end of its life, this equipment should be collected separately from any unsorted municipal waste.

North American Hazardous Location Approval

The following information applies when operating this equipment in hazardous locations.	Informations sur l'utilisation de cet équipement en environnements dangereux.
<p>Products marked "CL I, DIV 2, GP A, B, C, D" are suitable for use in Class I Division 2 Groups A, B, C, D, Hazardous Locations and nonhazardous locations only. Each product is supplied with markings on the rating nameplate indicating the hazardous location temperature code. When combining products within a system, the most adverse temperature code (lowest "T" number) may be used to help determine the overall temperature code of the system. Combinations of equipment in your system are subject to investigation by the local Authority Having Jurisdiction at the time of installation.</p>	<p>Les produits marqués "CL I, DIV 2, GP A, B, C, D" ne conviennent qu'à une utilisation en environnements de Classe I Division 2 Groupes A, B, C, D dangereux et non dangereux. Chaque produit est livré avec des marquages sur sa plaque d'identification qui indiquent le code de température pour les environnements dangereux. Lorsque plusieurs produits sont combinés dans un système, le code de température le plus défavorable (code de température le plus faible) peut être utilisé pour déterminer le code de température global du système. Les combinaisons d'équipements dans le système sont sujettes à inspection par les autorités locales qualifiées au moment de l'installation.</p>
<div style="display: flex; align-items: center;"> <div> <p>WARNING: Explosion Hazard –</p> <ul style="list-style-type: none"> • Do not disconnect equipment unless power has been removed or the area is known to be nonhazardous. • Do not disconnect connections to this equipment unless power has been removed or the area is known to be nonhazardous. Secure any external connections that mate to this equipment by using screws, sliding latches, threaded connectors, or other means provided with this product. • Substitution of components may impair suitability for Class I, Division 2. • If this product contains batteries, they must only be changed in an area known to be nonhazardous. </div> </div>	<div style="display: flex; align-items: center;"> <div> <p>AVERTISSEMENT: Risque d'Explosion –</p> <ul style="list-style-type: none"> • Couper le courant ou s'assurer que l'environnement est classé non dangereux avant de débrancher l'équipement. • Couper le courant ou s'assurer que l'environnement est classé non dangereux avant de débrancher les connecteurs. Fixer tous les connecteurs externes reliés à cet équipement à l'aide de vis, loquets coulissants, connecteurs filetés ou autres moyens fournis avec ce produit. • La substitution de composants peut rendre cet équipement inadapté à une utilisation en environnement de Classe I, Division 2. • S'assurer que l'environnement est classé non dangereux avant de changer les piles. </div> </div>

European Hazardous Location Approval

The following applies to products marked II 3 G:

- Are Equipment Group II, Equipment Category 3, and comply with the Essential Health and Safety Requirements relating to the design and construction of such equipment given in Annex II to Directive 2014/34/EU. See the EC Declaration of Conformity at <http://www.rockwellautomation.com/global/certification/overview.page> for details.
- The type of protection is "Ex nA IIC T4 Gc" according to EN 60079-15.
- Comply to standards: EN 60079-0:2012+A11:2013 and EN 60079-15:2010, reference certificate number DEMK017ATEX1976X.
- Are intended for use in areas in which explosive atmospheres caused by gases, vapors, mists, or air are unlikely to occur, or are likely to occur only infrequently and for short periods. Such locations correspond to Zone 2 classification according to ATEX directive 2014/34/EU.
- May have catalog numbers followed by a "K" to indicate a conformal coating option.

IEC Hazardous Location Approval

The following applies to products with IECEx certification:

- Are intended for use in areas in which explosive atmospheres caused by gases, vapors, mists, or air are unlikely to occur, or are likely to occur only infrequently and for short periods. Such locations correspond to Zone 2 classification to IEC 60079-0.
- The type of protection is "Ex nA IIC T4 Gc" according to IEC 60079-15.
- Comply to Standards IEC 60079-0:2011 6th Edition and IEC-60079-15:2010 4th Edition, reference IECEx certificate number IECEx UL 17.0122X.
- May have catalog numbers followed by a "K" to indicate a conformal coating option.



WARNING: Special Conditions for Safe Use:

- This equipment is not resistant to sunlight or other sources of UV radiation.
- This equipment shall be mounted in an ATEX/IECEx Zone 2 certified enclosure with a minimum ingress protection rating of at least IP54 (in accordance with EN/IEC 60079-15) and used in an environment of not more than Pollution Degree 2 (as defined in EN/IEC 60664-1) when applied in Zone 2 environments. The enclosure must be accessible only by the use of a tool.
- This equipment shall be used within its specified ratings defined by Rockwell Automation.
- Provision shall be made to prevent the rated voltage from being exceeded by transient disturbances of more than 140% of the rated voltage when applied in Zone 2 environments.
- The instructions in the user manual shall be observed.
- Secure any external connections that mate to this equipment by using screws, sliding latches, threaded connectors, or other means provided with this product.
- Do not disconnect equipment unless power has been removed or the area is known to be nonhazardous.
- Earthing is accomplished through mounting of controllers on rail.
- Devices shall be used in an environment of not more than Pollution Degree 2.
- The USB port is intended for temporary local programming purposes only and not intended for permanent connection.
- Do not use the USB port in hazardous locations.

Prevent Electrostatic Discharge



ATTENTION: This equipment is sensitive to electrostatic discharge, which can cause internal damage and affect normal operation. Follow these guidelines when you handle this equipment:

- Touch a grounded object to discharge potential static.
- Wear an approved grounding wriststrap.
- Do not touch connectors or pins on component boards.
- Do not touch circuit components inside the equipment.
- Use a static-safe workstation, if available.
- Store the equipment in appropriate static-safe packaging when not in use.



ATTENTION:

- In case of malfunction or damage, no attempts at repair should be made. The controller should be returned to the manufacturer for repair. Do not dismantle the controller.
- The USB port is intended for temporary local programming purposes only and not intended for permanent connection. The USB cable is not to exceed 3.0 m (9.84 ft) and must not contain hubs.
- Use only a soft dry anti-static cloth to wipe down equipment. Do not use any cleaning agents.
- This equipment is certified for use only within the surrounding air temperature range of: 0...60 °C (32...140 °F). The equipment must not be used outside of this range.



WARNING:

- If you connect or disconnect wiring while the field-side power is on, an electrical arc can occur. This could cause an explosion in hazardous location installations. Be sure that power is removed or the area is nonhazardous before proceeding.
- If you insert or remove the module while backplane power is on, an electrical arc can occur. This could cause an explosion in hazardous location installations. The module does not support "Removal and Insertion Under Power" (RIUP) capability. Do not connect or disconnect the module while power is applied. Be sure power is removed before proceeding.
- When you insert or remove the SD memory card while power is on, an electrical arc can occur. This could cause an explosion in hazardous location installations. Be sure that power is removed or the area is nonhazardous before proceeding.
- When you press the reset button while power is on, an electrical arc can occur. This could cause an explosion in hazardous location installations. Be sure that power is removed or the area is nonhazardous before proceeding.
- When you change switch settings while power is on, an electrical arc can occur. This could cause an explosion in hazardous location installations. Be sure that power is removed or the area is nonhazardous before proceeding.

IMPORTANT

Any illustrations, charts, sample programs, and layout examples that are shown in this publication are intended solely for the purposes of example. Since there are many variables and requirements that are associated with any particular installation, Rockwell Automation does not assume responsibility or liability for actual use that is based upon the examples that are shown in this publication.



ATTENTION: Personnel responsible for the application of safety-related programmable electronic systems (PES) shall be aware of the safety requirements in the application of the system and shall be trained in using the system.

About the Controller

The following graphic shows a Compact GuardLogix 5380 controller.

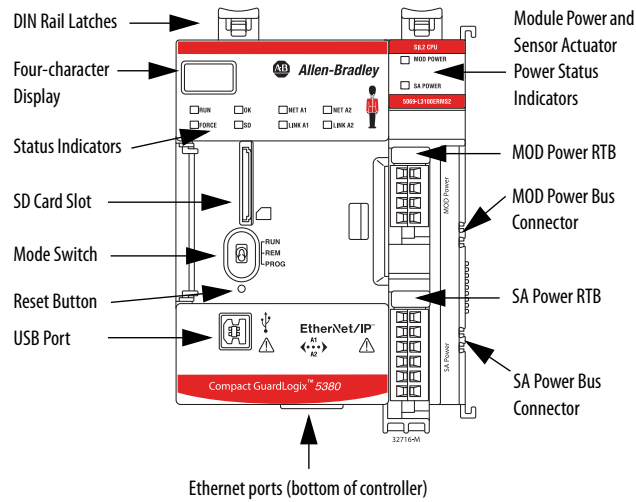

Components Needed to Install the Controller

Component	Description
DIN rail	Compatible zinc-plated, chromate steel DIN rail. You can use the EN50022 - 35 x 7.5 mm (1.38 x 0.30 in.) DIN rail.
EtherNet/IP network components	If your controller operates on an EtherNet/IP network, you must install the network and all required components.
Software	You can use the following software with your controller: <ul style="list-style-type: none"> • BOOTP DHCP EtherNet/IP Commissioning tool, version 3.02.00 or later • Studio 5000 Logix Designer application: version 31.00.00 or later • RSLinx® Classic software, Version 4.00.00 or later When you install the controller, you use one of these software tools to assign an IP address to the controller. For more information, see Set the Network Internet Protocol (IP) Addresses on page 10 .

System Planning

Follow these rules when planning your system configuration:

- You must mount the DIN rail horizontally.
- The controller is the left-most component in the system.
- Local Compact 5000™ I/O modules are installed to the right of the controller.

The number of local I/O modules that are supported varies by controller catalog number.

- Before power-up, make sure that the end cap is installed on the right-most Compact 5000™ I/O module in the system.

Before You Begin

Before you install the controller, verify that you have the following components.

Components Needed to Install the Controller

Component	Description		
Removable Terminal Blocks (RTB)	One of the following RTB types for each power type: <table border="0" style="width: 100%;"> <tr> <td style="vertical-align: top;"> MOD Power (system-side power) <ul style="list-style-type: none"> • 5069-RTB4-SCREW RTB • 5069-RTB4-SPRING RTB </td> <td style="vertical-align: top;"> SA Power (field-side power) <ul style="list-style-type: none"> • 5069-RTB6-SCREW RTB • 5069-RTB6-SPRING RTB </td> </tr> </table> <p>IMPORTANT: You must order RTBs separately. The RTBs are available in 5069 RTB kits. The 5069-RTB64-SCREW kit contains the 5069-RTB6-SCREW and 5069-RTB4-SCREW RTBs. The 5069-RTB64-SPRING kit contains the 5069-RTB6-SPRING and 5069-RTB4-SPRING RTBs. We recommend that you order only the RTB type that your system requires.</p>	MOD Power (system-side power) <ul style="list-style-type: none"> • 5069-RTB4-SCREW RTB • 5069-RTB4-SPRING RTB 	SA Power (field-side power) <ul style="list-style-type: none"> • 5069-RTB6-SCREW RTB • 5069-RTB6-SPRING RTB
MOD Power (system-side power) <ul style="list-style-type: none"> • 5069-RTB4-SCREW RTB • 5069-RTB4-SPRING RTB 	SA Power (field-side power) <ul style="list-style-type: none"> • 5069-RTB6-SCREW RTB • 5069-RTB6-SPRING RTB 		
External power supply for Module (MOD) Power	A power supply that is adequately sized to provide MOD power, that is, system-side power, to the system. For more information, see System Power Considerations on page 6 .		
External power supply for Sensor Actuator (SA) Power	A power supply that is adequately sized to provide SA power, that is, field-side power, to the system. For more information, see System Power Considerations on page 6 .		
Tools	You use the following tools to wire the RTBs: <ul style="list-style-type: none"> • Screwdriver • Wire stripper • Wires For more information on available wire sizes and wire insulation stripping length, see Specifications on page 13 .		



ATTENTION: Do not discard the end cap. Use this end cap to cover the exposed interconnections on the last module on the DIN rail. Failure to do so could result in equipment damage or injury from electric shock.

Spacing

Maintain **spacing** from enclosure walls, wireways, and adjacent equipment.

The minimum distance on all sides of the Compact GuardLogix 5380 system varies based on the operating temperature, as follows:

- 50.8 mm (2.00 in.) at 50 °C (122 °F)
- 101.7 mm (4.00 in.) at 55 °C (131 °F)
- 152.4 mm (6.00 in) at 60 °C (140 °F)

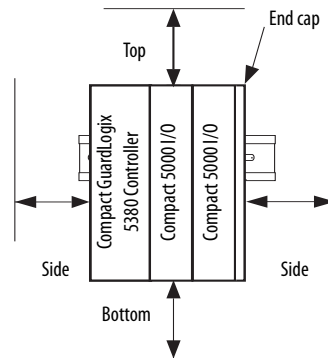

Dimensions

The controller dimensions are as follows.

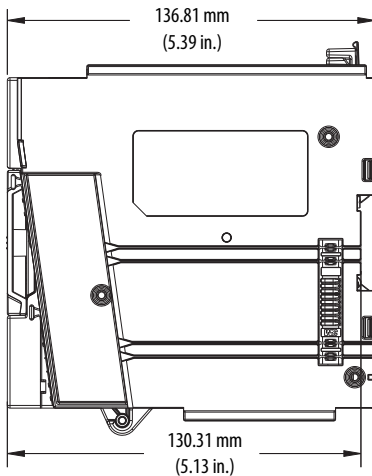
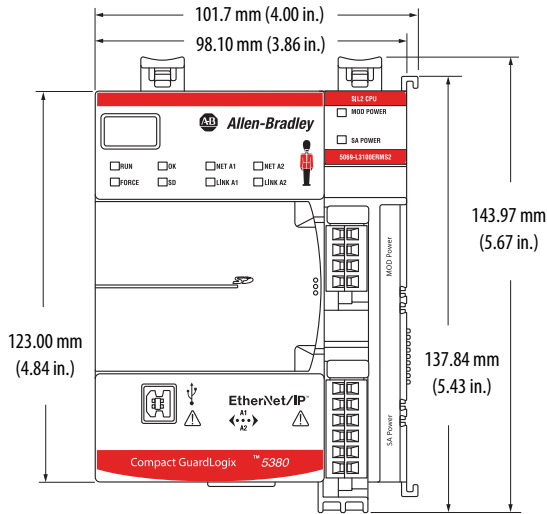

Ground Considerations

You must ground DIN rails according to the Industrial Automation Wiring and Grounding Guidelines, publication [1770-4.1](#)



ATTENTION: This product is grounded through the DIN rail to chassis ground. Use zinc-plated chromate-passivated steel DIN rail to assure proper grounding. The use of other DIN rail materials (for example, aluminum or plastic) that can corrode, oxidize, or are poor conductors, can result in improper or intermittent grounding. Secure DIN rail to mounting surface approximately every 200 mm (7.8 in.) and use end-anchors appropriately. Be sure to ground the DIN rail properly. See the Industrial Automation Wiring and Grounding Guidelines, Rockwell Automation publication [1770-4.1](#) for more information.

You can use the EN50022 - 35 x 7.5 mm (1.38 x 0.30 in.) DIN rail.

System Power Considerations

IMPORTANT For Functional Safety applications, SELV/PELV power supplies are required for both Module Power (MP) and Sensor Actuator (SA) power.

The controller provides power to a Compact GuardLogix 5380 system via RTBs that are connected to external power supplies and installed on the controller. The RTBs provide the following power to the system.

Power Type	Description
MOD Power	<p>System-side power that is used to operate the Compact GuardLogix 5380 system. MOD power is provided through the MOD power RTB and passed across the MOD power bus.</p> <ul style="list-style-type: none"> The total continuous current draw across the MOD power bus must not be more than 5 A, max, at 18...32V DC SELV/PELV. Confirm that the external MOD power supply is adequately sized for the total MOD power bus current draw in the system, plus the MOD power inrush current requirements.
SA Power	<p>Field-side power that is used to power field-side devices. SA power is provided through the SA power RTB and passed across the SA power bus.</p> <ul style="list-style-type: none"> The total continuous current draw across the SA power bus must not be more than 10 A, max at 18...32V DC. You can use a 5069-FPD field potential distributor to establish additional SA power buses in a Compact GuardLogix 5380 system. Your Sensor Actuator (SA) power source must be SELV/PELV. Confirm that the external SA power supply is sized adequately for the total SA power current draw in the system, including the combined inrush current requirements for all connected modules.

IMPORTANT Compact GuardLogix 5380 controllers **do not** have an embedded power supply that powers the system.

Electrical Safety Considerations



ATTENTION: You must use SELV/PELV-listed power supplies for MOD power and SA power if there are Functional Safety modules that are connected to the Compact GuardLogix 5380 controller control system.

IMPORTANT You can connect power from one external power supply to the MOD power and SA power connects. However, we **strongly recommend** that you use **separate external power supplies** for MOD power and SA power respectively.

The practice of using separate external power supplies can prevent unintended consequences that can result if you use one supply.

If you use separate external power supplies, the loss of power from one external power supply does not affect the availability of power from the other supply. For example, if separate external power supplies are used and SA power is lost, MOD power remains available for the Compact 5000 I/O modules.

Install the Controller onto the DIN Rail



WARNING: If you insert or remove the controller while power is on, an electrical arc can occur. This could cause an explosion in hazardous location installations. The controller does not support "Removal and Insertion Under Power" (RIUP) capability. Do not connect or disconnect the controller while power is applied. Be sure that power is removed before proceeding.



ATTENTION: Do not remove or replace the controller while power is applied. Interruption of the backplane can result in unintentional operation or machine motion.

1. Confirm that the DIN rail latches are closed.
2. If the DIN rail latches are open, gently push the rear latch back until the front latch pops up and clicks.

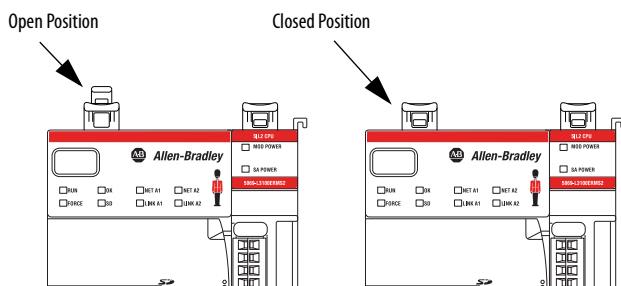

3. Position the controller so that the back of it faces the DIN rail.
4. Press the controller against the DIN rail until you hear a click.
5. Confirm that the controller is latched securely.

Connect External Power Supplies to the Controller

Before you connect MOD power or SA power to the RTBs on the Compact GuardLogix 5380 controller, complete the following tasks:

- Read [System Power Considerations on page 6](#).
- Confirm that the external power supplies that supply MOD power and SA power are adequately sized for your Compact GuardLogix 5380 system. For more information, see [page 6](#).
- Verify that the external power supplies that provide MOD power and SA power are turned off.
- Install the MOD power RTB and the SA power RTB, if used, on the controller.

Install the MOD Power RTB



WARNING: If you connect or disconnect the Removable Terminal Block (RTB) with power applied, an electrical arc can occur. This could cause an explosion in hazardous location installations.

The Removable Terminal Block (RTB) does not support "Removal and Insertion Under Power" (RIUP) capability. Do not connect or disconnect the Removable Terminal Block (RTB) while power is applied. Be sure that power is removed before proceeding.

1. Hook the bottom of the MOD power RTB on the controller.
2. Push the RTB against the controller until you hear a click.

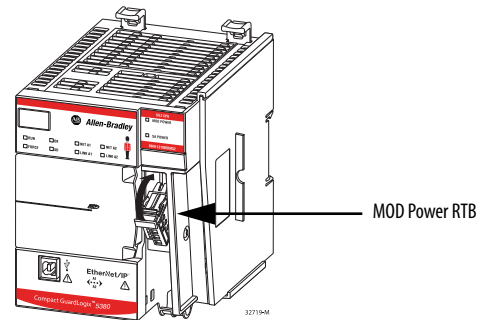

3. Push the RTB handle against the RTB until you hear a click.

Connect MOD Power

Before you connect an external power source to the MOD power RTB, make sure that the MOD power source is properly sized.

For example, if the total MOD power current draw, including current inrush requirements, is 3 A, you can use a MOD power supply that is limited to 3 A.

IMPORTANT Your application can require a power control device, for example, a switch, between the external 24V DC power source and the controller to control when the controller is powered. If so, you must install the power control device at the VDC+ terminal on the RTB.

If you install the power control device at the VDC- terminal, the controller can fail to power up or power down properly.



WARNING: If you connect or disconnect wiring while the field-side power is on, an electrical arc can occur. This could cause an explosion in hazardous location installations. Be sure that power is removed or the area is nonhazardous before proceeding.

1. Verify that the external power supply is not powered.
2. Strip insulation from the wires that you connect to the RTB.

RTB Type	Action
Screw	Strip 12 mm (0.47 in) of insulation from the wires.
Spring	Strip 10 mm (0.39 in) of insulation from the wires.

3. Connect the 24V DC(+) wire from the external power supply to the first MOD(+) terminal.

RTB Type	Action
Screw	1. Insert the wire into the terminal. 2. Turn the screwdriver to close the terminal on the wire. Torque the screw to 0.4 N·m (3.5 lb·in).
Spring	Push the wire into the terminal. If necessary, you can crimp a wire ferrule on the wire and insert it.

5069-RTB4-SCREW RTB

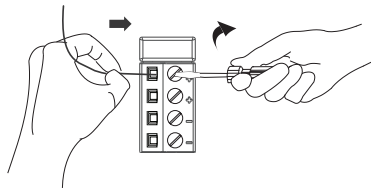

5069-RTB4-SPRING RTB

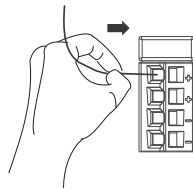

4. Connect the 24V DC(−) wire from the external power supply to the first MOD(−) terminal.

RTB Type	Action
Screw	1. Insert the wire into the terminal. 2. Turn the screwdriver to close the terminal on the wire. Torque the screw to 0.4 N·m (3.5 lb·in).
Spring	Push the wire into the terminal. If necessary, you can crimp a wire ferrule on the wire and insert it.

5069-RTB4-SCREW RTB

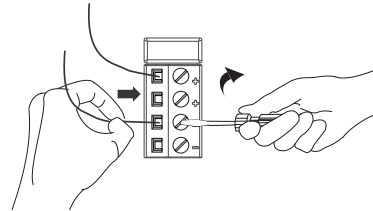

5069-RTB4-SPRING RTB

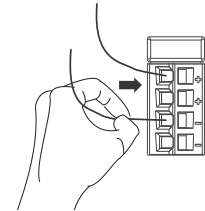

Install the SA Power RTB



WARNING: If you connect or disconnect the Removable Terminal Block (RTB) with power applied, an electrical arc can occur. This could cause an explosion in hazardous location installations.

The Removable Terminal Block (RTB) does not support "Removal and Insertion Under Power" (RIUP) capability. Do not connect or disconnect the Removable Terminal Block (RTB) while power is applied. Be sure that power is removed before proceeding.

1. Hook the bottom of the SA power RTB on the controller.
2. Push the RTB against the controller until you hear a click.

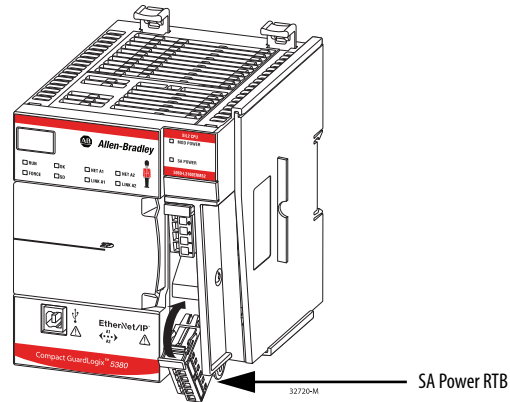

3. Push the RTB handle against the RTB until you hear a click.

Connect SA DC Power

Before you connect an external DC power source to the SA power RTB, make sure that the SA power source is properly sized. For example, if the total SA power current draw, including current inrush requirements, is 3 A, you can use an SA power supply that is limited to 3 A.



WARNING: If you connect or disconnect wiring while the field-side power is on, an electrical arc can occur. This could cause an explosion in hazardous location installations. Be sure that power is removed or the area is nonhazardous before proceeding.

1. Confirm that MOD power and SA power sources are turned off.
2. Strip insulation from the wires that you connect to the RTB.

RTB Type	Action
Screw	Strip 12 mm (0.47 in) of insulation from the wires.
Spring	Strip 10 mm (0.39 in) of insulation from the wires.

3. Connect the DC(+) wire from the external DC power supply to the first SA(+) terminal.

RTB Type	Action
Screw	1. Insert the wire into the terminal. 2. Turn the screwdriver to close the terminal on the wire. Torque the screw to 0.4 N·m (3.5 lb·in).
Spring	Push the wire into the terminal. If necessary, you can crimp a wire ferrule on the wire and insert it.

5069-RTB6-SCREW RTB

5069-RTB6-SPRING RTB

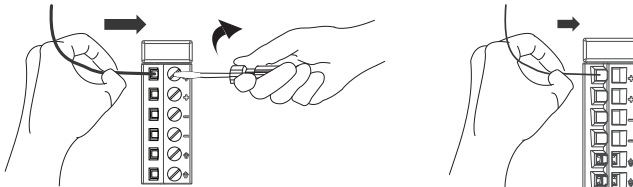

4. Connect the DC(−) wire from the external SA DC power supply to the first SA(−) terminal.

RTB Type	Action
Screw	1. Insert the wire into the terminal. 2. Turn the screwdriver to close the terminal on the wire. Torque the screw to 0.4 N·m (3.5 lb·in).
Spring	Push the wire into the terminal. If necessary, you can crimp a wire ferrule on the wire and insert it.

5069-RTB6-SCREW RTB

5069-RTB6-SPRING RTB

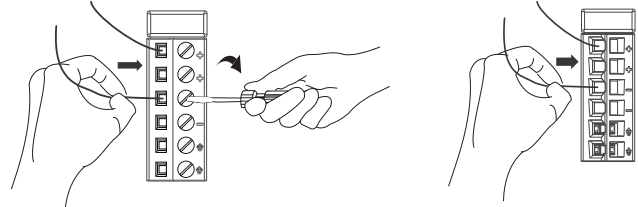

5. Connect a wire from an Earth Ground location to the first Ground (⏏) on the RTB. The Earth Ground location can be the external SA power supply, the DIN rail, or other Earth Ground location.

RTB Type	Action
Screw	1. Insert the wire into the terminal. 2. Turn the screwdriver to close the terminal on the wire. Torque the screw to 0.4 N·m (3.5 lb·in).
Spring	Push the wire into the terminal. If necessary, you can crimp a wire ferrule on the wire and insert it.

5069-RTB6-SCREW RTB

5069-RTB6-SPRING RTB

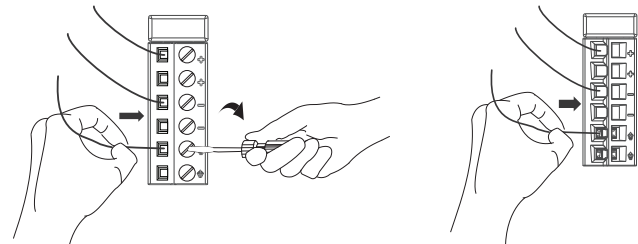

TIP This ⏏ symbol denotes an Earth Ground terminal that provides a low impedance path between electrical circuits and earth for functional purposes and provides noise immunity improvement. This connection must be made for functional purposes.

Disconnect Wires from the RTBs



WARNING: If you connect or disconnect wiring while the field-side power is on, an electrical arc can occur. This could cause an explosion in hazardous location installations. Be sure that power is removed or the area is nonhazardous before proceeding.

If necessary, complete the following tasks to **disconnect** wires from any RTB on the controller.

RTB Type	Action
Screw	<ol style="list-style-type: none"> 1. Turn the screwdriver counter-clockwise to open the terminal. 2. Remove the wire.
Spring	<ol style="list-style-type: none"> 1. Insert and hold a screwdriver in the right-side terminal. 2. Remove the wire. 3. Pull out the screwdriver.

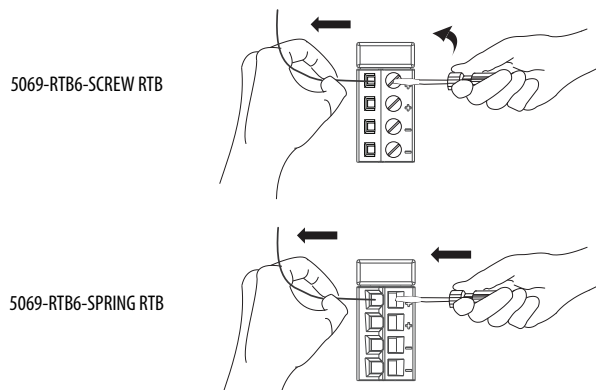

Install the End Cap

You must install an end cap on the right side of the last module in a Compact GuardLogix 5380 system. The end cap covers the exposed interconnections on the last module in the system. If you do not install the end cap before powering the system, equipment damage or injury from electric shock can result.

If you do not intend to install Compact 5000 I/O modules to the system before turning on power to the controller, install the end cap as described in this section.

If you intend to install Compact 5000 I/O modules to the system before turning on power to the controller, do not install the end cap and proceed to [Connect External Power Supplies to the Controller](#).

1. Align the end cap with the interlocking pieces on the controller.
2. Push the end cap toward the DIN rail until it locks into place.

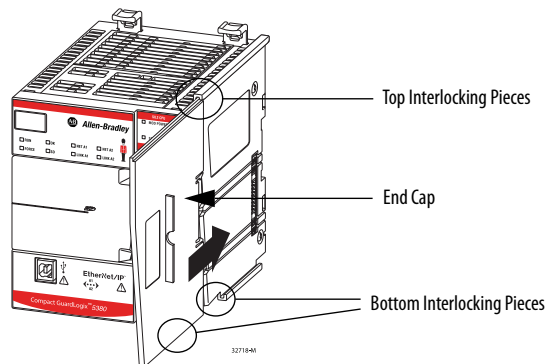

Power the System

After the end cap is installed on the last module in the system, turn on power to the MOD power RTB and the SA power RTB.

Set the Network Internet Protocol (IP) Addresses

Out-of-the-box, Compact GuardLogix 5380 controllers are configured to use Dual-IP mode, and each Ethernet port is DHCP-enabled.

Dual-IP mode is available with the Studio 5000 Logix Designer application, and lets you assign a unique IP address for each Ethernet port.

Compact GuardLogix 5380 controllers also support Linear/DLR mode, a mode that requires only one IP address. If necessary, you can use RSLinx Classic software to change the controller from Dual-IP mode to Linear/DLR mode and then set the IP address on the controller.

You can use the following to assign IP addresses:

- BOOTP DHCP EtherNet/IP Commissioning tool, version 3.02.00 or later
- Studio 5000 Logix Designer application, version 31.00.00 or later
- RSLinx Classic software, version 4.00.00 or later

IMPORTANT Consider the following:

- The controller does not have rotary switches that you can use to set the address.
- You must connect to the controller via the USB port when you use RSLinx Classic software or the Logix Designer application to assign an IP address.
- To reset the IP address and set the controller to DHCP-enabled, you must perform a Stage 2 Reset. A Stage 2 Reset returns the controller to the out-of-box state.

For information on how to set the IP address for a controller or perform a reset, see the CompactLogix™ 5380 and Compact GuardLogix 5380 Controllers User Manual, publication [5069-UM001](#).

Connect the Controller to an EtherNet/IP Network

IMPORTANT Before you can connect the controller to an EtherNet/IP network, you must first install the network and its components.

This section assumes that the EtherNet/IP network is installed.

Use an RJ45 cable to connect the controller to an EtherNet/IP network.



WARNING: If you connect or disconnect the communication cable with power applied to this controller or any device on the network, an electrical arc can occur. This could cause an explosion in hazardous location installations.

Be sure that power is removed or the area is nonhazardous before proceeding.

1. If needed, wire the RJ45 connector as shown.

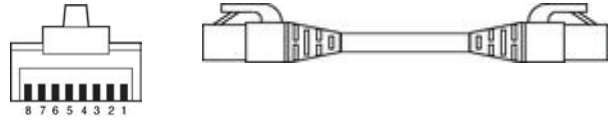

Connector Number	Color	1585J 8-pin Cables with Support for 10/100/1000 Mbps	1585J 8-pin Cables with Support for 10/100 Mbps	1585J 4-pin Cables with Support for 10/100 Mbps
1	White/Orange	BI_DA+	TxData +	
2	Orange	BI_DA-	TxData -	
3	White/Green	BI_DB+	Recv Data +	
4	Blue	BI_DC+	Unused	—
5	White/Blue	BI_DC-	Unused	—
6	Green	BI_DB-	Recv Data -	
7	White/Brown	BI_DD+	Unused	—
8	Brown	BI_DD-	Unused	—

2. Connect the RJ45 cable to an Ethernet port on the controller. You can connect two RJ45 cables to the controller.

Remove or Replace the Controller



WARNING: If you insert or remove the controller while power is on, an electrical arc can occur. This could cause an explosion in hazardous location installations. The controller does not support "Removal and Insertion Under Power" (RIUP) capability. Do not connect or disconnect the controller while power is applied. Be sure that power is removed before proceeding.



ATTENTION: Do not remove or replace a controller while power is applied. Interruption of the backplane can result in unintentional operation or machine motion.

1. Turn off power to the MOD power and the SA power RTBs.

IMPORTANT

When you remove MOD power from the controller, you shut down power to all modules in the system. That is, all system-side is removed. When you remove SA power from the controller, all field-side power that is provided by the controller is removed. If the system uses the SA power that is provided by a 5069-FPD field potential distributor, the system does not lose field-side power to the right of the field potential distributor.

In this case, you must use a separate power source for the SA power RTB on the field potential distributor.

Before removing MOD power or SA power from the system, we strongly recommend that you take the appropriate actions to help prevent unintended consequences that can result from a system power shutdown.

Despite the removal of power from SA RTBs on the controller or field potential distributor, the 5069-OB16 and 5069-OB16F modules continue to receive field-side power. The modules receive power from an external power source that is connected to the LA (+) and LA (-) module terminals.

2. Disconnect wires from the RTBs.

For more information, see [Disconnect Wires from the RTBs on page 10](#).

3. Pull the RTB handles to remove the MOD power RTB and SA power RTB.

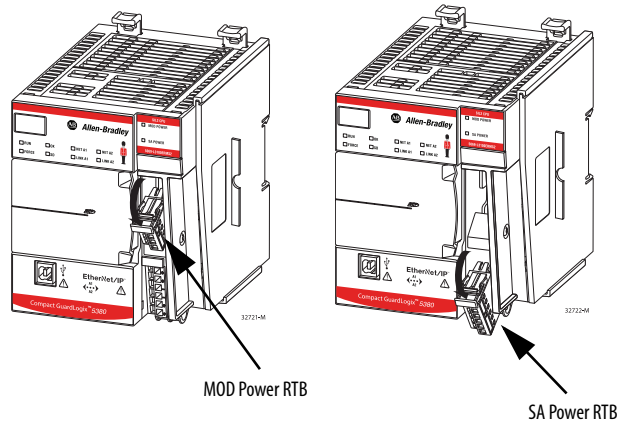

4. Remove the Ethernet cable from the controller.
5. Push down on the front of the DIN rail latches. A click indicates that the DIN rail latches are open.

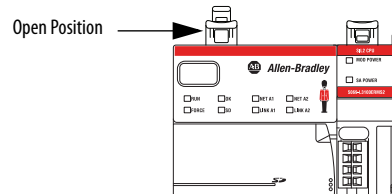

If the DIN rail latches fail to remain in the open position, hold them down.

6. Pull the controller off the DIN rail.
7. Repeat the installation steps that are described beginning at [Install the Controller onto the DIN Rail on page 7](#).
8. Apply MOD power and, if necessary, SA power to the system.

Specifications

The following table lists a subset of controller specifications. For a list of specifications, see the CompactLogix 5380 and Compact GuardLogix 5380 Controllers Specifications Technical Data, publication [5069-TD002](#).

Attribute	5069-L306ERS2, 5069-L306ERMS2, 5069-L310ERS2, 5069-L310ERMS2, 5069-L320ERS2, 5069-L320ERS2K, 5069-L320ERMS2, 5069-L320ERMS2K, 5069-L330ERS2, 5069-L330ERS2K, 5069-L330ERMS2, 5069-L330ERMS2K, 5069-L340ERS2, 5069-L340ERMS2, 5069-L350ERS2, 5069-L350ERS2K, 5069-L350ERMS2, 5069-L350ERMS2K, 5069-L380ERS2, 5069-L380ERMS2, 5069-L3100ERS2, 5069-L3100ERMS2
Temperature, operating IEC 60068-2-1 (Test Ad, Operating Cold), IEC 60068-2-2 (Test Bd, Operating Dry Heat), IEC 60068-2-14 (Test Na, Operating Thermal Shock)	0 °C < Ta < +60 °C (+32 °F < Ta < +140 °F) with 152.4 mm (6 in.) clearance on left, top, and bottom sides 0 °C < Ta < +55 °C (+32 °F < Ta < +131 °F) with 101.7 mm (4 in.) clearance on left, top, and bottom sides 0 °C < Ta < +50 °C (+32 °F < Ta < +122 °F) with 50.8 mm (2 in.) clearance on left, top, and bottom sides
Temperature, surrounding air, max	60 °C (140 °F)
Enclosure Type Rating	None (open-style)
Module Power bus (MOD Power) voltage range	18...32V DC SELV/PELV ⁽³⁾
Module Power bus (MOD Power) current, max	475 mA
Module Power bus (MOD Power) inrush	1.2 A
Module Power bus (MOD Power) Passthrough voltage range ⁽¹⁾	18...32V DC @ 4.525 A
Module Power bus (MOD Power) current rating, max	5 A Do not exceed 5 A current draw at the MOD Power RTB.
Sensor Actuator (SA) Field Power voltage ranges	0...32V DC SELV/PELV ⁽³⁾
Sensor Actuator (SA) Field Power current, max	10 mA (DC power)
Sensor Actuator Power bus (SA Power) Passthrough voltage ranges ⁽²⁾	0...32V DC @ 9.99 A
Sensor Actuator Power bus (SA Power) current rating, max	10 A (DC power) Do not exceed 10 A current draw at the SA Power RTB.
Isolation voltage	300V (continuous), Basic Insulation Type, SA, and MOD Power to Backplane 300V (continuous), Basic Insulation Type, SA to MOD Power 300V (continuous), Basic Insulation Type, Ethernet to Backplane 300V (continuous), Double Insulation Type, Ethernet to MOD Power 300V (continuous), Double Insulation Type, Ethernet to SA Power 50V (continuous), Functional Insulation Type, Ethernet to USB 300V (continuous), Basic Insulation Type, USB to Backplane 300V (continuous), Double Insulation Type, USB to MOD Power 300V (continuous), Double Insulation Type, USB to SA Power No isolation between Ethernet ports Type tested at 1500V AC for 60 seconds
Wire size	5069-RTB4-SCREW, 5069-RTB6-SCREW connections: 0.5...1.5 mm ² (22...16 AWG) solid or stranded copper wire rated at 105 °C (221 °F), or greater, 3.5 mm (0.14 in.) max diameter including insulation, single wire connection only 5069-RTB4-SPRING, 5069-RTB6-SPRING connections: 0.5...1.5 mm ² (22...16 AWG) solid or stranded copper wire rated at 105 °C (221 °F), or greater, 2.9 mm (0.11 in.) max diameter including insulation, single wire connection only Ethernet connections: Ethernet Cabling and Installation according to IEC 61918 and IEC 61784-5-2
Insulation stripping length	5069-RTB4-SCREW, 5069-RTB6-SCREW connections: 12 mm (0.47 in.) 5069-RTB4-SPRING, 5069-RTB6-SPRING connections: 10 mm (0.39 in.)
Terminal block torque	5069-RTB4-SCREW & 5069-RTB6-SCREW: 0.4 N·m (3.5 lb·in) 5069-RTB4-SPRING & 5069-RTB6-SPRING: N/A
North American temperature code	T4
ATEX temperature code	T4
IECEx temperature code	T4

(1) Maximum level of MOD Power current that the controller can pass through to the next module in the system. The specific level of current passed through varies based on system configuration.

(2) Maximum level of SA Power current that the controller can pass through to the next module in the system. The specific level of current passed through varies based on system configuration.

(3) For Functional Safety applications, SELV/PELV power supplies are required for both Module Power (MP) and Sensor Actuator (SA) power.

European Machinery Directive Approval

The following applies to products with EU Machinery Directive certification:

- Are in conformity with the essential requirements of the EU Machinery Directive (2006/42/EC) when installed in accordance with the instructions contained in the product documentation.
- The type of protection is Cat. 3/PL d according to EN ISO 13849-1, and SIL 2 according to EN 62061/IEC 61508.
- Comply to Standards EN ISO 13849-1:2015 and EN62061:2005 + A1:2013 + A2:2015, reference certificate number 01/205/5632.xx/yy.
- See the Product Certification link at <http://www.rockwellautomation.com/global/certification/overview.page> for Declarations of Conformity, Certificates, and other certification details including a full list of safety-related certifications.
- May have catalog numbers followed by a "K" to indicate a conformal coating option.

Additional Resources

These documents contain additional information concerning related products from Rockwell Automation.

Resource	Description
CompactLogix 5380 and Compact GuardLogix 50380 Controllers Specifications Technical Data, publication 5069-TD002	Provides specifications and other technical data for CompactLogix 5380 and Compact GuardLogix 5380 controllers.
CompactLogix 5380 and GuardLogix 5380 Controller User Manual, publication 5069-UM001	Describes how to configure, operate, and monitor CompactLogix 5380 and Compact GuardLogix 5380 controllers.
GuardLogix 5580 and Compact GuardLogix 5380 Controller Systems Safety Reference Manual, publication 1756-RM012	Provides information on safety application requirements for GuardLogix 5580 and Compact GuardLogix 5380 controllers in Studio 5000 Logix Designer applications.
Industrial Automation Wiring and Grounding Guidelines, publication 1770-4.1	Provides general guidelines for installing a Rockwell Automation industrial system.
Product Certifications website, http://www.rockwellautomation.com/global/certification/overview.page	Provides declarations of conformity, certificates, and other certification details.

You can view or download publications at <http://www.rockwellautomation.com/global/literature-library/overview.page>. To order paper copies of technical documentation, contact your local Allen-Bradley distributor or Rockwell Automation sales representative.

Notes:

Rockwell Automation Support

Use the following resources to access support information.

Technical Support Center	Knowledgebase Articles, How-to Videos, FAQs, Chat, User Forums, and Product Notification Updates.	https://rockwellautomation.custhelp.com/
Local Technical Support Phone Numbers	Locate the phone number for your country.	http://www.rockwellautomation.com/global/support/get-support-now.page
Direct Dial Codes	Find the Direct Dial Code for your product. Use the code to route your call directly to a technical support engineer.	http://www.rockwellautomation.com/global/support/direct-dial.page
Literature Library	Installation Instructions, Manuals, Brochures, and Technical Data.	http://www.rockwellautomation.com/global/literature-library/overview.page
Product Compatibility and Download Center (PCDC)	Get help determining how products interact, check features and capabilities, and find associated firmware.	http://www.rockwellautomation.com/global/support/pcdc.page

Documentation Feedback

Your comments will help us serve your documentation needs better. If you have any suggestions on how to improve this document, complete the How Are We Doing? form at http://literature.rockwellautomation.com/idc/groups/literature/documents/du/ra-du002_-en-e.pdf.

Rockwell Automation maintains current product environmental information on its website at <http://www.rockwellautomation.com/rockwellautomation/about-us/sustainability-ethics/product-environmental-compliance.page>.

Allen-Bradley, Compact 5000, CompactLogix, GuardLogix, Rockwell Automation, Rockwell Software, RSLink, and Studio 5000 Logix Designer are trademarks of Rockwell Automation, Inc. Trademarks not belonging to Rockwell Automation are property of their respective companies.

Rockwell Otomasyon Ticaret A.Ş., Kar Plaza İş Merkezi E Blok Kat:6 34752 İçerenköy, İstanbul, Tel: +90 (216) 5698400

www.rockwellautomation.com

Power, Control and Information Solutions Headquarters

Americas: Rockwell Automation, 1201 South Second Street, Milwaukee, WI 53204-2496 USA, Tel: (1) 414.382.2000, Fax: (1) 414.382.4444
Europe/Middle East/Africa: Rockwell Automation NV, Pegasus Park, De Kleetlaan 12a, 1831 Diegem, Belgium, Tel: (32) 2 663 0600, Fax: (32) 2 663 0640
Asia Pacific: Rockwell Automation, Level 14, Core F, Cyberport 3, 100 Cyberport Road, Hong Kong, Tel: (852) 2887 4788, Fax: (852) 2508 1846

Publication 5069-IN014B-EN-P - June 2018

Supersedes Publication 5069-IN014A-EN-P - March 2018

PN-499948

Copyright © 2018 Rockwell Automation, Inc. All rights reserved. Printed in the U.S.A.