

PHOTOSWITCH DIN Rail Fiber Optic Amplifier

Catalog Numbers 46DFA-L2LBT1-A2, 46DFA-L2LBT1-F4, 46DFA-L2LBT1-Y4

Topic	Page
Description	1
Features	1
Sensor Installation	1
Fiber-optic Cable Installation	2
Basic Settings and Operation	2

Description

Bulletin 46DFA PHOTOSWITCH® DIN rail fiber-optic amplifier is a dual display that is designed for the detection of objects with the use of a standard 2.2 mm (0.09 in.) diameter fiber-optic cable. These sensors are ideal for assembly and packaging applications where you detect objects in limited spaces or applications that require high speeds. Additional sensing flexibility can be achieved when used with the wide variety of fiber-optic tips.

Bulletin 43G glass fiber-optic cables compatible with this amplifier are ideal for use in high temperature applications. For continuous movement and high-flex applications, we recommend the use of the Bulletin 43P small aperture plastic fiber cables.

Features

- Two high-visibility displays provide configuration and operation feedback that makes the sensor easy to set up, operate, and maintain.
- ECO (economy) display mode reduces amplifier power consumption by 25%.
- Teachable LED intensity provides added flexibility in applications where there's a need to detect clear or transparent objects.
- Fast-response output using pin 2 when connected using IO-Link enables continuous sensor monitoring without impact on response time needs.
- Fast response speeds of 50 μs, 500 μs, 4 ms, and 32 ms allows operators easy adaptation of the sensor response time to their application needs.
- Built-in totalizer feature allows operator to trigger the sensor output once a certain count value has been reached.

- Cross-talk protection enables operation of sensors in close proximity without an impact on performance.
- Selectable PNP and NPN output using push button simplifies inventory.
- Embedded IO-Link 1.1 Communication protocol that is offered in all standard modes.
- IP40 rated enclosure.

Sensor Installation

Figure 1 - DIN Rail and Dedicated Mounting Bracket

1. DIN rail mount
Hook the front tab on the rail (or mounting bracket) and then press the rear section.
2. Removal
To remove the front tab, press the unit forward, and pull the front section up.

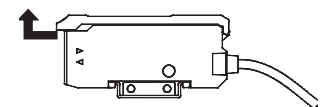
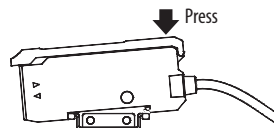

3. Side mount
Install the side of the amplifier unit using an optional mounting bracket.

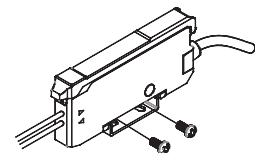
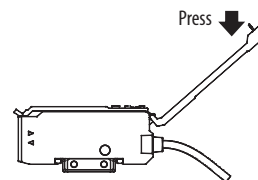
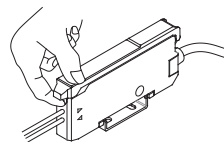
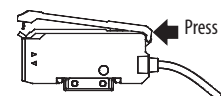

Figure 2 - Amplifier Case Cover

1. To open the sensor cover
Lift the cover by pulling up the tab.
2. To remove the case cover
The cover can be removed by pressing the edge of the fully opened cover.



3. To attach the case cover
Place the removed cover on the amplifier unit as shown and then press the hinge.



Fiber-optic Cable Installation

Figure 3 - Installation Into Amplifier Unit

1. Flip down the lock lever.
2. Insert the fiber-optic cable unit until it stops.

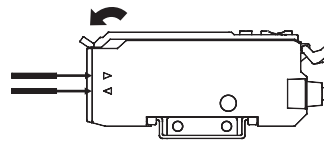

3. After inserting the fiber-optic cable unit, flip up the lock lever and secure the cable.

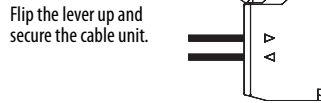

Figure 4 - Coaxial-reflection Type Fiber-optic Cable

Attach the multi-core fiber-optic cable to the receiver side and the single-core fiber cable to the transmitter side.

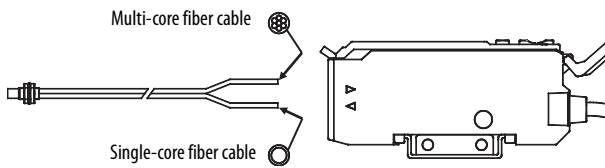
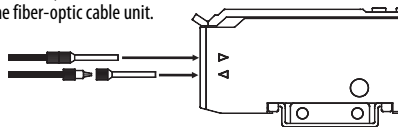

Figure 5 - Thin Fiber-optic Cable

When using a thin fiber-optic cable unit, use the adapter that is provided with the fiber-optic cable unit.



Basic Settings and Operation

Figure 6 - Basic Settings

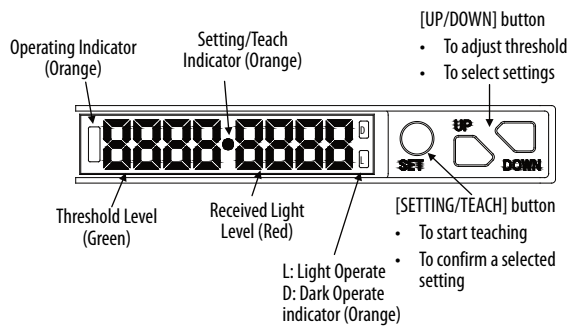

Teach Procedure

Hold down SET during normal operation, as shown in [Figure 7](#), to start the teaching operation. Five types of teaching are available by operation of the SET button.

Figure 7 - Normal Operation/Sensitivity Teach Flow

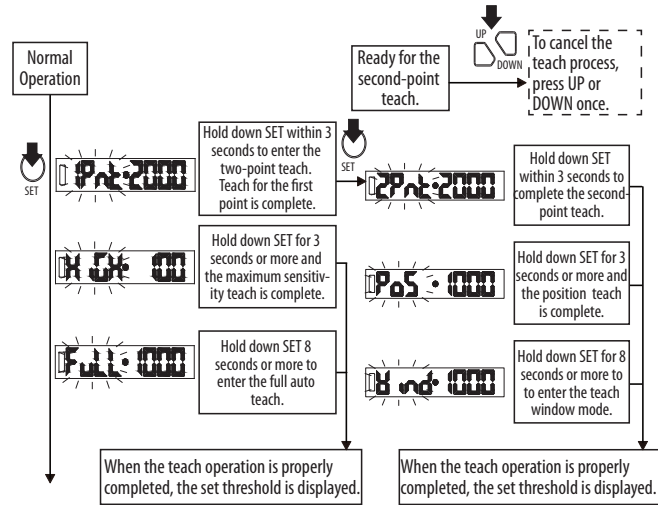
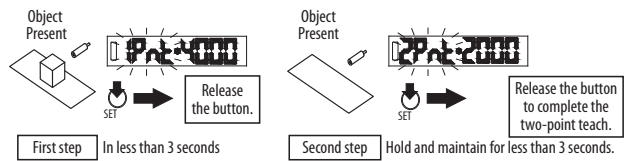
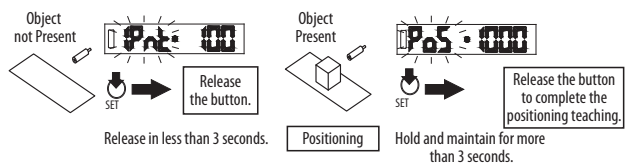

Figure 8 - Two-point Teach



This procedure sets the threshold as the average of the received light levels at the two positions for which teaching was performed. For example, the received light for the first point is 4000 and the received light for the second point is 2000. The threshold is automatically set to 3000.

Figure 9 - Position/Precision Teach



This procedure sets the threshold for the received light levels at the position to be detected. For example, the received light level during position teach is 1000 and the threshold is automatically set to 1000.

Figure 10 - Window Teach Mode

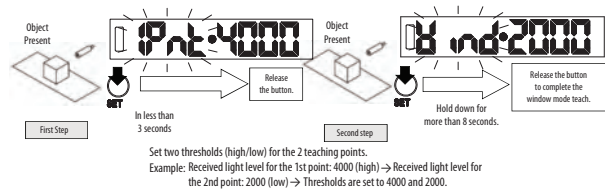

Figure 6 - Basic Settings (continued)

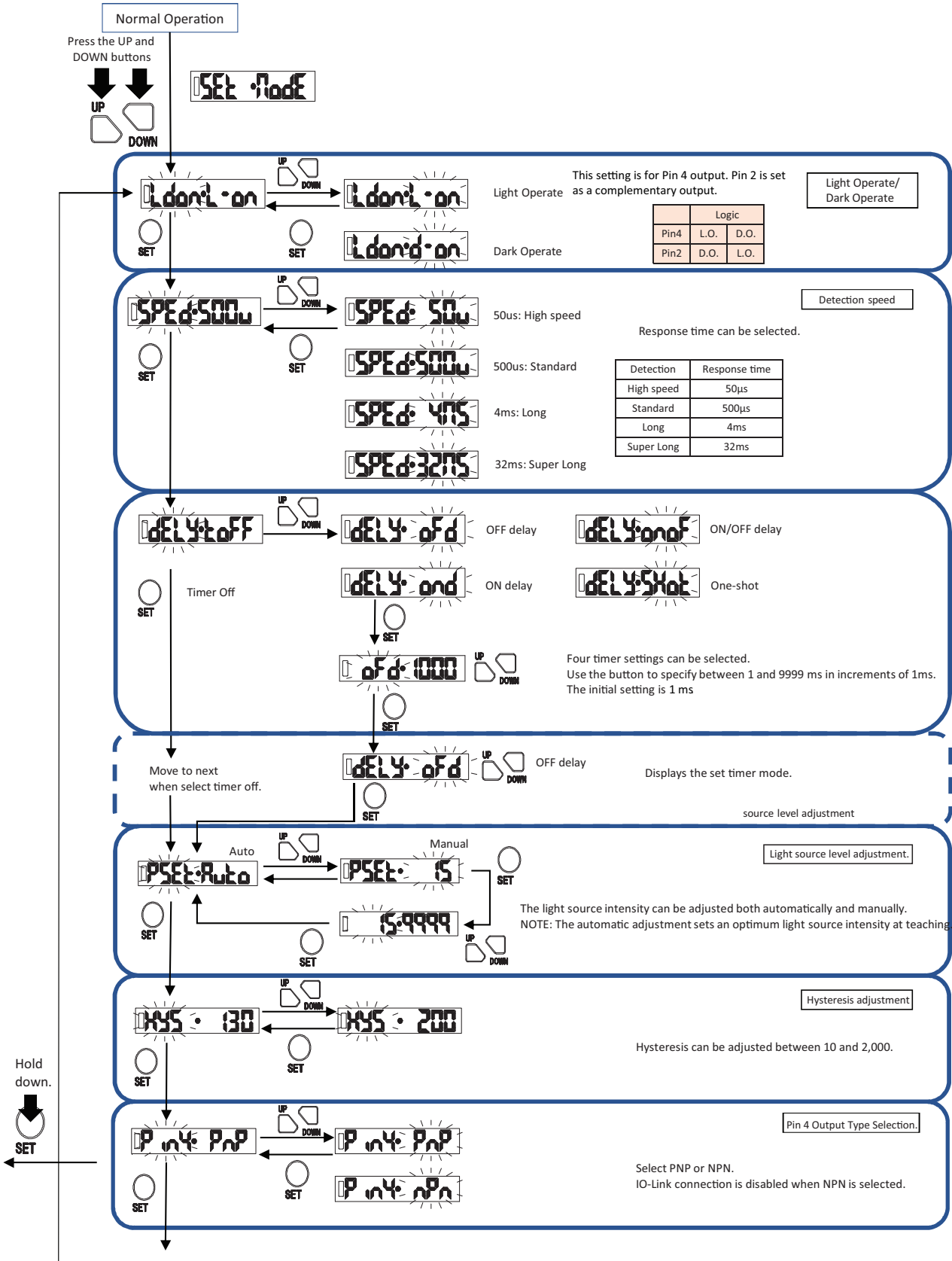

Figure 6 - Basic Settings (continued)

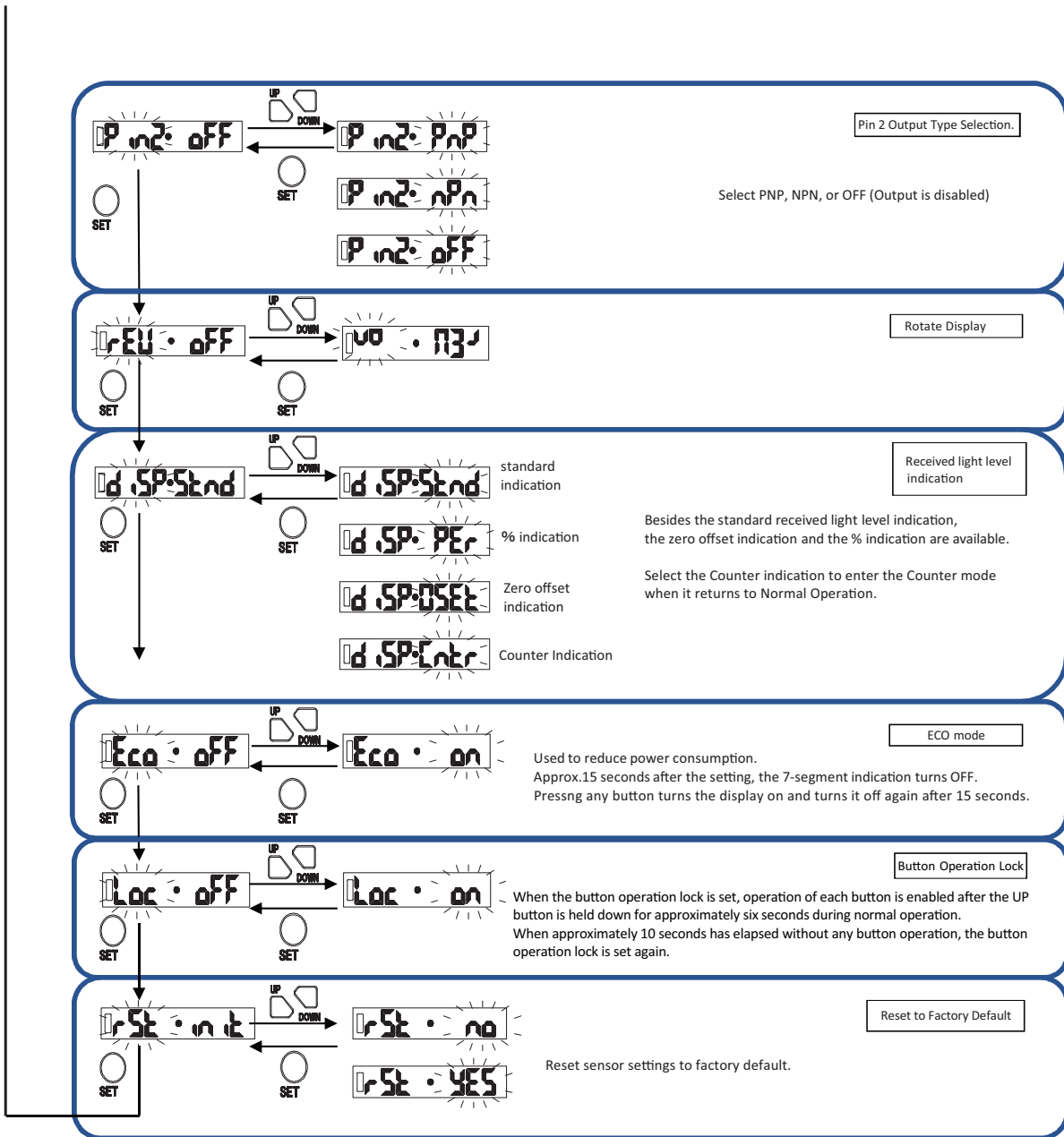

Figure 11 - Counter Mode

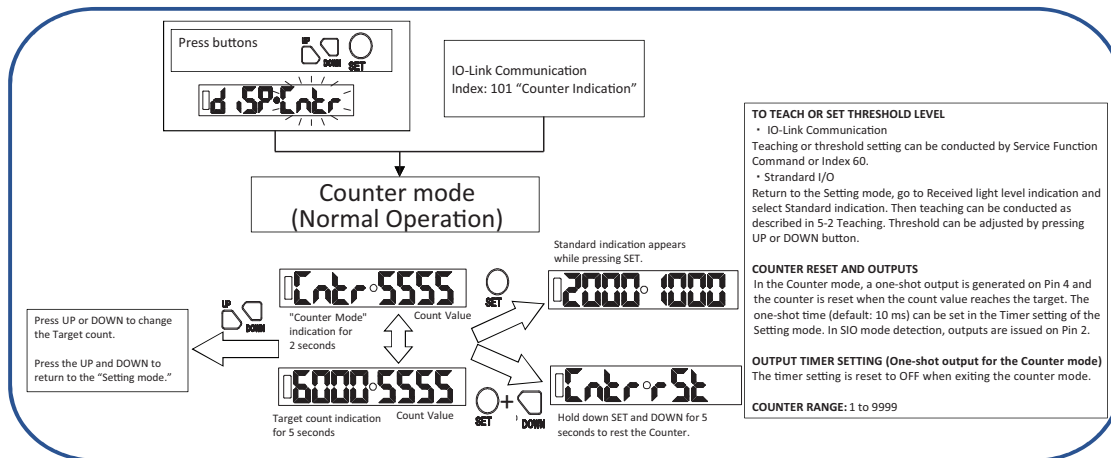
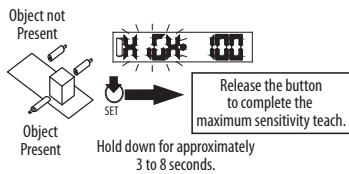

Figure 12 - Maximum Sensitivity Teach



The threshold is automatically set to a value larger than the maximum received light level while the button is pressed. Example: Received light level: 100 and the threshold is automatically set to 200.

Figure 13 - Maximum Sensitivity with Percent Indication



When selecting the percent indication for through beam types, the threshold is automatically set to a value smaller than the minimum received light level while the button is pressed. Example: Received light level: 2000 and the threshold is automatically set to 1900.

Figure 14 - Full Auto Teach

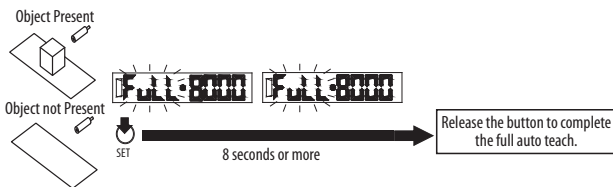

The threshold is automatically set as the average of the maximum and minimum received light levels while the button is pressed. For example, the maximum received light level is 8000 and the minimum received light level is 1000 during teaching and the threshold are automatically set to 4500.

See [Table 1](#) for teach errors. The sensor holds the threshold before teaching and returns to normal operation when a teaching error occurs.

Table 1 - Teach Errors

Display	Description	Solution
Err 1	The threshold to be set is too high. • 50 μs mode: 3500 or more • 500 μs mode: 9700 or more • 4 ms mode: 9700 or more • 32 ms mode: 9700 or more	Reduce the received light intensity. • Reduce the light power manually. • Use fiber cables of smaller diameter. • Detect at longer range.
Err 2	The threshold to be set is too low. • 50 μs mode: 100 or less • 500 μs mode: 180 or less • 4 ms mode: 50 or less • 32 ms mode: 22 or less	Increase the received light intensity. • Increase the light power manually. • Use fiber cables of larger diameter. • Detect at shorter range.

Teach Time Out

If the teach process has not been completed within 30 seconds, the teach process is canceled and the sensor returns to normal operation.

Sensor Functions

Four types of delay timer modes are available, see [Figure 15](#).

Figure 15 - Timers

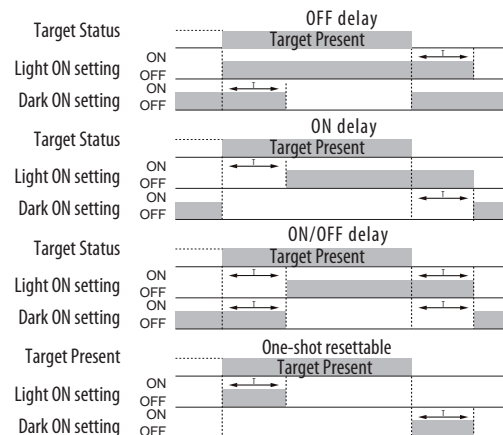

Received Light Level Indication

Three types of indication are available for the received light level and threshold.

Standard Indication

The direct values of received light level and threshold are displayed without correction.

Figure 16 - Standard Indication



Percent Indication

The received light level and threshold are displayed in percent as the maximum received light level during teaching is set to 100. The same displayed values can be arranged when multiple through-beam type units are in use.

This display may not be arranged at 100 as the received light intensity varies depending on environmental factors.

Figure 17 - Percentage Indication



Figure 18 - Zero Offset Indication

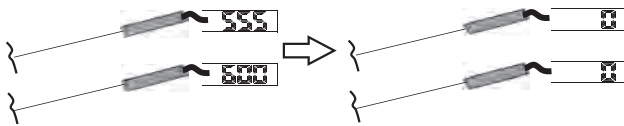

Differential value is displayed in the received light level and threshold as the minimum value of the received light level during teaching is set to zero. The same displayed values can be arranged when multiple reflective-type units are in use.

Figure 19 - Percent and Zero Offset Indication Examples

Percentage Indication



The received light level is displayed as a percentage because the maximum received light level during teaching is set to 100.

During teaching (the received light level is displayed).

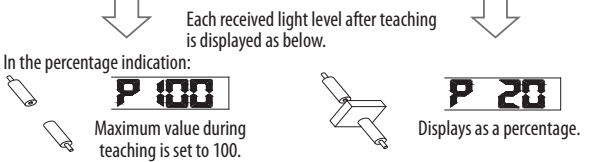
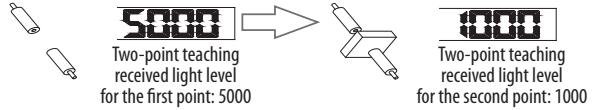

Zero offset indication



Differential value (displayed as the minimum received light level during teaching) is set to zero.

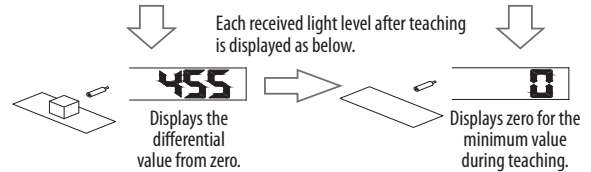
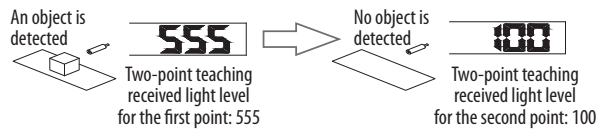

Crosstalk Avoidance

The sensor offers an optical unit-to-unit crosstalk avoidance feature when multiple amplifiers are operating in close proximity. To enable this function, the Bulletin 46DFA amplifier must be installed side-by-side and as close as possible in the DIN rail. To be sure there's a reliable crosstalk avoidance, we recommend that you use the DIN rail stop catalog number 60-BDFA-STP to firmly secure the units. This feature is disabled when the sensor is set to operate in 50 μs mode.

Figure 20 - DIN Rail Stop Catalog Number 60-BDFA-STP

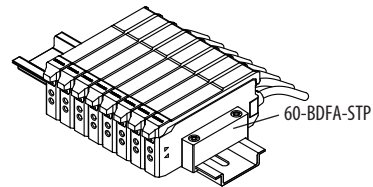

Light Source Intensity Adjustment Feature

The light source intensity can be automatically or manually adjusted.

Automatic Adjustment

The light source intensity is automatically adjusted when teaching is initiated. The light source level is settable to 15 steps for the 500 μ s, 4 ms, and 32 ms modes and 12 steps for the 50 μ s mode. Larger numbers indicate higher light intensity.

Manual Adjustment

The sensitivity teach procedure does not change the light source intensity. Adjust the light source level manually when Teach errors occur (see Teach Errors in [Table 1 on page 5](#)).

IMPORTANT Light source intensity can be low depending on the level set in which the light spot cannot be seen.

Figure 21 - Cat. No. 46DFA-L2LBT1-X Dimensions [mm (in.)]

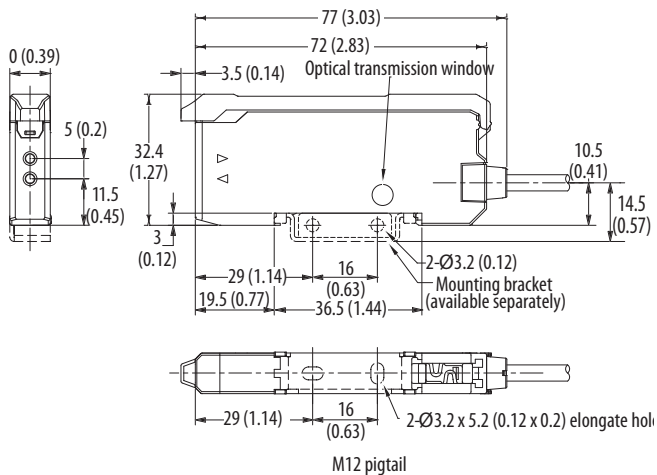

Table 2 - Specifications

Attribute	46DFA-L2LBT1-A2, 46DFA-L2LBT1-F4, 46DFA-L2LBT1-Y4
Operating voltage	12...24V DC, Class 2/Ripple 10% or less
Power consumption	Normal mode: 1000 mW or less (40 mA or less at 24V) ECO mode: 750 mW or less (30 mA or less at 24V)
Output types	NPN open collector output/Load current 100 mA (30V DC, Class 2) or less/ Residual voltage: 2V or less PNP open collector output/Load Current 100 mA(30V DC class 2) or less/ residual voltage: 2V or less
Output modes	Selectable Light Operate (L.O.) or Dark Operate (D.O.)
Output Timers	ON delay, Off delay, ON/OFF delay, Resettable One-shot, Timer off Delay timer: 1...9999 ms (set in millisecond)
Output response time	Selectable: 50 μ s, 500 μ s, 4 ms, and 32 ms. The default setting is 500 μ s.
Light source (wavelength)	Four-element (AlGaInp) LED (660 nm)
User interface	Operating indicator, setting/teaching indicator, L.O./D.O. Indicator: orange LED
Display	Received light level: 4 digits in red LED (50 μ s mode [(0...3800), 500 μ s/ 4 ms/32 ms mode (0...9999)]) Threshold: 4 digits in green LED (50 μ s mode [(0...3500, 500 μ s/4 ms/ 32 ms mode (0...9700)])
Adjustment options	Teach and Set Button (SET) Threshold and Configuration adjustment (UP/DOWN)
Sensitivity setting	Two-point teach/max sensitivity teach/full auto teach/position teach and window mode teach
Sensitivity adjustment function	Provided
Light source level adjustment	Provided (auto/manual)
Mutual interference prevention	Up to 8 units (500 μ s, 4 ms, and 32 ms modes only)
Protection circuit	Power reverse connection/output short-circuit protection
Material	Polycarbonate
Wiring options	2 m (6.56 ft) attached cable [outer dimension: 4.2 mm (0.16 in.) dia.] 0.2 mm ² (0.007 in.) 4 cores
Weight	Approximately 75 g (2.64 oz)
Ambient light	Illumination on light receiving surface: 3500 lx or less (incandescent lamp)
Ambient temperature	1...5 adjacent units in operation: -25...+55 °C (-13...+131 °F) 6 or more adjacent units in operation: -25...+50 °C (-13...+122 °F) Storage: -40...+70 °C (-40...+158 °F) (nonfreezing, noncondensing)
Ambient humidity	35...85% RH (noncondensing)
MTTF	53 years
Protective structure	IP40
Vibration	10...55 Hz/1.5 mm () double amplitude/2 hours each in X, Y, and Z directions
Shock	500 m/s ² /3 times each in X, Y, and Z directions
Dielectric withstanding	1000V AC for 1 minute
Insulation resistance	500V DC mega, 20 M Ω

UL: Maximum ambient temperature: 50 °C (122 °F) for single use, 40 °C (104 °F) for an installation with two or more units connected.

Table 3 - IO-Link Specifications

Attribute	46DFA-L2LBT1-xx
Model	2 m (6.56 ft) cable, 4-pin M12 QD on 150 mm (5.9 in.) pigtail, 4-pin M8QD on 150 mm (5.9 in.) pigtail
IO-Link version	V.1.1
Communication mode	COM2 (38.4 kbps)
Cycle time	3.6 ms, min
Process data length	4 Byte
Vendor ID	2
Device ID	291

Figure 22 - Micro (M12) Male QD on Pigtail and Pico (M8) Male QD on Pigtail Wiring

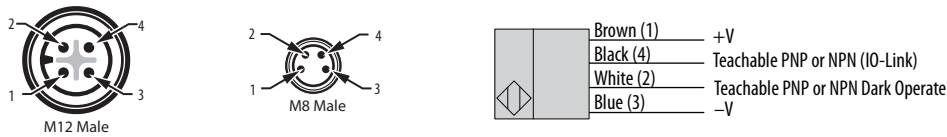

Rockwell Automation Support

Use the following resources to access support information.

Technical Support Center	Knowledgebase Articles, How-to Videos, FAQs, Chat, User Forums, and Product Notification Updates.	https://rockwellautomation.custhelp.com/
Local Technical Support Phone Numbers	Locate the phone number for your country.	http://www.rockwellautomation.com/global/support/get-support-now.page
Direct Dial Codes	Find the Direct Dial Code for your product. Use the code to route your call directly to a technical support engineer.	http://www.rockwellautomation.com/global/support/direct-dial.page
Literature Library	Installation Instructions, Manuals, Brochures, and Technical Data.	http://www.rockwellautomation.com/global/literature-library/overview.page
Product Compatibility and Download Center (PCDC)	Get help determining how products interact, check features and capabilities, and find associated firmware.	http://www.rockwellautomation.com/global/support/pcdc.page

Documentation Feedback

Your comments will help us serve your documentation needs better. If you have any suggestions on how to improve this document, complete the How Are We Doing? form at http://literature.rockwellautomation.com/idc/groups/literature/documents/du/ra-du002_-en-e.pdf.

Waste Electrical and Electronic Equipment (WEEE)



At the end of life, this equipment should be collected separately from any unsorted municipal waste.

Rockwell Automation maintains current product environmental information on its website at <http://www.rockwellautomation.com/rockwellautomation/about-us/sustainability-ethics/product-environmental-compliance.page>.

Allen-Bradley, PHOTOSWITCH, Rockwell Automation, and Rockwell Software are trademarks of Rockwell Automation, Inc. Trademarks not belonging to Rockwell Automation are property of their respective companies.

Rockwell Otomasyon Ticaret A.Ş., Kar Plaza İş Merkezi E Blok Kat:6 34752 İçerenköy, İstanbul, Tel: +90 (216) 5698400

www.rockwellautomation.com

Power, Control and Information Solutions Headquarters

Americas: Rockwell Automation, 1201 South Second Street, Milwaukee, WI 53204-2496 USA, Tel: (1) 414.382.2000, Fax: (1) 414.382.4444
 Europe/Middle East/Africa: Rockwell Automation NV, Pegasus Park, De Kleetlaan 12a, 1831 Diegem, Belgium, Tel: (32) 2 663 0600, Fax: (32) 2 663 0640
 Asia Pacific: Rockwell Automation, Level 14, Core F, Cyberport 3, 100 Cyberport Road, Hong Kong, Tel: (852) 2887 4788, Fax: (852) 2508 1846

Publication 46DFA-IN001A-EN-P - January 2019

10004032814 Ver 00

Copyright © 2019 Rockwell Automation, Inc. All rights reserved. Printed in the U.S.A