

User Manual

Original Instructions



GuardShield Safety Light Curtain

Catalog Numbers 450L-B4FNxYD, 450L-B4HNxYD, 450L-E4FLxYD, 450L-E4HLxYD



Important User Information

Read this document and the documents listed in the additional resources section about installation, configuration, and operation of this equipment before you install, configure, operate, or maintain this product. Users are required to familiarize themselves with installation and wiring instructions in addition to requirements of all applicable codes, laws, and standards.

Activities including installation, adjustments, putting into service, use, assembly, disassembly, and maintenance are required to be carried out by suitably trained personnel in accordance with applicable code of practice.

If this equipment is used in a manner not specified by the manufacturer, the protection provided by the equipment may be impaired.

In no event will Rockwell Automation, Inc. be responsible or liable for indirect or consequential damages resulting from the use or application of this equipment.

The examples and diagrams in this manual are included solely for illustrative purposes. Because of the many variables and requirements associated with any particular installation, Rockwell Automation, Inc. cannot assume responsibility or liability for actual use based on the examples and diagrams.

No patent liability is assumed by Rockwell Automation, Inc. with respect to use of information, circuits, equipment, or software described in this manual.

Reproduction of the contents of this manual, in whole or in part, without written permission of Rockwell Automation, Inc., is prohibited.

Throughout this manual, when necessary, we use notes to make you aware of safety considerations.



WARNING: Identifies information about practices or circumstances that can cause an explosion in a hazardous environment, which may lead to personal injury or death, property damage, or economic loss.



ATTENTION: Identifies information about practices or circumstances that can lead to personal injury or death, property damage, or economic loss. Attentions help you identify a hazard, avoid a hazard, and recognize the consequence.

IMPORTANT

Identifies information that is critical for successful application and understanding of the product.

Labels may also be on or inside the equipment to provide specific precautions.



SHOCK HAZARD: Labels may be on or inside the equipment, for example, a drive or motor, to alert people that dangerous voltage may be present.



BURN HAZARD: Labels may be on or inside the equipment, for example, a drive or motor, to alert people that surfaces may reach dangerous temperatures.



ARC FLASH HAZARD: Labels may be on or inside the equipment, for example, a motor control center, to alert people to potential Arc Flash. Arc Flash will cause severe injury or death. Wear proper Personal Protective Equipment (PPE). Follow ALL Regulatory requirements for safe work practices and for Personal Protective Equipment (PPE).

	Preface	
	Who Would Use This Manual	9
	Summary of Changes	9
	Terminology	10
	Additional Resources	10
	Chapter 1	
Product Overview	General Description	11
	Package Contents	14
	Firmware Revisions	15
	Chapter 2	
Safety Concepts	Safety Standards Applied to GuardShield	17
	Functional Safety Data	17
	Safety Certification	18
	Installation Requirements	19
	Possible Misuse	20
	Chapter 3	
Operation	Principle of Operation	21
	Laser Alignment	24
	Chapter 4	
Safety Function	Start Modes	27
	Automatic (Re) Start (Default)	27
	Manual (Re) Start	28
	Manual Cold Start	28
	Manual (Re) Start with Off Function	28
	Power Cycle	29
	External Device Monitoring (EDM)	29
	Low Operating Range	29
	Beam Coding	30
	Blanking and Reduced Resolution	30
	Teach-in Fixed Blanking	31
	Teach-in Blanking Procedure	33
	Configuration Process	34
	Reduced Resolution (Object Number Limited)	35
	Resolution with Blanking	37

Muting..... 38
 Muting Lamp 39
 Muting Sensors..... 39
 Mute Dependent Override Function (MDO)..... 40
 Two-sensor T-type Muting..... 41
 Two-sensor L-type Muting 43
 Two-sensor L-type Muting with Enable 44
 Four-sensor Muting 46
 Cascading 48
 Cascading and Blanking..... 52
 Response Time..... 52
 Standard Response Time, T_s 52
 Advanced Feature Response Time, T_a 54
 Multiple Scan 56
 Short Interruption Time..... 56
 Cascading Response Time, T_c 56
 Connected Components Workbench Response Time 57
 Product Labels 58

Chapter 5

System Configuration

Receiver Plug-in DIP Switch Settings 60
 450L-APR-ON-5 Connection Plug-in..... 61
 450L-APR-ED-8 Connection Plug-in..... 61
 450L-APR-BL-5 Connection Plug-in 62
 450L-APR-MU-8 Connection Plug-in..... 62
 450L-APR-UN-8 Connection Plug-in 64
 Confirmation of a New System Configuration..... 64
 Confirmation..... 65
 Confirmation Procedure..... 65

Chapter 6

Installation and Wiring

Determine the Safety Distance 68
 U.S. Safety Distance Formula..... 68
 OSHA Safety Distance Formula 69
 ANSI Safety Distance Formula 70
 European Safety Distance Formula..... 71
 Minimum Distance from Reflective Surfaces..... 73
 Mirrors..... 74
 Install and Mount 75
 Correct Installation..... 77
 Incorrect Installation 78
 Mount Multiple 450L GuardShield Safety Light Curtains 79

Mounting Brackets	82
Standard Top/Bottom Mounting Kit	82
Side Mounting Bracket	84
Shock Mounting Kit	86
Replacement Mounting Kit	86
Electrical Installation	88
Plug-ins	88
Plug-in Installation	89
Transmitter Plug-in	90
Receiver Plug-in	91
Cascading	93
Transmitter Cable Connection	94
Receiver Cable Connection	96
Cascading Cable Connection	97
Power Supply	98
Grounding	98
External Device Monitoring (EDM) Connection	99
Restart Button	100
OSSD Output	100
OSSD Signal Processing	100
OSSD Restart Time (from OFF to ON)	101
Test Pulses	101
Typical Wiring Diagram	102
Direct to Contactors	102
Guardmaster SI Safety Relay	103
T-connector	104
GuardLink Tap Connections	105
1732 ArmorBlock Connections	106
Two-sensor Muting with Muting Plug-in	109
Four-sensor Muting with Muting Plug-in	110

Chapter 7

Status Indicators and Troubleshooting

Status Indicators	113
System Status Indicators	113
Status Indicator for Normal Operation	115
Optical Push Button	116
Troubleshoot	116
Status Indicator Error Display	116
Optical Interface Device (OID)	120
Troubleshoot with Connected Component Workbench Software	121

Safety Instructions

Chapter 8

Maintenance..... 123
 Regular Inspection 123
 Clean Optic Front Window..... 126
 Disposal 126
 Product Labels 126
 Stick Labels 126
 Plug-in Label..... 127

**Connected Components
 Workbench Software**

Chapter 9

Overview 129
 Multiple Subconfigurations 129
 Start a New Project 130
 Workbench Layout..... 134
 Project Organizer 135
 General..... 135
 Hardware 136
 DIP Switch 136
 USB Status 137
 Sub-configurations 137
 General Settings..... 138
 GPIO 140
 Diagnose Window 144
 Export..... 144
 Reset 144
 Lock..... 145
 Mode..... 145
 Teach 146
 Laser 146
 Beam Status 146
 Two-sensor Muting Schematic Example..... 148
 Muting Type and Settings 149
 GPIO Selection and Settings 151
 Four-sensor Muting Schematic Example 152
 Hardware 153
 Muting Type and Settings..... 153
 GPIO Selection and Settings 155
 Blanking Overview 158
 Lens Identification 158
 Zones 159
 Configuration Options 161
 Fixed Blanking..... 161
 Settings..... 161
 Fixed Blanking Rules 163
 Teach Blanking Zones 163
 Process Details 164

Floating Blanking	170
Settings	170
Floating Blanking Rules	171
Object Height	171
Reduced Resolution Blanking	173
Settings	173
Reduced Resolution Blanking Rules	174
Object Height	174
Download and Upload Configurations	175
Change Hardware	179
Share Your Project (Export/Import)	181
Export Project to a Connected Components Workbench Software Archive	181
Import Project from a Connected Components Workbench Software Archive	183
Export Device to Zip File	184
Import a Zip File	185
Update Firmware	186

Appendix A

Specifications

Safety Ratings	189
Operating Characteristics	189
Inputs Receiver Plug-in, Cascading Plug-in, and Universal Plug-in	190
Safety Outputs (OSSDs): Receiver Plug-in	191
Status Outputs	191
Environmental and General Protection	191
Electrical Protection	191
General	192
Certifications	193
Compliance to European Union Directives	193
Approximate Dimensions	193
Product Selection	195
Sticks	195
Plug-ins	196
Optional Accessories	197
Corner Mirror	198
Mounting Columns	200
Alignment Tool and Bracket	202
Weld Shields	202
Cables	203

Typical Installations	Appendix B	
	Safety Light Curtain Mounted Vertically.....	205
	Safety Light Curtain Mounted Horizontally.....	205
	Fixed Blanking Application	206
	Cascading Application.....	207
	Index	209

This manual is a reference guide for the 450L-B and 450L-E GuardShield™ Safety Light Curtains. It describes the procedures to install, wire, and troubleshoot the safety light curtains.

Who Would Use This Manual

Use this manual if you design, install, program, or troubleshoot systems that use the 450L GuardShield safety light curtain.

You must have a basic understanding of electrical circuitry and familiarity with safety-related systems. If you do not, obtain the proper training before using this product.

Qualified personnel must conduct all inspections. A qualified person must perform these tasks:

- Undergone the appropriate technical training
- The responsible machine operator has instructed personnel in the operation of the machine and the current safety guidelines.
- Has read and has access to the user manual.

Qualified personnel must install the light curtain and only use it on that specific machine.

Summary of Changes

Topic	Page
Updated Standard Response Time, Ts section.	52
Added Multiple Scan and Short Interruption Time sections.	56
Updated Connected Components Workbench Response Time section.	57
Updated Table 51 .	111
Updated Table 56 .	139

Terminology

Abbreviation	Definition
DoC	Declaration of Conformity
EDM	External Device Monitoring
ESPE	Electro-sensitive protective equipment
FSD	Final switching device
NC	Not connected
NEC	National Electric Code (U.S.)
OID	Optical Interface Device
OSSD	Output Signal Switching Device: Typically designates a pair of solid-state signals that are pulled up to the DC source supply. The signals are tested for short circuits to the DC power supply, short circuits to the DC common, and short circuits between the two signals.
PL	Performance Level
POC	Point of Operation Control
QD	Quick disconnect
RB	Restart button
Rx	Receiver
SIL	Safety integrity level
Tx	Transmitter

Additional Resources

These documents contain additional information concerning related products from Rockwell Automation.

Resource	Description
GuardShield 450L Safety Light Curtain Package Content, publication 450L-PC001	Provides installation information for 450L replacement units.
GuardShield 450L Side Mounting Kit, publication 450L-IN002	Provides installation information for side mount brackets.
GuardShield 450L Weld Shield Kit, publication 450L-IN001	Provides installation information for weld shield kits.
GuardShield 450L Optical Interface Device, publication 450L-IN003	Provides installation information for optical interface device.
Safety Book 5, Safety-related Control Systems for Machinery, publication SAFEBK-RM002	Provides principles, standards, and implementation of safety-related control systems for machinery.
Industrial Automation Wiring and Grounding Guidelines, publication 1770-4.1	Provides general guidelines for installing a Rockwell Automation® industrial system.
Product Certifications website: rok.auto/certifications	Provides declarations of conformity, certificates, and other certification details.

You can view or download publications at rok.auto/literature.

Product Overview

General Description

The 450L GuardShield™ safety light curtain family consists of general-purpose presence sensing devices that are designed for use on hazardous machinery for Point of Operation Control (POC). The product family is certified as Type 4 electro-sensitive protective equipment (ESPE) (as defined by EN 61496-1 and IEC 61496-2). This certification allows this product to be used in applications that require PLe category 4 according to EN ISO 13849-1.

The 450L safety light curtains are offered in multiple lengths from 150...1950 mm (5.9...76.77 in.) in increments of 150 mm (5.9 in.). Each length is available in finger (14 mm [0.56 in.]) or hand (30 mm [1.19 in.]) resolution with a basic set of sensing functions.

The 450L safety light curtain family consists of two product lines:

- 450L-B (Basic)
- 450L-E (Enhanced)

Whereas the 450L-B version is suitable for basic ON/OFF applications, the 450L-E version provides enhanced features for more sophisticated applications. [Table 1](#) provides an overview of the differences between the two product versions:

Table 1 - Differences between 450L-B and 450L-E Safety Light Curtain Systems

Description	450L-B	450L-E
Alignment aid	Two zone indicator light-emitting diode (LED)	Integrated laser alignment and two zone indicator LED
Operating range finger resolution, max	4 m (13.12 ft)	9.0 m (29.53 ft)
Operating range hand resolution, max	7.0 m (22.97 ft)	16.2 m (53.15 ft)
Functionality	Start modes External device monitoring (EDM) Operating range	Start modes EDM Operating range Beam coding Blanking Muting Cascading

The two 450L versions have no differences in cross section, protective heights and resolutions, sealing, operating and storage temperature, and length passive zones at the ends of each stick and mounting options.

What makes each GuardShield light curtain system unique from other safety light curtain transmitter and receiver solutions is that it consists of two identical transceiver sticks. These safety light curtains are not designated as transmitter or receiver right out-of-the-box. The configuration of a stick as a transmitter or a receiver is done by inserting either:

- A dedicated transmitter or receiver plug-in into the transceiver sticks
- A universal plug-in module in each transceiver stick, which allows a selection for the transmitter or the receiver function by wiring.

The GuardShield safety light curtains are designed as a two box system, which has no inactive sensing area or dead/blind zones at the top and bottom of each stick. This design allows a perfect and easy integration in individual machine designs.

Selectable function depends on the installed receiver plug-in, which can be inserted in a GuardShield safety light curtain transceiver stick. Different operation modes can be selected via the DIP switch on the receiver plug-ins.

Depending on the type of plug-in that is installed in a GuardShield stick, the system offers:

- Connectivity to ArmorBlock® Guard I/O™ (5-pin M12 QD) for network connectivity providing CIP Safety™ over DeviceNet™ or EtherNet/IP™.
- Auto or manual start modes
- External device monitoring (EDM)
- Beam coding
- Muting, blanking, and cascading capabilities (only for the 450L-E safety light curtain)



LASER LIGHT CLASS 2 HAZARD: Do not stare into the beam. The 450L-E light curtains are equipped with an integrated laser alignment help option (see [Laser Alignment on page 24](#)).

Recognized technical regulations and ISO 9001 quality assurance procedures are carefully applied during the development and production of Allen-Bradley® GuardShield products.

IMPORTANT 450L-B transceiver stick cannot be operated with a 450L-E transceiver stick

Figure 1 - Compatibility Limitations

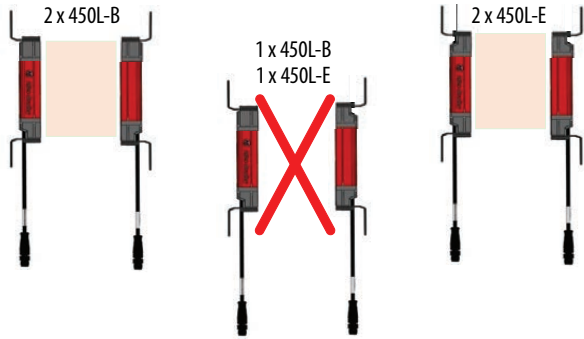

Figure 2 - Assembly Overview for the 450L-B Safety Light Curtain System

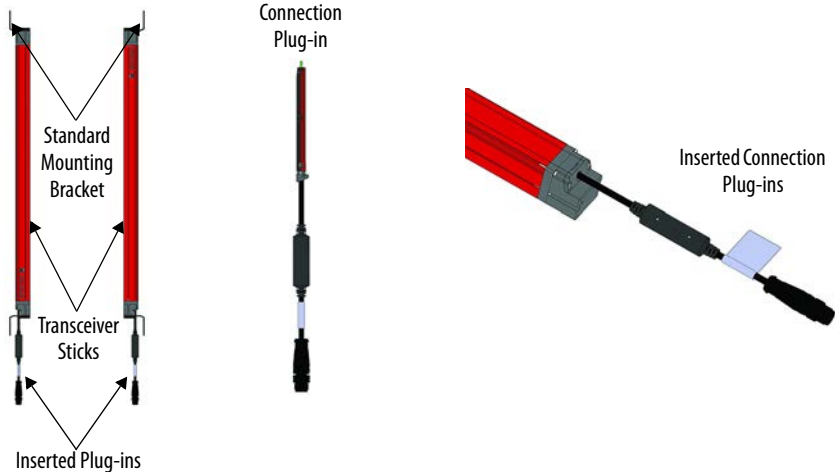
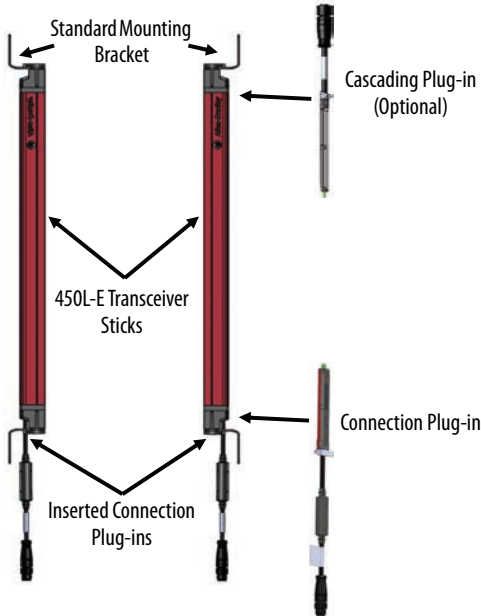

Figure 3 - Assembly Overview for the 450L-E Safety Light Curtain System



A 450L-E safety light curtain also provides the option to insert a cascading plug-in into the opposite stick end at the gray slot cover (see [Cascading on page 48](#) and [Figure 5 on page 14](#)).

Package Contents

A GuardShield safety light curtain is normally shipped as an individual component (single transceiver). A functional system includes four individual boxes.

Table 2 - List for a Complete System

Item	Required Quantity	Description	Remark
1	2	450L GuardShield transceiver stick	Each box contains: <ul style="list-style-type: none"> • One stick • Mounting kit (top and bottom) • Test rod • Short instruction manual
2	1	Transmitter plug-in	150 mm (5.9 in.) pigtail with M12 QD connector (male)
3	1	Receiver plug-in	150 mm (5.9 in.) pigtail with M12 QD connector (male)

Figure 4 - Contents of 450L Transceiver Stick Box



Figure 5 - Plug-ins

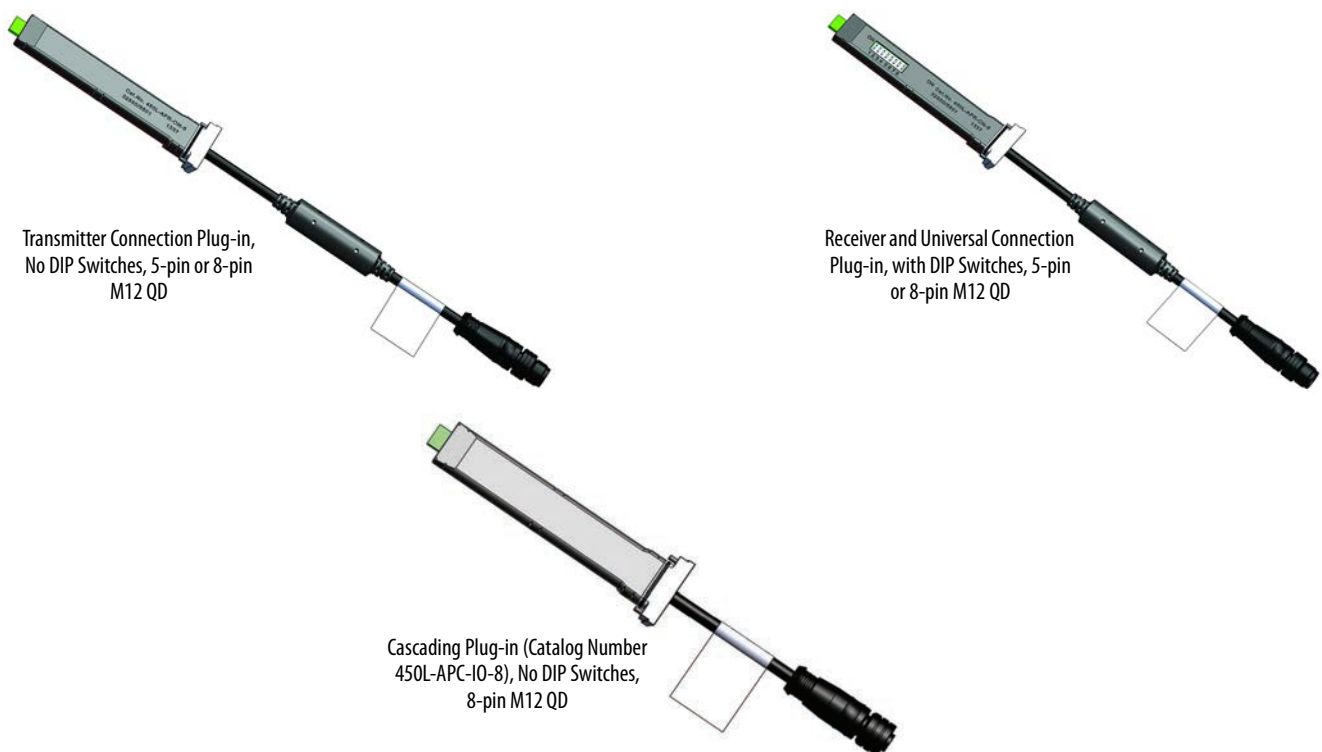

Firmware Revisions

The feature list of the 450L-B and of the 450L-E light curtains continuously expands. [Table 3](#) lists the components that have firmware that can be upgraded using ControlFLASH™ software.

Table 3 - Firmware Revisions of 450L Safety Light Curtains

Family	Version	Description
450L-B	1.001	Initial Release. Does not support Connected Components Workbench™ software.
	2.001	Support Connected Components Workbench software diagnosis and connection with T-connector. Can be used as the last pair of cascading.
	3.001	Same feature as 2.001 but 4K security key.
	4.001	Support Connected Components Workbench software diagnosis.
	5.001	Same feature as 4.001.
450L-E	2.001	Initial release and supports Connected Components Workbench software diagnosis. Supports Safety Override, Dry Contact Switch, and E-stop. Cascaded light curtains Tx side cannot use universal plug-in, the host pairs can still use universal plug-in.
	3.001	Same feature as 2.001.
	4.001	Support Connected Components Workbench software diagnosis and configuration. Not backward compatible with 450L-APC-IO-8.
	5.001	Same feature as 4.001.
450L-APC-IO-8	1.001	Initial Release.
	2.001	Allows 450L-APU-UN-8 to be used as a transmitter in a cascaded stick.
	3.001	Same feature as 2.001.
	4.001	Backward compatible with LC.
	5.001	Same feature as 4.001.
450L-OID	1.001	Initial Release, does not support 450L-E. If you get a message, "The connection to the 450L safety light curtain will be terminated because of repeatedly mismatched checksum calculation errors" then upgrade the FW to 1.002 or later.
	1.002	Support LC Diagnosis and FW update.
	3.001	Backward compatible with LC. It supports LC FW 3.001 diagnosis, FW update, reset, confirm and blanking teach command. Added 4K key certificate support.
	4.001	Backward compatible with LC. Example: 2.001, 3.001, 4.001 LC can work with 5.001 OID, but 3.001, 4.001 OID cannot work with 5.001 LC.
	5.001	Backward compatible with LC.

For maintenance reasons, a 450L stick with an old FW version can be operated with a 450L stick with newer FW.

Notes:

Safety Concepts

This section describes the safety Performance Level concept and explains how the 450L safety light curtains meet the requirements for SIL 3 and PLe for Category 4 architectures.

Safety Standards Applied to GuardShield

The 450L safety light curtain satisfies applicable requirements in the following standards that are related to functional and machinery assembly:

- IEC 61496-1/-2 (Type 4)
- IEC 61508 (SIL 3)
- IEC 62061 (SIL CL 3)
- EN/ISO 13849-1 (Performance Level e (PLe), Category 4)
- UL 508

The 450L-E safety light curtain satisfies applicable requirements that are provided in IEC 60825-1 for the integrated laser alignment aid (see [Laser Alignment on page 24](#)).

Published dates of the individual standards are given in the Declaration of Conformity (see [rok.auto/certifications](#)).

Functional Safety Data

The functional safety data are listed in [Table 70 on page 189](#). These values refer to the longest light curtain system length (1950 mm [76.77 in.]) with the smallest resolution (14 mm[0.55 in.]).

For cascaded 450L-E safety light curtain applications, the final PFH value of the complete system is the sum of the individual PFH values of each pair plus the sum of the PFH values of the cascading plug-in.

The following example ([Figure 6 on page 18](#)) shows the calculation of the PFH of a cascaded system with 450L-E safety light curtain and two cascading plug-ins.

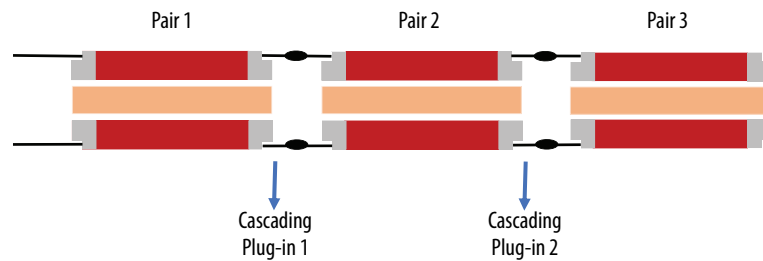
Figure 6 - Example and PFH Calculation of Cascaded Systems

$$\text{PFH (total)} = 3x \text{ PFH (450L pair)} + 2x \text{ PFH (cascading plug-in)}$$

IMPORTANT For 450L-E safety light curtains, if cascading the PFH of each cascade and each cascading plug-in must be considered.

Safety Certification

Each 450L safety light curtain is a Type 4 ESPE as defined by IEC 61496-1 and CLC/TS 61496-2. The safety light curtains are allowed for use with controls in compliance with these certifications.

- PLe (in a Category 4 architecture) in compliance with EN ISO 13849
- SIL CL3 in accordance with EN 62061
- SIL 3 in accordance with IEC 61508

Safety requirements are based on the standards applicable at the time of certification with a proof test interval of 20 years.

The device is suitable for the following:

- Point of Operation Control (POC) finger- and hand-detection
- Hazardous area protection
- Access protection

Access to the hazardous point must be allowed only through the protective field. The machine/system is not allowed to start as long as personnel are within the hazardous area (see [Correct Installation on page 77](#)).

Depending on the application, mechanical protective devices are potentially required in addition to the safety light curtain.

TÜV Rheinland has approved the 450L GuardShield™ safety light curtains for use in safety-related applications where Performance Level (PL) up to e and safety integrity level up to SIL 3 are required.

TÜV Rheinland confirmed that the integrated laser alignment aid in 450L-E GuardShield safety light curtains conforms to the classification of laser class two according to IEC 60825-1.

IMPORTANT Observe the following directives, rules, and regulations to help conform to proper and safe use of the GuardShield safety light curtain.

The national/international rules and regulations apply to the installation, use, and periodic technical inspections of the safety light curtain, in particular:

- Machine Directive
- Low Voltage Directive
- Equipment Usage Directive
- Work safety regulations/safety rules
- Other relevant health and safety regulations

Published dates of the individual standards are given in the Declaration of Conformity (see [Compliance to European Union Directives on page 193](#)).

Manufacturers and users of the machine with which the safety light curtain is used are responsible for obtaining and observing all applicable safety regulations and rules:

- The notices, in particular the test regulations of this user manual (for example, on use, mounting, installation, or integration into the existing machine controller) must be observed.
- Specialist personnel or specially qualified and authorized personnel implement the tests and must record and document that the tests can be reconstructed and retraced at any time.
- This user manual must be made available to the user of the machine where the GuardShield safety light curtain is installed. The machine operator is instructed in the use of the device by specialist personnel.

Installation Requirements

The GuardShield safety light curtains must be installed in accordance with applicable regulations and standards.

While the GuardShield safety light curtains can be used for SIL 3, PLe, and Category 4 applications, the installer must comply with the minimum (safe) distance requirements. For example, according to EN ISO 13855, if installed in the European Union.

The installed system, including the safety control system and the means by which the machine stops, must achieve the needed safety Performance Level. The GuardShield safety light curtains are only one element in the safety system. Additional guidance can be found in publication [SAFE BK-RM002](#).

Possible Misuse

GuardShield safety light curtains are used as electro-sensitive protective equipment in the sense of the Machinery Directive. These devices are only used in applications such as:

- POC device
- Access control device
- Hazardous area control device



WARNING: The following applications and/or environmental conditions can lead to misuse and potentially cause severe injuries or death (for more information see IEC 62046).

- Machines, which eject materials, swarf, or component parts
- Risk of injury from thermal or other radiation
- Unacceptable noise levels
- Transparent objects are detected
- An environment, which exceeds the specification, limits provided in [Specifications on page 189](#).

Some but not all possible limits are electrostatic discharge, radio frequency interference, vibration/shock, ambient light, pollution, temperature, humidity.

Without additional measures (IEC 62998), GuardShield safety light curtains are not designed to be used for the following applications:

- Outdoors
- Under water
- Explosive atmospheres
- Altitudes over 3000 m (1.86 miles) above sea level
- With enhanced ionizing or radar radiation.

Operation

This chapter provides information on the special features and properties of the 450L safety light curtain. It also describes the structure and functions of the unit, particularly the different operating modes.

Principle of Operation

A functional GuardShield™ safety light curtain system includes:

- Two transceiver sticks (same length and resolution)
- A transmitter plug-in
- A receiver plug-in

The type of plug-in defines which way a transceiver stick performs: as a transmitter stick or as a receiver stick. The maximum distance between transmitter and receiver sticks is referred to as the operating distance or operating range (see [Figure 7](#)). The GuardShield systems also require a minimum operating distance. If a system is installed below this distance, the safety outputs do not switch to on. The maximum operating range is reduced by using deflector mirrors and/or weld shields.

The protective field height of a GuardShield safety light curtain is equal to the total length of the stick.

Figure 7 - Principle Operation of a 450L Safety Light Curtain System

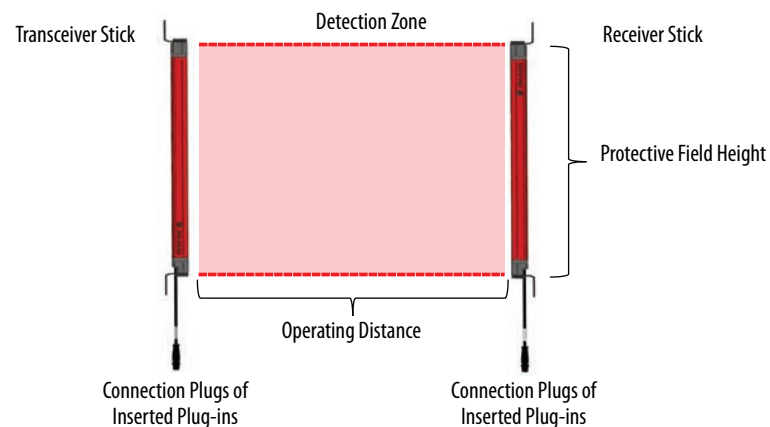

A short time after power-up and alignment of a system, nonvisible infrared light beams build up a plane of detection (protective field) between the two sticks. The axis of the detection zone is vertical to the front window of the light curtain sticks.

Sequential pulses of infrared light are sent between the two sticks. The beam status analysis and the processing are done by the receiver. When one or more beams are interrupted, the two output signal switching devices (OSSDs) turn off. A safety control, safety relay, or safety contactor evaluates the signal to stop the dangerous state of the machine.

The first or last beam near the end of the sticks optically synchronizes the timing of the emission and reception of infrared light pulses. These beams are referred to as the synchronization beams. Because the GuardShield systems are optically synchronized, no electrical connection is required between the transmitter and receiver sticks.

The unique design of the GuardShield platform allows every 450L transceiver to transmit and receives infrared light. In contrast to the classical architecture of common pure transmitter and receiver light curtain systems, GuardShield transceiver sticks exchange protective field information via infrared light. So infrared light is not only sent from a transceiver working as a transmitter to a receiver. As indicated in [Figure 8](#), a transceiver stick configured as a receiver transmits some infrared light to the transmitter. The dashed lines in [Figure 8](#) indicate the synchronization beams.

Figure 8 - Schematic Display of Beam Center Lines

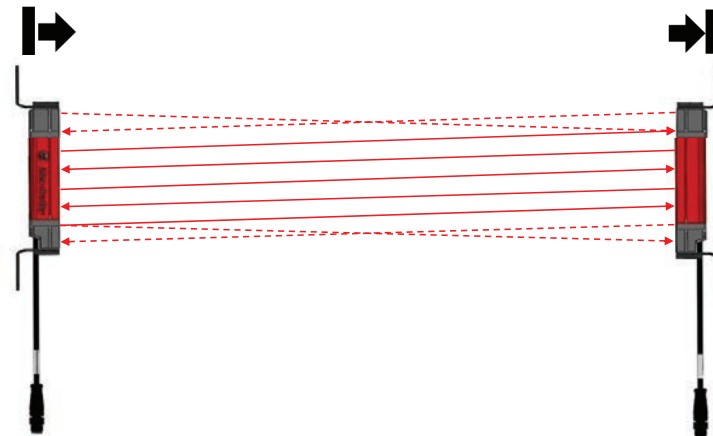

The slightly slanted beams and the maximum operating angle of the IR light require that a transmitter and a receiver stick are installed beyond a minimum operating distance. A 450L system is safe against manipulation because a transmitter stick cannot be installed directly in front of a receiver stick.

A GuardShield transceiver, which acts as a receiver, has two OSSD safety outputs and depending on the plug-in that is used, one additional non-safety auxiliary output. When the GuardShield transmitter and receiver are properly powered, aligned, not obstructed, and the start/restart mode has been correctly initiated, both the OSSDs and the auxiliary output are ON (output voltage = +24V DC). The two safety OSSDs are cross-fault monitored and short-circuit protected.



ATTENTION: The Auxiliary output is only a status output for diagnosis purposes to connect, for example, an indicator lamp. Do not use this output for safety purposes.

Interruption of the sensing field causes the receiver OSSD to switch OFF (sourced current 0 mA DC, source voltage 0V DC).

For automatic restart: no obstruction of the GuardShield sensing field causes the two safety outputs (OSSD) to switch to the active high (On) state (+24V DC).

With the appropriate resolution, the GuardShield safety light curtain system provides finger or hand protection. The resolution corresponds to the diameter of the provided test rod belonging to the safety light curtain. The test rod is reliably detected when positioned in the protective field. The resolution of a GuardShield stick is printed on the product label.



ATTENTION: The resolution of a 450L-E safety light curtain system that is configured with blanking, changes depending on the configuration (see [Blanking and Reduced Resolution on page 30](#)). Any change in the resolution must be considered in the safety distance calculation (see [Determine the Safety Distance on page 68](#)) and in the installation.

[Figure 9](#) shows the active lenses for the two resolutions of the safety light curtain.

Figure 9 - Active Lenses for Different Resolutions

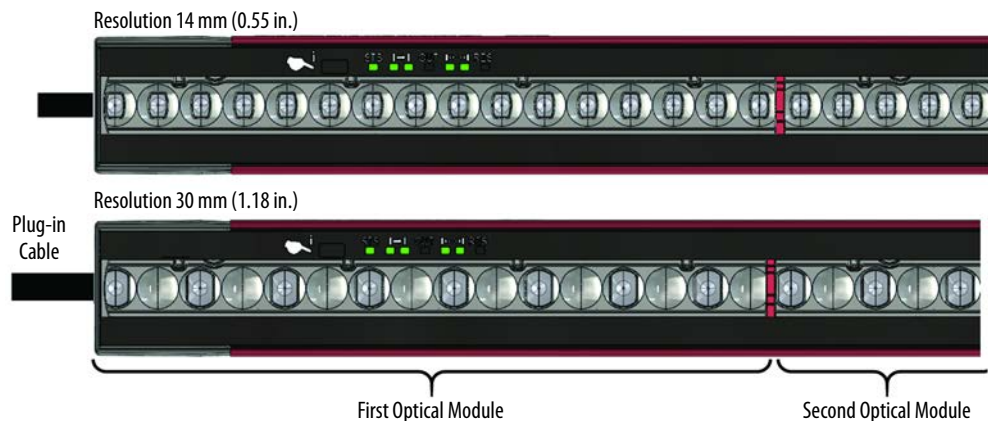

Resolution [mm (in.)]	Lens Number Per Module															
	1	2	3	4	5	6	7	8	9	10	11	12	13	14	15	16
14 (0.56)	X	X	X	X	X	X	X	X	X	X	X	X	X	X	X	X
30 (1.19)	X	—	X	—	X	—	X	—	X	—	X	—	X	—	X	—

IMPORTANT The gap (approximately 1.5 mm (0.05 in.) between adjacent modules, which are red (indicated in [Figure 9 on page 23](#) for hand and finger resolution), has no impact on resolution.

Laser Alignment

All 450L-E transceiver sticks have an integrated laser alignment system (ILAS). The laser works with visible light, which makes the alignment of a 450L-E safety light curtain system much easier.



LASER LIGHT HAZARD: Do not stare into the beam. Each 450L-E safety light curtain has a built in laser alignment system.

LASER CLASS 2 (IEC 60825-1).

Conforms to 21 CFR 1040.10.

The ILAS can be switched on and off by simply placing a finger on the optical push button, which is located close to the hand symbol on the front window (see [Figure 31 on page 65](#)). As soon as the laser is activated, several red laser beams are transmitted (see [Figure 10 on page 25](#)) from a source close to the optical push button.

[Figure 10 on page 25](#) shows the principle operation of the ILAS. The brightest beam is transmitted perpendicular to the front window, which is also parallel to the infrared light of the stick. The brightest beam has to be positioned at the opposite stick at the same level as indicated with distance A in [Figure 10 on page 25](#). The other slanted laser beams must also be targeted between the optics center and the housing of the opposite stick on the front window. The quantity of slanted beams on the opposite stick depends on the installation distance. To find optimum alignment for a 450L-E safety light curtain system, the laser of each stick must be aligned to the opposite stick.

IMPORTANT A white background (for example, paper) makes it easy to identify the brightest beam.

Figure 10 - Principal Function of the Integrated Laser Alignment System

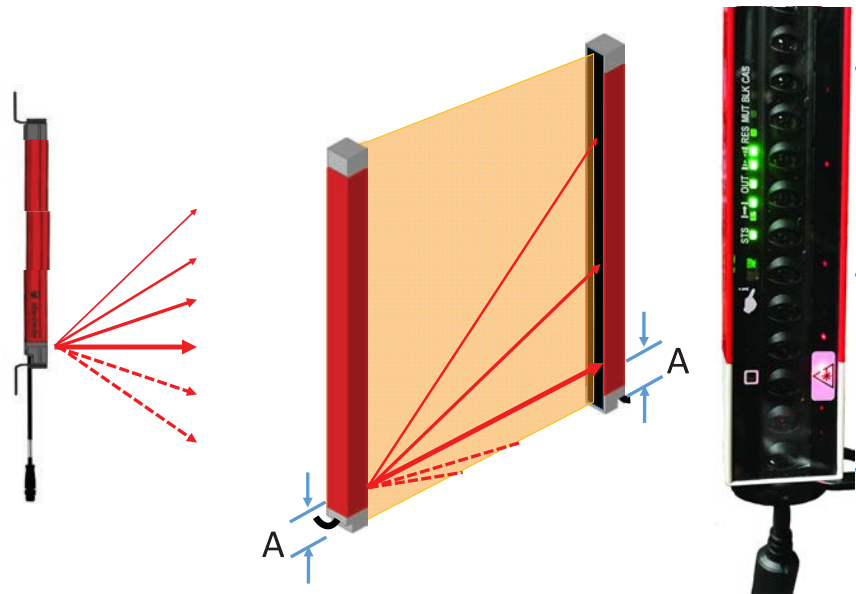

IMPORTANT [Figure 10](#) indicates additional visible laser beams (dotted) to the connection end of the stick. Such beams do not have to be considered for the alignment procedure.

In a cascading system, each integrated laser system works independently and can be switched on or off individually.

The 450L-B sticks have no integrated laser alignment system. For those sticks, an optional external alignment aid (see [Figure 184 on page 202](#)) with a mounting clamp ([Figure 185 on page 202](#)) is available.

Notes:

Safety Function

The 450L safety light curtain offers a range of functions that are integral to the safety system. The functions are selected through DIP switch settings on the receiver plug-in.

A confirmation of a new configuration at the receiver stick is only required if the stick was previously operated with another DIP switch setting or with another plug-in type (see [Confirmation of a New System Configuration on page 64](#)).

A confirmation of a new configuration at the transmitter stick is only required if the stick was previously operated with another beam coding (see [Beam Coding on page 30](#)).



ATTENTION: The protective system must be tested for proper operation after each change to the configuration.

Some safety functions can only be selected with the 450L-E safety light curtain. A complete overview is provided in [Table 1 on page 11](#).

Start Modes

The four start modes are configurable for both GuardShield™ product lines (450L-B and 450L-E). Manual reset options are only provided for eight-pin connection plug-ins. 5-pin plug-ins have only the automatic (re)start option.

IMPORTANT The Start button can also be used to power cycle a receiver stick if there is a lockout. A receiver stick performs the power off/on cycle if the input of the Start button is activated for a minimum of 10 seconds, but not longer than 20 seconds. This function is also available if automatic start is configured for receiver plug-ins, which allow a start mode selection, see [Restart Button on page 100](#) for additional installation hints.

Automatic (Re) Start (Default)

When in the automatic start mode of operation (also known as Guard only mode), the light curtain operates as an on/off device. The OSSD outputs switch off, according to an interruption of the sensing field, and automatically switch on when the protective field is cleared. The GuardShield pairs that are equipped with bottom plug-ins and factory-default DIP switch settings work in Automatic Start mode.

Manual (Re) Start

The manual start mode of operation (also known as restart interlock) helps prevent the OSSD outputs from switching ON automatically after interruption and clearance of the protective field or power-up. A manual start of the GuardShield system is required. Start up of the system is accomplished through a momentary N.O. push button or keyswitch. An orange status indicator (RES) on the 450L receiver indicates that the system is ready for manual restart.

Manual start is not available in GuardShield light curtains with ArmorBlock® Guard I/O™ connectivity (5-pin bottom plug-in).

The Start button must be pressed a minimum of 50 ms. The maximum time for accepting the start pulse is 5 seconds. If the pulse width is too short or too long, the start function is not executed. The start reacts on the falling edge of the start pulse.

Manual Cold Start

The manual cold start (also known as start interlock) helps prevent the OSSD outputs from switching ON after power-up of the system, even when the protective field is unobstructed. After each power-up, a one-time manual start of the system is required for the GuardShield system OSSD outputs to enter the ON state.

The Start button must be pressed a minimum of 50 ms. The maximum time for accepting the start pulse is 5 seconds. If the pulse width is too short or too long, the start function is not executed. The start reacts on the falling edge of the start pulse.

After the initial power-up and manual start has taken place, the light curtain system operates in the automatic start mode. Activation of this mode of operation and selection of the starting method is through DIP switch settings. An orange status indicator (RES) on the GuardShield receiver indicates that the system is ready to be manually started.

Manual cold start is not available in GuardShield light curtains with ArmorBlock Guard I/O connectivity (5-pin bottom plug-in).

Manual (Re) Start with Off Function

This start mode allows the OSSD outputs to be switched on manually (if the protection field is unobstructed) and switched off manually. The OSSD outputs can be manually turned OFF by use of the same momentary N.O. push button or keyswitch that is used for manual start. When the OSSDs switched off because of an interruption of the protective field, the protective field must be cleared and the push button or key must be operated again.

Configuration and activation of this mode of operation is through DIP switch settings. An orange status indicator (RES) on the GuardShield receiver indicates that the system is ready to be manually started.

Power Cycle

When a GuardShield receiver goes into a lockout state, power must be cycled after the cause of the lockout has been corrected. The Start input signal and the Optical Push Button, can be used to cycle power. Press and hold the Start button or the optical push button between 10...20 seconds. The power cycle function is available for all start modes, including automatic.

External Device Monitoring (EDM)

External device monitoring is configurable for both GuardShield product lines.

EDM is an input signal to the GuardShield receiver. It is used to monitor the state of the primary control contactors of the guarded machinery or other final switching devices (FSD). The EDM input is looking for a change of state of the contactors/FSD within a time period of 300 ms before the system faults. A fault causes the safety light curtain to enter a lockout condition (OSSDs OFF and error indication). One reason to select the EDM function can be the detection of an unsafe condition such as welded contacts in one of the FSD. Activation of this mode of operation is through the DIP switch setting on the GuardShield receiver plug-in or by enabling this function in the General settings in Connected Components Workbench™ software.

EDM is not available in GuardShield safety light curtains with ArmorBlock Guard I/O connectivity (M12 5-pin QD plug-in).

Low Operating Range

Low operating range is designed to minimize the influence of neighboring optical sensors on the 450L light curtain performance. This feature is available on both the 450L-B and the 450L-E. Low operating range narrows the operating distance. The maximum operating distance is reduced, and the minimum operating distance is increased.

Low operating range is configured by enabling the appropriate DIP switch on the receiver plug-in, or by enabling the function in the General settings in Connected Components Workbench software. The default setting is disabled.

The regional intensity status indicators on the transmitter and receiver indicate the activation of the low range function.

Beam Coding

Beam coding is only configurable for 450L-E safety light curtain.

If several safety light curtains are operating close to one another, it is possible that the transmitter infrared light from one 450L-E safety light curtain system is seen by another 450L-E safety light curtain receiver (optical cross talk, see [Mount Multiple 450L GuardShield Safety Light Curtains on page 79](#)). This situation can cause an unsafe installation. To reduce the probability of this situation, the 450L-E safety light curtain is able to exchange the addresses of the sticks that are paired and to generate different transmitter pulse pattern, which is referred to as beam coding.

Two settings are available in the 450L-E safety light curtain — non-coded and coded. The factory default is non-coded.

If beam coding is selected, a teach-in procedure at the transmitter and the corresponding receiver must be performed once for pairing the two sticks.

The pairing procedure for systems out of the box is only required at the Rx and at the Tx transceiver stick when the beam coding function was selected. It must only be done once after the first power-up.

Set beam coding with the appropriate DIP switch on the plug-in of the receiver (Rx) stick and power the system up. A confirmation of the configuration can be required first at the receiver (Rx), if the Rx stick was operated before. In this case, perform first the configuration confirmation at the Rx and then the confirmation for the pairing.

When the STS status indicator at the transmitter is blinking red/green, it indicates that the Tx stick beam coding must be paired with the Rx stick. Follow the procedure that is described in [Confirmation of a New System Configuration on page 64](#).



ATTENTION: If several systems are in the area, only one single transmitter is allowed to be paired with a given receiver. Make sure that any other adjacent installed safety light curtain system is switched off during the pairing process.

The beam coding settings do have an impact on the response time (see [Response Time on page 52](#)).

Blanking and Reduced Resolution

Blanking and reduced resolution is only configurable for 450L-E safety light curtain.

Blanking and reduced resolutions are typically used to allow objects wider than the optical resolution to stay in or to pass through the protective field during normal operation without causing a fault or stop condition (for blanking application, see [Fixed Blanking Application on page 206](#)).

Both are available in the 450L-E safety light curtain per DIP switch configuration:

- Fixed Teach-in Blanking (see [Figure 191 on page 206](#))
- Reduced resolution (see [Reduced Resolution \(Object Number Limited\) on page 35](#)).

IMPORTANT You must verify that for all blanking and reduced resolution modes, no undetected access is possible into the danger zone via the blanked protective field throughout the whole width of the protective field (also left and right of the blanked object). This verification can be achieved, for example, by using additional mechanical barriers.

The blanking settings do have an impact on the response time (see [Response Time on page 52](#)).

Muting and blanking cannot be configured simultaneously. It is possible to activate fixed blanking and reduced resolution simultaneously.

Teach-in Fixed Blanking

Beams are taught to ignore up to four fixed objects in the sensing field. The blanked fixtures or objects must remain in the sensing field or the 450L-E safety light curtain enters a Fault state (OSSDs off).

Theoretically the maximum number that can be blanked can nearly reach the whole length of the protective field. Minimum the first two active lenses at the connection end or the last two active lenses at the cascading end must be unblocked ([Table 4 on page 32](#)).

IMPORTANT Blanked areas can require an additional risk analysis. If no mechanical or other guarding is used to restrict access to the hazard, the blanked area must be considered in the calculation of the safety distance.

The fixed Teach-in blanking mode of operation is activated through DIP switch settings that are on following plug-ins:

- 450L-APR-BL-5 ([Table 23 on page 62](#)) or
- 450L-APR-MU-8 ([Table 24 on page 62](#))

With Teach-in blanking, the beams to be blanked are taught by activating the optical teach button that is located near the hand symbol on the 450L-E safety light curtain front window (see [Figure 12 on page 33](#)) in a specific sequence (see [Figure 13 on page 33](#)) while the object is in the 450L-E safety light curtain sensing field. The safety light curtain fixed blanking mode of operation is not activated until the teach procedure is complete.

The fixed blanking mode of operation is always monitored. If any part or all blanked objects are removed from the protective field, the OSSD outputs of the 450L-E safety light curtain go to the OFF state and the Rx stick displays a blanking error (see [Table 54 on page 118](#)).

Due to vibrations often present in industrial applications, the number of physically interrupted beams is allowed to be one less than the specified number of beams. A local adjustment of this tolerance value -1 is not possible with DIP switches.

If the fixed blanked object only blocked one beam, the tolerance value is zero. This value means that a minimum of one beam has to be blocked, there is no tolerance.

The 450L-E safety light curtain can perform fixed blanking of one or more adjacent beams. Minimum one of the two synchronization beams ([Figure 8 on page 22](#)) must be unblocked before and during the Teach-in procedure.

A teach-in error occurs if one of the cases that are described in [Table 4](#) (see [Figure 11 on page 32](#) for illustration) happens:

Table 4 - Teach-in Errors and Behavior

Case	Description	Behavior
1	More than four independent objects are in the protective field	In this case, the first four interrupted objects starting from the connection plug-in is taught, all other objects are not taught. As a result, the OSSDs stay in the OFF condition as long as the additional objects are in the protective field.
2	The beams at top and bottom are simultaneously blocked	In this case, the teach-in command is ignored and the 450L-E safety light curtain continues operating with the previously taught objects.
3	One object was moving during teach-in	In this case, the teach-in command is completed, but the error indication at the end of the teach-in process warns the user that the taught limits can cause sporadic OSSD switching.

Two set ups that cause teach-in blanking error:

- Case A: Number of objects > 4
- Case B: Top and Bottom end interrupted.

Figure 11 - Teach-in Blanking Error

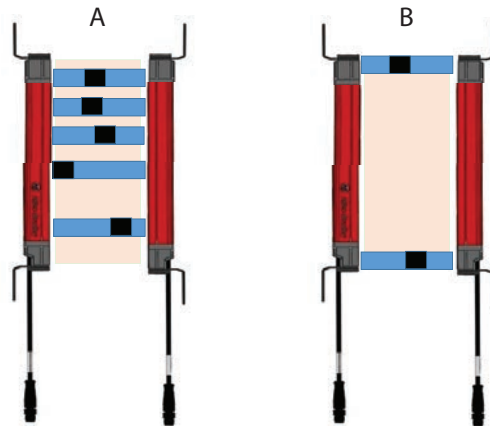

IMPORTANT Fully test the protective field with the provided test rods according to the instructions given in [Regular Inspection on page 123](#).

The configuration and activation of fixed blanking creates a hole to the left and/or right of the object in the protective field. (Objects are indicated in black in [Figure 11](#).) If the fixed object that is in the protective field does not completely fill the area between the GuardShield transmitter and receiver, it is necessary to obstruct access to the hazard by additional means. Hard guarding the open area can accomplish this obstruction. Open areas are indicated blue in [Figure 11](#).

Hard guards refer to mechanical barriers.



ATTENTION: A fixed blanking zone changes the resolution of the 450L-E safety light curtain system (see [Resolution with Blanking on page 37](#)). This change must be considered when calculating the safety distance.

[Table 6 on page 36](#) shows the reaction of the OSSD outputs with Fixed Blanking de-activated and activated for different use cases.

Teach-in Blanking Procedure

The procedure to teach a new fixed blanked object is similar to the procedure to conduct a confirmation of a changed configuration ([Confirmation of a New System Configuration on page 64](#)) with the help of the optical push button.

The optical push button ([Figure 12](#)) has to be activated two times for 5 seconds ([Figure 13](#)). Between the two activations, a break of a maximum of 2 seconds is allowed. The following two descriptions describe the same process that is shown in [Figure 13](#).

Figure 12 - Position of Optical Push Button, ILAS, and Status Indicators

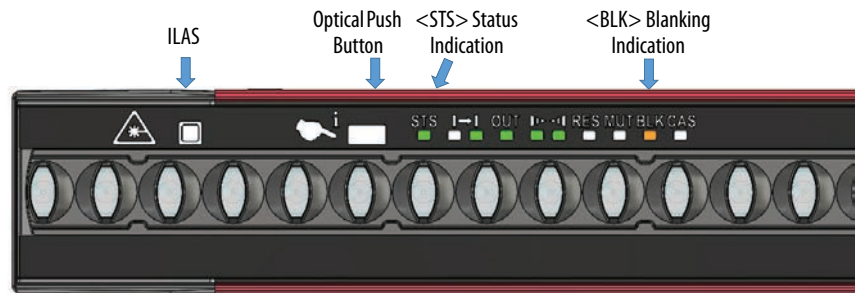
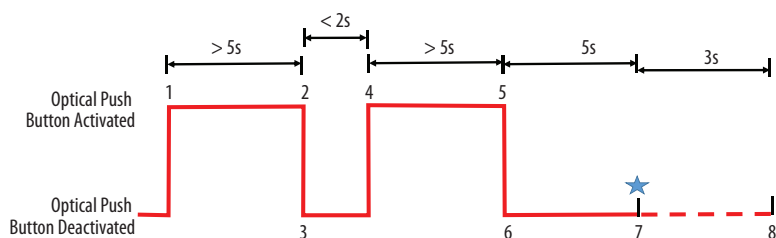

Figure 13 - Teach-In Blanking Configuration Process



Configuration Process

1. The status indicator STS is green, which indicates normal operation (no fault).
2. Actuate optical push button ([Figure 12 on page 33](#)) for 5 seconds.
3. STS remains continuously green
4. As soon as status indicator STS starts green/off blinking, release the optical push button.
5. Release is indicated with a change of frequency 10...1 Hz (status indicator STS green/off and a 50:50 duty cycle).
6. Within 2 seconds, actuate the optical push button.
7. Status indicator STS indicates the activation by a green/off and status indicator BLK indicates the activation by a orange/off frequency of 10 Hz and a 50% duty cycle.
8. Actuate the optical push button for at least for 5 seconds.
9. As soon as the status indicator and the blanking indicator changes frequency 10...1 Hz, release the optical push button.
10. After releasing, the status indicator STS is steady green and the BLK indicator continues blinking for 5 seconds (orange/off).
11. In these 5 seconds, you can remove your hand and all objects that should not be taught.
12. At the end of these 5 seconds, the 450L-E safety light curtain teaches all interrupted beams.
13. A successful Teach-in is indicated with a 3 second blinking of the BLK indicator (orange/off) and STS green on.
14. A failed Teach-in is indicated with a 3 second blinking of the BLK indicator (orange/off) and the STS indicator (green/red).

IMPORTANT If there is an error in the Teach-in procedure, the new fixed blanking zone limits are not accepted and the light curtain continues working with the previously taught zone limits.

Once the configuration confirmation procedure is completed, verify the changed resolution.

A Teach-in procedure can also be conducted with the Rockwell Automation Connected Components Workbench software and an installed optical interface device (see [Optical Interface Device \(OID\) on page 120](#)).

These options lead to deletion of taught fixed blanking areas:

- Change DIP switch setting and confirm new DIP setting
- Insert and confirm another plug-in type.

Reduced Resolution (Object Number Limited)

Reduced resolution is a type of blanking without monitoring whether the beams are interrupted. The comparable blanking function with monitoring is called floating blanking. So floating blanking and reduced resolution have similar functionality, the difference according to the standard IEC 61496 is the object monitoring.

Reduced resolution is always specified in combination with a beam number. There are different types of reduced resolution:

- All blanked beams must be adjacent. The maximum size of the object is equal to the beam value. This type is only good for one single object (reduced resolution, single object).
- Blanked beams can be, but do not have to be adjacent. The sum of the size of all object in the protective field is not larger than the beam value (reduced resolution, multiple objects, object number limited).
- Blanked beams can be, but do not have to be adjacent. The size of each object in the protective field is not larger than the beam value (reduced resolution, multiple objects, object number unlimited).

The reduced resolution that can be activated with a DIP switch in a 450L-E safety light curtain refers to the definition (b) multiple objects, object number limited.

IMPORTANT The blanking modes that can be activated with the DIP switches in a 450L-E safety light curtain system is equal to the blanking modes that can be activated in a 440L safety light curtain system.

The reduced resolution mode of operation is activated through DIP switch settings that are on the following plug-ins:

- 450L-APR-BL-5 ([Table 23 on page 62](#)) or
- 450L-APR-MU-8 ([Table 24 on page 62](#))

Reduced resolution of one beam or reduced resolution of two beams allows one or two beams that are located anywhere in the protective field to be blanked out, for instance, blocked beams ignored and the 450L-E safety light curtain remains with OSSD outputs active. Reduced resolution allows an object to float in (move within, or in and out of) the 450L-E safety light curtain protective field without causing the light curtain outputs to change to the OFF state. For details, see [Table 7 on page 36](#) and [Table 8 on page 37](#).

For reduced resolution with object number limited, the maximum number of blanked objects is equal to the beam number (see [Table 6 on page 36](#)).

If activated by the DIP switch the reduced resolution is active over the entire protective field, except the zones already taught with another blanking type.

IMPORTANT With reduced resolution activated, protective field holes that are left and/or right of the protective field can occur. This occurrence means at times when no object is blocking the protective field, there is a danger that the operator can reach through the protective field without deactivating the machine.

Table 5 - Nomenclature for Table 6...Table 8

Symbol	Description
○	Beam not interrupted
⊗	Beam interrupted
□	Beam is activated for Fixed Blanking and not interrupted
⊗	Beam is activated for Fixed Blanking and interrupted

Table 6 - Status of OSSDs for Different Situations in Case of Fixed Teach-in Blanking

Case	1	2	3	4	5	6	7	8
IR-Beam	No Blanking	Fixed Teach-in Blanking						
N	○	○	○	○	○	○	○	○
N+1	○	⊗	⊗	□	⊗	□	⊗	⊗
N+2	⊗	⊗	□	⊗	□	□	□	□
N+3	○	○	○	○	○	○	○	○
N+4	○	○	○	○	⊗	○	⊗	⊗
N+5	○	○	○	○	○	○	○	⊗
N+6	○	○	○	○	○	○	○	○
Status OSSDs	OFF	ON	ON	ON	OFF	OFF	ON	OFF

IMPORTANT For case 3 and case 4 in [Table 6](#), the OSSDs stay on because of the tolerance -1.

Table 7 - Status of OSSDs for Different Reduced Resolution Instances

Case	1	2	3	4	5	6	7	8	9	10	11	12
IR-Beam	Reduced Resolution Deactivated	Reduced Resolution 1 Beam Active				Reduced Resolution 2 Beams Active						
N	○	○	○	○	○	○	○	○	○	○	○	○
N+1	○	○	⊗	⊗	⊗	○	⊗	⊗	⊗	⊗	⊗	⊗
N+2	⊗	○	○	○	⊗	○	○	○	⊗	⊗	⊗	○
N+3	○	○	○	⊗	○	○	○	⊗	○	⊗	○	⊗
N+4	○	○	○	○	○	○	○	○	○	○	⊗	○
N+5	○	○	○	○	○	○	○	○	○	○	○	⊗
N+6	○	○	○	○	○	○	○	○	○	○	○	○
Status OSSDs	OFF	ON	ON	OFF	OFF	ON	ON	ON	ON	OFF	OFF	OFF

Table 8 - Status of OSSDs for Different Cases of Reduced Resolution in Combination with Fixed Teach in Blanking

Case	1	2	3	4	5	6	7	8	9	10	11	12
IR-Beam	Reduced Resolution Deactivated	Reduced Resolution 1 Beam and Teach-in Fixed Blanking				Reduced Resolution 2 Beams and Teach-in Fixed Blanking						
N	○	○	○	○	○	○	○	○	○	○	○	○
N+1	○	○	⊗	⊗	⊗	○	⊗	⊗	⊗	⊗	⊗	⊗
N+2	⊗	⊗	⊗	⊗	□	⊗	⊗	⊗	⊗	⊗	□	⊗
N+3	○	○	○	⊗	○	○	○	⊗	○	○	○	⊗
N+4	○	○	○	○	○	○	○	○	○	○	⊗	○
N+5	○	○	○	○	○	○	○	○	○	○	○	⊗
N+6	○	○	○	○	○	○	○	○	○	⊗	○	○
Status OSSDs	ON	ON	ON	OFF	OFF	ON	ON	ON	ON	OFF	OFF	OFF

Resolution with Blanking



ATTENTION: Actuation of the reduced resolution mode, changes the resolution of the 450L-E safety light curtain.

Table 9 shows resolution of a 450L-E safety light curtain for different blanking mode combinations.

Table 9 - Resolution

GuardShield Resolution (No Blanking)	Configured Blanking Type	Configured Resolution
14 mm (0.56 in.)	No blanking	14 mm (0.56 in.)
	Fixed blanking	Single object: 28 mm (1.11 in.) Multiple objects: 42 mm (1.66 in.)
	Reduced resolution one Beam	23 mm (0.91 in.)
	Reduced resolution one Beam in combination with Fixed Teach-In blanking	42 mm (1.66 in.)
	Reduced resolution two Beams	33 mm (1.30 in.)
	Reduced resolution two Beams in combination with Fixed Teach-in blanking	52 mm (2.05 in.)
30 mm (1.19 in.)	No blanking	30 mm (1.19 in.)
	Fixed blanking	Single object: 53 mm (2.09 in.) Multiple objects: 82 mm (3.23 in.)
	Reduced resolution one Beam	44 mm (1.74 in.)
	Reduced resolution one Beam in combination with Fixed Teach-In blanking	82 mm (3.23 in.)
	Reduced resolution two Beams	63 mm (2.49 in.)
	Reduced resolution two Beams in combination with Fixed Teach-In blanking	100 mm (3.94 in.)

IMPORTANT After each configuration or reconfiguration of a GuardShield safety light curtain, the configuration of the safety light curtain is tested using an appropriate test piece.

Especially critical for the resolutions are the borders between two adjacent blanking zones. [Table 9 on page 37](#) provides the largest resolution for a complete light curtain system for different DIP switch settings.

For blanking in the case of cascading, see [Cascading and Blanking on page 52](#).

Muting

The cascading feature is only available for the 450L-E safety light curtain. To enable the muting functionality, the receiver plug-in 450L-APR-MU-8 must be installed.

IMPORTANT A detailed description about muting, muting restrictions and hints for the installation are given in the standard IEC 62046. Additional hints are mentioned in the attachment A7 of IEC 61496-1. The muting function, is only allowed after a thorough safety analysis according to EN 13849-1 and ISO EN 12100 is completed.

Certain applications in practice require that the protective field of the 450L-E safety light curtain is muted automatically without the safety outputs switching off. A typical example of such an application is a conveyor belt. It is possible to transport the goods on a pallet through the protective field without stopping the pallet movement.

Muting is the temporary automatic suspension of the protective function of a safeguarding device like a light curtain. The muting function allows the transport of material through a light curtain without stopping a conveyor. To distinguish between material and persons, a certain sequence of events and timings are used. Muting sensors are mounted in a certain pattern, and the material must pass by the sensors and light curtain within specified time limits. If the muting sensor sequence is incorrect or the timing parameters are violated, the safeguarding device stops the conveyor. An override signal allows the movement of the material through the light curtain after a violation.

The 450L-E safety light curtain has three distinct types of muting, where the sequence and timing of signals that the light curtain monitors allows objects to pass through the light curtain without shutting down the machine process. The three available types are:

- Two sensors, T-type muting (bidirectional operation)
- Four sensors, T-type muting (bidirectional operation)
- Two sensors, L-type muting (unidirectional operation)

The two-sensor muting types can be connected at the connection plug-in (see [Figure 69 on page 104](#)) or at the cascading plug-in 450L-APC-IO-8 (see [Figure 75 on page 110](#)). The four-sensor muting type can only be connected at the cascading plug-in 450L-APC-IO-8.

To activate the desired muting functionality, select the DIP switches of the receiver plug-in 450L-APR-MU-8 according to [Table 24 on page 62](#) and [Table 26 on page 63](#).

Each of these functions can be configured with manual or automatic reset.

IMPORTANT The safety function block muting must be set to manual reset. In case the safety light curtain is set to automatic start, the safety relay or the safety PLC manages the manual reset.

Muting Lamp

Depending on the risk assessment of the application, a muting lamp is necessary to warn an operator when the light curtain is muted (see details in IEC 62046). The muting lamp is on when the light curtain is muted.

If an error in the muting sequence has occurred, the muting lamp blinks (see [Troubleshoot on page 116](#)), which indicates that the muting condition is not initiated, or has been discontinued.

Muting Sensors

IMPORTANT Detailed information about muting sensors (for example, positioning) is given in the standard IEC 62046.

Mechanical muting sensors must have an opening contact. For proper operation, the muting sensors are on (normally closed) if the safety light curtain is not muted.

The safety relay, the 450L-E safety light curtain, and the muting sensors must have the same reference (24V Com) for proper operation.

Photoelectric muting sensors do not need to be certified according to safety type 2 or 4 of IEC 61496-1/-2. The detection zone of the muting sensors must be within 30° of the horizontal and are mounted at a height suitable to detect a person's leg (see IEC 62046).

Various positions and sizes of materials on the pallet can make it difficult to guarantee an uninterrupted muting signal over the entire passage through the guarded area. For this reason, an off-delay time $t(\text{msdel})$ for the muting sensor inputs and the light curtain is set to 50 ms.

IMPORTANT The muting sensors detect the material on a pallet and not the pallet itself.

Mute Dependent Override Function (MDO)

Normal activation of the manual start button is only permitted if no muting sensors are activated and the light curtain is not interrupted.

An error in the muting sequence does not allow a muting condition. If the safety light curtain is interrupted, the OSSD safety outputs of the 450L-E safety light curtain switch off. This error typically leads to a cessation of movement.

In such a case, it may not be easy to move the material out of the protected area. If this situation is anticipated (an error in the muting sequence or timing), the Reset button provides an MDO (depending on DIP switch settings). The OSSD safety outputs can be reactivated temporarily by activating the Reset button (manual start). The maximum allowable duration t_{mdo} for this MDO is provided in [Table 10 on page 42](#), [Table 11 on page 43](#), and [Table 13 on page 47](#) of the individual muting types.

IMPORTANT Make sure that the MDO can be installed based on the risk assessment of the application. Some applications can require a spring loaded keyswitch for the reset.

The MDO is possible at the same pin when automatic start is configured. For this case, the connected safety relay or safety logic performs the manual reset.

IMPORTANT In muting applications, the reset of the muting function block must be manual reset. Either the light curtain and/or the safety relay that is connected to the light curtain performs the manual reset.

A push button or a spring loaded keyswitch activates the MDO. The push button/keyswitch is mounted at a location from which the dangerous area can be seen.

The MDO is automatically terminated after the mute dependent override time (t_{mdo}) has elapsed, or when the safety light curtain is no longer interrupted, whichever occurs first.

The muting functionality does not have an impact on the response time of the 450L-E safety light curtain.

Two-sensor T-type Muting

The sensors and light curtain form the shape of an upside down “T,” when viewed from the side. The muting sensors (MS) are mounted to form an “X” sensing pattern where the sensing beams cross near the center of the light curtain (LC).

Figure 14 - Two Sensor T-type Muting Arrangement

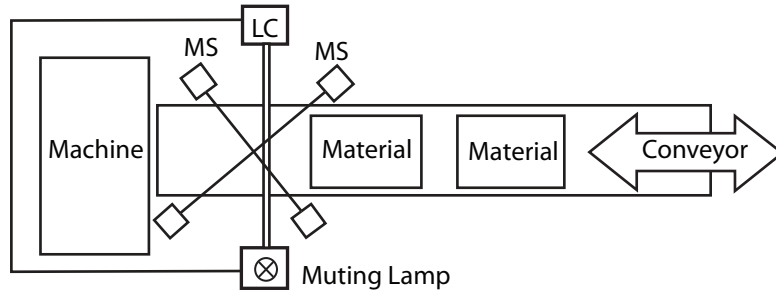

The muting sensors can be mounted symmetrically (equal distance from the light curtain) or asymmetrically (unequal distance from the light curtain).

The material can break either MS1 first (or MS2 first), then the other sensor, and then the light curtain. As the material clears the light curtain, it must then clear MS2 (or MS1) first and then the other sensor. The muting lamp turns on shortly after the second sensor is blocked, and the light curtain is muted.

Either of these two patterns is acceptable:

- MS1↑ MS2↓ LC↓ LC↑ MS2↑ MS1↑
- MS2↓ MS1↑ LC↓ LC↑ MS1↑ MS2↑

The crossing point of the two light beams is situated behind the sensing field of the safety light curtain in the direction of the dangerous area.

The height of the crossing point of the two muting sensors is at the same level as or higher than the lowest beam of the light curtain.

Be sure that the distance from the crossing point to the protective field of the safety light curtain is as short as possible.

During the muting process, it is not possible for a person to enter the undetected dangerous area to the left or right of the object.

With proper arrangement of the sensors, the conveyor can move in the forward or reverse direction, while also maintaining safeguarding integrity.

For connecting the sensors, see [Table 37 on page 92](#) and [Table 41 on page 94](#) for the cascading plug-in.

Figure 15 - Muting Time for Two Sensor T-type Muting Arrangement

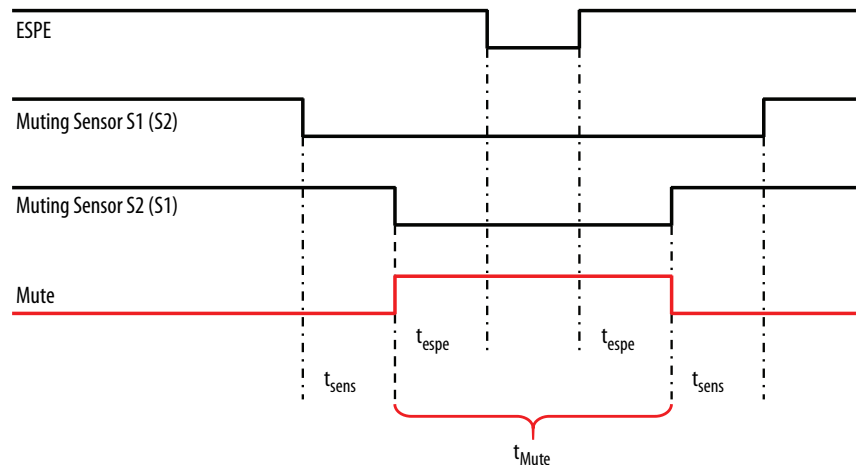

For proper operation, MS1 and MS2 must be activated/deactivated within the time t_{sens} , and the light curtain must be clear before the muting time t_{Mute} expires.

Muting of the safety light curtain is achieved only when muting sensor MS1 and MS2 are activated within the specified time t_{sens} . Since this muting mode is bidirectional the muting sequence also functions in reverse (for example, muting sensor one before muting sensor two, or two before one are both allowed). Both signals, however, cannot arrive simultaneously (t_{sens} minimum). The muting condition stops if one of the muting sensors is not activated or if the maximum muting time t_{Mute} is exceeded (muting timeout).

The minimum time between the sensors t_{sens} minimum is dependent on the position of the muting sensors and the speed of the object to be muted. You must maintain at least a delay of t_{sens} minimum for more dependable operation.

[Table 10](#) shows the default timing values for T-type muting. These values can be adjusted by using Connected Components Workbench software.

Table 10 - Two Sensor T-type Muting Default Settings

Parameter	Default Value	Parameter	Default Value
t_{sens}	4 s	t_{mdo}	20 s
$t_{sens\ min}$	50 ms	t_{espe}	5 s
t_{Mute}	5 minutes		

If t_{sens} , t_{espe} or t_{Mute} is exceeded, the STS and the MUT indicator flashes ([Table 54 on page 118](#)). The muting lamp output has the same characteristic as the MUT indicator. If the material is backed away from the sensors, the fault is cleared and the muting lamp turns off. If the material proceeds to break the light curtain, the OSSD output turns off. The STS and MUT indicator continue to flash. Use the muting override command to turn on the OSSD outputs temporarily and clear the material from the protective field.

IMPORTANT It must not be possible for a person to pass undetected to the left or right of the object during the muting process.

Two-sensor L-type Muting

The sensors and light curtain form the shape of the letter L, when viewed from the side. The muting sensors (MS) are mounted on one side of the light curtain.

Figure 16 - Two-sensor L-type Muting Arrangement

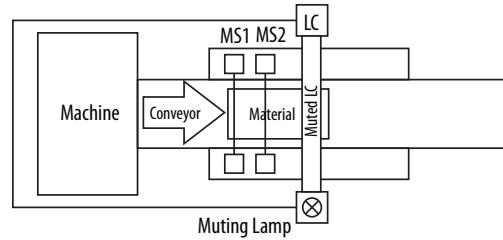

This muting mode is used to allow a load to exit a dangerous area while helping to prevent access from outside the dangerous area. The object coming from the dangerous area interrupts the two muting sensors, which initiates the muting of the safety light curtain. As the object continues to move through the protective field, muting remains active until the light curtain is no longer interrupted.

For connecting the sensors, see [Table 37 on page 92](#) and [Table 41 on page 94](#) for the cascading plug-in.

Figure 17 - Timing Sequence for Two Sensor L-type Muting Arrangement

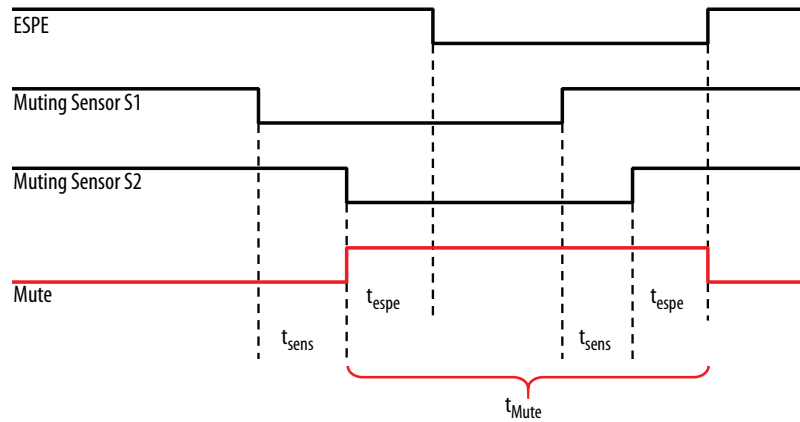

Muting of the safety light curtain is initiated only after muting sensor MS1 and MS2 are activated within the specified time t_{sens} . The muting condition stops after t_{espe} is exceeded, the light curtain is no longer interrupted, or the maximum muting time t_{Mute} is exceeded (muting timeout), whichever occurs first.

[Table 11](#) shows the default muting and synchronization times. These values can be adjusted by using Connected Components Workbench software.

Table 11 - Two Sensor L-type Muting Default Settings

Parameter	Default Value	Parameter	Default Value
t_{sens}	3 s	t_{mdo}	20 s
$t_{sens\ min}$	50 ms	t_{espe}	3 s
t_{Mute}	5 min		

The two sensor L-type muting arrangement must only be used for material that exits the hazardous area. It must not be used for material that enters the hazardous area.

It has to be impossible for a person to pass undetected to the left or right of the object during the muting process.

Two-sensor L-type Muting with Enable

This muting mode can only be configured with Connected Components Workbench software. This muting mode is suited for applications when muting should only be possible at certain times; for example, only when a conveyor is running. It can also be considered when the size and position of the pallet load is irregular or the size of the pallet is much smaller than the width of the conveyor. Because only one optical sensor is on either side of the light curtain, this mode requires an additional enable signal to initiate the muting sequence (for example, a conveyor run signal). This signal must be low before muting can be initiated.

Figure 18 - Two-sensor L-type Muting with Enable Arrangement

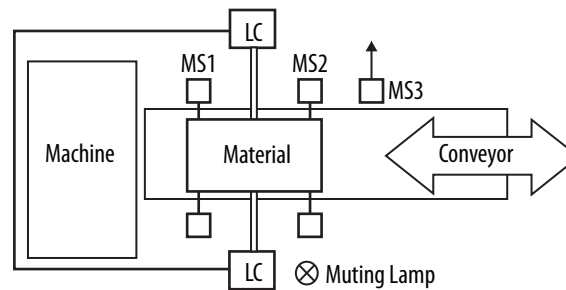

The height of the two muting sensors must be at the same level as or higher than, the lowest beam of the light curtain.

The distance between S1 or S2 sensors to the light curtain must be sufficient so that a person's leg cannot activate them simultaneously (>250 mm [9.8 in.]).

A person must not be able to pass undetected to the left or right of the object during the muting process. [Figure 19 on page 45](#) shows the corresponding timing sequence for such an arrangement.

Figure 19 - Timing Sequence for Two Sensor L-type Muting with Enable

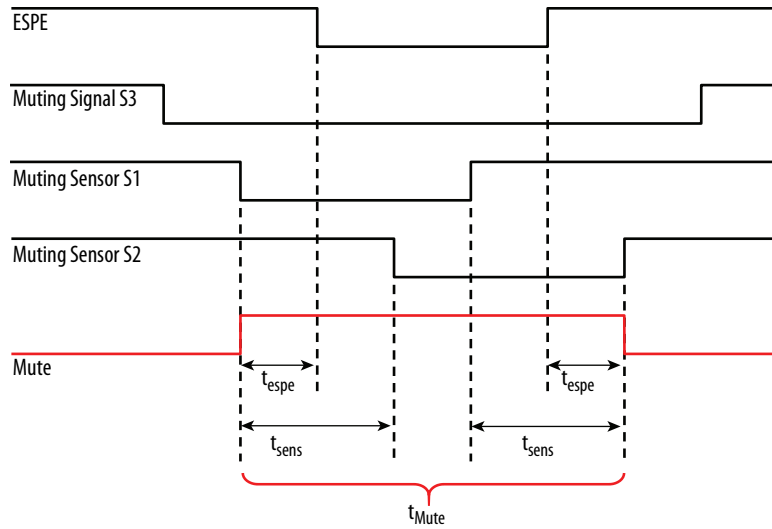

Muting of the light curtain is active only when both enable signal S3 and sensor S1 in one direction or enable signal S3 and sensor S2 in the opposite direction are activated simultaneously. There are no timing limitations from when the S3 signal goes LO to when the applicable muting sensor goes LO.

The object must be long enough to block both sensors.

The muted condition remains only if muting sensor S1 and S2 are activated within the specified time t_{sens} and less than the muting time t_{Mute} .

The muting condition stops if one of the following occurs:

- S3 and S1 are no longer activated (one direction)
- S3 and S2 are no longer activated (other direction)
- The maximum muting time t_{Mute} is exceeded (muting timeout)

Only after one muting sequence is finished may a new muting sequence be started. The enable signal S3 must first go HI before returning to LO, in order for a second object to pass through the light curtain (for example, the equivalent to a conveyor stop and restart).

[Table 12](#) shows the default settings for two-sensor L-type muting with enable. Use Connected Components Workbench software to change the settings.

Table 12 - Two Sensor L-type Muting with Enable Default Settings

Parameter	Default Value
t_{sens}	4 s
t_{Mute}	5 min
t_{mdo}	20 s
t_{espe}	4 s

If you get a timing error, the mute lamp flashes at 1 Hz and the mute timing error output turns ON.

If the object stops in front of the first sensor and does not block the light curtain, the mute timing error goes HI and the mute lamp flashes at 1 Hz. The OSSD outputs remain ON, which allows you to reverse the conveyor and restart the muting sequence.

Use the S3 muting signal to clear the errors. When S3 goes HI, it clears the mute timing error, mute sequence error, and the muting error outputs.

Four-sensor Muting

The sensors and light curtain form the shape of an upside down T, when viewed from the side. Two muting sensors (MS) are mounted on either side of the light curtain (LC).

Figure 20 - Four-sensor Muting

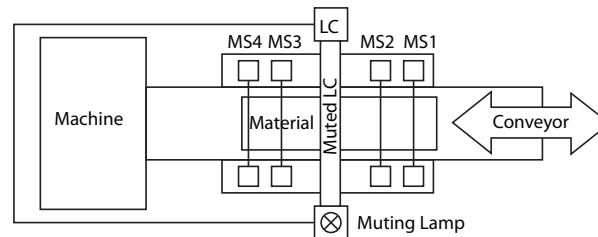

The material can travel in either direction; breaking MS1 first and MS4 last or breaking MS4 first and MS1 last. The muting lamp turns on and the light curtain is muted after the second sensor is blocked. The object must be large enough to interrupt all four sensors.

For connecting the muting sensors, see [Table 42 on page 94](#).

This muting mode is considered when the size and position of the pallet load is irregular, or the size of the pallet is much smaller than the width of the conveyor. This mode can require more space than the two sensor T-type with enable signal muting mode.

Sensors two and three (closest to the light curtain) are mounted within 200 mm (7.87 in.) of the light curtain. This position makes it difficult for a person to enter the dangerous zone undetected by preceding or following a load system into the dangerous zone.

The distance between any two muting sensors must be greater than 250 mm (9.84 in.) so that a person's leg cannot activate them simultaneously.

The distance between sensor MS1 and MS4 is such that a cylindrical object with a diameter of 500 mm (19.68 in.) with its axis parallel to the protective field cannot activate the muting function when moved in any point of the gate at any speed up to 1.6 m/s (see IEC 62064).

The muting sensors MS1-MS4 detect the objects on pallets and not the pallet itself. When this action is impractical, additional measures can be necessary to deter people from entering the zone by sitting on the pallet.

Figure 21 - Timing Sequence for Four Sensor Muting

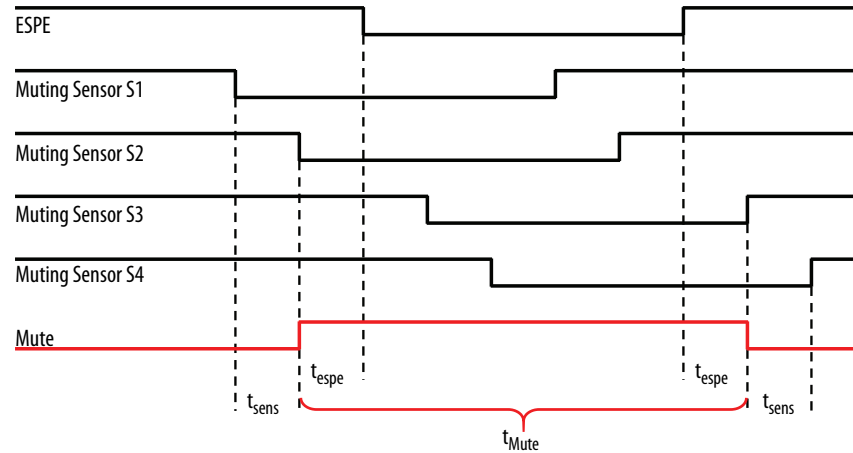

Muting of the 450L-E safety light curtain is achieved only when muting sensor MS1 and MS2 are activated within the specified time t_{sens} . The delay between the sensors must be larger than t_{sens} minimum. For a successful muting sequence, all four sensors must be simultaneously activated for a certain time period.

The muting condition stops when either sensor MS3 or MS4 is deactivated, or the maximal muting time t_{Mute} is exceeded (muting timeout). Since this muting mode is bidirectional, the muting sensor sequence also functions in reverse (such as MS4 => MS1).

[Table 13](#) shows the default time limits. These values can be adjusted by using Connected Components Workbench software.

Table 13 - Four Sensor T-type Muting Default Time Limit Settings

Parameter	Default Value
t_{sens}	4 s
$t_{sens\ min}$	50 ms
t_{Mute}	5 minutes
t_{mdo}	20 s
t_{espe}	5 s

A time t_{sens} of 4 s is recommended in IEC 62046.

The behavior of the muting lamp indicator is analogous to the behavior described in [Two-sensor T-type Muting on page 41](#).

It is not possible for a person to pass undetected to the left or right of the object during the muting process.

Cascading

The cascading feature is only available for the 450L-E safety light curtain. A 450L-B safety light curtain can only be used as the last pair of a cascaded system.

Cascading is enabled by the insertion of an additional cascading plug-in (450L-APC-IO-8) at the top cascading end of the stick. Depending on the configuration of the DIP switches at the connection plug-in module, the functions of the I/Os at the cascading plug-in can be changed (for example, for muting applications). The different settings for the pins of the cascading plug-in are provided in [Table 39 on page 93](#) through [Table 42 on page 94](#).

IMPORTANT Cascading with the 450L-APC-IO-8 cascading plug-in requires a minimum distance between two adjacent cascaded pairs ([Figure 24 on page 50](#)).

As soon as the 450L-APC-IO-8 cascading plug-in is inserted, the I/Os of the cascading plug-in provide the option to connect an additional 450L safety light curtain with an 8-pin connection in series (see [Figure 23 on page 49](#)). This feature allows up to four pairs of 450L-E safety light curtain transmitters and receivers to be interconnected in series.

[Figure 22](#) and [Figure 23 on page 49](#) specify the nomenclature that is used for cascaded systems.

Figure 22 - Nomenclature Used for a Noncascaded Setup

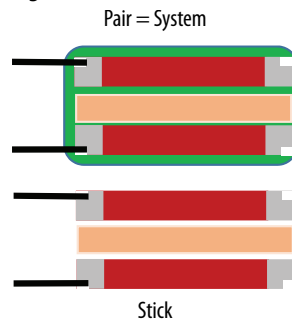
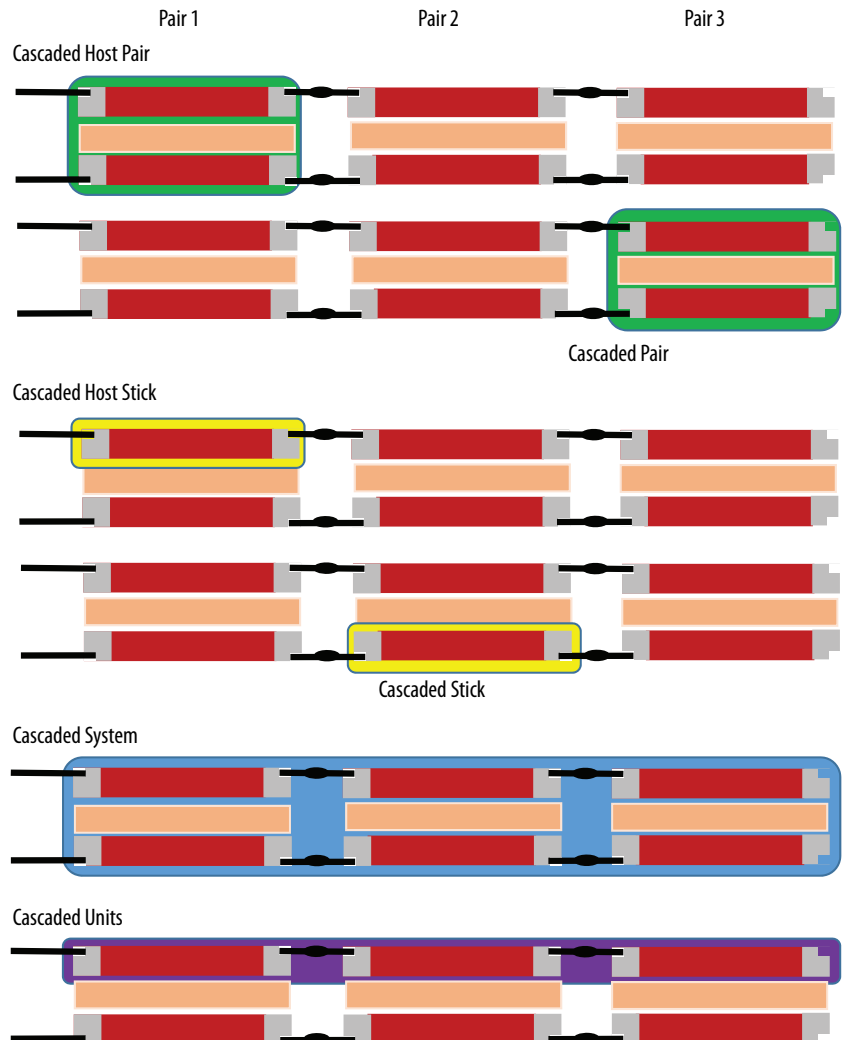

Figure 23 - Nomenclature for Cascaded Design

Nomenclature that is used for a cascaded design (example for a cascaded system with three cascaded pairs).



The first pair in a cascaded system is called the host pair. The OSSD outputs of the host pair are connected to safety contactors, a safety relay, or a safety PLC.

Cascading allows the 450L-E safety light curtain to help protect multiple sides of a machine and to connect the complete design with only two OSSD safety outputs to the machine safety control.

See [Cascading Application on page 207](#) for a typical application with cascading.



ATTENTION: To avoid optical crosstalk (see [Mount Multiple 450L GuardShield Safety Light Curtains on page 79](#)) or optical interference between the two adjacent pairs, a minimum spacing distance must be maintained. This minimum spacing distance is a function of the operating distance D between the transmitter and receiver. The spacing distance, S , must be larger than $0.026 \times D$. [Figure 24 on page 50](#) identifies the spacing distance and operating distance of a cascaded pair. [Table 14 on page 50](#) shows examples of the spacing distance, S , for typical operating distances when no additional optical barriers are installed between the pairs.

[Figure 24](#) identifies the spacing and operating distance of a cascaded light curtain pair.

Figure 24 - Identification of Spacing (S) and Distance (D)

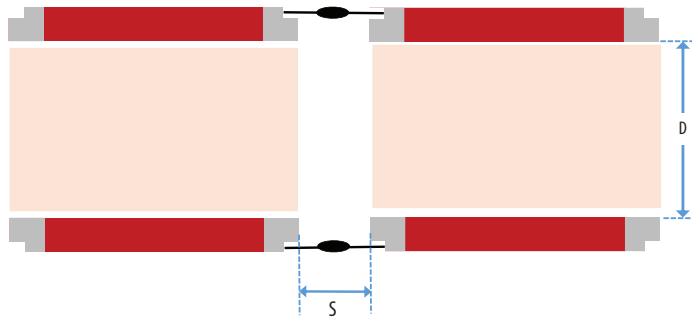

Table 14 - Minimum Spacing Distance (S) between Cascaded Pairs without Optical Barriers

D [m (ft)]	S [mm (in.)]
1 (3.28)	26 (1.02)
5 (16.4)	132 (5.2)
10 (32.8)	264 (10.4)
15 (49.2)	393 (15.5)

The cascade feature is available for protective field heights of 300 mm (11.81 in.) and longer. 450L transceiver sticks with a length of 150 mm (5.9 in.) cannot be used as a host pair or a middle pair in a cascaded system. However, a 150 mm (5.95 in.) 450L-E safety light curtain can be used as the last pair in a cascaded system.

A maximum of four 450L-E safety light curtains can be interconnected with a common pair of OSSDs. Each cascaded pair can have a resolution of 14 mm (0.56 in.) or 30 mm (1.19 in.) and a protective field height of up to 1950 mm (76.77 in.). Each cascading pair functions as an independent light curtain.

A cable length between two cascaded sticks must not exceed 10 m (32.8 ft).

If a 450L-E safety light curtain transceiver with an installed 450L-APC-IO-8 cascading plug-in is used as a standalone light curtain pair or as the last segment in a cascaded system, the cascading plug-in must be terminated:

- Use termination plug 898D-81CU-DM⁽¹⁾ at the cascading plug-in of a transceiver working as an Rx.
- Use termination plug 898D-81CU-DM or M12 sealing cap (1485A-M12) at the cascading plug-in of a transceiver working as a Tx.

Figure 25 - Cascaded System with 450L-APC-IO-8 as Last Module

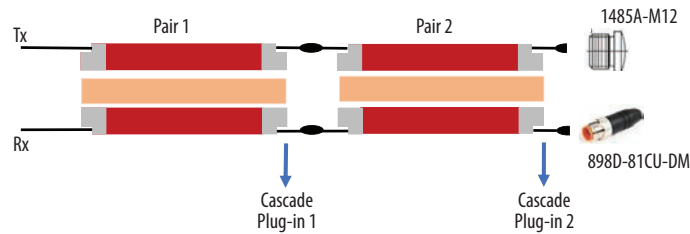

If a 450L-E stick, which operates as a receiver with a 450L-APC-IO-8 cascading plug-in, the corresponding transmitter, can but does not require, a 450L-APC-IO-8 cascading plug-in to be installed (see [Figure 26](#)).

Figure 26 - Cascaded System

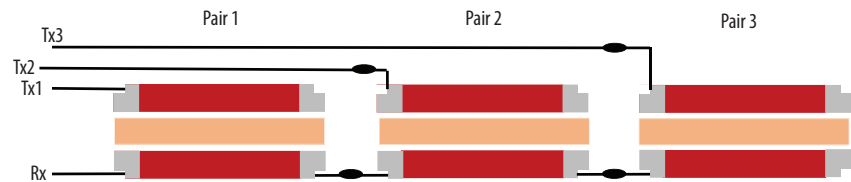

Cascaded system with three pairs and only two 450L-APC-IO-8. Supply power for all transmitters that are wired separately.

Manual start modes and relay monitoring (EDM) are not available on cascaded middle and end pairs of a cascading 450L system with DIP switch configuration. However, it is possible to configure these operating modes at the receiver of the host pair and allow the whole cascading system to operate in these modes.

For features like beam coding or blanking, each cascaded pair has to be configured separately.

For two-sensor muting applications, the muting function applies to the cascaded system. Four-sensor muting cannot be applied to cascaded systems.

(1) The termination plug has three pins that are shorted together (pins 2, 5, and 6). It is only needed on the receiver side.

Cascading and Blanking

When a 450L-E safety light curtain is installed for cascading, each cascading 450L-E pair functions as a standalone safety-light curtain pair with its OSSDs connected in series to the host pair OSSDs. Therefore, if requested, it is necessary to configure fixed blanking and/or reduced resolution in each cascaded pair. This configuration is accomplished by inserting in each 450L-E receiver an 8-pin 450L-APR-MU-8 plug-in that the blanking functionality is provided. First, set the DIP switches for the requested blanking function before you start assembling the light curtain sticks. Then, align all pairs and secure the brackets. It is then possible to teach each light curtain pair receiver with the Teach-In procedure. A successful completion of the teach function changes the operating mode of that pair only. During the teach-in process, the OSSDs of that pair and the OSSDs of the host segment are off (0V). Connected Components Workbench software can also be used to configure blanking for each cascaded pair.

Response Time

The response time, T_r , of the light curtain is the time from when the protective field of the light curtain is interrupted to when the safety outputs turn OFF. The response time is affected by the light curtain features that are used in the application.

Standard Response Time, T_s

The standard response time refers to the response time for standard on/off application. The standard application includes the following:

- Any start mode
- All operating ranges
- All EDM settings

The standard application does not include the advanced features:

- Beam coding
- Blanking (fixed or floating)
- Cascading
- Multiple zones
- Muting
- Reduced resolution
- Multiple scans
- Short interruption ignore time

For the purposes of determining the response time, floating blanking is equivalent to reduced resolution.

Although muting is considered an advanced feature, muting has no effect on the response time.

The standard response time is dependent on the following:

- Light curtain type (B or E)
- Resolution (finger or hand)
- Protective height

The standard response time for the 450L-B is shown in [Table 15](#). The standard response time for the 450L-E is shown in [Table 16](#). In these tables, $T_r = T_s$.

Table 15 - Standard Response Time for 450L-B

Protective Height [mm (in.)]	Response Time (T_s)	
	Finger [14 mm (0.55 in.)] Resolution [ms]	Hand [30 mm (1.18 in.)] Resolution [ms]
150 (5.91)	14	14
300 (11.81)	14	14
450 (17.72)	14	14
600 (23.62)	14	14
750 (29.53)	14	14
900 (35.43)	14	14
1050 (41.34)	16	14
1200 (47.24)	17	14
1350 (53.15)	19	14
1500 (59.06)	20	14
1650 (64.96)	22	14
1800 (70.87)	23	14
1950 (76.77)	25	15

Table 16 - Standard Response Time for 450L-E

Protective Height [mm (in.)]	Response Time (T_s)	
	Finger [14 mm (0.55 in.)] Resolution [ms]	Hand [30 mm (1.18 in.)] Resolution [ms]
150 (5.91)	9	8
300 (11.81)	10	9
450 (17.72)	11	9
600 (23.62)	12	10
750 (29.53)	14	11
900 (35.43)	14	11
1050 (41.34)	14	12
1200 (47.24)	15	12
1350 (53.15)	16	13
1500 (59.06)	17	13
1650 (64.96)	18	13
1800 (70.87)	19	13
1950 (76.77)	20	13

Advanced Feature Response Time, T_a

The response time of advanced features requires a complex algorithm. The response time is also dependent upon whether the features are set up the DIP switches on the plug-in or software configured by Connected Components Workbench software.

Table 17 shows response times when the advanced features are set by the Dip switches on the blanking or muting plug-in. The description of each column is:

Column	Description	Column	Description
1	Standard operation with beam coding	7	Reduced resolution, two beams with beam coding
2	Fixed blanking up to four zones	8	Fixed blanking up to four zones + reduced resolution, single beam
3	Fixed blanking up to four zones with beam coding	9	Fixed blanking up to four zones + reduced resolution, single beam with beam coding
4	Reduced resolution, single beam	10	Fixed blanking up to four zones + reduced resolution, two beams
5	Reduced resolution, single beam with beam coding	11	Fixed blanking up to four zones + reduced resolution, two beams with beam coding
6	Reduced resolution, two beams		

Table 17 - Response Time, T_a (Set by DIP Switches)

Protective Height [mm (in)]	Response Time, T_a , (ms)										
	1	2	3	4	5	6	7	8	9	10	11
Finger Resolution											
150 (5.91)	9	14	16	12	13	15	16	17	19	18	20
300 (11.81)	11	15	17	13	14	17	18	19	20	20	21
450 (17.72)	13	17	19	15	16	18	19	20	22	21	23
600 (23.62)	14	18	20	16	18	19	21	21	23	22	24
750 (29.53)	15	19	21	17	18	20	21	23	24	24	25
900 (35.43)	15	19	21	17	18	20	21	23	24	24	25
1050 (41.34)	16	19	22	17	20	20	23	23	26	24	27
1200 (47.24)	18	20	24	18	21	21	24	23	27	24	28
1350 (53.15)	19	21	26	19	23	22	26	24	29	25	30
1500 (59.06)	21	22	27	20	24	23	27	25	30	27	31
1650 (64.96)	22	23	29	21	26	24	29	27	32	28	33
1800 (70.87)	24	25	30	23	27	26	30	28	33	29	34
1950 (76.77)	25	26	32	24	29	27	32	29	35	30	36

Table 17 - Response Time, T_a (Set by DIP Switches)

Protective Height [mm (in)]	Response Time, T_a , (ms)										
	1	2	3	4	5	6	7	8	9	10	11
Hand Resolution											
150 (5.91)	9	12	13	12	12	15	15	16	16	17	17
300 (11.81)	9	14	16	12	13	15	16	17	19	18	20
450 (17.72)	10	15	16	13	14	16	17	18	19	19	21
600 (23.62)	11	15	17	13	14	17	18	19	20	20	21
750 (29.53)	12	16	18	14	15	17	18	19	21	20	22
900 (35.43)	13	17	19	15	16	18	19	20	22	21	23
1050 (41.34)	13	17	19	15	17	18	20	20	23	21	24
1200 (47.24)	14	18	20	16	18	19	21	21	23	22	24
1350 (53.15)	14	19	21	17	18	20	21	22	24	23	25
1500 (59.06)	14	19	21	17	18	20	21	22	24	23	25
1650 (64.96)	14	19	21	17	18	20	21	22	24	23	25
1800 (70.87)	15	19	21	17	18	20	21	22	24	23	25
1950 (76.77)	16	19	22	17	19	20	22	22	25	23	26

Table 18 shows the worst-case response times when the multiple advanced features are set by the configuration in Connected Components Workbench software. Shorter response times are typically achieved. The actual response time can be read in the diagnostic table reported by Connected Components Workbench software.

Table 18 - Response Time, T_a (Set by Connected Components Workbench Software Configuration)

Protective Height [mm (in)]	Response Time, T_a , (ms)	
	Reduced Resolution (Floating Blanking), single beam Reduced Resolution one object outside the blanked zones	Reduced Resolution (Floating Blanking), single beam Reduced Resolution one object outside the blanked zones, with Beam Coding
Finger Resolution		
150 (5.91)	23	24
300 (11.81)	26	28
450 (17.72)	32	35
600 (23.62)	33	36
750 (29.53)	48	51
900 (35.43)	48	51
1050 (41.34)	49	53
1200 (47.24)	50	54
1350 (53.15)	55	60
1500 (59.06)	57	62
1650 (64.96)	72	78
1800 (70.87)	73	79
1950 (76.77)	74	81

Table 18 - Response Time, Ta (Set by Connected Components Workbench Software Configuration)

Protective Height [mm (in)]	Response Time, Ta, (ms)	
	Reduced Resolution (Floating Blanking), single beam Reduced Resolution one object outside the blanked zones	Reduced Resolution (Floating Blanking), single beam Reduced Resolution one object outside the blanked zones, with Beam Coding
Hand Resolution		
150 (5.91)	21	22
300 (11.81)	23	24
450 (17.72)	25	27
600 (23.62)	26	28
750 (29.53)	31	34
900 (35.43)	32	35
1050 (41.34)	32	35
1200 (47.24)	33	36
1350 (53.15)	47	51
1500 (59.06)	47	51
1650 (64.96)	47	51
1800 (70.87)	47	51
1950 (76.77)	48	52

Multiple Scan

When multiple scan is enabled, the response time increases by approximately 33%. See the diagnostic property 3.30 in CCW for the actual response time.

Short Interruption Time

The 450L-E safety light curtain can be configured to ignore interruptions up to 174 ms. This value is added to the response time. See the diagnostic property 3.30 in CCW for the actual response time.

Cascading Response Time, Tc

The response time of a cascaded light curtain is simply an additional adder due to the cascading plug-in (450L-APC-IO-8). The adder must take into consideration the total number of cascading plug-ins between the cascaded stick and the host stick. Therefore, the total response time is calculated as such:

$$T_c = 6 \text{ ms}$$

$$\text{Standard Features: } T_r = T_s + (n \times T_c)$$

$$\text{Advanced Features: } T_r = T_a + (n \times T_c)$$

Figure 27 on page 57 shows an example with three pairs of light curtains. The cascading adder for Pair 1 is zero, as Pair 1 is the host. Pair 2 has one cascading plug-in between itself and the host, so the additional adder is 6 ms. Pair 3 has two cascading plug-ins between itself and the host, so the additional adder to the response time is 12 ms.

Figure 27 - Response Time Calculation for each Cascaded Pair

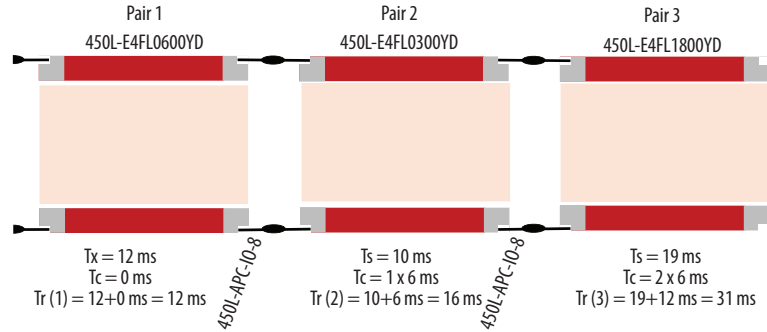

Connected Components Workbench Response Time

Connected Components Workbench software reports the response time when the configuration is locked. Figure 28 shows an example of the response time reported by Connected Components Workbench software. On the Diagnose screen, scroll down the diagnostic parameter to 3.30.

Figure 28 - Response Time in Connected Components Workbench Diagnostic Parameter 3.30



IMPORTANT Determine Stop Time: The stopping time calculation must include the response times of all devices in the stop circuit (see [Determine the Safety Distance on page 68](#)). Not including all device and control system elements when calculating the stopping time results in an inaccurate safety distance calculation.

Product Labels

Figure 29 shows examples of the response time printed on the GuardShield sticks. This response time should not be used to calculate the safety distance calculation. Use the information in this user manual to determine the response time. This information will be removed in future changes of the label.

Figure 29 - Response Time on the Product Label

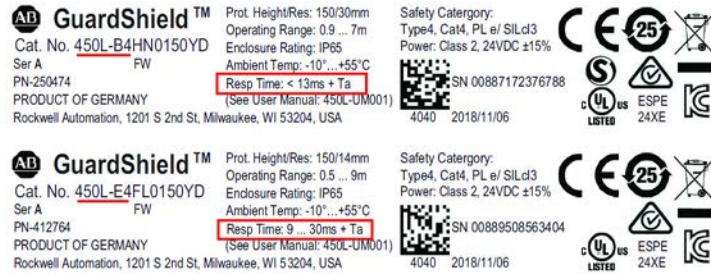

System Configuration

An authorized person must perform system configuration by setting the DIP switches at the receiver plug-in. First set the DIP switches and then mount the light curtain and establish the electrical connections.

[Table 19](#) and [Table 20](#) show which plug-ins are available and which functionality can be selected with the receiver plug-in.

The blanking and the muting plug-in can be used to operate a 450L-B safety light curtain, but no muting, blanking, or beam coding functionality can be selected.

Table 19 - Functionalities Available for 450L-B Safety Light Curtain

Description	Transmitter Plug-in		Receiver Plug-in				Universal Plug-in
	450L-APT-PW-5	450L-APT-PW-8	ON/OFF 450L-APR-ON-5	EDM 450L-APR-ED-8	Blanking 450L-APR-BL-5	Muting 450L-APR-MU-8	450L-APU-UN-8
Number of Connection Pins	5	8 ⁽¹⁾	5	8	5	8	8
Number of DIP Switches	0	0	4	8	8	8	12
Low Range Activation	—	—	X	X	X	X	X
Start Mode Selection	—	—	—	X	—	X	X
EDM	—	—	—	X	—	X	X
Transmitter and Receiver Functionality	—	—	—	—	—	—	X
Blanking	—	—	—	—	—	—	—
Muting	—	—	—	—	—	—	—
Beam Coding	—	—	—	—	—	—	—

(1) The 8-pin M12 for the transmitter is simply for the convenience of specifying two 8-conductor cordsets for the system.

Table 20 - Functionalities Available for 450L-E Safety Light Curtain

Description	Transmitter Plug-in		Receiver Plug-in				Universal Plug-in
	450L-APT-PW-5	450L-APT-PW-8	ON/OFF 450L-APR-ON-5	EDM 450L-APR-ED-8	Blanking 450L-APR-BL-5	Muting 450L-APR-MU-8	450L-APU-UN-8
Number of Connection Pins	5	8 ⁽¹⁾	5	8	5	8	8
Number of DIP Switches	0	0	4	8	8	8	12
Low Range Activation	—	—	X	X	X	X	X
Start Mode Selection	—	—	—	X	—	X	X
EDM	—	—	—	X	—	X	X
Transmitter and Receiver Functionality	—	—	—	—	—	—	X
Blanking	—	—	—	—	X	X	—
Muting	—	—	—	—	—	X	—
Beam Coding	—	—	—	—	X	X	X

(1) The 8-pin M12 for the transmitter is simply for the convenience of specifying two 8-conductor cordsets for the system.

The universal plug-in can be set to perform as an emitter or receiver. If pins four and eight of the connectors are short circuited at power-up, the stick behaves like a transmitter. In this case, the DIP switches have no functionality. Also the beam coding functionality is still set at the 450L-E Receiver (Rx). For the confirmation of the beam coding configuration and the pairing procedure, see [Confirmation of a New System Configuration on page 64](#). If pin four and pin eight of the plug-in are not short circuited at power-up, the corresponding stick behaves like a receiver. In this case, the DIP switches have the same functionality as the 450L-APR-ED-8 receiver plug-in.

Receiver Plug-in DIP Switch Settings

The transmitter plug-ins and the cascading plug-ins don't have DIP switches.

Identify and set the appropriate DIP switches for the configuration desired. DIP switch identification is shown in [Figure 30](#). The number of DIP switches varies depending on the plug-in type.

Figure 30 - DIP Switch Location at Receiver Plug-in



IMPORTANT DIP switches must be switched to OFF if the Switch Function is not defined. Otherwise, an error condition occurs (see [Status Indicator Error Display on page 116](#)).

After each reconfiguration of a safety light curtain, test the system for proper configuration and operation before placing the guarded machine in operation.



ATTENTION: Every modification of the DIP switches must be confirmed with a configuration confirmation procedure after the first power-up (see [Confirmation of a New System Configuration on page 64](#)).

After installing the plug-in on the 450L-B transmitter stick and power-up, a configuration confirmation can be performed (signaled by the red/ green blinking of the STS status indicator). The confirmation of the configuration can be performed without receiver and transmitter aligned.

[Table 21](#)...[Table 27](#) describe the switch functions and default settings for the receiver plug-ins.

450L-APR-ON-5 Connection Plug-in

Table 21 - Function and Default Settings

Switch Number	Switch Function	Default	Description
1	—	OFF	—
2	Low Range Activation	OFF	OFF: Disabled ON: Enabled
3	450L-E only: Activates Beam Coding	OFF	OFF: Deactivated ON: Activated
4	—	OFF	—

450L-APR-ED-8 Connection Plug-in

Function and default settings for the M12 8-pin EDM receiver plug-in (450L-APR-ED-8) inserted in a 450L transceiver stick 450L-APR-BL-5 connection plug-in are shown in [Table 22](#).

Table 22 - Function and Default Settings

Switch Number	Switch Function	Default	Description
1	—	OFF	—
2	Low Range Activation	OFF	OFF: Disabled ON: Enabled
3	450L-E only: Activates Beam Coding	OFF	OFF: Disabled ON: Enabled
4	—	OFF	—
5	Combination activates the following start modes: <ul style="list-style-type: none"> • Automatic start • Manual (re) start • Manual cold start • Manual start with off function 	OFF	<ul style="list-style-type: none"> • DIP 5: OFF, DIP 6: OFF: Automatic start (Default) • DIP 5: ON, DIP 6: OFF: Manual (re) start • DIP 5: OFF, DIP 6: ON: Manual cold start • DIP 5: ON, DIP 6: ON: Manual start with off function
6		OFF	
7	External Device Monitoring	OFF	OFF: Disabled ON: Enabled
8	—	OFF	—

450L-APR-BL-5 Connection Plug-in

The function and default settings for the M12 5-pin blanking receiver (450L-APR-BL-5) plug-in that is inserted in a 450L transceiver stick are shown in [Table 23](#).

Table 23 - Function and Default Settings

Switch Number	Switch Function	Default	Description
1	—	OFF	—
2	Low Range Activation	OFF	OFF: Disabled ON: Enabled
3	Activates Beam Coding	OFF	OFF: Disabled ON: Enabled
4	—	OFF	—
5	450L-E only Teach-in Blanking	OFF	OFF: Disabled ON: Enabled
6	450L-E only Combination activates the following start modes: <ul style="list-style-type: none"> • No reduced resolution • Reduced resolution 1 lens • Reduced resolution 2 lenses 	OFF	<ul style="list-style-type: none"> • DIP 6: OFF, DIP 7: OFF: Reduced resolution disabled (Default) • DIP 6: OFF, DIP 7: ON: Reduced resolution 2 beam • DIP 6: ON, DIP 7: OFF: Reduced resolution 1 beam • DIP 6: ON, DIP 7: ON: Invalid selection (error)
7		OFF	
8	—	OFF	—

450L-APR-MU-8 Connection Plug-in

[Table 24](#) shows the function and default settings for the M12 8-pin muting receiver plug-in (450L-APR-MU-8) inserted in a 450L transceiver stick.

Table 24 - Function and Default Settings

Switch Number	Switch Function	Default	Description
1	—	OFF	—
2	Low Range Activation	OFF	OFF: Disabled ON: Enabled
3	450L-E only Activates Beam Coding	OFF	OFF: Disabled ON: Enabled
4	—	OFF	—
5	Combination activates one of the following start modes: <ul style="list-style-type: none"> • Automatic start • Manual (re)start • Manual cold start • Manual start with off function 	OFF	<ul style="list-style-type: none"> • DIP 5: OFF, DIP 6: OFF: Automatic start (Default) • DIP 5: ON, DIP 6: OFF: Manual (re)start • DIP 5: OFF, DIP 6: ON: Manual cold start • DIP 5: ON, DIP 6: ON: Manual start with off function
6		OFF	
7	External Device Monitoring	OFF	OFF: Disabled ON: Enabled
8	450L-E only Muting or Blanking	OFF	OFF: see blanking modes in Table 25 on page 63 ON: see muting modes in Table 26 on page 63

For 450L-E light curtain only: If DIP 8 is set to OFF: blanking can be activated and DIP 9 to DIP12 provide a selection of different blanking configurations, see [Table 25](#).

If pin 8 is set to ON: Muting muting is activated and DIP 9 to DIP 12 a selection of different muting configurations, see [Table 26 on page 63](#).

[Table 25](#) shows the function and default settings for the M12 8-pin muting receiver plug-in (450L-APR-MU-8) inserted in a 450L-E transceiver stick; DIP 8 = OFF.

Table 25 - Function and Default Settings

Switch Number	Switch Function	Default	Description
9	450L-E only Teach-in blanking	OFF	OFF: Disabled ON: Enabled
10	Combination activates one of the following configurations: <ul style="list-style-type: none"> No reduced resolution Reduced resolution 1 lens Reduced resolution 2 lenses 	OFF	<ul style="list-style-type: none"> DIP 10: OFF, DIP 11: OFF: Reduced resolution disabled (Default) DIP 10: ON, DIP 11: OFF: Reduced resolution 1 beam DIP 10: OFF, DIP 11: ON: Reduced resolution 2 beams DIP 10: ON, DIP 11: ON: Invalid selection (error)
11		OFF	
12	—	OFF	—

[Table 26 on page 63](#) shows the function and default settings for the M12 8-pin muting receiver plug-in (450L-APR-MU-8) inserted in a 450L-E transceiver stick; DIP 8 = ON.

Table 26 - Function and Default Settings

Switch Number	Switch Function	Default	Description
9	450L-E only Combination activates one of the following muting configurations:	OFF	<ul style="list-style-type: none"> DIP 9: OFF, DIP 10: OFF, DIP 11: OFF No muting DIP 9: OFF, DIP 10: ON, DIP 11: OFF 2L muting sensors connected to connection plug-in DIP 9: OFF, DIP 10: ON, DIP 11: ON 2L muting sensors connected to I/O cascading plug-in DIP 9: ON, DIP 10: OFF, DIP 11: OFF 2T muting sensors connected to connection plug-in DIP 9: ON, DIP 10: OFF, DIP 11: ON 2T muting sensors connected to cascading plug-in DIP 9: ON, DIP 10: ON, DIP 11: ON 4T muting sensors connected to cascading plug-in
10		OFF	
11		OFF	
12	—	OFF	—

450L-APR-UN-8 Connection Plug-in

Table 27 shows the function and default settings for the M12 8-pin muting receiver plug-in (450L-APR-UN-8) inserted in a 450L transceiver stick.

Table 27 - Function and Default Settings

Switch Number	Switch Function	Default	Description
1	—	OFF	—
2	Low Range Activation	OFF	OFF: Disabled ON: Enabled
3	450L-E only Activates Beam Coding	OFF	OFF: Disabled ON: Enabled
4	—	OFF	—
5	Combination activates one of the following start modes: <ul style="list-style-type: none"> • Automatic start • Manual (re)start • Manual cold start • Manual start with off function 	OFF	<ul style="list-style-type: none"> • DIP 5: OFF, DIP 6 OFF: Automatic start (Default) • DIP 5: ON, DIP 6 OFF: Manual (re)start • DIP 5: OFF, DIP 6 ON: Manual cold start • DIP 5: ON, DIP 6 ON: Manual start with off function
6		OFF	
7	External Device Monitoring	OFF	OFF: Disabled ON: Enabled
8	—	OFF	—
9	—	OFF	—
10	—	OFF	—
11	—	OFF	—
12	—	OFF	—

For the UNIV plug-in, if pin four and pin eight are short circuited (transmitter mode), the DIP switch settings have no impact on the transmitter functionality.

Confirmation of a New System Configuration

IMPORTANT The confirmation procedure is not required when the receiver stick is operated the first time (brand new receiver). The STS status indicator flashes red/green when a confirmation is required.

Confirmation of a system configuration needs only be performed when the receiver stick was previously operated with another configuration or when the receiver stick was previously operated with another transmitter.

If the receiver plug-in is exchanged with a new plug-in with the same plug-in type and DIP switch settings as the original one, no confirmation procedure is required.

Also, no configuration confirmation procedure is required for a complete pair of 450L transceiver sticks out-of-the-box.

Perform a confirmation procedure of a new configuration when you reinsert the plug-in to the light curtain stick with a changed DIP switch setting. The request for such a confirmation is displayed via a 1 Hz red/green blinking STS status indicator ([Figure 31](#)).

This process has to be performed only once, after the first powerup of a plug-in with new settings. It is not required at any following powerup (only when DIP switches are changed again).

Figure 31 - Position of Optical Push Button and Status Indicator

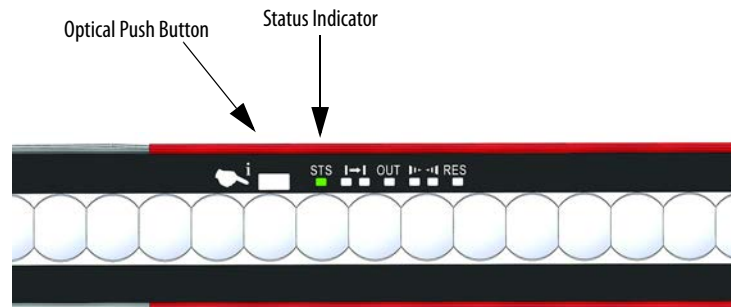

Confirmation

[Figure 32](#) shows the configuration timing sequence. The optical push button must be activated two times for 5 seconds. Between the two activations, a break of a maximum of 2 seconds is allowed.

Figure 32 - Configuration Process

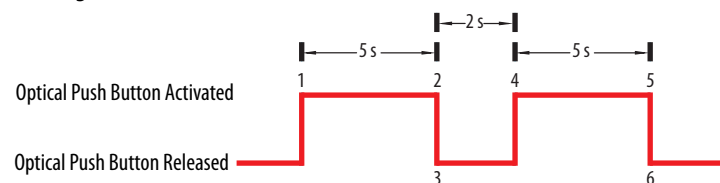

Confirmation Procedure

To confirm a new configuration, follow these steps:

1. The status indicator STS blinks green/red (1 Hz, one time red, and one time green per second, 50:50 duty cycle) which indicates that the stick is in the configuration mode.
2. Actuate optical push button for 5 seconds.
3. STS blinks green/red to indicate actuation with a frequency of 10 Hz and 50:50 duty cycle.
4. As soon as status indicator STS changes from green/red to green/off, release the optical push button.
5. Release is indicated with a change of frequency of 10 Hz to 1 Hz (status indicator STS green/off and a 50:50 duty cycle).
6. Within 2 seconds, actuate the optical push button.
7. Status indicator STS indicates the activation by a new green/red frequency of 10 Hz and a 50% duty cycle.
8. Actuate the optical push button for 5 seconds.

9. As soon as the status indicator changes from green/red blinking to green/off blinking, release.
10. After releasing, the status indicator STS is solid green.

If any error occurs in this procedure, the new configuration is not stored and the STS-indicator starts blinking again (1 Hz, green/red, and 50:50 duty cycle). For example:

- If the actuator is released before the 5 seconds,
- It is not actuated within the 2 seconds thereafter.

IMPORTANT Once the configuration confirmation procedure is completed, verify that the operating mode has changed to the intended configuration.

Installation and Wiring



ATTENTION: The GuardShield™ safety light curtain must not be used with machines that cannot be stopped electrically in an emergency.

The required safety distance (see [Determine the Safety Distance on page 68](#)) between the GuardShield safety light curtain and dangerous machine movement always has to be maintained.

Additional mechanical protective devices have to be installed if hazardous machine elements can be reached without passing through the protective field. Improper installation can result in serious injury.

Never connect the safety outputs (OSSDs) to +24V DC. If the safety outputs are connected to +24V DC, they are in the ON-state and cannot stop hazardous machine/application movements.

Never expose the GuardShield safety light curtain to flammable or explosive gases. Do not install GuardShield safety light curtains in outdoor or underwater applications without additional measures.

Regular safety inspections are imperative (see maintenance).

Do not open or attempt to repair or modify the GuardShield safety light curtain. Removal of either of the gray GuardShield safety light curtain end caps or the transparent front window voids the warranty terms of this product.



LASER LIGHT CLASS 2 HAZARD: Do not stare into beam.

The 450L-E GuardShield safety light curtains are equipped with an integrated laser alignment aid (see [Laser Alignment on page 20](#)).

IMPORTANT Do not insert or remove plug-ins when power is applied to the plug-in.

The GuardShield safety light curtain must be used only as defined in the [Range of Use on page 21](#).

If the device is used for any other purposes or modified in any way, warranty claims against Rockwell Automation become null and void.

Installation must be in accordance with this manual and implemented by qualified personnel exclusively.

A GuardShield safety light curtain system is intended to be part of the safety-related control system of a machine. Before installation, a thorough risk assessment has to be performed to determine whether the specifications of this device are suitable for all foreseeable operational and environmental characteristics of the application.

See [Specifications on page 127](#) for certification information and ratings. The requirements that are defined in this appendix, for example, power supply, cables, and ambient conditions, must be observed and maintained to allow the safety function.

Use appropriate screws, bolts, and/or nuts to mount the sticks and plug-ins to avoid damage.

Do not over-torque the mounting hardware:

- The required screwdriver type for installation of the plug-ins is a Phillips tip screwdriver for M2 x 8 Phillips screw. Maximum torque is 0.38 N•m (3.36 lb•in).
- The required screwdriver type for installation of the standard top/ bottom mounting kit is a Phillips tip screwdriver for M3 x 10 Phillips DIN 965 A screw. Maximum torque is 0.7 N•m (6.19 lb•in).

Only use the designated mounting holes of the mounting bracket.

Use only fixed, stable, and sturdy mounting posts or frames to mount a 450L-B GuardShield safety light curtain system.

For the installation of the plug-ins, see [Electrical Installation on page 88](#).

Determine the Safety Distance

The light curtain must be mounted with proper safety distance:

- From the point of danger
- From reflective surfaces.

To help prevent a person from reaching through the protective field to a dangerous area (while the machine is still moving), both points must be considered in an installation.

The calculation of point one varies depending on the region (country) where it is operated.

U.S. Safety Distance Formula

This distance, referred to as the safety distance, must be properly calculated before determining the safety light-curtain protective height and mounting the light curtains on the machine. Failure to calculate this safety distance properly can result in operator injury.



ATTENTION: The GuardShield safety light curtains must be mounted at a sufficient distance from the pinch point or point of operation hazard. This distance helps confirm that the machine stops before a finger, hand, arms, or body reach the hazard.

Regardless of the calculated safety distance, the protective field of a GuardShield safety light curtain is never mounted closer than 152.4 mm (6 in.) from the point of operation to the pinch point hazard.

In the United States, two formulas are commonly used to calculate the safety distance.

- The OSHA formula is the minimum requirement for the calculation of the safety distance.
- The ANSI formula, the formula we recommend, incorporates additional factors to be considered when calculating the safety distance.

OSHA Safety Distance Formula

The OSHA safety distance formula as specified in CFR29 Subpart O1910.217 is as follows:

$$D_s = 63 \times T$$

D_s	Safety Distance in inches (1 in. = 25.4 mm)
63	Is the OSHA recommended hand speed constant in inches per second (63 in./sec = 1600 mm/sec)
T	Is the total stop time of all devices in the safety circuit, which is measured in seconds. This value must include all components that are involved to stop the hazardous motion of the machinery. For a mechanical power press, it is the stopping time that is measured at approximately the 90° position of the crankshaft rotation.

IMPORTANT The T number must include the response times of all devices, including the response time of the safety light curtain, the safety light curtain controller (if used), the machine control circuit, and any other devices that react to stop the hazardous motion of the machinery. Not including the response time of a device or devices in the stop time calculation results in insufficient safety distance for the application, which results in operator injury.

ANSI Safety Distance Formula

The ANSI B11.19 safety distance formula, which is the formula we recommend for USA, is as follows:

$$D_s = K \times (T_{st} + T_c + T_t + T_{bm}) + D_{pf}$$

- D_s Minimum safety distance between the safe guarding device and the nearest point of operation hazard (in inches).
- K Hand-speed constant in inches per second. The ANSI standard value is 63 inches per second when the operator begins reaching toward the point of operation hazard from rest.

IMPORTANT ANSI B11.19 1990 E4.2.3.3.5 states “The value of the hand-speed constant, K , is determined in various studies. Although these studies indicate speeds of 63 inches/second to over 100 inches/second, they are not conclusive. The employer can consider all factors, including the physical ability of the operator, when determining the value of K to be used.”

- T_{st} Stop time of the machine tool that is measured at the final control element.
- T_c Response time of the control system
- T_t Response time of the presence sensing device (safety light curtain) and its interface, if any. The device manufacturer states this value or you can measure it.

IMPORTANT A stop time device is used to measure $T_{st} + T_c + T_r$.

- T_{bm} Additional time that is allowed for the brake monitor to compensate for variations in normal stop time.
- D_{pf} Depth penetration factor. It is an added distance to allow for how far into the protective field an object, such as a finger or hand, can travel before being detected. D_{pf} is related to the safety light-curtain object sensitivity. Object sensitivity is the smallest diameter object that is detected anywhere in the sensing field (commonly also known as resolution).

Example for Dpf

The Dpf can be approximated in a perpendicular safety-light curtain application with object sensitivity (effective resolution) less than 63.5 mm (2.5 in.):

$Dpf \text{ (inches)} = 3.4 \times (\text{Object Sensitivity [inch]} - 0.276 \text{ [inch]})$, but not less than 0.

Table 28 - Depth of Penetration Factor

Description	Depth Penetration Factor
Finger resolution (14 mm [0.56 in.])	23.7 mm (0.935 in.)
Hand resolution (30 mm [1.19 in.])	78.1 mm (3.077 in.)

European Safety Distance Formula

A safety distance must be maintained between the light curtain and the point of danger (Figure 35 on page 73), as described in IEC/TS 62046. This safety distance helps confirm that the point of danger can only be reached after the dangerous state of the machine has been removed.

The safety distance as defined in EN ISO 13855 and EN ISO 13857 depends on:

- Machine stop time
- Response time of the protective device (safety light curtain + control circuit)
- Resolution of the safety light curtain
- Approach speed to the danger point
- Position of the AOPD

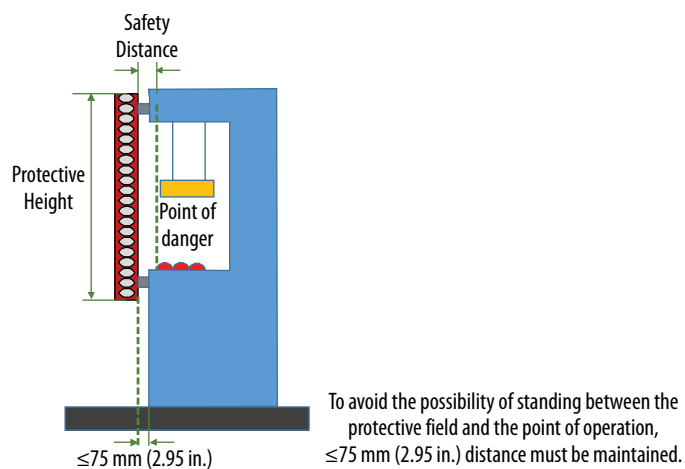
Figure 33 - Safety Distance from the Point of Danger to the Light Curtain

How to calculate the Safety Distance (S) according to EN ISO 13855 and EN ISO 13857:

- First, calculate S use the following formula:

$$S = 2000 \text{ [mm/s]} \times T + 8 \times (d - 14) \text{ [mm]}$$

Where:

- T = Stopping/run-down time of the machine [s] + response time T_t of the safety light curtain [s] + response time of the control circuit [s]
- d = Resolution of the light curtain [mm]
- S = Safety distance [mm]

The reach/approach speed is already included in the formula.

- If the result S is ≤ 500 mm (19.6 in.), then use the determined value as the safety distance.
- If the result S is > 500 mm (19.6 in.), then recalculate S as follows: $S = 1600 \times T + 8 \times (d - 14)$ [mm]
- If the new value S is > 500 mm (19.6 in.), then use the newly determined value as the minimum safety distance.
- If the new value S is ≤ 500 mm (19.6 in.), then use 500 mm (19.6 in.) as the safety distance.

Example:

Stopping/run-down time of the machine = 290 ms

Response time safety-light curtain $T_t < 20$ ms

Response time of the control circuit = 10 [ms]

$T = 290 \text{ [ms]} + 20 \text{ [ms]} + 10 \text{ [ms]} = 320 \text{ [ms]} = 0.32 \text{ [s]}$

Resolution of the light curtain = 14 mm (0.56 in.)

$S = 2000 \times 0.32 + 8 \times (14 - 14) = 640 \text{ mm (25.1 in.)}$ $S > 500$ mm, therefore:

$S = 1600 \times 0.32 + 8 \times (14 - 14) = 512 \text{ mm (20.1 in.)}$

[Figure 33 on page 71](#) also indicates the distance to avoid standing behind the safety light curtain. If the light curtain is installed more than 75 mm (2.95 in.) from the machine:

- With auto restart
- Where the dangerous area is not visible from the Reset button more protective measures must be considered (for example, an additional horizontal installed light curtain).

Minimum Distance from Reflective Surfaces

The infrared light that is transmitted from the two transceivers can be reflected off shiny surfaces. If this condition occurs, it can result in an object not being detected when it enters the GuardShield safety light curtain sensing field.

All reflecting surfaces and objects (for example, material bins) must, therefore, be at a minimum distance A from the protective sensing field of the system. The minimum distance A depends on the distance (D) between the two transceivers.

Figure 34 - Minimum Distance A from Reflective Surfaces (Top View)

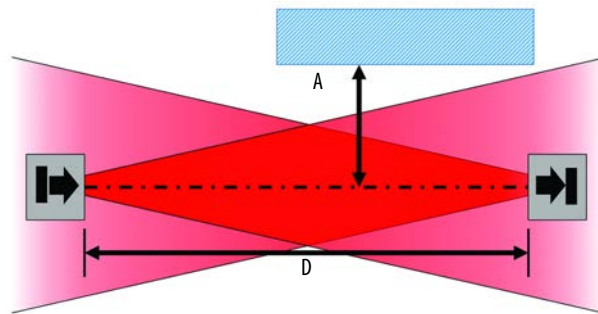
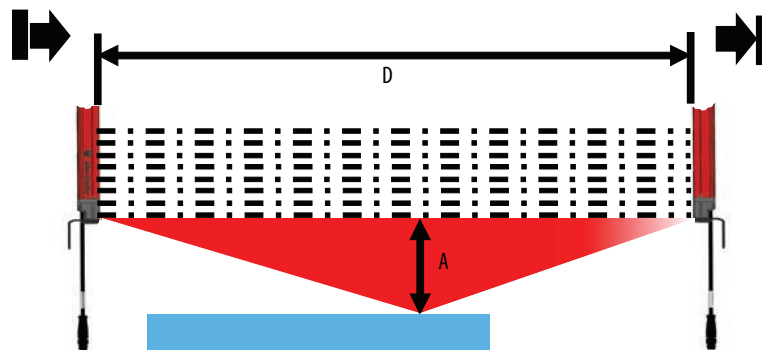

Figure 35 - Minimum Distance A from Reflective Surfaces (Side View)



The minimum distance from the reflective surfaces can be determined as follows:

- Determine the distance D [m] between transmitter and receiver
- Read the minimum distance A [mm] from the graph:

Figure 36 - Minimum Distance A from Reflective Surfaces (D= Distance between Receiver and Transmitter)

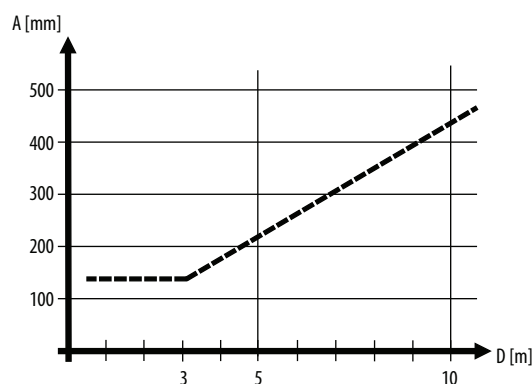

The effective aperture angle for the 450L-B safety light curtain system is $\pm 2.5^\circ$ at a mounting distance of ≥ 3.0 m (9.8 ft). Calculate the minimum distance to reflective surfaces depending on the distance between the transmitter and the receiver, with an aperture angle of 2.5° .

IMPORTANT Formula: $A \text{ [mm]} = \tan 2.5^\circ \times D = 43.7 \times D \text{ [m]}$
 A = Minimum distance to reflective surfaces
 D = Distance between transmitter and receiver Or take the appropriate value from [Table 29 on page 74](#).

Table 29 - Minimum Distance for Various Distances D Between Transmitter and Receiver

Distance between Transmitter and Receiver (Range D) [m (ft)]	Minimum Distance A [mm (in.)]
0.5 ... 3.0 (1.64 ... 9.8)	135 (5.31)
4.0 (13.1)	175 (6.88)
5.0 (16.4)	220 (8.66)
6.0 (19.6)	265 (10.43)
7.0 (22.9)	310 (12.2)
10.0 (32.8)	440 (17.32)

Mirrors

The GuardShield safety light curtains can be used with corner mirrors (see [Corner Mirror on page 198](#)). Mirrors are only allowed for applications without undetected access into the protected area.

Figure 37 - Installation Angle for Mirrors (View from the Top)

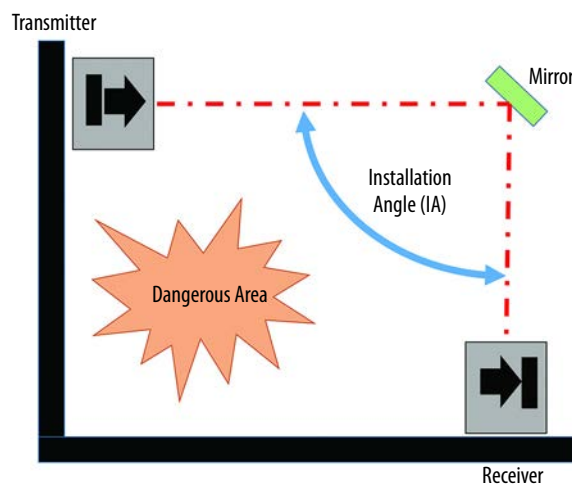

ATTENTION: When using mirrors, all sides of the protective field have to fulfill the requirements for minimum safety distance and minimum distance from the reflective surfaces.

The installation angle (IA) must be between $70^\circ < IA < 110^\circ$ otherwise serious injury or death could result.

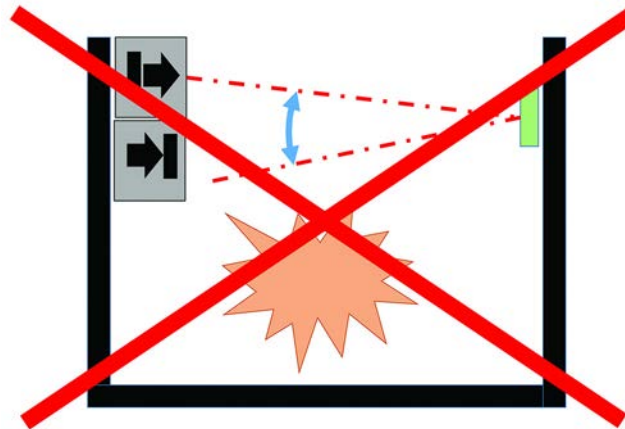
Figure 38 - Possible Misuse of a Mirror

Install and Mount

This section describes the preparation, selection, and installation of the GuardShield safety light curtain system.

- A GuardShield safety light curtain system can be used in all mounting orientations.
- The GuardShield safety light curtain has two status indicators in each stick to display the status of the intensity ([Figure 39](#)). One status indicator refers to the first half of the protective field, the other status indicator to the second half of the protective field. These status indicators begin to flash green when the receiver sees the infrared light from the transmitter. The status indicators turn solid green when optimal alignment is attained. These two status indicators can be used as an alignment aid.

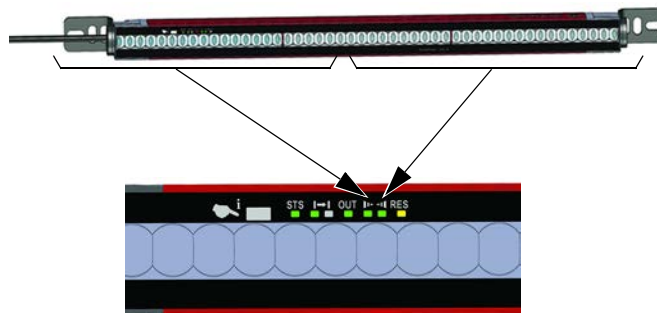
Figure 39 - Status Indicators to Display Intensity

- Mount both sticks so that the distance of the protective field is at or greater than the calculated safety distance (see [Determine the Safety Distance on page 68](#)).
- Mount both sticks away from any reflective surfaces (see [Figure 34 on page 73](#)).
- They must be parallel to each other and be positioned at the same height. The transmitter and receiver connection plug-in locations must point in the same direction ([Figure 40](#)).

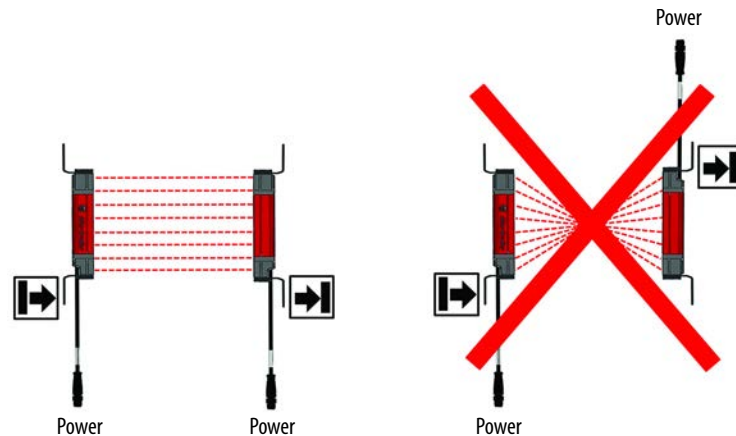
Figure 40 - Correct Positioning and Incorrect Positioning of Transmitter and Receiver Sticks

- The optical lens system of transmitter and receiver stick must be in exact opposition to each other.
- Take suitable measures to attenuate vibration.
- The safety light curtain must be mounted such that the hazardous point cannot be reached from below, above, or behind the safety light curtain and that the light curtain cannot be repositioned (see [Correct Installation on page 77](#) and [Incorrect Installation on page 78](#)).
- Connect both sticks.
- Turn on power to the GuardShield safety light curtain system.
- If the STS status indicator at the receiver stick displays a configuration change (blinking red/green), confirmation is required to proceed with [Confirmation of a New System Configuration on page 64](#).
- Rotate the transmitter and receiver sticks while watching the two status indicators on the sticks. Find the point where the two indicators for the intensity state illuminate to a solid green condition.
- Determine the maximum left and right adjustment angles and position each unit in the center. Tighten all hardware until the alignment (intensity) indicators are not blinking.
- Cycle power to confirm that the system powers up, goes to the ON state (STS status indicator solid green) and the intensity status indicators indicate solid green.

An external laser alignment tool (440L-ALAT) and a dedicated mounting bracket (450L-ALAT-C) are offered as accessories (see [Alignment Tool and Bracket on page 202](#)). Use these items for aligning the 450L-B safety light curtain for larger operating distances or when corner mirrors are used in the application.

IMPORTANT If EDM or manual start functions are configured through DIP switch settings, confirm that the proper receiver wire connections are made.

The minimum operating distance must always be followed (see [Table 71 on page 189](#)). Stable operation cannot be guaranteed when operating under this specified value. When the transmitter and the receiver stick are positioned closer than specified, it results in an interruption of the protective field and switches off the two OSSDs.

IMPORTANT We recommend that you only use the mounting brackets that we offer. Take appropriate measures to dampen vibration if the vibration and shock requirements are above the specified values and test conditions.

Correct Installation

Figure 41 - Operators Cannot Reach Hazardous Machine Parts without Passing Through the Protective Field

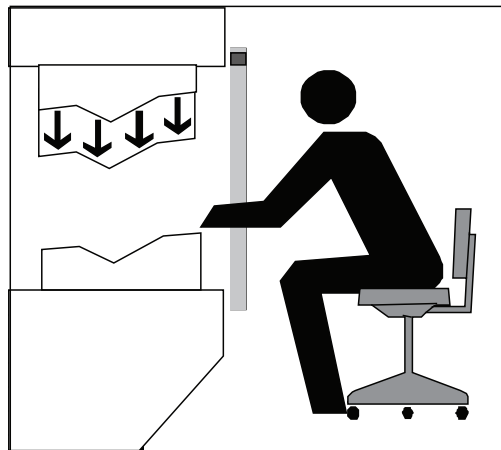

ATTENTION: The installation of the GuardShield safety light curtain must be such that access to the hazard is only possible through the sensing field of the GuardShield safety light curtain. Auxiliary safe guarding can be required with the GuardShield safety light curtain to meet this requirement.

Figure 42 - Operators Must Not Step between Protective Field and Hazardous Machine Parts (Pass Through Prevention)

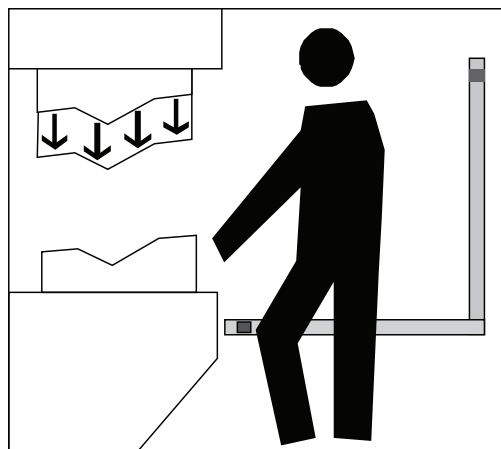

Incorrect Installation

Figure 43 - Operators Can Reach Hazardous Machine Parts without Passing Through the Protective Field

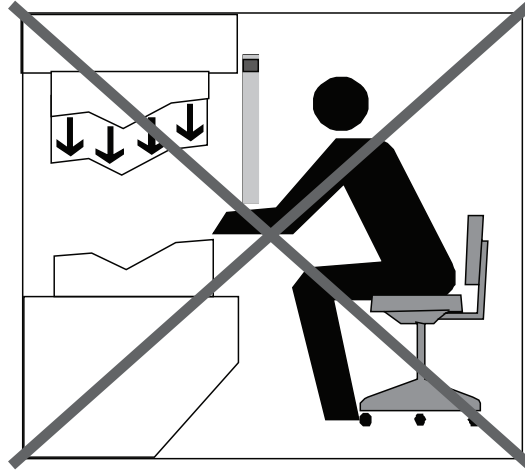
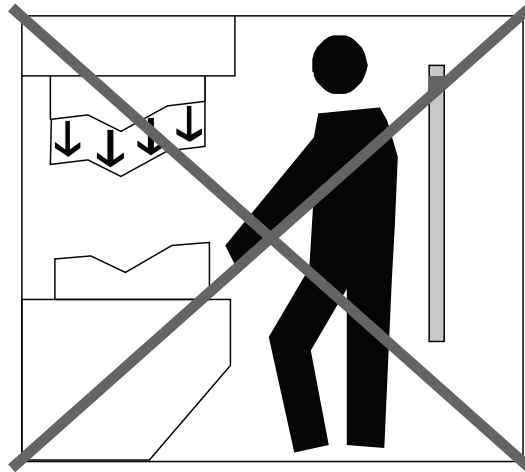
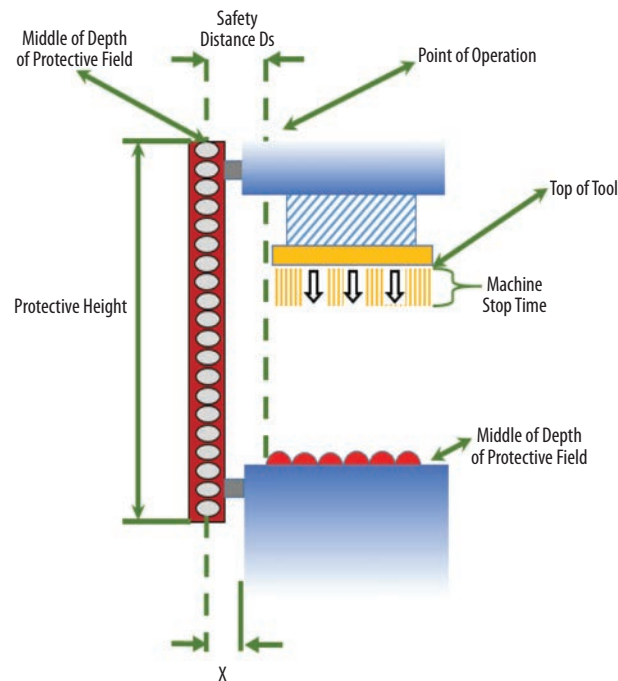

Figure 44 - Operators Can Step between Protective Field and Hazardous Machine Parts



The GuardShield safety light curtain must be mounted at the proper distance from the point of operation hazard. This distance is referred to as the safety distance. If the safety distance calculation is such that a person can step between a vertically mounted safety light curtain and the machine hazard, more protective measures are required.

Figure 45 - Terms to Help Define Safety Distance to Avoid the Possibility of Standing between the Protective Field and the Point of Operation



IMPORTANT Confirm that an operator is not able to stand between the protective field and the point of operation (hazard). EN ISO 13855 requires a minimum distance X at an installation height of 300 mm (11.9 in.). Check EN ISO 13855 for other installation heights.

Mount Multiple 450L GuardShield Safety Light Curtains

When two or more 450L safety light curtain pairs are mounted closely, the following possibilities can happen:

1. Optical interference: The receiver of one pair “sees” sporadically infrared light from the transmitter of another pair. Optical interference between neighboring 450L safety light curtain systems can affect light curtain system reliability by sporadic switching offs of the OSSDs.
2. Optical crosstalk (see [Figure 47 on page 80](#)): The receiver of one pair communicates continuously with the transmitter of another pair. Optical crosstalk between neighboring 450L safety light curtain systems cause holes in the protective field and is therefore an unsafe installation. Optical crosstalk can only occur if:
 - a. Both systems have the same resolution and the same height of the protective field.
 - b. The height of the protective field is smaller than the minimum separation distance S provided in [Table 14 on page 50](#).
 - c. The space between both pairs is smaller than the minimum separation distance S provided in [Table 14 on page 50](#).



ATTENTION: Cross talking between adjacent installed pairs can cause an unsafe situation.

Measures to avoid optical interference or optical cross talk are:

1. Minimum installation distance S between adjacent installed pairs (see [Table 14 on page 50](#)).
2. Installation of optical barriers (see [Figure 48 on page 81](#)).

For 450L-E safety light curtains, a measure to help prevent optical cross talk is also the beam code function (see [Beam Coding on page 30](#)). The beam code function helps prevent optical cross talking. It also reduces the probability for optical interferences but it does not fully stop them.

Figure 46 - Two Adjacent Installed Pairs without Optical Crosstalk

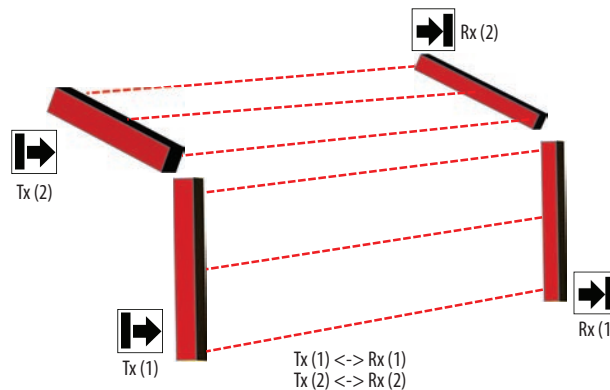
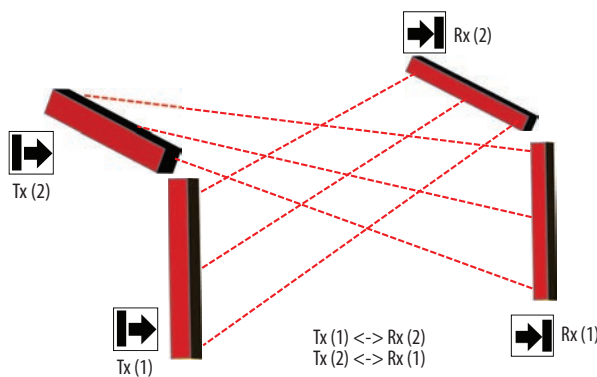

Figure 47 - Two Adjacent Installed Pairs with Optical Crosstalk



[Figure 48 on page 81](#) shows a number of installation techniques to stop optical interference or optical crosstalk between adjacent light curtains.

- Check that the maximum operation range can be reduced (see [Low Operating Range on page 29](#)).
- Install mechanical (optical) barriers to help prevent optical interference ([Figure 48](#)).

- For 450L-E only: Check if the beam code feature is a possible option (see [Beam Coding on page 30](#)).

Figure 48 - Optical Barriers (Ob) Are Required for Adjacent Light Curtains Installations

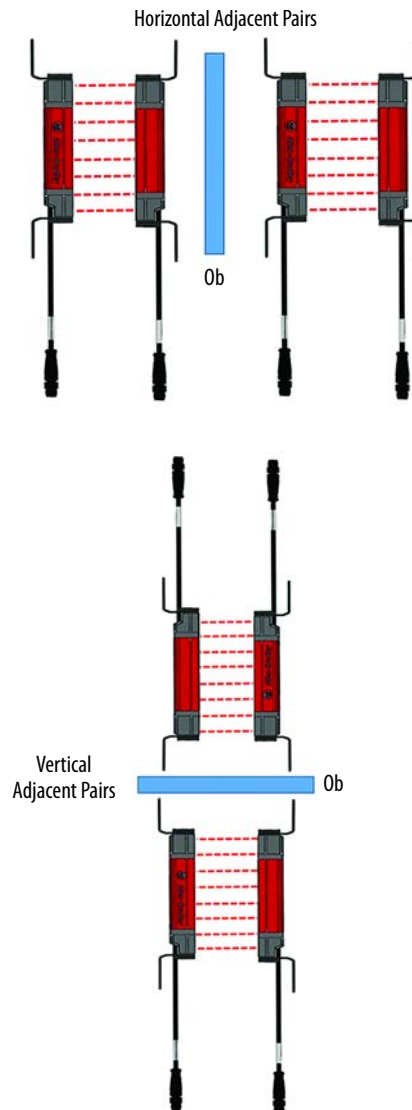

The transceiver architecture of safety light curtains does not allow a back-to-back installation of adjacent transmitters as is common with safety light curtain systems with a pure transmitter and receiver architecture.

Depending on the installed distance, the reduced operating functionality (see [Low Operating Range on page 29](#)) instead of an optical barrier can be used to stop optical interference of adjacent GuardShield safety light curtain systems.

For 450L-E safety light curtains only: To stop optical interference between neighbor 450L-E systems can cause a safety issue, in addition of an optical barrier the beam code feature (see [Beam Coding on page 30](#)) can be selected. Beam code changes the pulse pattern of infrared light that a 450L-E safety light curtain stick emits.

Mounting Brackets

Standard Top/Bottom Mounting Kit

The GuardShield safety light curtain can be mounted using right angle brackets that are attached to the end caps of both the transmitter and receiver sticks. A pair of end cap mounting brackets are supplied with each stick.

The required screwdriver type for installation of the standard top/bottom mounting kit is a Phillips screwdriver for M3 x 10 Phillips DIN 965 A screw. The maximum torque cannot be above 0.7 N•m (6.19 lb•in) otherwise the light curtain could become damaged.

The top/bottom mounting kit allows a rotation of $\pm 20\%$ of the GuardShield safety light curtain aluminum profile.

The length of the transceiver stick and the vibration and shock conditions of the application often require use of additional side mounting brackets.

Figure 49 - Standard Mounting Bracket Kit, Which Is Supplied with Each Stick (Catalog Number 450L-AM-TBM: Contains Two Brackets for One Stick)

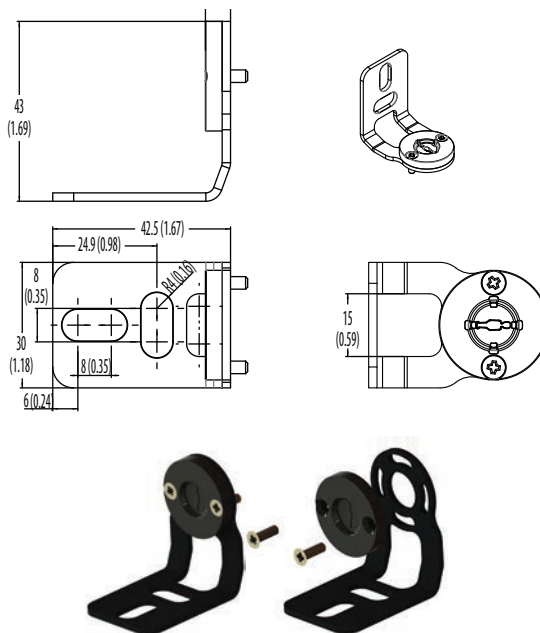

Two M6 DIN 912 screws (not provided) are required for proper mounting of each stick.

Photos that are shown in [Figure 50 on page 83](#) present different cable guide options. The bend radius of the plug-in pig tail cable is small enough so that the cable can be routed at a 90° angle. The minimum bend radius is specified in [Table 77 on page 192](#).

Figure 50 - Connection Cable Guide Options



[Figure 51](#) and [Figure 52](#) show possible mounting when attaching to extruded aluminum profiles.

Figure 51 - 450L Safety Light Curtain Mounted on an Extruded Aluminum Profile Using the Standard Top/Bottom Mounting Bracket



Figure 52 - 450L Safety Light Curtain Mounted Backwards on an Extruded Aluminum Profile Using the Standard Top/Bottom Mounting Bracket

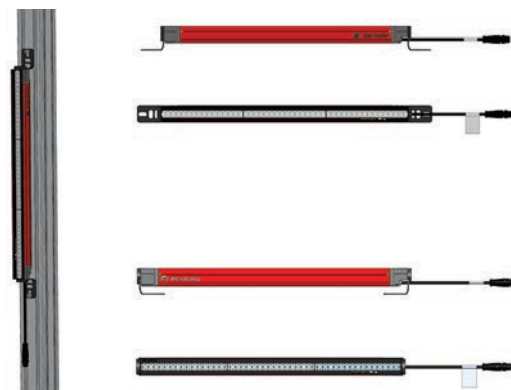

Side Mounting Bracket

The side mounting clamp allows a rotation of the snapped in GuardShield safety light curtain profile of $\pm 5^\circ$ (Figure 53).

Figure 53 - Dimensions of the Side Mounting Bracket 450L-AM-SM (Contains Two Brackets)

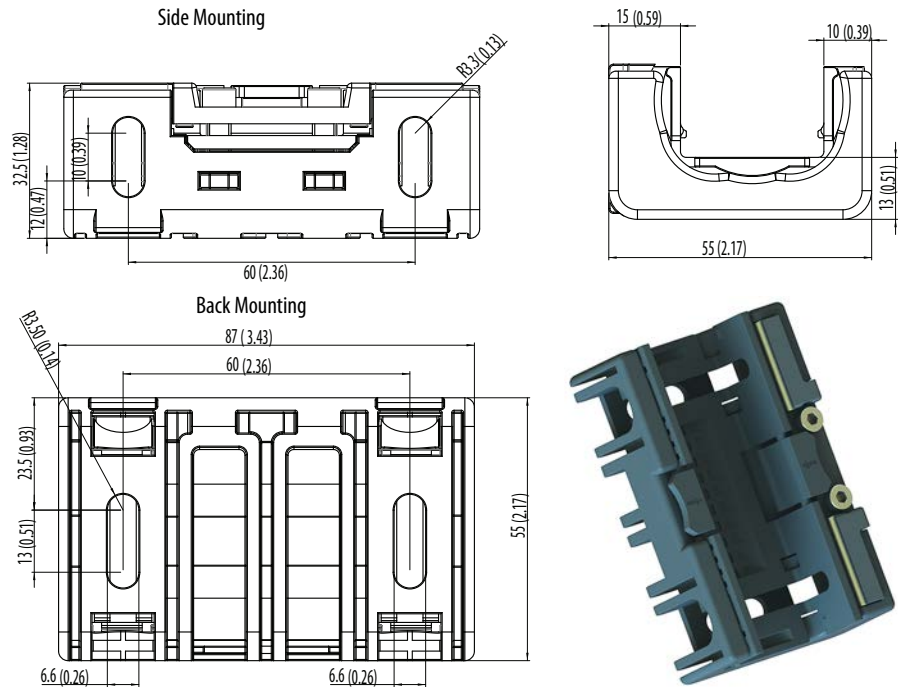
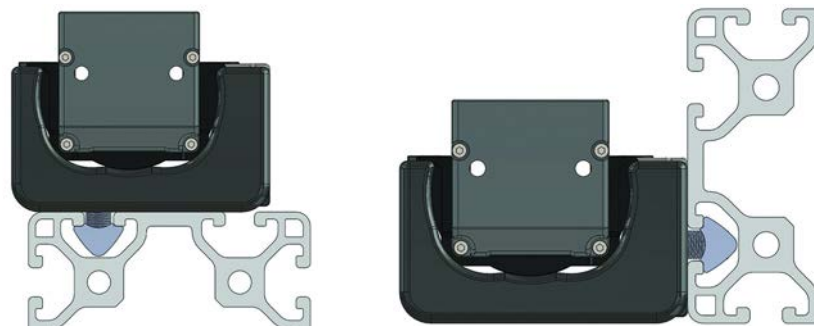

Figure 54 - 450L Safety Light Curtain Snapped in a Side Mounting Kit



Figure 55 - 450L Safety Light Curtain Mounted on an Extruded Aluminum Profile Using Side-mount Bracket Kit (450L-AM-SM: Contains Two Brackets)



Two M6 DIN 912 screws (not provided) are required (minimum) for proper mounting of each clamp.

IMPORTANT Use side mounting brackets and, or instead of, the top/bottom mounting kits in vibration applications.

Use additional side mounting brackets in vibration applications for protective heights of 1050 mm (41.3 in.) and larger. Position and mount the additional bracket in the middle of each stick.

Table 30 - Number of Side Mounting Brackets without Top/Bottom Brackets

Stick Length	Number of Side Mounting Brackets Per Stick
150 mm (5.9 in.)	1
300...900 mm (11.8...35.43 in.)	2
1050...1950 mm (41.34...76.77 in.)	2 (3 for vibration applications)

Table 31 - Number of Side Mounting Brackets and Top/Bottom Brackets

Stick Length	Number of Side Mounting Brackets Per Stick
150...900 mm (5.9...35.43 in.)	0
1050...1950 mm (41.34...76.77 in.)	1 for vibration applications

The required screwdriver type for installation of the side mounting kit is a hex tip screwdriver for M6 screws.



ATTENTION: The light curtain can be damaged if the maximum torque exceeds 11 N•m (97.36 lb•in).

Do not clamp the gray plastic end cap ([Figure 56](#)).

Figure 56 - Correct and Incorrect Positioning of the Side Mounting Bracket

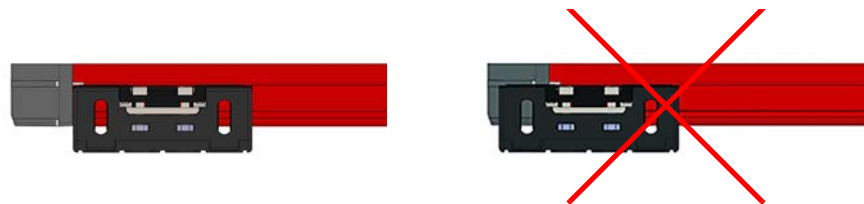

Position the side mount brackets close to the gray end cap. Position additional brackets so that the distance between each bracket is equal (symmetric). The optical interface device 450L-AD-OID (see [Optical Interface Device \(OID\) on page 120](#)) can also be installed in combination with the side mounting brackets.

Shock Mounting Kit

Special shock mount brackets are offered for applications that exhibit shock and vibration ([Figure 57 on page 86](#)). For vertical installations, the vibration damper (445L-AF6142) can be used in combination with the standard L-shaped top/bottom mounting bracket and side mounting.

Figure 57 - Shock Mount Brackets 445L-AF6142

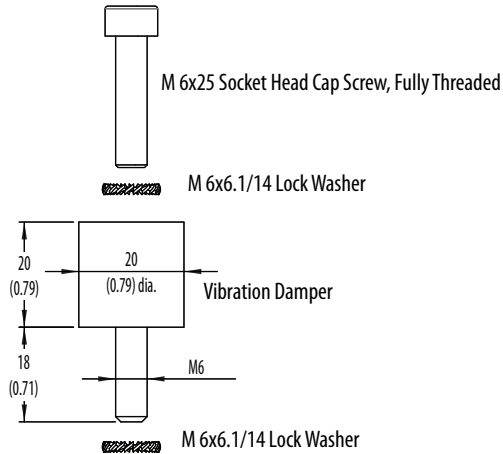

Replacement Mounting Kit

The Replacement Mounting Kit provides an easier mechanical conversion from installed safety light curtains to GuardShield safety light curtains if previous mounting holes have to be used. The GuardShield safety light curtain transceiver stick can be directly mounted to the replacement kit bracket. The replacement kit bracket can also be used in combination with the default mounting kit (catalog number 450L-AM-TBM) or the optional side-mount kit (catalog number 450L-AM-SM). See [Figure 59 on page 87](#).

Figure 58 - Replacement Mounting Kit (450L-AM-RK)

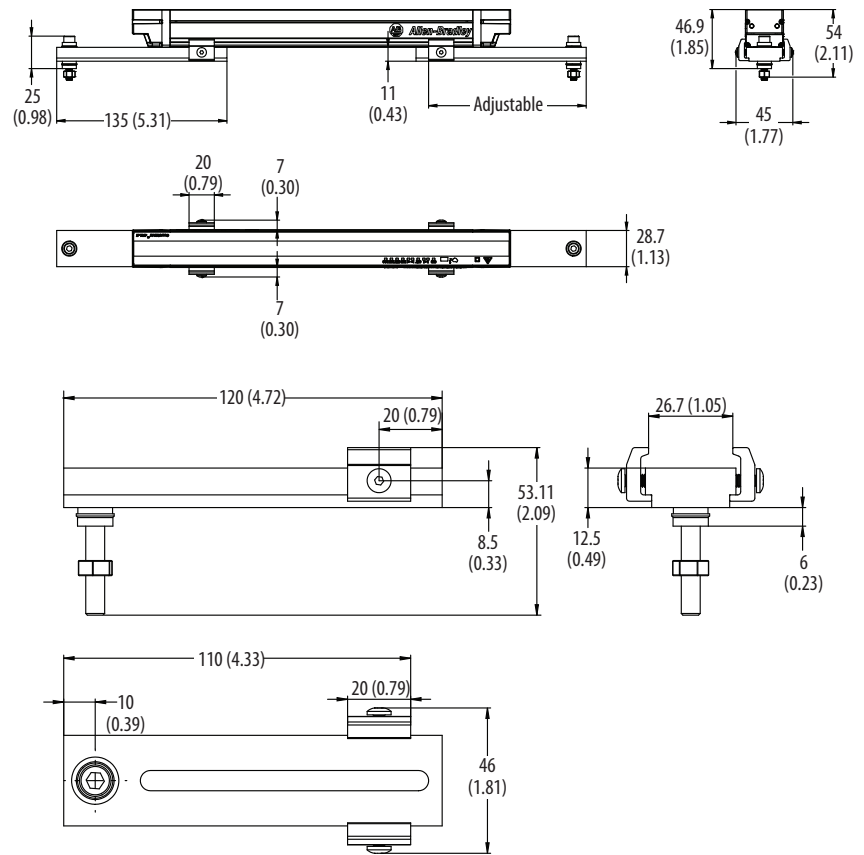
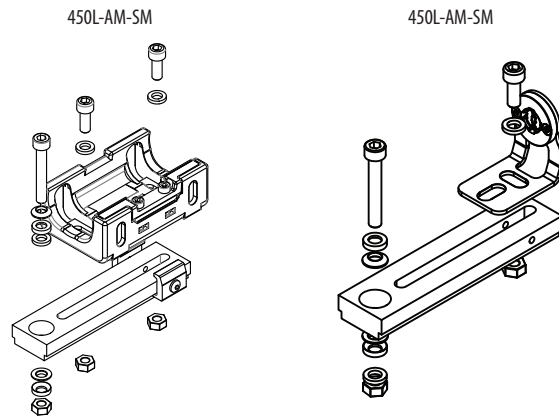

Figure 59 - Replacement Kit in Combination with the Default L-bracket (450L-AM-TBM) and the Side-mounting Bracket (450L-AM-SM).



Electrical Installation



ATTENTION: Remove power from the entire machine/system line.

The machine system could inadvertently start up while you are connecting the devices if power is not removed.



ATTENTION: Make sure that the entire system power is disconnected during the electrical installation.

Plug-ins

To assemble a 450L safety light curtain system two 450L safety light curtain sticks (two 450L-B sticks or two 450L-E sticks) — one transmitter and one receiver plug-in — are required. Instead of one transmitter and one receiver plug-in, two universal plug-ins can be used. Unpack the plug-ins and set the DIP switches according to the required functional settings. Remove the red slot cover from the 450L-B or 450L-E safety light curtain stick and insert the connection plug-in. Remove the gray slot cover from the 450L-E safety light curtain to insert a cascading plug-in if necessary.

IMPORTANT The connection and the cascading plug-ins are mechanically coded. It is not easy to insert a connection plug-in into the slot for the cascading plug-in and vice versa.

Do not insert plug-ins more than 100 times in one GuardShield safety light curtain stick.









ATTENTION: To avoid pollution or contamination, the installation of a plug-in into a stick must be implemented in a dry and clean area. Make sure that the rubber seal at the plug-in does not get out of place when the plug-in is inserted in the light curtain.

Plug-in Installation

To maintain the IP65 rating, the slot covers must be inserted fully into the light curtain. If the slot cover has been removed, it must be replaced with a plug-in that must be properly inserted into the light curtain. [Figure 60](#) shows example of correct and incorrect installation.

Figure 60 - Plug-in Installation Examples

Correct ✓	Incorrect ✗
 <p data-bbox="732 741 852 766">Cap fully seated</p>	 <p data-bbox="1187 741 1274 766">Cap missing</p>
 <p data-bbox="690 993 894 1045">Gasket in groove No nicks, splits, or flat spots</p>	 <p data-bbox="1161 993 1300 1018">Gasket mis-located</p>
 <p data-bbox="699 1325 885 1350">Fully seated, screws tight</p>	 <p data-bbox="1161 1325 1300 1350">Screws not torqued</p>

Transmitter Plug-in

Figure 61 shows the plug-ins that can make a transceiver a transmitter. Table 32...Table 34 show the pin-out connections for each plug-in.

Figure 61 - Transmitter Plug-ins

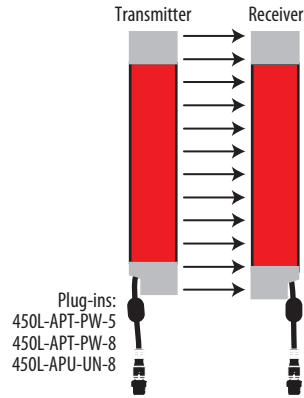

Table 32 - Pin Assignment — Cat. No. 450L-APT-PW-5

Face View of Male M12 5-pin	View	Pin Number	Signal Transmitter
		1	24V DC
		2	No connection
		3	0V (ground)
		4	No connection
		5	Functional earth FE

Table 33 - Pin Assignment — Cat. No. 450L-APT-PW-8

Face View of Male M12 8-pin	View	Pin Number	Signal Transmitter
		1	Do not connect
		2	+24V DC
		3	Functional earth FE
		4	Do not connect
		5	Do not connect
		6	Auxiliary output (lockout stick) (ON=24V DC)
		7	0V (GND)
		8	Do not connect

Receiver Plug-in

Any receiver plug-in type works with any transmitter plug-in type and vice versa (see [Figure 61 on page 90](#)).

Table 34 - Pin Assignment — Cat. Nos. 450L-APR-ON-5 and 450L-APR-BL-5

Receiver Bottom Plug-in Face View of Male M12 5-pin (DC Micro)	View	Pin Number	Signal Receiver
		1	+24V DC
		2	OSSD1
		3	0V (GND)
		4	OSSD2
		5	Functional earth FE

Table 35 - Pin Assignment — Cat. No. 450L-APR-ED-8

Receiver Bottom Plug-in Face View of Male M12 8-pin (DC Micro)	View	Pin Number	Signal Receiver
		1	Auxiliary output (OSSD emulation)
		2	+24V DC
		3	Functional earth FE
		4	EDM (Input) ⁽¹⁾
		5	OSSD1
		6	OSSD2
		7	0V (GND)
		8	Start ⁽¹⁾

(1) If set with DIP switches.

Table 36 - Pin Assignment — Cat. No. 450L-APR-MU-8 (Configured for (a) No Muting, or for (b) Muting Sensors Connected at Cascading 450L-APC-IO-8 Plug-in)

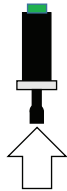
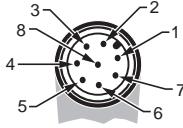
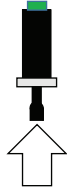
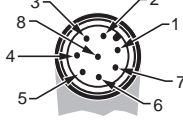
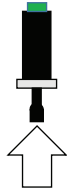
Receiver Bottom Plug-in Face View of Male M12 8-pin (DC Micro)	View	Pin Number	Signal Receiver
		1	Auxiliary output (OSSD emulation)
		2	+24V DC
		3	Functional earth FE
		4	EDM (Input) ⁽¹⁾
		5	OSSD1
		6	OSSD2
		7	0V (GND)
		8	Start ⁽¹⁾ /mute dependent override

(1) If set with DIP switches.

See [Table 37](#) for a configuration for muting sensors that are connected at the 450L-APR-MU-8 connection plug-in.



ATTENTION: The Auxiliary output is only a status output for diagnosis purposes to connect, for example, an indicator lamp. Do not use this output for safety purposes.

Table 37 - Pin Assignment — Cat. No. 450L-APR-MU-8 if Two-sensor Muting Are Connected at the Connection Plug-in Are Configured (450L-E Only)

Receiver Bottom Plug-in Face View of Male M12 8-pin (DC Micro)	View	Pin Number	Signal Receiver
		1	Sensor 1
		2	+24V DC
		3	Functional earth FE
		4	Sensor 2
		5	OSSD1
		6	OSSD2
		7	0V (GND)
		8	Start ⁽¹⁾ /mute dependent override

(1) If set with DIP switches.



ATTENTION: The Auxiliary output is only a status output for diagnosis purposes to connect, for example, an indicator lamp. Do not connect this output to fulfill safety functions.

Table 38 - Pin Assignment — Cat. No. 450L-APU-UN-8

Receiver Bottom Plug-in Face View of Male M12 8-pin (DC Micro)	View	Pin Number	Signal Transmitter	Signal Receiver
		1	Do not connect	Auxiliary output (OSSD emulation)
		2	+24V DC	+24V DC
		3	Functional earth FE	Functional earth FE
		4	(1)	EDM (Input) ⁽²⁾
		5	Do not connect	OSSD1
		6	Auxiliary output (Lockout)	OSSD2
		7	0V (GND)	0V (GND)
		8	(1)	(2)

(1) Pin 4 connected to pin 8 (short circuit).



(2) If set with DIP switches.

IMPORTANT If pin four is connected to pin eight, the corresponding 450L safety light curtain stick acts like a transmitter.

Cascading

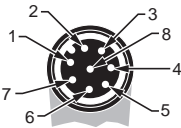

The cascading plug-in can be inserted in a 450L-E safety light curtain transceiver operating as a transmitter ([Table 39 on page 93](#)) or as a receiver ([Table 40 to Table 44 on page 95](#))

Table 39 - Pin Assignment of the Cascading Plug-in (Female M12 8-pin), Cat. No. 450L-APC-IO-8 Connected to a 450L-E, which Operates as a Tx

Receiver Bottom Plug-in Face View of Male M12 8-pin (DC Micro)	View	Pin Number	Signal Receiver
		1	No connection
		2	+24V DC
		3	Functional earth FE
		4	No connection
		5	No connection
		6	No connection
		7	0V (GND)
		8	No connection

The 450L-APC-IO-8 cascading plug-in that is connected to a GuardShield safety light curtain transceiver that is operating as a transmitter allows the cascading of an additional GuardShield safety light curtain transceiver operating as a transmitter (see [Cascading on page 48](#)). However, in a cascaded system for the transceiver working as a transmitter the 450L-APC-IO-8 cascading plug-ins can but do not have to be used ([Figure 26 on page 51](#)).

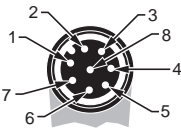
Table 40 - Pin Assignment of the Cascading Plug-in (Female M12 8-pin), Cat. No. 450L-APC-IO-8 Connected to a 450L-E, which Operates as an Rx (DIP Switch Connection Plug-in Default Setting)

Receiver Bottom Plug-in Face View of Male M12 8-pin (DC Micro)	View	Pin Number	Signal Receiver
		1	No connection
		2	+24V DC
		3	Functional earth FE
		4	No connection
		5	OSSD in 1
		6	OSSD in 2
		7	0V (GND)
		8	Not connected

For most DIP switch configurations, the 450L-APC-IO-8 cascading plug-in allows the cascading of an additional light curtain. There is no DIP switch that enables the cascading option. For some DIP switch settings that enable muting functionality, the pins of the 450L-APC-IO-8 plug-in are used for the connection of muting sensors. In those cases, the cascading feature is not enabled (see [Table 41](#) and [Table 42](#)).

Table 41 - Pin Assignment of the Cascading Plug-in (Female M12 8-pin), Cat. No. 450L-APC-IO-8 Connected to a 450L-E (DIP Switch Connection Plug-in Is Set for Muting Two Sensors, Muting Sensors Connected to the Cascade Plug-in)

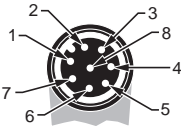
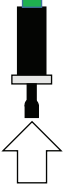
Receiver Bottom Plug-in Face View of Male M12 8-pin (DC Micro)	View	Pin Number	Signal Receiver
		1	MFO out
		2	+24V DC
		3	Functional earth FE
		4	Not connected
		5	Muting Sensor S1 In
		6	Muting Sensor S2 In
		7	0V (GND)
		8	Muting Lamp

The pin assignment of [Table 41](#) belongs to a two-sensor muting configuration. For DIP switch settings, see [Table 26 on page 63](#).

Table 42 - Pin Assignment of the Cascading Plug-in (Female M12 8-pin), Cat. No. 450L-APC-IO-8 Connected to a 450L-E (DIP Switch Connection Plug-in Set for Muting Four Sensors)

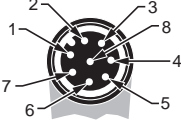
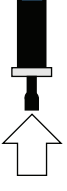
Receiver Bottom Plug-in Face View of Female M12 8-pin (DC Micro)	View	Pin Number	Signal Receiver
		1	Muting Sensor S3 In
		2	+24V DC
		3	Functional earth FE
		4	Muting Sensor S4 In
		5	Muting Sensor S1 In
		6	Muting Sensor S2 In
		7	0V (GND)
		8	Muting Lamp

The pin assignment of [Table 42](#) belongs to a four-sensor muting configuration. For DIP switch settings, see [Table 26 on page 63](#).

Transmitter Cable Connection

Depending on the selected plug-in, the GuardShield safety light curtain transmitter plug-in has either a 5-pin or 8-pin M12 (DC micro) male connector. Connection cable accessories are offered from 2...30 m (6.6...98 ft) lengths.

Only the 450L-B safety light curtain transmitter with 5-pin M12 QD plug-in can be used with ArmorBlock® Guard I/O™ connectivity or GuardLink® systems.

Table 43 - Pin Assignment of the Cable if Connected to a M12 5-pin Transmitter Bottom Plug-in (Cat. No. 450L-APT-PW-5)

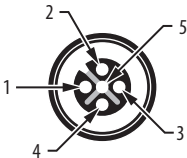
Transmitter Connection Cable Face View of Female M12 5-pin (DC Micro)	Color (Cat. No. 889D-F5BC-x) ⁽¹⁾	Pin Number	Signal Transmitter
	Brown	1	+24V DC
	White	2	Not connected
	Blue	3	0 (GND)
	Black	4	Not connected
	Gray	5	Functional earth FE

(1) Replace x with 2, 5, 10, 15, 20, or 30 for available lengths in meters.

IMPORTANT The transmitter itself is not expected to be connected to the ArmorBlock Guard I/O module or a GuardLink tab. Consider a separate connection cable or use the 5-pin T-connector for implementation of a transmitter (see [T-connector on page 104](#)).

Table 44 - Pin Assignment of the Cable if Connected to a M12 8-pin Transmitter Bottom Plug-in (Cat. No. 450L-APT-PW-8)

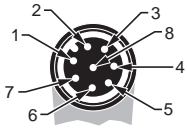
Transmitter Connection Cable Face View of Female M12 8-pin (DC Micro)	Color (Cat. No. 889D-F8AB-x) ⁽¹⁾	Pin Number	Signal Transmitter
	White	1	Do not connect
	Brown	2	+24V DC
	Green	3	Functional earth FE
	Yellow	4	Do not connect
	Gray	5	Do not connect
	Pink	6	Auxiliary output (lockout stick) (24V = normal operation, 0V = lockout stick)
	Blue	7	0V (GND)
	Red	8	Do not connect

(1) Replace x with 2, 5, 10, 15, 20, or 30 for available lengths in meters.

Receiver Cable Connection

Depending on the selected plug-in, the GuardShield safety light curtain receiver plug-in has either a 5-pin or 8-pin M12 (DC micro) connector (male). Connection cable accessories are offered from 2...30 m (6.6...98 ft) lengths.

Table 45 - Pin Assignment of the Cable if Connected to a M12 5-pin Receiver Plug-in (Cat. No. 450L-APR-ON-5 or 450L-APR-BL-5)

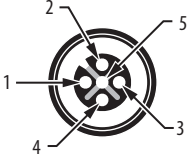
Receiver Connection Cable Face View of Female M12 5-pin (DC Micro)	Color (Cat. No. 889D-F5BC-x) ⁽¹⁾	Pin Number	Signal Transmitter
	Brown	1	+24V DC
	White	2	OSSD1
	Blue	3	0V (GND)
	Black	4	OSSD2
	Gray	5	Functional earth FE

(1) Replace x with 2, 5, 10, 15, 20, or 30 for available lengths in meters.

Table 46 - Pin Assignment of the Cable if Connected to a M12 Eight-pin Receiver Plug-in (Cat. Nos. 450L-APR-ED-8 or 450L-APR-MU-8)

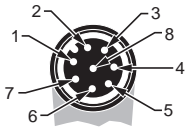
Receiver Connection Cable Face View of Female M12 8-pin (DC Micro)	Color (Cat. No. 889D-F8AB-x) ⁽¹⁾	Pin Number	Signal Receiver
	White	1	Auxiliary output (OSSD high = 24V)
	Brown	2	+24V DC
	Green	3	Functional earth FE
	Yellow	4	EDM (Input) ⁽²⁾
	Gray	5	OSSD1
	Pink	6	OSSD2
	Blue	7	0V (GND)
	Red	8	Start ⁽²⁾

(1) Replace x with 2, 5, 10, 15, 20, or 30 for available lengths in meters.

(2) If set with DIP switches.



ATTENTION: The Auxiliary output is only a status output for diagnosis purposes to connect, for example, an indicator lamp. Do not connect this output to fulfill safety functions.

Table 47 - Pin Assignment of the Cable if Connected to a M12 Eight-pin Universal Plug-in; (Depending on Wiring Can Either Be a Transmitter or a Receiver) (Cat. No. 450L-APU-UN-8)

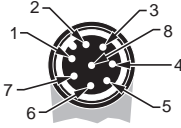
Connection Cable Face View of Female M12 8-pin (DC Micro)	Color (Cat. No. 889D-F8AB-x) ⁽¹⁾	Pin Number	Signal Transmitter	Signal Receiver
	White	1	—	Auxiliary output (OSSD high = 24V)
	Brown	2	+24V DC	+24V DC
	Green	3	Functional earth FE	Functional earth FE
	Yellow	4	⁽²⁾	EDM (Input) ⁽³⁾
	Gray	5	Do not connect	OSSD1
	Pink	6	Auxiliary output (Lockout) (24V = normal operation, 0V = lockout)	OSSD2
	Blue	7	0V (GND)	0V (GND)
	Red	8	⁽²⁾	⁽³⁾

- (1) Replace x with 2, 5, 10, 15, 20, or 30 for available lengths in meters.
- (2) Pin 4 connected to pin 8 (short circuit).
- (3) If set with DIP switches.

Cascading Cable Connection

The pin assignment for the cable connected to a cascading plug-in (catalog number 450L-APC-IO-8) depends on if the cascading plug-in is inserted in a 450L-E transceiver stick working as a transmitter or as a receiver. It also depends on the settings of the DIP switches on the RX plug-in.

Table 48 - Pin Assignment of the Cable if Connected to a M12 8-pin I/O Cascading Plug-in; (Cat. No. 450L-APC-IO-8)

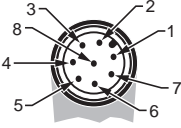
Connection Cable Face View of Male M12 8-pin (DC Micro)	Color (Cat. No. 889D-M8AB-x) ⁽¹⁾	Pin No.	Signal Transmitter	Signal Receiver (4 Sensor Muting) ⁽²⁾
	White	1	—	Muting sensor S3 in
	Brown	2	+24V DC	+24V DC
	Green	3	Functional earth FE	Functional earth FE
	Yellow	4	—	Muting sensor S4 in
	Gray	5	—	Muting sensor S1 in
	Pink	6	—	Muting sensor S2 in
	Blue	7	0V (GND)	0V (GND)
	Red	8	—	Muting lamp

- (1) Replace the x with 2 [2 m (6.6 ft)], 5 [5 m (16.4 ft)], 10 [10 m (32.8 ft)] for desired length.
- (2) If set with DIP switches.

Power Supply

The external voltage supply (+24V DC) must meet the requirements of IEC 61496-1. Give special attention to the following requirements:

- The power supply must bridge a short-term power failure of 20 ms (according to IEC 60204-1).
- The maximum deviation of the voltage levels is 24V DC \pm 15%.
- The power supply is protected against overload (use NEC Class 2 or fuse with 4 A in the 24V DC circuit).
- The light curtain devices must be provided with a 24V DC PELV or SELV power supply that conforms to the requirements of 414-3 or IEC 60364-4-41. These provisions have been taken to confirm that, even if an internal fault occurs, the voltage at the outgoing terminals cannot exceed 60V DC.

To comply with UL restrictions, GuardShield safety light curtain sticks are powered by DC sources whose secondary circuits are isolated from the primary circuit by double insulation or reinforced insulation. The DC power supply must satisfy the requirements for National Electric Code (NEC) Class 2.

The following are Rockwell Automation power supplies that are NEC Class 2 and PELV compliant. They also meet the isolation and output hold-off time requirements of two GuardShield safety light curtain transceiver sticks (GuardShield safety light curtain outputs not loaded):

- 2080-PS120-240V AC
- 1606-XLP15E
- 1606-XLP30E
- 1606-XLP50E
- 1606-XLP50EZ
- 1606-XLP72E
- 1606-XLP95E
- 1606-XLSDNET4

Grounding

There are two types of recommended grounding for 450L safety light curtains:

- Protective earth (PE)
- Functional earth (FE)

Protective earth is intended to help protect personnel from electric shock. Protective earth is also known as dirty earth as it can contain many types of noise transients and stray currents. The 24V common side of the 24V power supply must be connected to protective earth at one location.

Functional earth is intended to reduce the high frequency (RF) noise and is also known clean earth. The functional earth should carry only returning RF noise currents. Ground schemes must include a functional earth ground to minimize common mode disturbances that may have been capacitively coupled between cables, transients on the 24V common, or radiated noise. Functional earth must be separated from other earths and should be connected to protective earth at one point.

The 450L plug-in modules have a pin that is labeled functional earth and a pin that is labeled 0V (GND). The 0V (GND) must be connected to the 24V common. At some point, the 24V Com is connected to protective earth. In the absence of electrical noise, the functional earth could be connected to 24V Com or directly to protective earth point. In the presence of electrical noise, the functional earth connection becomes critical; the connection must be made to return the noise to its source in as short a distance as possible.

[Figure 62](#) shows the symbols that are used to designate functional and protective earth grounds.

Figure 62 - Earth Symbols



External Device Monitoring (EDM) Connection

The External Device Monitor (EDM) describes the EDM feature. The EDM function can be performed with the receiver plug-ins according to [Table 19](#) and [Table 20 on page 59](#).

Figure 63 - Connect the Contact Elements to the EDM Input

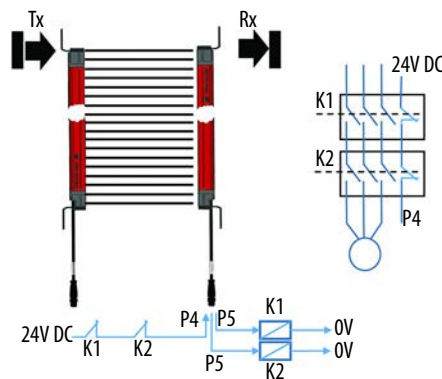

IMPORTANT EDM function is not available for GuardShield safety light curtain with receiver M12 5-pin plug-in (ArmorBlock Guard I/O connectivity).
Surge suppression elements are often required for the contactors depending on the contactor.

Restart Button

[Start Modes on page 27](#) describes the options for the individual start modes.

Figure 64 - Connect the Restart Button to Pin 8

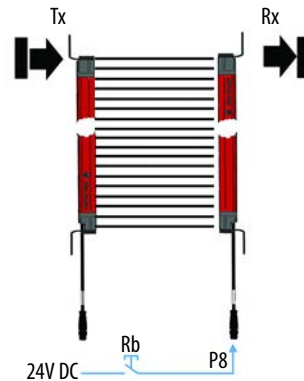

The Start button must be pressed a minimum of 50 ms. The maximum time for accepting the start is 5 seconds. The start reacts on the falling edge of the start pulse.

If there is a manual start, the Start button must be located outside the hazardous area such that a person working inside the hazardous area cannot operate it. Manual start is not available in GuardShield safety light curtains with 5-pin M12 QD connection plug-ins (ArmorBlock Guard I/O connectivity).

IMPORTANT Start is not available for GuardShield safety light curtain with M12 5-pin plug-in (ArmorBlock, Guard I/O connectivity).

The Start button can also be used to reset the system if there is a lockout. The stick performs a manual start if the button is pressed a minimum of 10 seconds and not longer than 20 seconds.

For information on Grounding, see [Grounding on page 98](#).

OSSD Output

OSSD Signal Processing

The dangerous movement of the machine must reach a safe state at any time if at least one of the two OSSDs switches off (0V).

In the application, the signals of both OSSDs must be processed separately. Both signals must always be connected to either a safety controller, safety relay or safety contactors. When safety contactors are used (positively guided contactors), verification of the status of each must be implemented (see [External Device Monitoring \(EDM\) Connection on page 99](#), [Figure 63 on page 99](#) and [Figure 65 on page 101](#)).

OSSD Restart Time (from OFF to ON)

The times that are necessary to switch on the OSSDs after clearance of an interruption of the protective field if automatic reset is as follows.

- Both synchronization beams interrupted before clearance is <210 ms
- Zero or one synchronization beams interrupted before clearance is <33 ms.

Each GuardShield safety light curtain system has two synchronization beams: one beam is at the bottom and one beam is at the top of the protective field.

Test Pulses

The safety outputs of a GuardShield safety light curtain system use test pulses to check for OSSD output faults. This process is illustrated graphically in [Figure 65 on page 101](#).

Figure 65 - OSSD Safety Output Test Pulse Characteristic

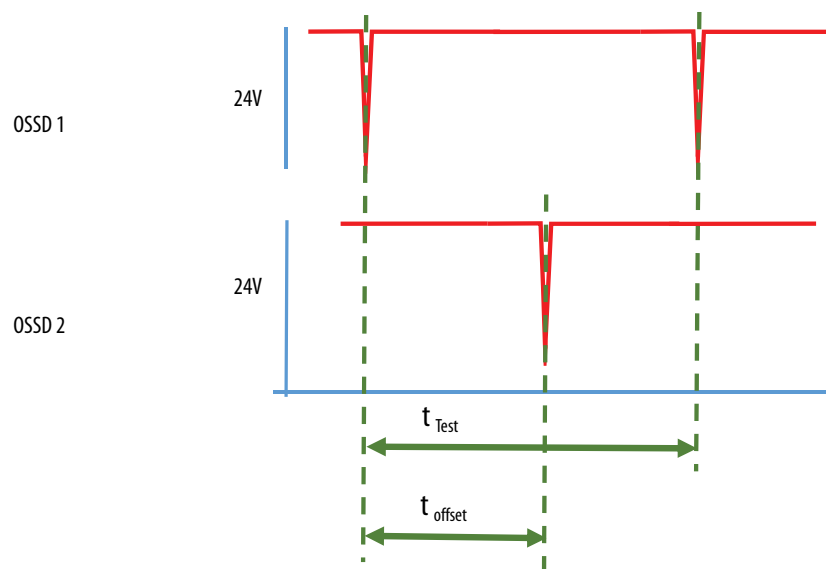

$t_{\text{Test}} = 100 \dots 125$ ms. Actual value depends on stick length. OSSD2 has same timing between pulses as OSSD1, with offset approximately half of t_{Test} .

Pulse is as short as possible, depends on load. 50 ms is typical for resistive load and longer if a capacitive load is used.

The test pulses can lead to the connected device being switched off sporadically if the device does not filter the test pulses correctly.

Typical Wiring Diagram Direct to Contactors

Figure 66 - Example of Connecting to External Contactors with a 450L-APR-ED-8 Plug-in for the Receiver and a 450L-APT-PW-8 Plug-in for the Transmitter

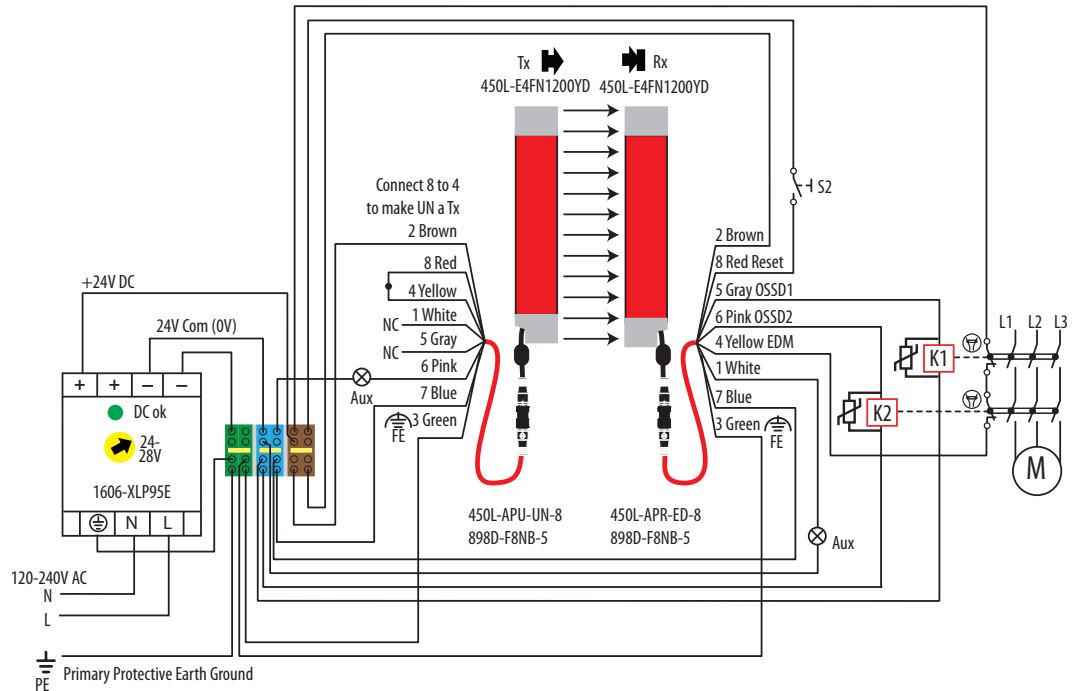

S2=manual restart; K1/K2 = safety contactors (Bulletin 100S-C contactors with electronic coils). For non-motor loads, K1/K2 can be Bulletin 700S-CF control relays with electronic coils.

IMPORTANT EDM must be activated in the GuardShield safety light curtain and the application requires safety contactors (K1 and K2). EDM feedback is only available on eight-pin plug-ins.

The use of some type of surge suppression to help protect and extend the operating life of the OSSD outputs is required. The potentially high current surges that are created when switching inductive load devices, such as motor starters and solenoids, requires this extra protection. By adding a suppression device directly across the coil of an inductive device, you prolong the life of the outputs. You also reduce the effects of voltage transients and electrical noise from radiating into adjacent systems.

Figure 66 shows an output with a suppression device. We recommend that you locate the suppression device as close as possible to the load device. Since the outputs are 24V DC, we recommend 1N4001 (50V reverse voltage) to 1N4007 (1000V reverse voltage) diodes for surge suppression for the OSSD safety outputs. The diode is connected as close as possible to the load coil. Bulletin 100S contactors and 700S control relays with electronic coils have built-in suppression; additional components for suppression are not needed.



ATTENTION: The response time of the safety contactors often increases drastically, when surge suppression diodes are used.

Never install suppressors directly across:

- The OSSD outputs, or
- Contacts of the safety device or module.

A short circuit fail of a surge suppressor element leads to an unsafe condition and causes serious injury or death.

Guardmaster SI Safety Relay

Figure 67 is an example of connecting to a 450L-B safety light curtain with a 5-pin transmitter plug-in (catalog number 450L-APT-PW-5) and 5-pin receiver plug-in (catalog number 450L-APR-ON-5) to an SI safety relay (catalog number 440R-S12R2).

Figure 67 - Example of Connecting to a 450L-B Safety Light Curtain System

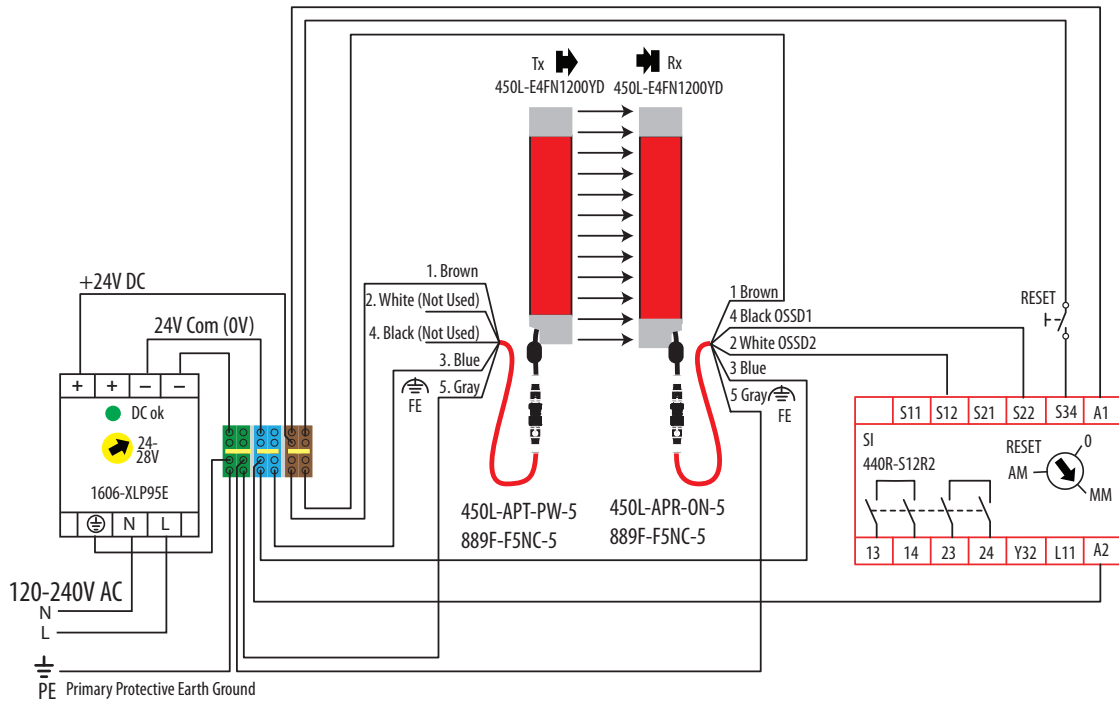

Figure 68 shows a connection example of a 450L-B safety light curtain with two universal plug-ins (catalog number 450L-APU-UN-8) to an SI safety relay (catalog number 440R-S12R2).

Figure 68 - Connection Example

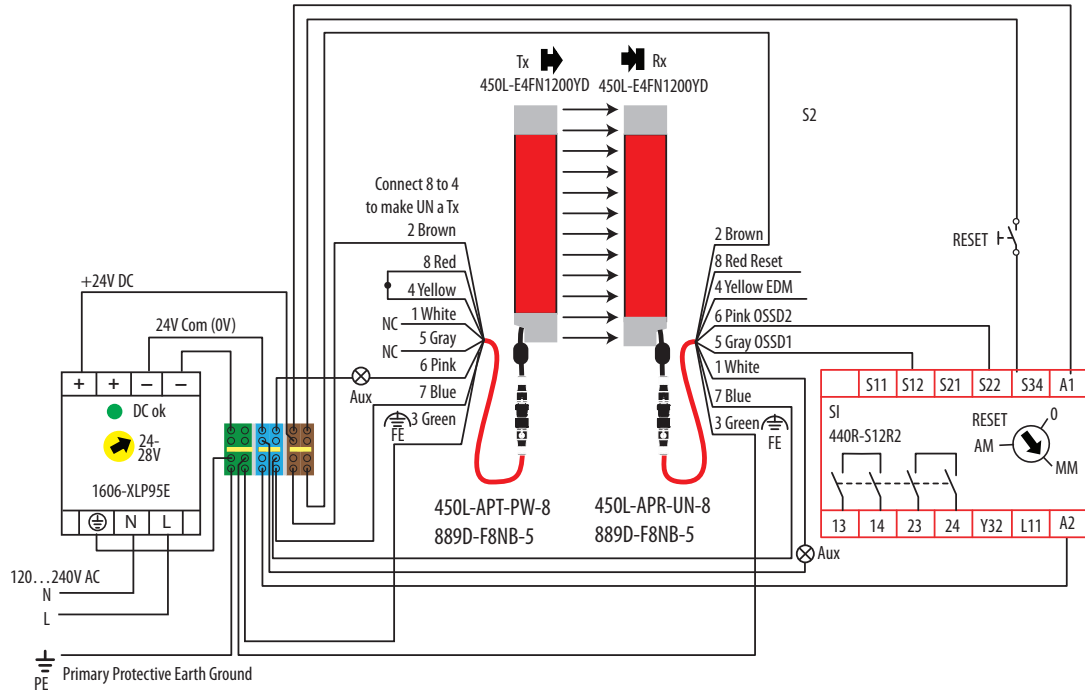
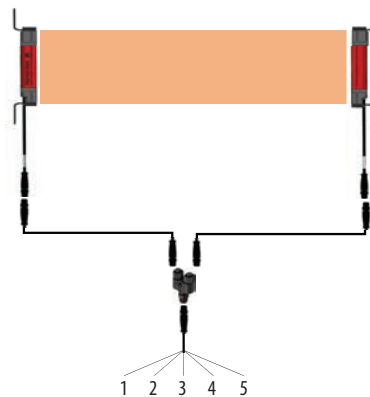

Figure 69 on page 104 is an example of a muting application that connects the 450L-E light curtain with a 5-pin transmitter plug-in (catalog number 450L-APT-PW-5) and an 8-pin receiver plug-in (catalog number 450L-APR-MU-8) to an SI safety relay (catalog number 440R-S12R12).

T-connector

If a safety light curtain system has an Rx and a Tx plug-in with M12 5-pin connectors, then a T-connector can also be used to design and connect the system (see Figure 69).

Figure 69 - Wiring with T-connector 1485P-RDR5.



For the description of the pins, see [Table 45 on page 96](#).



ATTENTION: Make sure that the connected power supply is able to source both connected sticks simultaneously (Power Consumption, see [Table 71 on page 189](#)).

The 450L transceiver stick working as a transmitter must have firmware 2.001 or higher.

The T-connector can also be used to attach a 450L safety light curtain system to GuardLink technology (see ab.rockwellautomation.com/allenbradley/safety/guardlink.page).

GuardLink Tap Connections

[Figure 70 on page 105](#) shows an example for connecting a 450L-B safety light curtain with 5-pin transmitter and 5-pin receiver plug-ins to a 440S-SF5D GuardLink tap. A 1485P-RDR5 splitter (see [T-connector](#)) allows both the receiver and transmitter to be connected to one tap. The firmware for the 450L transceiver stick working as a transmitter must be 2.001 or larger. The firmware level can be found on product label (see [Product Labels on page 126](#)).

Figure 70 - Example Schematic for Connecting to a 450L-B to GuardLink Tap

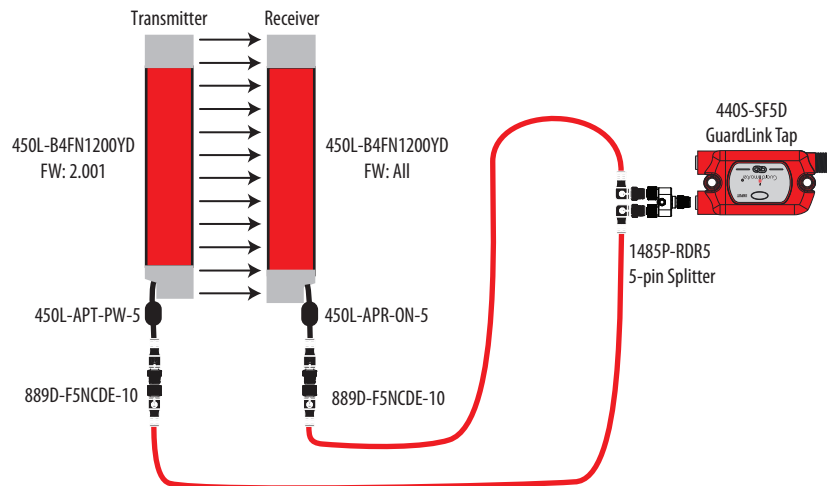

1732 ArmorBlock Connections

Figure 71 is an example of connecting to a 450L-B safety light curtain with 5-pin transmitter and receiver plug-ins to a 1732ES-IB12XOB4 ArmorBlock module. A 1485P-RDR5 splitter (see [T-connector on page 104](#)) allows both the receiver and transmitter to be connected to one input connector. The firmware for the 450L transceiver stick working as a transmitter must be 2.001 or larger. The firmware level can be found on product label; see example of [Product Labels on page 126](#).

Figure 71 - Example Schematic for Connecting to a 450L-B Safety Light Curtain System

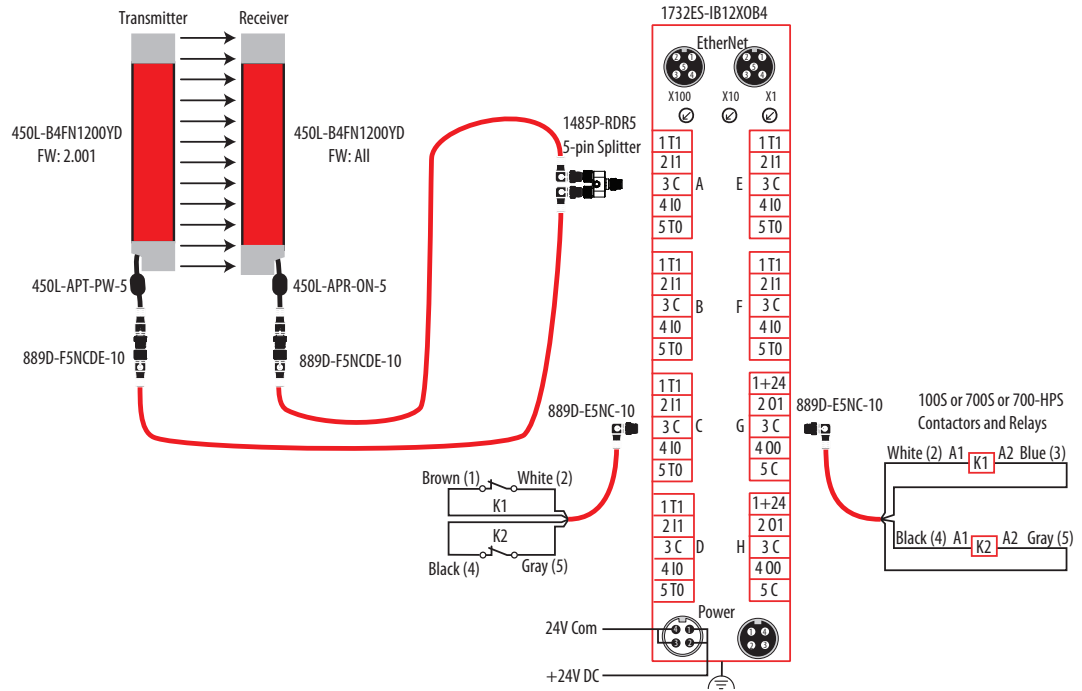

The DIP switch settings for the receiver plug-in module are shown in [Table 49](#). Switches 2 and 3 can be set to ON, if needed by the application. The transmitter plug-in does not have DIP switches.

Table 49 - DIP Switch Settings

Switch	450L-APR-ON-5	Description	Comment
1	OFF	—	
2	OFF	Low Range Disabled	Optional
3	OFF	Beam Coding Deactivated	Optional
4	OFF	—	

Figure 72 shows the screen captures of the ArmorBlock module properties setup for the example schematic.

Tab	Description
General	Configure the module definition.
Input Configuration	Points 0 and 1 monitor the light curtain OSSD outputs. Points 4 and 5 use pulse testing to monitor the status of the output contactors K1 and K2. The Point Operation Types are set to Single to allow the logic function block to detect faults.
Test Output	Point 0 must be set to Not Used as pin 5 on the connector is connected to the light curtain housing. Point 1 is set to Standard to allow the program to cycle the power to the light curtains if the light curtain has to be power cycled. Points 4 and 5 are the test pulses to monitor the contactors K1 and L2.
Output Configuration	Points 0 and 1 turn the output contactors, K1 and K2, on and off.

Figure 72 - ArmorBlock Module Properties Setup

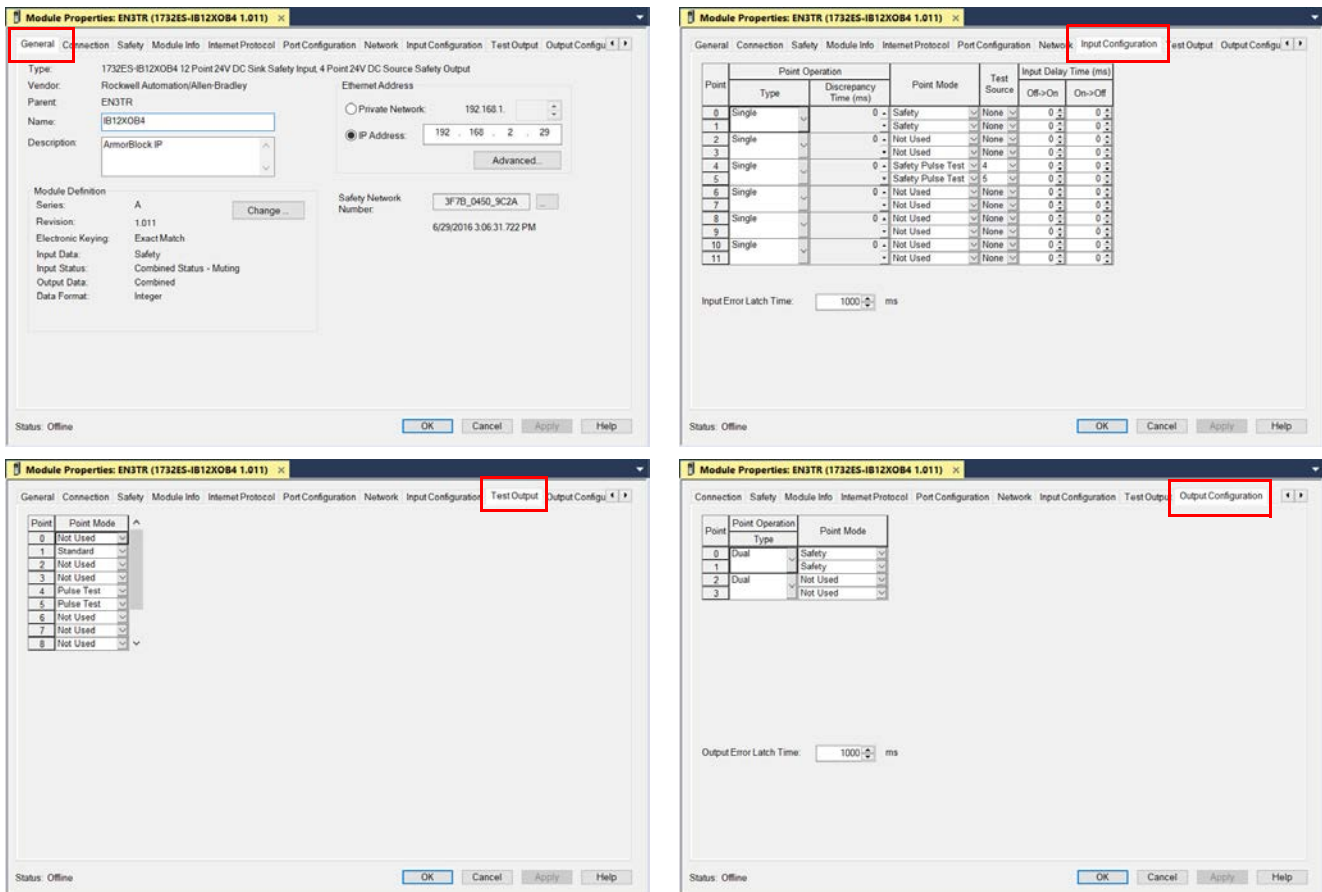
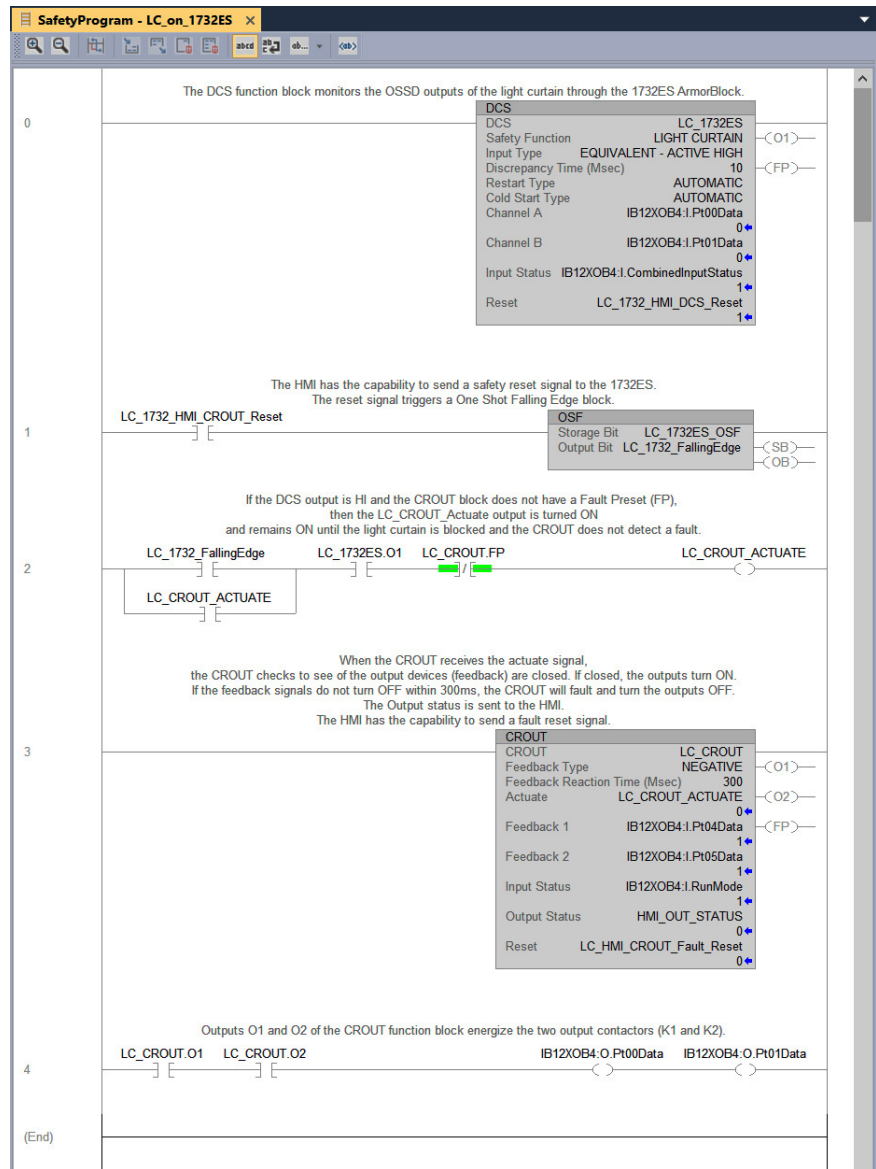

Figure 73 shows a typical example of a ladder logic program that could be used with the example schematic. The comments that are embedded in the program explain the usage of each rung.

Figure 73 - ArmorBlock Ladder Logic Program



Two-sensor Muting with Muting Plug-in

Figure 74 is a two-sensor muting example with the 450L-E safety light curtain. The transmitter uses the 5-pin transmitter plug-in, and the receiver uses the 8-pin muting plug-in.

Figure 74 - Example Schematic for Two-sensor Muting of a 450L-E Light Curtain

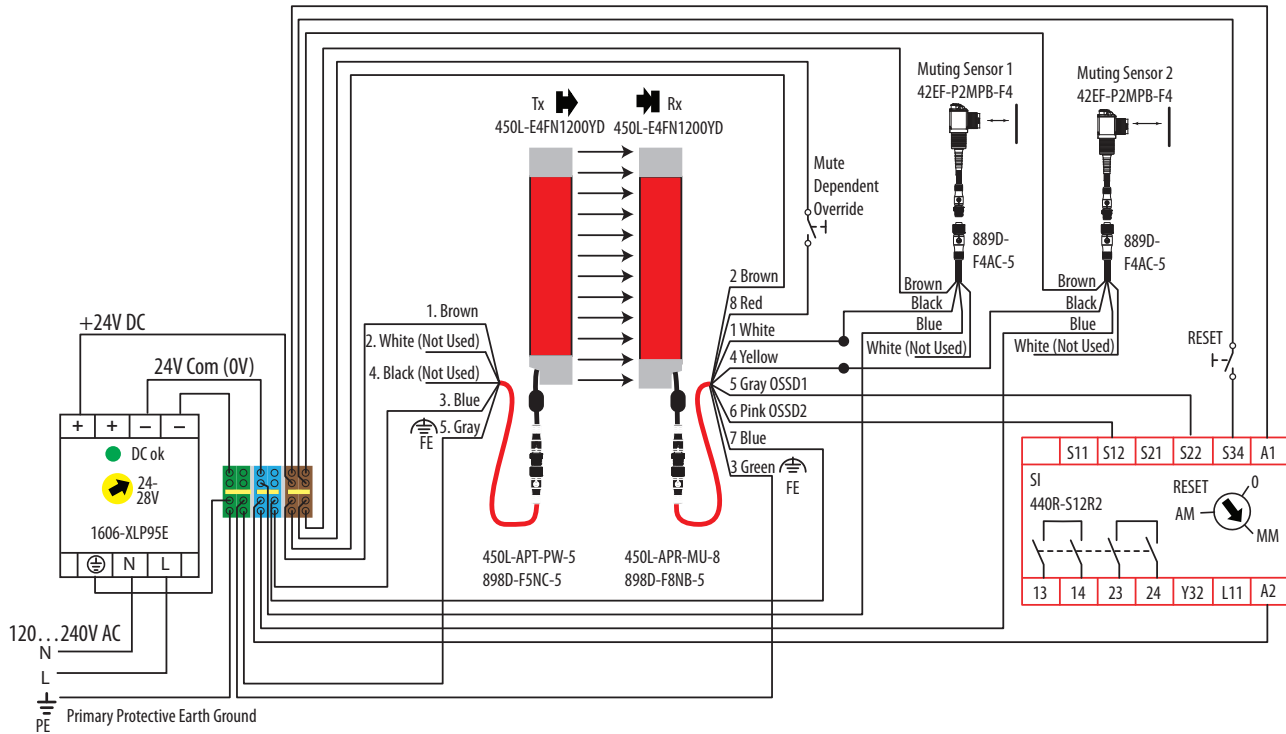

The DIP switch settings for the receiver muting plug-in are shown in Table 50. Switches 2, 3, 5, and 6 can be changed to ON, if needed by the application. Switch 7 must be OFF and switch 8 must be ON. Switches 9, 10, and 11 determine the type of muting. The transmitter plug-in does not have DIP switches.

Table 50 - Receiver DIP Switch Settings

Switch	450L-APR-MU-8	Description	Comment
1	OFF	—	—
2	OFF	Low Range Disabled	Optional
3	OFF	Beam Coding Disabled	Optional
4	OFF	—	—
5	OFF	Automatic Start	Optional
6	OFF		Optional
7	OFF	EDM Disabled	—
8	ON	Muting	Required
9	OFF or ON	DIP 9: OFF, DIP 10: ON, DIP 11: OFF 2L muting DIP 9: ON, DIP 10: OFF, DIP 11: OFF 2T muting	Determines muting type
10	OFF or ON		
11	OFF		
12	OFF	—	—

Four-sensor Muting with Muting Plug-in

Figure 75 is a four-sensor muting example with the 450L-E safety light curtain. The transmitter uses the 5-pin transmitter plug-in. The receiver uses the 8-pin muting plug-in at the bottom and the 8-pin I/O plug-in at the top.

Figure 75 - Example Schematic for Four-sensor Muting of a 450L-E Light Curtain

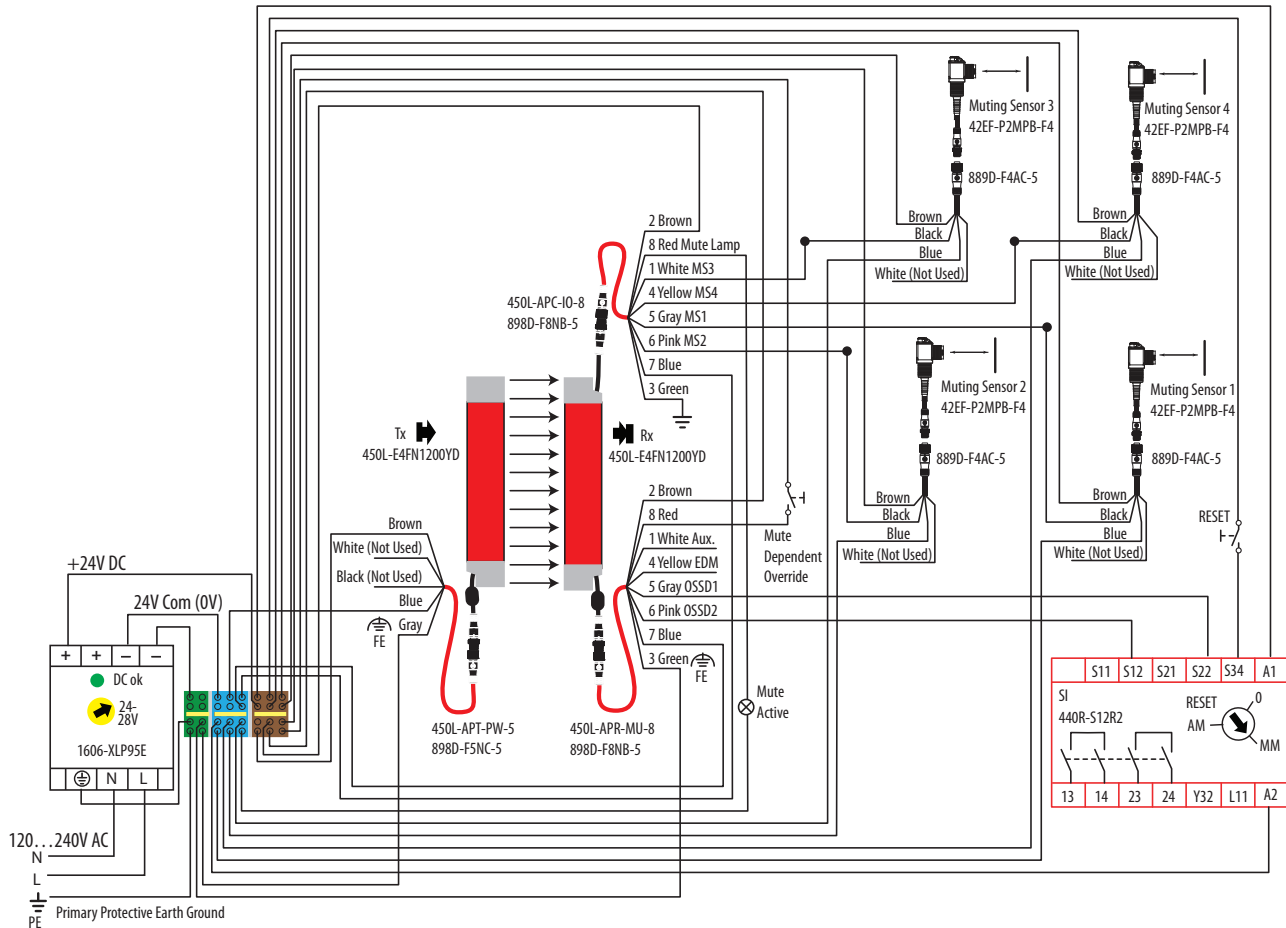

The DIP switch settings for the receiver muting plug-in are shown in Table 51 on page 111. Switches 2, 3, 5, and 6 can be changed to ON, if needed by the application. Switch 7 must be OFF and switch 8 must be ON. Switches 9, 10, and 11 must be set to ON for four-sensor muting. The transmitter and I/O plug-in do not have DIP switches.

Table 51 - Receiver Muting Plug-in DIP Switch Settings

Switch	450L-APR-MU-8	Description	Comment
1	OFF	—	—
2	OFF	Low Range Disabled	Optional
3	OFF	Beam Coding Disabled	Optional
4	OFF	—	—
5	OFF	Automatic Start	Optional
6	OFF		Optional
7	OFF	EDM Disabled	—
8	ON	Muting	Required
9	OFF or ON	DIP 9: OFF, DIP 10: ON, DIP 11: OFF 2L muting DIP 9: ON, DIP 10: OFF, DIP 11: OFF 2T muting DIP9: ON, DIP 10: ON DIP: 11 ON 4T muting.	Determines muting type
10	OFF or ON		
11	OFF or ON		
12	OFF	—	—

Notes:

Status Indicators and Troubleshooting

Status Indicators

The light curtain conducts an internal self-test after startup. If an error occurs, an appropriate signal combination displays the indicator status. If a GuardShield™ safety light curtain acts like a transmitter or as a receiver, it is also shown on the plug-in label.

Transmitter 

Receiver 

IMPORTANT If you use a universal plug-in, only the status indicators or the wiring can give the information if a light curtain is a transmitter or a receiver.

A quick categorization of an error can be done by checking the status indicator STS (see [Table 53 on page 116](#) and [Table 54 on page 118](#)).

System Status Indicators

In the area closest to the connection plug-in, there are different status indicator lights. The number of indicators depends on the stick type:

- 450L-B: 7 indicators
- 450L-E: 10 indicators

The STS and OUT status indicators are bicolor. Their functions and colors are defined in [Table 52 on page 115](#).

Figure 76 - Status Indicators of a 450L Safety Light Curtain





The transceiver architecture of 450L-B and 450L-E results in the Rx and Tx having the same status indicators.

Status Indicator for Normal Operation

[Table 52](#) lists normal operation status indicators on a 450L-B and 450L-E safety light curtain (colors and functions) for normal operation.

Table 52 - Status Indicators

No.	Marking	Status Indicator Name	Color	Behavior	Description	System Status	
1	STS	Status indicator	Green		On	Power on and system is OK	No
			Green	Red	Blinking	Configuration that is changed or receiver was operated previously with another transmitter	No
			Green	Off	Blinking	See Troubleshoot on page 116	No
			Off	Red	Blinking		No
			Red		On		No
2		Transmitter	Green		On	Plug-in identifies stick as a transmitter	No
					Blinking 1 Hz (50:50)	See Troubleshoot on page 116	No
					Blinking 1 Hz (98:2)	Reduced range and/or beam coding is activated	No
					Off	Stick is receiver	No
3		Receiver	Green		On	Plug-in identifies stick as a receiver	No
					Blinking 1 Hz (98:2)	Reduced range and/or beam coding is activated	No
					Off	Stick is transmitter	No
4	OUT	Safety outputs	Green		On	Safety outputs are on (receiver)	No
			Red		On	Safety outputs are off (receiver)	No
			—		Off	Transmitter	No
5		Regional light intensity level 1	Green		On	Bottom half zone is not interrupted and intensity is OK	Yes
					Blinking 1 Hz (50:50)	Bottom half zone intensity is at the limit	Yes
					—	Off	Bottom half zone interrupted
6		Regional light intensity level 2	Green		On	Top half zone is not interrupted and intensity is OK	Yes
					Blinking 1 Hz (50:50)	Top half zone intensity is at the limit	Yes
					—	Off	Top half zone interrupted
7	RES	Start	Amber		On	Start required (receiver)	No
			—		Off	No start is required (receiver)	No
8	MUT	Muting	Orange		Off	Light curtain that is not muted	No
					On	Light curtain that is muted	No
			Orange	Off	Blinking	Muting error	No
9	BLK	Blanking	Orange		Off	No blanking feature selected	No
			Orange		On	Blanking feature that is selected	No
			Orange	Off	Blinking	Blanking error	No
10	CAS	Cascading	Red		Off	No cascading plug-in that is inserted or Tx OSSDs of connected cascade are in ON-state (Rx only)	No
					On	OSSDs of connected cascade are in OFF-state (Rx only)	No
			Red	Off	Blinking	Error cascading plug-in	No

The last column in [Table 52](#) describes whether the signal is displayed simultaneously at both sticks.

- “No” means that the status indicator shows only the status of the individual stick
- “Yes” means that the status indicator shows the status of the complete system

Optical Push Button

The optical push button is on the front window next to the status indicators. For activation, place your finger on the square ([Figure 77](#)). It is operated with infrared light and can be used to:

- Confirm a new configuration (see [Confirmation of a New System Configuration on page 64](#)).
- Switch on/off the integrated laser alignments system (450L-E only) ([Laser Alignment on page 24](#)).
- Start power off/on cycle if there is a lockout. For recycling, the optical push button has to be pressed between 10...20 seconds. Otherwise, the recycle command is ignored (see [Table 54 on page 118](#)).
- Communication with the Optical Interface Device (see [Optical Interface Device \(OID\) on page 120](#)).

Figure 77 - Optical Push Button



Troubleshoot

Status Indicator Error Display

If the STS status indicator is red, blinks red on/off, or blinks green an error occurred which stops the system from working in normal operation.

Figure 78 - Status Indicator



Error types are differentiated according to [Table 53](#).

Table 53 - Error Types

Number	STS Code	Error Type
1	Red on	Internal error
2	Red/OFF blinking	External error
3	Green/OFF blinking	Invalid DIP switch settings
4	Green/Red blinking	Configuration changed

Errors can be caused externally (STS =red on/off blinking) and internally (STS = red on). Examples of external recoverable errors include: ambient light and/or Start button fault.

If there's an error, the second status indicator provides more information about the root cause ([Table 54 on page 118](#)).



ATTENTION: To indicate if a system is in the configuration mode, the STS status indicator blinks alternately red/green (50:50; 1 Hz). The configuration mode is not an error. It just indicates that the DIP switch configuration and/or plug-in was changed and it must be confirmed. For normal operation, the configuration must be confirmed first. This procedure is described in [Confirmation of a New System Configuration on page 64](#).

The timing of the status indicator blinking defines a frequency and a duty cycle. The frequency defines one sequence of on and off, as a default frequency 1 Hz is used if not otherwise mentioned. The duty cycle defines the ratio of the on duration and the off duration of the status indicator. If not otherwise mentioned, the default value for the duty cycle is 50:50, meaning 50% on, 50% off.

Table 54 - Status Indicators for External Errors and System Errors

No.	Error	First Status Indicator				Second Status Indicator			
	Short Description	Marking (Name)	Color	Blink Frequency	Duty Cycle (On/Off)	Marking (Name)	Color	Blink Frequency	Duty Cycle ⁽³⁾
0	Configuration changed ⁽¹⁾	STS	Red/ Green	1 Hz	50:50	—	—	—	—
1	Internal lockout ⁽²⁾	STS	Red	ON	100:0	—	—	—	—
2	EDM error ⁽³⁾	STS	Red	1 Hz	50:50	RES	Amber	1 Hz	10:90
3	Start error ⁽²⁾	STS	Red	1 Hz	50:50	RES	Amber	1 Hz	90:10
4	Ambient light or EMC disturbances	STS	Red	1 Hz	50:50	—	—	—	—
5	Short circuit between OSSDs to 24V DC (lockout) ⁽³⁾	STS	Red	1 Hz	50:50	OUT	Red	1 Hz	50:50
6	Error supply voltage ⁽²⁾	STS	Red	1 Hz	50:50	Stick type (transmitter or receiver)	Green	1 Hz	50:50
7	24V DC connected to transmitter plug-in input ⁽²⁾	STS (Tx)	Green	ON	100:0	Stick type transmitter	Green	1 Hz	50:50
8	Mixed design of 450L-B and 450L-E sticks or stick identification mismatch when beam coding is used	STS (Tx)	Red	1 Hz	50:50	Regional light intensity level 1 and level 2	Green	1 Hz	50:50
9	Invalid DIP switch setting	STS	Green	1 Hz	50:50	Stick type receiver	Green	1 Hz	50:50
10	Muting timing error (450L-E only)	STS (Rx)	Red	1 Hz	50:50	MUT	Orange	1 Hz	90:10
11	Muting sequence error (450L-E only)	STS (Rx)	Red	1 Hz	50:50	MUT	Orange	1 Hz	10:90
12	Blank error (450L-E only)	STS	Red	1 Hz	50:50	BLK	Orange	1 Hz	50:50
13	Cascade error (450L-E only)	STS	Red	1 Hz	50:50	CAS	Red	1 Hz	50:50

- (1) Error: If there is an error, remove the error source. For manual restart, activate the Restart button.
- (2) If there is a lockout, remove the lockout source. Lockout requires power recycling or adequate action (see [Table 55 on page 119](#)), [Manual \(Re\) Start on page 28](#), and [Optical Push Button on page 116](#).
- (3) The interpretation is first value on time, second value off time, for example, 10:90 means 10% on, 90% off.



ATTENTION: If automatic restart is used, the system starts immediately.

For fault conditions 0...13 and corrective actions, see [Table 55 on page 119](#).

Table 55 - Errors, Lockouts, and Corrections

Condition	Error Description	Action
0	Confirmation changed	See Confirmation of a New System Configuration on page 64 .
1	Internal lockout	<p>Make sure that the correct plug-in is inserted and that the DIP switch settings of the plug-in are in correct position.</p> <p>One of the following methods clears the lockout mode of a transmitter stick:</p> <ol style="list-style-type: none"> 1. Power down, then power up. If the fault is still present, the module lockout occurs again. 2. A reset signal longer than 10 seconds and less than 20 seconds acts like a power-up. 3. Press your finger on the optical push button longer than 10 seconds and less than 20 seconds (Optical Push Button on page 116) <p>If the fault persists, replace the 450L-B safety light curtain transceiver stick.</p> <p>Further diagnosis options are possible with the Connected Components Workbench™ software in combination with the USB/ optical interface device (OID; Cat No. 450L-AD-OID). If the 450L-B safety light curtain unit has a lockout, the exact fault description can be determined with these tools.</p>
2	EDM feedback signal at receiver plug-in not okay (external error)	<p>Short circuit between or to ground or over current at OSSDs</p> <ol style="list-style-type: none"> 1. Check wiring and function of external contactor 2. Check connected relay for closed contact (if OSSD ON-input “Relay monitoring” must have GND level, if OSSD OFF-input “Relay monitoring” must have +24V) 3. Repower the system or use adequate action after the lock out source is removed.
3	Start signal not okay	Check signal status and signal timing at receiver plug-in for the manual start
4	Ambient light can lead to short sporadic switch off the OSSD.	<p>Check system set-up and remove foreign ambient light source. Ambient light sources can be:</p> <ul style="list-style-type: none"> • Strong flashing beacon • Infrared remote controls • Laser pointers • Infrared light sensors
5	Short circuit between or to ground or over current at OSSDs	Check wiring and connected components at the two OSSDs
6	Error supply voltage	Check 24V DC power that is supplied to the stick
7	Voltage that is connected to transmitter plug-in input	Make sure DIP switch 4 is set to the default position (off). Make sure that the 24V DC voltage is not supplied to pin 4 of the 450L-APT-PW-5 part or voltage supply to pin 1 of the 450L-APT-PW-8 plug-in connector.
8	Stick identification mismatch when beam coding is used	Check design according to chapter: Beam coding on page 30
9	Invalid DIP switch setting	Make sure that the DIP switch settings of the inserted plug-in refer to one that is described in Receiver Plug-in DIP Switch Settings on page 60
10	Muting timing error (450L-E only)	Make sure that of the muting times are not above maximum or below minimum limits (see Muting on page 38)
11	Muting sequence error (450L-E only)	Make sure that the connected muting sensors are interrupted in the right sequence (see Muting on page 38)
12	Blanking error (450L-E only)	Make sure that beams of fixed blanked objects are always interrupted (see Teach-in Fixed Blanking on page 31)
13	Cascading error (450L-E only)	Make sure that the OSSDs of the connected safety component do not exhibit an error (see Cascading on page 48).
14	System cannot be aligned	<p>Make sure that both edges are parallel and installed at the same level.</p> <p>Make sure that the transparent front cover is clean, no dust and is not scratched.</p> <p>Make sure that the distance between transmitter and receiver is above the minimum distance.</p> <p>Make sure that the distance between transmitter and receiver is below maximum distance.</p> <p>Make sure that “low operation range” is not activated if operated above maximum range of the “low operation range” function</p>
15	OSSD outputs switch off sporadically	<p>Check all hints of condition 14 first</p> <p>Check that no ambient light from other sensors or sun or adjacent light curtain system can have an impact on the performance of a GuardShield safety light curtain system.</p> <p>Make sure that the power supply is adequate and the devices that are connected to the OSSD outputs are within the limits.</p> <p>Make sure that the GuardShield safety light curtain connection cables are not parallel to high-power supply cables of the application</p>

IMPORTANT Conditions 0 . . . 13 of [Table 54 on page 118](#) show the status indicator for condition numbers 0 . . . 13 in [Table 55](#).

Optical Interface Device (OID)

More service information is available by using the optical interface device (450L-AD-OID) and the Rockwell Automation Connected Components Workbench package. This device can be snapped on a stick and used to visualize (for example) the protective field status if connected to a computer via a USB interface. The required Connected Components Workbench software is available from rok.auto/ccw.

Figure 79 - Optical Interface Device Snapped on a GuardShield Safety Light Curtain

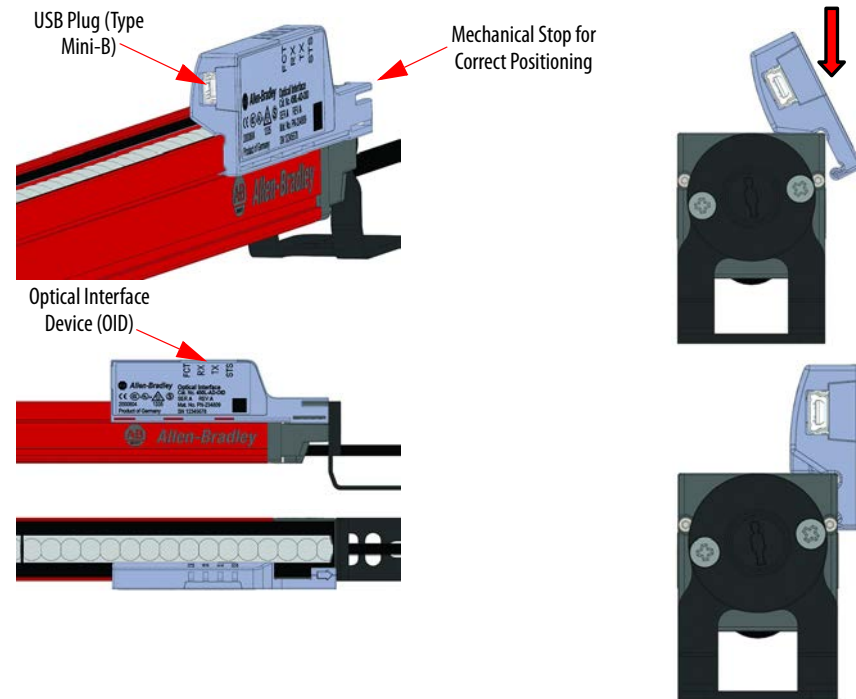

The Optical Interface Device (OID) has a USB interface for connection to a personal computer for diagnostic purposes. Use a standard USB A Male to USB Mini-B Male cable for connecting to the OID. The OID is delivered including a USB (Type A <--> Type Mini-B) 1 m (3.28 ft) long connection cable (catalog number 2711C-CBL-UU02). The device must be positioned correctly at the end of the protective field (2) above the status indicators to allow communication. First move the latch of the interface close to the bottom end cap so that it touches the end cap and rotate it so that it snaps in.

The OID can be used when the light curtain is mounted with the top/bottom and/or the side mounting kit. If there is a weld shield, the weld shield has to be removed before the OID can be installed.

IMPORTANT We continuously improve and expand the functionality of the GuardShield safety light curtain product line. Therefore, new firmware releases may be available. For diagnostic purposes, make sure that both sticks (Rx and Tx) and the OID are operated with the latest available firmware revision.

Troubleshoot with Connected Component Workbench Software

When connected to the GuardShield safety light curtain through the USB port with the Optical Interface Device, the Connected Component Workbench diagnosis function displays the status of the connected stick. If there is an error, detailed diagnostic information of the corresponding stick is provided.

IMPORTANT We continuously improve and expand the functionality of Connected Component Workbench software. Therefore, new software releases could be available. For diagnostic purposes, make sure that the Connected Component Workbench software and the OID are operated with the latest firmware revision. Update the Connected Component Workbench software to the latest version.

Notes:

Safety Instructions



LASER LIGHT CLASS 2 HAZARD: Do not stare into beam. The 450L-E safety light curtains are equipped with an integrated laser alignment aid (see [Laser Alignment on page 20](#)).

Maintenance



ATTENTION: Never operate the 450L safety light curtain before conducting the [Regular Inspection](#). Improper inspection can lead to serious, or even deadly, injury.

Confirm that all power to the machine and safety system is disconnected during electrical installation.

Before powering up the 450L safety light curtain system, the responsible person reviews the checklist:

- For safety reasons, all inspection results are recorded.
- Only people who clearly understand the function of the 450L safety light curtain and the machine, can perform the inspection.

If the installer, engineer, and operator are different people, they all must have sufficient information available for the inspection.

Regular Inspection

The following inspection actions must be done regularly. For example, the frequency of inspection must be daily or according to the risk assessment.

1. Approach to hazardous machine parts must only be possible by passage through the GuardShield™ safety light curtain protective field.
2. Operators cannot step through the sensing area while working on dangerous machine parts.
3. The safety distance of the application is bigger than the calculated value.
4. The optic front cover is not scratched or dirty.

The inspection interval for [1...4](#) are:

- Daily or whenever the machine setting is changed (electrical or mechanical).
- Whenever a light curtain component (stick and/or plug-in) is replaced.
- According to the requirements of local regulation or an application-specific standard.
- According to the inspection instruction and the risk assessment of the application.

Operate the machine and check if the hazardous movement stops under the following circumstances.

- The protective field is interrupted.
- If the test rod directly in front of the transmitter or receiver or between the transmitter and receiver, interrupts the protective field, the hazardous machine movement stops immediately ([Figure 80 on page 125](#)).
- There is no hazardous machine movement while the test rod is anywhere within the protective field.
- Make sure that there are no reflective surfaces within the calculated distance (see [Minimum Distance from Reflective Surfaces on page 71](#)).

Before introducing the test rod, verify that the protective field is free. Both intensity indicators are green at the stick, which acts as the receiver (see [Figure 81 on page 136](#)). If the two intensity indicators are not green, adjust the sticks until the intensity indicators are green. Move the test rod through the protective field as indicated in [Figure 80 on page 125](#). Use test rod 450L-AT-14 for the light curtain with finger resolution (14 mm [0.56 in.]) and test rod 450L-AT-30 for the light curtain with hand resolution (30 mm [1.19 in.]). The catalog number of the test rod is printed on a label on each rod. The protective field must always be interrupted:

- If the test rod is placed at any angle anywhere within the protective field (static)
- If the test rod is moved (according to [Figure 80 on page 125](#)) with the axis of the test rod normal to the plane of the detection zone, at any speed from 0...0.3 m/s (dynamic).

The interruption of the protective field is displayed at the indicator diodes. Verify that the minimum of one intensity indicator ([Figure 39 on page 75](#)) is off as long as the test rod is in the protective field. If both intensity indicators are simultaneously green or blinking green during the static and dynamic testing, the resolution to operate the application is not fulfilled.

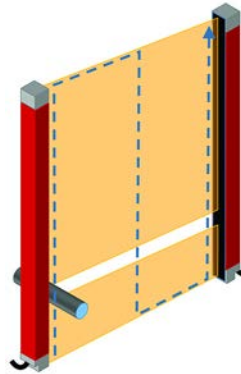

ATTENTION: If any of the previous conditions do not stop the hazardous motion of the machine or simultaneously lead to two green intensity indicators (see [Figure 39 on page 75](#)), then do not allow the machine to be placed into operation.

Figure 80 - Proper Testing of Protective Field Using Test Rod

IMPORTANT If one or more mirrors are used (see [Mirrors on page 74](#)), inspect each protective field separately. The movement of the test rod is also performed directly in front of the mirrors.

Additionally, a more detailed inspection has to be conducted.

- Whenever a machine setting is changed
- The local regulation or an application-specific standard requires an inspection
- According to the inspection instruction and the risk assessment of the application
- Frequently (for example, every six months)

A more detailed inspection must consider these actions:

- Machine stops or does not obstruct any safety function.
- The latest machine or connection modifications have no effect on the control system.
- The outputs of the GuardShield safety light curtain are properly connected to the machine.
- The total response time of the machine is shorter than the calculated value.
- Cables and plugs of the GuardShield safety light curtain are in flawless condition.
- Mounting brackets, caps and cables are tightly secured.
- Optical windows and components (mirrors or weld shields) are clean.

IMPORTANT Document the test results, sign, and file them appropriately.

Clean Optic Front Window

The effectiveness and the reliability of the safety light curtain system is reduced if the optic front window of the GuardShield safety light curtain is dirty. Regularly clean with a soft cloth and rub without pressure. Do not apply aggressive or abrasive agents, which can attack the surface.



LASER LIGHT HAZARD: Do not stare into beam. 450L-E safety light curtains are equipped with an integrated laser alignment help (see [Laser Alignment on page 24](#)).

Disposal

The GuardShield safety light curtain has been designed according to the main environmental protection directives (for example, RoHS). Always dispose of unserviceable devices in compliance with local/national rules and regulations.

Product Labels

The address that is printed on the stick and on the plug-in products and packaging labels refers to the Rockwell Automation global address. For the regional office addresses, see the listing on the back cover of this publication.

Stick Labels

Figure 81 - Explanation of Date Code on a Stick [1335: Year 2013, Week: 35; Serial Number 450L-B Is 1068700055; 450L-E is 1068800055] (Printed Before November 2018)

 GuardShield™ 450L-B Cat. No. 450L-B4HN0150YD Ser A Rev A 2.001 Mat. No. PN-250474 IDN: 1068700055 Rockwell Automation, S. 2nd St. Milwaukee, WI 53204, USA		Safety Category: Type4, Cat4, PL e/SILcl3 2000804 1335 Product of Germany Rockwell Automation, S. 2nd St. Milwaukee, WI 53204, USA	Prot. Height/Res.: 150/30mm Resp. Time: < 13ms +Ta (See User Manual: 445L-UM001) Operating Range: 0.9...6.5m Enclosure Rating: IP65 Ambient Temp.: -10°...+55°C Power: Class 2, 24VDC ±15%	    ESPE 24XE
 GuardShield™ 450L-E Cat. No. 450L-E4FL0150YD Ser A Rev A 2.001 Mat. No. PN-412764 IDN: 1068800055 Rockwell Automation, S. 2nd St. Milwaukee, WI 53204, USA		Safety Category: Type4, Cat4, PL e/SILcl3 2000804 1335 Product of Germany Rockwell Automation, S. 2nd St. Milwaukee, WI 53204, USA	Prot. Height/Res.: 150/14mm Resp. Time: < 9 ... 30ms + Ta (See User Manual: 450L-UM001) Operating Range: 0.5 ... 9m Enclosure Rating: IP65 Ambient Temp.: -10°...+55°C Power: Class 2, 24VDC ±15%	    ESPE 24XE

Figure 82 - 450L Transceiver Stick Label (Printed Since November 2018). Production date code: yyyy/mm/dd

 GuardShield™ Cat. No. 450L-B4HN0150YD Ser A FW PN-250474 PRODUCT OF GERMANY Rockwell Automation, 1201 S 2nd St, Milwaukee, WI 53204, USA		Prot. Height/Res: 150/30mm Operating Range: 0.9 ... 7m Enclosure Rating: IP65 Ambient Temp: -10°...+55°C Resp Time: < 13ms + Ta (See User Manual: 450L-UM001)	Safety Category: Type4, Cat4, PL e/ SILcl3 Power: Class 2, 24VDC ±15% SN 00887172376788 4040 2018/11/06	    ESPE 24XE
 GuardShield™ Cat. No. 450L-E4FL0150YD Ser A FW PN-412764 PRODUCT OF GERMANY Rockwell Automation, 1201 S 2nd St, Milwaukee, WI 53204, USA		Prot. Height/Res: 150/14mm Operating Range: 0.5 ... 9m Enclosure Rating: IP65 Ambient Temp: -10°...+55°C Resp Time: 9 ... 30ms + Ta (See User Manual: 450L-UM001)	Safety Category: Type4, Cat4, PL e/ SILcl3 Power: Class 2, 24VDC ±15% SN 00889508563404 4040 2018/11/06	    ESPE 24XE

Figure 83 - 450L-E Laser Warning Label (Positioned on the Backside of the Aluminum Profile)



Plug-in Label

Figure 84 - Explanation of Date Code at a 450L Plug-in [1337: Year 2013, Week: 37; Serial Number Is 123456]

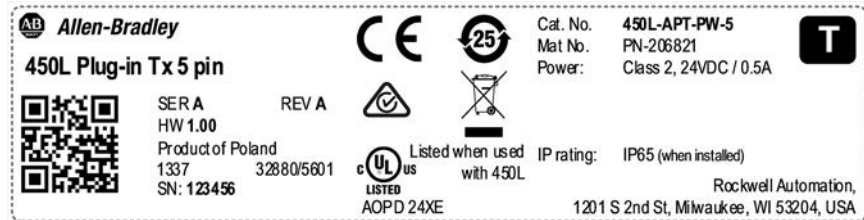

A black square with a gray letter quickly indicates the principle type of plug-in ([Figure 84](#)).

IMPORTANT The catalog number is also printed on the plug-in housing, which is inside the transceiver stick.

Notes:

Connected Components Workbench Software

Overview

The Connected Components Workbench™ software can be used to monitor the 450L light curtains and to configure the 450L-E version. The Bulletin 450L has two versions:

- 450L-B: Basic ON/OFF
- 450L-E: Enhanced features

The Connected Components Workbench software can only monitor the 450L-B version; the 450L-B does not have configurable parameters. The advantage of 450L-E safety light curtain is that Connected Components Workbench software can monitor and configure it. Use the Connected Components Workbench software to do the following:

- Setup
 - Muting
 - Floating blanking
 - Reduced resolution
 - Fixed blanking
 - A combination of floating, reduced resolution, and fixed blanking
- Diagnostics
 - Know which beams are blanked or blocked
 - Review last 10 lockout codes
- Export the configuration to a file

The Connected Components Workbench software performs its function with the 450L-OID Optical Interface Device (OID). For more information on the OID, [Optical Interface Device \(OID\) on page 120](#).

Multiple Subconfigurations

This manual assumes that the Connected Components Workbench software, Version 12 or later has been loaded.

Start a New Project

The following example uses the Connected Components Workbench software (version 12) loaded onto a Windows® 10 environment.

[Figure 85](#) shows the Windows “Start” icon.

1. Click the windows “Start” icon in the lower left corner.
2. Scroll down to Rockwell Automation. Expand the selection and click Connected Components Workbench.

Figure 85 - Start Menu

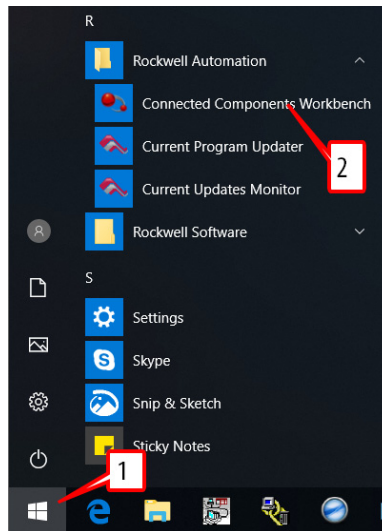

[Figure 86 on page 131](#) shows the Start Page. This page allows you to do the following:

- Create a project
- Open an existing project
- Open a recent project
- Open online training videos (requires an internet connection)

You can bypass this page by clearing the Show page on startup checkbox.

3. Start a new project three ways:
 - Click New... under the “Project” heading.
 - Click File in the main menu, then click New.
 - Press Ctrl-N on your keyboard.

Figure 86 - New Project

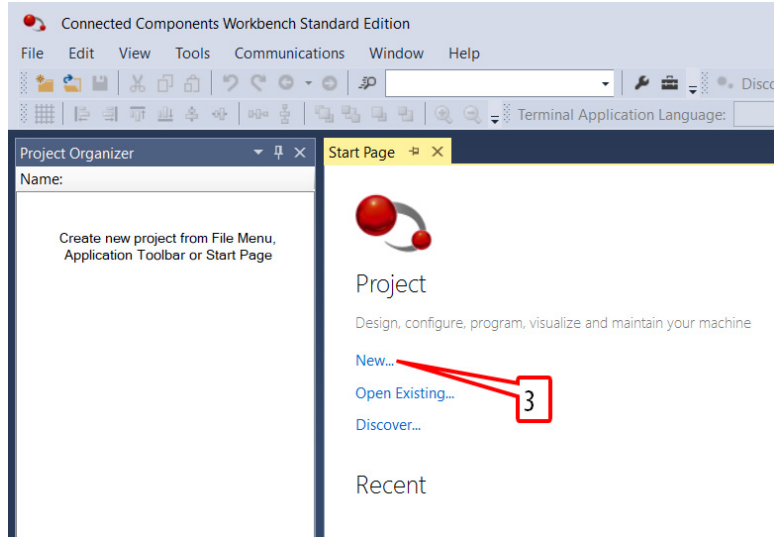

[Figure 87](#) shows the New Project window. The Connected Components Workbench software maintains a list of projects to help prevent you from overwriting an existing project. The name of each new project increments by one (for example, Project90). This window allows you to customize the name and browse for a location for the file.

4. Type a new name, for example, “My 450L Project.”
5. Click Create.

Figure 87 - Project Name

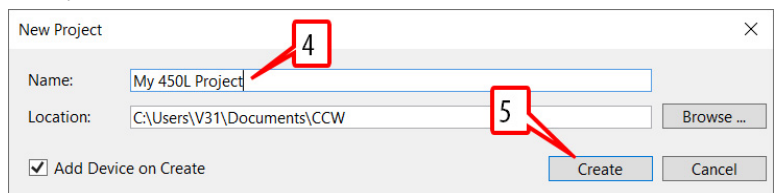

[Figure 88 on page 132](#) shows the Add Device window.

6. Expand the Safety listing.
7. Expand The Bulletin 450L Light Curtains.
8. Click the Bulletin 450L.
9. Select the version number that matches the stick firmware.
10. Click Select.

Figure 88 - Add a Device

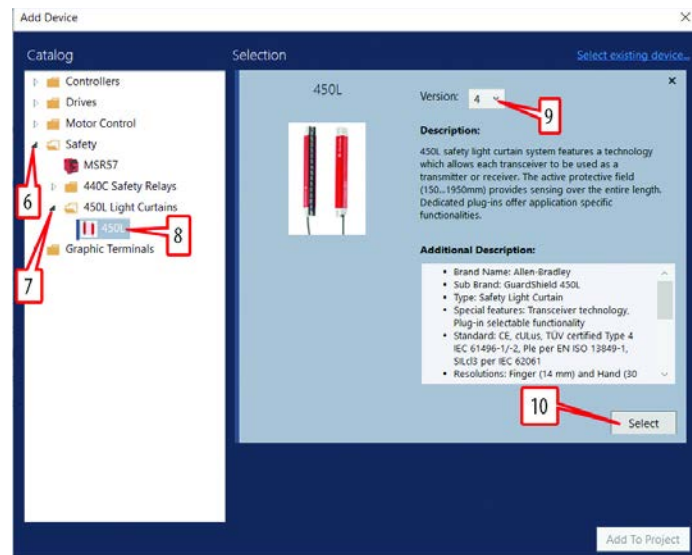

TIP To determine the current firmware revision of the light curtain, open RSLinx® software, right-click the Bulletin 450L, and click Device Properties. An example is shown in [Figure 89](#).

Figure 89 - Firmware Revision

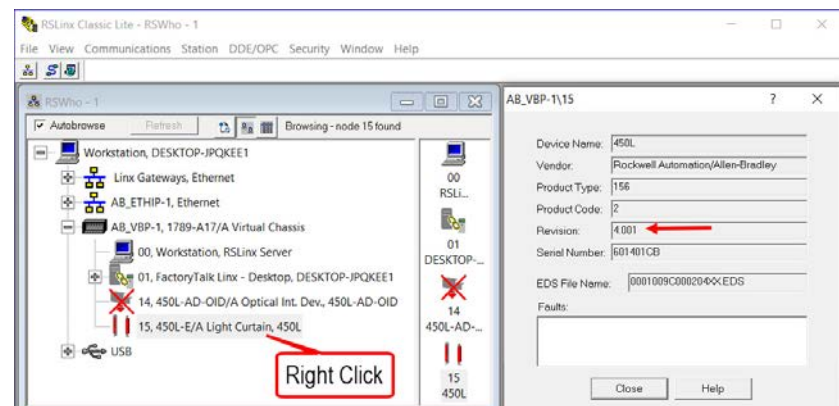

The firmware selection process is confirmed in [Figure 90 on page 133](#).

11. Verify that the selection and firmware revision are correct and click Add to Project.

Figure 90 - Add to Project

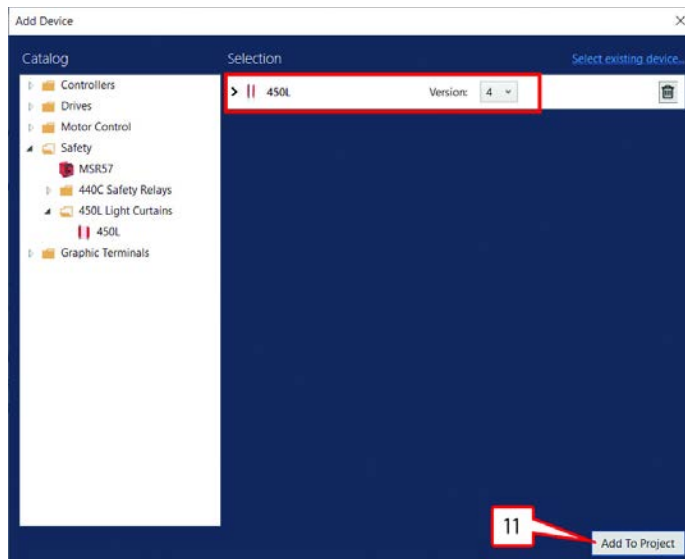

[Figure 91 on page 133](#) shows the Bulletin 450L light curtain device in the Project Organizer.

The project name appears in the title of the window and in the Project Organizer. In this example, the light curtain project name is “My 450L Project.”

The Bulletin 450L device appears in the Project Organizer with the default name “450L_1.” If desired, the name of the safety controller can be changed. Click the name to change the name of the light curtain (or right-click and select Rename). This step is not required to complete the configuration or to run the Bulletin 450L. The name that you choose must follow these rules:

- No special characters, except underscore
- No double underscore
- 1...32 characters

An asterisk appears after the controller name and project name to indicate that a valid project has not yet been saved.

12. In the Project Organizer, double-click the device name or icon to open the product configuration tab.

Figure 91 - Project Created

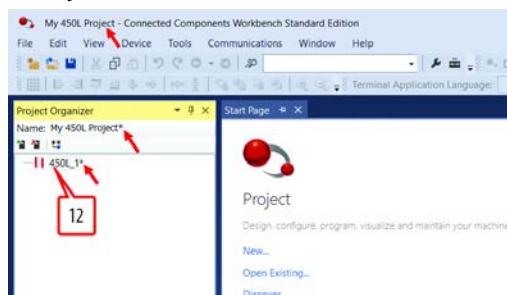

Workbench Layout

Figure 92 on page 134 shows the six major sections of the workbench layout.

- Project Organizer – shows all devices that are contained in the project.
- Header – shows the device identity and the connection information.
- Toolbar – shows the operations/commands for the Bulletin 450L device. The set of operations for Bulletin 450L-B and Bulletin 450L-E (DIP switch 1=OFF) are: Diagnose, Report, Manual, Help. The set of operations for Bulletin 450L-E (DIP switch 1=ON) is: Download, Upload, Diagnose, Report, Manual, and Help.
- Graphic – shows a graphical representation of the light curtain device and the system mode status. The graphic pane can be minimized to expand the Configuration Pane and Diagnostic Information.
- Configuration Tree – provides the navigation to the configuration of a light curtain.
- Configuration Pane – sets the configuration details of the Bulletin 450L-E light curtain. The content of this pane coincides with the selection in the Configuration Tree.

Figure 92 - Project Opened – Workbench Layout

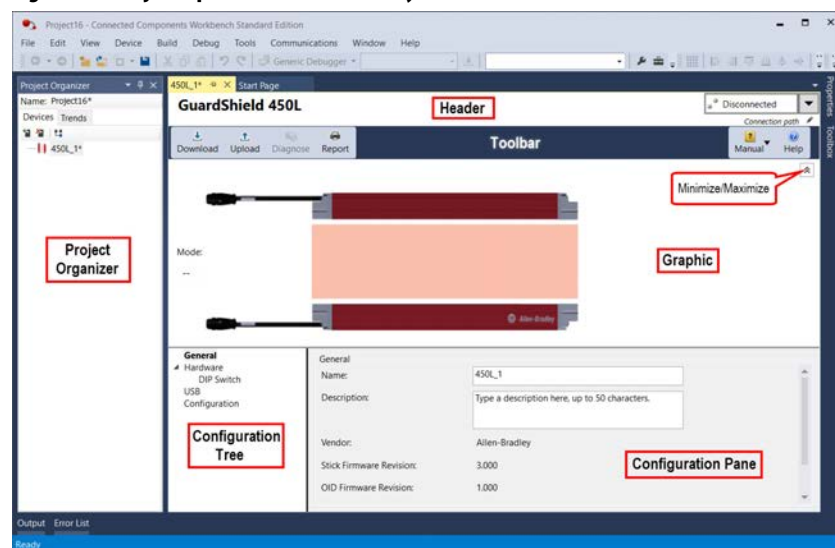

Project Organizer

[Figure 93](#) shows an example with multiple devices that are used in the project. Click the icons in the Project Organizer add, remove, or discover devices.

Figure 93 - Add, Remove, and Discover Devices

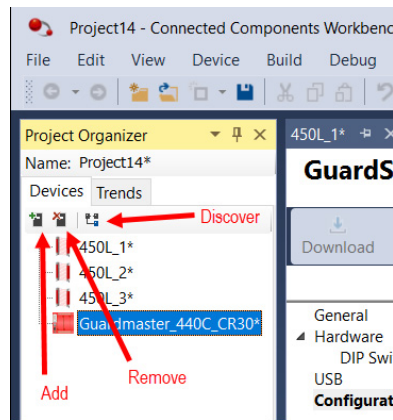

General

[Figure 94 on page 135](#) shows the General setup. The device is automatically assigned the name 450L_1 and this name can be customized. A 50-character description can also be entered. This description shows the vendor, Stick Firmware Revision, OID Firmware Revision. If installed, the Cascading Plug-in Firmware Revision is also shown.

Figure 94 - General Setup

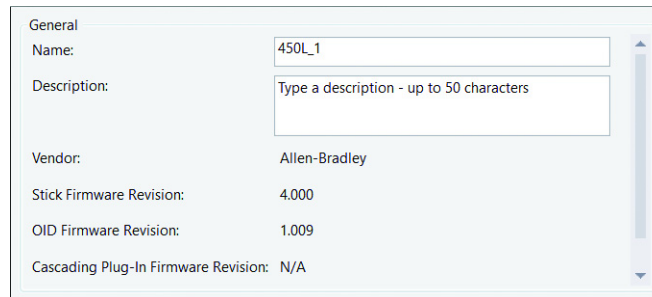

Hardware

[Figure 95](#) shows the hardware setup. Select the appropriate values to match the light curtain in use.

Figure 95 - Hardware Setup

Hardware	
450L Type	E
Series	A
Length	600mm (23.6 in)
Resolution	14mm (0.56 in)
Laser	Integrated
Catalog	450L-E4FL0600YD
Connection plug-in Tx	450L-APT-PW-8
Connection plug-in Rx	450L-APR-MU-8
Cascading plug-in Tx	None
Cascading plug-in Rx	None

DIP Switch

[Figure 96 on page 136](#) shows the hardware DIP switch settings for the connection plug-in. The graphic is updated to match the actual switch settings when a connection is made to the device.

To use the Connected Components Workbench software to configure the Bulletin 450L-E light curtains, switch 1 must be set to ON and all other switches set to OFF. If switch 1 is OFF, then the Connected Components Workbench software shows the status of the light curtain.

Figure 96 - Hardware DIP Switch Settings

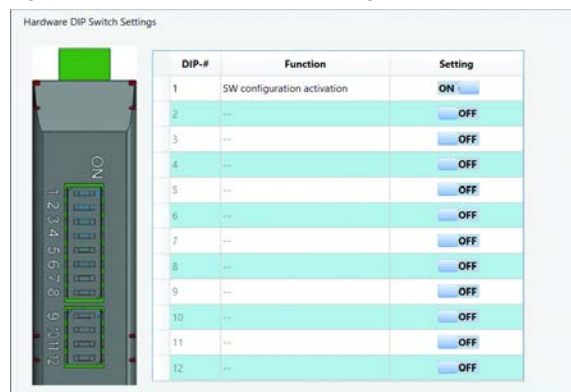

USB Status

[Figure 97](#) shows the status of the USB connection. The status is read-only.

Figure 97 - USB Status

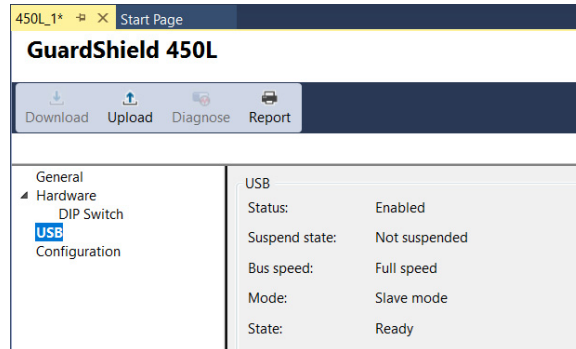

Sub-configurations

[Figure 98 on page 137](#) shows the subconfiguration setup. The subconfiguration setup is only available when the OID is connected to a receiver; the transmitter does not require a configuration.

Key elements of subconfigurations include:

- With DIP switch 1 set to ON, up to four subconfigurations can be created.
- The General, Muting, and Blanking settings can be adjusted for each sub-configuration.
- If a cascading plug-in is installed, the Cascaded Safety Component is automatically refreshed when a configuration is uploaded from the light curtain.
- The four configurations use the same GPIO.
- If DIP switch 1 is set back to 0, the configuration via the Connected Components Workbench software is erased.

Figure 98 - Sub-Configuration Setup

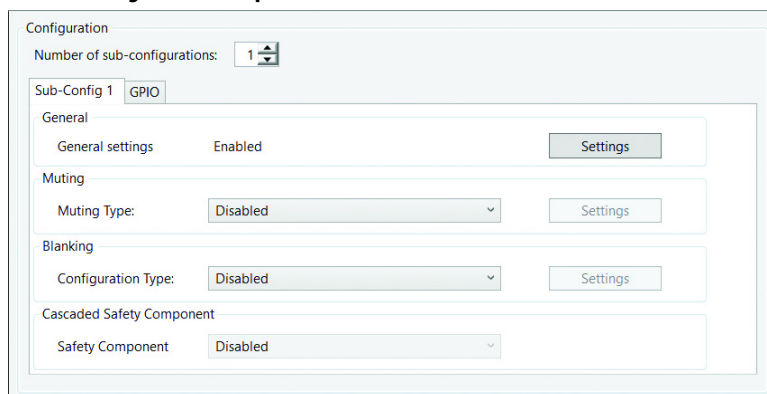

General Settings

Figure 99 shows the default general settings. The general settings apply to both the muting and blanking functions, if these functions are enabled. See Table 56 on page 139 for descriptions of each setting.

Figure 99 - General Settings

General settings		
Start mode	<input type="checkbox"/>	Automatic start
Start release	<input type="checkbox"/>	Disabled
EDM enable	<input type="checkbox"/>	Max. EDM reaction time Disabled ms
Operating range	<input type="checkbox"/>	Long range
Beam coding	<input type="checkbox"/>	Disabled
External test enable	<input type="checkbox"/>	Logic external test: Disabled
Multiple scan	<input type="checkbox"/>	Disabled
Short interruption ignore	<input type="checkbox"/>	Short interruption ignore time Disabled ms
OSSD threshold time		"ON" threshold 250 ms
		"OFF" threshold 500 ms
Laser switch off time	<input type="checkbox"/>	240 s
Configured response time	N/A ms	Upload configuration to see configured response time
Configured resolution	14 mm	

Table 56 - General Setting Descriptions

Setting	Description
Start mode	<p>Can only be selected for 8-pin Rx plug-in or for 5-pin Rx plug-in with I/O cascading plug-in. The selections are:</p> <ul style="list-style-type: none"> Automatic start – If the light curtain is clear, the OSSD outputs turn ON. This mode applies to power-up and after power-up. Power up Start Interlock – Upon power-up, the start must be pressed and released within a window of 50...5000 ms. After power-up, the OSSD output operates automatically. Manual Start – Upon power-up and after the OSSDs turn OFF, the start must be pressed and released within a window of 50...5000 ms. The OSSD outputs energize on the trailing edge of the start signal. Manual Start with Off Function – Upon power-up and after the OSSDs turn OFF, the start must be pressed and released within a window of 50...5000 ms. The OSSD outputs energize on the trailing edge of the start signal. The OSSD outputs can also be turned OFF with the start.
Start release	<p>Start release function can be selected with either the 8-pin Rx plug-ins or the 5-pin plug-ins with an I/O plug-in. Start Release and EDM cannot be ON simultaneously.</p> <p>When the light curtain is clear, the OSSD outputs energize on the leading edge of the start release input.</p>
EDM enable	<p>EDM function can only be selected with 8-pin Rx plug-ins. Start Release and EDM cannot be ON simultaneously.</p> <p>The EDM input must change state within the selected time. If the EDM signal does not change state, the OSSD outputs de-energize and the light curtain is locked out; a lock out requires a power cycle to clear the fault.</p> <ul style="list-style-type: none"> Min: 50 ms Max: 1275 ms Increment: 5 ms Default: 300 ms (when enabled)
Operating range	Allows you to set the operating range to either long range (default) or short range.
Beam coding	Enables beam coding. Beam coding helps prevents interference from neighboring light curtains. The response time increases if beam coding is selected.
External test enables	Enables an input to either turn the OSSD outputs ON or OFF.
Multiple scans	Defines whether the light curtain operates in a multiple scanning mode. When enabled, multiple scan modes only turn OSSDs OFF if there are at least three consecutive scans with an interruption. The normal mode of operation is the double-scan, which turns OSSDs OFF if there is an interruption in at least two consecutive scans. This extra measure of resiliency against spurious trips adds an additional 33% (approximately) to the response time.
Short interruption ignored	<p>You can define a filter time to ignore short interruptions of the light curtain.</p> <ul style="list-style-type: none"> Min: 0 ms Max: 174 ms Increment: 2 ms <div style="border: 1px solid black; padding: 5px; margin-top: 10px;">  <p>ATTENTION: Setting the response time longer than 90 ms may allow a person to walk through the light curtain undetected. Safety distance/physical barriers must be adjusted accordingly.</p> </div>
OSSD threshold time	<p>You can define a filter time the OSSD outputs from changing too quickly. This function is applicable when the OSSD outputs are connected to electromechanical devices like relays and contactors, and the light curtain is set for automatic start.</p> <p>If the light curtain is broken and cleared more than twice within the OFF time, the OSSD outputs turn OFF during the ON time. The ON time must be equal to or greater than the OFF time.</p> <ul style="list-style-type: none"> Min: 30 ms Max: 5000 ms Default: ON 500 ms, OFF 250 ms
Laser switch off time	<p>If enabled, the laser turns off automatically after the selected time expires.</p> <ul style="list-style-type: none"> Min: 0 s Max: 255 s Increment: 1 s
Configured response time	The response time is automatically adjusted based on protective height, multiple scanning, beam coding, and short interruption ignore functions.
Configured resolution	The resolution is automatically adjusted when reduced resolution or floating blanking are configured.

GPIO

Figure 100 shows an overview of the layout of the General Purpose Input Output (GPIO) window. The window has three significant areas:

1. Connection plug-in
2. Cascading plug-in
3. Message box — informs you whether the mandatory GPIO has been specified

The configuration cannot be downloaded to the stick until the mandatory GPIO is completed. When completed, the message box has a green background.

Figure 100 - GPIO Overview

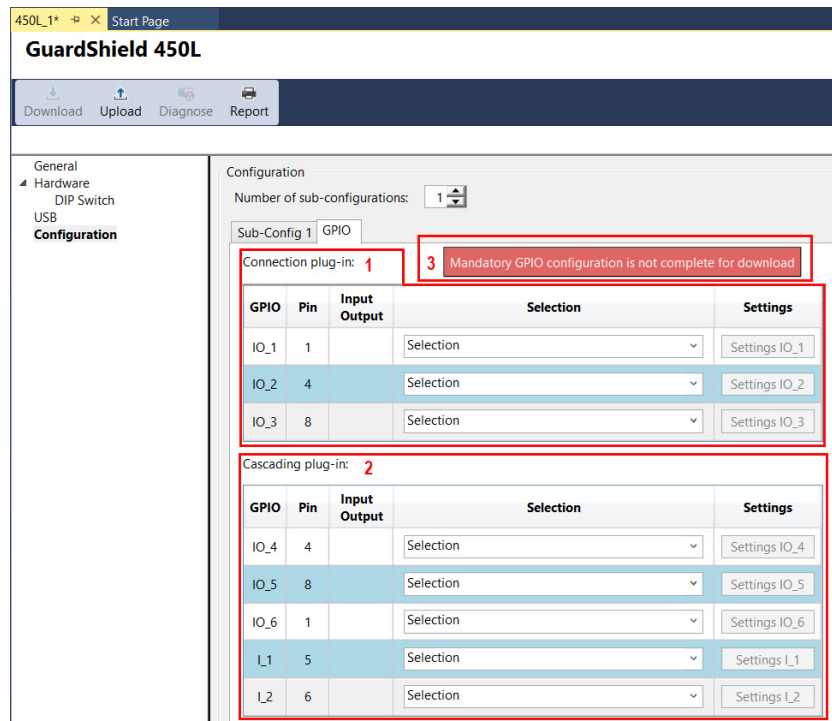

Figure 101 on page 141 shows an example of the General Purpose Input Output selections. The Connected Components Workbench software automatically determines the available pins on the connection [1] and cascading [2] plug-ins. A message [3] is displayed to show whether mandatory configuration points are selected. When complete, the message background turns from red to green.

The subconfiguration setup automatically determines the available selections. This selection is a four-sensor muting example with two subconfigurations. The connection plug-in has three I/O and the cascading plug-in has three I/O (inputs or outputs) and two I (inputs).

The selection for IO_1 shows seven mandatory inputs. Three of the mandatory inputs have white boxes. At least two of the three mandatory inputs must be assigned to the connection plug-in. The third mandatory input can be assigned to the connection or cascading plug-in. The four mandatory muting sensors are disabled as these sensors can only be assigned on the cascading plug-in.

With eight potential I/O and seven mandatory inputs, one of the I/O can be used for the optional inputs or outputs.

Figure 101 - GPIO Selection Settings

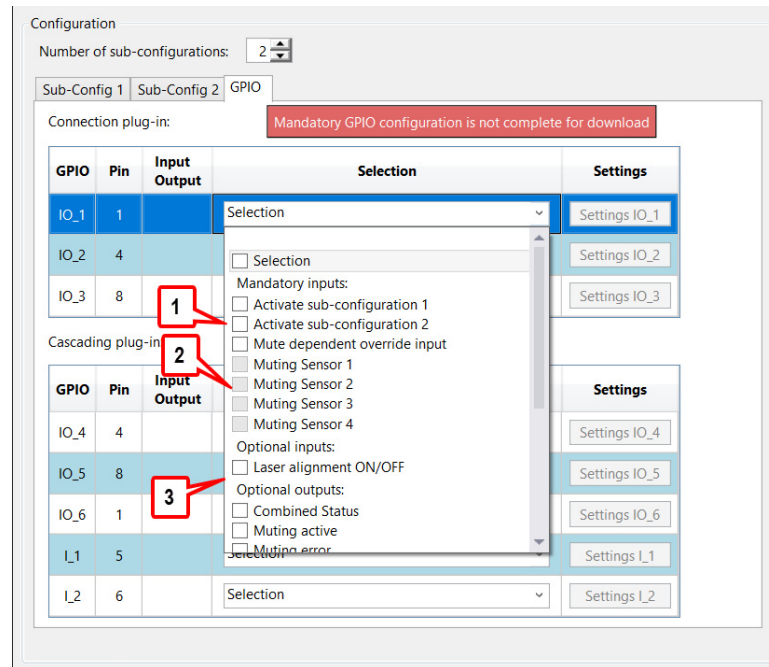

Item	Description
1	Mandatory inputs
2	Mandatory muting sensors
3	Optional inputs or outputs

[Table 57 on page 142](#) lists the possible selections and their descriptions. The possible selection choices are dependent on the hardware and automatically determined by the Connected Components Workbench software. See [Table 56 on page 139](#) for detailed descriptions of the selections.

Table 57 - GPIO Selections

I/O	Selection	Description
Input	Activate subconfiguration #	Activates this subconfiguration. Only one subconfiguration can be active. At least one subconfiguration must be active.
	External device monitoring	Monitors external devices that the light curtain OSSD outputs drive.
	Laser alignment ON/OFF	Turns the integrated laser alignment function ON and OFF.
	Manual (re)start	Input turns on the OSSD outputs if the light curtain is clear.
	Mute dependent override	Turns on the OSSD outputs if a muting error occurs and the light curtain is blocked.
	Muting sensor #	Indicates that a sensor is blocked.
	Start release	With the light curtain clear, the start release input turns on the OSSD outputs on the leading edge of the signal.
	Test input	Turns the OSSD outputs ON or OFF, depending on the configuration.
Output	Combined status	Indicates the logic applied to the combined status of two parameters are satisfied.
	Muting active	Indicates when muting is active. The appropriate muting inputs (signals/sensors) go low within the T(sens) time and within the proper sequence.
	Muting error	Indicates when either a muting timing error or muting sequence error is present.
	Muting sequence error	Indicates that the muting inputs occurred in an incorrect order.
	Muting timing error	Indicates the T(sens) time or the T(espe) time are exceeded.
	Start	Indicates that the light curtain is waiting for the start input. After the OSSD outputs energize, the start output turns OFF.
	Status EDM/start release	Indicates the status of the EDM or start release input.
	Status error (lockout/external error)	Indicates that a lockout or external error has occurred.
	Status external error	Indicates that an external error has occurred.
	Status intensity (cascading end)	The intensity of one or more of the beams on the cascading half (top side) of the light curtain is below Good Intensity. This occurrence is reported as Diagnostic Parameter 3.14.
	Status intensity (connection end)	The intensity of one or more of the beams on the connection half (bottom side) of the light curtain is below Good Intensity. This occurrence is reported as Diagnostic Parameter 3.124.
	Status intensity (connection/cascading end)	The intensity of one or more of the beams on the connection half (bottom side) or the cascading side (top side) of the light curtain is below Good Intensity. This occurrence is reported as Diagnostic Parameter 3.12 and 3.14.
	Status lockout	Indicates that a lockout status has occurred.
	Status mutes dependent override	Indicates that the mute dependent override signal is active.
	Status OSSD outputs	Indicates the status of the OSSD outputs.
Status helps protected field free	Indicates the status of the whole helps protected height (both the bottom side and the top side) of the light curtain.	
Status test input	Indicates the status of the test input.	

Figure 102 shows the settings that can be made for each of the I/O types. The Connected Components Workbench software automatically determines the allowable selections.

- Many inputs can be assigned High/Low logic and have filter times that are adjusted from 0...255 ms.
- Muting, Cascading OSSD and (Cascading) E-stop inputs have the logic that is fixed at Low Active and cannot be changed.
- Cascading OSSD input filter times range from 3...255 ms.
- E-stop input filter times range from 4...255 ms.
- The outputs only have logic options.

The Combined Status output allows and/or logic to be applied to two selectable status outputs.

Figure 102 - GPIO Selection Settings

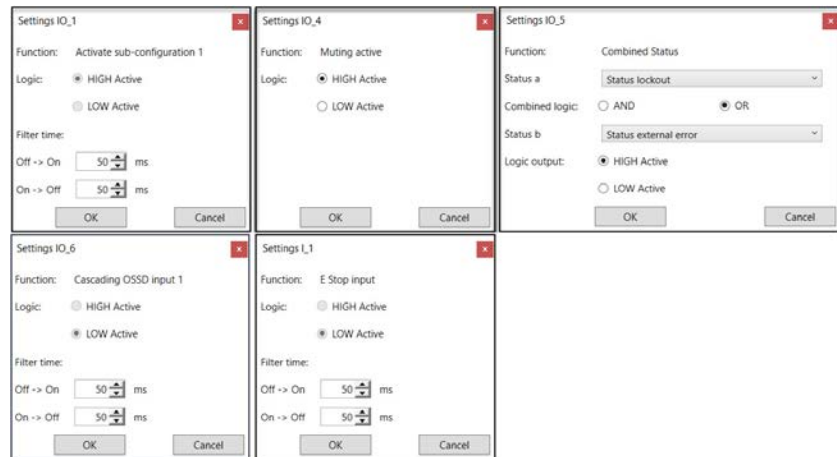

Diagnose Window

Figure 103 shows the Diagnose window layout. The Diagnose window is only available when the Connected Components Workbench software has a connection with the light curtain. This layout has three regions:

- Toolbar
- Graphic
- Diagnostic parameters

Figure 103 - Diagnose Window Layout

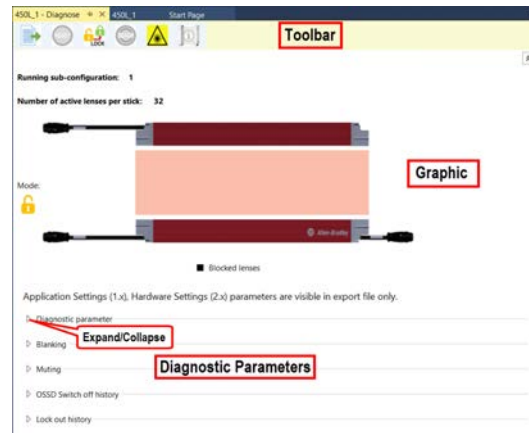

Export

The Export creates a csv file of the complete light curtain hardware setup and all available diagnostic data.

Before saving to a file, one dialog window, which contains default full name (path and file name) is provided to you. You can change the saving path or the saving name. After you press Save, the parameter information is exported to the pointed folder. The default path and file name are:

- Default path: C:\Users\Current User\Documents\CCW\Project Name
- Default file name: 'Device Name' + '_' + 'YYYYMMDD'

Reset

The Reset clears a light curtain that has been locked out. After you resolve the lock out condition and press Reset, the light curtain powers off and then powers on. The stick disconnects from the Connected Components Workbench software because of this power off/on cycle.

Lock

All new and changed configurations must be locked before run mode. The Lock is enabled if the light curtain is in unlocked mode and is disabled if device system is in run mode. After locking, the configuration active window in [Figure 104](#) appears. The light curtain is disconnected from the Connected Components Workbench software.

Figure 104 - Configuration Active

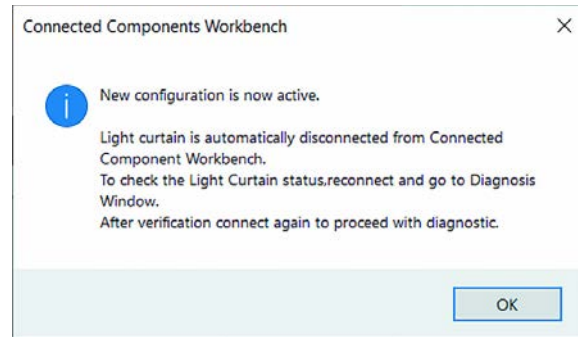

Mode

The mode symbol provides a quick way of determining the operating status of the light curtain.

Symbol	Description	Explanation
	Error	Mouse over the icon for additional information.
	Run	The configuration is locked, and the light curtain is in run mode.
	Unlocked	The light curtain configuration must be confirmed.
	Lock out	See the diagnostic 7.1. Upload and click Reset.

Teach

Teach is only shown when the Connected Components Workbench software is connected to a Bulletin 450L-E. Teach is only enabled when:

- The connection plug-in is either catalog number 450L-APR-BL-5 or catalog number 450L-APR-MU-8,
- The stick status is “Run mode after synchronization,” and either:
 - DIP switch 1 is set to ON, and the Blanking Configuration Type is set to Push Button Teach-in, or
 - DIP switch 1 is set to OFF, and
 - Switch 5 is ON when using the catalog number 450L-APR-BL-5, or
 - Switch 8 is OFF and switch 9 is ON when using the catalog number 450L-APR-MU-8.

Teach blanking can also be accomplished in the Blanking Configuration window.

Laser

The Laser turns the Integrated Laser Alignment ON and OFF. The Laser is only shown when the Connected Components Workbench software is connected to a Bulletin 450L-E.

A confirmation window is shown when the Laser is turned ON and when it is turned OFF.

Beam Status



The Beam Status provides a snapshot table of the status of each individual beam at each lens. The length of the table is equal with the number of lenses of the connected stick. An example of the Beam Status table is shown in [Figure 102 on page 143](#). The information that is provided is:

- Connected stick is a Tx or an Rx
- Snapshot date
- Snapshot time
- Cascade number
- Lens number
- Beam status – Free or Blocked
- Beam intensity – Low, Med-Low, Med-High, High, N/A when the beam status is Blocked.
- Blanking status – no blanking, fixed blanking, reduced resolution, or floating blanking.
- Muting status – Free (not muted) or muting active

The export provides the user the option to export the data in an *.CSV file.

- Default path: C:\Users\Current User\Documents\CCW\Project Name
- Default name: ‘Device Name’ + ‘_’ + ‘BeamStatus’ + ‘_’ + ‘MMddyyyy’ + ‘_’ + ‘hhmmss’

Blanking Example – In [Figure 105 on page 147](#), lenses 1 and 2 are fixed blanking. Beams 3...14 are floating blanking, with beam 10 blocked. Beams 15...18 have no blanking. Beams 19...31 have reduced resolution and no beams are currently blocked. Finally, beam 32 has no blanking.

Figure 105 - Beams Status –Blanking Example

Connected Components Workbench

Snap shot beam status RX

Date (dd.mm.yyyy): 14.06.2019 Time: 16:01:42

Cascade	Lens	Status	Intensity	Blanking	Muting
1	1	Blocked	N/A	Fixed Blanking	No
1	2	Blocked	N/A	Fixed Blanking	No
1	3	Free	High	Floating Blanking	No
1	4	Free	High	Floating Blanking	No
1	5	Free	High	Floating Blanking	No
1	6	Free	High	Floating Blanking	No
1	7	Free	High	Floating Blanking	No
1	8	Free	High	Floating Blanking	No
1	9	Free	High	Floating Blanking	No
1	10	Blocked	N/A	Floating Blanking	No
1	11	Free	High	Floating Blanking	No
1	12	Free	High	Floating Blanking	No
1	13	Free	High	Floating Blanking	No
1	14	Free	High	Floating Blanking	No
1	15	Free	High	No	No
1	16	Free	High	No	No
1	17	Free	High	No	No
1	18	Free	High	No	No
1	19	Free	High	Reduced Resolution One Object	No
1	20	Free	High	Reduced Resolution One Object	No
1	21	Free	High	Reduced Resolution One Object	No
1	22	Free	High	Reduced Resolution One Object	No
1	23	Free	High	Reduced Resolution One Object	No
1	24	Free	High	Reduced Resolution One Object	No
1	25	Free	High	Reduced Resolution One Object	No
1	26	Free	High	Reduced Resolution One Object	No
1	27	Free	High	Reduced Resolution One Object	No
1	28	Free	High	Reduced Resolution One Object	No
1	29	Free	High	Reduced Resolution One Object	No
1	30	Free	High	Reduced Resolution One Object	No
1	31	Free	High	Reduced Resolution One Object	No
1	32	Free	High	No	No

Export Cancel

Two-sensor Muting Schematic Example

Figure 106 shows an example wiring diagram for two-sensor muting. The muting sensors are connected to pins 1 and 4 of the connection plug-in. If the Connected Components Workbench software is not used, the connections of the muting sensors must be as shown in the schematic. If the Connected Components Workbench software is used, the muting sensors can be connected in any of the muting wires and then configured in the Connected Components Workbench software.

Figure 106 - Example Schematic for Two Sensor Muting

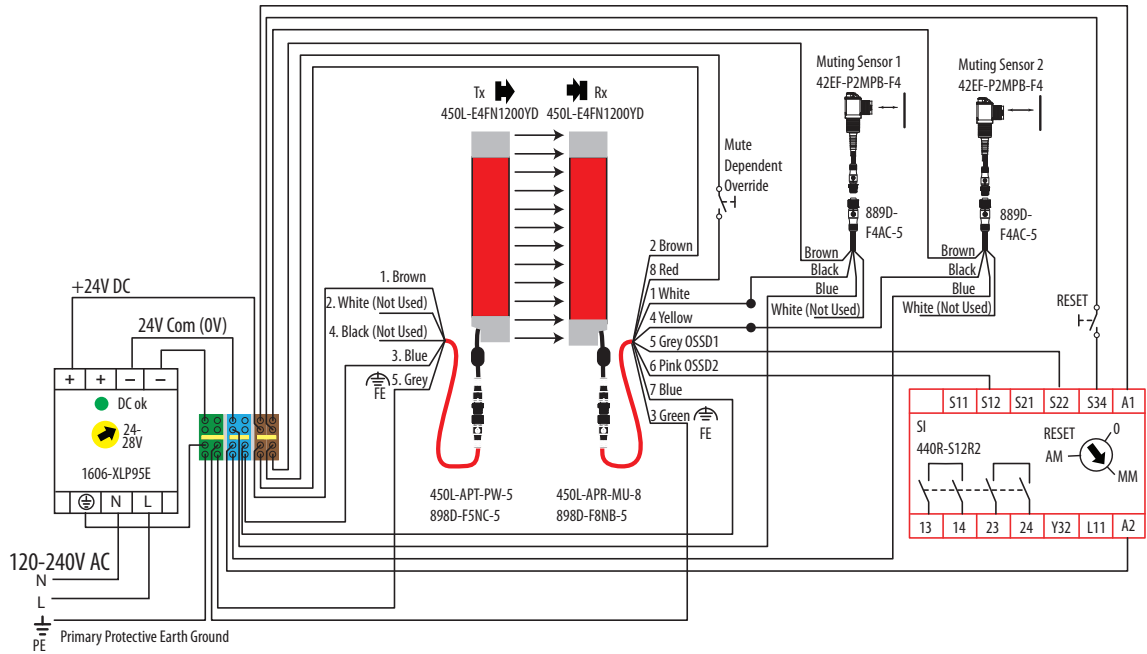

In the hardware setup, which is shown in Figure 107, select the muting plug-in, Bulletin 450L-APR-MU-8, as the Connection plug-in Rx. On the plug-in, set switch 1 to ON, and all other switches are OFF. This step allows the Connected Components Workbench software to configure the muting setup.

Figure 107 - Hardware Setup

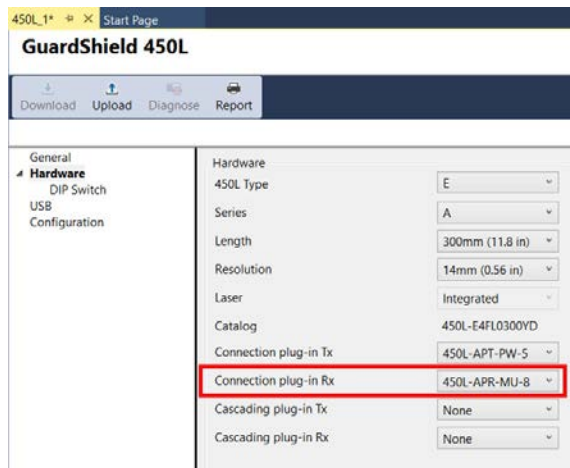

Muting Type and Settings

In [Figure 108](#), select the Muting Type. Since the receiver only has the muting plug-in, the muting types are limited to two sensors. Select the type of muting. Click Settings to adjust the muting time parameters.

Figure 108 - Select Muting Type

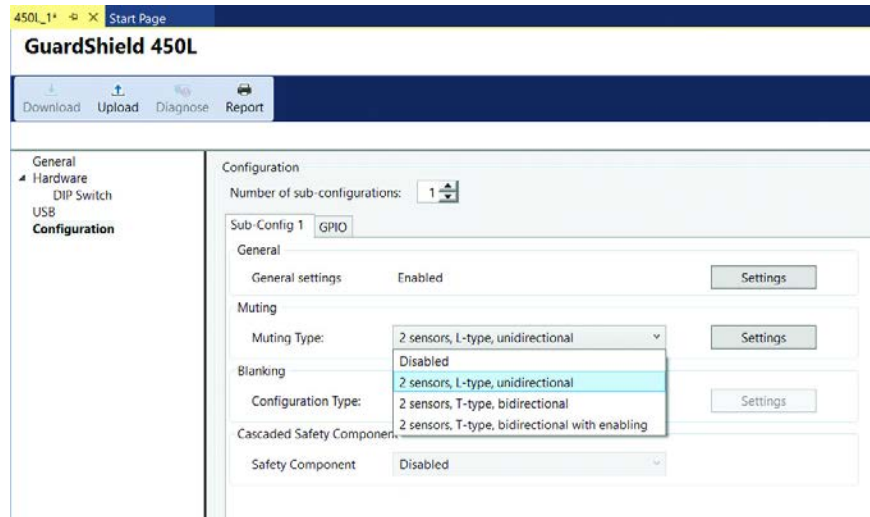

[Figure 109](#) shows the two-sensor muting settings. These settings apply to all three types of two-sensor muting. [Table 58 on page 150](#) describes the settings. Select the values appropriate for the application.

Figure 109 - Muting Settings

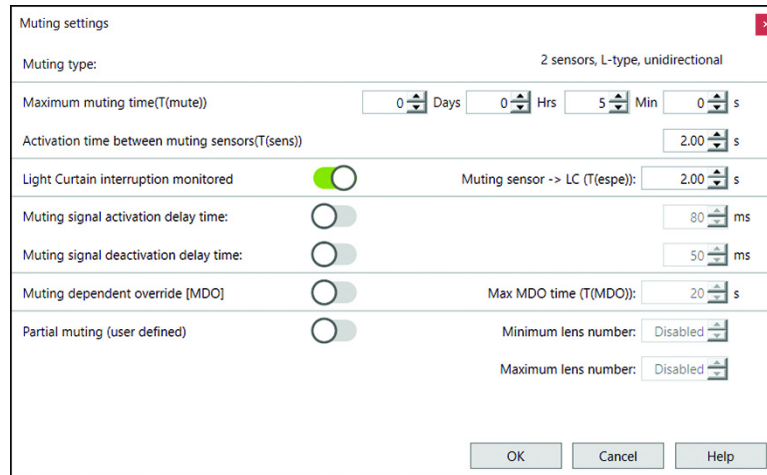

Table 58 - Muting Parameters

Parameter	Description
Muting type	This parameter is a read-only field, setup by the Configuration tab.
Maximum muting time	This parameter is the maximum time that the material can occupy the light curtain. If the time is exceeded, the OSSD outputs turn OFF and the object can be cleared by using the Mute Dependent Override.
Activation time between muting sensors T(sens)	Specifies the maximum time between sensors. This maximum is the time in which the object must block both sensors. If the time is exceeded, the muting timing error becomes active and the light curtain is not muted.
Light curtain interruption monitored T(espe)	If set to OFF, the time from the start of muting to when the object blocks light curtain is not used in the muting sequence. If set to ON, specify the time that the light curtain must be interrupted after muting state has been achieved. If the time is exceeded, the OSSD outputs turn OFF.
Muting signal activation delay time	Specifies a delay before muting becomes activate. <ul style="list-style-type: none"> • Max setting: 2550 ms • Default setting: 80 ms • Min setting: 1 ms
Muting signal deactivation delay time	Specifies a delay before muting becomes de-activated. <ul style="list-style-type: none"> • Max setting: 2550 ms • Default setting: 50 ms • Min setting: 0 ms • Increment: 10 ms
Muting dependent override (MDO)	Specifies the duration of the muting dependent override signal. Use this function to force the OSSD outputs ON after a muting error has occurred. The override signal becomes active on the trailing edge. <ul style="list-style-type: none"> • Max setting: 1275 s • Min setting: 0 ms • Increment: 10 ms
Partial muting (user defined)	The light curtain can be set up to allow muting of a specified number of lenses. Specify the first lens and last lenses to mute. If the other lenses are blocked, the OSSD outputs turn OFF.

GPIO Selection and Settings

Figure 110 shows the GPIO tab. Click GPIO and select the function of the three inputs. Two of the inputs must be the muting sensors. A likely choice for the third input is a mute dependent override function.

Figure 110 - General Purpose Input Output Selection

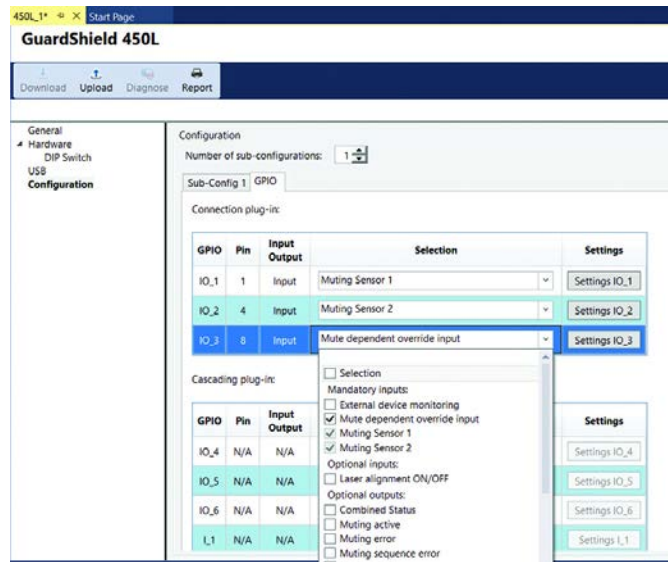

Click Settings IO_x to set Logic and Filter times. Figure 111 shows the options for the GPIO settings.

The Logic function for muting sensor is fixed at LOW Active. When an object passes in front of the sensor, the sensor output turns OFF.

Adjust the filter times to help prevent inadvertent changes from the sensor output from disrupting the muting process. The filter times can be adjusted from 0...255 ms.

Click OK after adjustments are made.

Figure 111 - General Purpose Input Output Selection

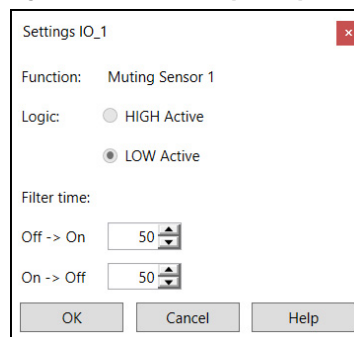

Proceed to [Download and Upload Configurations on page 175](#).

Four-sensor Muting Schematic Example

Figure 112 shows an example wiring diagram for four-sensor muting. The muting sensors are connected to the cascading plug-in. If the Connected Components Workbench software is not used, the connections of the muting sensors must be as shown in the schematic. If the Connected Components Workbench software is used, the muting sensors can be connected in any of the muting wires and then configured in the Connected Components Workbench software.

Figure 112 - Example Schematic for Four Sensor Muting

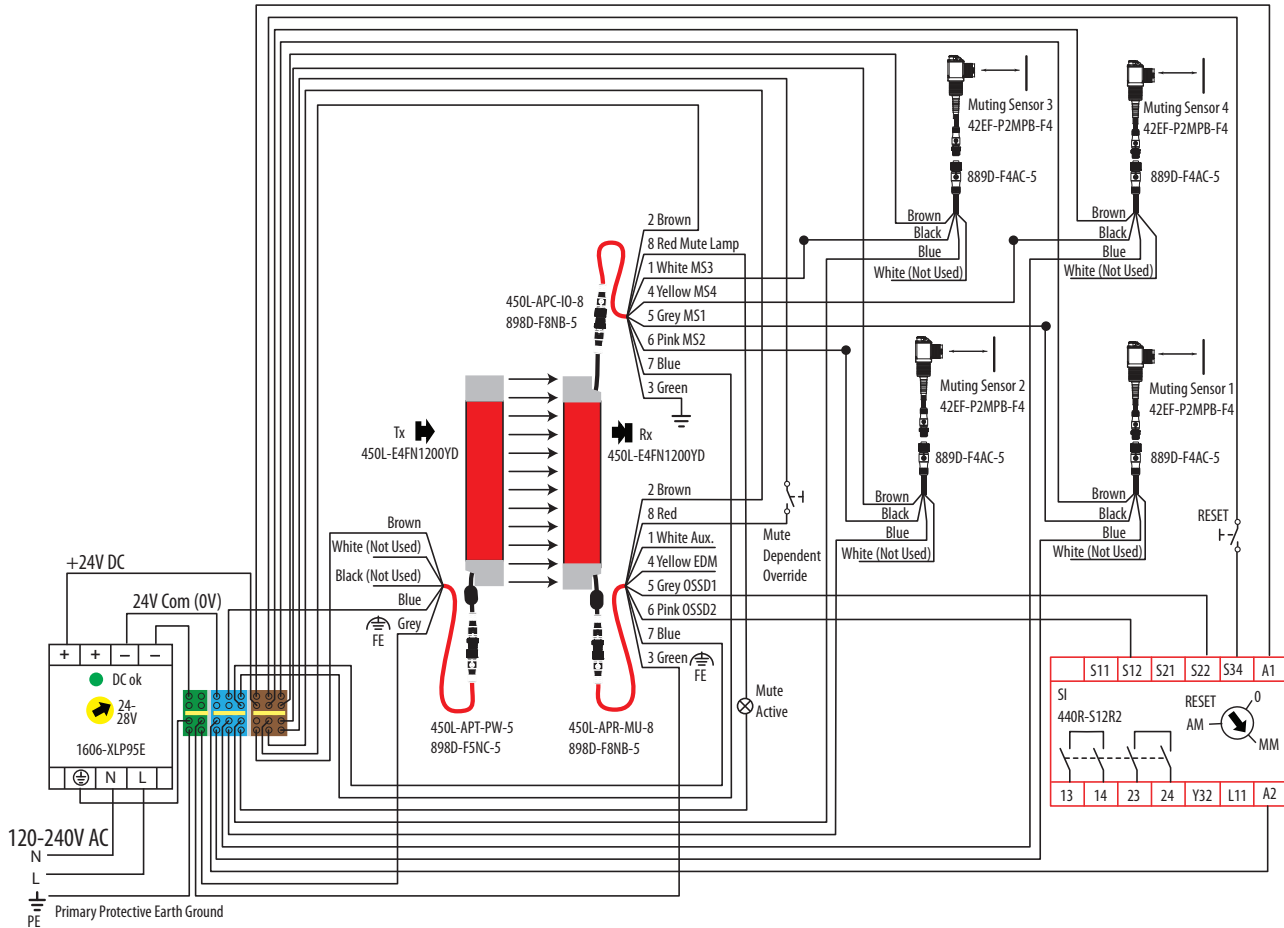

Hardware

Figure 113 shows the hardware settings for four-sensor muting. The receiver stick requires the muting connection plug-in and the cascading plug-in. When both plug-ins are selected, the Connected Components Workbench software allows for four-sensor muting to be selected.

Figure 113 - Hardware Settings for Four Sensor Muting

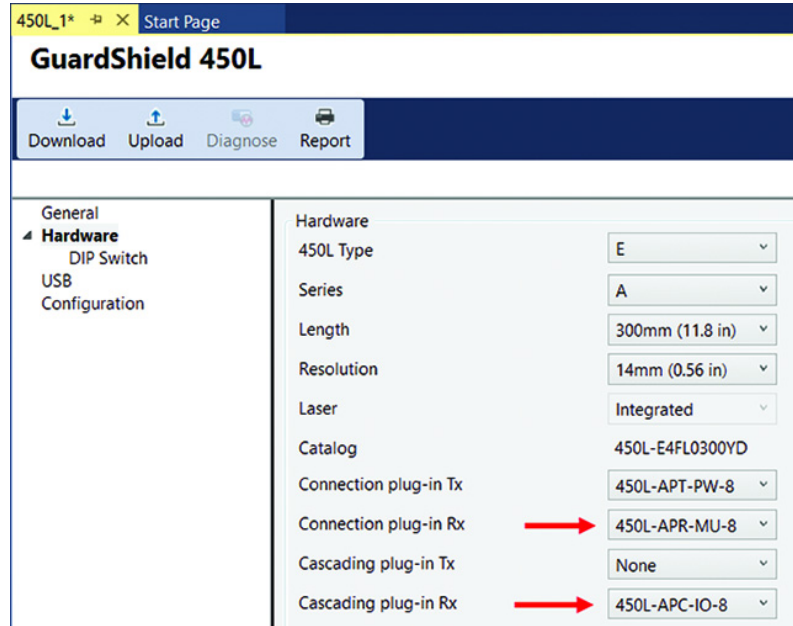

Muting Type and Settings

Figure 114 shows the Configuration window. There is only one type of four-sensor muting. Select four sensors, T-type, bidirectional as the muting type. Click Settings to adjust the muting time parameters.

Figure 114 - Muting Type with Four Sensors

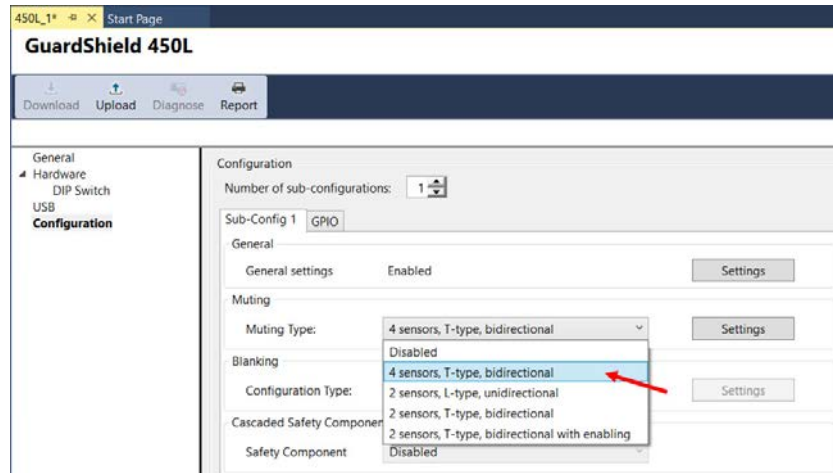

Figure 115 shows the four-sensor muting settings. Table 59 describes the muting settings. Select the values appropriate for the application.

Figure 115 - Muting Settings

Table 59 - Muting Settings

Setting	Description
Muting type	This setting is a read-only field, setup by the Configuration tab.
Maximum muting time	This setting is the maximum time that the material can occupy the light curtain.
Activation time between muting sensors T(sens)	Specifies the maximum muting time between sensors. This setting is the time in which the object must block both sensors on either side of the light curtain. If the time is exceeded, the muting timing error becomes active, and the light is not be muted. If the object then blocks the second sensor, the muting sequence error becomes active. The object must be removed from the sensors.
Light curtain interruption monitored (T(espe))	If set to OFF, the time from the start of muting to when the object blocks light curtain is not used in the muting sequence. If set to ON, specify the time that the light curtain must be interrupted after muting starts. If the time is exceeded, the OSSD outputs turn OFF.
Muting signal activation delay time	Specifies a delay before muting becomes activated. <ul style="list-style-type: none"> • Max setting: 2550 ms • Default setting: 80 ms • Min setting: 0 ms
Muting signal deactivation delay time	Specifies a delay before muting becomes de-activated. <ul style="list-style-type: none"> • Max setting: 2550 ms • Default setting: 50 ms • Min setting: 0 ms
Muting dependent override (MDO)	Specifies the duration of the muting dependent override signal. Use this function to force the OSSD outputs ON after a muting error has occurred. The override signal becomes active on the trailing edge. <ul style="list-style-type: none"> • Max setting: 1275 s • Min setting: 0 s
Partial muting (user defined)	The light can be set up to allow muting to a specified number of lenses. Specify the first lens and last lenses that is muted. If the other lenses are blocked, the OSSD outputs turn OFF.

GPIO Selection and Settings

With the muting settings established, the General Purpose Input and Output (GPIO) must be set. Click the GPIO tab.

[Figure 116](#) highlights three sections of the GPIO settings:

1. The connection plug-in has three wiring connections that can be used as input or output. The I/O are available on connector pins 1, 4, and 8.
2. The cascading plug-in has five wiring connections. Three can be used as input or output, and two can only be used as inputs. The I/O are available on connector pins 4, 8, 1, 5, and 6.
3. Initially, a red message box “Mandatory GPIO configuration is not complete for download” appears. After making the proper mandatory selections, the message turns green.

Figure 116 - GPIO Overview

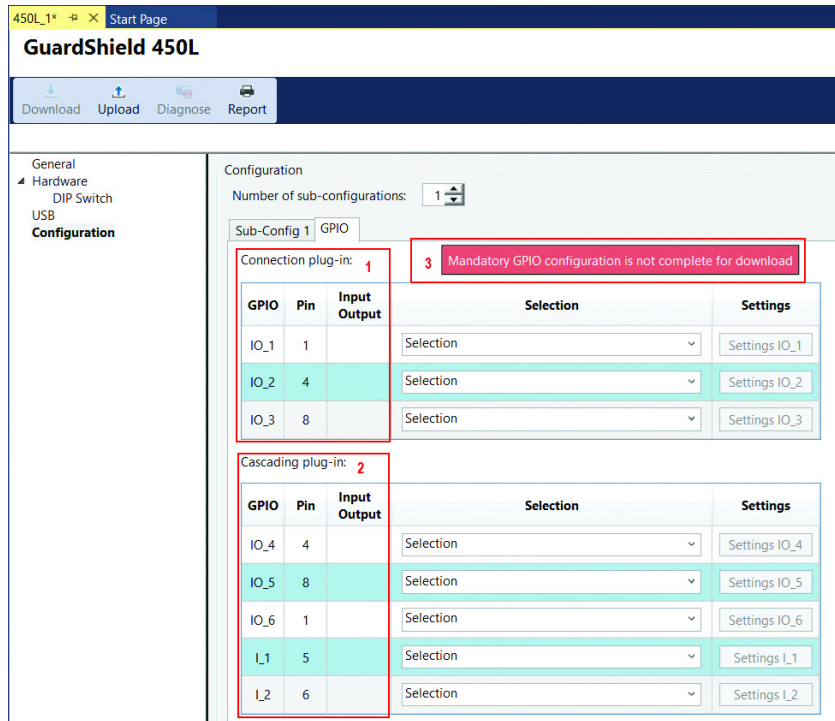

[Figure 60 on page 156](#) lists the I/O from the example schematic in [Figure 112 on page 152](#). There are five inputs on the cascading plug-in and one output on the connection plug-in.

Table 60 - Muting I/O

Plug-in	I/O	Function	Pin
Cascading	Input	Muting sensor 1	5
		Muting sensor 2	6
		Muting sensor 3	1
		Muting sensor 4	4
	Output	Muting lamp	8
Connection	Input	Muting override	8
	Output	Mute timing error	1
		Mute sequence error	4

Figure 117 on page 156 shows the settings. Click the selection expander for Cascading plug-in pin five. The four muting sensors appear as mandatory inputs. Check Muting Sensor 1, as this sensor is connected to pin 5.

Figure 117 - Select I/O for Pin 5

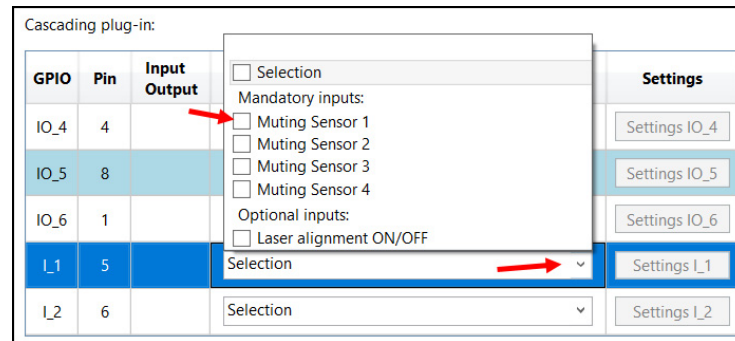

Click Settings I_1. Figure 118 on page 157 shows the sensor settings to adjust the sensor logic and filter times.

The Logic function for muting sensor is fixed at LOW Active. When an object passes in front of the sensor, the sensor output turns OFF.

Adjust the filter times to help prevent inadvertent changes from the sensor output from disrupting the muting process. The filter times can be adjusted from 0...255 ms.

Click OK after adjustments are made.

Figure 118 - Muting Sensor Settings

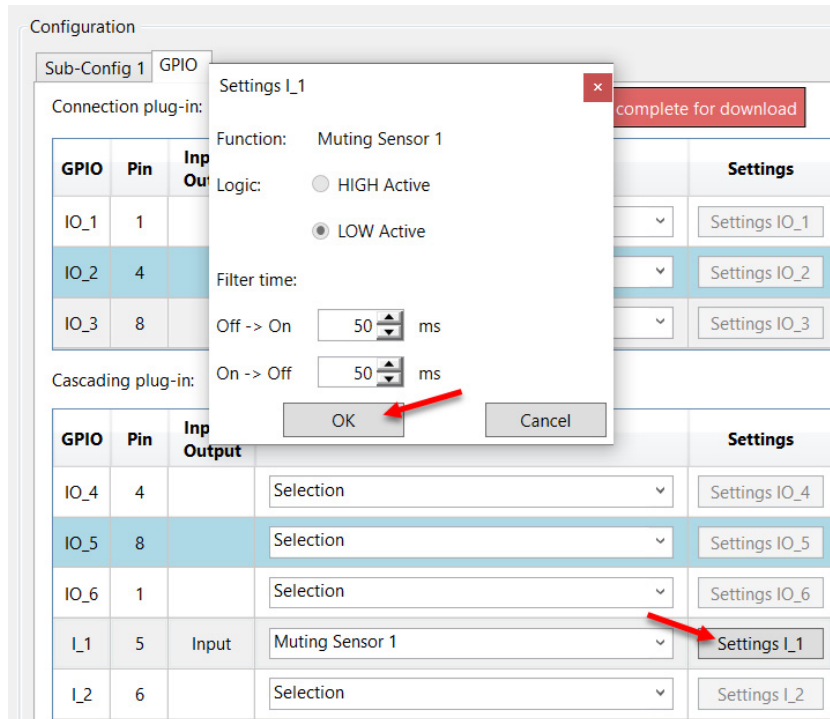
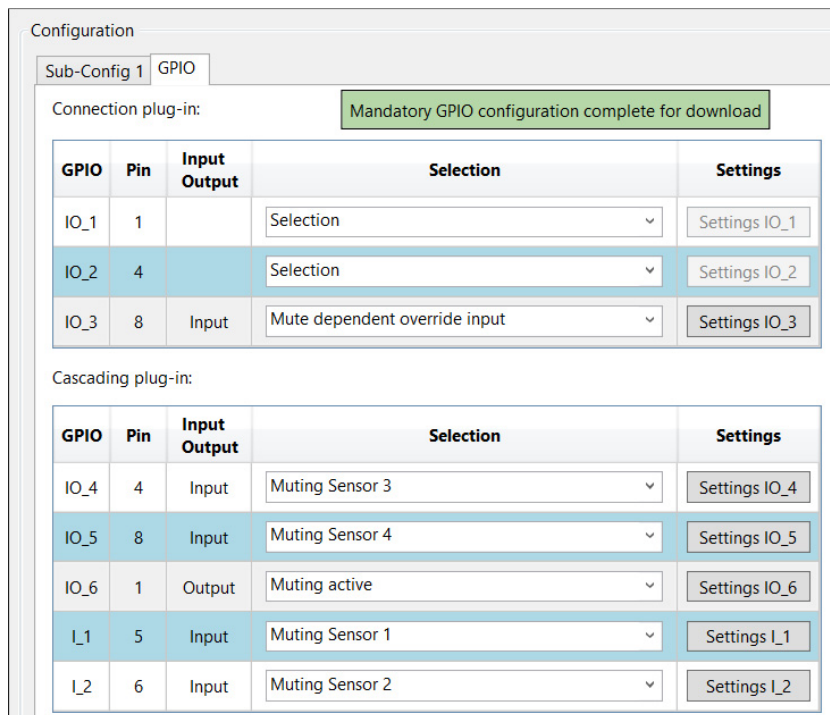

Figure 119 shows the final GPIO settings to meet the example schematic. The mandatory GPIO message box is green.

Figure 119 - Final GPIO Muting Settings



Proceed to [Download and Upload Configurations on page 175](#).

Blanking Overview

To use the blanking features, the transceiver must have either of these plug-ins:

- Catalog number 450L-APR-MU-8 – the muting/blanking plug-in,
- Catalog number 450L-APR-BL-5 – the blanking plug-in

The Bulletin 450L-E light curtain has three types of blanking:

- Fixed blanking
- Floating blanking
- Reduced resolution blanking.

Lens identification and zones help with the implementation of blanking.

Lens Identification

[Figure 120](#) shows an example of the identification of the lenses for both finger and hand resolution for a light curtain that has a 300 mm (11.81 in.) height. Notice the following:

- Lens 1 is the lens closest to the connection plug-in (not the cascading plug-in). This arrangement is especially important for the hand resolution as lens ‘n’ is not used.
- Both resolutions have the name number of lenses.
- The even-numbered lenses of hand resolution are not used; the lens ‘n’ is not used.
- The Bulletin 450L transceivers are built on 16 lens segments; the number of lenses, n, is a multiple of 16.

Figure 120 - Lens Identification Example – 300 mm (11.8 in.) Sensing Height

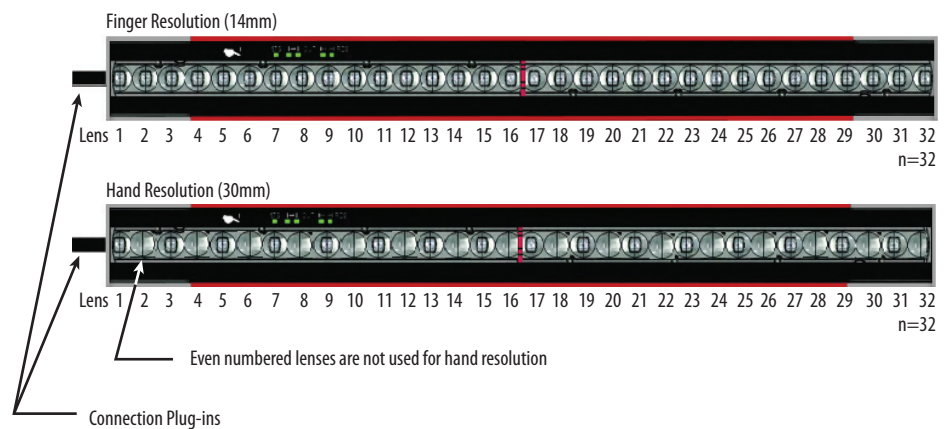

Zones

A zone is a range of lenses in the transceivers that are blanked with specific conditions. A maximum of eight zones can be specified. The zones must be used in order and must not be skipped. The lenses must be used in order, but lenses can be skipped. Each zone can be:

- Fixed blanking
- Floating blanking
- Reduced resolution blanking

The following rules apply to specifying zones:

- Zone definition begins with the lowest lens; the lens closest to the connection plug-in.
- Zones cannot overlap.
- Each zone must be a contiguous set of lenses.
- Each zone can be either fixed, floating, or reduced resolution.
- A non-blanking area is allowed between zones or at either end of the transceiver. This area is not considered a zone.
- Non-blanked areas can be assigned either 1) normal operation, 2) reduced resolution one object or 3) reduced resolution two objects.
- Only one of the synchronization beams can be blocked (either at the top or the bottom, but not both top and bottom).

[Figure 121 on page 160](#) shows an example with a finger resolution light curtain. Zone 1 applies fixed blanking (object always present and remains stationary) between lens 1 and 2. Zone 2 applies floating blanking (object can move but must always be present) between lens 3 and 14. Zone 3 applies reduced resolution between lens 19 and 30. Lenses 31...32 are used for synchronization, and normal operation (finger resolution) applies. The area from lens 15...18 is also normal operation (finger resolution).

Figure 121 - Three Zone Blanking Example – With Finger Resolution

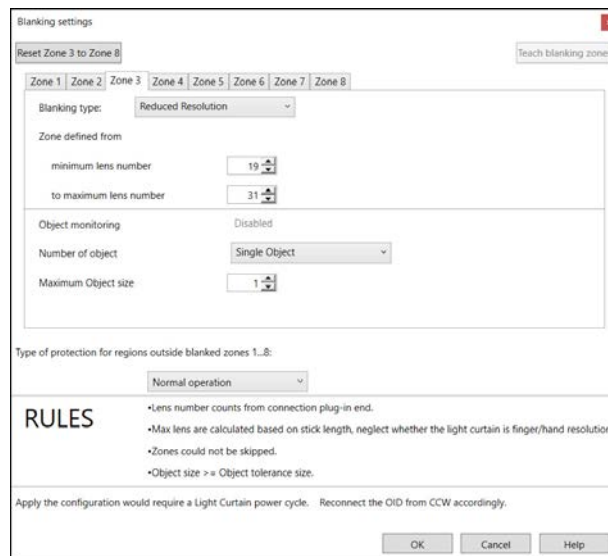
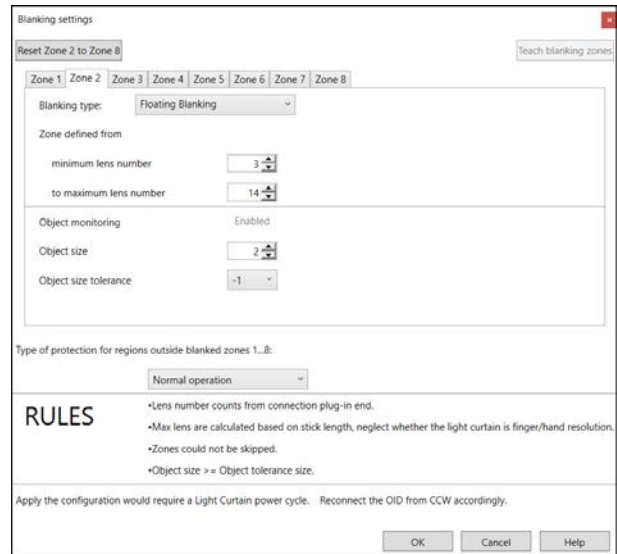
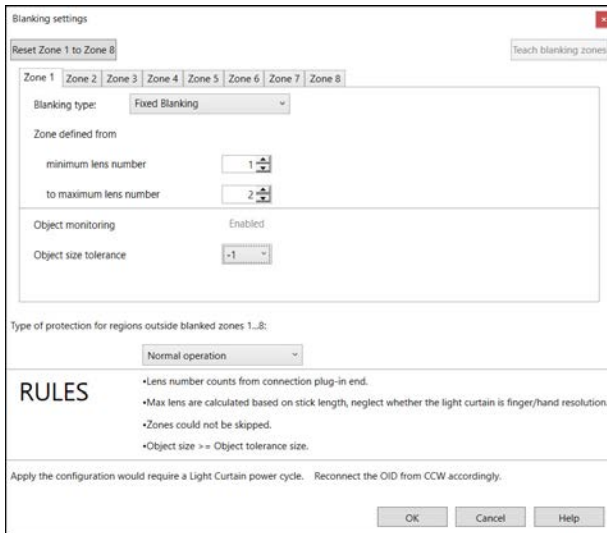
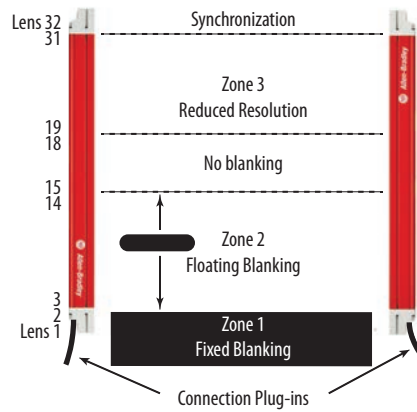

Configuration Options

On the configuration window, blanking has three types that can be selected when the Connected Components Workbench software is disconnected from the light curtain:

- Disable – blanking is not used.
- Software configuration – configure for fixed, floating, or reduced resolution.
- Push Button Teach-in – use the Teach command button on the Diagnose Window.

Fixed Blanking

A fixed blanking zone is a set of lenses that has been configured to always expect an object to block the beams. The beams must always be blocked. A fixed zone that becomes unblocked causes the OSSD outputs of the light curtain receiver to turn OFF.

The Bulletin 450L-E accommodates changes in the set of lenses that can be blocked; this change is the object tolerance. The object tolerance can be set to zero (no lens tolerance) or to a negative number. The fixed blanking range can only be smaller by the tolerance number. A positive shift in the object size or location causes the OSSD outputs to turn OFF.

The Bulletin 450L-E uses the first or last beams for synchronization. If the first beam is blocked, then the last beam cannot be blocked. In contrast, if the last beam is blocked then the first beam cannot be blocked (see [Fixed Blanking](#)).

Settings

[Figure 122 on page 162](#) shows the settings for Fixed Blanking for Zone 1. Up to eight zones can be configured for fixed blanking or other types of blanking. The Teach Blanking Zones is enabled for fixed blanking. [Table 62 on page 163](#) describes the blanking settings. Select the values appropriate for the application.

Reset Zone 1 to Zone 8 – Click to clear the settings of the specified zones. The specified zones are a range from the selected zone to Zone 8.

Figure 122 - Fixed Blanking Settings

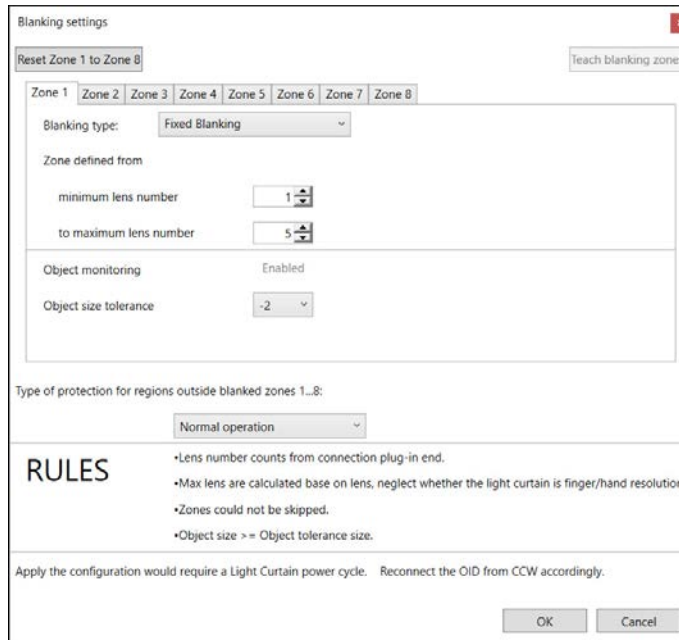

Table 61 - Fixed Blanking Settings

Setting	Description
Blanking type	Select Fixed Blanking.
Minimum lens number	This number is the first lens, closest to the connection plug-in that participates in the range of lenses.
Maximum lens number	This number is the last lens that participates in the range of lenses.
Object monitoring	Always enabled for fixed blanking.
Object size tolerance	The light curtain allows the object size to be smaller by 0, 1, or 2 lenses for finger resolution and 0 or 1 (where 1 = 2 lenses) for hand resolution. Select the number of lenses that accommodate the variation in the fixed object height and location.
Outside blanked zones	Select normal operation, reduced resolution one object, or reduced resolution two objects for the other zones.

Fixed Blanking Rules

[Table 62](#) shows the rules for fixed blanking within a zone. The Connected Components Workbench software automatically enforces these blanking rules. Since the transceiver sticks are synchronized with either the first or last lens, only one end of the stick can be blocked (not both ends).

Table 62 - Fixed Blanking Rules

Resolution	Object Size Tolerance	Include/Exclude Lens 1	Min Lens Value	Max Lens Value	Rules
Finger (14 mm [0.55 in.])	0	Include	1	2,3,4...n-1	Since lens 1 is blanked, the last lens cannot be blanked. Max lens must be greater than min lens.
		Exclude	3,4,5...n	4,5,6...n	Since lens 1 is not blanked, Lens 2 cannot be blanked. Max lens must be greater than min lens. Special case: Min lens and max lens can be n simultaneously.
	-1	Include	1	2,3,4...n-1	Since lens 1 is blocked, the last lens cannot be blocked. Max lens must be greater than min lens.
		Exclude	3,4,5...n	4,5,6...n	Max lens must be greater than min lens. Special case: Min lens and max lens can be n simultaneously.
	-2	Include	1	5,6,7...n-1	Since lens 1 is blanked, the last lens cannot be blanked. Max lens must be greater than min lens by a value of 4.
		Exclude	3,4,5...n-3	6,7,8...n	Since lens 1 is not blanked, Lens 2 cannot be blanked. Max lens must be greater than min lens by a value of 3.
Hand (30 mm [1.18 in.])	0	Include	1	3,5,7...n-1	Since lens 1 is blanked, the last lens cannot be blanked. Max lens must be an odd number and greater than the min value.
		Exclude	4,6,8...n	5,7,9...n-1	Min lens must be an even number equal to or greater than 4. Max lens must be an odd number greater than the min lens.
	-1	Include	1	3,5,7...n-3	Since lens 1 is blocked, the last lens cannot be blocked. Max lens must be an odd number greater than min lens.
		Exclude	4,6,8...n-2	7,9...n-1	Min lens must be an even number equal to or greater than 4. Max lens must be an odd number greater than the min lens by a value equal to or greater than 3. Special case: Min lens and max lens can be n simultaneously.

Proceed to [Download and Upload Configurations on page 175](#).

Teach Blanking Zones

The Connected Components Workbench software can learn new arrangements of fixed blanking. It learns by reading the beams, storing the new setting in a project, and then transferring the new settings down to the light curtain. Follow this process:

1. Set up the fixed object within the light curtain field.
2. Connect the Connected Components Workbench software to the light curtain.
3. Teach the Connected Components Workbench software the new settings.
4. Download the new settings to the light curtain
5. Upload and confirm (lock) the new settings.

Process Details

Place only the fixed objects in the light curtain field. The object can be singular or multiple fixed objects can be within the light curtain field. Mount the Optical Interface Device onto the receiver. Connect the USB cable from computer with the Connected Components Workbench software to the Optical Interface Device. Turn on power to the light curtain.

[Figure 123](#) starts the process by connection to the light curtain.

1. Click Connect to Device. Wait for the connection to be made. When the connection is made, Diagnose becomes enabled, and Download and Upload become disabled.
2. Click Blanking Settings. The Blanking configuration type is not relevant.

Figure 123 - Connect to Device

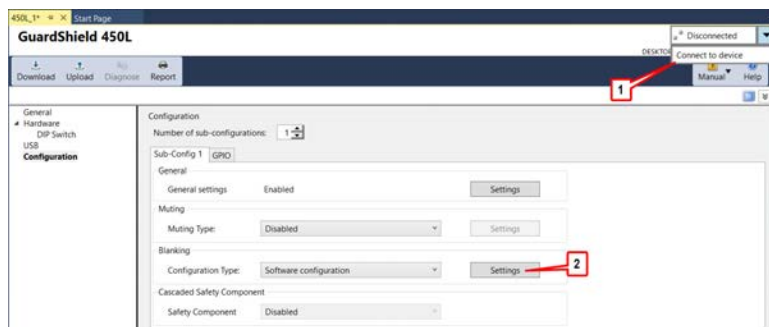

3. [Figure 124](#) shows the Blanking settings. Teach is enabled. Click Teach Blanking Zones.

Figure 124 - Teach Blanking Zones

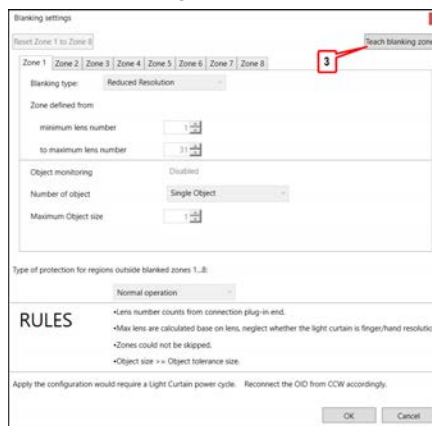

4. [Figure 125](#) shows the caution message that allows you to cancel if necessary. After reading the message, click OK.

Figure 125 - Delete Current Settings

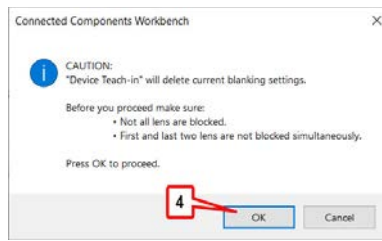

[Figure 126](#) shows the teaching in process window. If the light curtain is configured for automatic start, the OSSD outputs are ON. The OSSD outputs momentarily turn OFF and then back ON during the teaching process.

Figure 126 - Teaching in Process

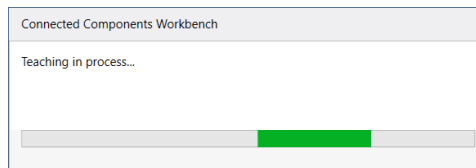

5. [Figure 127](#) shows that the teach-in process is complete. When completed, the Connected Components Workbench software generates a message and describes how many blanking zones were taught. Click OK.

Figure 127 - Teach-In Process Completed

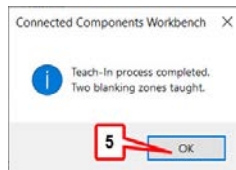

- Figure 128 shows the learned blanking settings. Review the settings in each zone. The settings cannot be changed in the Connected Components Workbench software; but the setting can be relearned by clicking the Teach blanking zones again. In this example, two zones have fixed blanking. The Connected Components Workbench software has learned the new settings. Click OK.

Figure 128 - Blanking Zone Review

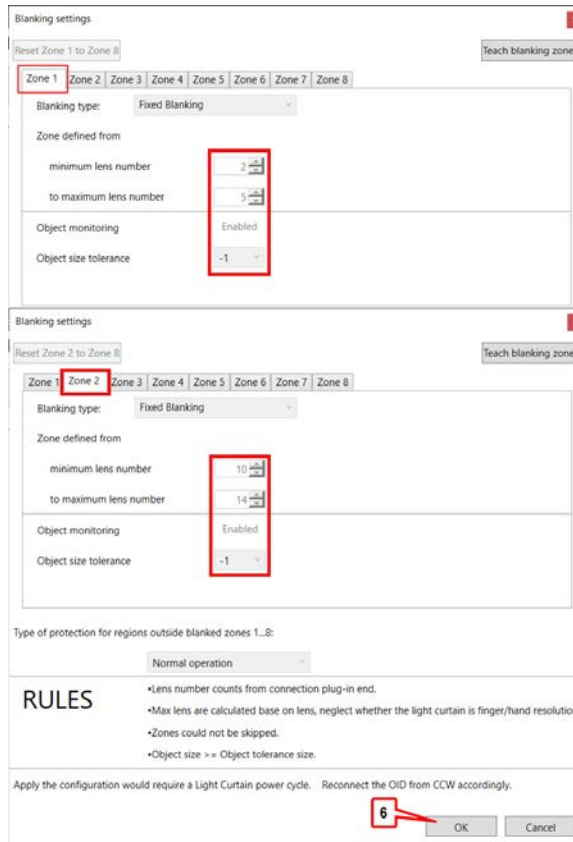

- In Figure 129, click Go Offline to disconnect the Connected Components Workbench software from the light curtain.

Figure 129 - Go Offline

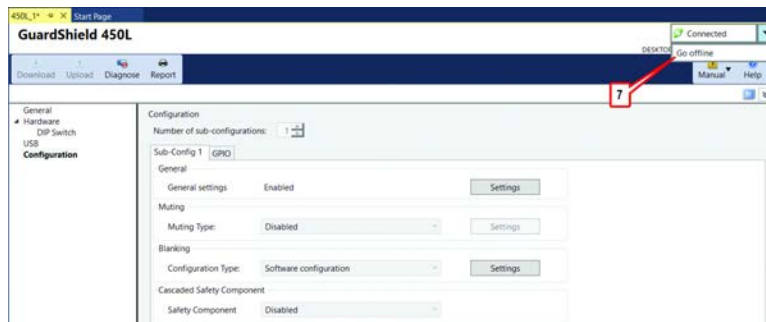

8. In [Figure 130](#), click Download with the light curtain disconnected. The OSSD outputs turn OFF while the new configuration is being downloaded.

Figure 130 - Download

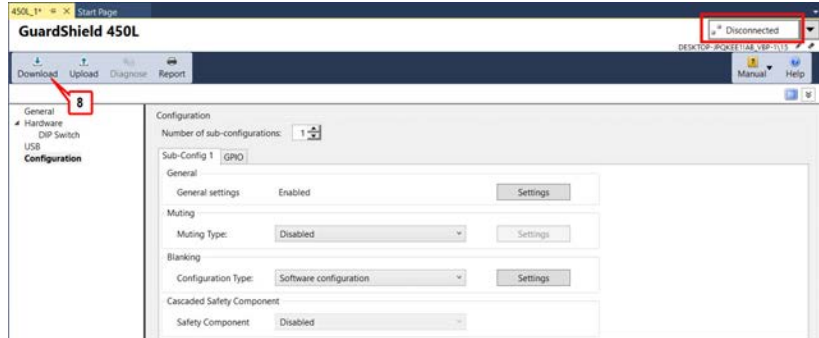

9. In [Figure 131](#), the download was a success. The downloaded and uploaded CRC values are the same. Click OK.

Figure 131 - Download Success

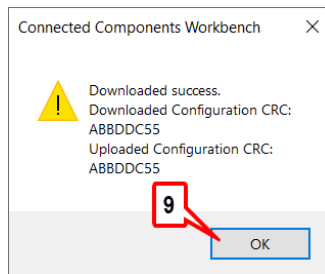

10. In [Figure 132](#), the Connected Components Workbench software resets. After resetting, the Connected Components Workbench software is disconnected from the light curtain, and the message box instructs you to click Upload or Connect to confirm the new configuration. On the light curtain, the status indicator is alternating red and green. The OSSD outputs are OFF. The Blanking indicator is OFF. Click OK.

Figure 132 - Resetting

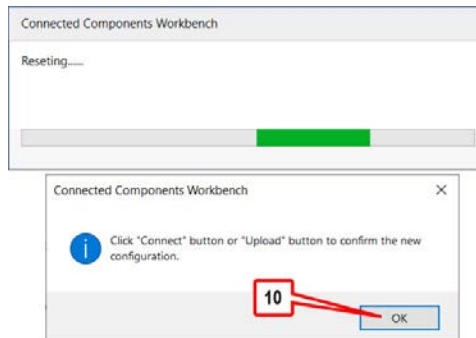

- In [Figure 133](#), click Upload. This step uploads the configuration from the light curtain back into the Connected Components Workbench software, so the new configuration can be confirmed.

Figure 133 - Upload

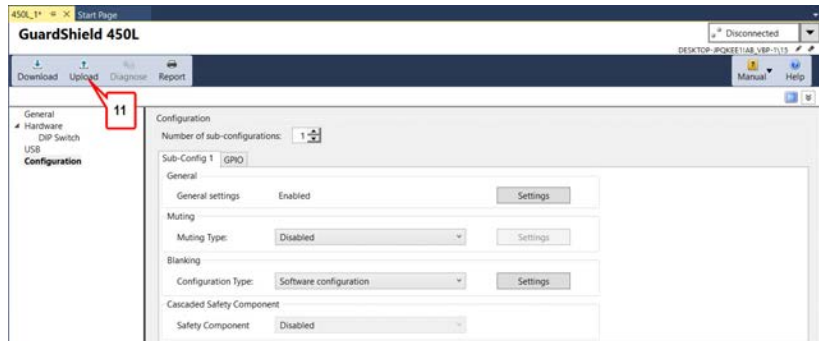

- In [Figure 134](#), the new configuration is waiting to be confirmed. Instructions are provided in the message to confirm the configuration. Click OK.

Figure 134 - New Configuration Waiting to be Confirmed

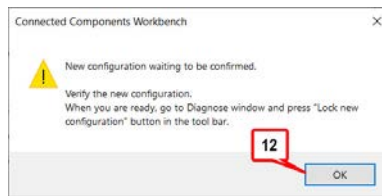

- In [Figure 135](#), click on Diagnose.

Figure 135 - Diagnose

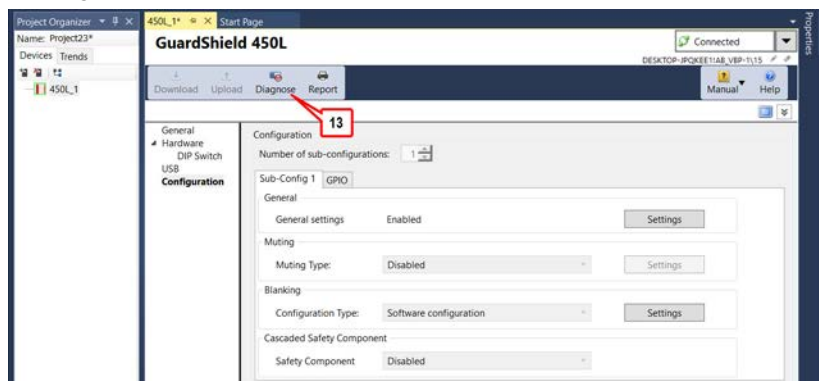

14. In [Figure 136](#), click Lock to confirm the configuration. The light curtain cycles power, and the new configuration is ready for use.

Figure 136 - Confirm Configuration by Locking

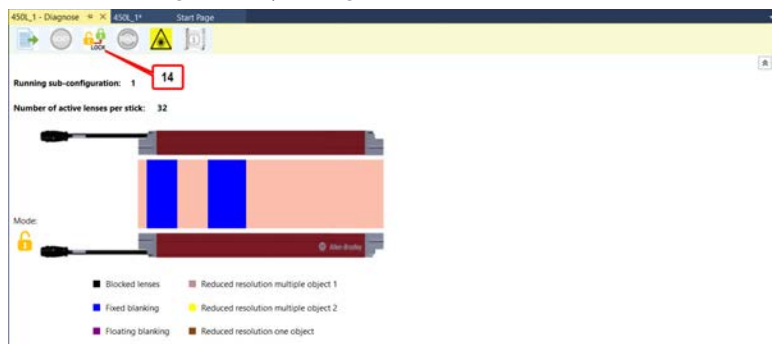

15. [Figure 137](#), the configuration is now active. Click OK.

Figure 137 - New Configuration Is Now Active

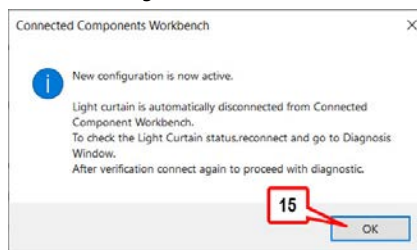

Floating Blanking

Floating blanking allows an object to move within the specified lens range without causing the light curtain OSSD outputs to turn off. The light curtain monitors the presence of the blanking; therefore, the object must always be within the specified lens range. If the object height is less than the minimum or more than the maximum number of lenses, the light curtain outputs turn OFF.

Settings

[Figure 138 on page 170](#) shows the settings for Floating Blanking. Up to eight zones can be configured for floating blanking. The Teach Blanking Zones are disabled for floating blanking. [Table 63 on page 170](#) describes the settings. Select the values appropriate for the application.

Figure 138 - Floating Blanking Settings

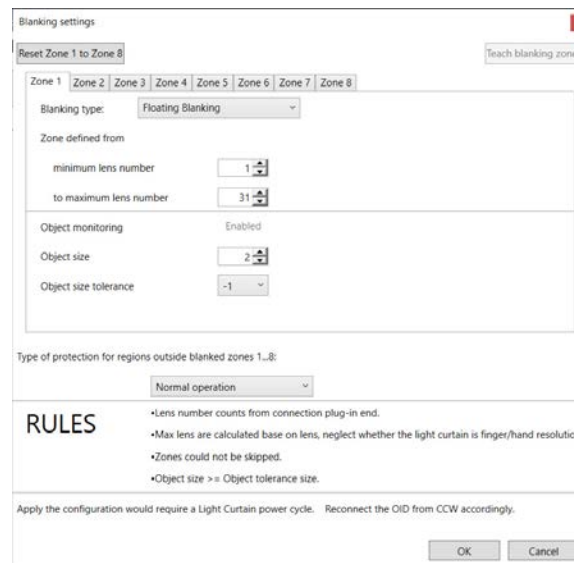

Table 63 - Floating Blanking Settings

Setting	Description
Blanking type	Select Floating Blanking.
Minimum lens number	This setting is the first that participates in the range of lenses.
Maximum lens number	This setting is the last lens that participates in the range of lenses.
Object monitoring	Always enabled for floating blanking.
Object size	Select the number of lenses typically blocked by the object. The number is subject to certain (see Table 64).
Object size tolerance	The light curtain allows the object size to be smaller by either 1 or 2 lenses for finger resolution and 1 lens for hand resolution. Select the number of lenses that accommodate the variation in object size. The number is subject to certain rules (see Table 64).
Other zones	Select normal operation, reduced resolution one object, or reduced resolution two objects for the other zones.

Floating Blanking Rules

[Table 64](#) shows the rules for floating blanking for the minimum object size. The Connected Components Workbench software enforces these blanking rules automatically. Since the transceiver sticks are synchronized with either the first or last beams, only one end of the stick can be blocked (not both ends).

Table 64 - Floating Blanking Rules

Resolution	Object Size (Min)	Object Size Tolerance	Include/ Exclude Lens 1	Min Lens Value	Max Lens Value	Rules
Finger (14 mm [0.55 in.])	2	-1	Include	1	6,7,8...n-1	Since lens 1 is blanked, the last lens cannot be blanked. Max lens must be at least equal to or greater than min lens by a value of 5.
			Exclude	3,4,5...n-5	8,9,10...n	Since lens 1 is not blanked, lens 2 cannot be blanked. Max lens must be at least equal to or greater than min lens by a value of 5.
	3	-2	Include	1	7,8,9...n-1	Since lens 1 is blanked, the last lens cannot be blanked. Max lens must be at least equal to or greater than min lens by a value of 6.
			Exclude	3,4,5...n-6	9,10,11...n	Since lens 1 is not blanked, lens 2 cannot be blanked. Max lens must be at least equal to or greater than min lens by a value of 6.
Hand (30 mm [1.18 in.])	4	-1	Include	1	13, 15...n-3	Since lens 1 is blanked, the last lens cannot be blanked. Max lens must be an odd number at least equal to or greater than the min lens by a value of 12.
			Exclude	4,6,8...n-8	15,17...n-1	Since lens 1 is not blanked, lens 2 cannot be blanked. Min lens number must be an even number with a value at least equal or greater than 4. Max lens must be an odd number at least equal to or greater than min lens by a value of 11.

Object Height

[Table 65 on page 172](#) shows the formulas for calculating the minimum and maximum object height. The height of the object must be maintained between the minimum and maximum values for the OSSD outputs to remain ON.

[Figure 139 on page 172](#) shows an example of a maximum object size selection of 2 and tolerance of -1 for both finger and hand resolution. For finger resolution, the beam width is 3.91 mm (0.15 in.). The worst-case tolerance of beam spacing is 9.42 mm (0.37 in.) for minimum and 9.38 mm (0.37 in.) for maximum. An object that has a height larger than 13.33 mm (0.52 in.) and less than 14.85 mm (0.58 in.) does not cause the OSSD outputs to turn OFF. If the object height falls below 13.33 mm (0.52 in.) or exceeds 14.85 mm (0.58 in.), the OSSD outputs turn OFF.

Table 65 - Object Height Formulas

Resolution	Max/Min	Formula
Finger (14 mm [0.55 in.])	Min	Min object height is $> (\text{Object Size} + \text{Object Size Tolerance}) \times 9.42 + 3.91$ Example with Object Size = 2 and Tolerance = -1 $> (2 - 1) \times 9.42 + 3.91$ $> 13.33 \text{ mm (0.52 in.)}$
	Max	Max object height is $< \text{Object Size} \times 9.38 - 3.91$ Example with Object Size = 2 $< 2 \times 9.38 - 3.91$ $< 14.85 \text{ mm (0.58 in.)}$
Hand (30 mm [1.18 in.])	Min	Min object height is $> (\text{Object Size} + \text{Object Size Tolerance}) \times 18.84 + 5.70$ Example with Object Size = 2 and Tolerance = -1 $> (2 - 1) \times 18.84 + 5.70$ $> 24.54 \text{ mm (0.97 in.)}$
	Max	Max object height is $< \text{Object Size} \times 18.76 - 5.70$ Example with Object Size = 2 $< 2 \times 18.76 - 5.70$ $< 31.82 \text{ mm (1.25 in.)}$

Figure 139 - Object Height Example – Object Size = 2, Object Tolerance = -1

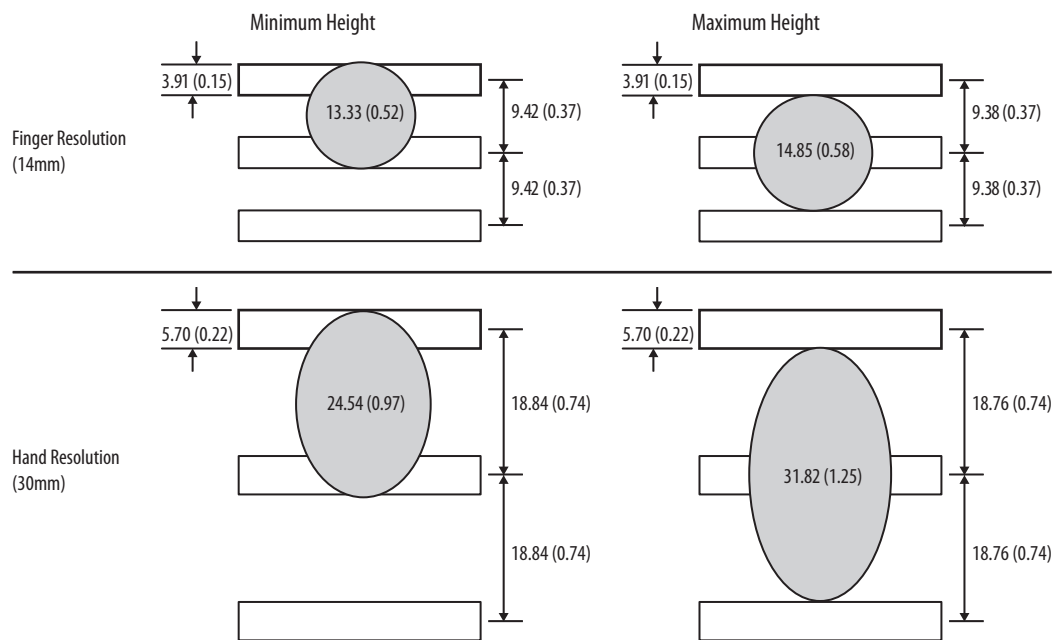

Reduced Resolution Blanking

Reduced resolution is similar to floating blanking with this exception: the object does not need to be in the reduced resolution zone. Reduced resolution blanking is not monitored blanking.

Settings

[Figure 140](#) shows the setting for reduced resolution blanking. [Figure 66](#) describes the settings.

Figure 140 - Reduced Resolution Settings

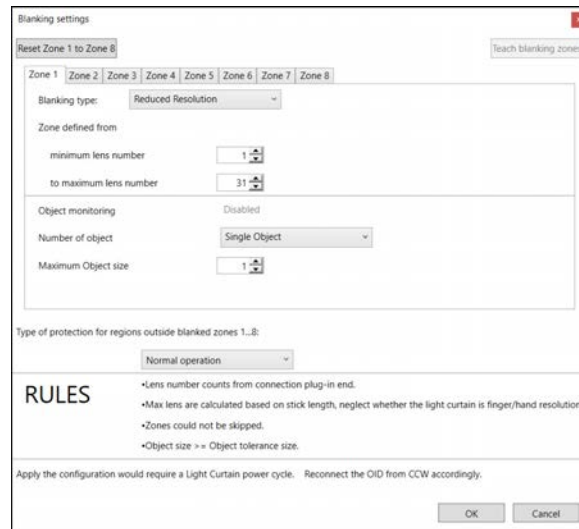

Table 66 - Reduced Resolution Settings

Setting	Description
Blanking type	Select Reduced Resolution.
Minimum lens number	This setting is the first lens that participates in the range of lenses.
Maximum lens number	This setting is the last lens that participates in the range of lenses.
Object monitoring	Always disabled for reduced resolution.
Number of objects	Select single or multiple objects. Single - The height of the single object must be less than the maximum object size. Multiple – The sum of the heights of all objects must be less than the maximum object size.
Maximum object size	Select the maximum height of the object or objects. The height is subject to certain rules (see Object Height on page 174).
Other zones	Select normal operation, reduced resolution one object, or reduced resolution two objects.

Reduced Resolution Blanking Rules

Table 67 shows the rules for reduced resolution blanking. The Connected Components Workbench software enforces these blanking rules automatically. Since the transceiver sticks are synchronized with either the first or last lens, only one end of the stick can be blocked (not both ends).

Table 67 - Reduced Resolution Rules

Resolution	Object Size, Max	Include/Exclude Lens 1	Lens Value, Min	Lens Value, Max	Rules
Finger (14 mm [0.55 in.])	1...31	Include	1	5...n-1	Since Lens 1 is blanked, the last lens cannot be blanked. Max Object Size \leq Max Lens - Min Lens - 3 Examples: Max Object Size = 1 and Min = 1, then Max = 5...n-1 Max Object Size = 4 and Min = 1, then Max = 8...n-1
		Exclude	3	n	Since Lens 1 is not blanked, Lens 2 cannot be blanked. Max Object Size \leq Max Lens - Min Lens - 3 Examples: Max Object Size = 1 and Min = 3, then Max = 7...n Max Object Size = 4 and Min = 5, then Max = 12...n
Hand (30 mm [1.18 in.])	2,4,6...n-12	Include	1	11,13,15...n-3	Since Lens 1 is blanked, the last lens cannot be blanked. Max Object Size \leq Max Lens - Min Lens - 8 Examples: Max Object Size = 2 and Min = 1, then Max = 11...n-3 Max Object Size = 4 and Min = 1, then Max = 13...n
		Exclude	4	13,15,17...n-1	Since Lens 1 is not blanked, Lens 3 cannot be blanked. Max Object Size \leq Max Lens - Min Lens - 7 Examples: Max Object Size = 2 and Min = 4, then Max = 13...n-1 Max Object Size = 4 and Min = 6, then Max = 17...n-1

Object Height

Figure 141 on page 175 shows an example of a maximum object size selection of two for both finger and hand resolution. For finger resolution, the beam width is 3.91 mm (0.15 in.), and the worst-case tolerance for beam spacing is 9.38 mm (0.37 in.). An object that has a height of 14.85 mm (0.58 in.) never blocks more than two beams. Blocking the third beam causes the OSSD outputs to turn OFF. Therefore, the maximum height remains less than the formulas in Table 68 to avoid nuisance tripping.

Table 68 - Formulas for Max Object Height

Resolution	Formula
Finger (14 mm [0.55 in.])	Max object height is $<$ Max Object Size Selection \times 9.38 - 3.91 Example with Max Object Size = 2 $< 2 \times 9.38 - 3.91$ $< 14.85 \text{ mm (0.58 in.)}$
Hand (30 mm [1.18 in.])	Max object height is $<$ Max Object Size Selection \times 18.76 - 5.70 Example with Max Object Size = 2 $< 2 \times 18.76 - 5.70$ $< 31.82 \text{ mm (1.25 in.)}$

Figure 141 - Max Object Height Example [mm(in)]

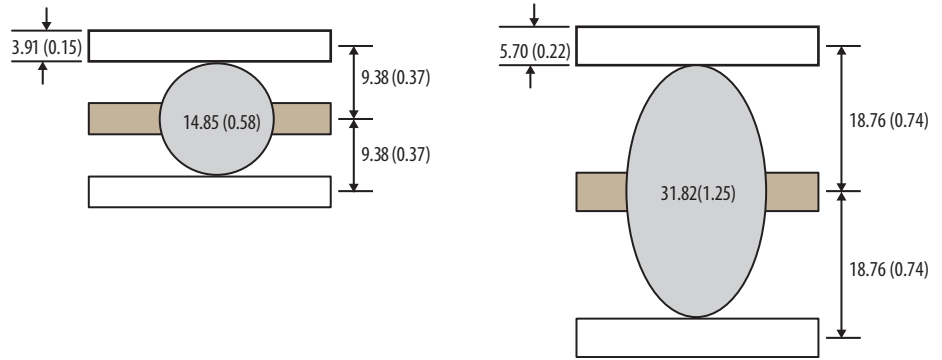

Table 69 shows maximum object size for selections 1...10. Use the appropriate formula in Table 69 for larger values.

Table 69 - Maximum Object Size Table [mm (in.)]

Select Maximum Object Size	If the object height is smaller than...	
	Finger Resolution [mm (in.)]	Hand Resolution [mm (in.)]
1	5.47 (0.22)	13.06 (0.51)
2	14.85 (0.58)	31.82 (1.25)
3	24.23 (0.95)	50.58 (1.99)
4	33.61 (1.32)	69.34 (2.73)
5	42.99 (1.69)	88.10 (3.47)
6	52.37 (2.06)	106.86 (4.21)
7	61.75 (2.43)	125.62 (4.95)
8	71.13 (2.80)	144.38 (5.68)
9	80.51 (3.17)	163.14 (6.42)
10	89.89 (3.54)	181.90 (7.16)

Download and Upload Configurations

Three essential steps are required to change a configuration in the light curtain:

1. Download the project to the light curtain.
2. Upload the project from the light curtain.
3. Lock the configuration.

Figure 142 starts the step-by-step process for changing the configuration in the light curtain.

1. Go offline (disconnected).
2. Complete the configuration.
3. Click Download.

Figure 142 - Configure Light Curtain Offline

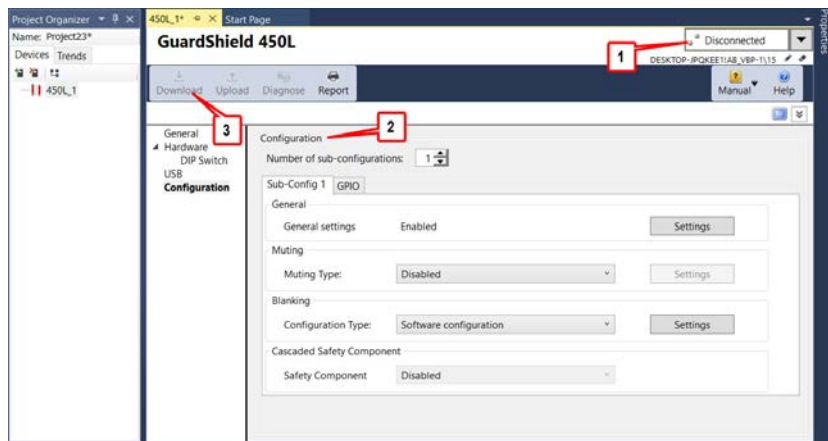
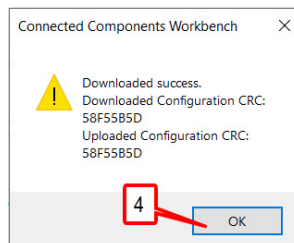

Figure 143 shows that the download was a success. The downloaded and uploaded CRC are identical.

4. Click OK.

Figure 143 - Download Successful



In Figure 144, the Connected Components Workbench software generates a progress window during the resetting process.

Figure 144 - Resetting Progress

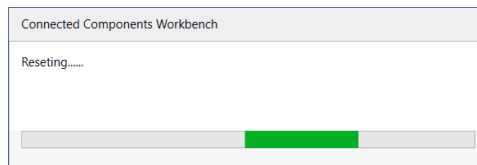

- In [Figure 145](#), click Upload to transfer the project from the light curtain back to the Connected Components Workbench software.

Figure 145 - Upload Project into the Connected Components Workbench Software

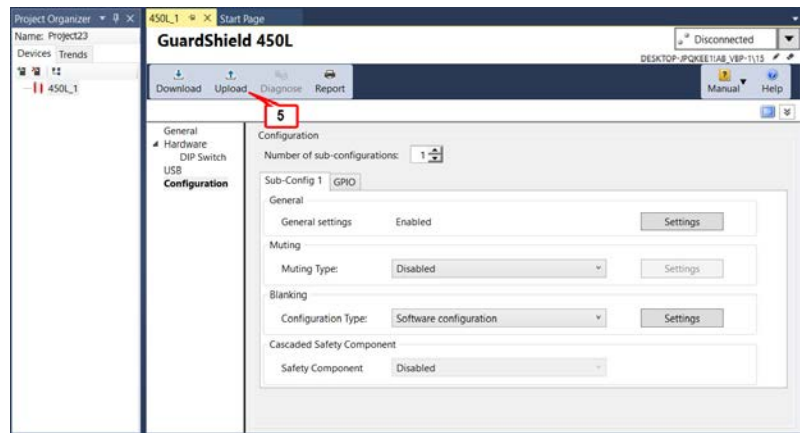

- [Figure 146](#) shows the waiting to confirm message. Click OK.

Figure 146 - Waiting for Confirmation

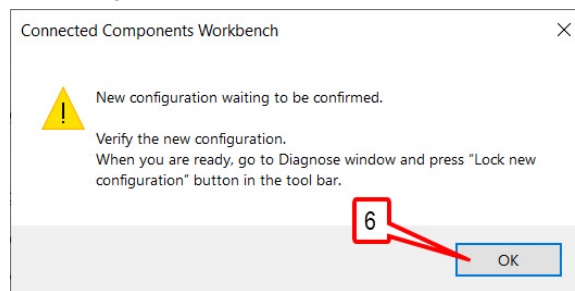

- In [Figure 147](#), click Diagnose.

Figure 147 - Diagnose

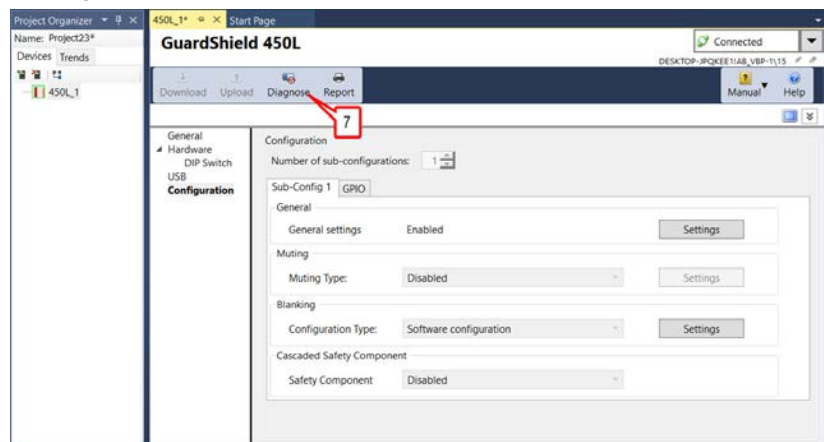

8. [Figure 148](#) shows the unlocked Mode icon. Click Lock.

Figure 148 - Lock to Confirm Configuration

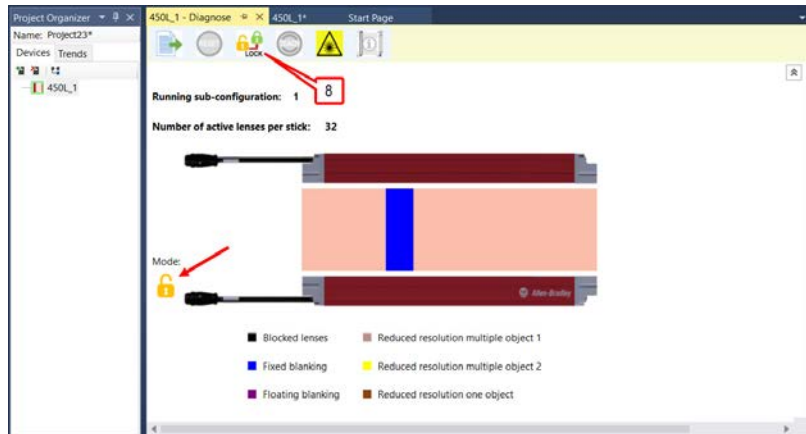

9. In [Figure 149](#), the configuration is now active, and the light curtain is ready for use. Click OK.

Figure 149 - Configuration Active

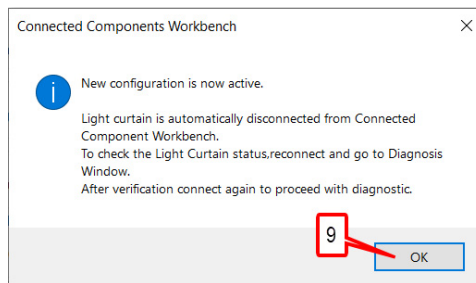

The following steps are optional. These steps can be used to monitor the performance of the light curtain through the Connected Components Workbench software.

10. In [Figure 150](#), select Connect to device.

Figure 150 - Connect to Device

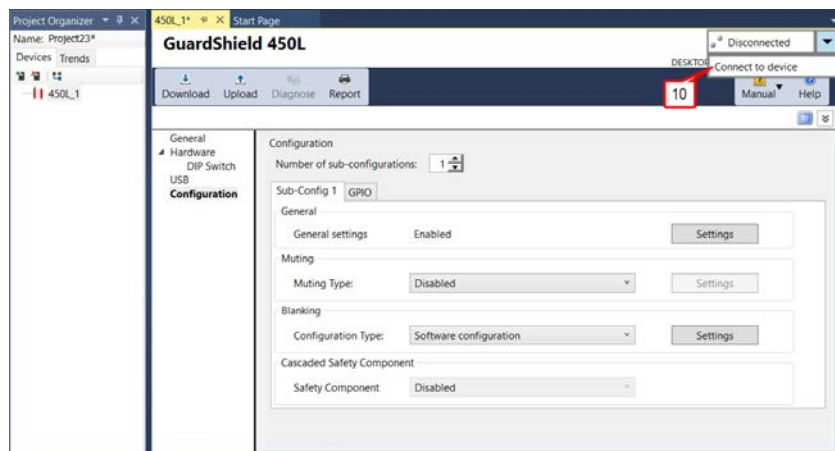

11. In [Figure 151](#), click Diagnose.

Figure 151 - Go to Diagnose Window

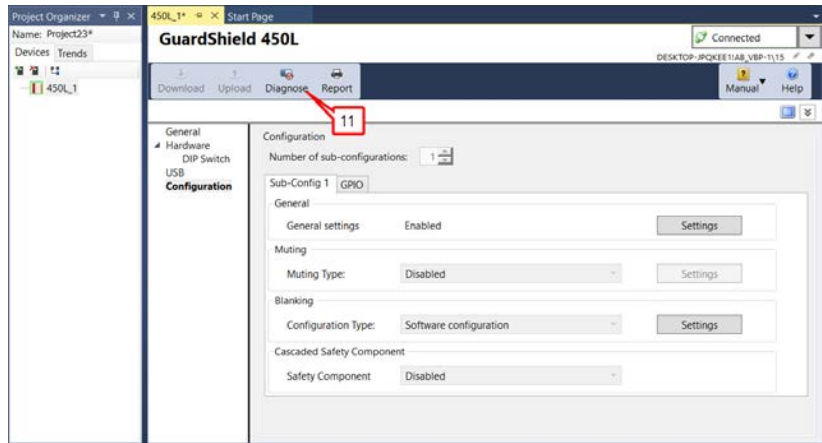

[Figure 152](#) shows the diagnostic window and the light curtain is locked in run mode with no errors.

Figure 152 - Run Mode

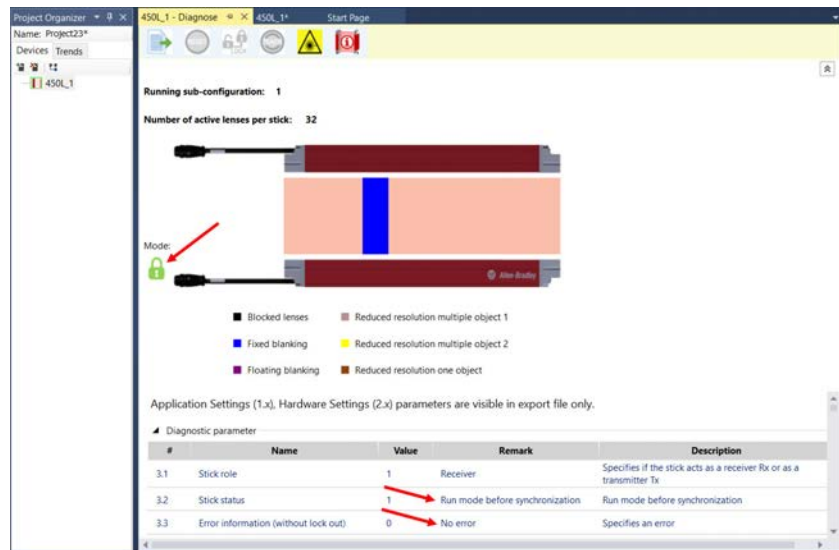

Change Hardware

The Connected Components Workbench software must know the actual hardware setup before downloading a new configuration. If the hardware is changed, for instance you add a cascading plug-in or change from a muting to a blanking plug-in, then the following steps synchronize the hardware with the Connected Components Workbench software.

After changing the hardware, apply power to the light curtain.

1. In [Figure 153](#), click Connect to device.

Figure 153 - Connect to Device

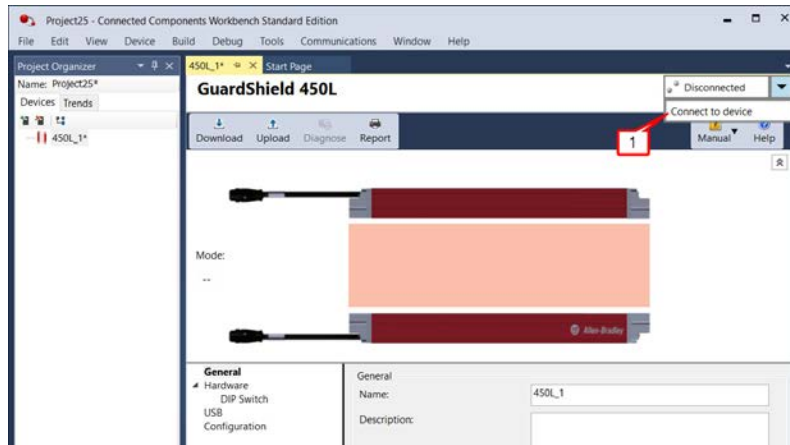

2. In [Figure 154](#), expand the AB_VPN-1 connection, click on Bulletin 450L, and click OK.

Figure 154 - Connection Browser

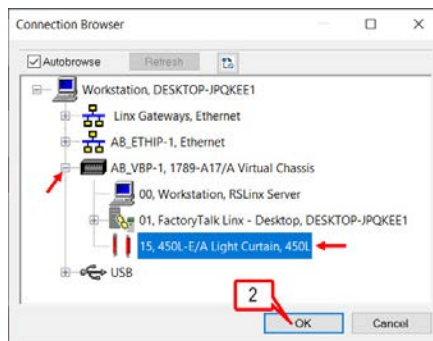

3. [Figure 155](#) shows that the hardware settings do not match. Click OK.

Figure 155 - Hardware Settings Do Not Match

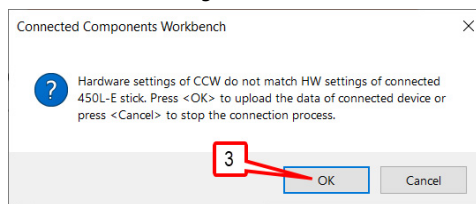

4. [Figure 156](#) shows the new configuration waiting to be confirmed. Click OK.

Figure 156 - Awaiting Confirmation

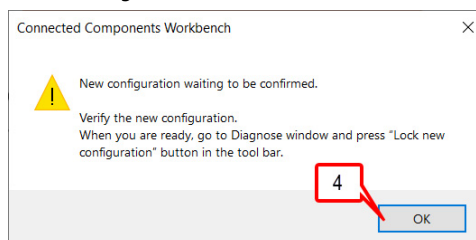

- In [Figure 157](#), click Diagnose.

Figure 157 - Diagnose

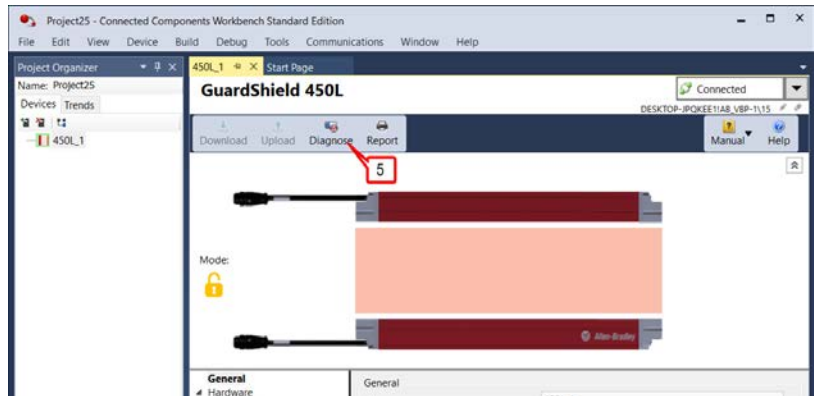

- In [Figure 158](#), click Lock.

Figure 158 - Lock

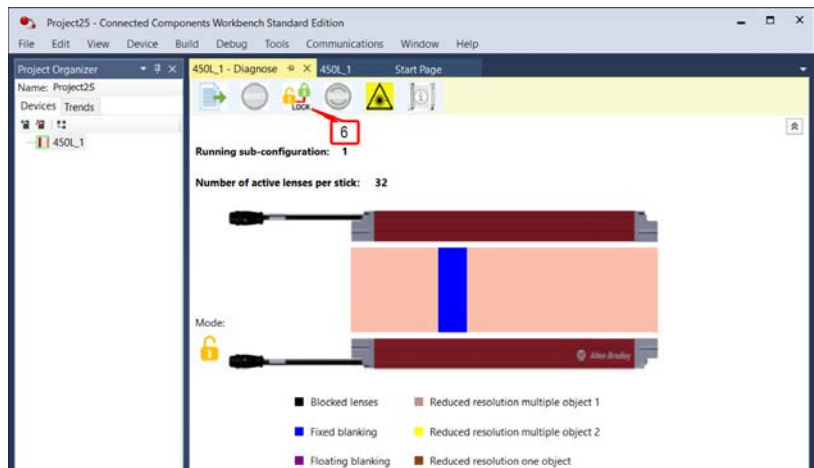

The light curtain can now be configured using the new hardware.

Share Your Project (Export/Import)

Projects and devices can be easily shared with other users by using the Import and Export routines. Complete projects can be exported to a Connected Components Workbench software archive file. Individual devices can be exported to a zip file.

Export Project to a Connected Components Workbench Software Archive

- Select File > Export Project, as shown in [Figure 159 on page 182](#).

This approach creates a small file that can be imported into the Connected Components Workbench software. This method can be used when you have only one device or when multiple devices are included in one project. In [Figure 159 on page 182](#), all four devices are included in the archive file.

Figure 159 - File > Export Project

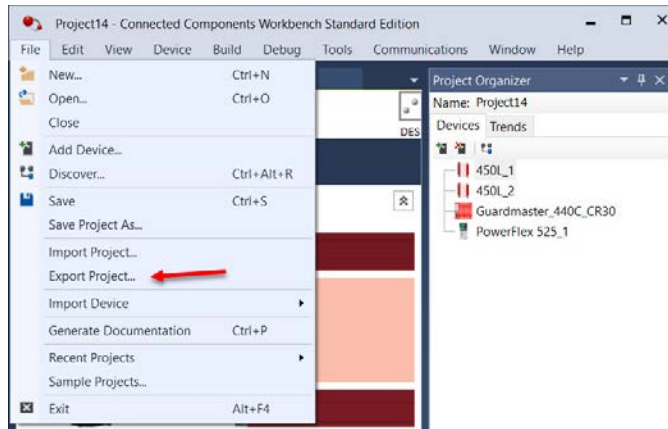

2. The Connected Components Workbench software exports the archive file in the default directory Import_Export, as shown in [Figure 160](#). Type in a filename and click Save. The only file type is *.ccwarc.

Figure 160 - Export Directory and Filename

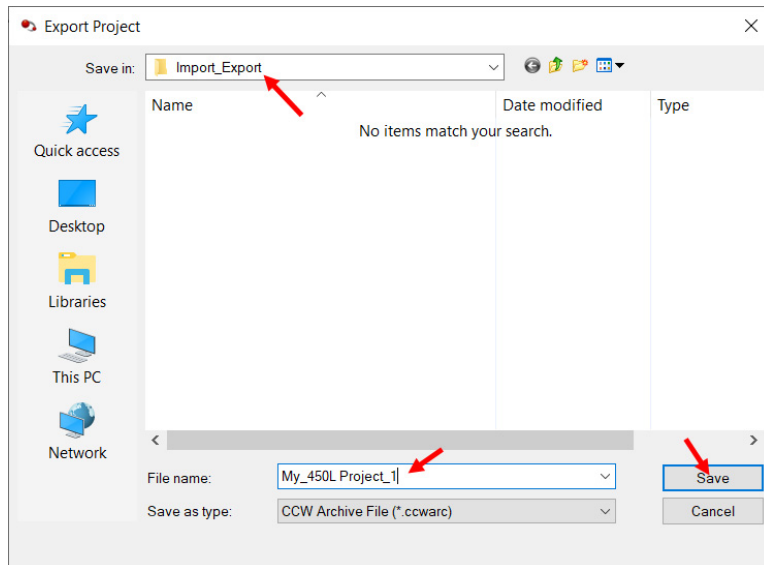

3. The Connected Components Workbench software generates a confirmation and displays the message in the Output window, as shown in [Figure 161](#). The message shows the file path and filename.

Figure 161 - Export Confirmation

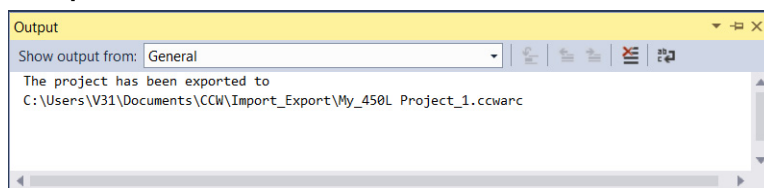

Import Project from a Connected Components Workbench Software Archive

When an archive file is imported into the Connected Components Workbench software, the current project is closed, without saving, and replaced by the imported project.

1. In [Figure 162](#), click File > Import Project on the main menu. The Connected Components Workbench software opens the default Import_Export directory.

Figure 162 - File > Import Project

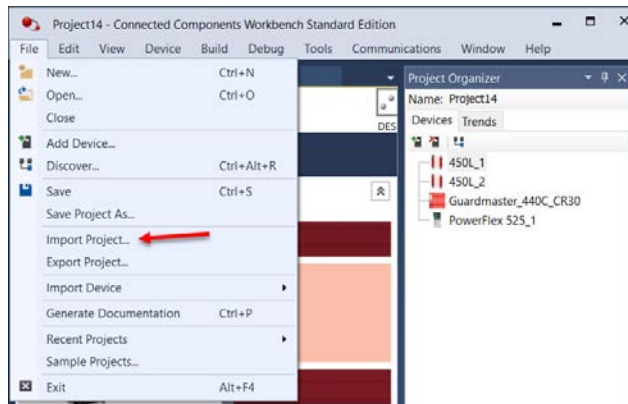

2. In [Figure 163](#), click on the file you want to import; the file type must be a CCWARC type of file. The name appears in the File name field. Click Open.

Figure 163 - Import Archive Filename

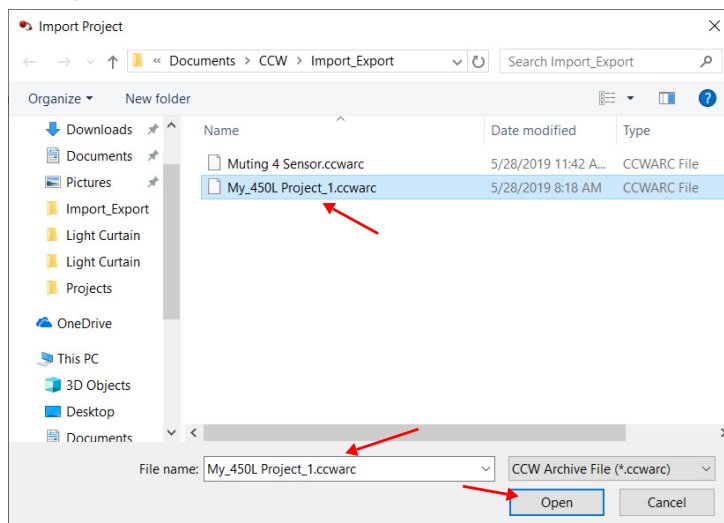

3. If the filename exists, the Connected Components Workbench software creates a project by incrementing a number at the end of the filename. As shown in [Figure 164](#), My_450L Project_2 is created. Click OK.

Figure 164 - Import as a New Project

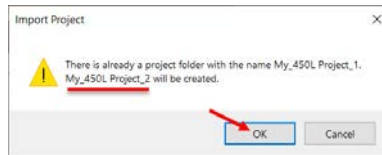

Export Device to Zip File

Use this method if you have multiple devices in one project and want to share the configuration of only one device. This approach creates a 7-Zip (free software) directory of files. After expanding the files, the files can be imported into the Connected Components Workbench software.

1. In [Figure 165](#), right-click the device in the Project Organizer and select export.

Figure 165 - Device > Export

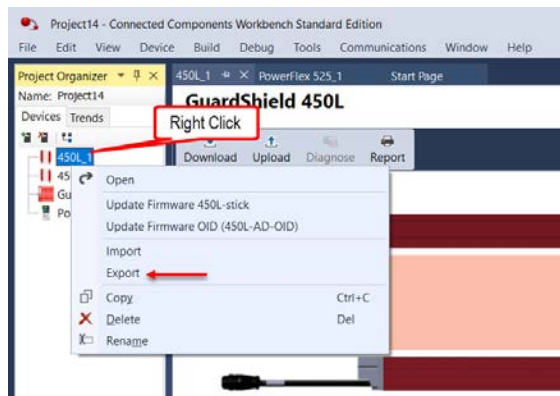

2. In [Figure 166](#), select the directory; type in a filename and click Save.

Figure 166 - Export to Zip File

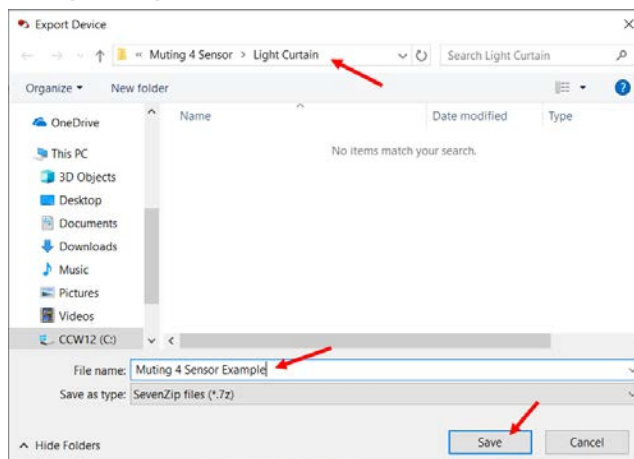

3. The Connected Components Workbench software does not provide a confirmation message. To confirm the export, follow the export file path. [Figure 167](#) shows the single zipped file.

Figure 167 - Zip File Confirmation

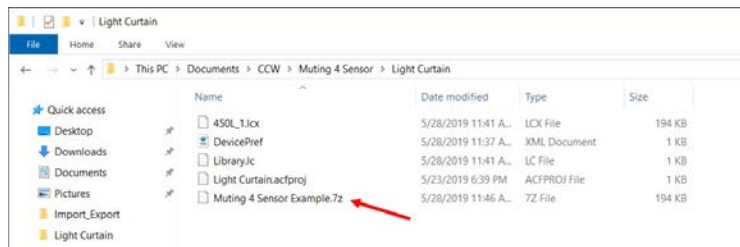

Import a Zip File

1. In [Figure 168](#), right-click the device in the Project Organizer. Then click Import. This process replaces the configuration of the selected device with the imported configuration.

Figure 168 - Device > Import

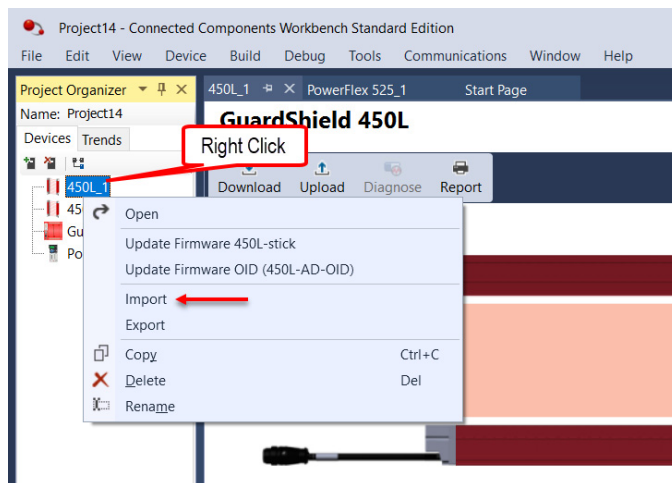

In [Figure 169](#), search for the directory that contains the desired file. The file type must be 7z. Highlight the filename and click Open. The configuration is imported into the selected Connected Components Workbench software device.

Figure 169 - Import a Zip File

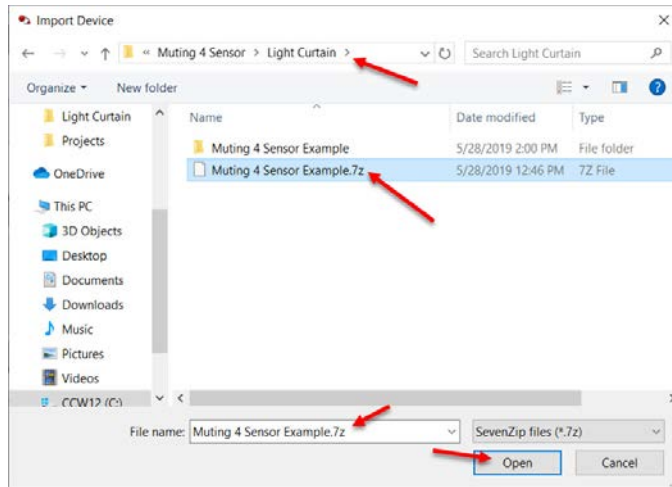

Update Firmware

Each release of the Connected Components Workbench software includes updated versions of the firmware. Both the Optical Interface Device and the light curtain contain firmware. The firmware can also be updated using ControlFLASH software.

1. In the Project Organizer (Figure 170), right click the device name or its icon (450L_1). Then select either Update Firmware 450K-stick or Update Firmware OID (450L-AD-OID).

Figure 170 - Project Organizer: Device > Update Firmware

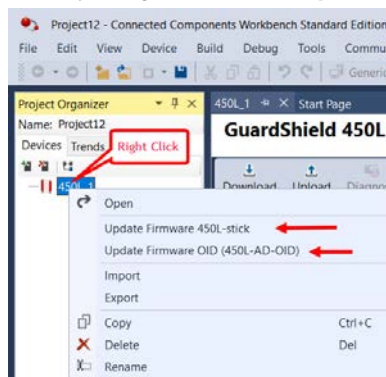

2. Follow the instructions in the message box (Figure 171). If you are updating the firmware in the OID, then the OID must not be mounted on the light curtain. If you are updating the firmware in the light curtain, then the OID must be mounted on the light curtain with the light curtain powered. Click OK.

Figure 171 - Stick or OID Connection

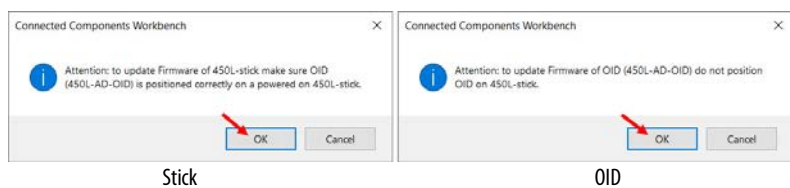

[Figure 172](#) shows the Connection Browser with connections to the Stick and the OID.

- In the Connection Browser, expand the AB_VBP-1. Both the OID and the light curtain are shown. One of the two always have an X over its icon. If you are updating the light curtain, the OID is not available. If you are updating the OID, the light curtain is not available. Click the Bulletin 450L to select it. Click OK.

Figure 172 - Connection Browser

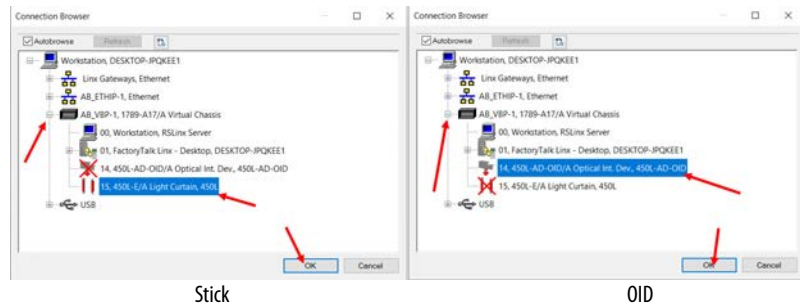

- In [Figure 173](#), verify the target revision or select a revision from the pull-down menu and click Update.

Figure 173 - Update Hardware



Progress of the update is shown on [Figure 174](#).

Figure 174 - Update Progress Bar

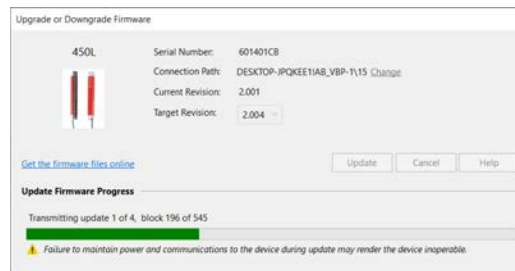

- [Figure 175](#) shows a courtesy message. If you are updating the sticks, you must update both sticks. Click OK.

Figure 175 - Update Both Sticks

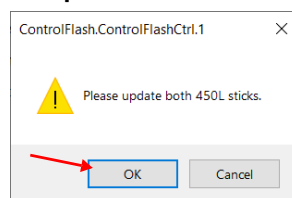

If both sticks are powered and properly aligned, both sticks are updated simultaneously. If both sticks are slightly misaligned, the update may not be successful. If your update fails, block the top and bottom synchronization beams and update the sticks individually.

Best practice is to mount the OID on the other stick. Check the revision. If the current revision is not the same as the target revision, then repeat the update procedure.

Specifications

This appendix provides the specifications for 450L-B and 450L-E safety light curtains.

Safety Ratings

Table 70 - Safety Ratings

Attribute	Value
Standards	IEC 61508, EN/ISO 13849-1, IEC 62061, UL 508 (see rok.auto/certifications for Declaration of Conformity)
Safety classification	Type 4 according to IEC 61496-1/-2 Up to PLe (Category 4) per ISO 13849-1, SIL 3 per IEC 61508 SILcl 3 per IEC 62061 Laser alignment of 450L-E safety light curtain: Laser class 2 according to IEC 60285-1.
Functional safety data	450L-B; Pair (including any connection plug-in) <ul style="list-style-type: none"> • PFHD: $12.7 \cdot 10^{-9}$ • Mission time/PTI: 20 years • Mode of operation: High demand mode 450L-E; Pair (including any connection plug-in) <ul style="list-style-type: none"> • Pair: PFHD: $12.7 \cdot 10^{-9}$ • Cascading plug-in PFHD: $0.96 \cdot 10^{-9}$ • Mission time/PTI: 20 years • Mode of operation: High demand mode

Operating Characteristics

Table 71 - Operating Characteristics

Attribute	Value
Switch function	OSSDs enable (on, high, 24V DC) when protective field not interrupted
Protective field length	150...1950 mm (5.91...76.77 in.) in 150 mm (5.91 in.) increments
Resolution	Finger: 14 mm (0.56 in.); Hand: 30 mm (1.19 in.)
Number of active lenses (see Table 9 on page 23)	Finger: 16 per 150 mm (5.91 in.) increment; Hand: 8 per 150 mm (5.91 in.) increment
Operating range	450L-B: <ul style="list-style-type: none"> • Resolution 14 mm (0.56 in.): 0.5...4 m (1.64...13.12 ft) • Resolution 30 mm (1.19 in.): 0.9...7.0 m (2.95...22.97 ft) • Reduced operating range (selected with DIP switch): <ul style="list-style-type: none"> – Resolution 14 mm (0.56 in.): 0.9...2 m (2.95...6.56 ft) – Resolution 30 mm (1.19 in.): 1.2...3.5 m (3.94...11.48 ft) 450L-E: <ul style="list-style-type: none"> • Resolution 14 mm (0.56 in.): 0.5...9 m (1.64...29.53 ft) • Resolution 30 mm (1.19 in.): 0.9...16.2 m (2.95...53.15 ft) • Reduced operating range (selected with DIP switch): <ul style="list-style-type: none"> – Resolution 14 mm (0.56 in.): 0.9...4.5 m (2.95...14.76 ft) – Resolution 30 mm (1.19 in.): 1.2...8.0 m (3.94...26.25 ft)

Table 71 - Operating Characteristics

Attribute	Value
Response time	450L-B <ul style="list-style-type: none"> OSSD – ON to OFF Finger resolution <25 ms Hand resolution < 15 ms (for details see Response Time on page 48) 450L-E <ul style="list-style-type: none"> OSSD – ON to OFF (no blanking, muting, beam coding, or cascading functionality configured) Finger resolution <20 ms Hand resolution <13 ms (for detail see Response Time on page 48)
Power up time, max	5 s
OSSD restart time after clearance of the protective field if automatic reset	210 ms (see Response Time on page 48)
Power Supply	24V DC ±15%; NEC Class 2 (U.S.). PELV per IEC 60204-1.
Power consumption (single stick)	450L-B Protective height: <ul style="list-style-type: none"> 150 mm (5.91 in.): 64 mA maximum 1950 mm (76.77 in.): 214 mA (outputs not loaded) 450L-E Protective height: <ul style="list-style-type: none"> 150 mm (5.91 in.): 70 mA maximum 1950 mm (76.77 in.): 221 mA (Output not loaded) 450L-APC-10-8: additional 40 mA (with termination plug)
Peak current during power-up cycle	800 mA maximum (outputs not loaded)
Duration of peak current during power-up cycle	100 ms
Power down time (OSSD<2V)	3000 ms
Transmitted infrared wave length	Infrared (wave length 855 nm)
Aperture angle	Within ±2.5° @ 3 m (9.8 ft)
Synchronization	Optical
DIP switch selectable functions	Depends on inserted plug-in: <ul style="list-style-type: none"> 450L-B: start mode; external device monitoring (EDM); maximum operating range 450L-E: start mode; external device monitoring (EDM); maximum operating range, beam coding, blanking, muting
Lifetime expectancy	<ul style="list-style-type: none"> DIP switch on plug-in: 1000 cycles Plug-in on transceiver stick: 50 cycles
Ambient light	<ul style="list-style-type: none"> Incandescent lamp: 3000 lux or less Sunlight: 100,000 lux or less

Inputs Receiver Plug-in, Cascading Plug-in, and Universal Plug-in

Table 72 - Inputs Receiver Plug-in, Cascading Plug-in, and Universal Plug-in

Attribute	Value
Input Manual start	Minimum duration 50 ms; maximum duration 5 seconds Voltage level for Logic Low/0: 0...5V DC Voltage level for Logic Hi/1: > 16V DC Current: 7 mA typical
Input EDM	300 ms after activation of OSSD Voltage level for Logic Low/0: 0...5V DC Voltage level for Logic Hi/1: > 16V DC Current: 7 mA typical
Input muting sensors	Voltage level for Logic Low/0: 0...5V DC Voltage level for Logic Hi/1: >16V DC Current: 7 mA typical

Safety Outputs (OSSDs): Receiver Plug-in

Table 73 - Safety Outputs (OSSDs): Receiver Plug-in

Attribute	Value
Safety outputs (OSSDs)	Two solid-state outputs
Switching capacity	500 mA each, maximum
OFF-current, max	<2 mA
Residual voltage (drop from power supply)	2V (excl. voltage drop through cables), maximum
Connection cable length	100 m (330 ft) maximum with 22 AWG; Condition: power supply 24V and maximum load on outputs 50 mA total
Switching voltage to HIGH (Ueff)	11...30 V
Switching voltage to LOW	-3...2V
Load capacity	0.5 µF maximum
Short circuit protection	Yes
Test pulse data	See OSSD Output on page 100
Short circuit detection	Yes
Galvanic isolation: I/O from Logic	No

Status Outputs

Table 74 - Status Outputs

Attribute	Value
Number of status outputs	Receiver plug-in: Up to three nonsafety solid-state outputs (depends on plug-in) I/O-cascading plug-in: Up to three solid-state outputs (depends on configuration)
Switching capacity	200 mA each, maximum
Residual voltage (drop from power supply)	2V (excl. voltage drop through cables), maximum
Short circuit protection	Yes
Galvanic isolation: I/O from Logic	No

Environmental and General Protection

Table 75 - Environmental and General Protection

Attribute	Value
Operating temperature	-10...+55 °C (14...131 °F)
Storage temperature	-25...+75 °C (-13...+167 °F)
Operating humidity	5... 95% (without condensation)
Enclosure rating	IP65
Vibration Resistance	Per IEC 61496-1, IEC 60068-2-6 Frequency 10...55 Hz Amplitude 0.35 mm (0.01 in.)
Shock	Per IEC 61496-1, IEC 60068-2-29 Acceleration 10 g (0.35 oz), Duration 16 ms
Pollution level	2

Electrical Protection

Table 76 - Electrical Protection

Attribute	Value
Short circuit protection	Incorporated
Current limitation	Incorporated
Overload protection	Incorporated
Reverse polarity protection	Incorporated
Overvoltage protection	Incorporated (up to 60V max.)
Thermal shutdown/restart	Incorporated

General

Table 77 - General

Attribute	Value
Materials	Transceiver stick (450L-B...) or 450L-E: <ul style="list-style-type: none"> • Profile: Extruded aluminum, powder coated • End caps: Polyamide • Front window: Polycarbonate • Screws: Steel
	Plug-in (450L-AP...): <ul style="list-style-type: none"> • Pig tail cable: Polyurethane • M12 Connector: Bare copper, SR-PVC, PUR • Body: Polyamide
	Top/Bottom (Cat. No. 450L-AM-TBM) mounting brackets: <ul style="list-style-type: none"> • Bracket: Steel, powder coated • Screws: Steel
	Side mounting brackets (Cat. No. 450L-AM-SM): <ul style="list-style-type: none"> • Body: Polyamide • Screws: Steel
	Replacement brackets (Cat. No. 450L-AM-RK): <ul style="list-style-type: none"> • Bracket: Aluminum, black anodized • Screws: Steel
	Laser-alignment tool bracket (Cat. No. 450L-ALAT-C): <ul style="list-style-type: none"> • Bracket: Polyamide • Test rod: Aluminum • Optical Interface Device (Cat. No. 450L-AD-OID): Polyamide
Stick dimensions	<ul style="list-style-type: none"> • Cross section: 30 x 30 mm (1.19 x 1.19 in.) • Length: N x 150 mm (N x 5.9 in.) [N = 1 ... 13]
Screw type and maximum torque of top/bottom mounting bracket	M3 x 10; Phillips screw 0.7 N·m (6.2 lb·in) max.
Screw type and maximum torque for M2 screws of plug-in	M2 x 8; Phillips screw 0.38 N·m (3.4 lb·in) max.
Maximum torque for screws of side mounting bracket	<ul style="list-style-type: none"> • M6 screws: 11 N·m • M4 screws: 2.8 N·m
Indicators stick	450L-B and 450L-E: Transceiver type (Rx or Tx) Status Intensity (for two regions) Start/Restart Output
	450L-E only: Muting Blanking Cascading
Connection plug	Depending on installed plug-in: M12 5-pin (male) or M12 8-pin (male) fixed at pigtail with cable length: Connection plug-ins: 150 mm (11.81 in.) I/O cascading plug-in: 60 mm (2.36 in.); Minimum outer bend radius of pigtail: > 3xD: 5-pin: D = 4.4 mm (0.17 in.) 8-pin: D = 5.5 mm (0.22 in.)
Connection cable length	Maximum 100 m (330 ft) with wire section AWG 22 (Condition: Power supply 24V and maximum load on outputs 50 mA total)
Accessories included	Test rod, top/bottom mounting brackets and installation instruction
Silicon	The unit does not release any silicone or other LABS-critical substances and is suitable for use in paint shops.

Certifications

See the Product Certification link at rok.auto/certifications for Declaration of Conformity, Certificates, and other certification details.

- c-UL-us Listed Industrial Control Equipment, which is certified for US and Canada
- CE Marked for all applicable directives (see [Compliance to European Union Directives on page 193](#))
- RCM marked (Australia)
- TÜV Rheinland Certified for functional safety up to SIL 3 Category 4 for use in safety applications up to and including SIL 3, in accordance with IEC 61508 and EN 62061, Performance Level e and Category 4 in accordance with ISO 13849-1, ESPE type 4 safety light curtain according to EN IEC 61496. TÜV Rheinland confirmed that the laser class of the integrated laser alignment tool that is integrated in all 450L safety light curtain sticks conforms to laser class 2 of IEC 60825-1.

Compliance to European Union Directives

Rockwell Automation B.V. (address: Rivium Promenade 160, 2909 LM Capelle aan den IJssel, The Netherlands) declares that this product is in conformity with the provisions of the following EC directives (including all applicable amendments): 2014/30/EU Electromagnetic Compatibility Directive (EMC) and 2006/42/EC Machinery Directive (MD)

And that the respective standards and/or technical specifications have been applied. It is approved for installation within the European Union and EEA regions. All relevant directives and standards are listed in the declaration of conformity, which is available on <http://www.rockwellautomation.com/global/certification/overview.page>.

Approximate Dimensions

450L-B and 450L-E safety light curtain transceiver sticks have the same dimensions. The only difference is, that the 450L-E safety light curtain sticks have an additional slot, which allows the insertion of a cascading plug-in and the connection plug-in.

Figure 176 - 450L Safety Light Curtain Stick Dimensions [mm (in.)]

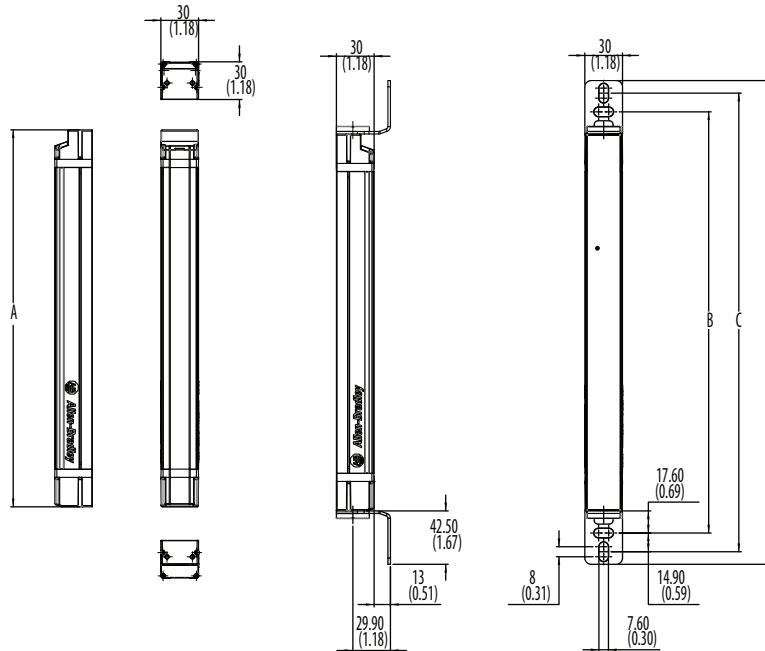

Cat. No.	A	B	C	D
	Protective Height	Mounting Value	Mounting Value	Total Length
450L-B4xN0150YD	150 (5.91)	185.5 (7.3)	215 (8.46)	235 (9.25)
450L-E4xL0150YD				
450L-B4xN0300YD	300 (11.81)	335.5 (13.21)	365 (14.37)	385 (15.16)
450L-E4xL0300YD				
450L-B4xN0450YD	450 (17.72)	485.5 (19.11)	515 (20.28)	535 (21.06)
450L-E4xL0450YD				
450L-B4xN0600YD	600 (23.62)	635.5 (25.02)	665 (26.18)	685 (26.97)
450L-E4xL0600YD				
450L-B4xN0750YD	750 (29.53)	785.5 (30.93)	815 (32.09)	835 (32.87)
450L-E4xL0750YD				
450L-B4xN0900YD	900 (35.43)	935.5 (36.83)	965 (37.99)	985 (38.78)
450L-E4xL0900YD				
450L-B4xN1050YD	1050 (41.34)	1085.5 (42.74)	1115 (43.9)	1135 (44.68)
450L-E4xL1050YD				
450L-B4xN1200YD	1200 (47.24)	1235.5 (48.64)	1265 (49.8)	1285 (50.59)
450L-E4xL1200YD				
450L-B4xN1350YD	1350 (53.15)	1385.5 (54.55)	1415 (55.71)	1435 (56.5)
450L-E4xL1350YD				
450L-B4xN1500YD	1500 (59.06)	1535.5 (60.45)	1565 (61.61)	1585 (62.4)
450L-E4xL1500YD				
450L-B4xN1650YD	1650 (64.96)	1685.5 (66.36)	1715 (67.52)	1735 (68.31)
450L-E4xL1650YD				
450L-B4xN1800YD	1800 (70.87)	1835.5 (72.26)	1865 (73.43)	1885 (74.21)
450L-E4xL1800YD				
450L-B4xN1950YD	1950 (76.77)	1985.5 (78.17)	2015 (79.33)	2035 (80.12)
450L-E4xL1950YD				

Product Selection

Sticks

The catalog number refers to a stick, including top/bottom mounting kit and test rod.

450L - $\frac{B}{a}$ 4 $\frac{H}{b}$ $\frac{N}{c}$ - $\frac{0750}{d}$ - Y D

a		b		c		d			
Transceiver Stick Type		Resolution [mm (in.)]		Laser Alignment		Protected Height [mm (in.)]			
Code	Description	Code	Description	Code	Description	Code	Description	Code	Description
B	Basic	H	Hand (30 [1.19])	N	Not integrated	0150	150 (5.91)	1200	1200 (47.28)
E	Enhanced					0300	300 (11.82)	1350	1350 (53.19)
		F	Finger (14 [0.56])	L	Integrated	0450	450 (17.73)	1500	1500 (59.1)
						0600	600 (23.64)	1650	1650 (65.01)
						0750	750 (29.55)	1800	1800 (70.92)
						0900	900 (35.46)	1950	1950 (76.83)
						1050	1050 (41.37)		

Protective Field Length [mm (in.)]	Cat. No. ⁽¹⁾⁽²⁾		Approximate Shipping Weight (With Packaging) [kg (lb)]	Shipping Dimensions [mm (in.)]
	Resolution 14 mm (0.56 in.)	Resolution 30 mm (1.19 in.)		
150 (5.90)	450L-x4Fy0150YD	450L-x4Hy0150YD	0.59 (1.3)	860 x 111 x 68 (33.86 x 4.37 x 2.68)
300 (11.81)	450L-x4Fy0300YD	450L-x4Hy0300YD	0.72 (1.59)	860 x 111 x 68 (33.86 x 4.37 x 2.68)
450 (17.72)	450L-x4Fy0450YD	450L-x4Hy0450YD	0.85 (1.87)	860 x 111 x 68 (33.86 x 4.37 x 2.68)
600 (32.62)	450L-x4Fy0600YD	450L-x4Hy0600YD	0.98 (2.16)	1310 x 111 x 68 (51.57 x 4.37 x 2.68)
750 (29.53)	450L-x4Fy0750YD	450L-x4Hy0750YD	1.11 (2.45)	1310 x 111 x 68 (51.57 x 4.37 x 2.68)
900 (35.43)	450L-x4Fy0900YD	450L-x4Hy0900YD	1.24 (2.73)	1310 x 111 x 68 (51.57 x 4.37 x 2.68)
1050 (41.34)	450L-x4Fy1050YD	450L-x4Hy1050YD	1.37 (3.02)	1760 x 111 x 68 (69.29 x 4.37 x 2.68)
1200 (47.24)	450L-x4Fy1200YD	450L-x4Hy1200YD	1.5 (3.3)	1760 x 111 x 68 (69.29 x 4.37 x 2.68)
1350 (53.15)	450L-x4Fy1350YD	450L-x4Hy1350YD	1.63 (3.59)	1760 x 111 x 68 (69.29 x 4.37 x 2.68)
1500 (59.05)	450L-x4Fy1500YD	450L-x4Hy1500YD	1.77 (3.90)	2360 x 111 x 68 (92.91 x 4.37 x 2.68)
1650 (64.96)	450L-x4Fy1650YD	450L-x4Hy1650YD	1.91 (4.21)	2360 x 111 x 68 (92.91 x 4.37 x 2.68)
1800 (70.86)	450L-x4Fy1800YD	450L-x4Hy1800YD	2.05 (4.52)	2360 x 111 x 68 (92.91 x 4.37 x 2.68)
1950 (76.77)	450L-x4Fy1950YD	450L-x4Hy1950YD	2.18 (4.81)	2360 x 111 x 68 (92.91 x 4.37 x 2.68)

(1) Replace x with B for 450L-B or E for 450L-E.

(2) Replace y with N for 450L-B or with L for 450L-E.

Plug-ins

450L - APR - ON - 5N
 a b c

a		b		c	
Plug-in Type		Function		Number of Pins	
Code	Description	Code	Description	Code	Description
APR	Accessory plug-in receiver	PW	Power	5	5-pin
APT	Accessory plug-in transmitter	ON	On/Off	8	8-pin
APU	Accessory plug-in universal	ED	EDM		
APC	Accessory plug-in cascading	UN	Universal		
		BK	Blanking		
		MU	Muting		
		IO	I/O cascading		

Description	Cat. No.
450L plug-in Tx 5-pin	450L-APT-PW-5
450L plug-in Tx 8-pin	450L-APT-PW-8
450L plug-in Rx ON/OFF 5-pin	450L-APR-ON-5
450L plug-in Rx EDM 8-pin	450L-APR-ED-8
450L plug-in universal 8-pin	450L-APU-UN-8
450L plug-in blanking 5-pin	450L-APR-BL-5
450L plug-in muting 8-pin	450L-APR-MU-8
450L plug-in cascading 8-pin	450L-APC-IO-8

Figure 177 - 450L Connection Plug-in Dimensions [mm (in.)]

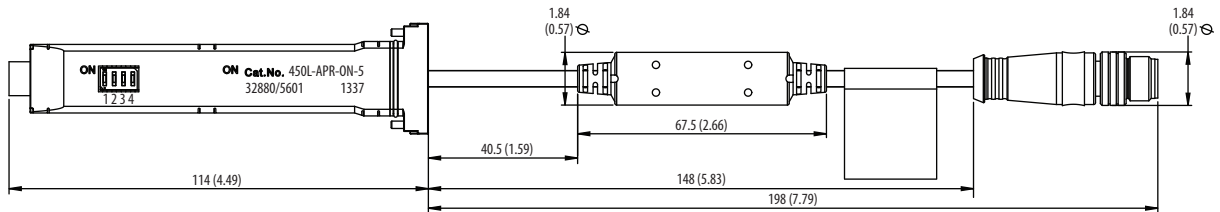
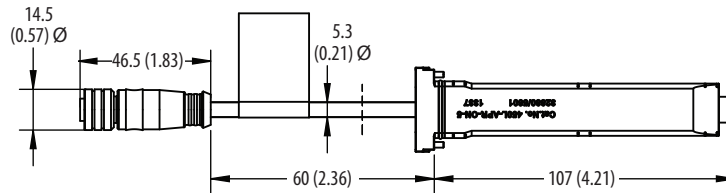

Figure 178 - 450L-APC-IO-8 Cascading Plug-in Dimensions [mm (in.)]



Optional Accessories

Description	Cat. No.
L-shaped end-cap mounting bracket kit (two per package), shipped with each stick (see Standard Top/Bottom Mounting Kit on page 82)	450L-AM-TBM
Side mounting bracket (2 per package) (see Side Mounting Bracket on page 84)	450L-AM-SM
Replacement Mounting Kit (see Replacement Mounting Kit on page 86)	450L-AM-RK
445L bracket (2 per package)	445L-AF6140
445L bracket (180°) (2 per package)	445L-AF6141
Power supply Output—24V DC, 3 amps, 72 W (see Power Supply on page 98)	1606-XLP72E
Laser alignment tool (see Alignment Tool and Bracket on page 202)	440L-ALAT
450L-B laser alignment tool bracket (see Alignment Tool and Bracket on page 202)	450L-ALAT-C
Optical Interface Device (including USB cable) (see Optical Interface Device (OID) on page 120)	450L-AD-OID
450L stick slot cover (plug-in slot, one red slot cover shipped with each 450L-B stick; one red and one gray slot cover shipped with each 450L-E stick). (see Cascading on page 48 and Figure 5 on page 14)	450L-AS-1
Shock mount kit (one kit is required per stick) (see Shock Mounting Kit on page 86)	445L-AF6142
Mounting stand (column) (see Mounting Columns on page 200)	440L-AMSTD
Mounting stand (column) (See publication 445L-UM004)	445L-AMSTD2M
Corner mirror (xxxx = 0300...1800 mm [11.8...70.86 in.] in 150 mm [5.9 in.] increments) (see Mirrors on page 74)	440L-AM075xxxx
Corner mirror (xxxx = 0300...1800 mm [11.8...70.86 in.] in 150 mm [5.9 in.] increments) (see Mirrors on page 74)	440L-AM125xxxx
Mirror mounting bracket (see Corner Mirror on page 198)	442L-AF6106
Weld shield (xxxx = 0150...1950 mm [5.9...76.77 in.] in 150 mm [5.9 in.] increments) (see Weld Shields on page 202)	450L-AW-xxxx
T-connector (see T-connector on page 104)	1485P-RDR5
Safety Relay GSR SI (see Guardmaster SI Safety Relay on page 103)	440R-S12R2
GSR CI	440R-S13R2
GSR D	440R-D22R2
GSR DIS	440R-D22S2
Safety Relay MSR42	440R-P226AGS-NNR
Configurable Safety Relay CR-30	440C-CR30-22BBB
External contactor	100S:
	100S-C09QJ14BC,
	100S-C43QJ22BC
	700S:
	700S-CF53QDJBC
	(or minor variations)
Test rod 14 mm (shipped with each stick that has finger resolution) (see Regular Inspection on page 123)	450L-AT-14
Test rod 30 mm (shipped with each stick that has hand resolution) (see Regular Inspection on page 123)	450L-AT-30
Test rod 40 mm (see Regular Inspection on page 123)	450L-AT-40
Termination plug, M12, 8 pin (see Cascading and Blanking on page 52)	898D-81CU-DM
Termination cap, M12, 8 pin (see Cascading and Blanking on page 52)	1485A-M12

Corner Mirror

Specially constructed glass mirrors for two-sided and three-sided safeguard applications (see [Mirrors on page 72](#) for installation).

IMPORTANT Each mirror reduces maximum scan range by 10%. Each corner mirror is supplied with two end-cap mounting brackets (Cat. No. 442L-AF6106).

Figure 179 - Dimensions of the Mirror (440L-AM075) (Width 75 mm (2.95 in.))

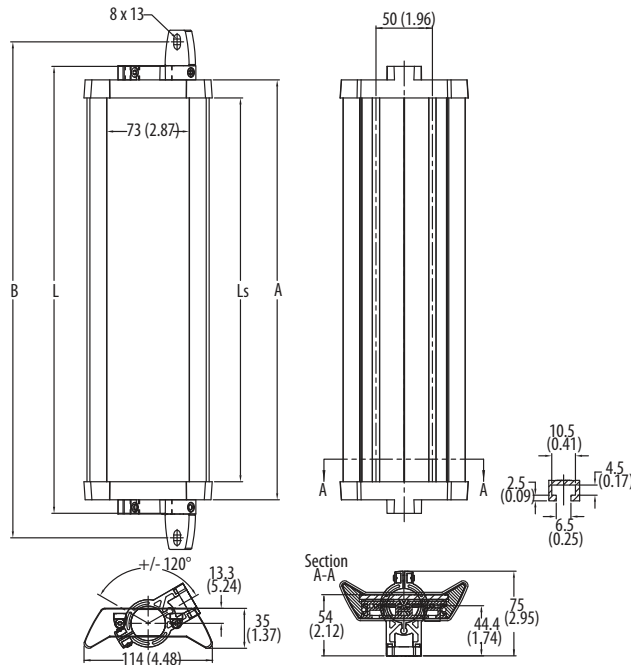

Table 78 - Mirror (75 mm (2.95 in.)) Width

Cat. No.	Series	Description	L	LS	A	B	Protective Height 450L [mm]
440L-AM0750300	A	Mirror, 300 mm (11.81 in.), 4 m (13.12 ft)	396	340	372	440	300
440L-AM0750450	A	Mirror, 450 mm (17.72 in.), 4 m (13.12 ft)	546	490	522	590	450
440L-AM0750600	A	Mirror, 600 mm (23.62 in.), 4 m (13.12 ft)	696	640	672	740	600
440L-AM0750750	A	Mirror, 750 mm (29.53 in.), 4 m (13.12 ft)	846	790	822	890	750
440L-AM0750900	A	Mirror, 900 mm (35.43 in.), 4 m (13.12 ft)	996	940	972	1040	900
440L-AM0751050	A	Mirror, 1050 mm (41.34 in.), 4 m (13.12 ft)	1146	1090	1122	1190	1050
440L-AM0751200	A	Mirror, 1200 mm (47.24 in.), 4 m (13.12 ft)	1296	1240	1272	1340	1200
440L-AM0751350	A	Mirror, 1350 mm (53.15 in.), 4 m (13.12 ft)	1446	1390	1422	1490	1350
440L-AM0751500	A	Mirror, 1500 mm (59.05 in.), 4 m (13.12 ft)	1596	1540	1572	1640	1500
440L-AM0751650	A	Mirror, 1650 mm (64.96 in.), 4 m (13.12 ft)	1746	1690	1722	1790	1650
440L-AM0751800	A	Mirror, 1800 mm (70.86 in.), 4 m (13.12 ft)	1896	1840	1872	1940	1800

Figure 180 - Dimensions of the Mirror (440L-AM125) (Width 125 mm (4.92 in.))

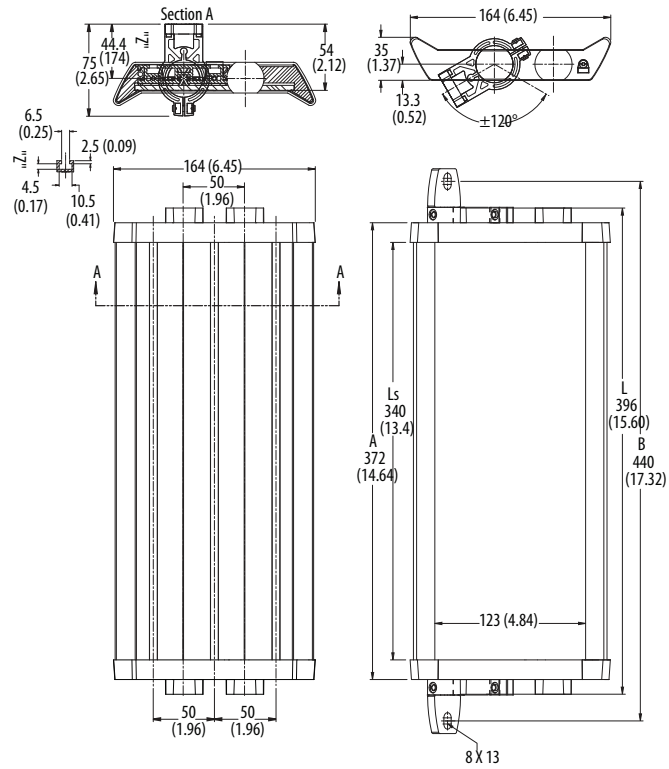
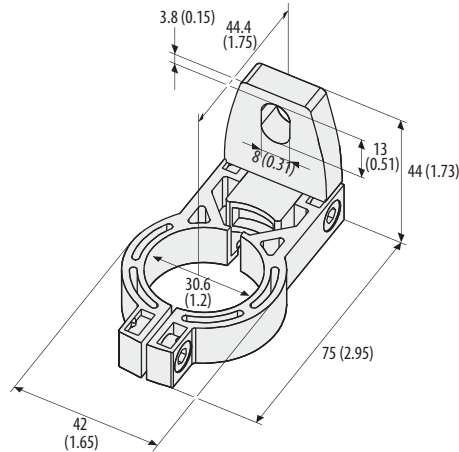

Table 79 - Mirror (Width: 125 mm (4.92 in.))

Cat. No.	Series	Description	L	LS	A	B	Protective Height 450L [mm]
440L-AM1250300	A	Mirror, 300 mm (11.81 in.), 4 m (13.12 ft)	396	340	372	440	300
440L-AM1250450	A	Mirror, 450 mm (17.72 in.), 4 m (13.12 ft)	546	490	522	590	450
440L-AM1250600	A	Mirror, 600 mm (23.62 in.), 4 m (13.12 ft)	696	640	672	740	600
440L-AM1250750	A	Mirror, 750 mm (29.53 in.), 4 m (13.12 ft)	846	790	822	890	750
440L-AM1250900	A	Mirror, 900 mm (35.43 in.), 4 m (13.12 ft)	996	940	972	1040	900
440L-AM1251050	A	Mirror, 1050 mm (41.34 in.), 4 m (13.12 ft)	1146	1090	1122	1190	1050
440L-AM1251200	A	Mirror, 1200 mm (47.24 in.), 4 m (13.12 ft)	1296	1240	1272	1340	1200
440L-AM1251350	A	Mirror, 1350 mm (53.15 in.), 4 m (13.12 ft)	1446	1390	1422	1490	1350
440L-AM1251500	A	Mirror, 1500 mm (59.05 in.), 4 m (13.12 ft)	1596	1540	1572	1640	1500
440L-AM1251650	A	Mirror, 1650 mm (64.96 in.), 4 m (13.12 ft)	1746	1690	1722	1790	1650
440L-AM1251800	A	Mirror, 1800 mm (70.86 in.), 4 m (13.12 ft)	1896	1840	1872	1940	1800

Figure 181 - Swivel Mounting Bracket 442L-AF6106 for Corner Mirrors



Mounting Columns

Two stands are available to mount sticks or mirrors. To mount the 450L safety light curtain transceiver stick at any height of the catalog number 440L-AMSTD, use side-mounting kit (catalog number 450L-AM-SM).

Figure 182 - Figure 80 - 440L-AMSTD

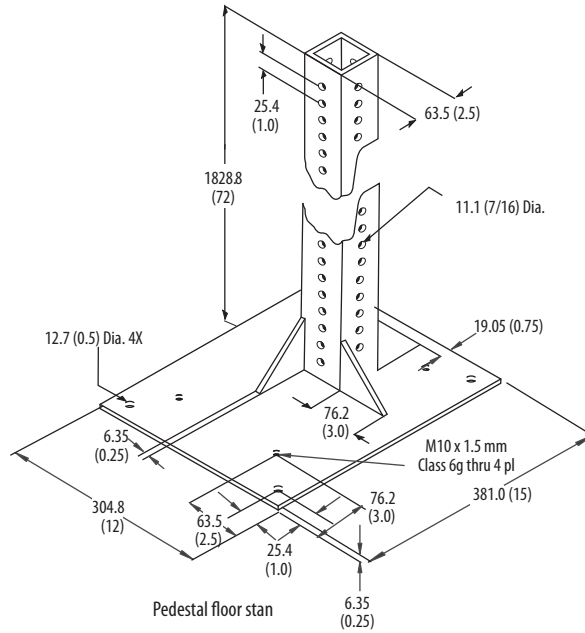
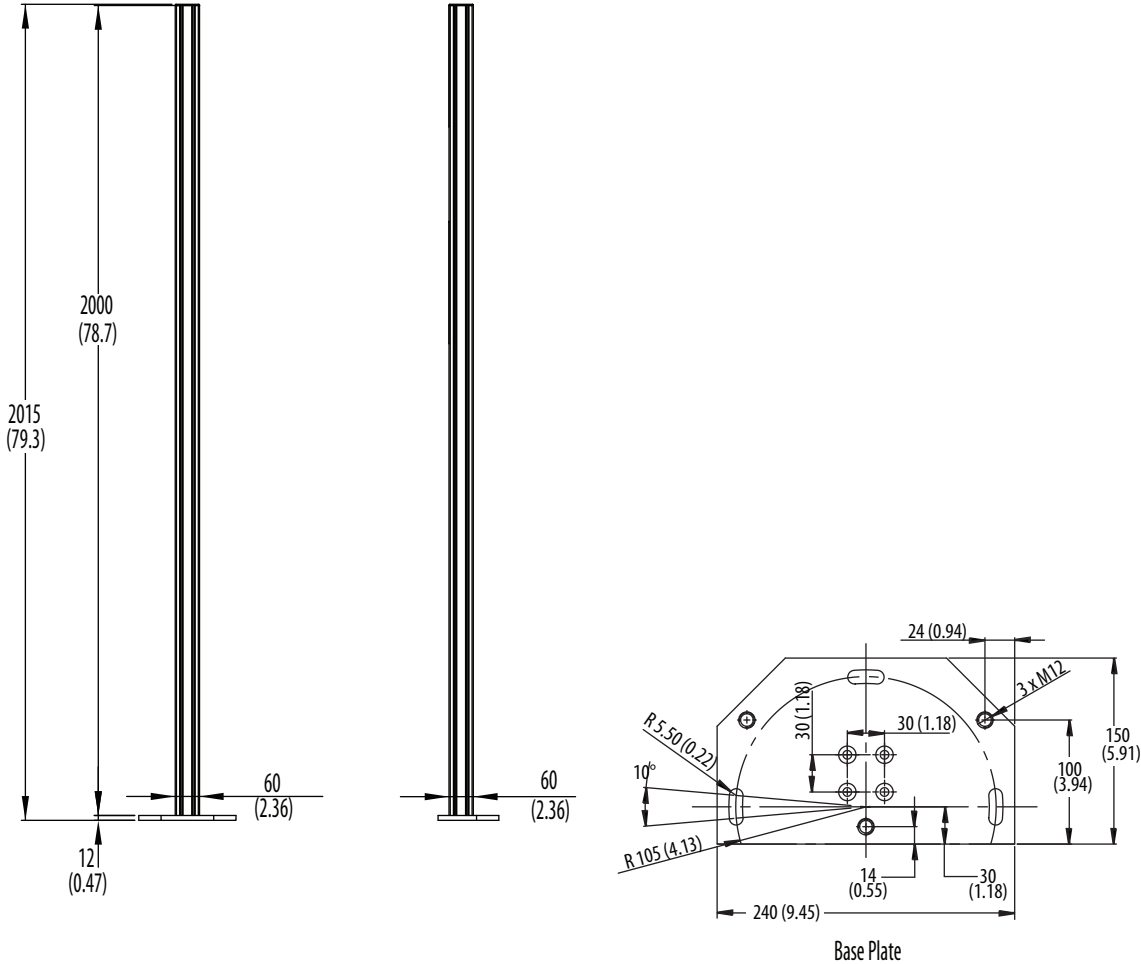

Figure 183 - 440L-AMSTD2M



Alignment Tool and Bracket

Optional laser-alignment tool (laser class 2) and alignment tool bracket.

Figure 184 - Laser Alignment Tool (Catalog Number 440L-ALAT)

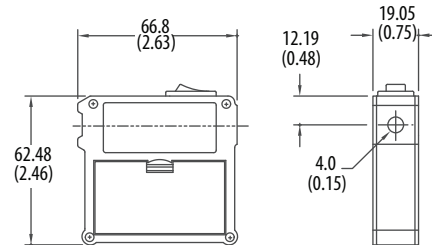

Figure 185 - Alignment Tool Bracket (Catalog Number 450L-ALAT-C)



Weld Shields

Figure 186 - Weld Shield Dimensions

Highly polished transparent surface on both sides

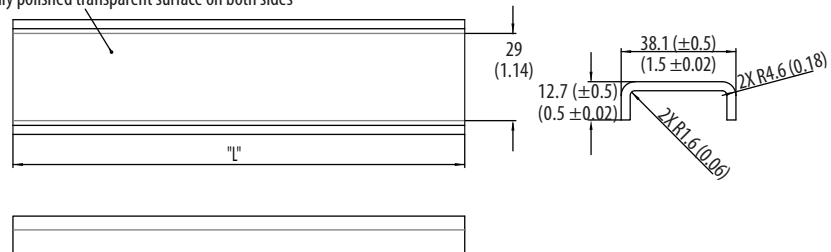

The GuardShield™ safety light curtain weld shields are sold in the same lengths as the protective field heights of the GuardShield safety light curtains. These polycarbonate weld shields are designed as disposable devices whose purpose is to help protect the front window of the GuardShield safety light curtain from damage.

One weld shield reduces the operation range by approximately 10%. For a 450L with finger resolution with a weld shield that is installed on each stick, the maximum range of operation reduces to: 7.0 m (22.97 ft) x 90% x 90% = 5.67 m (18.61 ft). The installation of the weld shields does not affect the minimum operation range.

Table 80 - Weld Shield Kits

Description	Cat. No.
Weld Shield Kit, two pieces per kit Safety Light Curtain, Length xxxx mm [xxxx: 0150...1950 mm (5.9...76.77 in.) in 0150 mm (5.9 in.) increments]	450L-AW-xxxx

The weld shield is supplied with precut Velcro® tape strips. Position the strips on the front window and attach the weld shields. Additional information about the weld shields is provided in the publication [450L-IN001](#)).

Cables

Depending on the plug-in, an M12 5-pin or a M12 eight-pin connection cable is required to connect a transceiver stick.

Connection cables (also commonly referred to as cordsets) have an M12 plug (female) at one end and the other end is free wires.

Extension cables (also commonly referred to as patchcords or interconnection cables) have one M12 plug at each end. They can be used to extend the length of the connection cables or can be used to extend the cascading distance ([Figure 12 on page 21](#)). Only the M12 5-pin patchcords can be used to connect a safety light curtain directly to a GuardShield safety light curtain ArmorBlock® module.

[Table 81 on page 203](#) lists cables that are required for connecting a light curtain stick (cable color black). Check ab.rockwellautomation.com/Connection-Devices/DC-Micro-Cordsets-and-Patchcords for additional lengths and/or cable jacket colors.

Table 81 - Connection Cables (Cordsets and Patchcords); Unshielded; Color: Black

Description	Cat. No.	
	Female M12 5-pin ⁽¹⁾	Female M12 8-pin ⁽¹⁾
No connector (cordset)	889D-F5BC-x	889D-F8AB-x
Male M12 connector (patchcord)	889D-F5BCDM-x	889D-F8ABDM-x ⁽²⁾

(1) Replace the x with 2 (2 m (6.6 ft)), 5 (5 m (16.4 ft)), 10 (10 m (32.8 ft)), 15 (15 m (49.2 ft)), 20 (20 m (65.6 ft)), or 30 (30 m (98.4 ft)) for desired length.

(2) Use this cable to extend the cable length between cascades.

IMPORTANT For environments with high EMC (electromagnetic disturbances) influences, shielded cables are highly recommended.

Figure 187 - Patchcord Cable

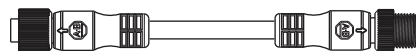
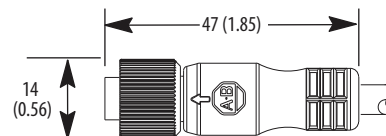

Figure 188 - M12 5-pin Plug Dimensions [mm (in.)]



Notes:

Typical Installations

Safety Light Curtain Mounted Vertically

Figure 189 - Point of Operation Control (POC) and Access Control (AC)

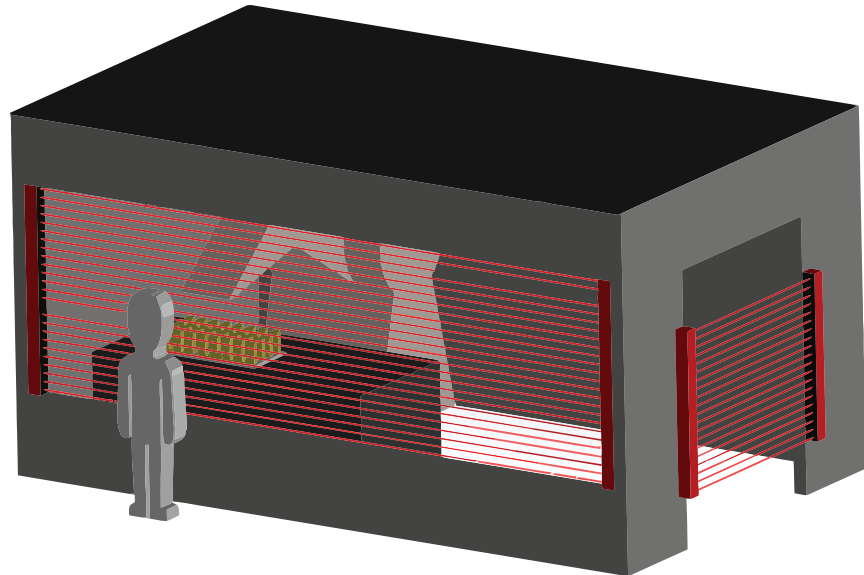

Safety Light Curtain Mounted Horizontally

Figure 190 - Hazardous Zone Safe Guard (Area Protection)

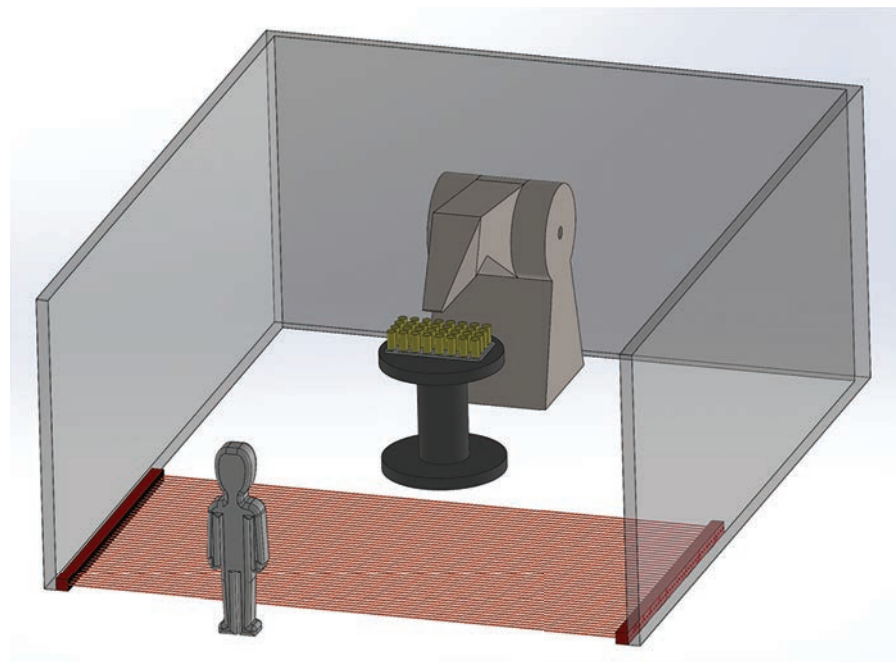

Fixed Blanking Application

This application can include a sheet of metal that passes through the light curtain before an operation is performed to form the material. The light curtain permits the material at a specific width without causing the safety outputs to turn off. Certain applications cannot be protected in any other way. If, for example, normal operation of a machine requires that material is permanently fed into the dangerous part of a machine, then a portion of the protective field is always interrupted, but the machine nevertheless continues to operate. The protection with blanking must come from a detailed risk analysis. Authorized personnel must confirm that in spite of blanking, the safety of the machine operator is adequately accounted for. When necessary, additional protective measures must be taken to shield the dangerous area. All Blanking modes can create “holes” in the protective field. These “holes” must be considered separately in the risk analysis.

Figure 191 - Schematic Application for Fixed Teach-in Blanking

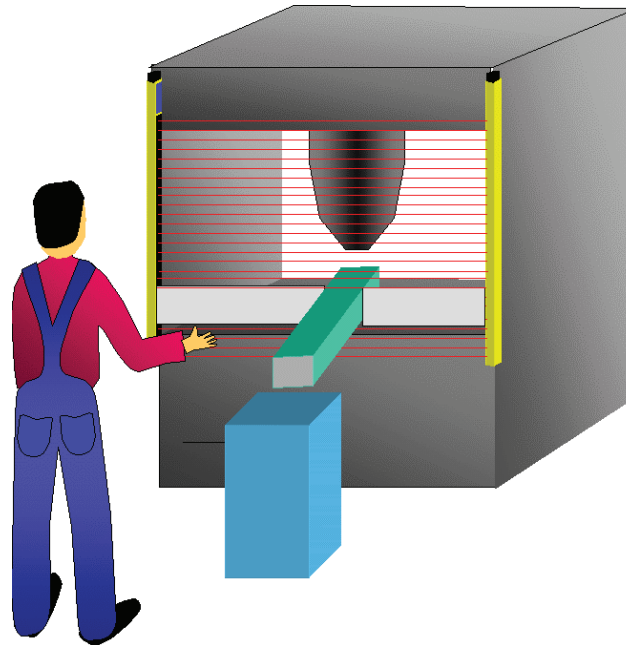

A typical example of fixed Teach-in blanking is also the exit ramp on an automatic punch press. The punched part is transported out of the dangerous zone into a container. The ramp passes through the protective field, and without Blanking would cause the machine to stop. The position of this ramp is monitored. During a tool change, the position of this ramp may vary slightly. This new position must be reconfigured in order for the application to run smoothly. It is possible this new position needs reconfiguration in order for the application to run smoothly.

Cascading Application

Figure 192 - Example for a Setup with Two Cascaded Segments (L-shape Setup)

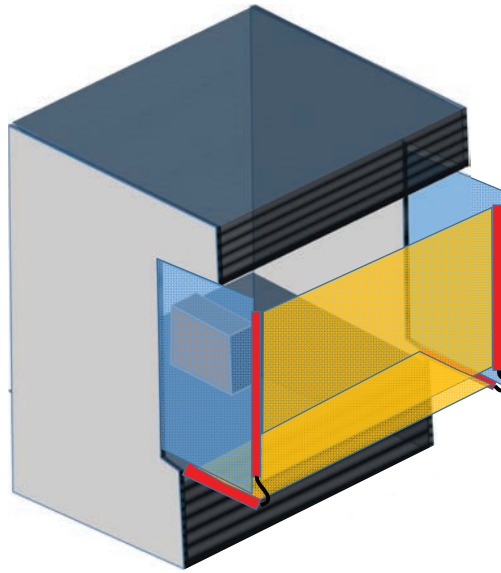

Notes:

Numerics

- 1732 ArmorBlock**
 - wiring diagram 106
- 450L-APR-BL-5**
 - connection plug-in 62
- 450L-APR-ED-8**
 - connection plug-in 61
- 450L-APR-MU-8**
 - connection plug-in 62
- 450L-APR-ON-5**
 - connection plug-in 61
- 450L-APR-UN-8**
 - connection plug-in 64

A

- abbreviation** 10
- accessories**
 - optional 197
- active lenses** 23
- advanced feature**
 - response time 54
- alignment**
 - laser 24
 - tool and bracket 202
- ANSI safety distance formula** 70
- application**
 - cascading 207
 - fixed blanking 206
- approximate dimension** 193
- ArmorBlock**
 - wiring diagram 106
- assembly overview** 13
- automatic (re) start** 27

B

- beam coding** 30
- beam status** 146
- blanking** 52
 - fixed 161
 - floating 170
 - overview 158
 - reduced resolution 30, 173
 - resolution 37
 - teach-in fixed 31
 - teach-in procedure 33
- blanking zones**
 - teach 163
- bracket**
 - alignment 202
 - mounting 82
 - side mounting 84
- button**
 - restart 100

C

- cable** 203
- cable connection**
 - cascading 97
 - receiver 96
 - transmitter 94
- cascading** 48, 52, 93
 - application 207
 - cable connection 97
 - response time 56
- cascading plug-in** 190
- certification** 193
 - safety 18
- change**
 - hardware 179
- characteristic**
 - operating 189
- clean**
 - optic front window 126
- coding**
 - beam 30
- column**
 - mounting 200
- compatibility**
 - limitation 13
- compliance**
 - European Union directive 193
- concept**
 - safety 17
- configuration**
 - download/upload 175
 - system 59
- configuration option** 161
- confirmation** 64, 65
 - new system configuration 64
- Connected Component Workbench**
 - troubleshoot 121
- Connected Components Workbench**
 - overview 129
 - response time 57
- connection**
 - EDM 99
 - external device monitoring 99
- connection plug-in**
 - 450L-APR-BL-5 62
 - 450L-APR-ED-8 61
 - 450L-APR-MU-8 62
 - 450L-APR-ON-5 61
 - 450L-APR-UN-8 64
- contents**
 - package 14
- corner mirror** 198
- correct installation** 77
- correction** 119

D

default
 automatic (re) start 27

determine
 safety distance 68

device
 export (zip file) 184

diagnose window 144

dimension
 approximate 193

DIP switch setting
 receiver plug-in 60

DIP switch setup 136

direct to contactors
 wiring diagram 102

directive
 European Union compliance 193

disposal 126

distance
 reflective surface 73

download
 configuration 175

E

EDM 29
 connection 99

electrical
 protection 191

electrical installation 88

environmental 191

error 119

error display
 status indicator 116

error type 116

European safety distance formula 71

European Union directive
 compliance 193

export 144, 181
 device (zip file) 184
 project 181

external device monitoring 29
 connection 99

external error
 status indicator 118

external/system error 118

F

firmware
 revision 15
 update 186

fixed blanking 161
 application 206
 process details 164
 rules 163
 setting 161
 teach-in 31

floating blanking 170
 object height 171
 rules 171
 setting 170

formula
 ANSI safety distance 70
 European safety distance 71
 OSHA safety distance 69
 U.S. safety distance 68

four-sensor 46
 muting 46

four-sensor muting
 muting plug-in
 wiring diagram 110
 schematic example 152

function
 mute dependent override 40
 safety 27

functional safety data 17

G

general
 protection 191
 setting 138

general purpose input output 140

general setup 135

GPIO 140
 selection 151
 setting 151

GPIO selection 155

GPIO setting 155

grounding 98

GSR SI safety relay
 wiring diagram 103

GuardLink tap
 wiring diagram 105

H

hardware 153
 change 179

hardware setup 136

horizontally
 mount 205

I

identification
 lens 158

import 181
 project 183
 zip file 185

incorrect installation 78

inputs receiver
 plug-in 190

inspection
 regular 123

install 75

installation 67
 correct 77
 electrical 88
 incorrect 78
 plug-in 89
 requirement 19
 typical 205

instruction
 safety 123

interruption time
 short 56

K

kit
 replacement mounting 86
 shock mounting 86
 standard top/bottom mounting 82

L

label
 plug-in 127
 product 58
 stick 126

lamp
 muting 39

laser 146

laser alignment 24

layout
 workbench 134

lens identification 158

lenses
 active 23

limitation
 compatibility 13

lock 145

lockout 119

low operating range 29

L-type muting 43, 44

M

maintenance 123

manual 28

manual (re) start 28
 off function 28

manual cold start 28

MDO 40

mirror 74
 corner 198

misuse
 possible 20

mode 145
 start 27

monitoring
 external device 29

mount 75
 horizontally 205
 multiple GuardShield safety light curtain 79
 vertically 205

mounting
 replacement kit 86
 shock 86

mounting bracket 82
 side 84

mounting column 200

multiple GuardShield safety light curtain
 mount 79

multiple scan 56

multiple subconfigurations 129

mute dependent override 40

muting 38, 46
 four-sensor schematic example 152
 lamp 39
 sensor 39
 setting 149
 two-sensor
 L-type 43
 L-type with enable 44
 T-type 41
 two-sensor schematic example 148

muting setting 153

muting type 149, 153

N

new project
 start 130

new system configuration 64

normal operation
 status indicator 115

O

object height
 floating blanking 171
 reduced resolution blanking 174

object number limited
 reduced resolution 35

off function
 manual (re) start 28

OID 120

operating characteristic 189

operating range
 low 29

operation 21

optic front window
 clean 126

optical interface device 120

optical push button 116

option
 configuration 161

optional accessories 197

OSHA safety distance formula 69

- OSSD** 191
 - output 100
 - restart time 101
 - signal processing 100
 - output**
 - OSSD 100
 - status 191
 - overview**
 - assembly 13
 - blanking 158
 - Connected Components Workbench 129
 - product 11
- P**
- package contents** 14
 - plug-in** 14, 88
 - cascading 190
 - inputs receiver 190
 - installation 89
 - label 127
 - receiver 91, 191
 - DIP switch setting 60
 - selection 196
 - transmitter 90
 - universal 190
 - possible misuse** 20
 - power supply** 98
 - procedure**
 - teach-in blanking 33
 - product label** 58
 - product overview** 11
 - product selection** 195
 - project**
 - export 181
 - import 183
 - share 181
 - start new 130
 - project organizer** 135
 - protection**
 - electrical 191
 - general 191
 - push button**
 - optical 116
- R**
- rating**
 - safety 189
 - receiver**
 - cable connection 96
 - plug-in 91, 191
 - receiver plug-in**
 - DIP switch setting 60
 - reduced resolution**
 - object number limited 35
 - reduced resolution blanking** 173
 - object height 174
 - rules 174
 - setting 173
 - reflective surface**
 - minimum distance 73
 - regular inspection** 123
 - replacement mounting kit** 86
 - requirement**
 - installation 19
 - reset** 144
 - resolution**
 - blanking 37
 - reduced 30
 - object number limited 35
 - response time** 52
 - advanced feature 54
 - cascading 56
 - Connected Components Workbench 57
 - standard 52
 - restart** 28
 - automatic 27
 - manual
 - off function 28
 - restart button** 100
 - restart time**
 - OSSD 101
 - revision**
 - firmware 15
 - rules**
 - fixed blanking 163
 - floating blanking 171
 - reduced resolution blanking 174
- S**
- safety**
 - certification 18
 - concept 17
 - function 27
 - instruction 123
 - rating 189
 - standard 17
 - safety distance**
 - determine 68
 - safety distance formula**
 - ANSI 70
 - European 71
 - OSHA 69
 - U.S. 68
 - safety output** 191
 - scan**
 - multiple 56
 - selection**
 - alignment tool and bracket 202
 - cable 203
 - corner mirror 198
 - mounting column 200
 - optional accessories 197
 - weld shield 202
 - sensor**
 - muting 39
 - setting**
 - fixed blanking 161
 - floating blanking 170
 - reduced resolution blanking 173

- setup**
 - DIP switch 136
 - general 135
 - hardware 136
 - share**
 - project 181
 - shield**
 - weld 202
 - shock mounting kit** 86
 - short interruption time** 56
 - SI safety relay**
 - wiring diagram 103
 - side mounting bracket** 84
 - signal processing**
 - OSSD 100
 - specification** 189
 - standard**
 - response time 52
 - safety 17
 - standard top/bottom mounting kit** 82
 - start** 28
 - automatic 27
 - manual
 - off function 28
 - manual cold 28
 - new project 130
 - start mode** 27
 - status**
 - beam 146
 - USB 137
 - status indicator** 113, 118
 - error display 116
 - normal operation 115
 - status output** 191
 - stick**
 - label 126
 - selection 195
 - Sub-configuration** 137
 - subconfiguration**
 - multiple 129
 - system configuration** 59
 - system error**
 - status indicator 118
- T**
- t-connector**
 - wiring diagram 104
 - teach** 146
 - blanking zones 163
 - teach-in**
 - fixed blanking 31
 - teach-in blanking**
 - procedure 33
 - terminology** 10
 - test pulse** 101
 - time**
 - response 52
 - short interruption 56
- tool**
 - alignment 202
 - top/bottom mounting kit** 82
 - transmitter**
 - cable connection 94
 - plug-in 90
 - troubleshoot** 116
 - Connected Component Workbench 121
 - T-type muting** 41
 - two-sensor** 41, 43
 - L-type muting 43
 - L-type muting with enable 44
 - T-type muting 41
 - two-sensor muting**
 - muting plug-in
 - wiring diagram 109
 - schematic example 148
 - two-sensor with enable** 44
 - type**
 - error 116
 - typical installation** 205
 - typical wiring diagram** 102
- U**
- U.S. safety distance formula** 68
 - universal plug-in** 190
 - update firmware** 186
 - upload**
 - configuration 175
 - USB status** 137
- V**
- vertically mount** 205
- W**
- weld shield** 202
 - window**
 - diagnose 144
 - wiring** 67
 - wiring diagram**
 - 1732 ArmorBlock connection 106
 - direct to contactors 102
 - four-sensor muting with muting plug-in 110
 - GSR SI safety relay 103
 - GuardLink tap connection 105
 - t-connector 104
 - two-sensor muting with muting plug-in 109
 - typical 102
 - workbench layout** 134
- Z**
- zip file**
 - export 184
 - import 185
 - zones** 159

Notes:

Rockwell Automation Support

Use the following resources to access support information.

Technical Support Center	Find help with how-to videos, FAQs, chat, user forums, and product notification updates.	rok.auto/support
Knowledgebase	Access Knowledgebase articles.	rok.auto/knowledgebase
Local Technical Support Phone Numbers	Locate the telephone number for your country.	rok.auto/phonesupport
Literature Library	Find installation instructions, manuals, brochures, and technical data publications.	rok.auto/literature
Product Compatibility and Download Center (PCDC)	Get help determining how products interact, check features and capabilities, and find associated firmware.	rok.auto/pcdc

Documentation Feedback

Your comments help us serve your documentation needs better. If you have any suggestions on how to improve our content, complete the form at rok.auto/docfeedback.

Waste Electrical and Electronic Equipment (WEEE)



At the end of life, this equipment should be collected separately from any unsorted municipal waste.

Rockwell Automation maintains current product environmental information on its website at rok.auto/pec.

Allen-Bradley, ArmorBlock, Connected Components Workbench, ControlFLASH, GuardLink, Guardmaster, GuardShield, Guard I/O, Rockwell Automation, Rockwell Software, and RSLinx are trademarks of Rockwell Automation, Inc.

CIP Safety, DeviceNet, and EtherNet/IP are trademarks of ODVA, Inc.

Windows is a trademark of Microsoft Corporation.

Trademarks not belonging to Rockwell Automation are property of their respective companies.

Rockwell Otomasyon Ticaret A.Ş., Kar Plaza İş Merkezi E Blok Kat:6 34752 İçerenköy, İstanbul, Tel: +90 (216) 5698400

www.rockwellautomation.com

Power, Control and Information Solutions Headquarters

Americas: Rockwell Automation, 1201 South Second Street, Milwaukee, WI 53204-2496 USA, Tel: (1) 414.382.2000, Fax: (1) 414.382.4444

Europe/Middle East/Africa: Rockwell Automation NV, Pegasus Park, De Kleetlaan 12a, 1831 Diegem, Belgium, Tel: (32) 2 663 0600, Fax: (32) 2 663 0640

Asia Pacific: Rockwell Automation, Level 14, Core F, Cyberport 3, 100 Cyberport Road, Hong Kong, Tel: (852) 2887 4788, Fax: (852) 2508 1846

Publication 450L-UM001E-EN-P - April 2020

Supersedes Publication 450L-UM001D-EN-P - December 2019

Copyright © 2020 Rockwell Automation, Inc. All rights reserved. Printed in the U.S.A.