

# GuardShield Safety Light Curtain

Catalog Numbers 450L-B4FNxYD, 450L-B4HNxYD, 450L-E4FLxYD, 450L-E4HLxYD

**Figure 1 - Package Content (Stick, Mounting Kit, and Test Rod)**

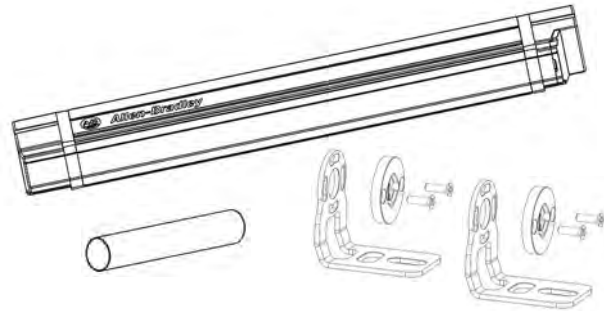

**Figure 5 - Tighten Screws (0.38 N·m [3.36 lb·in], Max)**

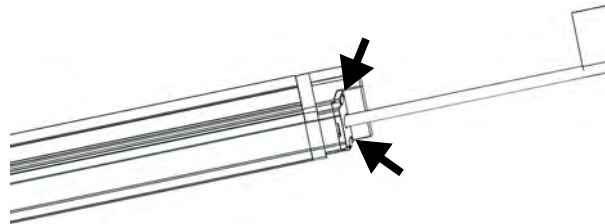

## Installation



**ATTENTION:** This package content is intended for replacement cases. For new product installation, see publication [450L-UM001](#).

**Figure 6 - Install Mounting Kit (0.7 N·m [6.19 lb·in], Max)**

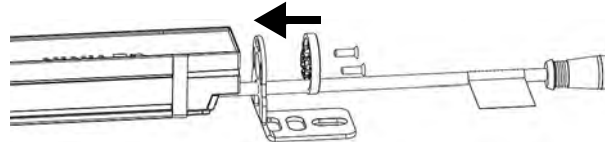

**Figure 7 - Positioning of Transmitter and Receiver Sticks**

Make sure that both connection plug-ins are at the same end of the installation.

**Figure 2 - Remove Red Slot Cover**



**Figure 3 - Check DIP Switches on Connection Plug-in**

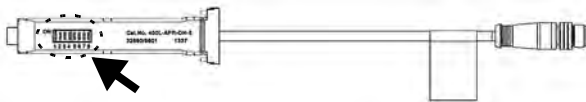

**Figure 4 - Insert Plug-in**

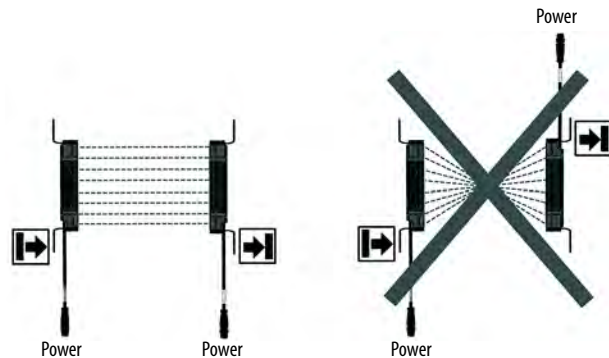
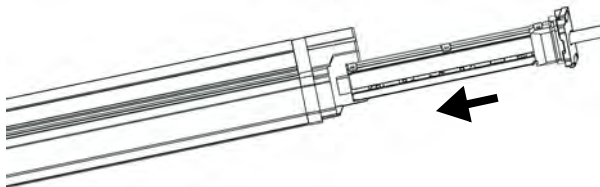

**Figure 8 - Install, Connect, Power Up, and Align Complete System**



If a 450L-E safety light curtain is used and operated with a cascading plug-in, remove the gray slot cover insert and mount the cascading plug-in similar to the connection plug-in.

The 450L-E sticks have an integrated laser alignment system. This system can be switched on/off by placing the finger on the optical switch, which is the square next to the hand symbol on the front window.

**Figure 9 - Use the Integrated Laser Alignment System for Positioning**

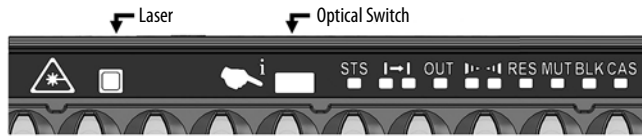

**WARNING:** Do not stare into the beam. Laser Class 2. Conforms to 21 CFR 1040.10.

For 450L-B sticks an optional laser alignment tool (Catalog Number 440L-ALAT) and clamp (Catalog Number 450L-ALAT-C) are available.

**Figure 10 - Test Resolution with Test Rod**

Verify that while the test rod is anywhere within the protective field, the OSSD safety outputs remain in the OFF-state. Move the test rod as indicated in Figure 8 with a maximum speed of 0.3 ms (11.8 in./s). Be sure that the intensity indicator indicates a continuous protective field interruption (minimum one intensity indicator is OFF).

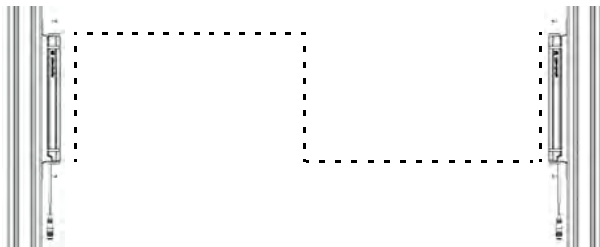

**Table 1 - Status Indicators on a 450L-B GuardShield Light Curtain (Colors and Functions) for Normal Operation**

OUT	Safety Outputs	Green	On	Safety outputs are on (receiver)
		Red	On	Safety outputs are off (receiver)
			Off	Transmitter
	Regional light intensity level 1	Green	On	Bottom half zone is not interrupted and intensity is OK
			Blinking 1 Hz (50:50)	Bottom half zone intensity is at the limit
			Off	Bottom half zone interrupted
	Regional light intensity level 2	Green	On	Top half zone is not interrupted and intensity is OK
			Blinking 1 Hz (50:50)	Top half zone intensity is at the limit
			Off	Top half zone interrupted
RES	Start	Amber	On	Start required (receiver)
			Off	No start is required (receiver)

**Table 2 - Additional Status Indicators on a 450L-E GuardShield Light Curtain (Colors and Functions) for Normal Operation**

Marking	Status Indicator	Color	Behavior	Description
MUT	Muting	Orange	Off	Light curtain not muted
			On	Light curtain muted
			Blinking	Muting error
BLK	Blanking	Orange	Off	No blanking feature selected
			On	Blanking feature selected
			Blinking	Blanking error
CAS	Cascading	Red	Off	No cascading plug-in inserted or Tx or OSSDs of connected cascade are in ON-state (Rx only)
			On	OSSDs of connected cascade are in OFF-state (Rx only)
			Blinking	Plug-in cascade error

**Table 1 - Status Indicators on a 450L-B GuardShield Light Curtain (Colors and Functions) for Normal Operation**

Marking	Status Indicator Name	Color	Behavior	Description	
STS	Status indicator	Green	On	Power on and system is OK	
		Green	Red	Blinking	Configuration that is changed or receiver was operated previously with another transmitter. See user manual section "Confirmation of a New Configuration"
		Green	Off	Blinking	See user manual section "Troubleshooting," in publication <a href="#">450L-UM001</a>
		Off	Red	Blinking	
		Off	Red	On	
	Transmitter	Green	On	Plug-in identifies stick as a transmitter	
			Blinking 1 Hz (50:50)	See user manual section "Troubleshooting," in publication <a href="#">450L-UM001</a>	
			Blinking 1 Hz (98:2)	Reduced range is activated	
			Off	Stick is receiver	
	Receiver	Green	On	Plug-in identifies the stick as a receiver	
			Blinking 1 Hz (98:2)	Reduced range is activated	
			Off	Stick is transmitter	



**WARNING:** A 450L GuardShield safety light curtain system is intended to be part of the safety-related control system of a machine. Before installation, a thorough risk assessment has to be performed to determine whether the specifications of this device are suitable for all foreseeable operational and environmental characteristics of the application.

The following applications and/or environmental conditions can lead to misuse and potentially cause severe injuries or death (for more information see IEC 62046):

- Machines, which eject materials, swarf, or component parts
- Risk of injury from thermal or other radiation
- Unacceptable noise levels
- Transparent objects are detected
- An environment, which exceeds the specification, limits provided in publication [450L-UM001](#).

Some but not all possible limits are electrostatic discharge, radio frequency interference, vibration/shock, ambient light, pollution, temperature, humidity.

Without additional measures (IEC 62998), GuardShield™ 450L-B safety light curtains are not designed to be used for the following applications:

- Outdoors
- Under water
- Explosive atmospheres
- Altitudes over 3000 m (1.86 miles) above sea level
- With enhanced ionizing or radar radiation

The protective system must be tested for proper operation after each change to the configuration. The 450L GuardShield light curtain cannot be used with machines that cannot be stopped electrically in an emergency. Always maintain the required safety distance (see publication [450L-UM001](#)) between the 450L GuardShield light curtain and a dangerous machine movement. Additional mechanical protective devices have to be installed if hazardous machine elements can be reached without passing through the protective field. Improper installation can result in serious injury or death. Never connect the safety outputs (OSSDs) to +24V DC. The Auxiliary output is only a status output for diagnosis purposes to connect, for example, an indicator lamp. Do not connect this output to fulfill safety functions. If the safety outputs are connected to +24V DC, they are in the ON-state and cannot stop hazardous machine/application movements. Do not open or attempt to repair or modify the 450L GuardShield. Removal of either of the gray GuardShield end caps or the transparent front window voids the warranty terms of this product. Do not insert or remove plug-ins when power is applied to the plug-in. Make sure that the power supply is protected against overload (fuse with 3 A in the 24V DC circuit). Installation must be in accordance with the publication [450L-UM001](#) and implemented by qualified personnel exclusively.

When screws are overtightened, damage occurs to the light curtain. To avoid pollution or contamination, the installation of a plug-in into a stick must be implemented in a dry and clean area. Make sure that the rubber seal at the plug-in does not get out of place when the plug-in is inserted in the light curtain.

**Table 3 - DIP Switch Functionality**

450L-APR-ON-5:	DIP 1...4	450L-APR-BL-8:	DIP 1...8
450L-APR-EDM-8:	DIP 1...8	450L-APR-MU-8:	DIP 1...12
450L-APU-UN-8:	DIP 1...12		

Switch Number	Switch Function	Default	Description
1	—	OFF	—
2	Low range activation	OFF	OFF: Disabled ON: Enabled
3	Beam coding (450L-E only)	OFF	OFF: Disabled ON: Enabled
4	—	OFF	—
5	Combination activation of the following start modes: Automatic start Manual (re) start Manual cold start Manual start with off function	OFF	DIP 5: OFF, DIP 6 OFF: Automatic start (Default) DIP 5: ON, DIP 6 OFF: Manual (re) start DIP 5: OFF, DIP 6 ON: Manual cold start DIP 5: ON, DIP 6 ON: Manual start with off function
6		OFF	Manual cold start DIP 5: ON, DIP 6 ON: Manual start with off function
7	External Device Monitor	OFF	OFF: Disabled ON: Enabled
8		OFF	—
9	Muting or Blanking (450L-E only)	OFF	For details, see publication <a href="#">450L-UM001</a>
10		OFF	
11		OFF	
12	—	OFF	—

## CE Marking and EC Conformity

The present product complies with the requirements of the current European and national directives: 2006/42/EC (Machinery); 2014/30/EU (EMC); 2011/65/EU (ROHS) Conformity has been verified. The corresponding declaration can be downloaded at [www.ab.com](http://www.ab.com). Rockwell Automation B.V.; Rivium Promenade 160; 2909 LM Capelle aan den IJssel; The Netherlands.

**Table 4 - Pin Assignment Connection Plug-in (Tx=Transmitter, Rx=Receiver)**

For cascading plug-in (Catalog Number 450L-APC-IO-8, see publication 450L-UM001).

Stick Behavior	Tx	Rx	Tx	Rx	Tx	Rx
<b>Plug-in Catalog Number</b>	<b>450L-APT-PW-5</b>	<b>450L-APR-ON-5 450L-APR-BL-5</b>	<b>450L-APT-PW-8</b>	<b>450L-APR-ED-8<sup>(1)</sup> 450L-APR-MU-8<sup>(3)</sup></b>	<b>450L-APU-UN-8</b>	
Pin 1	+24V DC	+24V DC	Do not connect	Auxiliary output (OSSD emulation) <sup>(1)</sup>	Do not connect	Auxiliary output (OSSD emulation)
2	Do not connect	OSSD1	+24V DC	+24V DC	+24V DC	+24V DC
3	0V (Ground)	0V (GND)	Earth PE	Earth PE	Earth PE	Earth PE
4	Do not connect	OSSD2	Do not connect	EDM (Input) <sup>1</sup>	<sup>(2)</sup>	EDM input <sup>(3)</sup>
5	Earth PE	Earth PE	Do not connect	OSSD1	Do not connect	OSSD1
6	—	—	Auxiliary output (Lockout)	OSSD2	Auxiliary output (Lockout)	OSSD2
7	—	—	0V (GND)	0V (GND)	0V (GND)	0V (GND)
8	—	—	Do not connect	Start <sup>1</sup>	<sup>(2)</sup>	Start <sup>1</sup>

- (1) If set with DIP Switches.
- (2) Pin 4 connected to pin 8 (short circuited).
- (3) For muting applications, see publication 450L-UM001.

## Additional Resources

Resource	Description/Publication Number
GuardShield Safety Light Curtain User Manual, publication 450L-UM001	Provides product-specific guidelines for installing the Rockwell Automation® 450L-B and 450L-E safety light curtain system.
Product Certifications website, <a href="http://www.rockwellautomation.com/global/certification/overview.page">http://www.rockwellautomation.com/global/certification/overview.page</a>	Provides declarations of conformity, certificates, and other certification details.

You can view or download publications at <http://www.rockwellautomation.com/literature/>. To order paper copies of technical documentation, contact your local Allen-Bradley distributor or Rockwell Automation® sales representative.

## Rockwell Automation Support

For technical support, visit <http://www.rockwellautomation.com/support/overview.page>.

## Waste Electrical and Electronic Equipment (WEEE)



At the end of life, this equipment can be collected separately from any unsorted municipal waste.

Rockwell Automation maintains current product environmental information on its website at <http://www.rockwellautomation.com/rockwellautomation/about-us/sustainability-ethics/product-environmental-compliance.page>.

Allen-Bradley, GuardShield, Rockwell Automation, and Rockwell Software are trademarks of Rockwell Automation, Inc. Trademarks not belonging to Rockwell Automation are property of their respective companies.

Rockwell Otomasyon Ticaret A.Ş., Kar Plaza İş Merkezi E Blok Kat:6 34752 İçerenköy, İstanbul, Tel: +90 (216) 5698400

[www.rockwellautomation.com](http://www.rockwellautomation.com)

### Power, Control and Information Solutions Headquarters

Americas: Rockwell Automation, 1201 South Second Street, Milwaukee, WI 53204-2496 USA, Tel: (1) 414.382.2000, Fax: (1) 414.382.4444  
 Europe/Middle East/Africa: Rockwell Automation NV, Pegasus Park, De Kleetlaan 12a, 1831 Diegem, Belgium, Tel: (32) 2 663 0600, Fax: (32) 2 663 0640  
 Asia Pacific: Rockwell Automation, Level 14, Core F, Cyberport 3, 100 Cyberport Road, Hong Kong, Tel: (852) 2887 4788, Fax: (852) 2508 1846

Publication 450L-IN004A-EN-P - December 2017

Supersedes Publication 450L-PC001A-EN-P - April 2017

PN-306702

Copyright © 2017 Rockwell Automation, Inc. All rights reserved. Printed in the U.S.A.