

# 42EF RightSight™ Photoelectric Sensors with IO-Link Interface

42EF-D2\*, 42EF-P2-\*



 **IO-Link** 

## Important User Information

Read this document and the documents listed in the additional resources section about installation, configuration, and operation of this equipment before you install, configure, operate, or maintain this product. Users are required to familiarize themselves with installation and wiring instructions in addition to requirements of all applicable codes, laws, and standards.

Activities including installation, adjustments, putting into service, use, assembly, disassembly, and maintenance are required to be carried out by suitably trained personnel in accordance with applicable code of practice.

If this equipment is used in a manner not specified by the manufacturer, the protection provided by the equipment may be impaired.

In no event will Rockwell Automation, Inc. be responsible or liable for indirect or consequential damages resulting from the use or application of this equipment.

The examples and diagrams in this manual are included solely for illustrative purposes. Because of the many variables and requirements associated with any particular installation, Rockwell Automation, Inc. cannot assume responsibility or liability for actual use based on the examples and diagrams.

No patent liability is assumed by Rockwell Automation, Inc. with respect to use of information, circuits, equipment, or software described in this manual.

Reproduction of the contents of this manual, in whole or in part, without written permission of Rockwell Automation, Inc., is prohibited.

Throughout this manual, when necessary, we use notes to make you aware of safety considerations.



**WARNING:** Identifies information about practices or circumstances that can cause an explosion in a hazardous environment, which may lead to personal injury or death, property damage, or economic loss.



**ATTENTION:** Identifies information about practices or circumstances that can lead to personal injury or death, property damage, or economic loss. Attentions help you identify a hazard, avoid a hazard, and recognize the consequence.

---

### IMPORTANT

Identifies information that is critical for successful application and understanding of the product.

---

Labels may also be on or inside the equipment to provide specific precautions.



**SHOCK HAZARD:** Labels may be on or inside the equipment, for example, a drive or motor, to alert people that dangerous voltage may be present.



**BURN HAZARD:** Labels may be on or inside the equipment, for example, a drive or motor, to alert people that surfaces may reach dangerous temperatures.



**ARC FLASH HAZARD:** Labels may be on or inside the equipment, for example, a motor control center, to alert people to potential Arc Flash. Arc Flash will cause severe injury or death. Wear proper Personal Protective Equipment (PPE). Follow ALL Regulatory requirements for safe work practices and for Personal Protective Equipment (PPE).

---

<b>1. Product Overview</b>	<b>1</b>
Product Description	1
Operation Modes	1
Features	1
<b>2. Installation</b>	<b>3</b>
User Interface	3
Alignment Indication	3
Specifications	4
Mounting	5
Dimensions	5
Typical Response Curves	6
Wiring	6
<b>3. 42EF RightSight Sensor with IO-Link Overview</b>	<b>8</b>
What Is IO-Link?	8
Why IO-Link?	8
How Does IO-Link Work?	9
IO-Link Data Types	11
Accessing IO-Link Data	11
Start-up of the I/O System	12
Assign Device Parameters	12
Rockwell Automation Solution	12
Premier Integration	13
42EF IO-Link Features	14
<b>4. Setting up the 42EF for IO-Link Mode</b>	<b>17</b>
Example: Setting up the Hardware	18
<b>5. Creating a Project</b>	<b>20</b>
AOP Installation	22
<b>6. Configuring IO-Link Master</b>	<b>23</b>
<b>7. Registering the 42EF IODD</b>	<b>28</b>
<b>8. Connecting the 42EF to the IO-Link Master</b>	<b>32</b>
<b>9. Exploring the 42EF IO-Link Parameters</b>	<b>34</b>
Overview	34
IO-Link Configuration	35
Manage Parameter Differences Between IO-Link Devices and Controllers	43
<b>10. Troubleshooting</b>	<b>48</b>
Checklist	48
<b>Appendix A — Installing the Add-on Profile</b>	<b>49</b>
Introduction	49
Performing the Installation	49
<b>Appendix B — Device Parameters</b>	<b>54</b>
Identification Tab	54
Observation Tab	55
Parameter Tab	56
Diagnosis Tab	58
Process Data	60
<b>Appendix C — Message Structure and Configuration Examples</b>	<b>61</b>
Configuring a Message Instruction	61
<b>Appendix D — Error Codes and Events</b>	<b>69</b>
Error Codes	69
Events	70

**Appendix E — Abbreviations.....71**

## Product Overview

### Product Description

The Allen-Bradley® 42EF RightSight™ with IO-Link features a new user interface boosting ultra-bright LEDs, in an 18 mm base and nose mount. Connecting the 42EF RightSight to IO-Link allows you to take advantage of advanced sensing functionality including real-time diagnostics, automatic device configuration (ADC) and access to multiple parameters.

### Operation Modes

The sensor can operate in two modes:

**Standard IO (SIO) Mode:** The sensor default-operation mode. The sensor outputs and user interface behave as described in the installation instructions included with the product. This mode of operation is active when the sensor is connected to digital input devices such as a PLC inputs modules, distribution boxes, and input terminal connections.

**IO-Link Mode:** This mode is automatically activated when the sensor is connected to an IO-Link enabled master device. Upon entering this mode, the green LED on the sensor starts blinking at a rate of one hertz to indicate that IO-Link communication has been successfully established with the master. The sensor transmits more parameter and diagnostic information that can be accessed via the PLC process data. No user intervention is required to enable this functionality within the sensor.

### Features

- New Look and User Interface. Two bright LEDs allow for 360° visible indication helps operators verify proper sensor operation.
- Visible red light source on Diffuse and Transmitted Beam models.
- Universal 18 mm base and nose mount for ease of assembly and added flexibility.
- Linear sensing range adjustment for models with sensitivity adjustment knob.
- Improved high frequency ballast immunity.
- Enhanced sensor diagnostics on DC Diffuse and Polarized Retroreflective when using IO-Link 1.1 point-to-point protocol helps customers minimize machine downtime and increase productivity.
- IP69K rated enclosure.
- IO-Link Features:

- Sensor Heartbeat™ feature helps ensure excellent reliability operation by indicating to the PLC if a sensor has lost connectivity due to sensor failure or faulty wiring.
- Margin Low Alarm minimizes downtime by indicating when the sensor is about to fail due to insufficient light being reflected.
- Signal Strength provides the raw measurement value of the amount of light reflected from the target.
- Margin Levels displays the excess gain above the sensor threshold to help reliably detect the target.
- Contrast Levels display the difference between the light signal levels that the sensor read the last time that the output was ON versus the last time the output was OFF. The IO-Link parameter contrast levels help identify enough difference between the target and the background.
- Margin Low and High Indication Multipliers allow for specific minimum margin levels when the local indication LED indicates marginal conditions and stable conditions.
- Location Indication helps locate the sensors in large machines where there are several units close to each other.
- Alignment Mode facilitates the alignment of the sensors in applications where a transmitted beam receiver or a polarized retroreflective sensor must be optimally aligned.
- Timers and Counters add additional sensor functionality by allowing the operator to count the number of times a target has been detected.
- Timers and Counters add additional sensor functionality by allowing the operator to count the number of times a target has been detected.
- Pin 2 Enable parameter allows continuous monitoring of the sensor while providing access to a discrete output. Pin 2 Enable is ideal for applications where high-speed sensor detection is critical to the application.
- Process Data Maps allow for selection of the type of information that is continuously sent to the PLC as a process data parameter.
- Temperature allows operators to visualize the internal temperature value and to increase or decrease depending on the influence of the ambient temperature on the internal sensor temperature.

## Installation

### User Interface

### LED Status

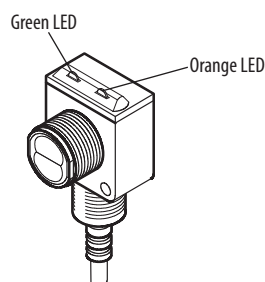

The Standard IO operation table provides LED status in the RUN mode during operation. The sensor is always in RUN mode, except when being taught.

### Standard IO Operation (Auto PNP/NPN) Operating Mode Indication

Green	OFF	Power is OFF
	ON	Power is ON
	Flashing (6 Hz)	Unstable light: $0.8 X < \text{margin} < 1.5 X$
	Flashing in (1.4 Hz)	Output short circuit protection active
Orange	OFF	Output de-energized
	ON	Output energized

### IO-Link Operation Mode Indication

Green	OFF	Power is OFF
	Flashing (1 Hz)	Power is ON
Orange	OFF	Output de-energized
	ON	Output energized

### Alignment Indication

The green LED can also serve as a set-up alignment aid, which indicates that a margin of 1.5, has been reached. The indication means that the sensor is receiving at least 1.5 times the signal strength back from the target that is required to trigger an output signal. In general, it is desirable to have a higher margin to help overcome any deteriorating environmental conditions, for example, dust build-up on the sensor lens. When aligning the sensor, the preferred performance can be obtained if this margin indicator is illuminated with the target in place. When

aligning diffuse mode sensors, be sure that the sensitivity is set at its maximum setting (use the single-turn adjustment knob on the front panel). Pan the sensor left, right, up, and down to center the beam on the target. It might then be necessary to decrease this setting to prevent the sensor from detecting a background object. If this problem persists, the application requires the use of a background suppression, sharp cutoff diffuse, or retroreflective sensing mode.

## Specifications

	42EF	42EF	42EF
Certifications	cULus Listed and CE Marked for all applicable directives		
Vibration	10...55 Hz, 1 mm amplitude, meets or exceeds IEC 60947-5-2		
Shock	30 G with 1 ms pulse duration, meets or exceeds IEC 60947-5-2		
Relative Humidity	5...95% (non condensing)		
Ambient Light Immunity	Incandescent light: 5000 lux Sunlight: 20,000 lux		
User Interface			
Indicator LEDs	Green LED (power and margin), Orange LED (output)		
Electrical			
Adjustments	Fixed or adjustment knob by cat. no.		
Voltage	10...30V DC, I-O link: 18...30V DC		
Current consumption	30 mA maximum		
Sensor Protection	False pulse, reverse polarity, overload, short circuit		
Outputs			
Response time	1 ms		
Output type	PNP and NPN	PNP OR NPN (based on cat. no.)	
Load Current	100 mA		
Leakage Current	PNP: 0.1 mA, NPN: 0.3 mA, maximum		
Mechanical			
Housing Material	Mindel™		
Lens Material	Acrylic		
Cover Material	Udel™		
Supplied Accessories	Supplied 18 mm mounting nut		
Environmental			
Enclosure Type Rating	NEMA 4X, 6P, IP67, IP69K; 1200 psi (8270 kPa) washdown		
Operating Temperature [C (F)]	-25...+70° (-13...+158°)		
Connection Type	2 m cable, 4-pin DC micro (M12) QD on 150 mm pigtail; 4-pin DC pico (M8) QD on 150 mm pigtail		



## Mounting

Securely mount the sensor on a firm, stable surface, or support. An application, which is subject to excessive vibration or shifting, can cause intermittent operation. For installation convenience, Rockwell Automation® offers a wide range of brackets for mounting (see the Accessories section for more details).

## Dimensions

The following illustration shows the relevant device dimensions [mm (in.)]:

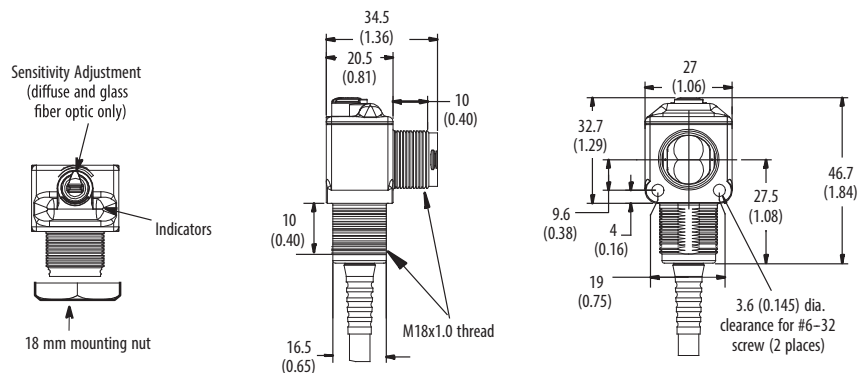

## Typical Response Curves

**Visible Red Polarized Retrorefle tive—  
3.0 m Margin Curve**

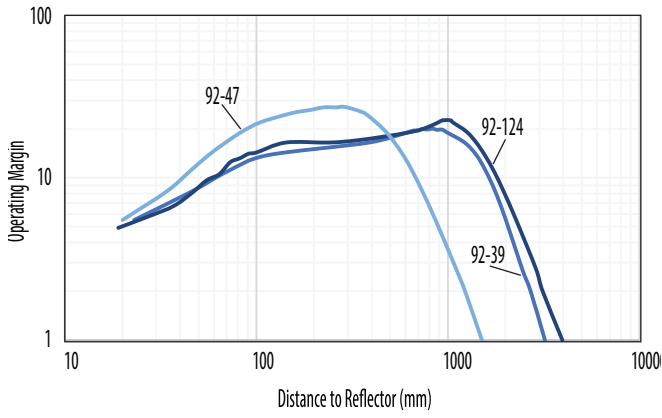

**Visible Red Diffus —  
500 mm Margin Curve**

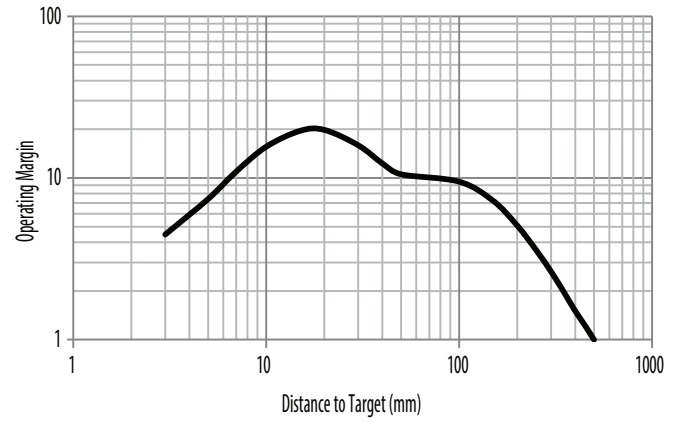

**Visible Red Polarized Retrorefle tive—  
3.0 m Beam Pattern**

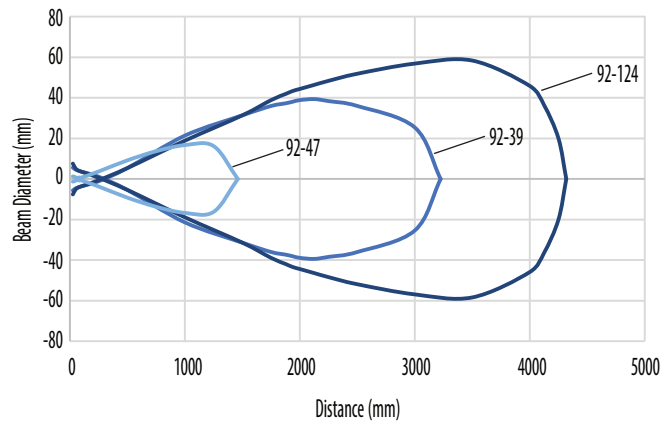

**Visible Red Diffus —  
500 mm Beam Pattern**

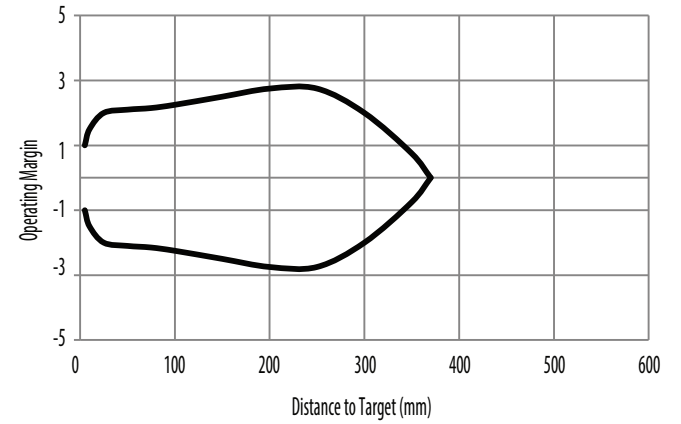

## Wiring

### Micro (M12) Male QD on Pigtail and Integral Pico (M8) Male QD

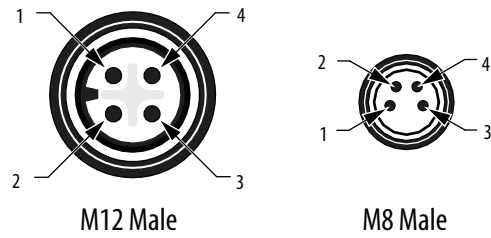

## Output Wiring

### Light Operate PNP and NPN Models (42EF-D2JBAK-1, 42EF-P2JBB-1)

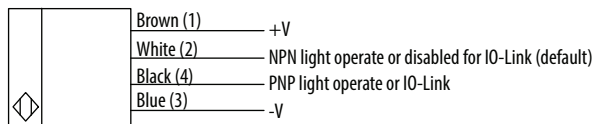

### Dark Operate PNP and NPN Models (42EF-D2KBAK-1, 42EF-P2KBB-1)

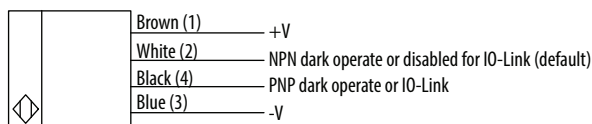

### PNP Complementary Models (42EF-D2MPAK-1, 42EF-P2MPB-1)

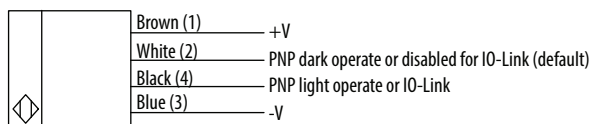

### NPN Complementary Models (42EF-D2MNAK-1, 42EF-P2MNB-1)

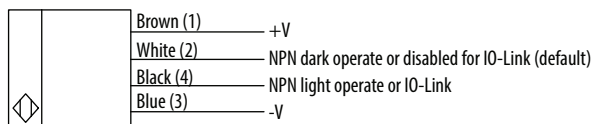

<sup>1</sup> See Connection Types table for cable lengths.

## 42EF RightSight Sensor with IO-Link Overview

### What Is IO-Link?

The IO-Link technology is an open point-to-point communication standard and was launched as (IS) IEC 61131-9. IO-Link is now the first globally standardized technology for sensor and actuator communication with a field bus system. This technology provides benefits to both OEMs and End Users.

IO-Link provides communications-capable sensors to the control level by a cost-effective point-to-point connection. IO-Link provides a point-to-point link between the I/O module and sensor that is used for transferring detailed diagnostics, device identity information, process data, and parameterization.

IO-Link communication is based on a master-slave structure in which the master controls the interface access to the sensor. The option of using the intelligence that is integrated into the sensor provides the user with new commissioning methods. Benefits range from reduced installation time during startup to increased diagnostics over the lifetime of the machine. Benefits of IO-Link technology include:

- Reduced inventory and operating costs
- Increased uptime/productivity
- Simplified design, installation, set up and maintenance
- Enhanced flexibility and scalability
- Detailed diagnostic information for preventative maintenance

### Why IO-Link?

IO-Link Offers a Full Range of Advanced Features and Functions

#### Seamless Integration

- Forward and backward compatible, sensor catalog numbers remain the same
- No special cables required
- Connectivity options remain the same
- Access IO-Link functionality by simply connecting an IO-Link enabled device to an IO-Link master
- Analog devices no longer require a dedicated input card

## Real-time Diagnostics and Trending

- Real-time monitoring of the entire machine down to the sensor level
- Optimized preventative maintenance—identify and correct issues before failures can occur
- Detect sensor malfunctions/failure

## Sensor Health Status

- Real-time monitoring helps ensure that sensors are operating correctly
- Detect damaged sensors and pinpoint their exact location for quick troubleshooting through Application Specific Name parameter

## Device Profiles and Automatic Device Configuration

- “Golden” device configurations are stored in the IO-Link master module
- Multiple configurations can be stored in controller to support changes in machine production, for example tool changes
- Within minutes instead of hours, modify sensor parameters to produce different finished goods

## Descriptive tags

- Faster programming during initial setup
- More efficient troubleshooting process—data tags are named based on the information they provide
- Easily monitor sensor data through intuitive tag names

## How Does IO-Link Work?

IO-Link delivers data over the same standard field cabling used today. By connecting an IO-Link sensor to an IO-Link master, the field-device data and diagnostics are accessible. So go beyond detecting products on the machine—now the health of the machine can be MONITORED as it runs.

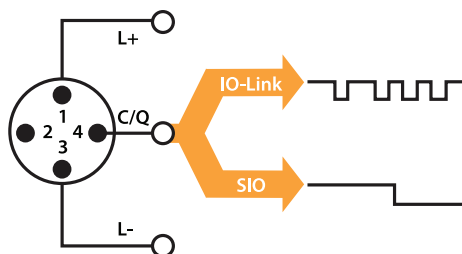

Pin	Signal	Remark
1	L+	24V
2	out	Depends on sensor
3	L-	Ground
4	C/Q	Communication/switching signal

---

**IMPORTANT** The response time of an IO-Link system might not be fast enough for high-speed applications. In this case, it is possible to monitor/configure the sensor through IO-Link on pin four of the sensors while connecting pin two (if the sensor offers a second output) of the sensor to a standard input card.

---

## Transmission Rates

Three communication rates are specified for the IO-Link device:

- COM 1 = 4.8 kbaud
- COM 2 = 38.4 kbaud
- COM 3 = 230.4 kbaud

An IO-Link device typically supports only one of the specified transmissions rates, while the IO-Link V1.1 specifications requires an IO-Link master to support all three communication rates (see Product Specifications for product communication rate.).

## Transmission Quality

The IO-Link communication system operates at a 24V level. If a transmission fails, the frame is repeated two more times. If the transmission fails on the second try, the IO-Link master recognizes a communication failure and signals it to the controller.

## Response Time of the I-O Link System

The device description file (IODD) of the device contains a value for the minimum cycle time of the device. This value indicates the time intervals at which the master addresses the device. The value has a large influence on the response time. In addition, the master has an internal processing time that is included in the calculation of the system response time.

Devices with different minimum cycle times can be configured on one master. The response time differs accordingly for these devices. When configuring the master, you can specify a fixed cycle time and the device-specific minimum cycle time stored in the IODD. The master then addresses the device that is based on this specification. The typical response time for a device therefore results from the effective cycle time of the device and the typical internal processing time of the master. (See Product Specifications for minimum product cycle time.)

## IO-Link Data Types

There are four data types available through IO-Link:

Process data	?	Cyclic data
Value status	?	Cyclic data
Device data	?	Acyclic data
Events	?	Acyclic data

### Process Data

The process data of the devices are transmitted cyclically in a data frame in which the size of the process data is specified by the device. Depending on the device, 0...32 bytes of process data are possible (for each input and output). The consistency width of the transmission is not fixed and is thus dependent on the master.

Some devices can support multiple process data “modes,” which allows for selection of different cyclic process data themes.

### Value Status

The value status indicates whether the process data is valid or invalid. The value status can be transmitted cyclically with the process data.

### Device Data

Device data supports device-specific configurable parameters, identification data, and diagnostic information. They are exchanged acyclically and at the request of the IO-Link master. Device data can be written to the device (Write) and also read from the device (Read).

### Events

When an event occurs, the device signals the presence of the event to the master. The master then reads out the event. Events can be error messages and warnings/maintenance data. Error messages are transmitted from the device to the controller via the IO-Link master. The transmission of device parameters or events occurs independently from the cyclic transmission of process data.

## Accessing IO-Link Data

### Cyclic Data

In order to exchange the cyclic process data between an IO-Link device and a controller, the IO-Link data from the IO-Link master is placed on the address ranges assigned beforehand. The user program on the controller accesses the process values using these addresses and processes them. The cyclic data exchange from the controller to the IO-Link device (for example, IO-Link sensor) is performed in reverse.

## Acyclic Data

Acyclic data, such as device parameters or events, are exchanged using a specified index and subindex range. The controller accesses these using Explicit Messaging. The use of the index and subindex ranges allows targeted access to the device data (for example, for reassigning the device or master parameters during operation).

## Start-up of the I/O System

If the port of the master is set to IO-Link mode, the IO-Link master attempts to communicate with the connected IO-Link device. To do so, the IO-Link master sends a defined signal (wake up pulse) and waits for the IO-Link device to reply.

The IO-Link master initially attempts to communicate at the highest defined data transmission rate. If unsuccessful, the IO-Link master then attempts to communicate at the next lower data transmission rate.

If the master receives a reply, the communication begins. Next, it exchanges the communication parameters. If necessary, parameters that are saved in the system are transmitted to the device. Then, the cyclic exchange of the process data and value status begins.

## Assign Device Parameters

Setting up a device for a specific application requires changes to parameter settings. The device parameters and setting values are contained in the IODD of the device.

IO Device Description (IODD) files contain information about the device identity, parameters, process data, diagnostic data, and communication properties. These files are required to establish communication with the sensors via IO-Link.

The IODD consists of multiple data files; the main file and several optional language files are in XML-format and graphic files are in PNG format (portable network graphics). These files adhere to the IO-Link open standard, which means that they can be used with any IO-Link masters.

IODD files are assigned using Studio 5000® and the 1734-4IOL Add-on Profile (when using the 1734-4IOL IO-Link master module).

## Rockwell Automation Solution

### Overview and Benefits

Rockwell Automation is the only supplier who provides every piece of the Connected Enterprise solution from top to bottom. Plus, exclusive features, and Premier Integration between Allen-Bradley® components and an Integrated Architecture® system allow for a seamless connection and commission of control components. Empowering the ability to reap the benefits of an IO-Link solution



with access to more detailed and customized plant-floor information than other solutions can offer.

## Premier Integration

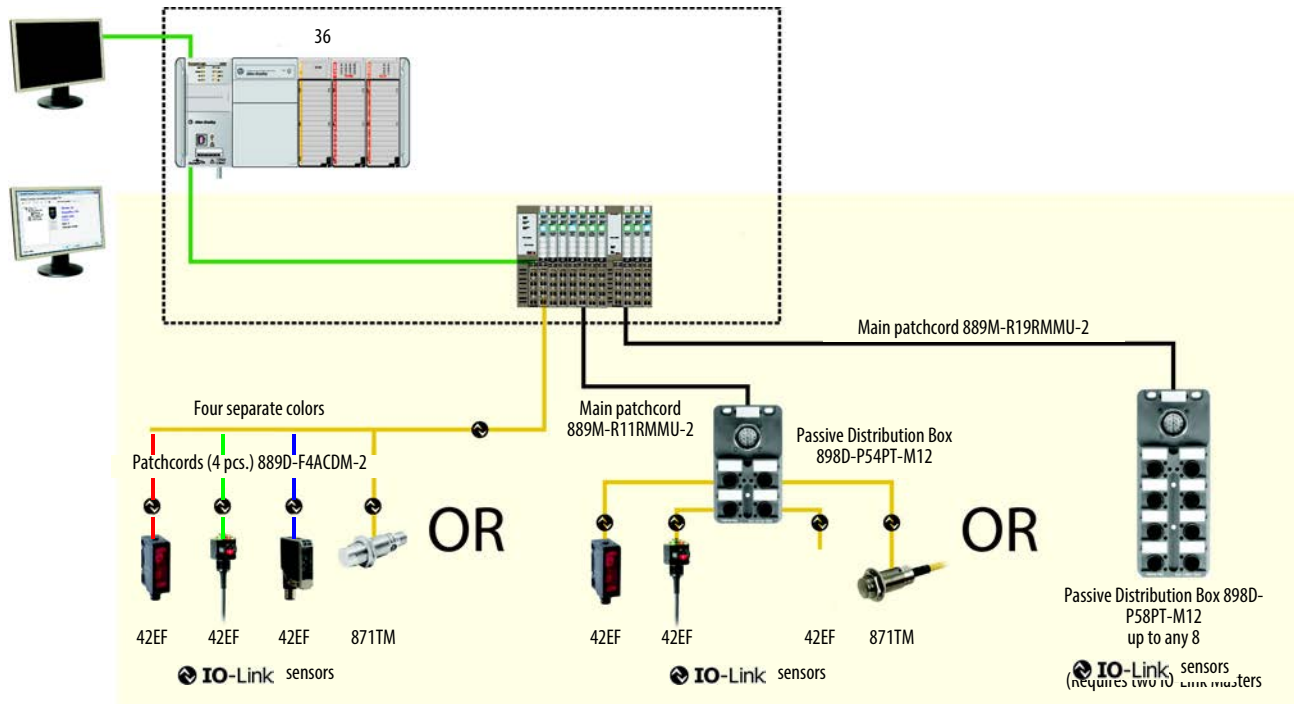

The Studio 5000 Logix Designer environment combines design and engineering elements in one interface, enabling users to access IO and configuration data across the Integrated Architecture system. Using a Rockwell Automation solution, provides a smooth, consistent integration of Allen-Bradley IO-Link enabled devices into the system.

To simplify the integration of the Rockwell Automation IO-Link devices to the Rockwell Automation architecture, there is an IO-Link Add-on Profile (AOP) available for the 1734-4IOL master module. The use of an AOP simplifies the setup of devices by providing the necessary fields in an organized manner that allows set up and configuration of the systems in a quick and efficient manner.

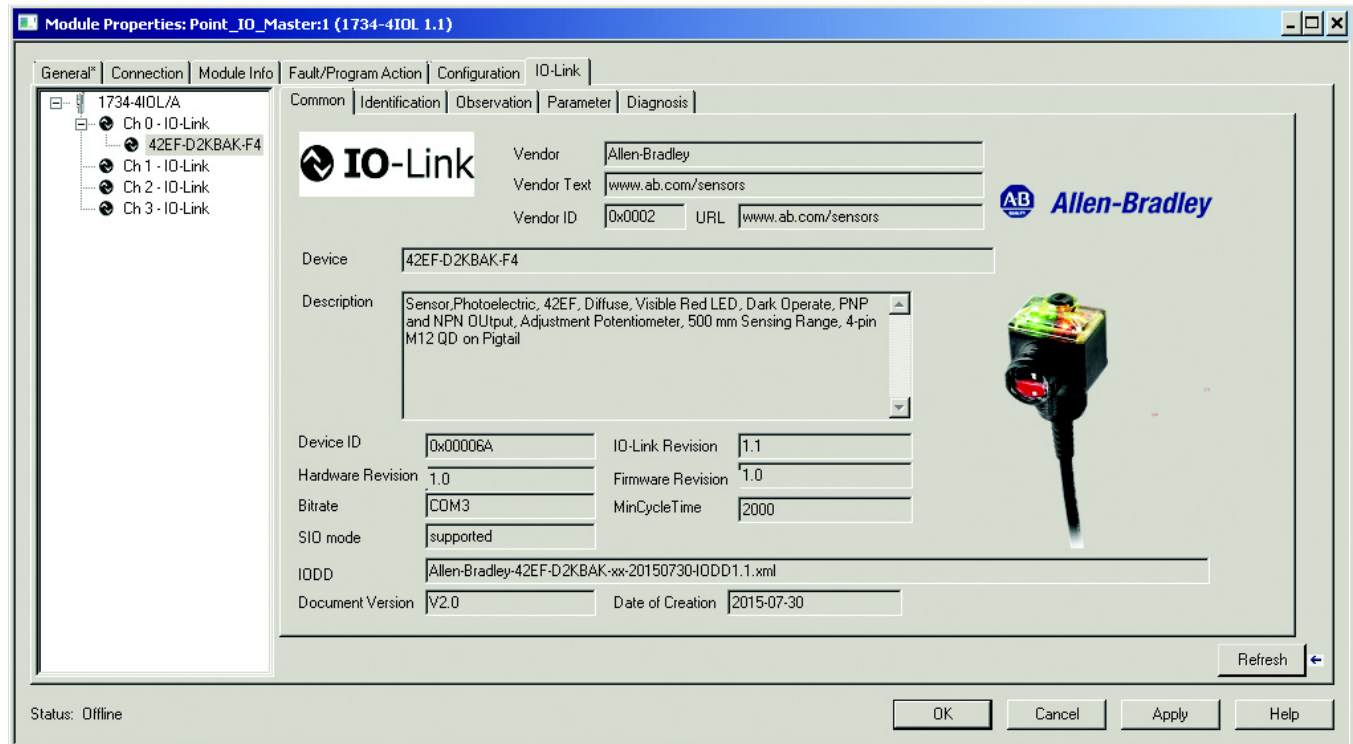

## 42EF IO-Link Features

The 42EF VisiSight™ communicates the following parameters via IO-Link:

**Sensor Heartbeat** feature helps ensure excellent reliability operation by indicating to the PLC if a sensor has lost connectivity due to sensor failure or faulty wiring.

**Margin Low Alarm** minimizes downtime by indicating when the sensor is about to fail due to insufficient light being reflected.

**Signal Strength** provides the raw measurement value of the amount of light reflected from the target.

**Margin Levels** displays the excess gain above the sensor threshold to help ensure reliable detection of the target.

**Contrast Levels** displays the difference between the light signal levels that the sensor read the last time the output was ON versus the last time the output was OFF. This helps identify that there is enough difference between the target and the background.

**Margin Low and High Indication Multipliers** allow for specifying the minimum margin levels when the local indication LED indicates marginal conditions and stable conditions.

**Location Indication** helps locate the sensors in large machines where there are several units close to each other.

Alignment Mode facilitates the alignment of the sensors in applications where a transmitted beam receiver or a polarized retroreflective sensor require optimal alignment.

Timers and Counters add additional sensor functionality by allowing the operator to count the number of times a target has been detected.

Timers and Counters add additional sensor functionality by allowing the operator to count the number of times a target has been detected.

Pin 2 Enable parameter allows continuous monitoring of the sensor while providing access to a discrete output. Pin 2 Enable is ideal for applications where high-speed sensor detection is critical to the application.

Process Data Maps allow the selection of the type of information that is continuously sent to the PLC as a process data parameter.

**Automatic Device Configuration (ADC):** Replacing damaged sensors is easy. Simply remove the old Allen-Bradley sensor and connect the new one—the controller automatically sends the configuration to the new sensor.

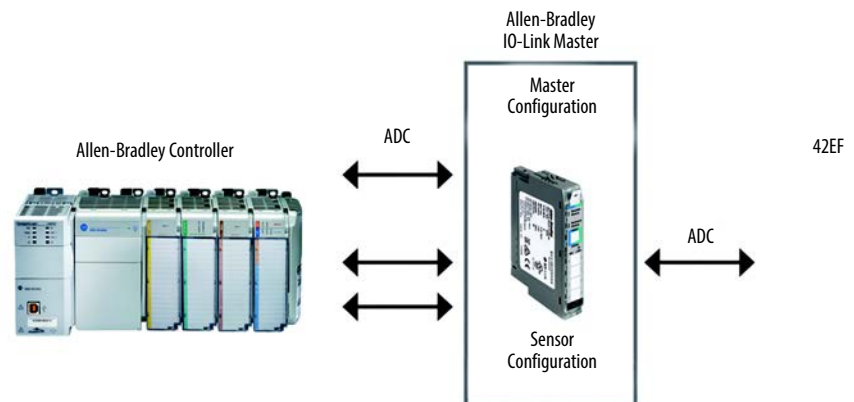

**Application Specific Name (ASN):** With numerous sensors on a machine with the same catalog number, the ASN parameter within each sensor makes it easy to identify the sensor during commissioning and the lifetime of the machine when collecting data. Name resides in the project and the sensor itself.

Channel	Mode	Vendor	Device	Application Specific Name	Electronic Keying	Process Data Input	Change Device
0	IO-Link	Allen-Bradley	42EF-D2MPAK-F4	Jam Detection	Exact Match	Triggered_Margin_Proximity_Gain_Signal	...
1	IO-Link						...
2	IO-Link						...
3	IO-Link						...

OK Cancel

**Tag Naming for I/O Data:** Rockwell Automation system solutions provide tag names that are based on the Allen-Bradley sensor connected. I/O data is converted, formatted, and named based on the Allen-Bradley sensor applied.

Reduces commissioning time by the OEM and reduces troubleshooting time by the end user when searching for sensor data. Consistent naming techniques used.

Point_IO_Master:1:I.Ch0Triggered	0	Decimal	BOOL
Point_IO_Master:1:I.Ch0MarginLowAlarm	0	Decimal	BOOL
Point_IO_Master:1:I.Ch0ProximityAlarm	0	Decimal	BOOL
⊕ Point_IO_Master:1:I.Ch0Gain	0	Decimal	INT
⊕ Point_IO_Master:1:I.Ch0SignalStrength	0	Decimal	DINT

## Setting up the 42EF for IO-Link Mode

This chapter shows the physical hardware and software required to configure the 42EF through IO-Link and provides a simple guide to setting up the hardware.

Products required:

### Hardware

- 42EF RightSight sensor
- CompactLogix™ or ControlLogix® PLC Platform
- POINT I/O™ Communications Interface: 1734-AENTR
- POINT I/O IO-Link Master Module: 1734-4IOL
- POINT I/O Terminal Base: 1734-TB
- RJ45 network cable for EtherNet/IP connectivity: 1585J-M8TBJM-1M9\*
- 889D cordsets (optional): 889D-F4AC-5\*\* (IO-Link maximum acceptable cable length is 20 m (65.6 ft))

### Software

- Studio 5000 environments, version 20 and higher
- Sensor specific IODD
- 1734-4IOL IO-Link Add-on Profile (AOP)

## Example: Setting Up the Hardware

In this example, we are showing an Allen-Bradley POINT I/O chassis with a 1734-AENTR adapter and a 1734-4IOL IO-Link master module in the first slot. The 1734-AENTR is communicating with a CompactLogix™ controller via EtherNet/IP.

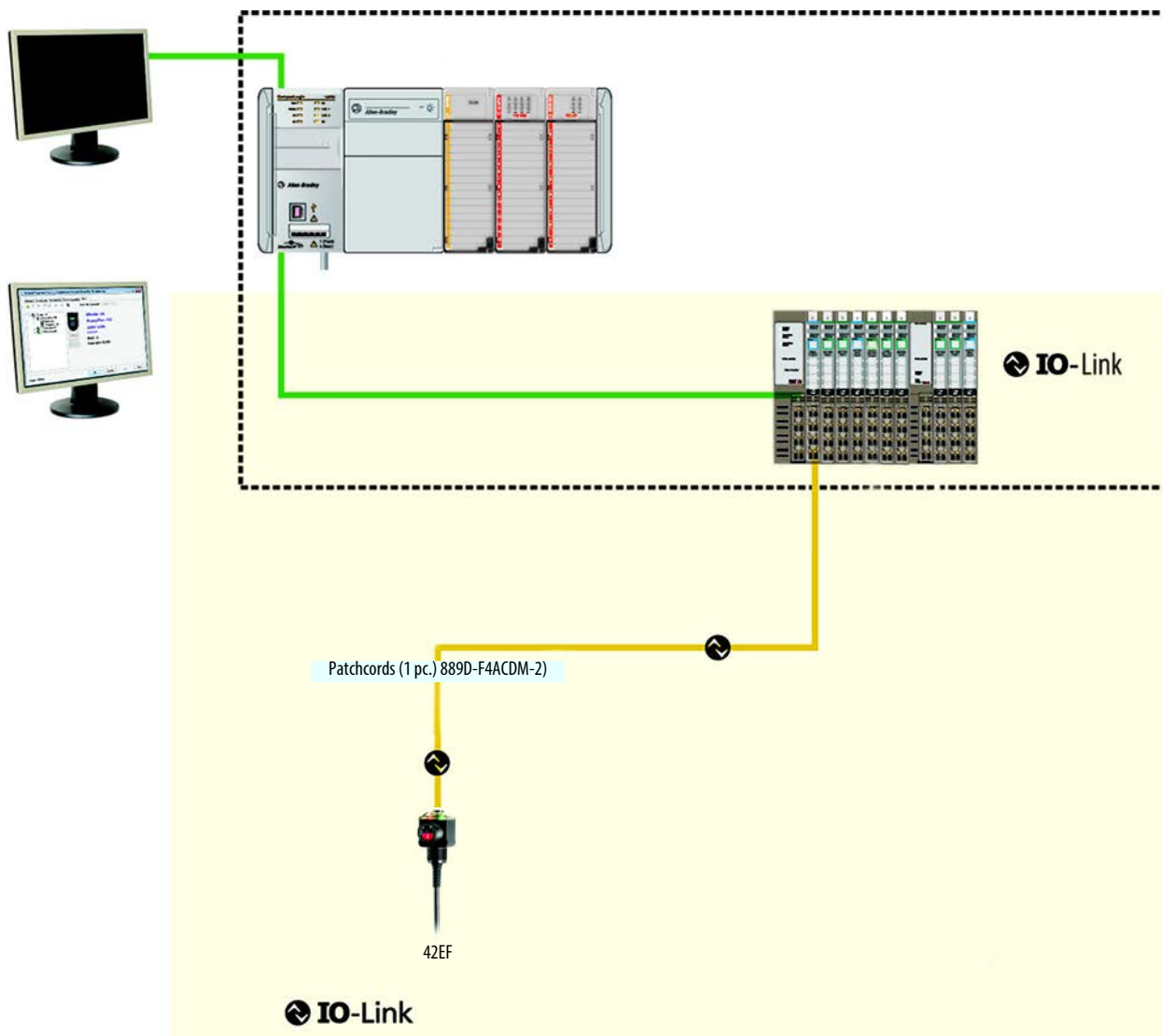

When adding a 42EF to the 1734-4IOL master module, complete the following steps:

1. Provide power to the 1734-AENTR adapter.
2. Set the node address on 1734-AENTR adapter.
3. Connect the 1734-AENTR to the Allen-Bradley controller with the recommended RJ45 Ethernet cable.
4. Wire the sensor cable to the desired location on the IO-Link master (in this example, we are showing the sensor that is wired to the channel 0).
5. Connect the 42EF to the other end of the sensor cable.

6. After connecting the sensor, you will need to create/open a project in Studio 5000 to establish communication with the Allen-Bradley controller that is being used and to add the 1734-AENTR adapter and 1734-4IOL IO-Link master module to Controller Organizer Tree (see Chapters 6 and 7 for detailed instructions).

---

**IMPORTANT** Once the sensor adapter and the master module have been configured in the Controller Organizer Tree and the 42EF has been wired to the master module, the green LED indicator on the sensor will flash at a 1 Hz rate, which indicates that it is operating in IO-Link mode. The green indicator associated with the channel that the sensor is wired into on the right-hand side of the master module will also pulse at a 1 Hz rate.

---

## Creating a Project

To begin a new project in Studio 5000, follow these steps.

If there's an existing project within Studio 5000 with CompactLogix or ControlLogix hardware that is installed and communicating online, go directly to Chapter 7 "Configuring the IO-Link Master."

1. Double-click the Studio 5000 icon.

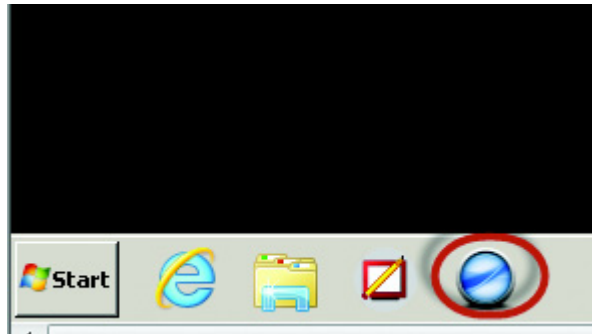

2. Click New Project.



3. To program the controller, select the controller that is used. In this example, it is the "1769 L24ER" CompactLogix.



- After selecting the controller, name the project and click “Next.” In this example, the project name is “Project42EF.”

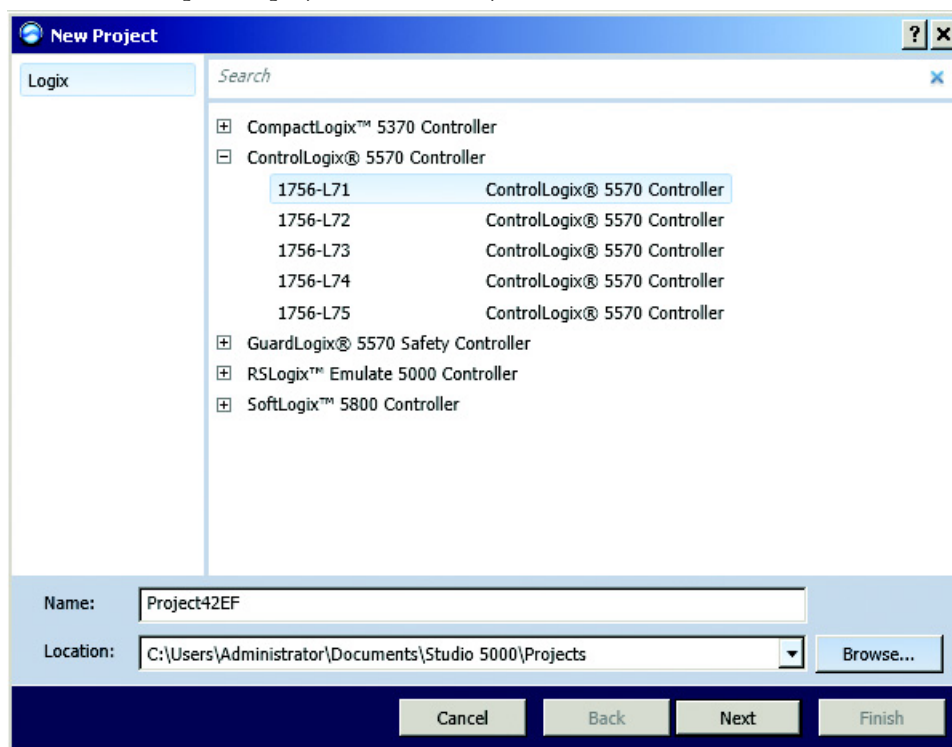

- Once the project opens up, setup the IP address of the controller to help ensure communication. To set the IP address, click the browsing icon.

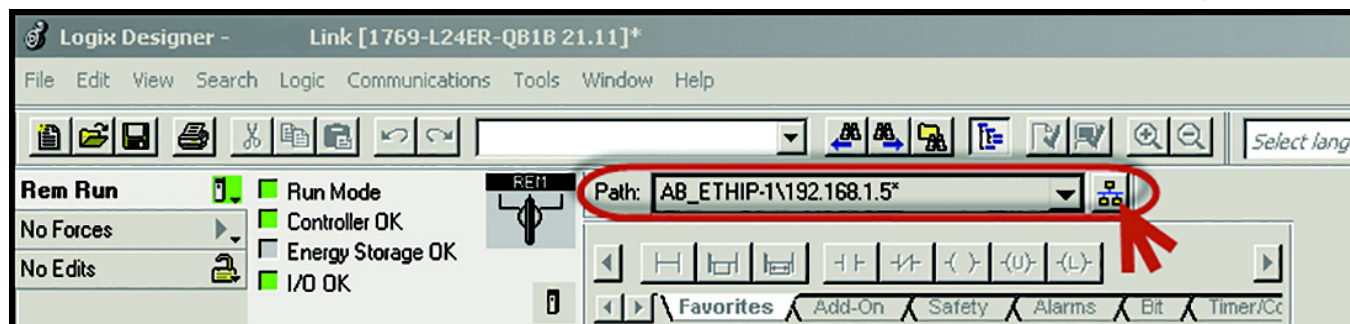

6. Select the controller that is being used for the project. In this example, we are using a 1769-L24ER-QB1B CompactLogix.

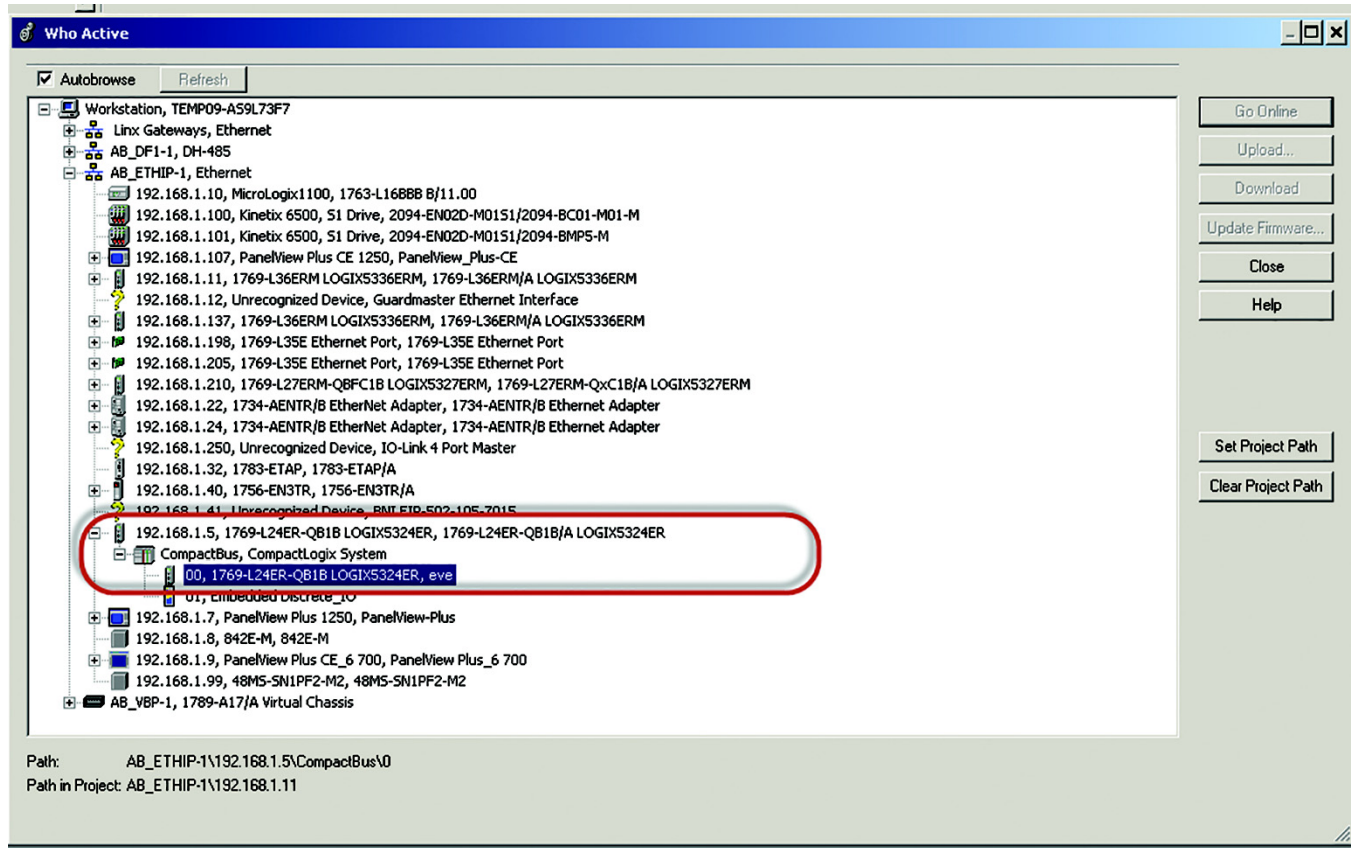

7. Click “Go Online” to start communicating.

The next step is to configure the IO-Link Master.

## AOP Installation

Next, verify that Studio 5000 contains the 1734-4IOL IO-Link AOP. Version 20 or higher of Studio 5000 supports this module and AOP. To verify that the 1734-4IOL is installed, helps ensure the 1734 AENT(R) contains the 1734-4IOL in the library. If the AOP is required to be downloaded, please reference Appendix A for more information.

## Configuring the IO-Link Master

1. Make sure that the controller is offline to configure the IO-Link Master.

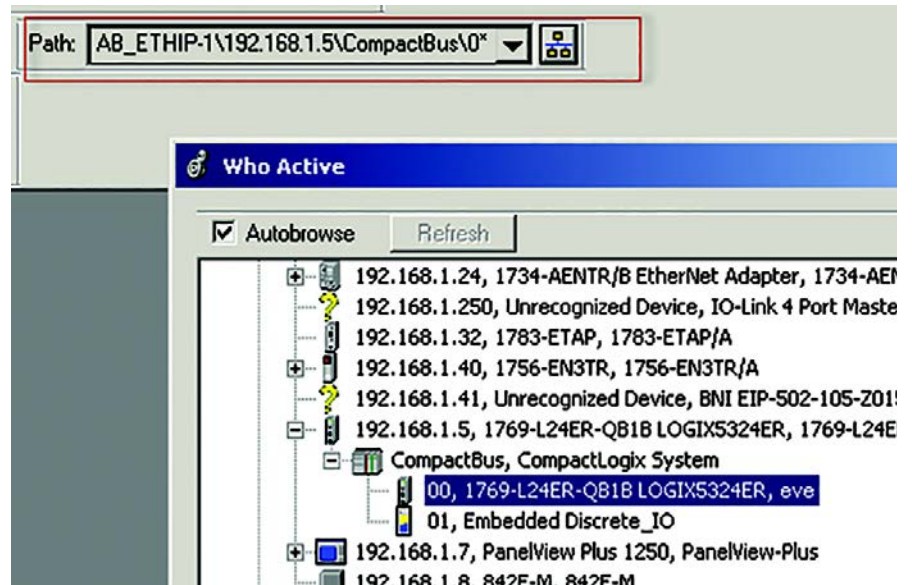

2. In the controller organizer tree, find Ethernet under I/O Configuration and right-click to “add new module.”

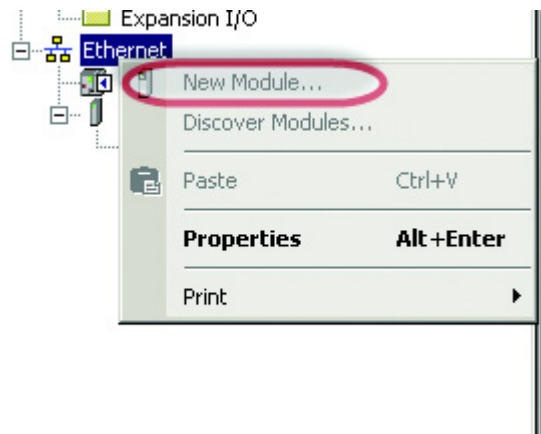

- The module window pops up and show the available modules. Select the “1734-AENTR, 1734 Ethernet adapter, two-port, twisted-pair media” and click Create.

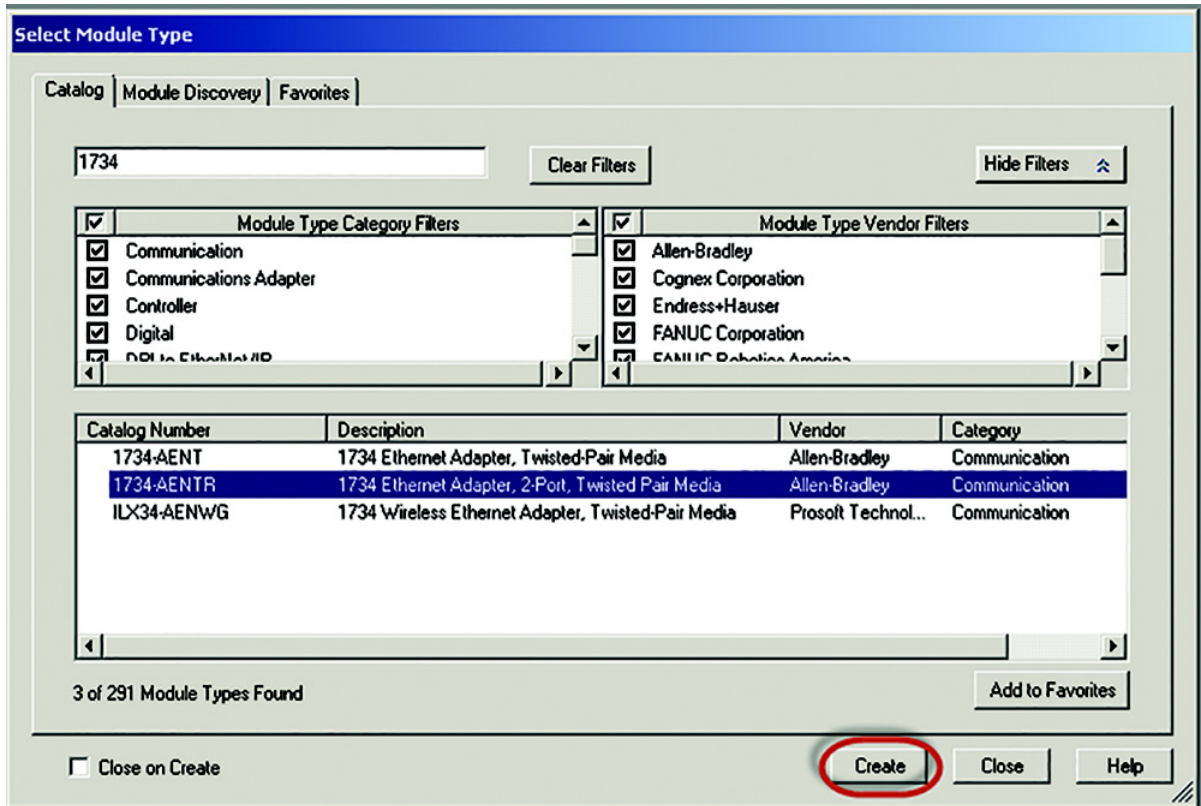

- Name the Ethernet adapter (in this example our adapter name is “adapter”), set the chassis size, check the module revision and set-up the adapter IP address. Click OK and then Close.

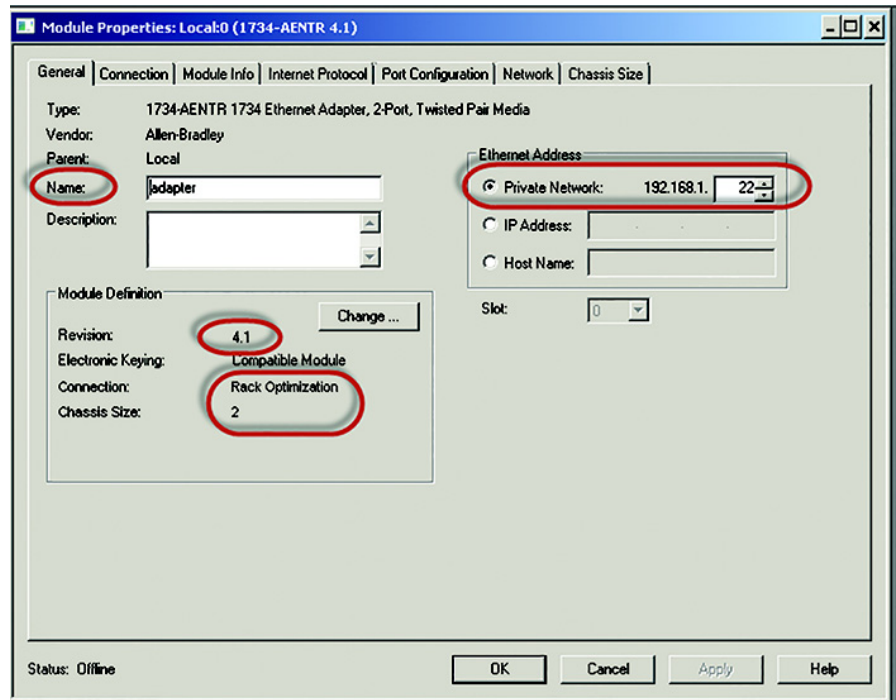

- The 1734 AENTR now appears in the Controller Organizer tree.

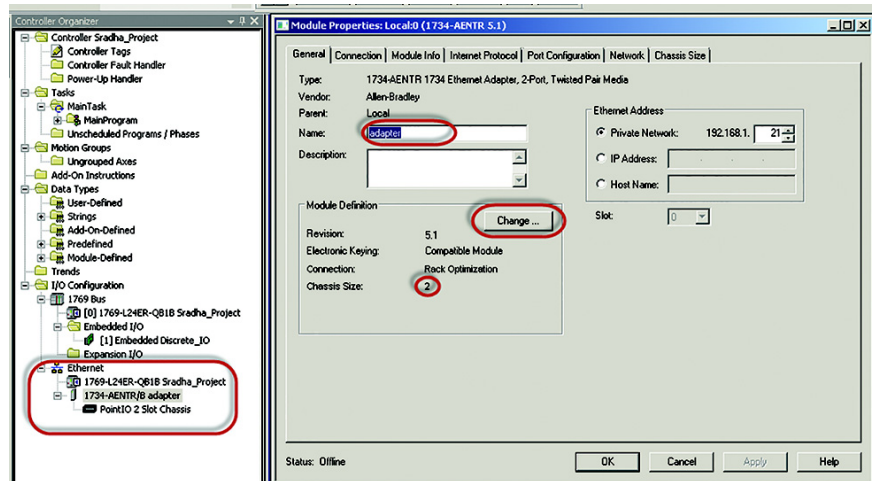

- Right-click on 1734-AENTR adapter, and then select “New Module.”

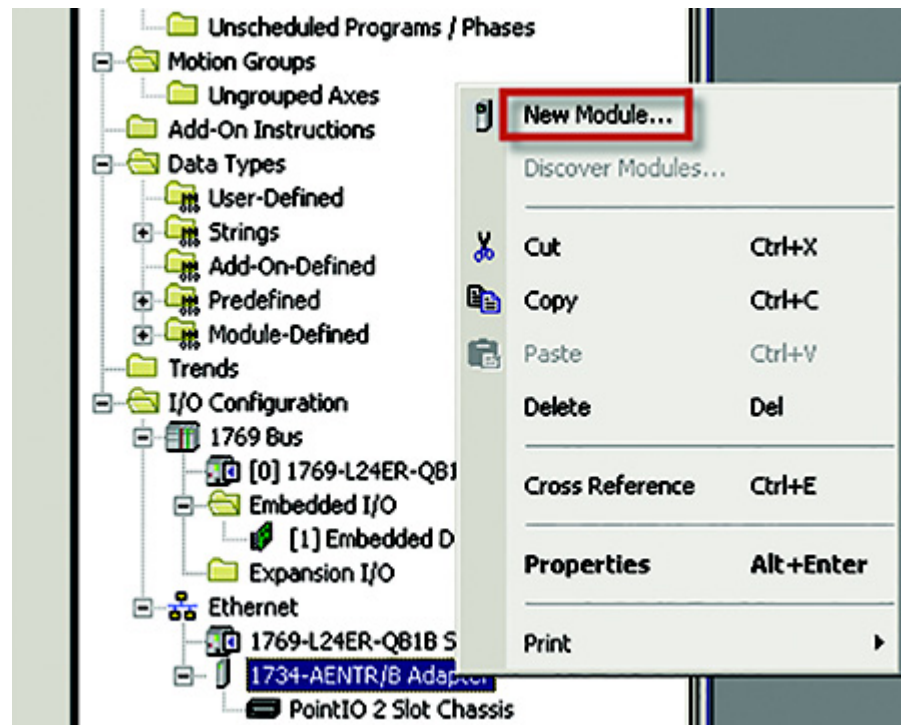

7. Select "1734-4IOL" and click Create.

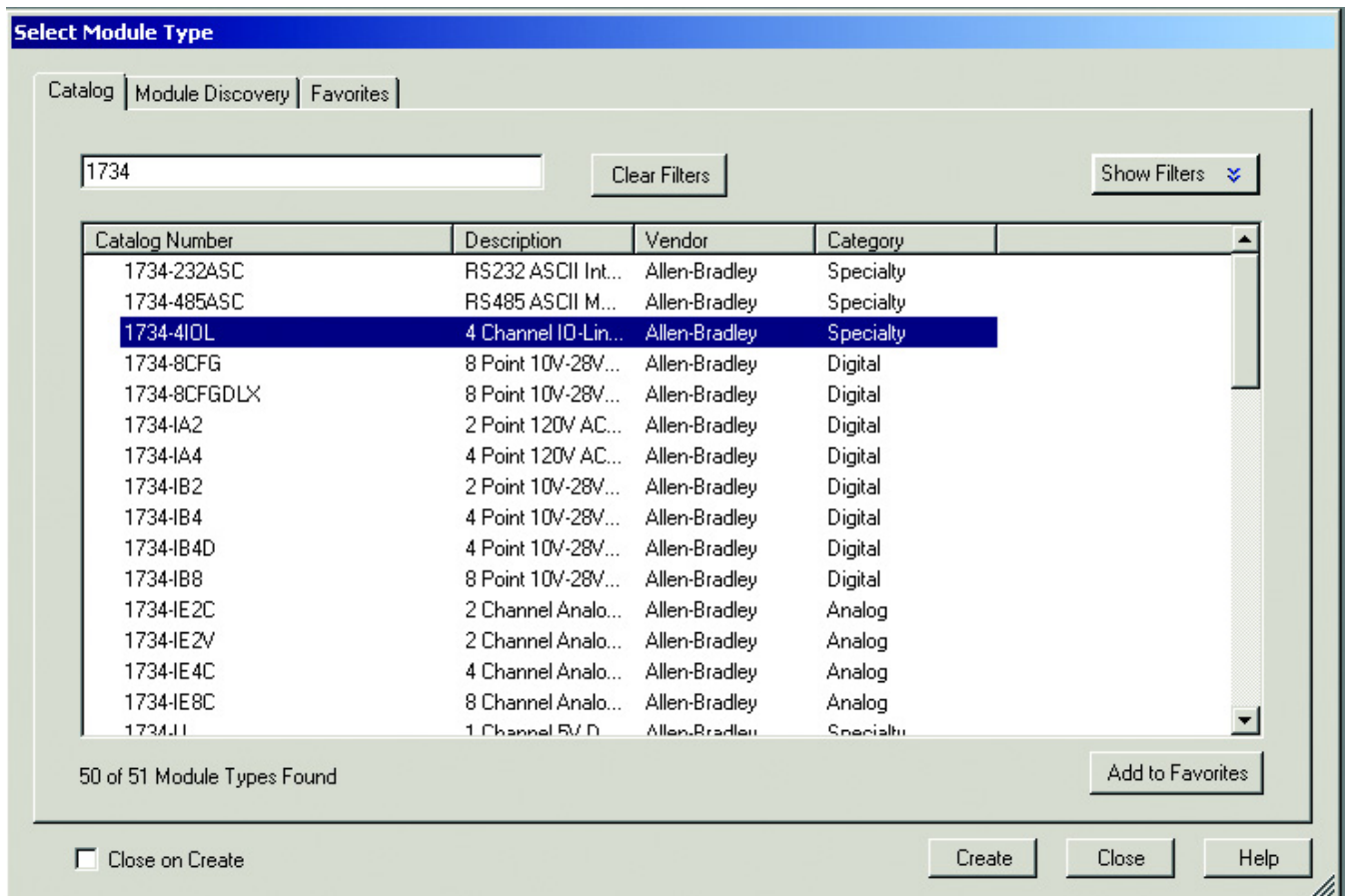

8. Another screen appears showing the IO-Link Configuration screen.
9. Name the IO-Link Master and click OK.

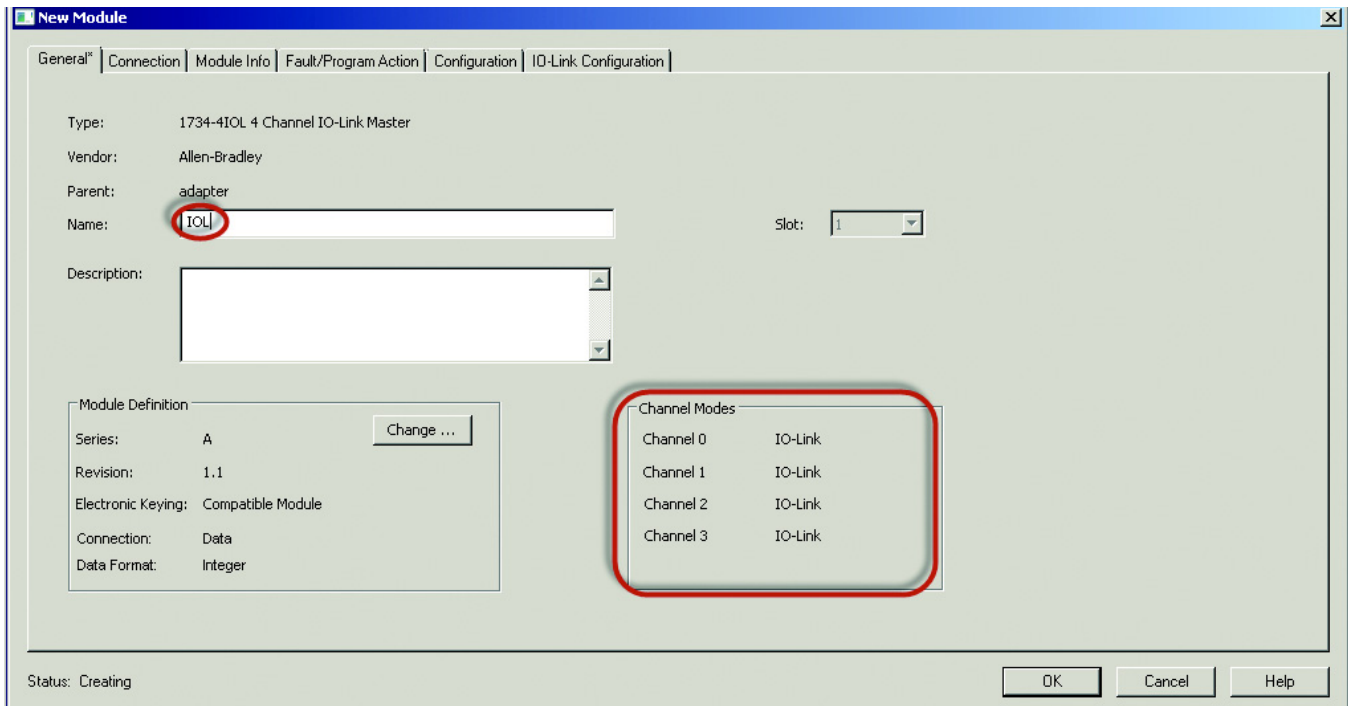

The 42EF can now be configured. To configure the sensor, a sensor specific IODD (IO Device Description) file is required. The next steps will show how to register the IODD file.

## Registering the 42EF IODD

To initialize a sensor on an IO-Link Master, register the IODD of the sensor. The IO Device Description (IODD) files contain the information that is related to the sensor, integrated into the system environment.

By default, the IODDs are already located in the AOP Library.

If the IODD file for the 42EF cannot be located in the library, it can be downloaded from <http://compatibility.rockwellautomation.com/Pages/MultiProductDownload.aspx>. Once the IODD is registered, there's no need to register the IODD again unless it is manually deleted from the Master Tree.

1. Double-click the 1734-4IOL in the Controller Organizer Tree.

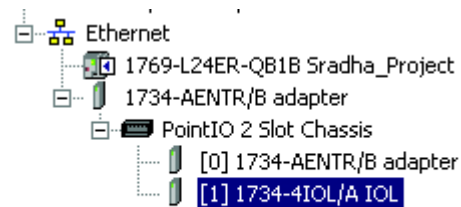



2. Select the IO-Link configuration tab.

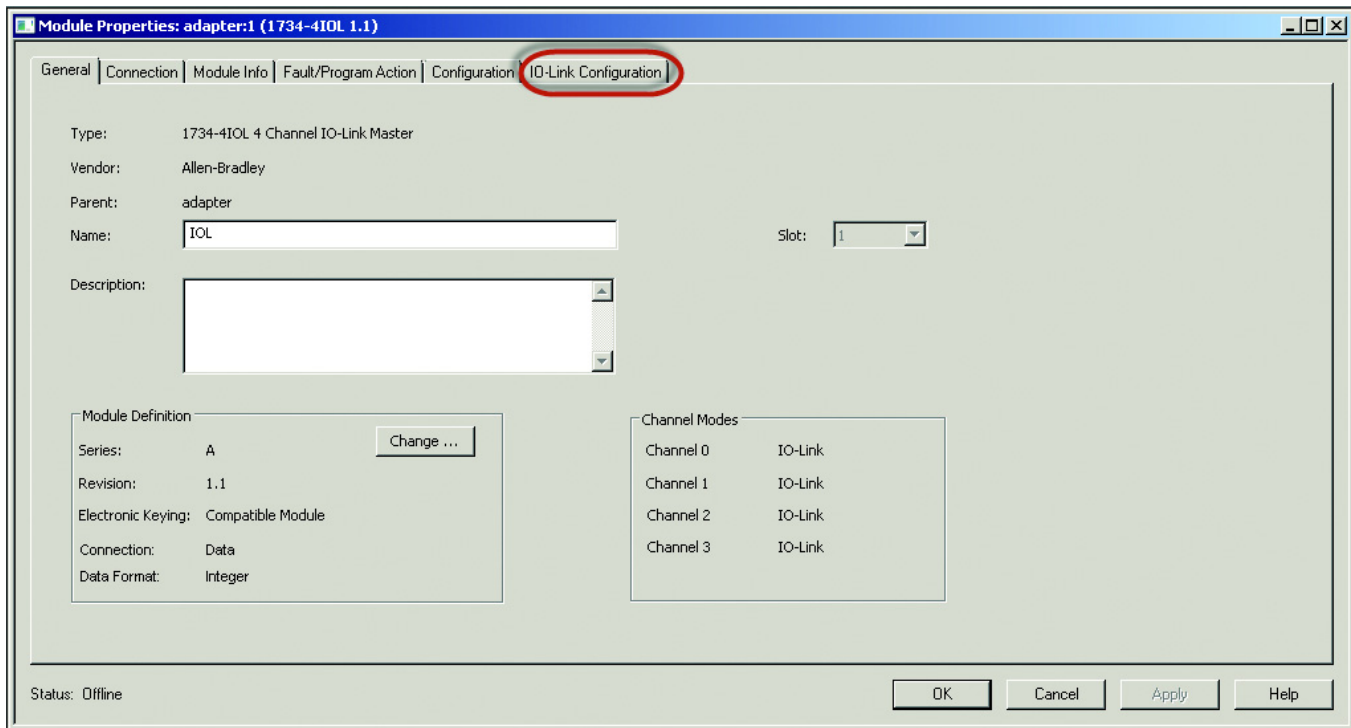

The IO-Link configuration screen appears.

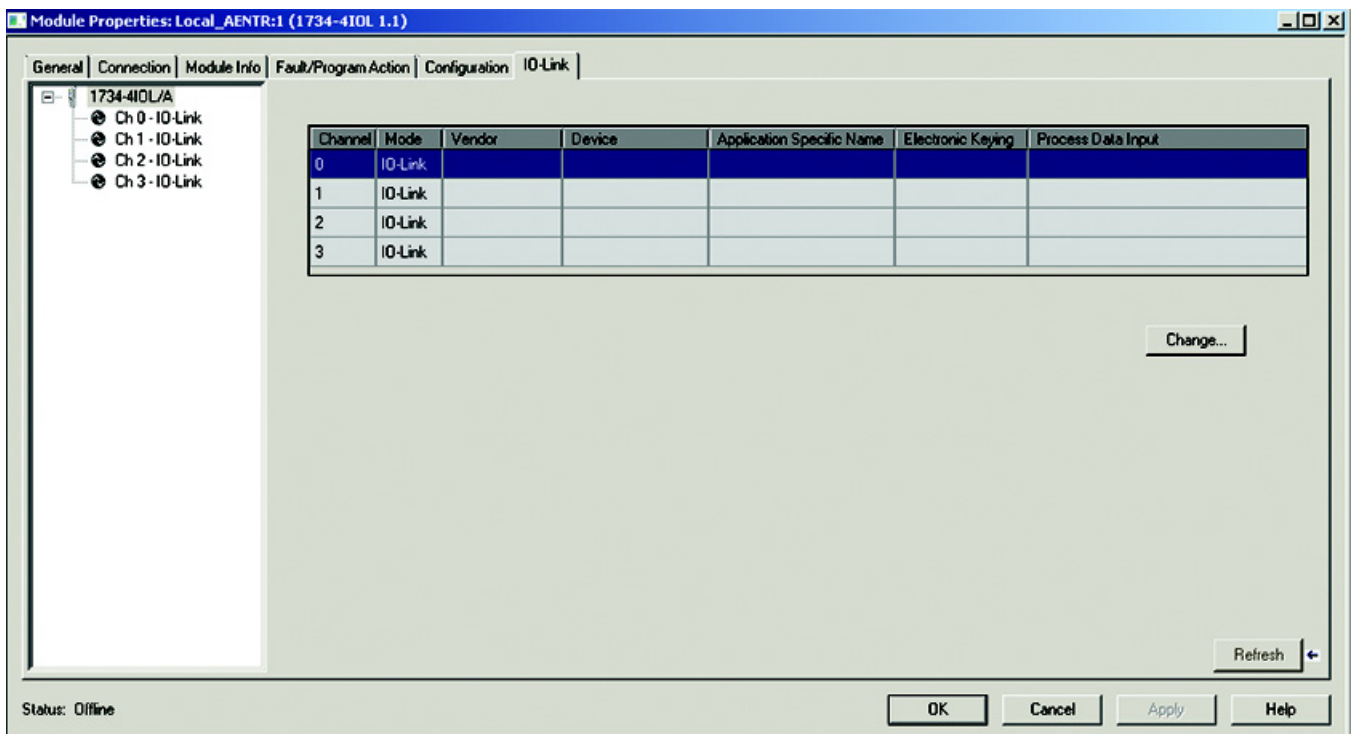

3. Right-click the left section of the screen where the channel information is located and click “Register IODD.”

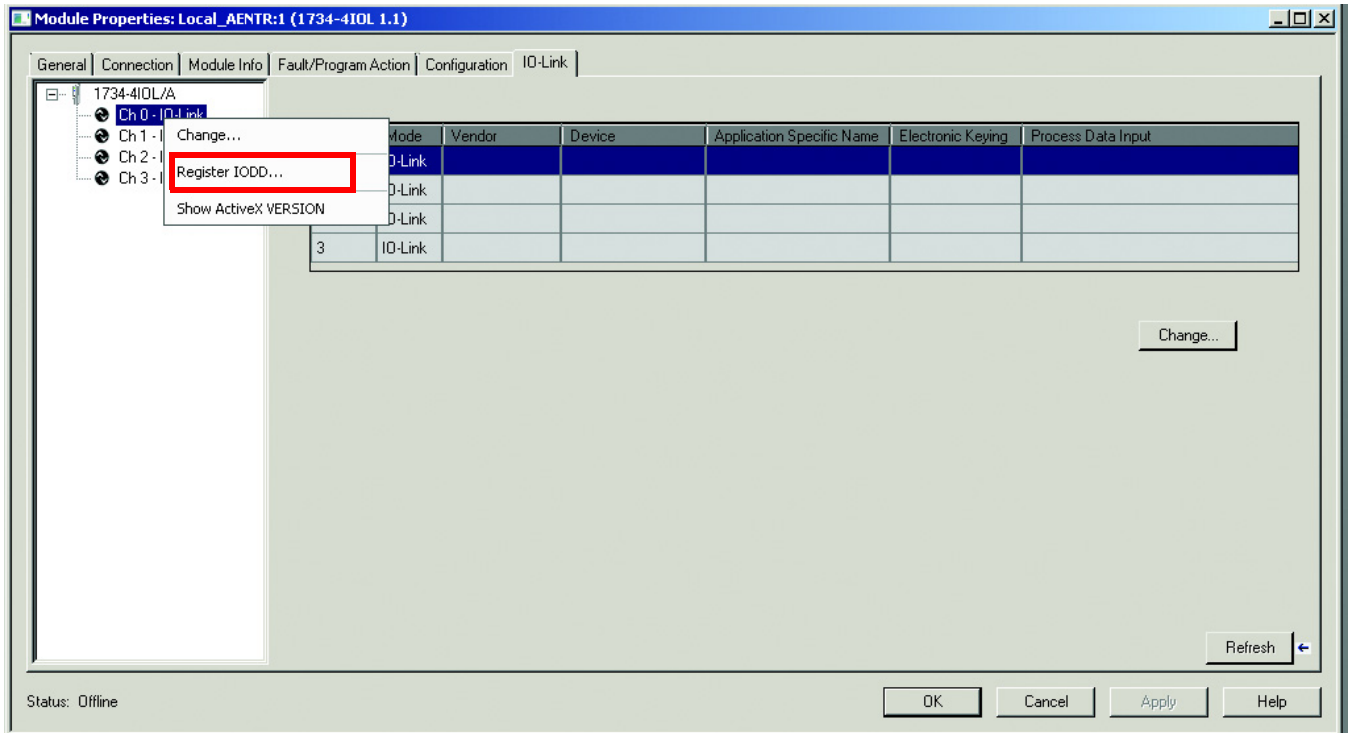

- Select the IODD file that is needed for the sensor being configured and double-click.

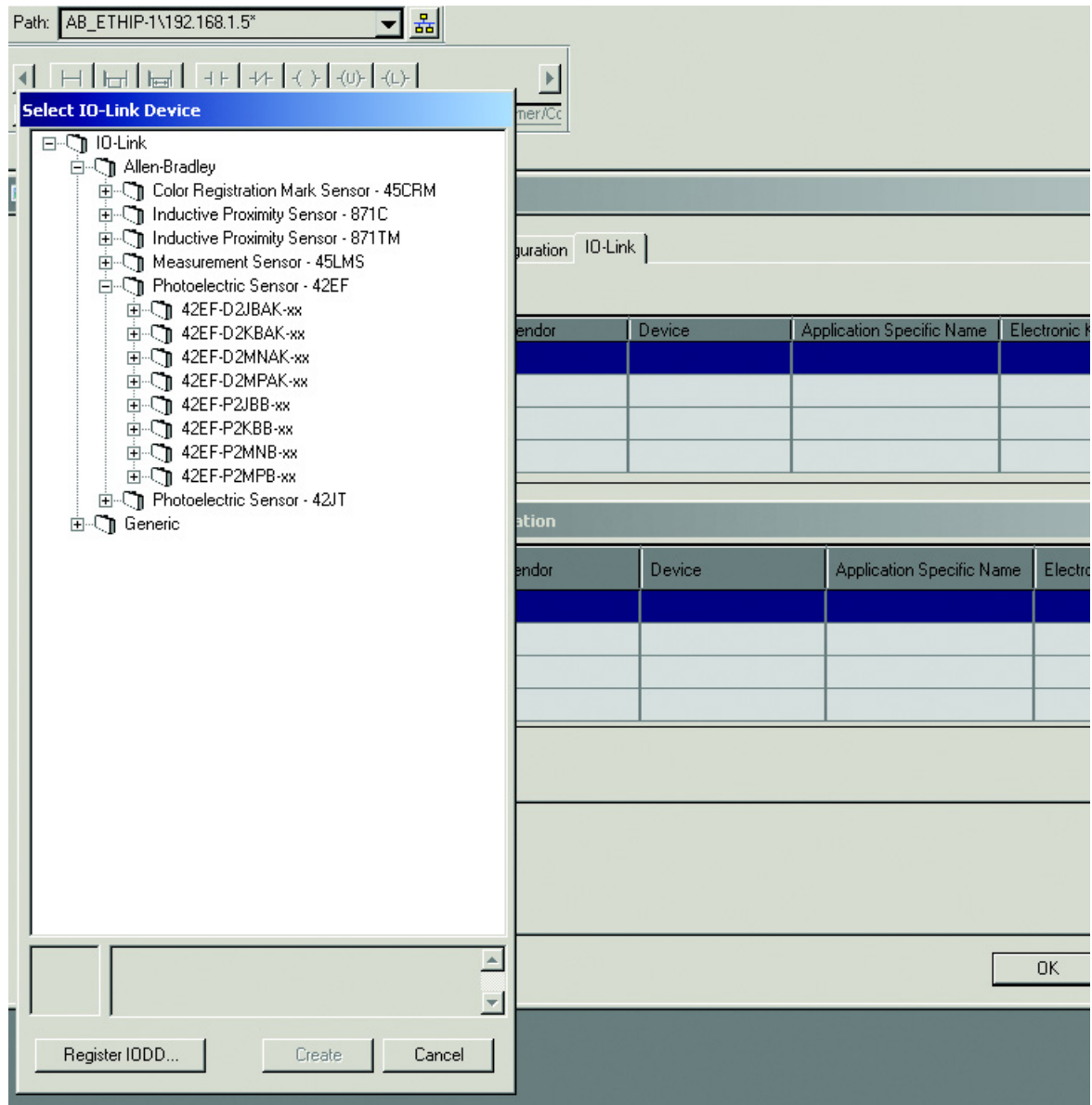

- Then click “Exit.”

The IODD registration is complete.

## Connecting the 42EF to the IO-Link Master

Once the IODD file is registered, the sensor must be connected to the IO-Link master. The controller must always be off line to add a device to the IO-Link Master.

1. Right-click the channel number where the sensor is configured and click “Change.”

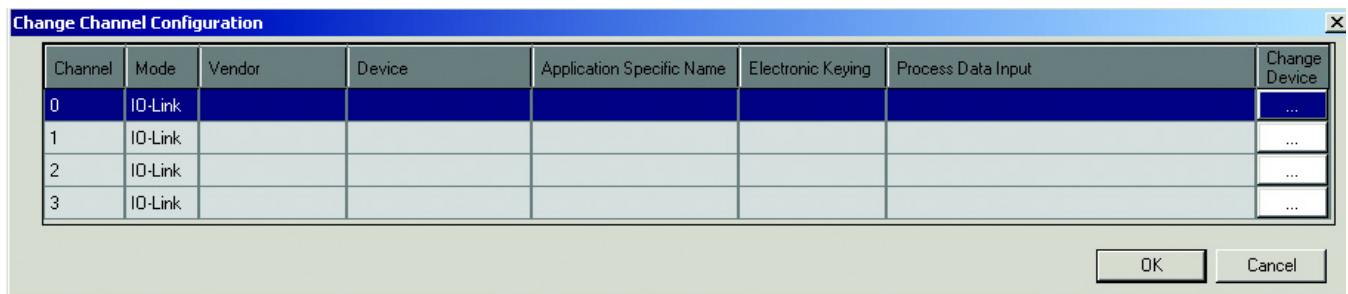

2. Click on ... to select the appropriate sensor.

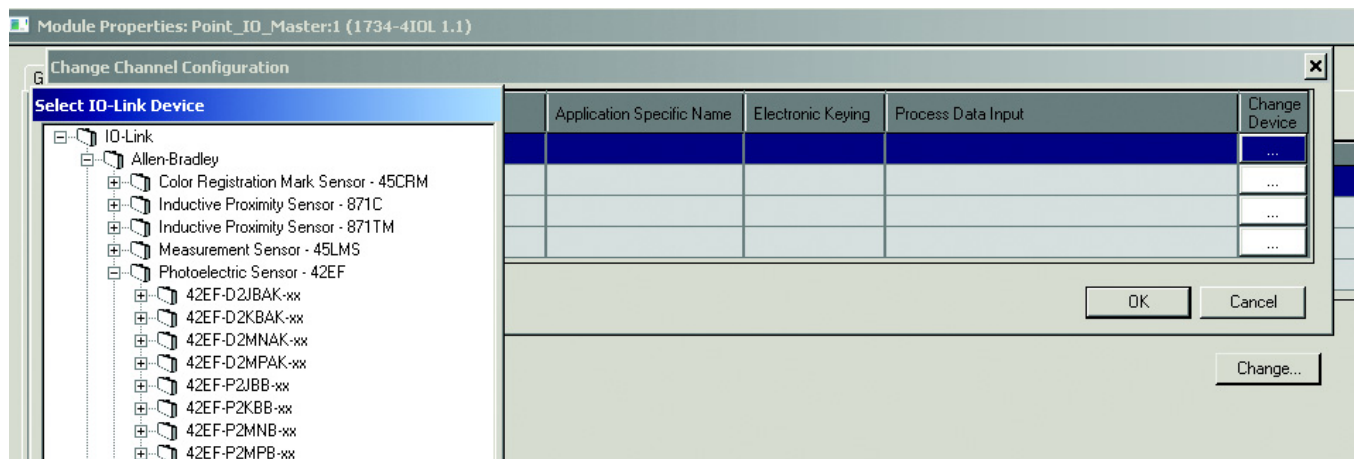

3. Select the appropriate sensor and double-click or click “Create.”

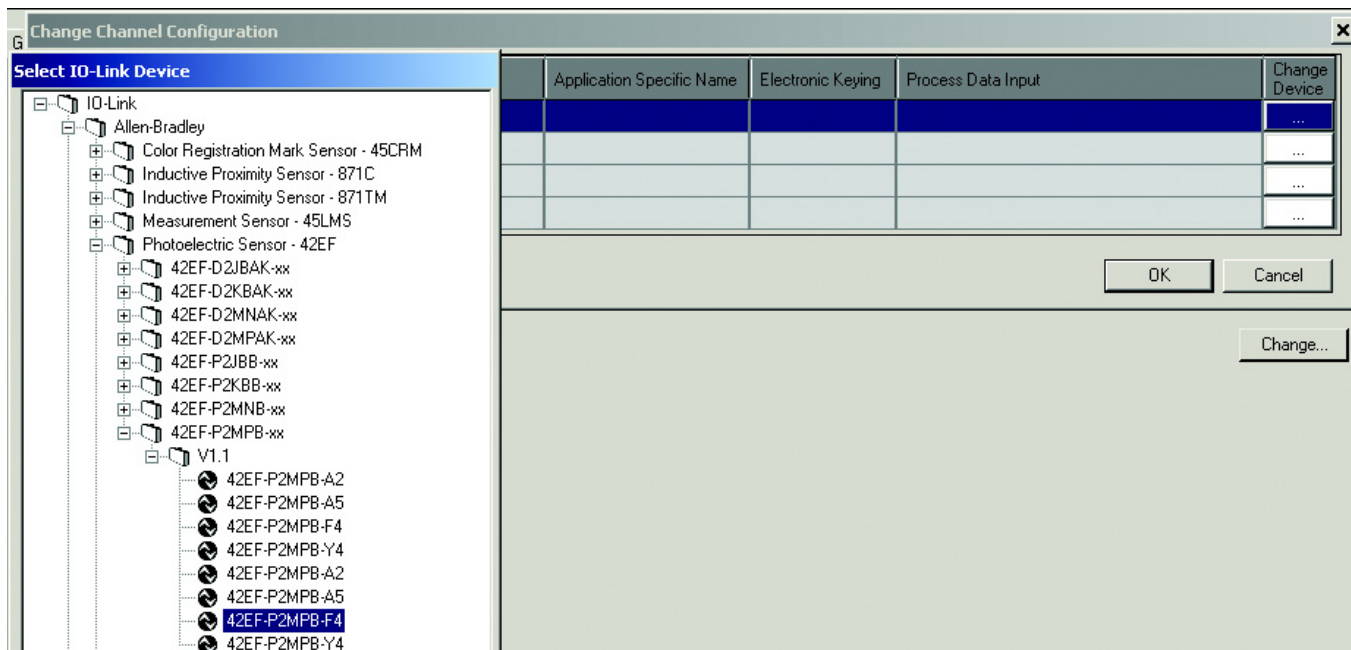

4. Go “OK” to accept configuration.

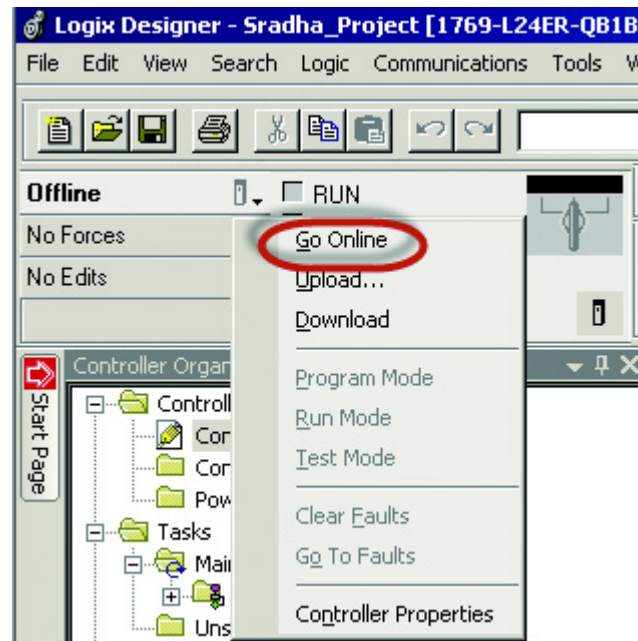

5. Go online to communicate. The following pages describe each tab of the 1734-4IOL AOP in detail and how to teach the sensor.

The following pages describe each tab of the 1734-4IOL AOP in detail and how to teach the sensor.

## Exploring the 42EF IO-Link Parameters

### Overview

The 42EF offers four different tabs to describe the sensor functionality and operation. These tabs are:

**Common Tab:** Provides general product information about the sensor specifications and IO-link IODD information.

**Observation Tab:** Provides device monitoring parameters with signal strength ON, signal strength OFF, contrast, and gain.

**Identification Tab:** Provides the sensor catalog number, series letter, general product description including the current product firmware and hardware revisions.

**Parameter Tab:** Displays and allows the user to change the IO-Link parameters offered by the 42EF VisiSight Sensor.

**Diagnosis Tab:** Offers the different teach functions available in the 42EF.

## IO-Link Configuration

### Common Tab

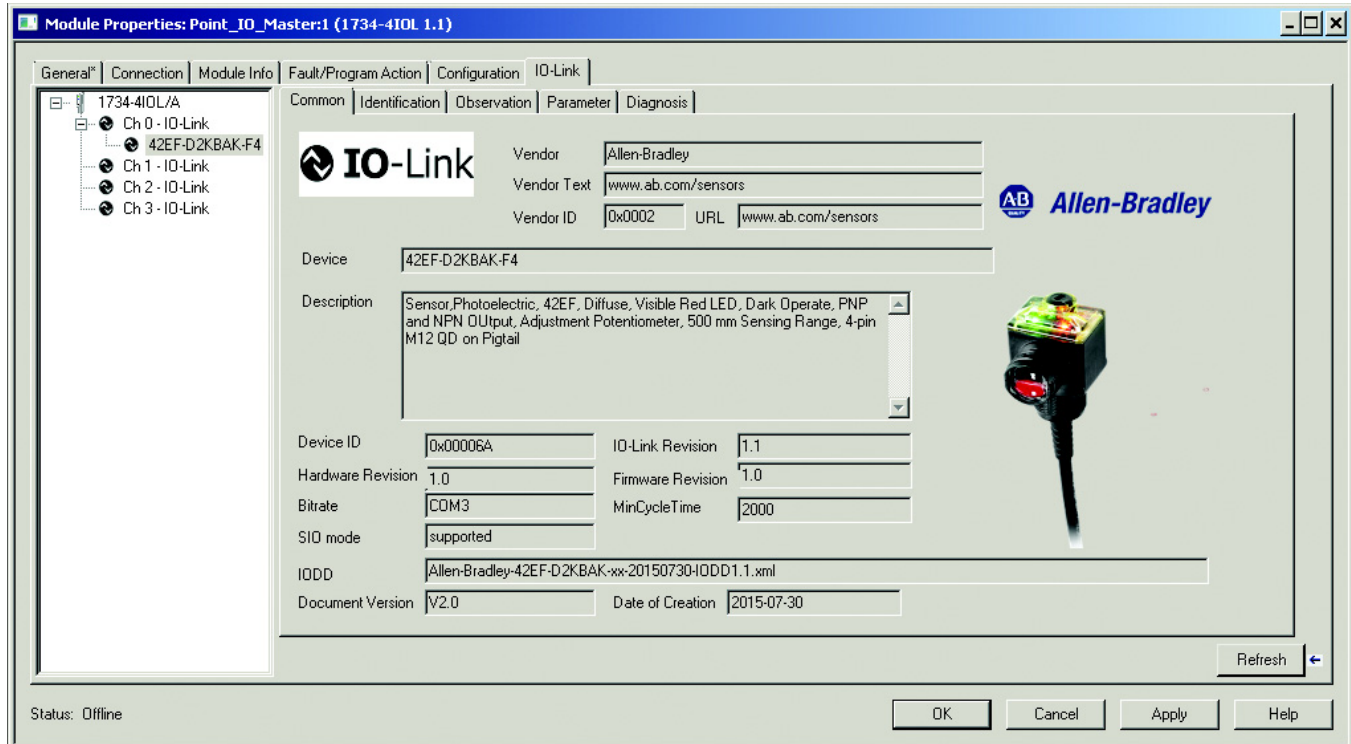

This tab contains the following sensor information:

**Vendor:** Provides the vendor name of the product.

**Vendor Text:** Field used to describe additional product information.

**Vendor ID:** Describes the vendor ID of the manufacturer of the product as designated in the IO-Link consortium.

**URL:** Displays the vendor URL.

**Device:** Provides the specific catalog number of the product.

**Description:** Describes the sensor features and range performance.

**Device ID:** Displays the unique device ID as defined in the IO-Link specifications.

**IO-Link Revision:** Displays the current IO-Link version supported by the device.

**Hardware Revision:** Displays the latest sensor hardware information.

**Firmware Revision:** Displays the latest sensor firmware information.

**Bitrate:** Displays the supported bitrate for communications as defined in the IO-link 1.1 standard.

**Minimum Cycle Time:**

**SIO Mode:** Describes if the sensor is also designed to operate without an IO-Link connection.

**IODD:** Displays the complete file name of the IODD that is assigned to the product.

**Document Version:** Displays the version control for the IODD.

**Date of Creation:** Displays the IODD file was created.

## Identification Tab

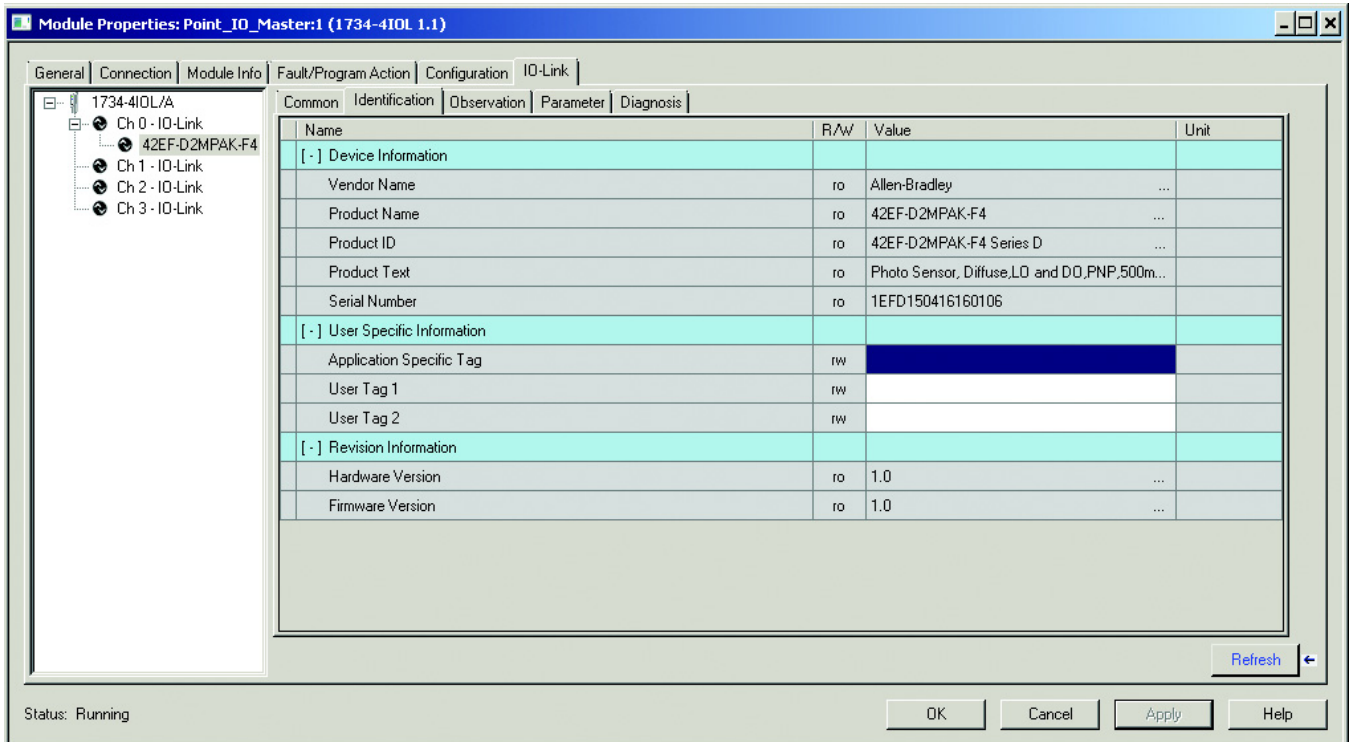

The Device Information shows us the Vendor Name, Product Name, Product Text, Product ID, and Serial Number of the exact sensor that is configured. These fields will be automatically populated according to the sensor information. These fields are Read Only (RO).

The User Specific Information contains the Application Specific Name (ASN) where you can name the sensor with a unique text string for identification. The ASN allows a unique identity of each sensor. These fields can be custom (that is populated and is Read/Write).



## Observation Tab

The screenshot shows the 'Observation Tab' of the 'Module Properties: Point\_IO\_Master:1 (1734-4IOL 1.1)' window. The left sidebar shows a tree view with '1734-4IOL/A' expanded to '42EF-D2KBAK-F4', which includes 'Ch 0 - IO-Link', 'Ch 1 - IO-Link', 'Ch 2 - IO-Link', and 'Ch 3 - IO-Link'. The main area has tabs for 'Common', 'Identification', 'Observation', 'Parameter', and 'Diagnosis'. The 'Observation' tab is active, displaying a table with the following data:

Name	R/W	Value	Unit
[ - ] Device Monitoring			
.SignalStrength On	ro		
.SignalStrength Off	ro		
Contrast	ro		
Gain	ro		

At the bottom right of the table area is a 'Refresh' button. At the bottom of the window are 'OK', 'Cancel', 'Apply', and 'Help' buttons. The status at the bottom left is 'Status: Offline'.

## Parameter Tab

The screenshot shows the 'Parameter Tab' of the 'Module Properties: Point\_IO\_Master:1 (1734-4IOL 1.1)' window. The left sidebar is the same as in the Observation Tab. The main area has tabs for 'Common', 'Identification', 'Observation', 'Parameter', and 'Diagnosis'. The 'Parameter' tab is active, displaying a table with the following data:

Name	R/W	Value	Unit
[ - ] Operation Configuration			
[ - ] Triggered			
.Set Point - Threshold	rw	1000	
.Polarity	rw	Inverted	
.Hysteresis	ro		
Pin 2 Mode	rw	Disabled	
[ - ] Sensor Configuration			
.MarginLevel - Low Multiplier	rw	0.8	
.MarginLevel - High Multiplier	rw	1.5	
[ - ] Counter / Timer			
[ - ] Counter			
.Mode	rw	Disabled	
.Reset	wo	Reset	
.Counter	ro		
[ - ] Timer			
.Mode	rw	Disabled	
.Reset	wo	Reset	

At the bottom right of the table area is a 'Refresh' button. At the bottom of the window are 'OK', 'Cancel', 'Apply', and 'Help' buttons. The status at the bottom left is 'Status: Offline'.

The parameter tab displays the sensor parameter settings, as well as enabling the user to read data from the sensor or teach the sensor by writing new values.

The parameter section is divided into three sections:

- Operation Configuration
- Sensor Configuration
- Counter/Timer Configuration
- Data Mapping Configuration

**Operation Configuration:** In this section, operators are able to change the function of the sensor outputs while operating in Standard IO mode and IO-Link Mode. The Triggered sub-section describes the parameters affecting the sensor output.

**Set-Point – Threshold** allows operators to enter the signal value required for the sensor output to turn ON (threshold) upon target detection. That means that the sensor signal level must be higher than the threshold for the output to turn ON. The default value for this parameter is 1000 with acceptable values between 505 and 12923.

**Polarity** changes the sensor output to operate as Light Operate (Non Inverted) and Dark Operate (Inverted) in relation to Pin 4. For complementary (Light and Dark Operate) models, changing this parameter from **Not Inverted** to **Inverted** swaps Pin 2 to function as Light Operate and Pin 4 to function as Dark Operate. For PNP and NPN models, changing this parameter from Light Operate to Dark Operate changes the function for both outputs PNP and NPN at the same time (for example, Changing from Not Inverted to Inverted makes both outputs (NPN and PNP) output to be Inverted.

**Hysteresis** displays the sensor output hysteresis value. The real value for hysteresis is this value shown on this parameter divided by 100.

**Pin 2 Mode** enables the operation of the output on pin 2 in IO-Link Mode. When connecting the sensor in IO-Link mode, pin 2 is disabled by default and could be changed to either operate as Light Operate or Dark Operate. This parameter is ideal for applications where the response time is critical for the application as IO-Link response time may not be fast enough to address the application needs.

**Sensor Configuration:** In this section, the operator is able to change when the sensor Indication LEDs should display marginal conditions. Two parameters are displayed: Margin Level Low Multiplier and Margin Level High Multiplier

**Margin Level – Low Multiplier** allows users to define when the green LED should start flashing to reflect a signal level that is below the threshold. The default value for this parameter is 0.8 with multiple selection options ranging from 0.5 to 0.8 in increments of 0.1X.

**Margin Level – High Multiplier** allows users to define when the green LED should stop flashing to reflect a signal level that is higher than the threshold. The

default value for this parameter is 1.5 with multiple selections that could reach a maximum of 20X. This means that the sensor will need to have at least 20 times the amount of light for the Green LED to stop flashing.

**Counter/Timer Configuration:** In this section, the operator is able to configure the sensor counter and timer functions. Two main parameter subsections are shown: Counter and Timer.

**Counter:** When enabled, the counter will count up on any transition from OFF to ON until a maximum of XXXX detections.

**Mode:** Allows users to enable or disable the counter function. This parameter is Read/Write.

**Reset:** Allows users to reset the counter function. This parameter is write only and can be enabled via the AOP or sending explicit messages. Refer to Appendix B for Index information.

**Counter:** This parameter is read only and displays the current count.

**Timer:** Measures the amount of time the output is present and absent up to a maximum period of four seconds.

**Mode:** Allows users to enable or disable the timer function. This parameter is Read/Write.

**Reset:** Allows users to reset the timer function. This parameter is write only and can be enabled via the AOP or sending explicit messages. Refer to Appendix B for Index information.

**Duration Triggered:** Displays the amount of time the target was detected. The maximum value that this parameter will display is 4095 ms.

**Duration Not Triggered:** Displays the amount of time the target was not detected. The maximum value that this parameter will display is 4095 ms.

**Data Mapping Configuration:** In this section, the operator is able to configure the combination of parameters that shall be displayed as process data. The 42EF RightSight process data consists of four bytes of data containing multiple parameters to be presented to the operator. The following process data maps are offered in the 42EF RightSight:

- Data Map 0 (Default): Triggered, Margin, Proximity, Gain, Signal
- Data Map 1: Triggered, Margin, Proximity, Gain, Contrast, Temp
- Data Map 2: Triggered, Margin, Proximity, Gain, Count
- Data Map 3: Triggered, Margin, Proximity, Gain, Duration

**Triggered:** Displays the status of the sensor output. This process data element is a bit that indicates when the target has been detected or not.

**Margin:** Displays the status of the sensor margin low alarm. This process data element is a bit that indicates to the operator if the sensor signal is marginal or unstable.

**Proximity:** Displays the status of the proximity alarm. This process data element is a bit that indicates if there is an object in close proximity to the threshold (below 1.0X) when the output is OFF.

**Gain:** Displays the excess gain above the sensor threshold to ensure reliable detection of the target.

**Signal:** Provides the raw measurement value of the amount of light reflected from the target.

**Contrast:** Displays the difference between the light signal levels that the sensor read the last time the output was ON versus the last time the output was OFF.

**Temp:** Displays the current internal temperature of the sensor. This process data element provides the internal temperature value and may increase or decrease depending on the influence of the ambient temperature on the internal sensor temperature. This element does not provide a direct and exact temperature measurement of the ambient temperature in the application.

**Count:** Displays the sensor counter value when enabled. This process data element can count up to 65535 and can be reset via explicit messaging to the appropriate index. Refer to Appendix B for additional information about index.

**Duration:** Displays the amount of time that the sensor output has been OFF (Duration Not Triggered) and ON (Duration Triggered).

## Diagnosis Tab

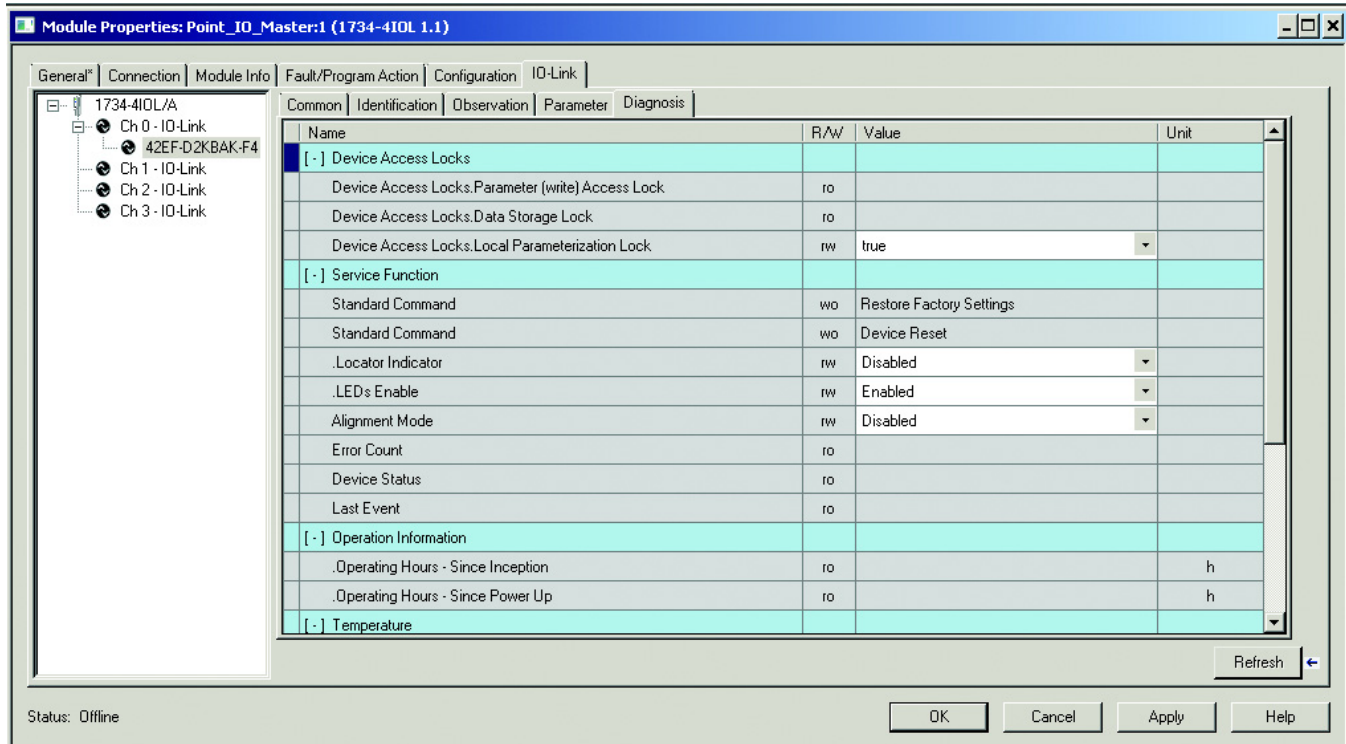

The Diagnosis Tab is divided into five sections:

- Device Access Locks,
- Service Function,
- Operating Information,
- Temperature, and
- Communications Characteristics

**Device Access Locks:** This section displays the Device Storage Lock and the user Interface Lock parameters. The Device Storage Lock is a read only parameter that describes that data storage on the sensor cannot be locked and the Local User Interface Lock keeps unauthorized operators from changing the sensor threshold setting when using the local sensitivity adjustment (when available).

**Service Function:** This section contains multiple parameters that allow operators to enable additional sensing functionality. This parameter can only be accessed through explicit messages as described in Chapter 11.

**Restore Factory Settings:** This is a write only command and sets the current sensor settings to their factory default values. This parameter can only be accessed via explicit message as defined in Chapter 11.

**Device Reset:** This is a write only command that performs the same function as cycling power in the sensor.

**Location Indicator:** This parameter activates the location indication sensor functionality. When enabled, the sensor user interface (green and orange LEDs) start flashing synchronously until the operator disables this function. This parameter is ideal for applications where the operator needs to locate a sensor in the application where there may be multiple sensors in close proximity.

**LEDs Enable:** This parameter allows operators to turn OFF or turn ON the User Interface LEDs (green and orange LEDs). This parameter is ideal for applications where turning OFF the LEDs is desired to accommodate the application.

**Alignment Mode:** This parameter changes the sensor user interface to operate in alignment mode. The alignment mode uses the green and orange LEDs of the sensor to visually indicate the strength of the light signal that is reflected back from the object. Upon entering this mode, the green LED will have a low visibility if no target is present (or no reflector is seen) and will slowly dim to a brighter state until a maximum brightness is reached depending on how much light is the target reflecting back to the sensor. When the maximum brightness is reached, the orange LED will change duty cycle from 10...90%. The table below describes the User Interface behavior while operating in Alignment Mode:

Green LED	Orange LED	Target State	Triggered Status
Low Intensity	Flashing at 1 Hz with 10% duty cycle	Not enough light reflection. Signal level is below threshold	Sensor Output is OFF
Medium Intensity	Flashing at 1 Hz with 10% duty cycle	Some light being reflected from target. Signal level is below threshold	Sensor Output is OFF
High Intensity	Flashing at 1 Hz with 90% duty cycle	Optimal amount of light reflected from target. Signal level is above threshold.	Sensor Output is ON

The alignment mode can be enabled for an indefinite amount of time or enabled for limited intervals of 120 and 240 seconds.

**Error Count:** Displaces the amount of errors.

**Device Status:** Displaces the status of the device.

**Last Event:** Displaces the code for the last event initiated by the sensor.

**Operation Information:** In this section, the operator is able to monitor the sensor operating hours since inception and power up.

**Operating Hours:** Since Inception: displays the total operating hours that the sensor has been running since the first time it was powered ON. This value is not lost during factory reset. The information displayed in this parameter is represented in hours.

**Operating Hours:** Since Inception: displays the total operating hours that the sensor has been running since the last time the sensor power was cycled. This value is reset to zero every time the sensor loses power.

**Temperature:** In this section, the operator is able to monitor the actual, minimum and maximum internal temperature of the sensor.

**Actual – Since Power Up:** Displays the current internal temperature of the sensor.

**Maximum – Since Power Up:** Displays the maximum sensor internal temperature since the last time the sensor was power cycled.

**Maximum: Since Inception:** Displays the maximum internal temperature of the sensor since the first time the sensor was ever powered ON. This value is retained and not lost during default factory reset.

**Minimum: Since Power Up:** Displays the minimum internal temperature of the sensor since the last time the sensor was power cycled.

**Minimum: Since Inception:** displays the maximum internal temperature of the sensor since the first time the sensor was ever powered ON. This value is retained and not lost during default factory reset.

**Communication Characteristics:** In this section of the Diagnosis Tab, the user can see read only (ro) values for the Minimum Cycle Time (response time of the sensor) and the Master Cycle Time (time that is used by the master to address the sensor) while in IO-Link mode. The user can also visualize the IO-Link Revision of the sensor in this section.

## Manage Parameter Differences between IO-Link Devices and Controllers

The Add-on Profile has a Refresh button that updates the read-only parameters for all channels with IO-Link devices. It also performs a Correlation check of the read-write parameters in all connected IO-Link devices and in the controller. Differences in parameter values can happen when the device configuration is changed externally, such as through a device console during operation. If there are differences after running a Correlation check, you can choose to use the parameters that are currently in the connected IO-Link device or to use the parameters that are stored in the controller. The changes can be done on a per channel basis.

Before you proceed with this task, take note that the Refresh function:

- Is only enabled in online mode.
- Is performed initially when the Add-on Profile is launched in online mode.



The alignment mode can be enabled for an indefinite amount of time or enabled for limited intervals of 120 and 240 seconds.

1. From the IO-Link tab on the working pane, click the Refresh button. If differences are detected in the RW values, a dialog box appears. The dialog box displays mismatched information per channel, including the parameters and the values present in the device and in the controller.

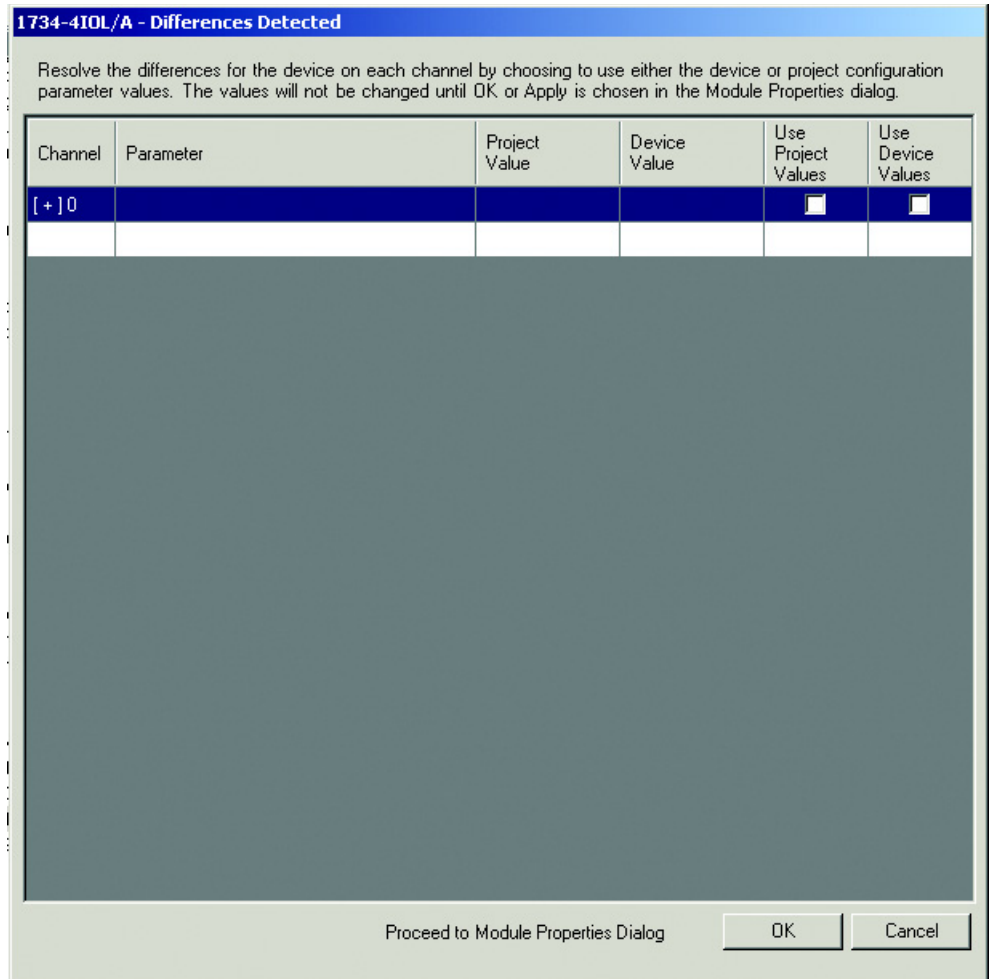

Communication errors (if applicable) are indicated in the dialog for each channel. A link becomes available for you to click to retry communication.



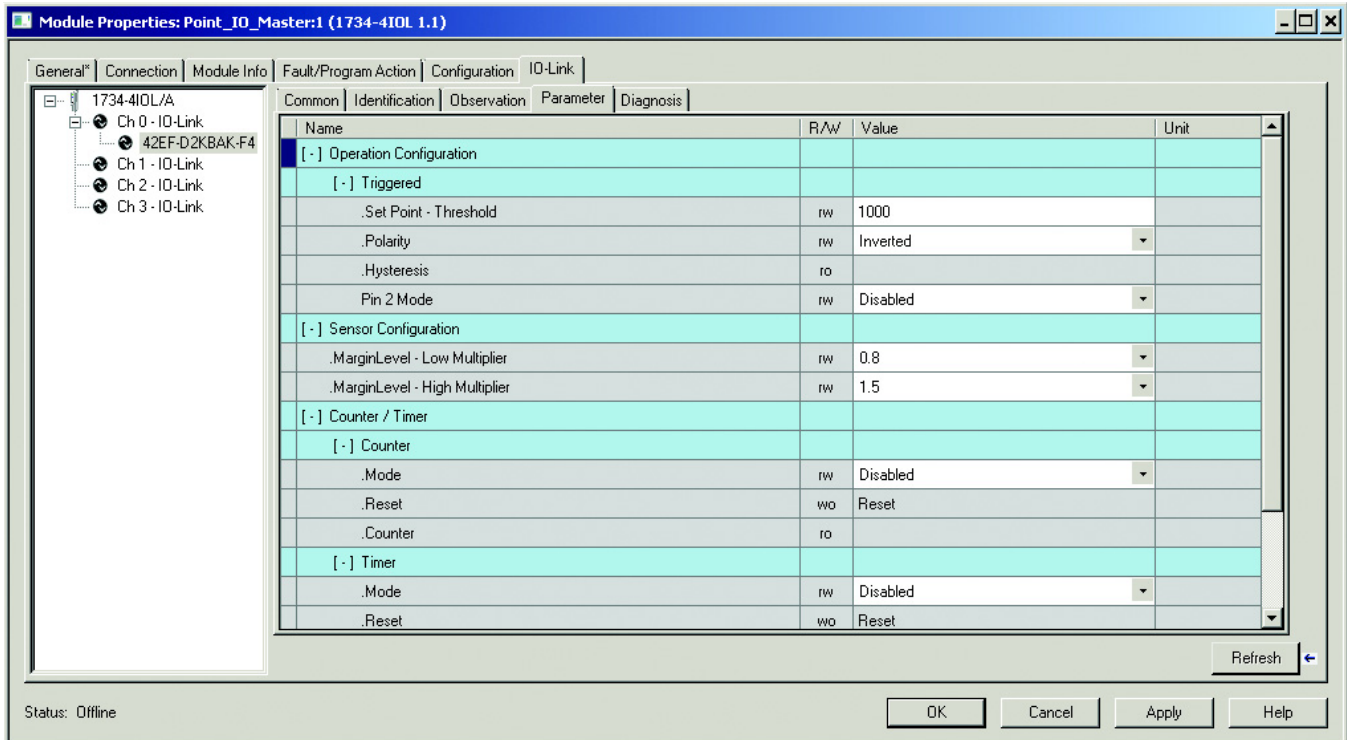

2. For each channel, select the check-box for the corrective action:
  - Use Device Values: Uploads the parameter values that are read from the connected IO-Link device to the project.
  - Use Project Values: Downloads the parameter values from the project to the connected IO-Link device.
3. Click "OK." If you click the "OK" button without fixing the errors, the read/write parameters of the affected channels are displayed.

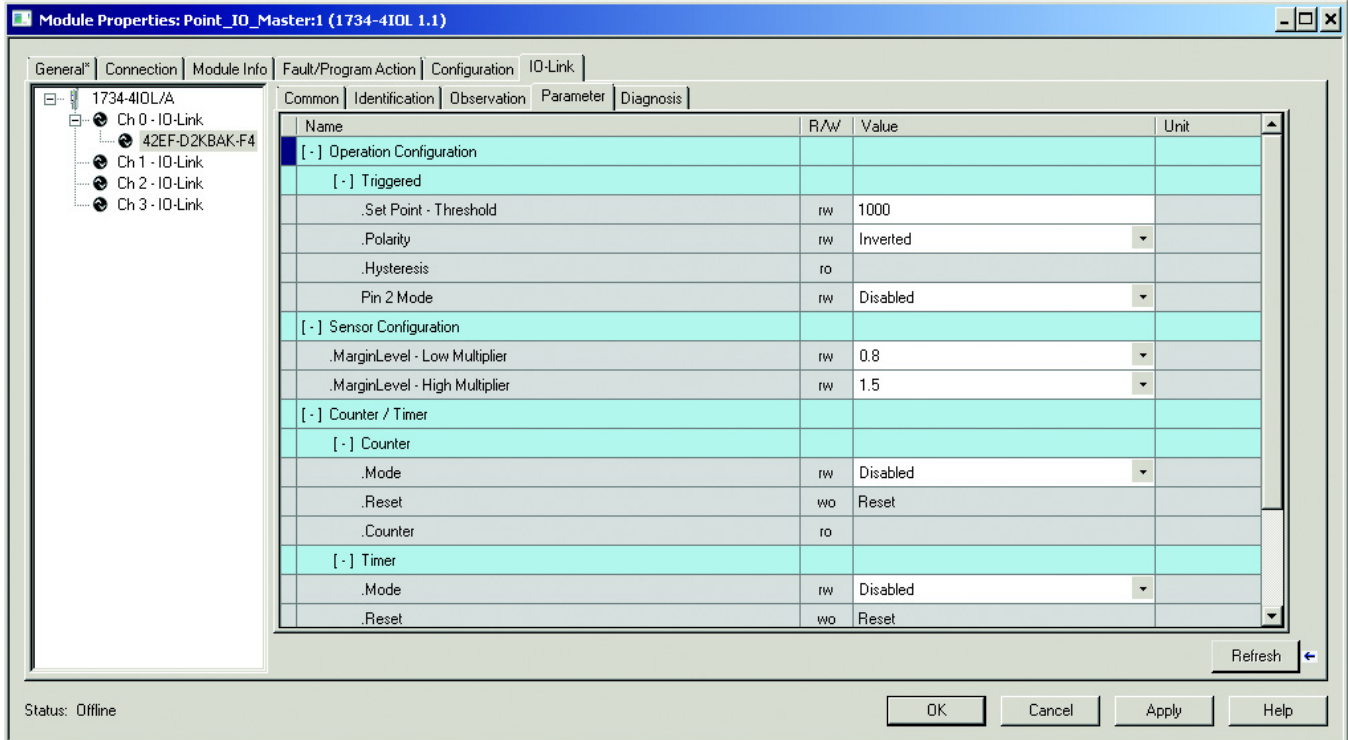

### Controller Tags

In the Controller Tag view, it is possible to view the status of the sensor process data (The process data values are not viewable in the Add-on Profile.).

Point_IO_Master:1:I.Ch0Triggered	0	Decimal	BOOL
Point_IO_Master:1:I.Ch0MarginLowAlarm	0	Decimal	BOOL
Point_IO_Master:1:I.Ch0ProximityAlarm	0	Decimal	BOOL
Point_IO_Master:1:I.Ch0Gain	0	Decimal	INT
Point_IO_Master:1:I.Ch0SignalStrength	0	Decimal	DINT

**Triggered:** This process bit toggles between one or zero depending on the polarity configuration when the sensor detects the target or not. For diffuse sensors, this bit displays a zero by default when no target is present and a one when target is present. For Polarized Retroreflective and Transmitted Beam sensors this bit displays a one by default and a zero when the target is blocking the reflector and the target.

**MarginLowAlarm:** This process bit toggles between one and zero to indicate if there is enough margin to ensure reliable target detection. This bit will be one when the target is marginal (signal strength is above 0.5X and below 2X) and zero when the light levels are above the operating margin if the triggered bit is active. The table below describes the significance of both bits when evaluated together:

Triggered	MarginLowAlarm	Description
0	0	No target is present
0	1	No target present, item in background is very close to the sensor threshold
1	0	Target is present and sensor signal is not marginal
1	1	Target is present and signal strength is marginal ( $0.5x < \text{signal} < 2x$ )

**Proximity:** Displays the status of the proximity alarm. This process data element is a bit that indicates if there is an object in close proximity to the threshold (below 1.0X) when the output is OFF.

**Gain:** Displays the excess gain above the sensor threshold to ensure reliable detection of the target.

**Signal:** Provides the raw measurement value of the amount of light reflected from the target.

## Troubleshooting

This guide is meant to help resolve common issues that occur when setting up the 42EF.

### Checklist

Error	Cause	Remedy
Power indicator LED does not light up	The power supply is switched off.	Check to see if there's a reason for it to be switched off (installation or maintenance work, and so on). Switch on the power supply if appropriate.
Power indicator LED does not light up	The 4-pin M12 plug is not connected to the connector on the sensor	Connect the 4-pin M12 plug to the sensor and tighten the cap nut by hand.
Power indicator LED does not light up	Wiring fault in the splitter or control cabinet.	Check the wiring carefully and repair any wiring faults.
“Operator indicator” LED does not light up	Supply cable to the sensor is damaged.	Replace the damaged cable.
No IO-Link connection to the device	The C/Q communication port on the sensor is not connected to the IO-Link master	Make sure that the C/Q communication port is connected to the IO-Link master.
No IO-Link connection to the device	No power supply	See error “Operator indicator” LED does not light up.
Push button does not respond to user interface	Local operation has been de-activated.	Activate local operation.

## Installing the Add-on Profile

### Introduction

This appendix shows how to install the IO-Link Add-on Profile (AOP) with the RSLogix™ 5000 program. Add-on Profiles are files that users add to their Rockwell Automation® library. These files contain the pertinent information for configuring a device that is added to the Rockwell Automation network.

The Add-on Profile simplifies the setup of devices because it presents the necessary fields in an organized fashion. The Add-on Profile allows for set up and configuration of systems in a quick and efficient manner.

The Add-on Profile is a folder that contains numerous files for the device. It comes as an installation package.

### Performing the Installation

1. Download the latest IO-Link AOP file from the Add-on Profiles website.  
<https://download.rockwellautomation.com/esd/download.aspx?downloadid=addonprofiles>
2. Extract the AOP zip file, open the folder, and execute the “MPSetup” application file.



3. Select "Next" in order to install the IO-Link module profiles, accept the license agreements, select "Next" and follow the module-profiles installation wizard.

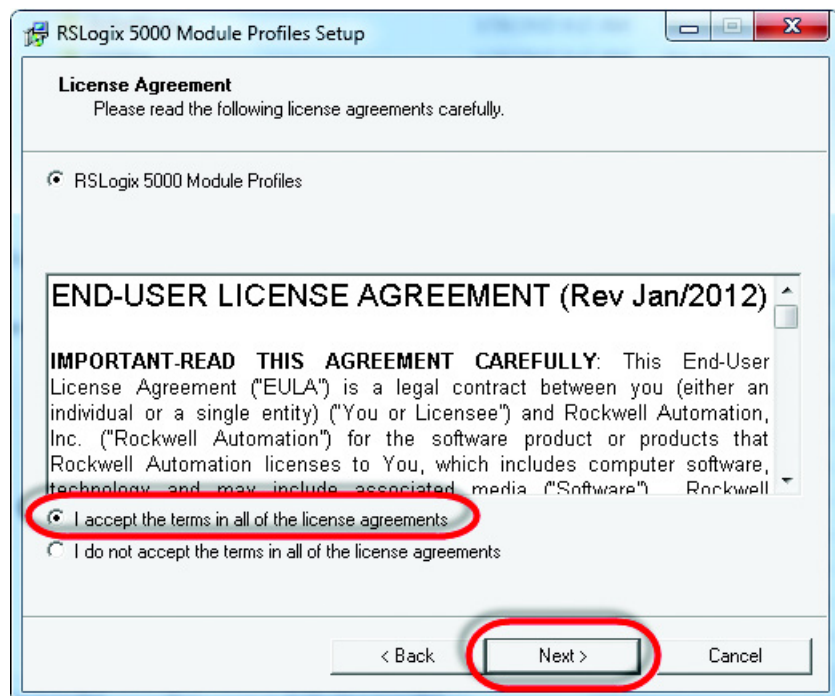
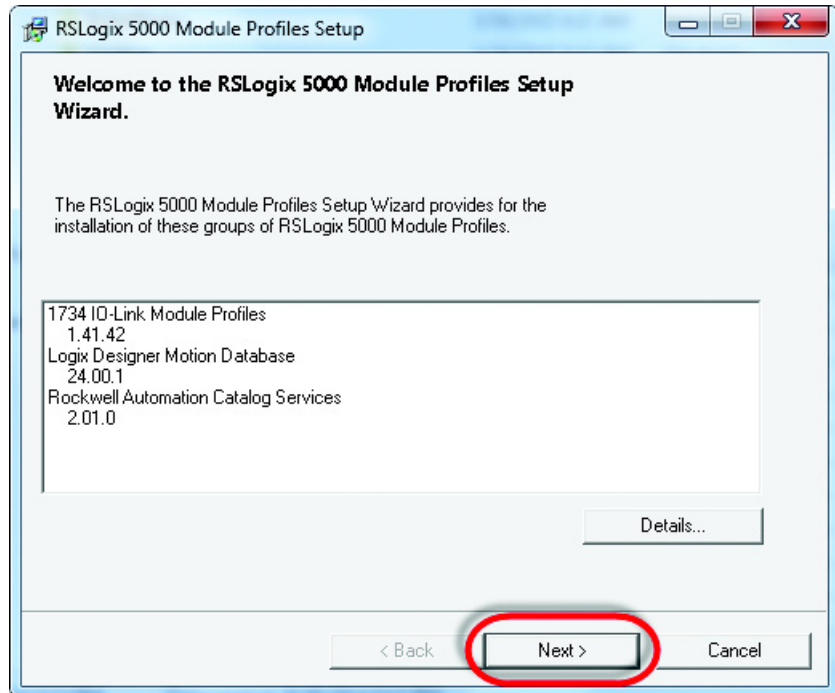

4. Be sure the “Install” option is selected, select “Next,” review the install details and select “Install.”

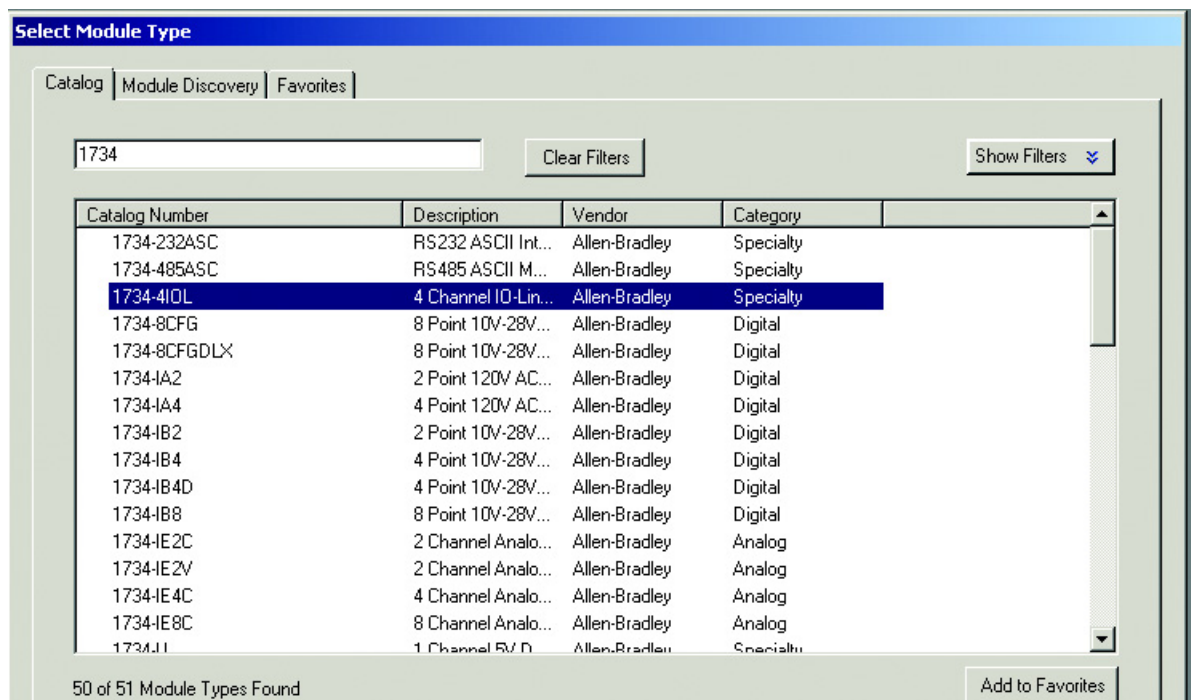
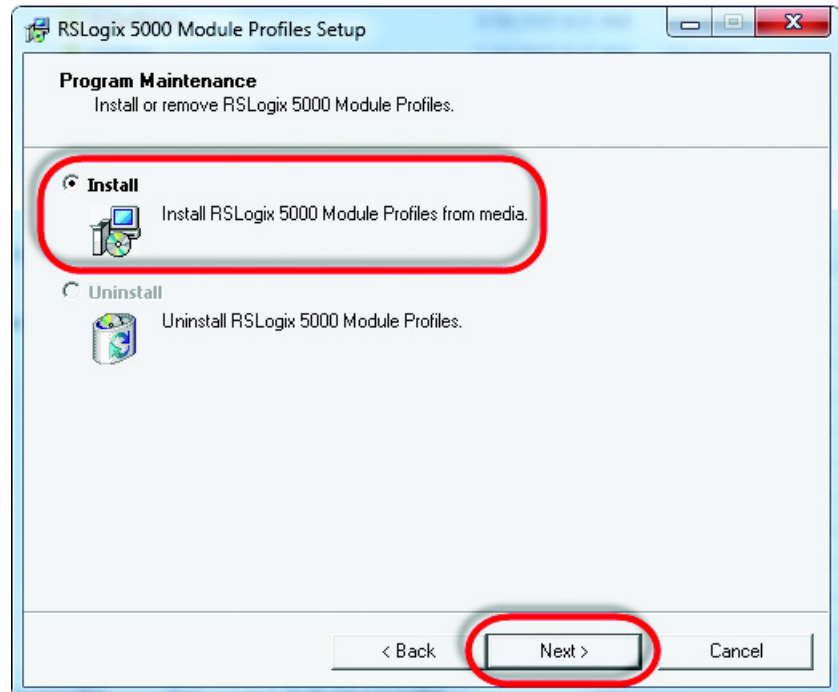

5. The installation process begins. The process may take several minutes. Once completed the “Next” button is available, select “Next.”

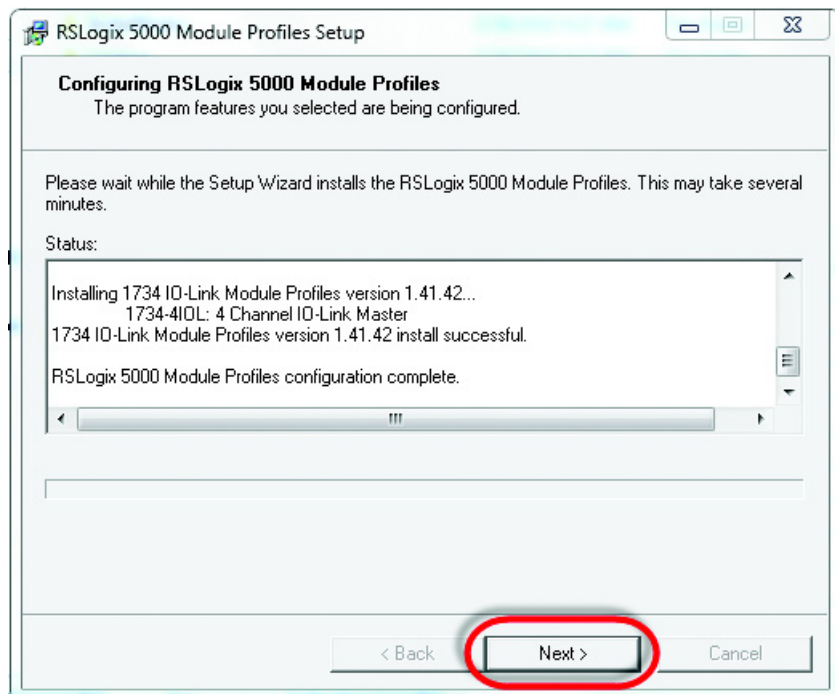
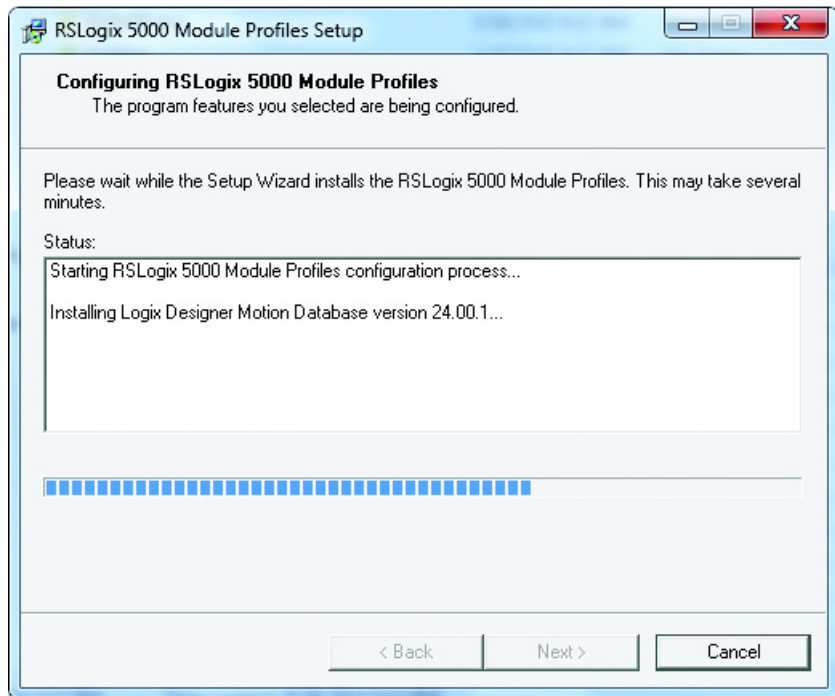



6. Select “Finish” and review the release notes for any additional information. The IO-Link AOP installation is completed.

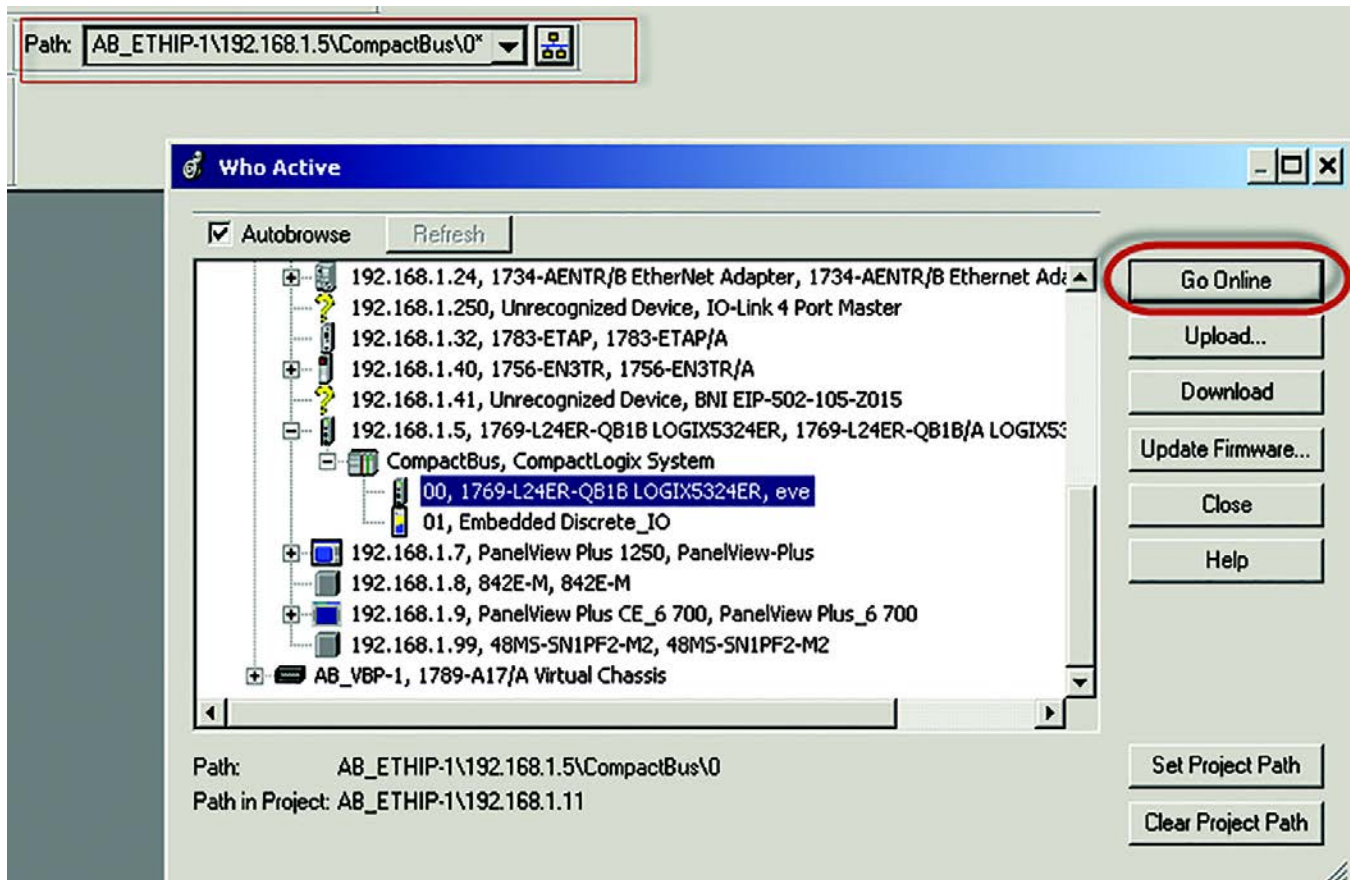

## Device Parameters

When using Explicit Messages to Read/Write parameter values from/to the 42EF, it's important to know the Index Number, Data Type, and Size of the Data that is transmitted/received in the message. The Identification table provides this information for each of the Device Parameters.

### Identification Tab

Parameter Name	Index Hex(Dec)	Sub-Index Hex (Dec)	Access	Default	Allowed Value	Data Type (Length )
<b>Device Information</b>						
Vendor Name	0x10(16)	0x00(0)	RO	Allen-Bradley	Allen-Bradley	StringT
Product Name	0x12(18)	0x00(0)	RO	Product Catalog Number 42EF-D2xxx-x4 or 42EF-P2xxx-x4	42EF-x2xxx-xx	StringT
Product ID	0x13(19)	0x00(0)	RO	42EF-D2xxx-x4 Series D or 42EF-P2xxx-x4 Series D	42EF-xxxx-xx	StringT
Product Text	0x14(20)	0x00(0)	RO	<u>42EF</u> Diffuse, P-Retro	Right Sight Photoelectric Sensor	StringT
Serial Number	0x15(21)	0x00(0)	RO		-	StringT
<b>User Specific Information</b>						
Application Specific Tag	0x18(24)	0x00(0)	RW	0	-	StringT
User Tag 1	0xC0(192)	0x00(0)	RW	0	-	UIntegerT bitLength=32
User Tag 2	0xC1(193)	0x00(0)	RW	0	-	UIntegerT bitLength=16
<b>Revision Information</b>						
Hardware Revision	0x16(22)	0x00(0)	RO	1.0	-	StringT
Firmware Revision	0x17(23)	0x00(0)	RO	1.0	-	StringT

## Observation Tab

Parameter Name	Index Hex(Dec)	Sub-Index Hex (Dec)	Access	Default	Allowed Value	Data Type (Length )
<b>Device Monitoring</b>						
.SignalStrength On	0x56(86)	0x01(1)	RO	-	0-65,535	UIntegerT(RecordT) bitLength=16 bitOffset=16
.SignalStrength Off	0x56(86)	0x02(2)	RO	-	0-65,536	UIntegerT(RecordT) bitLength=16 bitOffset=0
Contrast	0x57(87)	0x00(0)	RO	-	0-255	UIntegerT bitLength=8
Excess Gain	0x59(89)	0x00(0)	RO	-	0-255	UIntegerT bitLength=8
Gain (only for 42EF polarized retroreflective)	0x59(89)	0x00(0)	RO	-	0-255	UIntegerT bitLength=8

## Parameter Tab

Parameter Name	Index Hex(Dec)	Sub-Index Hex (Dec)	Access	Default	Allowed Value	Data Type (Length)
<b>User Interface Configuration</b>						
<b>Operation Configuration</b>						
<b>Triggered1(or Triggered)</b>						
.Set Point - Threshold	0x3C(60)	0x01(1)	RW	1000	505-12923	UInteger(RecordT) bitLength=16 bitOffset=16
.Polarity	0x70(112)	0x01(1)	RW	1= Inverted	0 = Not Inverted, 1 = Inverted	Boolean (RecordT) bitLength=48 bitOffset=40
.Hysteresis	0x3D(61)	0x03(3)	RO	1650		UInteger(RecordT) bitLength=16 bitOffset=0
Pin 2 Mode	0x60(96)	0x00(0)	RW	0 = Disabled	0 = Disabled 1 = Light Operate 2 = Dark Operate	UInteger bitLength=8
<b>Sensor Configuration</b>						
.MarginLevel - Low Multiplier	0x58(88)	0x01(1)	RW	4 = 0.8	0 = 0.5 1 = 0.6 2 = 0.6 3 = 0.7 4 = 0.8	UInteger(RecordT) bitLength=8 bitOffset=8
.MarginLevel - High Multiplier	0x58(88)	0x02(2)	RW	1 = 1.5	0 = 1.0 1 = 1.5 2 = 2.0 3 = 5.0 4 = 10.0 5 = 15.0 6 = 20.0	UInteger(RecordT) bitLength=8 bitOffset=0
<b>Counter/Timer</b>						
<b>Counter</b>						
Mode	0x5D(93)	0x01(1)	RW	0 = Disabled	0 = Disabled 1 = Enabled	UInteger(RecordT) bitLength=8 bitOffset=24
.Reset	0x5D(93)	0x02(2)	WO	-	1 = Reset	UInteger(RecordT) bitLength=8 bitOffset=16
.Counter	0x5D(93)	0x03(3)	RO	0	0-65,535	UInteger(RecordT) bitLength=16 bitOffset=0

## Parameter Tab (continued)

Parameter Name	Index Hex(Dec)	Sub-Index Hex (Dec)	Access	Default	Allowed Value	Data Type (Length)
<b>Timer</b>						
.Mode	0x5C(92)	0x01(1)	RW	0 = Disabled	0 = Disabled 1 = Enabled	UInteger(RecordT) bitLength=8 bitOffset=40
.Reset	0x5C(92)	0x02(2)	WO	-	1 = Reset	UInteger(RecordT) bitLength=8 bitOffset=32
.DurationTriggered	0x5C(92)	0x03(3)	RO	0	0-4,095	UInteger(RecordT) bitLength=12
.DurationNotTriggered	0x5C(92)	0x04(4)	RO	0	0-4,095	UInteger(RecordT) bitLength=12
<b>Data Mapping Cofiguration</b>						
.Mode	0x50(80)	0x01(1)	RW	0 = Triggered,Margin, Proximity,Gain,Si gnal,	0 = TriggerMarginLowAlarmProximityAlarmExcessGainLevel ReceivedSignalStrength, 1 = TriggerMarginLowAlarmProximityAlarmExcessGainLevel ContrastLevelTemperature, 2 = TriggerMarginLowAlarmProximityAlarmExcessGainLevel CounterValue, 3 = TriggerMarginLowAlarmProximityAlarmOnDurationOff Duration	UInteger(RecordT) bitLength=8 bitOffset=0

## Diagnostic Tab

Parameter Name	Index Hex(Dec)	Sub-Index Hex (Dec)	Access	Default	Allowed Value	Data Type (Length)
<b>Device Access Locks</b>						
Device Access Locks.Parameter (Write) Access Locks	0x0C(12)	0x00(0)	RO	0=False	0=False	Boolean(RecordT) bitOffset=0
Device Access Locks.Data Storage Lock	0x0C(12)	0x01(1)	RO	0=False	0=False	Boolean(RecordT) bitOffset=1
Device Access Locks.Local Parameterization Lock	0x0C(12)	0x02(2)	RW	0=False	0=False 1=True	Boolean(RecordT) bitOffset=2
<b>Service Function</b>						
<Standard Command> Device Reset	0x02(2)	0x00(0)	WO	Button = "Device Reset" Button = 128	Button = "Device Reset" Button = 128	
<Standard Command> Restore Factory Settings	0x02(2)	0x82(130)	WO	Button = "Restore Factory Settings"	Value = 130	UIntegerT bitLength=8
.Locator Indicator	0x5E(94)	0x01(1)	RW	0= Disabled	0 = Disable(d) 1 = Enable(d)	UInteger(RecordT) bitLength=8 bitOffset=8
.LEDs Enable	5E(94)	0x0(2)	RW	1= Enabled	0 = Disable(d) 1 = Enable(d)	UInteger(RecordT) bitLength=8 bitOffset=0
<b>Device Status</b>						
Alignment Mode	0x5F(95)	0x00(0)	RW	0= Disabled	0 = Disable(d) 1 = Enable(d)	UIntegerT bitLength=8
Error Count	0x20(32)	0x00(0)	RO	-	-	UIntegerT bitLength=16
Device Status	0x24(36)	0x00(0)	RO	'0 = Device is OK	0 = Device is OK 1 = Maintenance required 2 = Out of specification 3 = Funtional chek 4 = Failure	UIntegerT bitLength=8
Last Event	0x6E(110)	0x00(0)	RO	0	0-65,535	UIntegerT bitLength=16
<b>Operation Information</b>						
.Operating Time - Since Inception	0x5B(91)	0x01(1)	RO			UInteger(RecordT) bitLength=32 bitOffset=32
.Operating Time - Since Power Up	0x5B(91)	0x0(2)	RO			UInteger(RecordT) bitLength=32 bitOffset=0

## Diagnostic Tab (continued)

Parameter Name	Index Hex(Dec)	Sub-Index Hex (Dec)	Access	Default	Allowed Value	Data Type (Length)
<b>Temperature</b>						
.Actual - Since Power Up	0x5A(90)	0x01(1)	RO	-	-40 - 125	IntegerT(RecordT) bitLength=8 bitOffset=32
.Maximum - Since Power Up	0x5A(90)	0x02(2)	RO	-	-40 - 125	IntegerT(RecordT) bitLength=8 bitOffset=24
.Maximum - Since Inception	0x5A(90)	0x02(3)	RO	-	-40 - 125	IntegerT(RecordT) bitLength=8 bitOffset=16
.Minimum Since Power Up	0x5A(90)	0x04(4)	RO	-	-40 - 125	IntegerT(RecordT) bitLength=8 bitOffset=8
.Minimum - Since Inception	0x5A(90)	0x05(5)	RO	-	-40 - 125	IntegerT(RecordT) bitLength=8 bitOffset=0
<b>Communication Characteristics</b>						
Direct Parameters 1.Min Cycle Time	0x00(0)	0x03(3)	RO	20	2 ms	UIntegerT bitLength=8 bitOffset=104
Direct Parameters 1. Master Cycle Time	0x00(0)	0x02(2)	RO	20	2 ms	UIntegerT bitLength=8 bitOffset=112
Direct Parameters 1.IO-Link Revision ID	0x00(0)	0x05(5)	RO	0x11		UIntegerT bitLength=8 bitOffset=88

## Process Data

Parameter Name	Sub-Index	Access	Default	Allowable Values	Data Type (Length)
Triggered	Depends on mode	RO	0 = Not Triggered	0 = Not Triggered 1 = Triggered	BooleanT bitLength=32 bitOffset=0
MarginLowAlarm	Depends on mode	RO	0 = Off	0 = Off 1 = On	BooleanT bitLength=32 bitOffset=1
ProximityAlarm	Depends on mode	RO	0 = Off	0 = Off 1 = On	BooleanT bitLength=32 bitOffset=2
Gain	Depends on mode	RO	n/a	0 to 255	UIntegerT bitLength=8 bitOffset=8
Contrast	Depends on mode	RO	n/a	0 to 255	UIntegerT bitLength=8 bitOffset=16
TemperatureInternal	Depends on mode	RO	n/a	-40 to 125	BooleanT bitLength=32 bitOffset=24
DurationTriggered	Depends on mode	RO	n/a	0 to 4095	UIntegerT bitLength=12 bitOffset=20
DurationNotTriggered	Depends on mode	RO	n/a	0 to 4095	BooleanT bitLength=32 bitOffset=8
SignalStrength	Depends on mode	RO	n/a	0 to 65535	UIntegerT bitLength=16 bitOffset=16
Count	Depends on mode	RO	n/a	0 to 65535	UIntegerT bitLength=16 bitOffset=16

Process Data parameter allows a maximum of four bytes.



---

# Message Structure and Configuration Example Configuration Examples

## Configuring a Message Instruction

This appendix provides additional information and examples that explain how to configure a Message Instruction.

In the examples that we show, we are assuming the use of the ControlLogix® controller. A ControlLogix controller can accommodate both downloading Explicit Message Requests and uploading Explicit Message Responses. The Message Instruction dialog blocks must be formatted as shown in the examples shown.

### Example Format of a Read Message

In this example the steps necessary to Read the IO-Link Parameter value for “Vendor Name: from the 42EF are shown. The screen capture that is shown is the Message Configuration dialog box that shows all of the information needed to complete this task. To open this dialog box, click the blue square box in the Message Instruction.

Some of the data that are required to complete the Message Configuration dialog box comes from [Appendix B](#). [Appendix B](#) shows the Index Number, Data Type, and Size of all the Parameters that are available in the 42EF. To complete the dialog box, the Service Code and Source Length needs to be provided.

A table of the different Read and Write Service Codes and their associated Source Lengths are shown on [page 68](#).

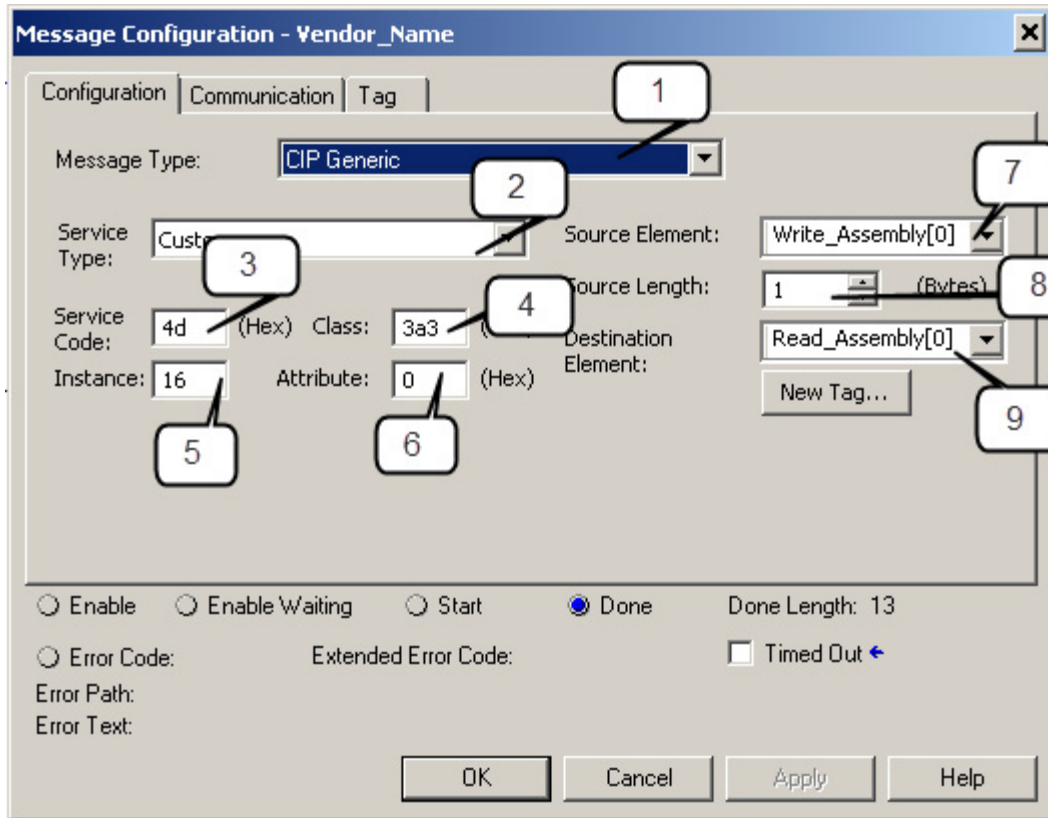

The following table identifies the data that are required to complete the Message Configuration dialog box to Read the “Vendor Name” from the 42EF:

<b>Box</b>	<b>Description</b>	<b>Value</b>
1	<b>Message Type</b> The message type is CIP Generic.	CIP Generic
2	<b>Service Type</b> The service type is Custom.	Custom
3	<b>Service Code</b> Established from Service Code Table.	4D
4	<b>Class</b> The class is 3a3.	3a3
5	<b>Instance</b> Established from Appendix A. Identifies the Index for the Parameter being read.	16
6	<b>Attribute</b> The Attribute value is 0.	0
7	<b>Source Element</b> Contains the name of the tag of the channel number to be read.	Write_Assembly[0]
8	<b>Source Length</b> This box contains the number of bytes of service data to be sent or received in message. Defined in Data Structure Tables.	1 byte
9	<b>Destination Element</b> First element of the destination Array.	Read_Assembly[0]

## Read Data from the Sensor

Once the data in the Message Instruction dialog box has been populated, trigger the rung of logic that contains the message instruction and the “Vendor Name” is read from the 42EF and copied into the “Read\_Assembly” Array. When viewed as ASCII the name Allen-Bradley is displayed.

[-] Recipe_1	{...}	{...}	Decimal
[-] Read_Assembly	{...}	{...}	ASCII
[+] Read_Assembly[0]	'A'		ASCII
[+] Read_Assembly[1]	'l'		ASCII
[+] Read_Assembly[2]	'l'		ASCII
[+] Read_Assembly[3]	'e'		ASCII
[+] Read_Assembly[4]	'n'		ASCII
[+] Read_Assembly[5]	'-'		ASCII
[+] Read_Assembly[6]	'B'		ASCII
[+] Read_Assembly[7]	'r'		ASCII
[+] Read_Assembly[8]	'a'		ASCII
[+] Read_Assembly[9]	'd'		ASCII
[+] Read_Assembly[10]	'l'		ASCII
[+] Read_Assembly[11]	'e'		ASCII
[+] Read_Assembly[12]	'y'		ASCII
[+] Read_Assembly[13]	'\$00'		ASCII
[+] Read_Assembly[14]	'\$00'		ASCII

## Example Format of a Write Message

It is possible to Write a unique name to the 42EF sensor. This Parameter is called “Application Specific Name.” In [Appendix B](#) we can find the Index Number for this Parameter (24) and the maximum length of the String (32 characters). Each character is equivalent to one byte. This example shows the steps necessary to write “Test” to the Application Specific Name index.

The source element Array is “Write\_Assembly,” byte zero is the channel followed by the data to be written.

[-] Write_Assembly	{...}	{...}	ASCII
[+] Write_Assembly[0]	'\$00'		ASCII
[+] Write_Assembly[1]	'T'		ASCII
[+] Write_Assembly[2]	'E'		ASCII
[+] Write_Assembly[3]	'S'		ASCII
[+] Write_Assembly[4]	'T'		ASCII
[+] Write_Assembly[5]	'\$00'		ASCII
[+] Write_Assembly[6]	'\$00'		ASCII

The screen capture that is shown is the Message Configuration dialog box that shows all of the information that is needed to Write to the Application Specific

Name Parameter in the 42EF. To open the Message Instruction dialog box, click the blue square box in the Message Instruction.

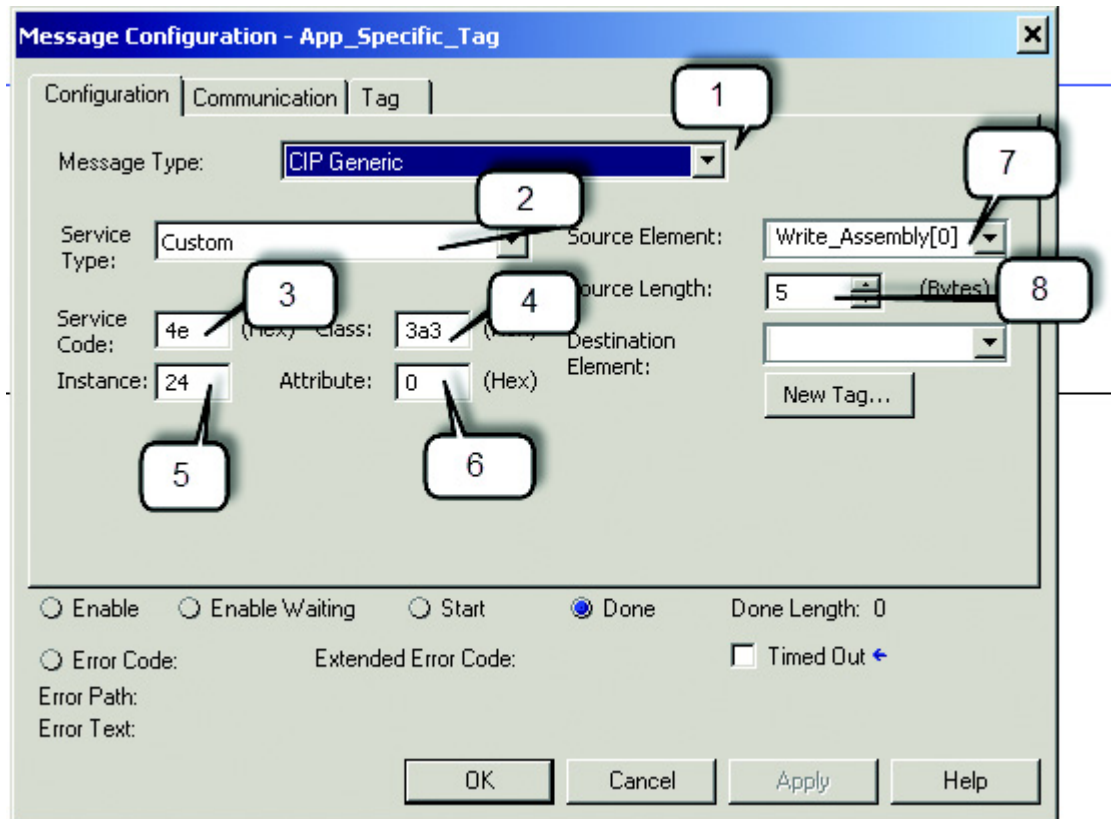

The following table identifies the data that are required to complete the Message Configuration dialog box to Write “Test” to the Application Specific Name in the 42EF:

Box	Description	Value
1	<b>Message Type</b> The message type is CIP Generic.	CIP Generic
2	<b>Service Type</b> The service type is Custom.	Custom
3	<b>Service Code</b> Established from Service Code Table.	4E
4	<b>Class</b> The class is 3a3.	3a3
5	<b>Instance</b> Established from Appendix A. Identifies the Index for the Parameter being read.	24
6	<b>Attribute</b> The Attribute value is 0.	0
7	<b>Source Element</b> Contains the name of the first tag of the data array to be written.	Write_Assembly[0]
8	<b>Source Length</b> This box contains the number of bytes of service data to be sent or received in a message. Defined in Data Structure Tables.	5 bytes
9	<b>Destination Element</b> N/A	N/A

### Validation of Write

Once the data in the Message Instruction dialog box has been populated; trigger the rung of logic that contains the message instruction and “Test” is written from the “Write\_Assembly” to the Application Specific Name Parameter Index in the 42EF.

The data is validated by either reading the value of Index 24 in the sensor or by viewing the 1734-4IOL configuration. To view the configuration of the 1734-4IOL follow these steps:

1. Click the 1734-4IOL in the IO Configuration.
2. A pop-up box is displayed, advising that changes within the sensor have been detected. Expand the settings and to see that the Application Specific Name has changed to Test.

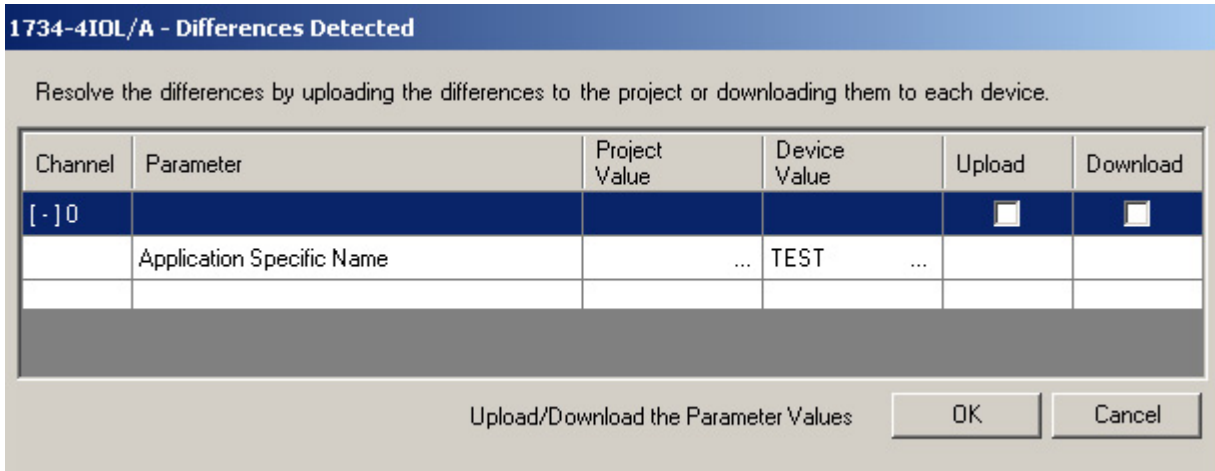

3. Click “Upload” then “OK” and the new parameter values are uploaded into the controller. The new Application Specific Name can be seen when viewing the Identification Tab of the AOP for the 42EF sensor.

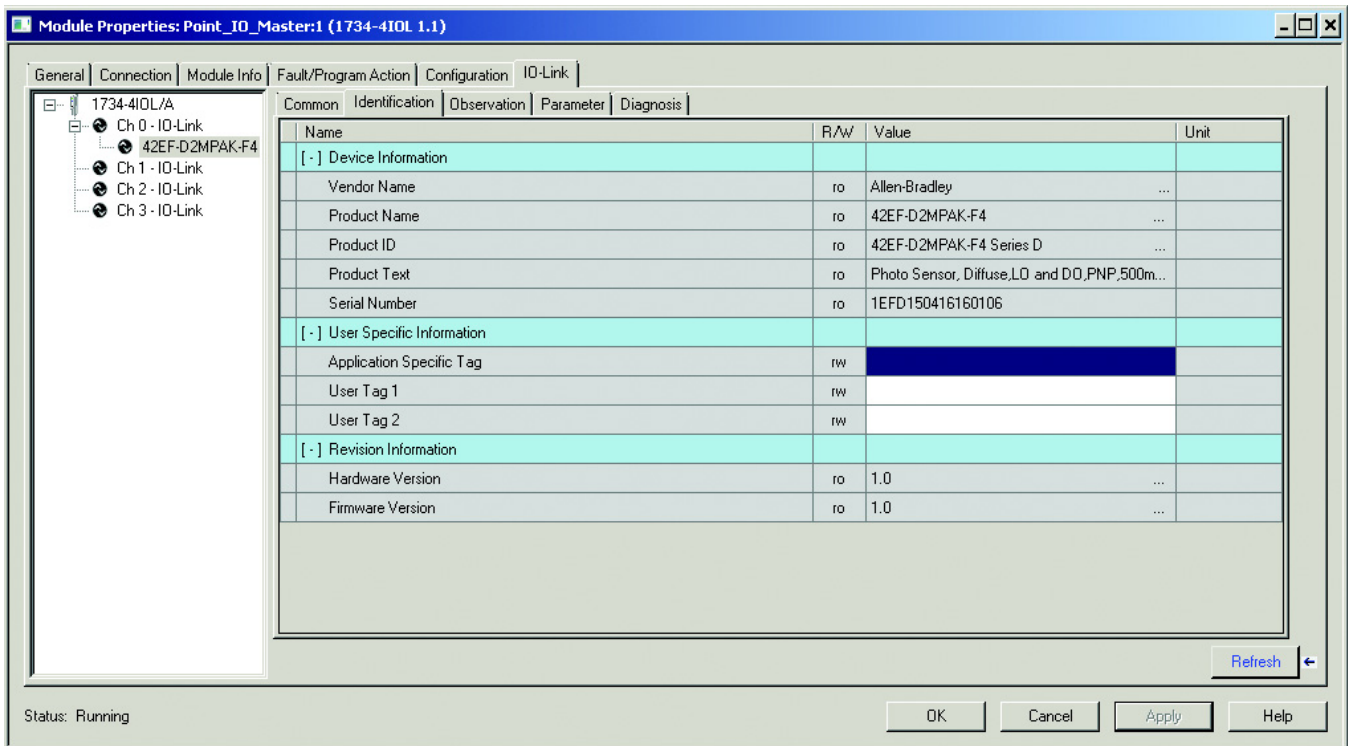

## Service Code

The table that is shown is used to determine the service code that is needed for a specific Message Instruction.

Service Code (Hex)	Need in Implementation		Service Name	Description of Service
	Class	Instance		
4B	Required	Required	Read Subindex	Reads a parameter value from the IO-Link device
4C	N/A	Required	Write Subindex	Writes a parameter value from the IO-Link device
4D	Required	Required	Read Subindex	Reads an entire index (all parameters within an index) from the IO-Link device (uses subindex 0)
4E	N/A	Required	Write Subindex	Writes an entire index (all parameters within an index) from the IO-Link device (uses subindex 0)

## Source Length: from Data Structure Tables

The tables below can be used to determine the source length that is based on the service code that is used and the number of bytes being written.

### Read Subindex (4B)

#### Message Data Format:

Byte 0	Byte 1
Subindex Number	Channel Number

Source Length= 2 bytes

### Read Subindex (4C)

#### Message Data Format:

Byte 0	Byte 1	Byte 2	Byte 3
Subindex Number	Channel Number	Data 0	Data 1

Source Length= 2 bytes + Number of bytes of data being written

### Read Subindex (4D)

#### Message Data Format:

Byte 0
Channel Number = 1 byte

Source Length= 1 byte

### Write Index (4E)

#### Message Data Format:

Byte 0	Byte 1	Byte 2	Byte 3
Channel Number	Data 0	Data 1	Data 3

Source Length= 1 byte + Number of bytes of data being written



## Error Codes and Events

When an event occurs, the device signals the presence of the event to the master. The master then reads out the event. Events can be error messages and warnings/maintenance data. Error messages are transmitted from the device to the controller via the IO-Link master. The transmission of device parameters or events occurs independently from the cyclic transmission of process data.

### Error Codes

Error code	Instance	Code	Note
No error	APP	ZERO	Only applies for response telegram
Unspecific application fault	APP	0x8000	
Invalid index	APP	0x8011	
Invalid subindex	APP	0x8012	
Service temporarily unavailable	APP	0x8020	
Service temporarily unavailable (control)	APP	0x8021	
Service temporarily unavailable (sensor)	APP	0x8022	
Access denied	APP	0x8023	Write attempt to read-only address
Invalid value range, parameter	APP	0x8030	
Parameter value too large	APP	0x8031	
Parameter value too small	APP	0x8032	
Application error	APP	0x8081	Application does not respond
Application not ready	APP	0x8082	Application does not respond

## Events

Name	Bit	Name >>>	42EF						
		Description >>>	No Malfunction	Temperature			Hardware Fault	Voltage Overrun	Short Circuit
				Fault Overload	Overrun	Underrun			
Event Code	-	See "1734-4IOL Events" tab	0x0000	0x4000	0x4210	0x4220	0x5000	0x5111	0x7710
Event Location	3	0 - Device application (Remote) 1 - Master application (Local)							
Event Mode 0	6	0 - Reserved 1 - Event single shot 2 - Event disappears 3 - Event appears	1	1	3	3	3	3	3
Event Mode 1	7				2	2	2	2	2
Event Qualifier	-	See "Event Qualifier" tab							
Event Sequence Count	-	1 to 255 (can never be 0)							
Event Source 0	0	0 - Unknown 1 - Physical Layer (PL) 2 - Data Layer (DL) 3 - Application Layer (AL) 4 - Application (APP) 5-7 - Reserved							
Event Source 1	1								
Event Source 2	2								
Event Type 0	4	0 - Reserved 1 - Notification 2 - Warning 3 - Error	1	1	3	2	3	2	3
Event Type 1	5								
Status Bit		0 - Device OK 1 - Device Fault	n/a	n/a	n/a	n/a	n/a	n/a	n/a

## Abbreviations

ADC	Automatic Device Configuration
AOI	Add-on Instruction
AOP	Add-on Profile
ASN	Application Specific Name
IEC	International Electrotechnical Commission
IODD	I/O Device Description
NEC	National Electric Code
QD	Quick Disconnect
RGB	Red, Green, Blue
SIO	Standard I/O
TB	Teach Background
TD	Teach Dynamic
TM	Teach Mark

## Rockwell Automation Support

Rockwell Automation provides technical information on the Web to assist you in using its products.

At <http://www.rockwellautomation.com/support> you can find technical and application notes, sample code, and links to software service packs. You can also visit our Support Center at <https://rockwellautomation.custhelp.com/> for software updates, support chats and forums, technical information, FAQs, and to sign up for product notification updates.

In addition, we offer multiple support programs for installation, configuration, and troubleshooting. For more information, contact your local distributor or Rockwell Automation representative, or visit <http://www.rockwellautomation.com/services/online-phone>.

## Installation Assistance

If you experience a problem within the first 24 hours of installation, review the information that is contained in this manual. You can contact Customer Support for initial help in getting your product up and running.

United States or Canada	1.440.646.3434
Outside United States or Canada	Use the <a href="#">Worldwide Locator</a> at <a href="http://www.rockwellautomation.com/rockwellautomation/support/overview.page">http://www.rockwellautomation.com/rockwellautomation/support/overview.page</a> , or contact your local Rockwell Automation representative.

## New Product Satisfaction Return

Rockwell Automation tests all of its products to help ensure that they are fully operational when shipped from the manufacturing facility. However, if your product is not functioning and needs to be returned, follow these procedures.

United States	Contact your distributor. You must provide a Customer Support case number (call the phone number above to obtain one) to your distributor to complete the return process.
Outside United States	Please contact your local Rockwell Automation representative for the return procedure.

## Documentation Feedback

Your comments will help us serve your documentation needs better. If you have any suggestions on how to improve this document, complete this form, publication [RA-DU002](#), available at <http://www.rockwellautomation.com/literature/>.

Allen-Bradley and Rockwell Automation are trademarks of Rockwell Automation, Inc.  
Trademarks not belonging to Rockwell Automation are property of their respective companies.

Rockwell Automation maintains current product environmental information on its website at <http://www.rockwellautomation.com/rockwellautomation/about-us/sustainability-ethics/product-environmental-compliance.page>.

Rockwell Otomasyon Ticaret A.Ş., Kar Plaza İş Merkezi E Blok Kat:6 34752 İçerenköy, İstanbul, Tel: +90 (216) 5698400

**[www.rockwellautomation.com](http://www.rockwellautomation.com)**

### Power, Control and Information Solutions Headquarters

Americas: Rockwell Automation, 1201 South Second Street, Milwaukee, WI 53204-2496 USA, Tel: (1) 414.382.2000, Fax: (1) 414.382.4444  
Europe/Middle East/Africa: Rockwell Automation NV, Pegasus Park, De Kleetlaan 12a, 1831 Diegem, Belgium, Tel: (32) 2 663 0600, Fax: (32) 2 663 0640  
Asia Pacific: Rockwell Automation, Level 14, Core F, Cyberport 3, 100 Cyberport Road, Hong Kong, Tel: (852) 2887 4788, Fax: (852) 2508 1846