

## PanelView 5310 Terminals

Catalog Numbers 2713P-T7WD1, 2713P-T7WD1-B, 2713P-T9WD1, 2713P-T9WD1-B, 2713P-T12WD1, 2713P-T12WD1-B

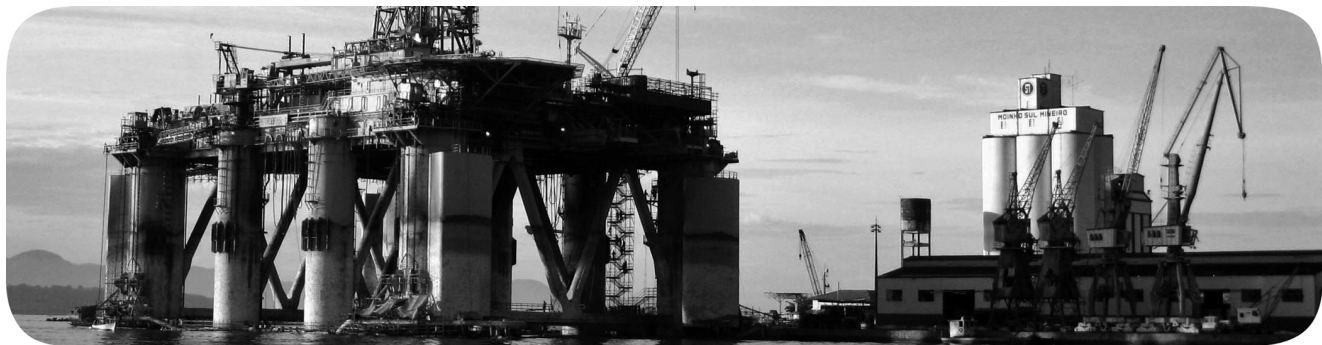

## Important User Information

Read this document and the documents listed in the additional resources section about installation, configuration, and operation of this equipment before you install, configure, operate, or maintain this product. Users are required to familiarize themselves with installation and wiring instructions in addition to requirements of all applicable codes, laws, and standards.

Activities including installation, adjustments, putting into service, use, assembly, disassembly, and maintenance are required to be carried out by suitably trained personnel in accordance with applicable code of practice.

If this equipment is used in a manner not specified by the manufacturer, the protection provided by the equipment may be impaired.

In no event will Rockwell Automation, Inc. be responsible or liable for indirect or consequential damages resulting from the use or application of this equipment.

The examples and diagrams in this manual are included solely for illustrative purposes. Because of the many variables and requirements associated with any particular installation, Rockwell Automation, Inc. cannot assume responsibility or liability for actual use based on the examples and diagrams.

No patent liability is assumed by Rockwell Automation, Inc. with respect to use of information, circuits, equipment, or software described in this manual.

Reproduction of the contents of this manual, in whole or in part, without written permission of Rockwell Automation, Inc., is prohibited.

Throughout this manual, when necessary, we use notes to make you aware of safety considerations.



**WARNING:** Identifies information about practices or circumstances that can cause an explosion in a hazardous environment, which may lead to personal injury or death, property damage, or economic loss.



**ATTENTION:** Identifies information about practices or circumstances that can lead to personal injury or death, property damage, or economic loss. Attentions help you identify a hazard, avoid a hazard, and recognize the consequence.

---

**IMPORTANT** Identifies information that is critical for successful application and understanding of the product.

---

Labels may also be on or inside the equipment to provide specific precautions.



**SHOCK HAZARD:** Labels may be on or inside the equipment, for example, a drive or motor, to alert people that dangerous voltage may be present.



**BURN HAZARD:** Labels may be on or inside the equipment, for example, a drive or motor, to alert people that surfaces may reach dangerous temperatures.



**ARC FLASH HAZARD:** Labels may be on or inside the equipment, for example, a motor control center, to alert people to potential Arc Flash. Arc Flash will cause severe injury or death. Wear proper Personal Protective Equipment (PPE). Follow ALL Regulatory requirements for safe work practices and for Personal Protective Equipment (PPE).

---

	<b>Preface</b>	
	Summary of Changes .....	7
	Package Contents .....	7
	Request Corresponding Source for Open Source Packages .....	8
	Product Firmware and Release Notes .....	8
	Additional Resources .....	9
	<b>Chapter 1</b>	
<b>Overview</b>	About the PanelView 5310 Terminals .....	11
	Hardware Features .....	12
	Operator Control .....	13
	Touch Gestures .....	13
	Studio 5000 Environment .....	14
	EtherNet/IP Communication .....	15
	Typical Configuration .....	15
	Catalog Number Explanation .....	16
	Product Selections .....	16
	Accessories .....	16
	Ethernet Cables .....	17
	<b>Chapter 2</b>	
<b>Install the PanelView 5310 Terminal</b>	Installation Precautions .....	20
	Environment and Enclosure Information .....	20
	Wiring and Safety Guidelines .....	21
	Outdoor Installation Recommendations .....	21
	Mounting Considerations .....	23
	Mounting Clearances .....	23
	Panel Guidelines .....	24
	Panel Cutout Dimensions .....	24
	Terminal Dimensions .....	25
	Prepare for Panel Mounting .....	26
	Mount the Terminal in a Panel .....	29
	Remove and Replace Power Terminal Block .....	32
	Connect Power .....	33
	Connect to a Network .....	34
	Ethernet Port .....	34
	Linear Network Topology .....	36
	Star Network Topology .....	36
	Initial Startup .....	37
	Update the Firmware before You Use the Terminal .....	37

<b>Configure Terminal Settings</b>	<p><b>Chapter 3</b></p> <p>Runtime Environment..... 39</p> <p>Enter Data With Virtual Keyboards ..... 41</p> <p>Log On to the Terminal ..... 43</p> <p>Log Off of the Terminal ..... 44</p> <p>Settings Menu ..... 44</p> <p>Configure the IP Address of the Terminal..... 46</p> <p style="padding-left: 20px;">Use DHCP to Assign an IP Address for the Terminal ..... 46</p> <p style="padding-left: 20px;">Assign a Static IP Address for the Terminal ..... 47</p> <p>Configure a DNS Address for the Terminal ..... 48</p> <p>Configure the Ethernet Port ..... 49</p> <p>View the Network Diagnostics ..... 50</p> <p>Export a Data Log..... 51</p> <p>Adjust the Brightness of the Display ..... 52</p> <p>Configure the Display Screen Saver ..... 53</p> <p>Calibrate the Touch Screen ..... 54</p> <p>Disable Downloads to the Terminal ..... 56</p> <p>Change the HMI Device Name ..... 57</p> <p>View the Firmware Revision ..... 58</p> <p>Display Terminal Diagnostics ..... 59</p> <p>Enable the VNC Server..... 60</p> <p>Load an Application from Removable Media ..... 61</p> <p>Reboot the Terminal ..... 62</p> <p>Change the Date and Time ..... 63</p> <p>View General Information for the Configured Controller ..... 64</p>
<b>Monitor and Manage Control System Alarms</b>	<p><b>Chapter 4</b></p> <p>Alarm Indicator..... 65</p> <p>Alarm Help Menu..... 66</p> <p>View the Alarm Summary..... 68</p> <p>Manage the Alarms..... 69</p> <p>Alarm Detail Pane Descriptions ..... 70</p> <p>Filter the Alarms ..... 72</p>
<b>Install and Replace Components</b>	<p><b>Chapter 5</b></p> <p>Accessories and Replacement Parts ..... 75</p> <p>Voltage Precautions ..... 75</p> <p>Electrostatic Discharge Precautions..... 76</p> <p>Connect to USB Ports..... 76</p> <p style="padding-left: 20px;">USB Cables ..... 77</p> <p>Insert an SD Card..... 77</p> <p>Replace the Battery ..... 78</p>

	<b>Chapter 6</b>	
<b>Update Firmware</b>	Before You Begin . . . . .	81
	Firmware Requirements . . . . .	81
	Get the Terminal Firmware . . . . .	82
	Install the ControlFLASH Software . . . . .	82
	Update the Firmware by Using ControlFLASH Software . . . . .	83
	Verify the Firmware Update . . . . .	85
	<b>Chapter 7</b>	
<b>Troubleshooting</b>	Status Indicators . . . . .	88
	View Diagnostic Information for the Configured Controller. . . . .	89
	Troubleshooting Profiles. . . . .	89
	Import a Troubleshooting Profile. . . . .	90
	Export a Troubleshooting Log. . . . .	91
	Terminal Does Not Start Up. . . . .	93
	Terminal Restarts Intermittently . . . . .	93
	Touch Screen Issues . . . . .	93
	Display Issues . . . . .	94
	Ethernet Issues. . . . .	95
	Cannot Download Application to Terminal. . . . .	95
	Performance Is Slow. . . . .	95
	Resistance to Chemicals . . . . .	96
	Clean the Display . . . . .	96
	Remove Paint and Grease . . . . .	96
	Equipment Wash Downs . . . . .	97
	Ship the Terminal. . . . .	97
	Restore Factory Defaults. . . . .	97
	Dispose of the Terminal . . . . .	98
	<b>Index</b>	
	. . . . .	99



This manual describes how to install, configure, operate, and troubleshoot the PanelView™ 5310 terminals. This manual does not provide procedures on how to create applications that run on the terminals, or ladder logic that runs in the controller.

Other tasks that you must do include:

- Configure the Ethernet settings and update the firmware of the terminal.

---

**IMPORTANT** You must configure the Ethernet settings and update the firmware before you can download a View Designer project and use the terminal. See [Initial Startup on page 37](#).

---

- Create a project by using the Studio 5000 View Designer® application.
- Create control logic for the controller by using the Studio 5000 Logix Designer® application.

## Summary of Changes

This manual contains new and updated information as indicated in the following table.

Topic	Page
Converted content in Package Contents section into a table.	7
Increased maximum number of user-defined screens from 50 to 100.	11
Increased maximum number of Logix-based alarms from 1,000 to 4,000, and added footnote.	11
Added logos and cross-reference in item 7 description in Table 1.	12
Added catalog numbers for 8-GB and 32-GB SD cards, and revised footnote in Table 5.	17
Added SD card content following Table 5.	17
Added Installation Precautions title and introductory sentence.	20
Added Environment and Enclosure Information subtitle.	20
Added Wiring and Safety Guidelines subtitle.	21
Added Outdoor Installation Recommendations subsection.	21
Added Accessories and Replacement Parts section.	75
Added Voltage Precautions section.	75
Added Electrostatic Discharge Precautions section.	76
Added cross-reference to second sentence of Install an SD Card section.	77
Added Dispose of the Terminal section.	98

## Package Contents

The PanelView 5310 terminals ship with these items.

Item	Description
Hardware	<ul style="list-style-type: none"> <li>• Mounting levers for panel installation</li> <li>• Removable DC power terminal block</li> </ul>
Documents	<ul style="list-style-type: none"> <li>• PanelView 5310 Terminals Product Information, publication <a href="#">2713P-PC001</a></li> <li>• Cutout Templates for PanelView 5310 Terminals, publication <a href="#">2713P-DS001</a></li> </ul>

## Request Corresponding Source for Open Source Packages

The software included in this product contains copyrighted software that is licensed under one or more open source licenses. Copies of those licenses are included with the software. Corresponding Source for open source packages included in this product can be found at the websites identified in the product documentation.

You may alternately obtain complete Corresponding Source by contacting Rockwell Automation via our Contact form on the Rockwell Automation website: <http://www.rockwellautomation.com/global/about-us/contact/contact.page>. Please include 'Open Source' as part of the request text.

---

**IMPORTANT** Do not modify the NVS file. The NVS file is used in firmware updates and a modified NVS file can cause the firmware update to fail.

---

## Product Firmware and Release Notes

Product firmware and release notes are available online at the Product Compatibility and Download Center at <https://compatibility.rockwellautomation.com/Pages/home.aspx>.

1. On the PCDC home page, search for your product.



2. On the search results page, find the firmware and release notes for your product.

See the Product Compatibility and Download Center Quick Start Guide, publication [PCDC-QS001](#), for instructions on how to find and download firmware and release notes for the terminal.



## Additional Resources

These documents contain additional information about related products from Rockwell Automation.

Resource	Description
PanelView 5310 Terminals Specifications Technical Data, publication <a href="#">2713P-TD001</a>	Provides specifications and certifications for the PanelView 5310 terminal.
Industrial Automation Wiring and Grounding Guidelines, publication <a href="#">1770-4.1</a>	Provides general guidelines for installing a Rockwell Automation industrial system.
Guidelines for Handling Lithium Batteries Technical Data, publication <a href="#">AG-5.4</a>	Provides guidelines to store, handle, install, and dispose of lithium batteries.
Safety Guidelines for the Application, Installation, and Maintenance of solid-state Controls, publication <a href="#">SGI-1.1</a>	Provides general guidelines for the application, installation, and maintenance of solid-state equipment.
Product Certifications website, <a href="http://rok.auto/certifications">rok.auto/certifications</a>	Provides declarations of conformity, certificates, and other certification details.

You can view or download publications at <http://www.rockwellautomation.com/global/literature-library/overview.page>.

**Notes:**

## Overview

Topic	Page
About the PanelView 5310 Terminals	11
Hardware Features	12
Operator Control	13
Touch Gestures	13
Studio 5000 Environment	14

Topic	Page
EtherNet/IP Communication	15
Typical Configuration	15
Catalog Number Explanation	16
Product Selections	16
Accessories	16

### About the PanelView 5310 Terminals

The PanelView™ 5310 terminals are operator interface devices that monitor and control devices attached to ControlLogix® 5570 and 5580 controllers, and CompactLogix™ L1, L2, and L3 controllers over an EtherNet/IP™ network. Animated graphic and text displays provide operators with a view into the operating state of a machine or process. Operators interact with the control system by using the touch screen.

The PanelView 5310 terminals include these features and capabilities:

- Tightly integrated control and design environment allows information to be shared between the PanelView 5310 terminal and the Logix platforms.
- The Studio 5000® environment provides one point of access for the Studio 5000 View Designer® and Studio 5000 Logix Designer® applications.<sup>(1)</sup>
- Connection to one ControlLogix 5570, ControlLogix 5580, or CompactLogix L1, L2, or L3 controller with revision 27 firmware or later.
- Supports a maximum of 100 user-defined screens.
- Supports a maximum of 4,000 Logix-based alarms.<sup>(1)</sup>
- Easily configured screen navigation menu.

(1) PanelView 5310 firmware can support up to 4,000 Logix-based alarms in one controller if you use Studio 5000 View Designer application version 5 and Studio 5000 Logix Designer application version 32 or higher. Of the 4,000 alarms, no more than 1,000 can be instruction-based. Earlier versions of the Studio 5000 View Designer or Studio 5000 Logix Designer applications can support up to 1,000 Logix-based alarms.

## Hardware Features

The PanelView 5310 terminal features fixed-hardware configurations in a range of display sizes with touch screen input.

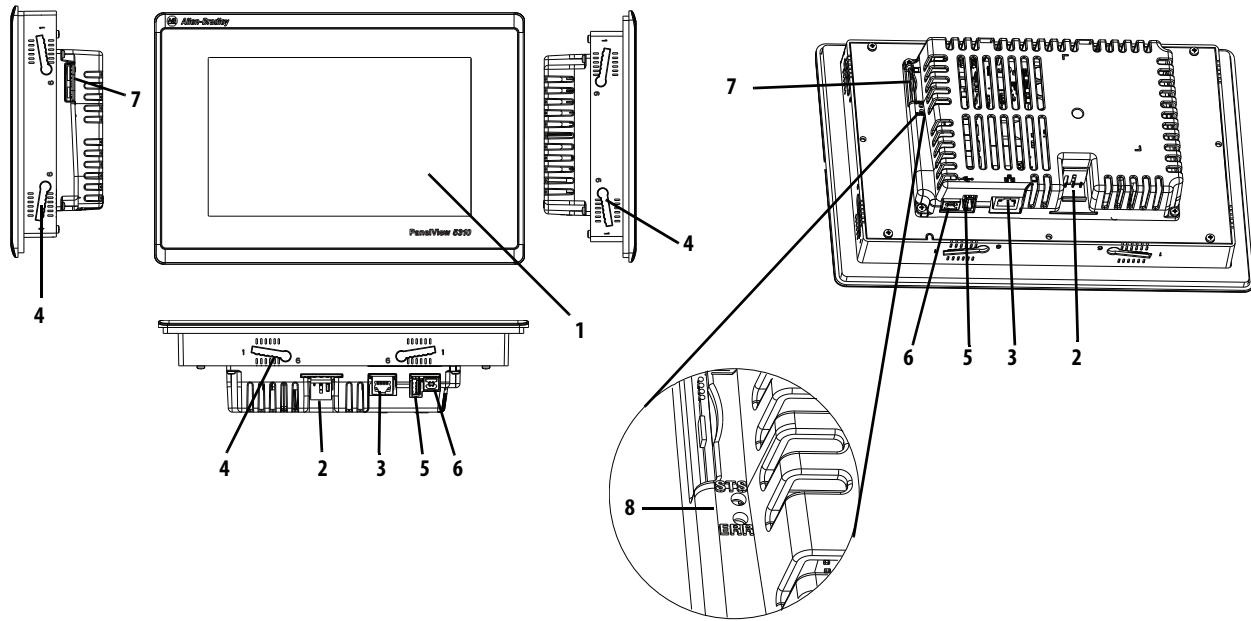

**Table 1 - Hardware Features**

Item	Feature	Description
1	Display/Touch screen	TFT color, SVGA, VGA, WVGA, or WXGA graphic display with a touch screen available in sizes of 5.7-in., 7-in., 9-in., 10.4-in., and 12.1-in.
2	Power	24V DC nom (18...30V DC) non-isolated power input
3	Ethernet port	One 10/100Base-T, Auto MDI/MDI-X, EtherNet/IP port for controller communication.
4	Mounting slots	Mounting levers insert into the slots to mount device in a panel or enclosure. The number of slots varies by terminal size.
5	Universal serial bus (USB) host port	One USB 2.0 high-speed (type A) host port.
6	USB device port	One USB 2.0 high-speed (type B) device port to connect a host computer that is software-feature dependent.
7	SD card slot	One slot that supports an SD™ or SDHC™ card that is recommended in <a href="#">Table 5 on page 17</a> .
8	Status Indicators	STS indicator (green) indicates that the terminal is on and in use. ERR indicator (red) indicates hardware and firmware faults.

## Operator Control

All PanelView 5310 terminals have a color display with a touch screen for operator control. The resistive touch screen provides accurate, durable touch control for industrial applications.



**ATTENTION:** The touch screen accepts input from a finger, stylus, or gloved hand for operation in dry or wet environments.

The plastic stylus must have a minimum tip RADIUS of 1.3 mm (0.051 in.). Any other object or tool can damage the touch screen.

---



**ATTENTION:** Do not perform multiple operations simultaneously. Multiple simultaneous operations can result in unintended operation.

Touch only one operating element on the screen with one finger at a time.

---

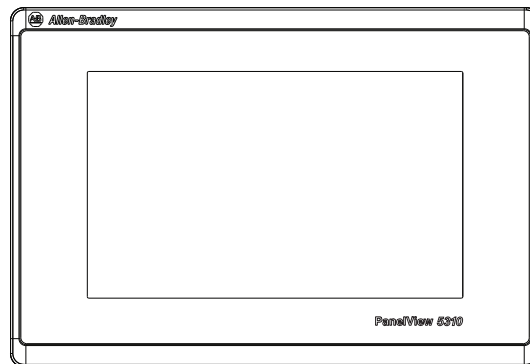

**TIP**

During runtime, a virtual keyboard or numeric keypad opens on HMI displays for data entry.

## Touch Gestures

The PanelView 5310 terminal supports touch gestures to interact with screen elements during runtime. Standard touch gestures include:

- **Tap** – Briefly touch the target on the HMI display with your fingertip.
- **Double-tap** – Touch the target on the HMI display twice quickly with your fingertip.
- **Drag** – Move your fingertip over the target on the HMI display without contact loss.
- **Long press** – Touch and hold the target on the HMI display for several seconds.

For a list of actions you can perform by using touch gestures, see the View Designer help.

## Studio 5000 Environment

Use the Studio 5000 environment to create HMI applications for the PanelView 5310 terminal.



The Studio 5000 environment includes these applications:

- **View Designer** – you can create and design a project for a specific PanelView 5310 terminal and download the project to the terminal.
- **Logix Designer application** – you can develop control logic for a CompactLogix or ControlLogix controller and download the logic to the controller.

You can create an application for any PanelView 5310 terminal and reuse that same application across the entire platform.

**Figure 1 - How Studio 5000 Applications Work Together**

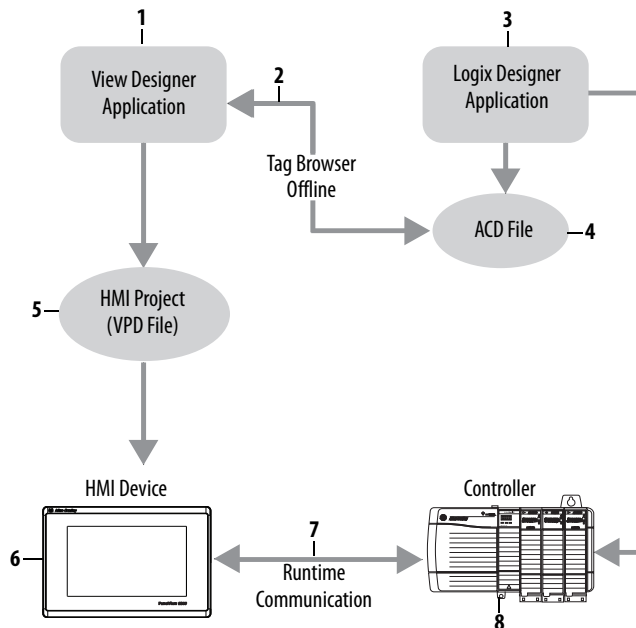

[Table 2](#) describes how the View Designer and Logix Designer applications work together to create an HMI runtime project.

**Table 2 - Studio 5000 Applications and Tools**

Item	Component	Description
1	View Designer application	A Studio 5000 application that is used to build HMI projects. Studio 5000 View Designer projects are stored as VPD files that can be downloaded to the PanelView 5310 terminal.
2	Tag browser	A tool that is used to search for and select tags within a Studio 5000 Logix Designer application ACD project file. You can bind the tags to graphic element properties and properties of an HMI display. The Studio 5000 View Designer application uses the tag browser to read data from an ACD file.
3	Logix Designer application	A Studio 5000 application that is used to develop control logic for an industrial automation system. The Studio 5000 Logix Designer application interfaces with controllers to read and write tag information. Studio 5000 Logix Designer application projects are stored as ACD files that can be downloaded to the controller.
4	ACD file	An Automation Controller Database (ACD) file. An ACD file is a Logix Designer application project file that contains the logic or code, including tags and data types, which runs within a controller.
5	HMI project (VPD file)	A View Project Database (VPD) file. A VPD project is a file that contains the operator interface application, including HMI displays, controller references, and information about the HMI device to run the application.
6	HMI device	A Human Machine Interface (HMI) device, such as the PanelView 5310 terminal, which runs the HMI project. At runtime, the HMI device communicates directly with the controller.
7	Runtime	The environment in which the runtime HMI project communicates with the controller. During runtime, the HMI device runs the downloaded project, exchanges data with the controller, animates displayed data, and responds to operator input.
8	Controller	A logic controller such as a ControlLogix or CompactLogix 5370 controller.

## EtherNet/IP Communication

The PanelView 5310 terminals contain EtherNet/IP technology. These terminals communicate with ControlLogix controllers over an Ethernet connection with linear network topologies. Star technology is also supported when using switches.

## Typical Configuration

Linear and star network topologies are supported. See these topics for examples:

- [Linear Network Topology on page 36](#)
- [Star Network Topology on page 36](#)

## Catalog Number Explanation

This table provides an explanation of the catalog numbers.

Bulletin	Input Type	Display Size	Display Type	Power	Ethernet Port	Special Option
2713P-	T = Touch	6 = 5.7-in. 7 = 7-in. 9 = 9-in. 10 = 10.4-in. 12 = 12.1-in.	C = Color, 4:3 aspect ratio W = Color, widescreen <sup>(1)</sup> aspect ratio	D = DC	1 = Single	- B = Without brand identity <sup>(2)</sup>

(1) Depending on the PanelView 5310 terminal model, the widescreen aspect ratio is either 5:3 or 16:10. For further details, see the Product Selections section on this page.

(2) A catalog number with -B at its end (for example, 2713P-T9WD1-B) is a terminal without the Allen-Bradley logo and product identification on the front bezel.

## Product Selections

This table provides information for the product selections.

Cat. No.	Display				Input Power	Ethernet Port	Memory		
	Touch Screen	Display Size	Type	Aspect Ratio			Pixels (W x H)	RAM	User <sup>(1)</sup>
2713P-T6CD1 2713P-T6CD1-B		5.7-in.	VGA TFT color	4:3	640 x 480	DC	One	1 GB	1 GB
2713P-T7WD1 2713P-T7WD1-B		7-in.	WVGA TFT color	5:3	800 x 480				
2713P-T9WD1 2713P-T9WD1-B		9-in.							
2713P-T10CD1 2713P-T10CD1-B		10.4-in.	SVGA TFT color	4:3	800 x 600				
2713P-T12WD1 2713P-T12WD1-B		12.1-in.	WXGA TFT color	16:10	1280 x 800				

(1) Nonvolatile memory that is available to store projects.

## Accessories

[Table 3](#) through [Table 7](#) list accessories for the PanelView 5310 terminals.

**Table 3 - Power Supplies and Power Terminal Blocks**

Cat. No.	Description	Quantity
1606-XLB120E	DIN rail power supply, 24...28V DC output voltage, 120 W	1
1606-XLP100E	DIN rail power supply, 24...28V DC output voltage, 100 W	1
1606-XLP95E	DIN rail power supply, 24...28V DC output voltage, 95 W	1
2711P-RSACDIN	DIN rail power supply, AC-to-DC, 85...265V AC, 47...63 Hz	1
2711-TBDC	3-pin DC power terminal block	10

**Table 4 - Mounting Hardware**

Cat. No.	Description	Quantity
2711P-RMCP <sup>(1)</sup>	Mounting levers (black)	16

(1) Use catalog number 2711P-RMCP mounting levers (black) for PanelView 5310 terminals. Do not use gray mounting levers; they are not compatible with PanelView 5310 terminals.



**Table 5 - Secure Digital (SD) Cards <sup>(1)</sup>**

Cat. No.	Description	Quantity
1784-SD1	1-GB SD card	1
1784-SD2	2-GB SD card	1
1784-SDHC8	8-GB SDHC card	1
1784-SDHC32	32-GB SDHC card	1
2711C-RCS	USB to SD adapter for SD card	1

(1) To help reduce the chance of corruption when you use SD Cards or USB drives with the terminal, Rockwell Automation recommends that you use only the above SD card catalog numbers.

SD™ and SDHC™ accessory cards in [Table 5](#) have been designed to meet industrial robustness and environmental requirements. Rockwell Automation recommends that you use these accessory cards with the terminal to help reduce the chances of corruption. Studio 5000 View Designer software requires the following for SD cards that are inserted into the HMI device:

- 4 GB of free space
- A supported SDHC card type, preferably one listed in [Table 5](#)
- An environmental rating for the PanelView 5000 environment
- A supported format of either FAT32 or ext3

**Table 6 - USB Programming Cable**

Cat. No.	Description	Length
6189V-USBCBL2	Programming cable that connects the device port of the terminal to a USB host port of a computer.	1.8 m (5.9 ft)

**Table 7 - Battery Replacement**

Cat. No.	Description	Quantity
2711P-RY2032	Lithium coin-cell battery, CR2032 equivalent	1

## Ethernet Cables

See the Industrial Ethernet Media Brochure, publication [1585-BR001](#), for recommended Ethernet cables and media solutions.

See the USB to Serial Adapter Quick Start Guide, publication [GMSC10-QS003](#), for information on USB to serial port adapters.

**Notes:**

## Install the PanelView 5310 Terminal

Topic	Page
Installation Precautions	20
Mounting Considerations	23
Mounting Clearances	23
Panel Guidelines	24
Panel Cutout Dimensions	24
Terminal Dimensions	25
Prepare for Panel Mounting	26
Mount the Terminal in a Panel	29
Remove and Replace Power Terminal Block	32
Connect Power	33
Connect to a Network	34
Initial Startup	37



**ATTENTION:** Do not use a PanelView™ 5310 terminal for emergency stops or other controls critical to the safety of personnel or equipment. Use separate hard-wired operator interface devices that do not depend on solid-state electronics.

---

## Installation Precautions

Read and follow these precautions before you install the PanelView 5310 terminal.

### Environment and Enclosure Information

---



**ATTENTION:** This equipment is intended for use in a Pollution Degree 2 industrial environment, in overvoltage Category II applications (as defined in IEC 60664-1), at altitudes up to 2000 m (6561 ft) without derating. The terminals are intended for use with programmable logic controllers.

This equipment is considered Group 1, Class A industrial equipment according to IEC CISPR 11. Without appropriate precautions, there can be difficulties with electromagnetic compatibility in residential and other environments due to conducted or radiated disturbances.

**Korean Radio Wave Suitability Registration - When so marked this equipment is registered for Electromagnetic Conformity Registration as business equipment (A), not home equipment. Sellers or users are required to take caution in this regard.**

이 기기는 업무용 (A 급) 전자파적합기기로서 판매자 또는 사용자는 이 점을 주의하시기 바라며, 가정외의 지역에서 사용하는 것을 목적으로 합니다.

This equipment is supplied as open-type equipment. It must be mounted within an enclosure that is suitably designed for those specific environmental conditions that can be present, and appropriately designed to help prevent personal injury resulting from accessibility to live parts. The interior of the enclosure must be accessible only by the use of a tool. The terminals meet specified NEMA, UL Type, and IEC ratings only when mounted in a panel or enclosure with the equivalent rating. Subsequent sections of this publication can contain additional information regarding specific enclosure type ratings that are required to comply with certain product safety certifications.

In addition to this publication, see the following:

- Industrial Automation Wiring and Grounding Guidelines, publication [1770-4.1](#), for additional installation requirements.
  - NEMA 250 and IEC 60529, as applicable, for explanations of the degrees of protection provided by different types of enclosure.
-

---

## Wiring and Safety Guidelines

---



**ATTENTION:** Use publication NFPA 70E, Electrical Safety Requirements for Employee Workplaces, IEC 60364 Electrical Installations in Buildings, or other applicable wiring safety requirements for the country of installation when wiring the devices. In addition to the NFPA guidelines, here are some other guidelines to follow:

- Connect the device and other similar electronic equipment to its own branch circuit.
- Protect the input power by a fuse or circuit breaker rated at no more than 15 A.
- Route incoming power to the device by a separate path from the communication lines.
- Cross power and communication lines at right angles if they must cross.
- Communication lines can be installed in the same conduit as low-level DC I/O lines (less than 10V).
- Shield and ground cables appropriately to avoid electromagnetic interference (EMI). Grounding minimizes noise from EMI and is a safety measure in electrical installations.

For more information on grounding recommendations, refer to the National Electrical Code published by the National Fire Protection Association.

---

## Outdoor Installation Recommendations

When you use a PanelView 5310 terminal outdoors, follow these recommendations to maximize the field life of the front bezel and display:

- Do not expose terminal to direct sunlight
- Add UV protection and/or shielding
- Manage terminal temperature
- Mount terminal in an acceptable position
- Select a proper enclosure

Ultraviolet (UV) and infrared radiation can reduce the field life of any electronic terminal. While the materials used in the terminal bezels provide long field life, that life can be improved by proper installation and by following the suggested guidelines.

UV radiation from the sun causes all plastics to fade or yellow and become brittle over time. Avoid direct sunlight exposure, use a sacrificial antiglare overlay and/or use a shield to shade the terminal to help protect the front of the terminal from direct exposure to UV radiation and greatly increase its field life. When you install a sun shield that closes over the display, the temperature between the sun shield and the display cannot exceed the maximum temperature of the display, which is 50 °C (122 °F). Adequately ventilate all sun shields to help prevent excess heat rise on the terminal display.

Use stirring fans or active cooling in high altitude and high ambient temperature locations to keep the internal enclosure temperature below 50 °C (122 °F).

Verify that the ambient temperature at which the product is operating does not fall below its minimum rated 0 °C (32 °F).

Minimize the temperature differential between the inside of the terminal enclosure and the front panel to help reduce the potential for condensation and possible pressure variation between the inside and outside of the terminal.

If possible, avoid placing the terminal on the south (north in the southern hemisphere) or west side of the cabinet, which helps reduce the heat rise due to solar heating during the hottest part of the day.

Mount the terminal vertically to minimize solar heating on the display. Do not mount the terminal in a sloped enclosure if it exposes the terminal to direct sunlight. For more information, see [Mounting Considerations on page 23](#).

To help protect the terminal from water and dust, mount it in a proper enclosure by following the instructions in the PanelView 5310 Terminals Product Information, publication [2713P-PC001](#). The terminals meet specified NEMA, UL Type, and IEC ratings only when properly mounted in a panel or enclosure with the equivalent rating. Other sections of this publication can contain additional information about specific enclosure type ratings that are required to comply with certain product safety certifications.



**ATTENTION:** Failure to follow the recommended installation practices for outdoor use can substantially reduce terminal life and void its warranty.

---

## Mounting Considerations

Consider the following items when mounting the PanelView 5310 terminal:

- [Figure 2](#) shows the acceptable mounting positions where the terminal functions properly.
- Mount the terminal at a height suitable for most operators.
- Mount the terminal in an area that has good lighting.
- Do not mount the terminal where it is exposed to direct sunlight.

**Figure 2 - Acceptable Mounting Positions for PanelView 5310 Terminals**

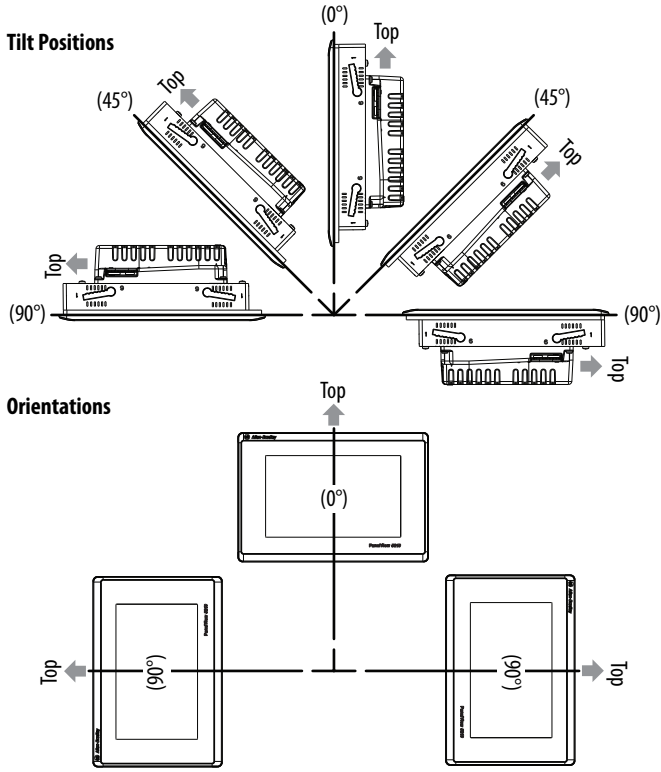

## Mounting Clearances

Plan for adequate space around the terminal, inside the enclosure, for ventilation and cables. Consider the heat from other devices in the enclosure. The ambient temperature around the terminal must be 0...50 °C (32...122 °F).

**Table 8 - Minimum Required Clearances**

Terminal Area	Minimum Clearance
Top	51 mm (2 in.)
Bottom	102 mm (4 in.)
Side	25 mm (1 in.) 102 mm (4 in.) is required to insert and remove an SD™ or SDHC™ card, or cable on one side
Back	0 mm (0 in.)

## Panel Guidelines

The terminals are panel-mounted devices that mount in the door or wall of a NEMA, UL Type, or IP rated enclosure:

- Enclosure panels must meet the panel thickness requirements in [Table 10 on page 26](#).
- The material strength and stiffness of the panel must be sufficient to hold the terminal and maintain an appropriate seal against water and dust.
- The panel surface must be flat and free of imperfections to maintain an adequate seal and NEMA, UL Type, or IP ratings.

## Panel Cutout Dimensions

Use the template that is shipped with your terminal to mark the cutout dimensions.

**PanelView 5310 - Panel Cutout Dimensions**

Terminal Size (in.)	Input Type	Height, mm (in.)	Width, mm (in.)
6	Touch	123 (4.84)	156 (6.14)
7		150 (5.9)	210 (8.25)
9		162 (6.38)	252 (9.92)
10.4		224 (8.82)	269 (10.59)
12.1		218 (8.58)	312 (12.28)



# Terminal Dimensions

This section provides terminal dimensions.

**Figure 3 - PanelView 5310 Terminal Dimensions (9-in. wide terminal shown)**

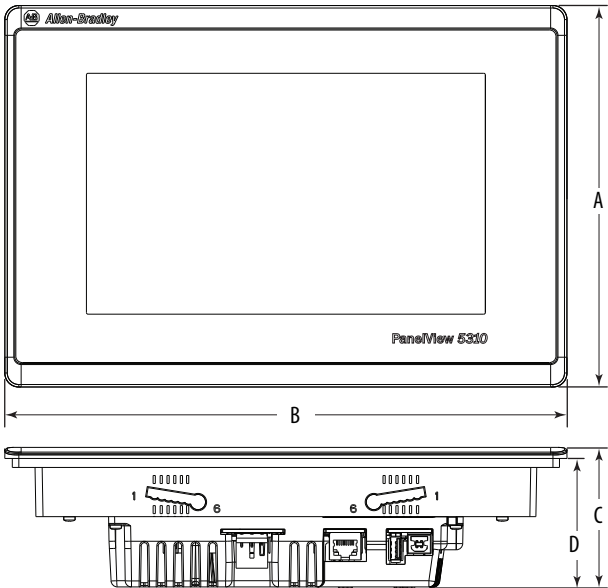

**Table 9 - PanelView 5310 Terminal Dimensions**

Display Size (in.)	Input Type	Height (A) mm (in.)	Width (B) mm (in.)	Overall Depth (C) mm (in.)	Mounted Depth (D) mm (in.)
6	Touch	153 (6)	186 (7.3)	69.5 (2.74)	64 (2.5) <sup>(1)</sup>
7		178 (7)	237 (9.3)		
9		190 (7.5)	280 (11)		
10.4		252 (9.92)	297 (11.69)		
12.1		246 (9.7)	340 (13.4)		

(1) When mounted in a panel, the front of the bezel extends less than 6 mm (0.24 in.) from the panel.

## Prepare for Panel Mounting

Before mounting a terminal in a panel, read this section and the entire installation procedure on [page 29](#).

---

**IMPORTANT** Use catalog number 2711P-RMCP mounting levers (black) for PanelView 5310 terminals. Do not use gray mounting levers; they are not compatible with PanelView 5310 terminals.

---

Mounting levers insert into the slots around the bezel to secure the terminal in the panel. The number of mounting levers varies by terminal size.

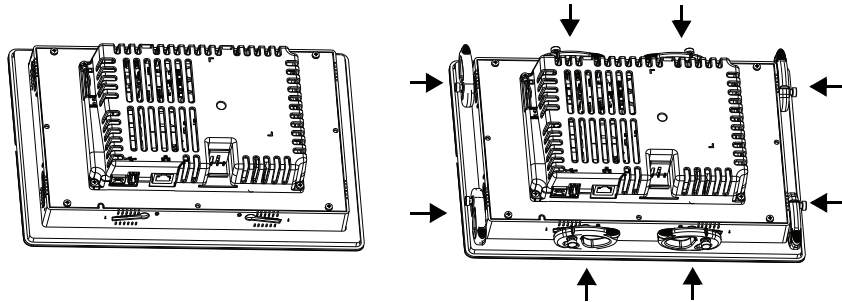

Each slot has six notches with alignment marks that are locking positions for a mounting lever. The thickness of the panel that you mount the terminal in determines the locking position that is required to maintain a NEMA, UL Type, and IP seal.

**Table 10 - Mounting Lever Locking Positions**

Mounting Slot	Mounting Lever Lock Position	Panel Thickness Range	Typical Gauge
	1	1.50...2.01 mm (0.060...0.079 in.)	16
	2	2.03...2.64 mm (0.08...0.104 in.)	14
	3	2.67...3.15 mm (0.105...0.124 in.)	12
	4	3.17...3.66 mm (0.125...0.144 in.)	10
	5	3.68...4.16 mm (0.145...0.164 in.)	8/9
	6	4.19...4.80 mm (0.165...0.188 in.)	7

Always orient a mounting lever vertically before inserting it into a slot. This method is the only way to slide the mounting lever knob within the slot for positioning. After sliding the mounting lever to a specific notch, rotate the mounting lever toward the panel to lock it in position. The flat side of the mounting lever must come into contact with the panel.

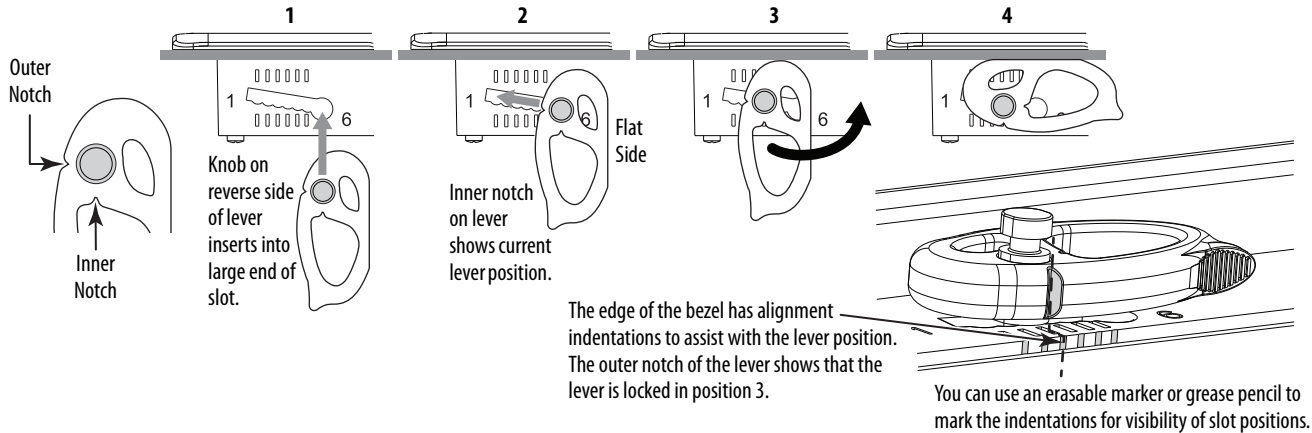

Initially, you secure the terminal in the panel by sliding each mounting lever to a position that is one or two notches greater than the final lock position. For example, if the final lock position is 1, slide each mounting lever to position 2 or 3. Follow the sequence specific to the terminal size shown in [Figure 5 on page 28](#).

**TIP** If the lock position is 6, slide the mounting lever to the large end of the slot or insertion hole.

[Figure 4 on page 27](#) shows the mounting lever orientation and locking sequence for a 9-in. terminal. See [Figure 5 on page 28](#) for locking sequence and mounting lever orientations for all terminals.

**Figure 4 - Mounting Levers Shown in Locked Position**

All mounting levers are locked in position 4, which is appropriate for a panel thickness of 3.17...3.66 mm (0.125...0.144 in.).

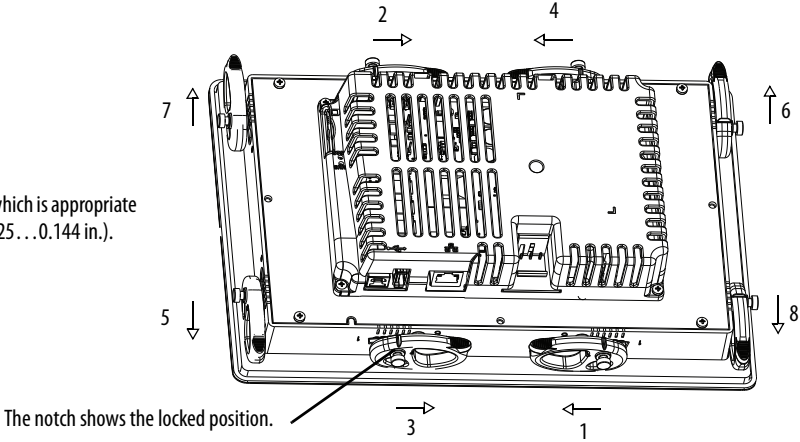
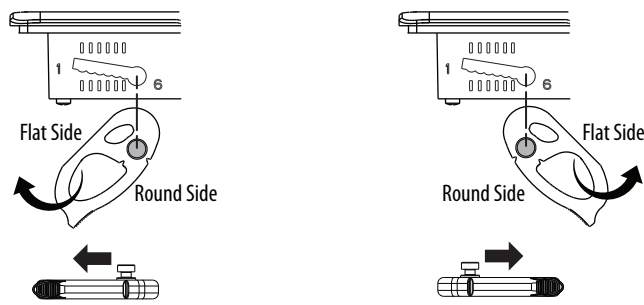
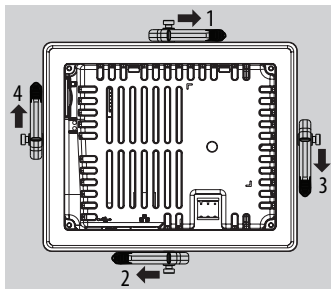

Figure 5 - Mounting Lever Orientation and Lock Sequence



6-in. Touch Screen – 4 Levers



7-in. Touch Widescreen – 6 Levers

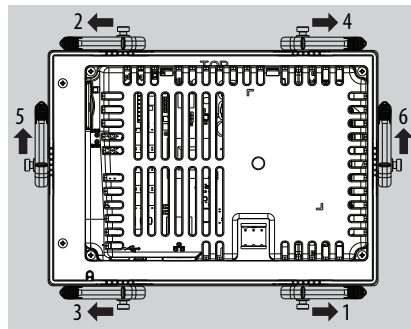

9-in. Touch Widescreen – 8 Levers

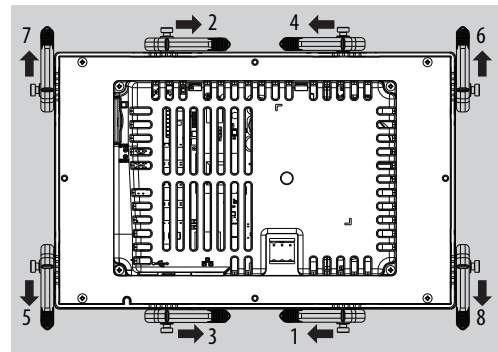

10.4-in. Touch Screen – 8 Levers

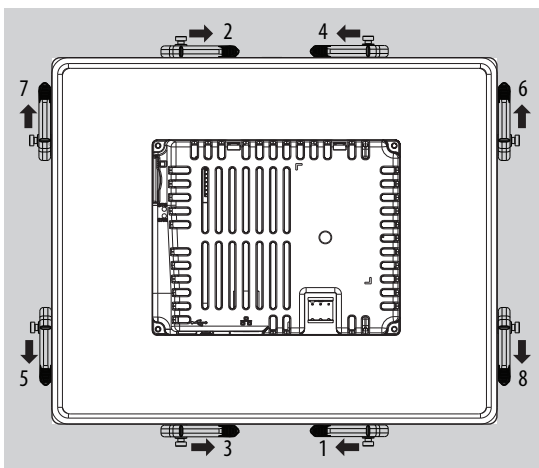

12.1-in. Touch Widescreen – 10 Levers

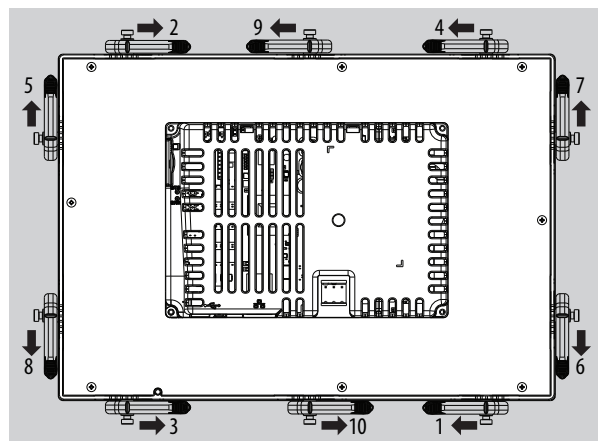

**IMPORTANT** The mounting lever orientations that are shown are required to maintain NEMA, UL Type, and IP seals. If you require a NEMA, UL Type, or IP seal, do not use a mounting lever in another orientation than shown.

## Mount the Terminal in a Panel

The PanelView 5310 terminals are designed for single-person installation. No tools are required except for tools to make the panel cutout.

To mount the terminal in a panel, follow these steps.



**ATTENTION:** Disconnect all electrical power from the panel before making the panel cutout.

Make sure that the area around the panel cutout is clear and that the panel is clean of any debris, oil, or other chemicals.

Make sure that metal cuttings do not enter any components that are already installed in the panel and that the edges of the cutout have no burrs or sharp edges.

Failure to follow these precautions can result in personal injury or damage to panel components.

1. Use the cutout dimensions on [page 24](#) to cut an opening in the panel.
2. Verify that the sealing gasket is present on the terminal.

This gasket forms a compression seal. Do not use sealing compounds.

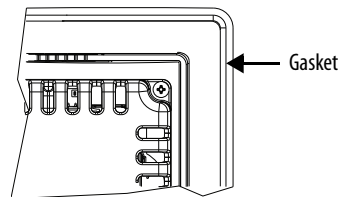

3. Insert and stabilize the terminal in the panel cutout.
  - a. Insert levers in the top corner slots in the orientation that is shown and rotate the non-flat side of the levers toward panel.

**TIP** The mounting levers for PanelView 5310 terminals are black (catalog number 2711P-RMCP).

Do not use gray mounting levers; they are not compatible with PanelView 5310 terminals.

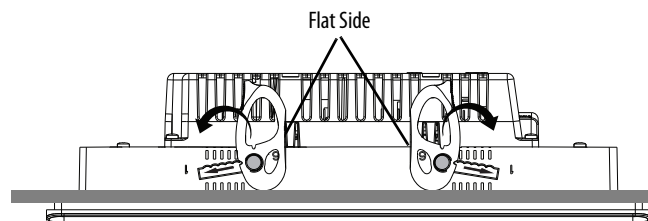
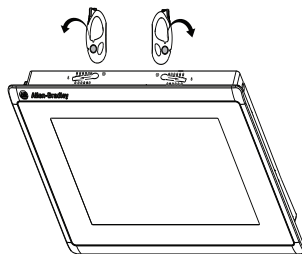

- b. Tilt the terminal toward the panel cutout and guide upward into the cutout. Make sure that the levers stay intact.

**TIP** The levers help prevent the terminal from falling out of the panel.

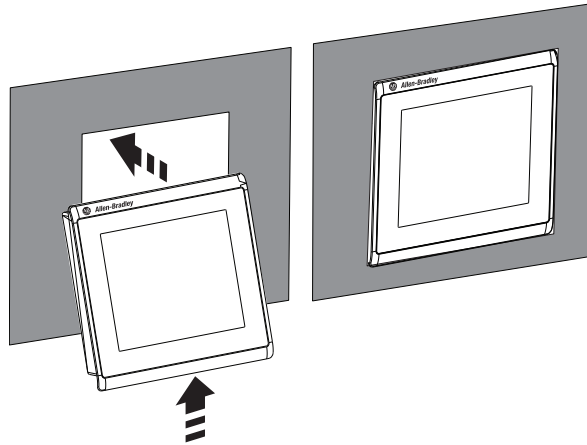

- c. Pull the top of the terminal toward you to verify that the levers are still intact and the terminal is stabilized in the panel.
- d. Insert the remaining levers in the slots by using the orientations in [Figure 5 on page 28](#) that are correct for your terminal. The direction that you rotate the levers varies for each terminal size.

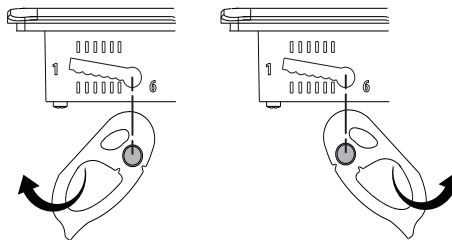

4. Slide and rotate each lever to a notch that is one or two positions greater than the final lock position. Start with the first lever in the sequence. For example, if the final lock position is 3, slide the lever to notch 4 or 5.

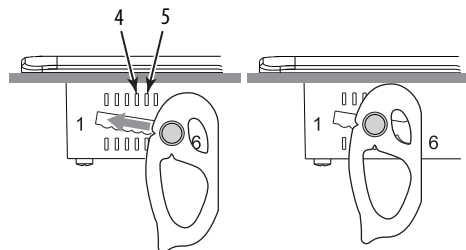

**TIP** To help position the levers and identify the final slot position, use the alignment marks or previous marks you made on the bezel.

- a. See [Table 10 on page 26](#) to get the final lock position of the levers.
- b. See [Figure 5 on page 28](#) to get the locking sequence.

- c. Rotate each lever until its flat side comes in contact with the panel.

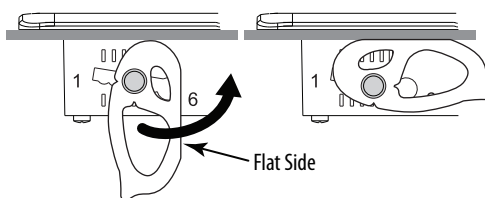

5. Adjust each lever to its final lock position shown in the same locking sequence in [Figure 5 on page 28](#).
- a. Unlock lever one in the sequence by rotating it away from the bezel.

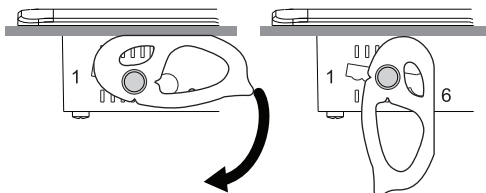

- b. With the lever positioned vertically to the slot, slide the lever to the final locking position in [Table 10 on page 26](#).  
The outer notch of the lever aligns with the bezel indentation.
- c. Carefully rotate the lever back toward panel.

**TIP** A broken lever does not damage the product.

- d. Lock the remaining levers to their final position.
6. Inspect all levers and make sure each is in the correct locked position.



**ATTENTION:** All levers must be in the correct and same locked position to provide an adequate gasket seal between the terminal and the panel. Rockwell Automation assumes no responsibility for water or chemical damage to the terminal or other equipment within the enclosure because of improper installation.

The notch on the outside of lever shows its locked position.

These two views show levers that are locked in position 4.

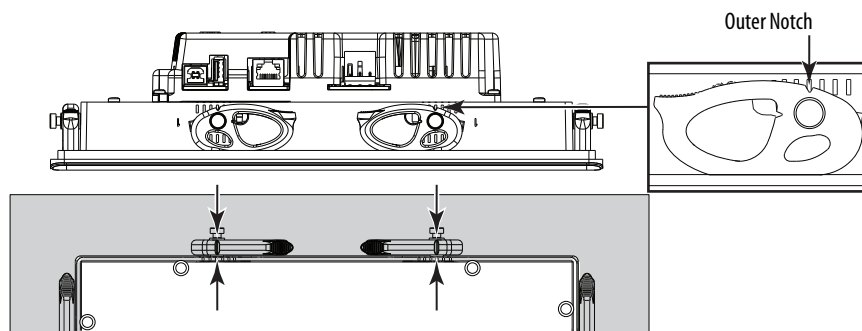

## Remove and Replace Power Terminal Block

The product has a three-pin terminal block for DC power connections. You can remove the terminal block for ease of installation, wiring, and maintenance.



**SHOCK HAZARD:** Turn off the power before you connect or disconnect wiring. If the power is on, an electric arc can occur.

Failure to turn power off can result in electric shock or damage to the terminal.

Use a 0.6 x 3.5 mm screwdriver for terminal block wiring.

**Table 11 - Wire Specifications for Power Input Terminal Block**

Wire Type	Dual-wire Size <sup>(1)</sup>	Single-wire Size	Strip Length	Screw Torque
Stranded or solid Cu 90 °C (194 °F)	0.3...1.3 mm <sup>2</sup> 22...16 AWG	0.3...2.1 mm <sup>2</sup> (22...14 AWG)	7 mm (0.28 in.)	0.56 N·m (5.0 lb-in)

(1) Two-wire maximum per terminal.

To remove the power terminal block, follow these steps.

1. Insert the tip of a small screwdriver into the terminal block access slot.
2. To release the locking mechanism, gently pry the terminal block away from terminal.

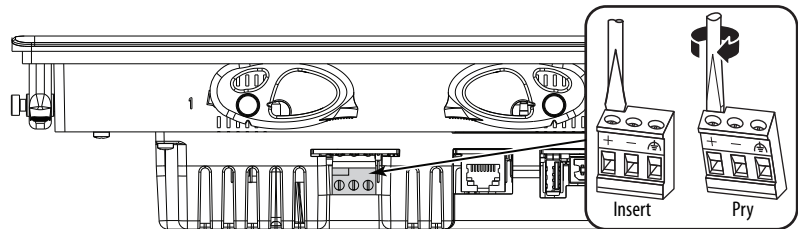

To install the power terminal block, follow these steps.

1. Press the terminal block base in first with the terminal block leaning outward.
2. Gently push the top of the terminal block back to vertical position to snap in the locking tab.



## Connect Power

The terminals have a 24V DC non-isolated power supply at these power ratings.

**Table 12 - DC Power Ratings**

Terminal	Power Supply	Input Voltage	Power Consumption
2713P-T6CD1	Non-isolated	24V DC nom (18...30V DC)	13 W max (0.54 A at 24V DC)
2713P-T7WD1			
2713P-T9WD1			14 W max (0.58 A at 24V DC)
2713P-T10CD1			15 W max (0.62 A at 24V DC)
2713P-T12WD1			16 W max (0.67 A at 24V DC)



**ATTENTION:** The power supply is internally protected against reverse polarity. Do not connect DC+ or DC- to the earth ground terminal, which can damage the terminal. Do not connect AC power, or more than 30V DC, which can also damage the terminal.

The terminals support operation from a safety extra low voltage (SELV) or protective extra low voltage (PELV) 24V DC power supply. Supported power supplies include catalog numbers 1606-XLP95E, 1606-XLP100E, 1606-XLP120E, and 2711P-RSACDIN.



**ATTENTION:** Use a SELV or PELV supply as required by local wiring codes for your installation. The SELV and PELV power sources provide protection so that under normal and single fault conditions, the voltage between conductors and earth ground does not exceed a safe value.

To power the terminal from the same power source as other equipment, use a DC power bus.

To connect the operator terminal to a DC power source, follow these steps.

1. Verify that the wiring is not connected to a power source.
2. Strip 7 mm (0.28 in.) of insulation from your power supply wires.

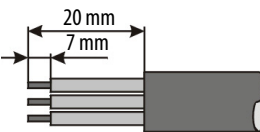

3. Secure the DC power wires to the marked terminals (+ and -) on the terminal block.

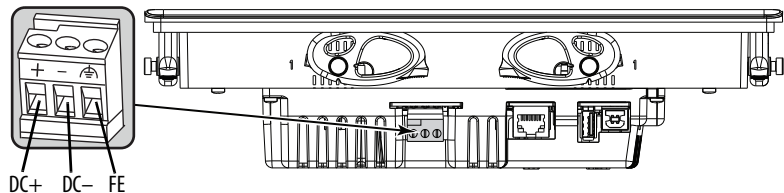

4. Secure the functional earth (FE) ground wire to the GND terminal on the terminal block.

The GND terminal must be connected to a low-impedance FE ground.



**ATTENTION:** The FE ground connection to FE ground is mandatory. This connection is required for noise immunity, reliability, and Electromagnetic Compliance (EMC) with the European Union (EU) EMC Directive for CE marking conformance. This connection is required for safety by Underwriters Laboratory (UL).

- IMPORTANT** Secure the power cable to help prevent these actions:
- Vibration at the connector.
  - Pulling when the panel door is opened and closed, or when personnel are working inside the panel.

5. Apply power to the operator terminal.

## Connect to a Network

The Ethernet port connects to controllers on an EtherNet/IP™ network by using standard Ethernet connections. These types of networks are supported:

- [Linear Network Topology on page 36](#)
- [Star Network Topology on page 36](#)

### Ethernet Port

The terminal has one 10/100Base-T, Auto MDI/MDI-X, Ethernet port for controller communication.

The terminal connects to an EtherNet/IP network by using a CAT5, CAT5E, or CAT6 twisted-pair, Ethernet cable with RJ45 connectors.

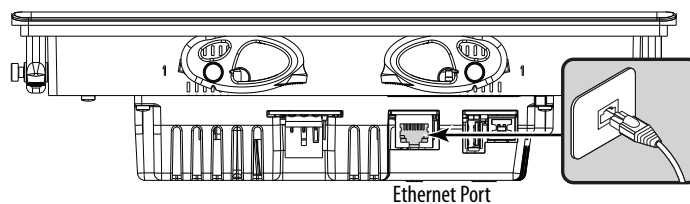

- IMPORTANT** To help prevent accidental disconnection of the Ethernet cable, follow these steps:
- To minimize vibration at the connector and help reduce the chance that personnel working inside the panel can accidentally disconnect the cable, secure the Ethernet cable.
  - To help prevent pulling on the cable when the panel door is opened and closed, do not install the Ethernet cable too tightly. Leave some slack in the cable.

The maximum cable length between the Ethernet port and a 10/100Base-T port on an Ethernet hub (without repeaters or fiber) is 100 m (328 ft).



**SHOCK HAZARD:** Do not connect or disconnect any communication cable with power that is applied to this device or any device on the network. If the power is on, an electric arc can occur.

Failure to turn power off can result in electric shock or damage to the terminal.

**Table 13 - Ethernet Connector Pinout**

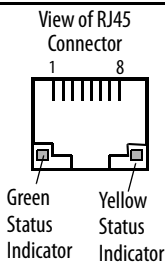
Connector	Pin	Pin Name
View of RJ45 Connector  Green Status Indicator      Yellow Status Indicator	1	TD+
	2	TD-
	3	RD+
	4	Unused
	5	Unused
	6	RD-
	7	Unused
	8	Unused
	Shield connection	No direct connection (AC coupled to chassis GND)

The Ethernet port has two indicators that provide the status of activity.

**Table 14 - Ethernet Status Indicators**

Indicator	Color	Description
Link integrity	Green	On when a link is present.
Activity	Yellow	Blinks when activity is detected on the Ethernet link.

## Linear Network Topology

A linear network topology is a collection of devices that are daisy-chained together across an EtherNet/IP network. Devices that can connect to a linear network topology use embedded switch technology so you do not need a separate switch, as required in star network topologies.

**Figure 6 - PanelView 5310 Terminal at the End of a Linear Network**

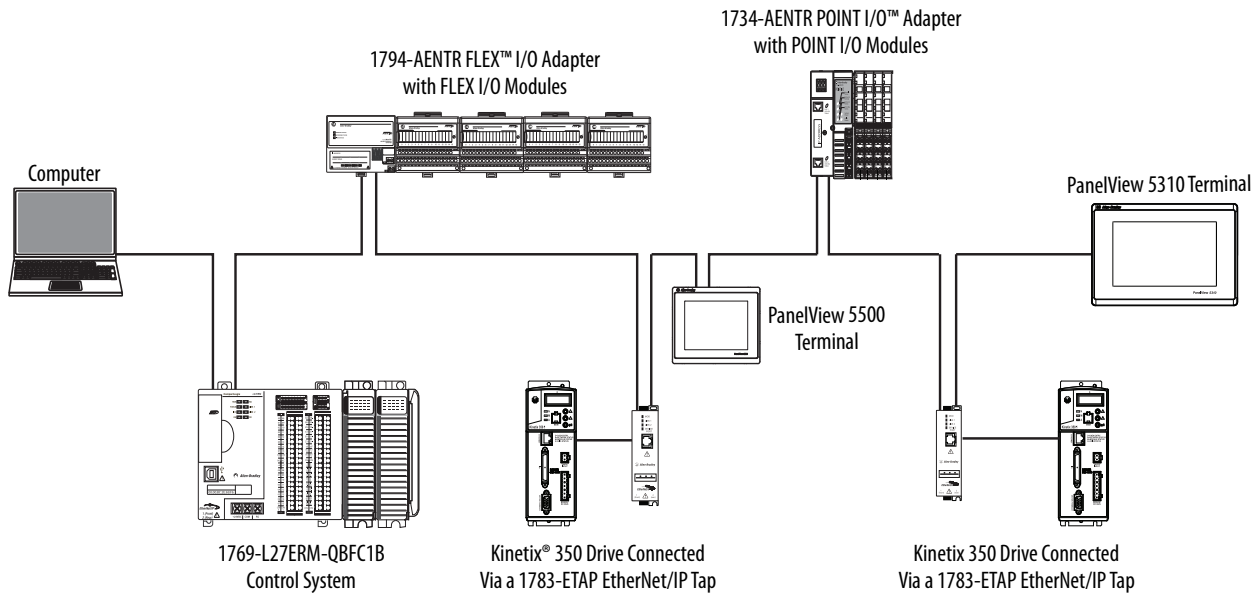

## Star Network Topology

A star network topology is a traditional EtherNet/IP network that has multiple devices that are connected to each other via an Ethernet switch.

**Figure 7 - PanelView 5310 Terminal Connected Via a Stratix 6000 Switch**

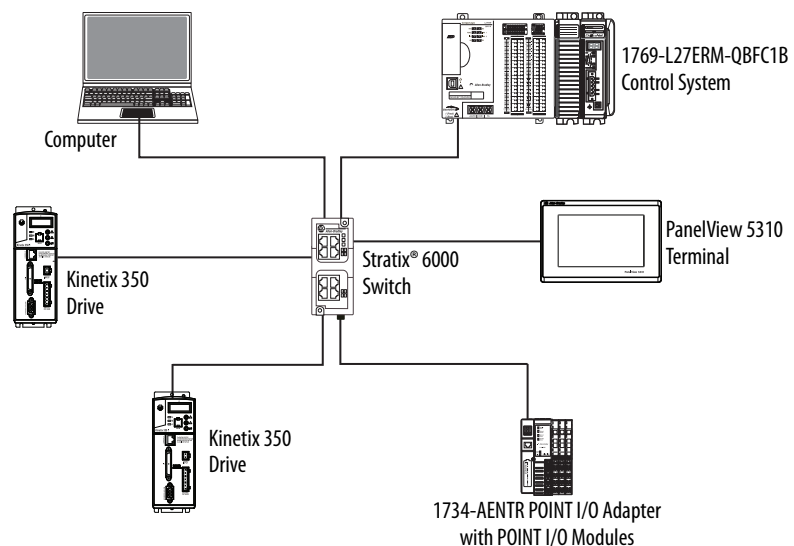

## Initial Startup

**IMPORTANT** You must configure the Ethernet settings and update the firmware before you can download a View Designer project and use the terminal. See [Update the Firmware before You Use the Terminal on page 37](#).

If you attempt to configure the terminal settings without updating the firmware, the Settings menu shows an update firmware message at the bottom of the screen.

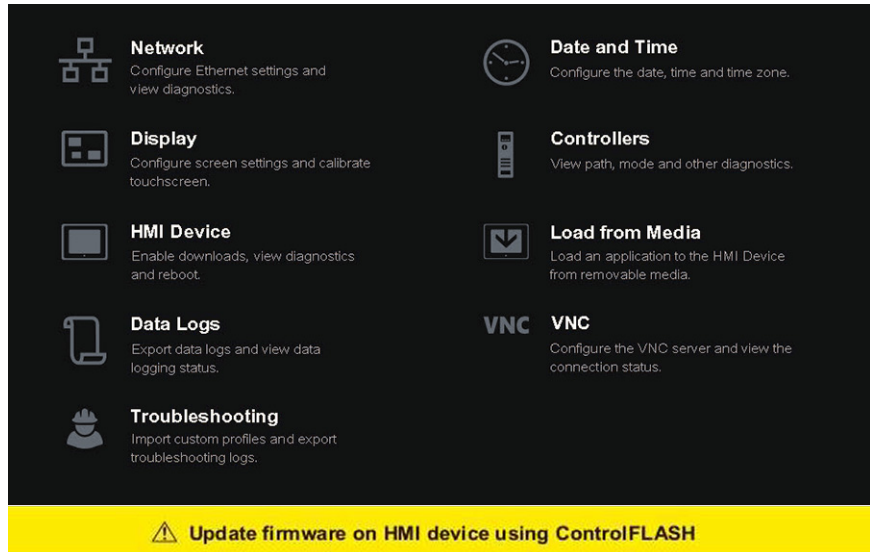

### Update the Firmware before You Use the Terminal

When power is turned on, the terminal goes through its startup sequence. The Welcome screen displays with a Configure the Ethernet Network button.

To configure the Ethernet settings and update the firmware, follow these steps.

1. Start up the terminal.

The Welcome dialog box displays.

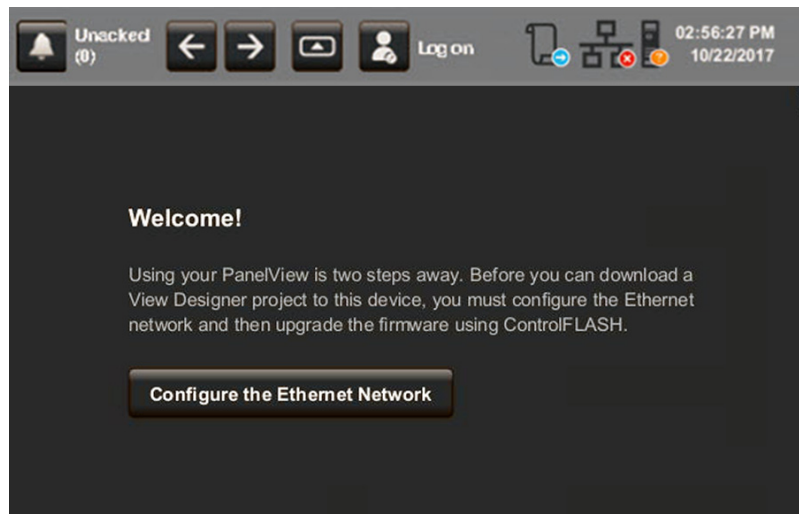

2. Tap Configure the Ethernet Network.

The Internet Protocol (IP) Settings dialog box displays.

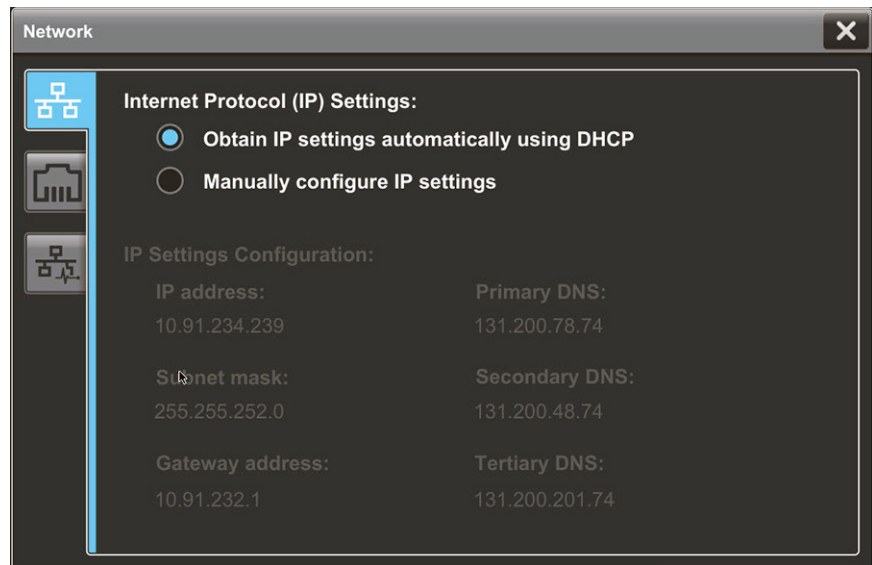

3. Configure the IP settings for the terminal.
  - To obtain an IP address automatically, see [Use DHCP to Assign an IP Address for the Terminal on page 46](#).
  - To configure IP settings manually, see [Assign a Static IP Address for the Terminal on page 47](#).
4. Tap the Ethernet icon.
5. Configure the Ethernet ports for the terminal.  
See [Configure the Ethernet Port on page 49](#).

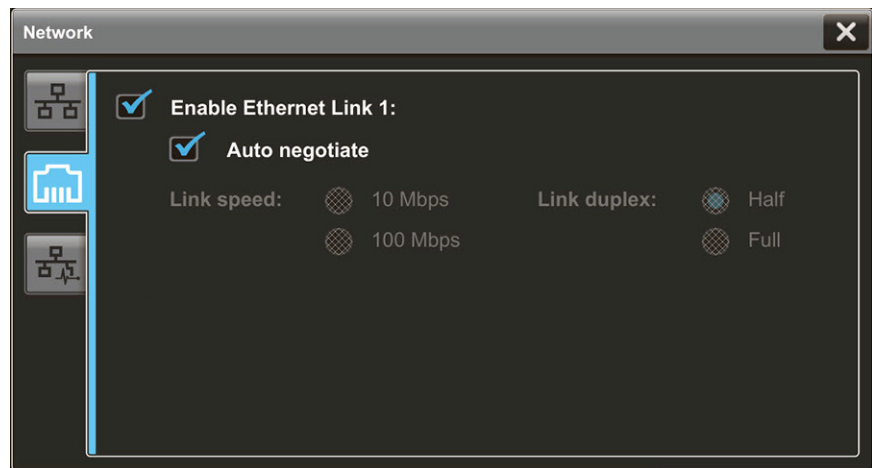

6. Update the firmware by using the ControlFLASH™ software.  
Begin the update at [Get the Terminal Firmware on page 82](#).

You can now download a View Designer application to the terminal. After the application is downloaded, the terminal resets then automatically launches the application.

## Configure Terminal Settings

Topic	Page	Topic	Page
Runtime Environment	39	Configure the Display Screen Saver	53
Enter Data With Virtual Keyboards	41	Calibrate the Touch Screen	54
Log On to the Terminal	43	Disable Downloads to the Terminal	56
Log Off of the Terminal	44	Change the HMI Device Name	57
Settings Menu	44	View the Firmware Revision	58
Configure the IP Address of the Terminal	46	Display Terminal Diagnostics	59
Configure a DNS Address for the Terminal	48	Enable the VNC Server	60
Configure the Ethernet Port	49	Load an Application from Removable Media	61
View the Network Diagnostics	50	Reboot the Terminal	62
Export a Data Log	51	Change the Date and Time	63
Adjust the Brightness of the Display	52	View General Information for the Configured Controller	64

### Runtime Environment

During runtime, the PanelView™ 5310 terminal runs HMI projects. A project is configured and downloaded to your terminal from the View Designer application. The project launches each time that the terminal restarts.

The terminal exchanges data values with the controller, animates the displayed data, and responds when you press keys or touch a screen or element on a screen.

During runtime, you can perform these tasks:

- Navigate screens and their graphic elements
- View and manage alarms
- View and perform operations on a trend chart
- Display error information
- Configure terminal settings and view diagnostic information

Here is an example of a screen in a project that is downloaded to the terminal.



Item	Name	Description
1	Alarm status indicator button	Opens the Alarm Summary screen. A button on the screen turns red and flashes when there are active alarms that are unacknowledged. The button returns to its pictured default state with a gray icon when all alarms return to normal, even if alarms are unacknowledged.
2	Unacked (unacknowledged) number	Displays the number of unacknowledged alarms in the project, regardless of the inhibit state of the alarms.
3	Previous button	Opens the previous screen in the navigation history of the terminal.
4	Next button	Opens the next screen in the navigation history of the terminal. <b>IMPORTANT:</b> Using the Next button requires that a previous screen is first displayed.
5	Navigation button	Displays the navigation menu at the bottom of the screen. Use the Navigation menu to display shortcuts and folder contents.
6	Log On	Logs you on and off the project. The name of the logged-on user appears in the system banner. <b>IMPORTANT:</b> The logged-on user sees only the screens for which the user has access.
7	Data Log status	Appears only if a data log is configured for the project. Tap the icon to open the Data Log popup for status details.
8	Network status	Appears only if there is an issue with network communication. Tap the icon to open the Device Configuration Network popup for details about the issue.
9	Controller status	Appears only if there is an issue with the controller. Tap the icon to open the Controllers popup for details about the issue.
10	Time and date	Displays the current time and date.
11	System banner	Appears at the top of each screen in a project.
12	Project screen	Displays screens, shortcuts, and popups of a project that is created in the View Designer application.
13	Navigation menu	Displays menu items that you have access to when you are logged in. To display the navigation menu, press the Navigation button below the screen or in the system banner above the screen. You can tap to menu items to open the screens of the project. Tap a menu item to display that project in the screen. The navigation menu also provides access to the Settings menu for the terminal.



## Enter Data With Virtual Keyboards

The virtual keyboard or virtual numeric keypad opens during runtime when text or numeric input is required.

- The virtual keyboard opens on the PanelView 5310 terminal screen when you tap a field or element that requires text or numeric input.
- The virtual numeric keypad opens on the PanelView 5310 terminal screen when you tap a field or element that requires only numeric input.

**Figure 8 - Virtual Keyboard**

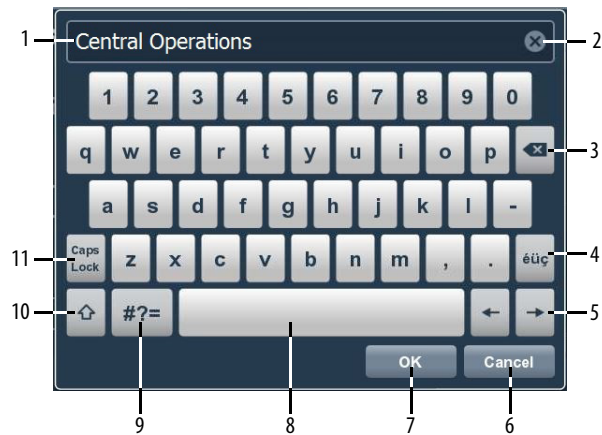

**Table 15 - Virtual Keyboard Description**

Item	Feature	Description
1	Text entry field	Tap the letters, numbers, and character keys to enter text into this field. The text entry field is always active when the keyboard is open.
2	Clear	Tap this button to remove all characters that are entered in the text entry field.
3	Backspace	Tap this key to delete one character to the left at a time.
4	éüç	Tap this key to toggle between Roman characters and alpha-European characters. Numeric keys are not part of the alpha-European keyboard.
5	Arrow keys	Tap the left arrow key to move the cursor one space to the left. Tap the right arrow key to move the cursor one space to the right.
6	Cancel	Tap Cancel to cancel the entry.
7	OK	Tap OK to complete the entry.
8	Space bar	Tap the space bar to enter a space in the text entry field.
9	#?= ABC	Tap this key to toggle between symbols and alpha-numeric characters: <ul style="list-style-type: none"> <li>• When in symbol mode, the key displays as ABC.</li> <li>• When in alpha-numeric mode, the key displays as #?=. </li> </ul>
10	Shift	Tap this key to toggle the keyboard between uppercase and lowercase letters. The keyboard returns to lowercase characters after one character has been entered.
11	Caps lock	Tap this key to toggle the keyboard between uppercase or lowercase letters. The keyboard remains in the selected state until you tap this key again.

Figure 9 - Virtual Numeric Keypad

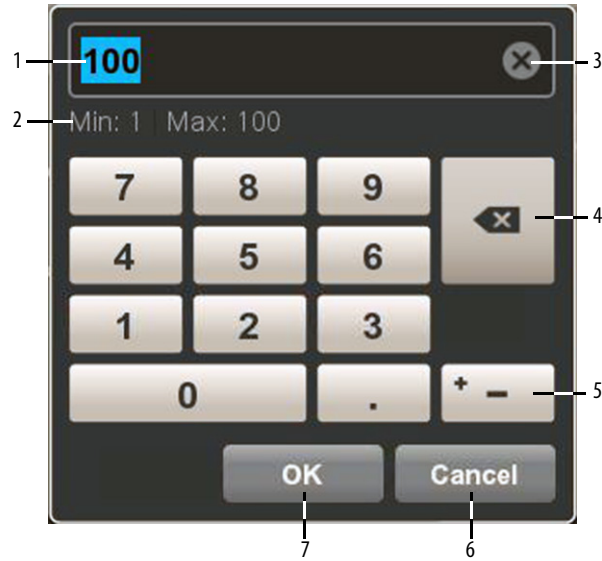

Table 16 - Virtual Numeric Keypad Description

Item	Feature	Description
1	Numeric entry field	The numeric entry field into which you type the numeric value for the graphic element.
2	Min-Max value	The displayed minimum and maximum values you can enter for the selected field or element.
3	Clear	Tap the X to remove all numbers that are entered into the numeric entry field.
4	Backspace	Tap the backspace button to delete one number to the left at a time.
5	+ _	Tap the positive-negative value button to toggle between a positive or negative number.
6	Cancel	Tap Cancel to cancel the entry.
7	OK	Tap OK to complete the entry.

## Log On to the Terminal

When you log on to the terminal, the screens that you have security access to appear as items in the navigation menu. For example, if you have been assigned the administrator role, all screens that have administrator access appear in the navigation menu.

- TIP**
- The Guest user is logged on automatically at system startup. Anyone that is not logged on to the system can view or access only those screens assigned the level of security that is given to the Guest user account.
  - Screen security and user roles are assigned in Studio 5000 View Designer® and cannot be modified on the PanelView 5310 terminal.

To log on to the terminal, follow these steps.

1. In the system banner at the top of the screen, tap  .

The Log On dialog box opens.

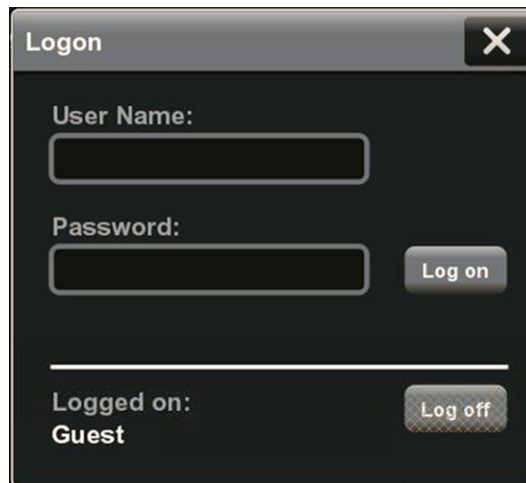

2. Tap the User Name field.  
The virtual keyboard opens.
3. To enter your user name with no spaces, tap the keys.
4. Tap OK.
5. Tap the Password field.  
The virtual keyboard opens.
6. To enter your password with no spaces, tap the keys.  
Passwords are case-sensitive.
7. Tap OK.
8. Tap Log on.

The Log On dialog box closes and your user name appears on the Log On button on the status banner.

- TIP**
- You can only be logged on as one user at a time.
  - If you are already logged on to the terminal, you can log on as another user. Open the Log On dialog box, enter another user name and password, then tap Log On.

## Log Off of the Terminal

When you log off, these actions occur:

- The Guest user is logged in by default.
- If the Guest user has access to the current screen, the terminal continues to display the current screen.
- If the Guest user does not have access to the current screen, the Home screen for the project is displayed.

To log off the terminal, follow these steps.

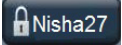
1. In the status banner at the top of the screen, tap  that shows your user name.

The Log On dialog box opens.

2. Tap Log Off.

You are logged off the terminal.

## Settings Menu

You can access configuration parameters and systemwide information for the terminal from the Navigation menu.

To open the Settings menu, follow these steps.

1. On an application screen, press .

2. On the Settings screen, tab to the menu item and press Enter.

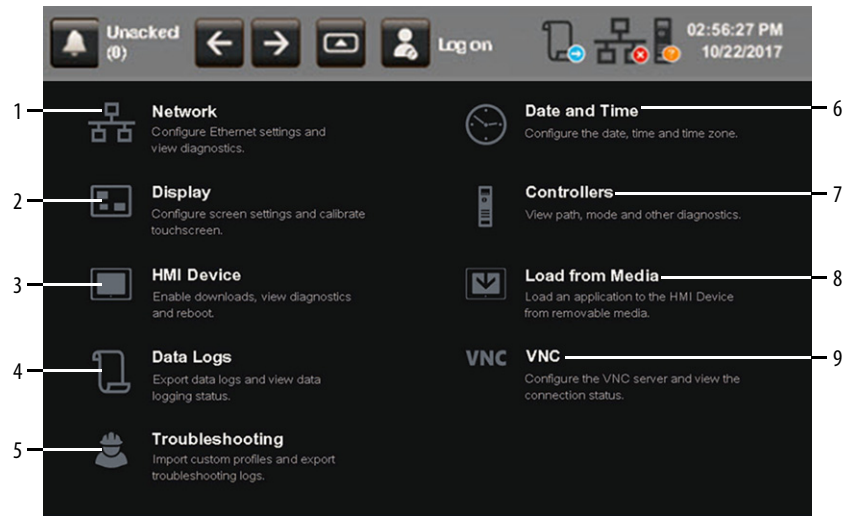

Item	Menu Topic	Tasks That You Can Perform
1	Network	<ul style="list-style-type: none"> <li>• Configure a static or dynamic device IP address</li> <li>• Configure Ethernet Link 1 settings</li> <li>• View network diagnostics</li> </ul>
2	Display	<ul style="list-style-type: none"> <li>• Adjust the brightness of the display</li> <li>• Enable or disable the screen saver</li> <li>• Configure the screen saver settings</li> <li>• Calibrate the touch screen</li> </ul>
3	HMI Device	<ul style="list-style-type: none"> <li>• Enable or disable downloads and firmware updates</li> <li>• Enter an HMI device name</li> <li>• View the catalog number and current firmware revision</li> <li>• View terminal diagnostic information</li> <li>• Restart the terminal</li> </ul>
4	Data Logs	<ul style="list-style-type: none"> <li>• Export data logs</li> <li>• Remove the SD™ or SDHC™ card safely</li> <li>• View data logging status</li> </ul>
5	Troubleshooting	<ul style="list-style-type: none"> <li>• Select a default or imported profile for troubleshooting</li> <li>• Save the troubleshooting log to a USB drive or SD card for Rockwell Automation technical support</li> </ul>
6	Date and Time	<ul style="list-style-type: none"> <li>• Set the date and time on the terminal</li> <li>• Set the time zone on the terminal</li> </ul>
7	Controllers	<ul style="list-style-type: none"> <li>• View general information for the controller</li> <li>• View diagnostic information for the controller</li> </ul>
8	Load from Media	<ul style="list-style-type: none"> <li>• Load an application to the HMI device from removable media</li> </ul>
9	VNC	<ul style="list-style-type: none"> <li>• Configure the VNC server and view the connection status</li> </ul>

## Configure the IP Address of the Terminal

You can configure the IP address of the terminal to use the Dynamic Host Configuration Protocol (DHCP), or manually configure a static IP address.



A project is downloaded to the terminal from the View Designer software through the IP address of the terminal.

**TIP** You cannot configure network IP addresses in the View Designer software.

### Use DHCP to Assign an IP Address for the Terminal

In a DHCP configuration, the network assigns the IP address, subnet mask, and default gateway address fields.

To configure DHCP for the terminal, follow these steps.

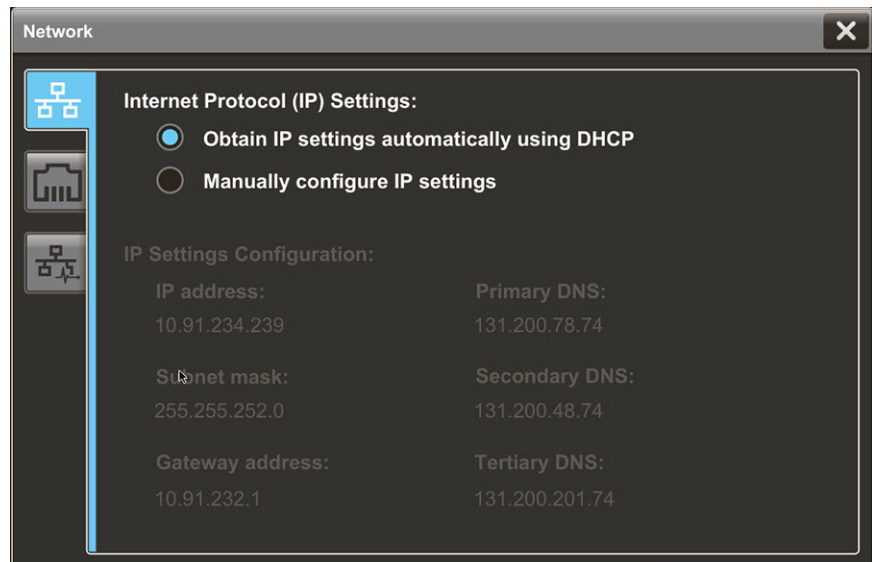

1. On an application screen, press .
2. On the Settings screen, tap .
3. Tap the Obtain IP settings automatically using DHCP radio button.



4. To close the window, tap .

## Assign a Static IP Address for the Terminal

To assign a static IP address for the terminal, follow these steps.

1. On an application screen, press .
2. On the Settings screen, tap .
3. Tap the Manually configure IP settings radio button.

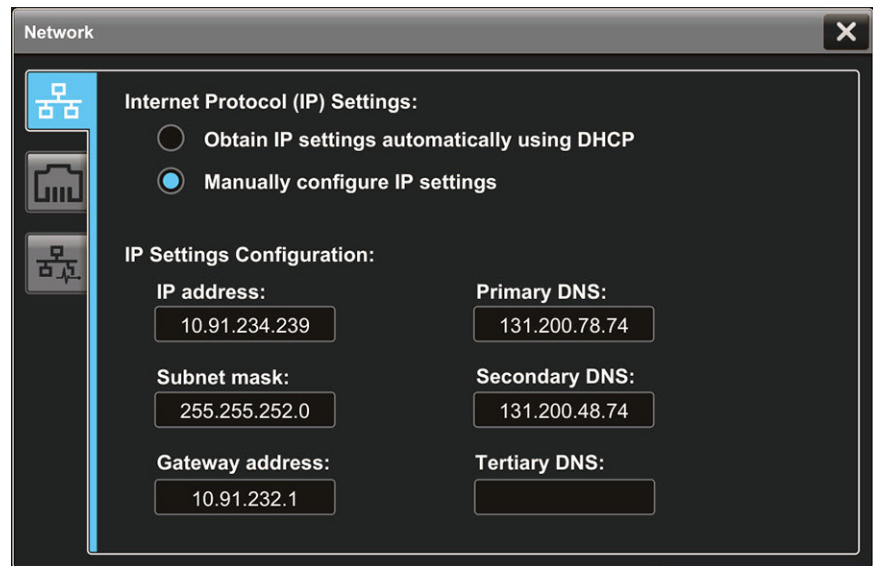

Follow these guidelines to assign the IP Settings Configuration.

Parameter	Description
IP address	The range of values for the first set of numbers is 1...255. The range of values for last three sets of numbers is 0...255
Subnet mask	The subnet mask address must be identical to server subnet mask.
Gateway address	Optional address.



4. Tap the IP address field.  
The virtual keyboard opens.
5. To enter the IP address, use the virtual keyboard.
6. Tap OK to close the virtual keyboard.
7. Repeat steps 4...6 for the subnet mask and the Gateway address fields.
8. To close the window, tap .

## Configure a DNS Address for the Terminal

The domain name system (DNS) translates Internet domain and host names to IP addresses. DNS automatically converts a name that is typed in a web browser address bar to the IP addresses of web server that host that site. You can configure DNS addresses for common domain or host names.

**TIP** You cannot configure DNS addresses within the View Designer software.

To configure a DNS address for the terminal, follow these steps.

1. On an application screen, press .
2. On the Settings screen, tap .
3. Tap the Manually configure IP settings radio button.

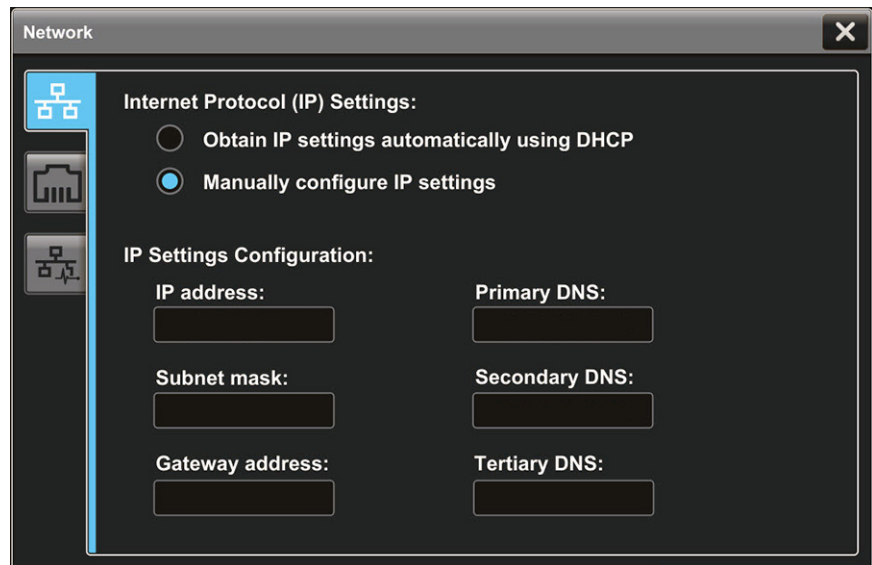

Follow these guidelines to assign the DNS settings.

Parameter	Description
Primary DNS	The range of values for this address is 0...255
Secondary DNS	The range of values for this address is 0...255
Tertiary DNS	The range of values for this address is 0...255

4. Tap the Primary DNS field.  
The virtual keyboard opens.
5. To enter the DNS address, use the virtual keyboard.
6. Tap OK to close the virtual keyboard.
7. Repeat steps 4...6 for the Secondary DNS and the Tertiary DNS fields.
8. To close the window, tap .



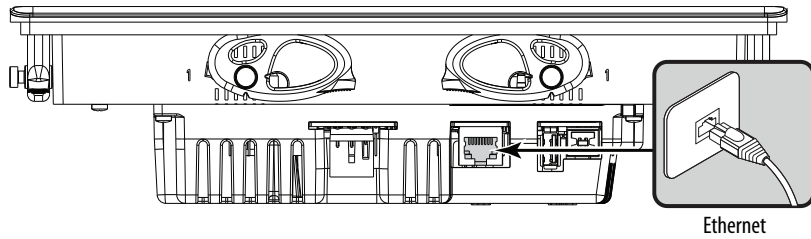

## Configure the Ethernet Port

You can configure the link speed and duplex mode for the Ethernet port on the terminal. The port is identified as Ethernet Link 1.



**TIP** You cannot configure the Ethernet port within the View Designer software.

To view or change the link settings of the Ethernet port, follow these steps.

1. On an application screen, press .
2. On the Settings screen, tap .
3. Tap the Ethernet icon.

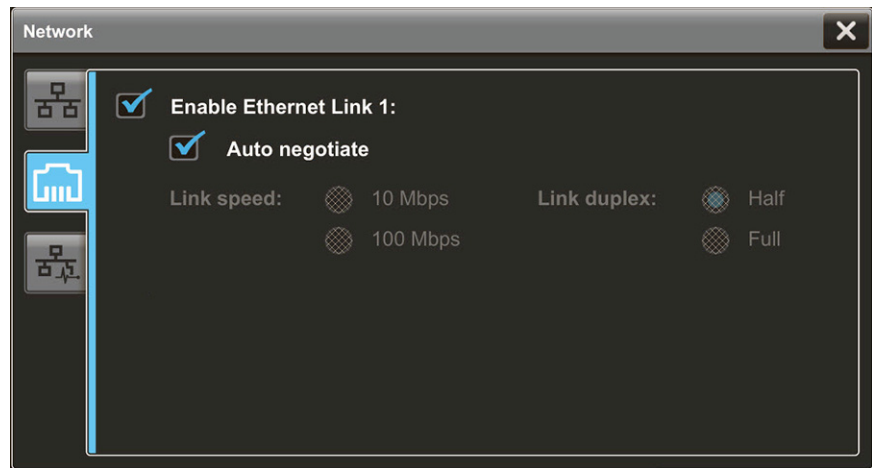



4. Select the Ethernet options for your network configuration:
  - Tap the Enable Ethernet Link 1 checkbox to add or remove the check mark. The option is enabled when the box is checked.
  - To set the speed and duplex options that are based on the network connection, tap the Auto negotiate checkbox. The option is enabled when the box is checked.
  - To set the speed and duplex options, tap the Auto negotiate checkbox to remove the check mark from the box. Then tap the speed and duplex options for your network.
5. To close the window, tap .

## View the Network Diagnostics

From the Network Diagnostics screen, you can view Ethernet Link 1 network connection data, network status data, and IP settings configuration data.

To view the Network Diagnostics screen, follow these steps.

1. On an application screen, press .
2. On the Settings screen, tap .
3. Tap the network diagnostic icon.

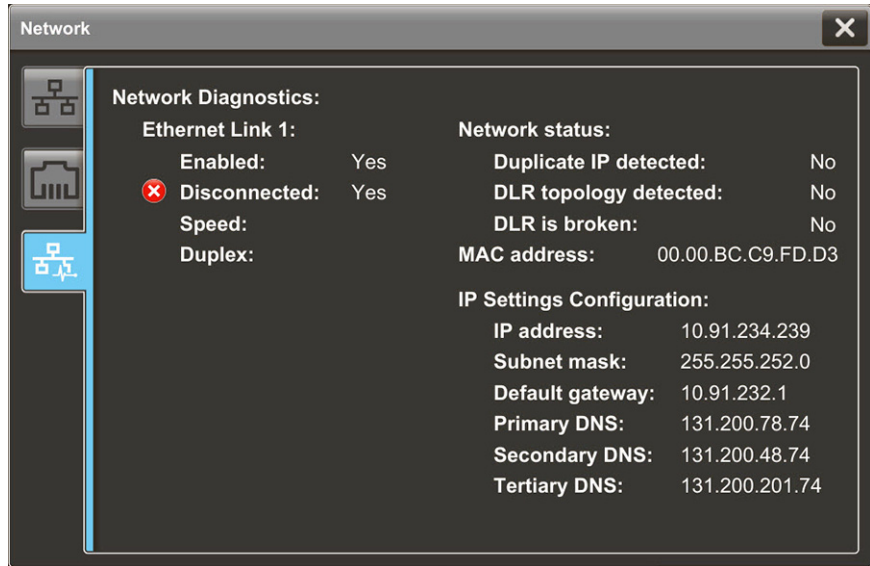



4. To close the window, tap .

## Export a Data Log



You can export a configured data log from the terminal to removable media to view tag values collected on the terminal. The exported ZIP file contains individual CSV files for each data log in the project. You can then open the exported data log file on a personal computer to view the values in the data log.

To export a data log to removable media, follow these steps.

**IMPORTANT** Before you can export a data log, verify that a FAT32-formatted USB device or SD card is inserted in the terminal.

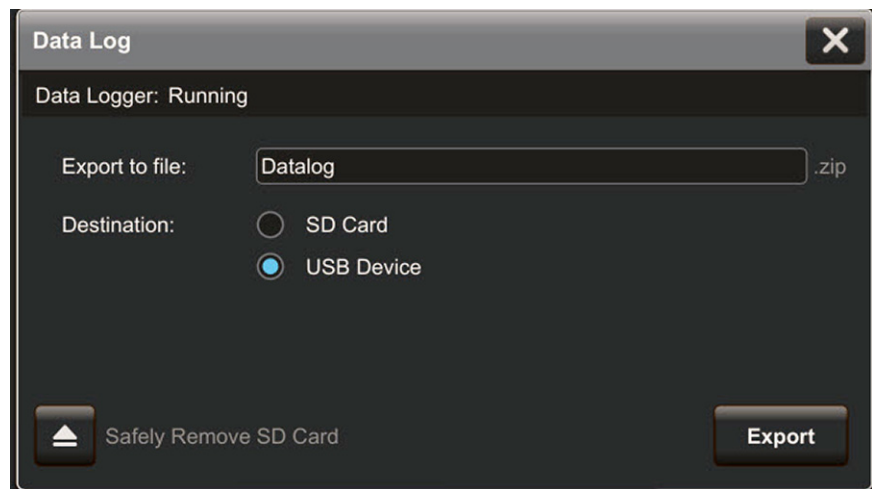
1. On an application screen, press .
2. On the Settings screen, tap .



3. In the Export to file box, type a name for the export file.  
Datalog is the default name.
4. Under Destination, select the media type.
5. Tap Export.  
A progress bar appears to show export progress, and a data log popup displays the date and time of the last exported data log.
6. If an SD card is used, verify the following before you remove the media:
  - a. After the data export completes and the progress bar disappears, tap  Safely Remove SD Card.
  - b. Verify that the Data Logger status changes from Running to Remove SD card.
  - c. You can safely remove the SD card.
7. To close the window, tap .

## Adjust the Brightness of the Display

You can adjust the brightness level of the terminal display in increments from 1...100%.

- 1% is the minimum display visibility.
- 100% is the maximum display visibility.



**TIP** Lower the brightness level to reduce the power that the backlight consumes, and extend the life of the backlight.

These tags can also be set to control backlight brightness level:

::Local:HMIDevice.Display.BacklightIntensity

::Local:HMIDevice.Display.ScreenSaverIntensity

To adjust the brightness of the display, follow these steps.

1. On an application screen, press .
2. On the Settings screen, tap .
3. Tap the Brightness field.

The virtual numeric keypad opens.





4. Enter the value for the brightness in increments from 1...100%.
5. Tap OK.
6. To close the window, tap .

## Configure the Display Screen Saver

The screen saver extends the life of the back light by dimming the brightness level when activity is not sensed for a specified amount of time. When the screen saver is activated, the terminal displays a moving image at a reduced brightness level. When user input is sensed, the screen saver is deactivated and the display brightness returns to its configured level.

**TIP** After the screen saver is deactivated, touch or keypad input is ignored for at least 0.5 seconds.

To configure the brightness and screen saver for the display, follow these steps.

1. On an application screen, press .
2. On the Settings screen, tap .

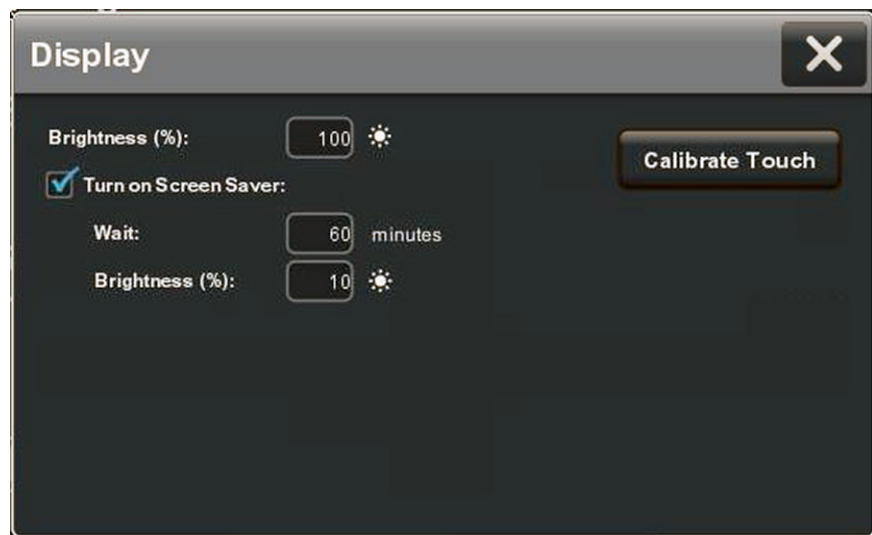

3. To add or remove the check mark next to Turn on Screen Saver, tap the checkbox.  
The option is enabled when the box is checked.
4. Tap the Wait field.  
The virtual numeric keyboard opens.
5. Enter the number of continuous, idle minutes from 1...5999 to wait before activating the screen saver.  
The default is 10 minutes.
6. Tap OK.
7. Tap the Brightness (%) field.  
The virtual numeric keyboard opens.
8. Enter the value for the brightness in increments from 1...100%.
9. Tap OK.
10. To close the window, tap .



## Calibrate the Touch Screen

The touch screen is calibrated at the factory. After installation, you can recalibrate the touch screen to compensate for parallax if the screen is viewed at an angle.

The calibration process requires you to touch a series of targets on the screen.

**IMPORTANT** For accuracy and to help prevent damage to the touch screen, use a plastic stylus device with a minimum tip radius of 1.3 mm (0.051 in.).

To calibrate the touch screen, follow these steps.

1. On an application screen, press .
2. On the Settings screen, tap .

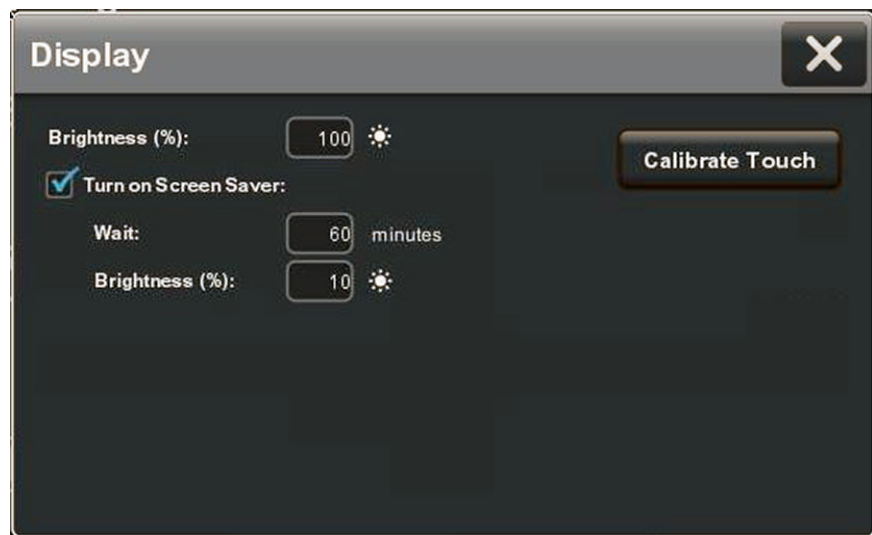

3. Tap .

A red target appears on the screen.

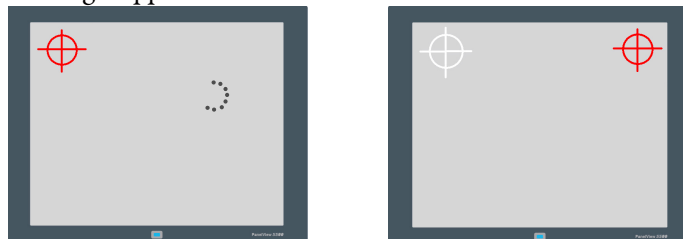

4. Press and hold the center of the target until the target completes the circle.

The next target appears.

**TIP** Touch inside the target areas before the progress indicator completes a circle.

5. Continue to press and hold the centers of all remaining targets as they appear.

All processed targets are replaced with white targets.

A green circle with a check indicates a successful calibration.

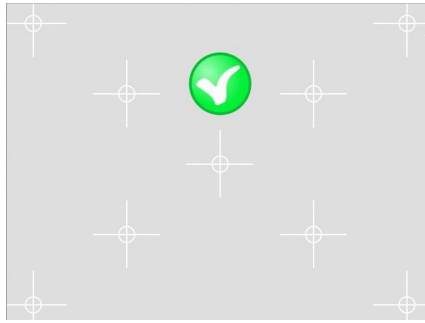

A red circle with an X indicates a failed calibration.

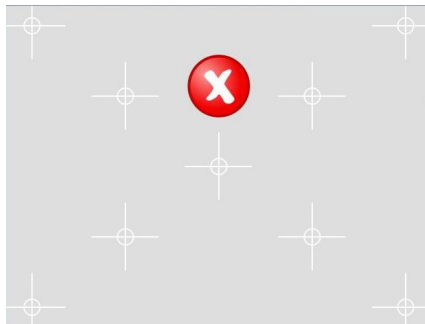

If the calibration fails, the process automatically repeats. Continue the calibration until the calibration is successful.



**TIP** The calibration is retained after a reset or power cycle.

6. Tap OK.
7. To close the window, tap .

## Disable Downloads to the Terminal

As a security measure, you can disable downloads to the terminal, including application downloads and firmware updates. Disable downloads to help prevent the current application from being replaced when an application is downloaded from the View Designer application.

To disable downloads to the terminal, follow these steps.

1. On an application screen, press .
2. On the Settings screen, tap .

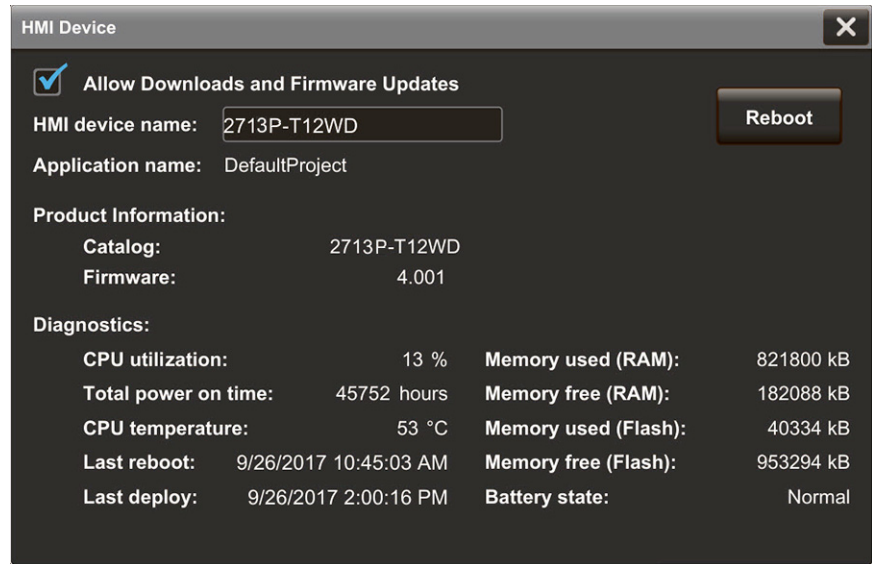

3. Tap the Allow Downloads and Firmware Updates checkbox to clear the checkbox.
  - Downloads are not permitted when the checkbox is cleared.
  - Downloads are permitted when the checkbox is checked.
4. To close the window, tap .

While this setting is unchecked, you cannot download another application to the terminal or update the terminal firmware.



Attempts to download an application from the View Designer application results in an error.



## Change the HMI Device Name

Each terminal has a unique default HMI device name that identifies it to other devices on the network. You can view or change this name.

To view or change the HMI device name, follow these steps.

1. On an application screen, press .
2. On the Settings screen, tap .

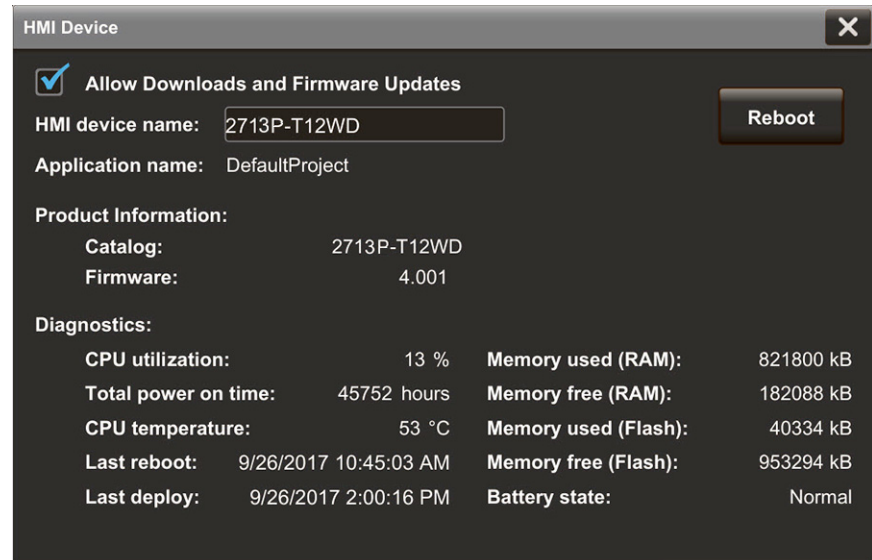

The HMI device name field shows the current name.

3. Tap the HMI device name field.  
The virtual keyboard opens.
4. To enter or modify the current name, tap the virtual keyboard keys.



- TIP**
- You can enter up to 15 characters including letters, numbers, and hyphens.
  - The first character of the terminal name must be an upper or lowercase letter.

5. Tap OK.
6. To close the window, tap .

## View the Firmware Revision

You can view the current firmware revision on the terminal. You need this information for firmware updates, or when you call technical support.

To view the firmware revision, follow these steps.

1. On an application screen, press .
2. On the Settings screen, tap .

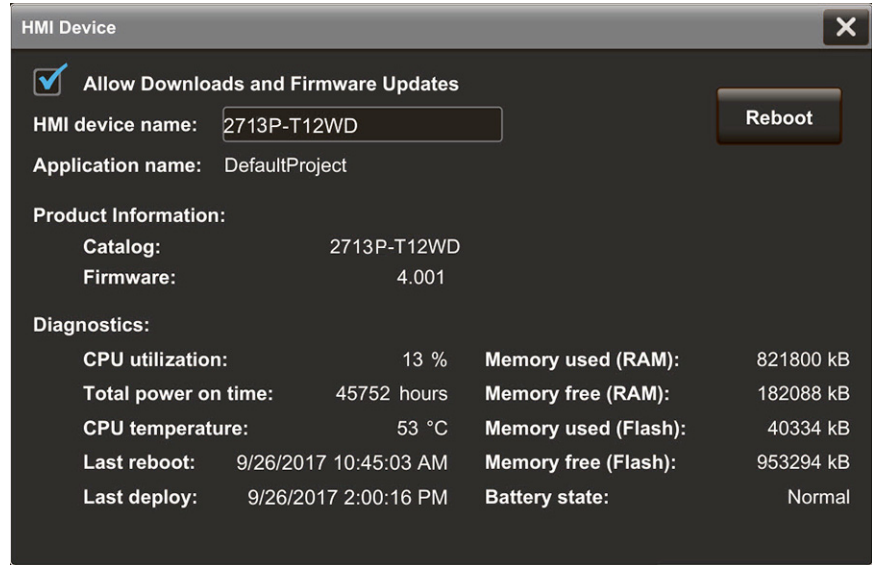



View the firmware revision under Product Information.

3. To close the window, tap .

## Display Terminal Diagnostics

To view the diagnostic data for the terminal, follow these steps.

1. On an application screen, press .
2. On the Settings screen, tap .

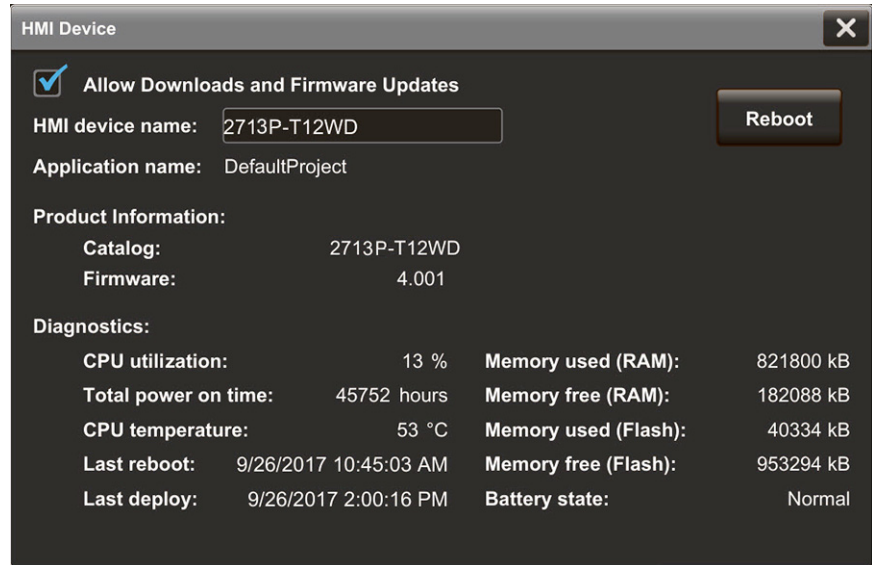

3. View the information under Diagnostics.

Diagnostic Parameter	Description
CPU utilization	The processor usage.
Total power on time	The total time the terminal has been running (powered).
CPU temperature	Displays the current temperature of the CPU: <ul style="list-style-type: none"> <li>• Normal: 25...94 °C (77...201 °F)</li> <li>• High: 100 °C (212 °F) and higher</li> </ul> An over-temperature condition of 105...110 °C (221...230 °F) causes a delayed automatic system restart. The restarts continue indefinitely until the system is cool enough to resume normal operation.
Last reboot	Displays the date and time for the most recent restart of the terminal.
Last deploy	Displays the date and time of the most recent project application download.
Memory used (RAM)	The total RAM memory that is in use.
Memory free (RAM)	The total RAM memory that is remaining.
Memory used (Flash)	The total nonvolatile memory that is in use.
Memory free (Flash)	The total nonvolatile memory that is remaining.
Battery state	<ul style="list-style-type: none"> <li>• Normal</li> <li>• Low</li> <li>• Depleted</li> </ul>

4. To close the window, tap .

## Enable the VNC Server

You can enable VNC to connect remotely to a PanelView 5310 terminal. Use the Remote Connectivity screen to enable or disable the VNC server.

To enable or disable a VNC connection, follow these steps.

1. On an application screen, press .
2. On the Settings screen, tap **VNC**.

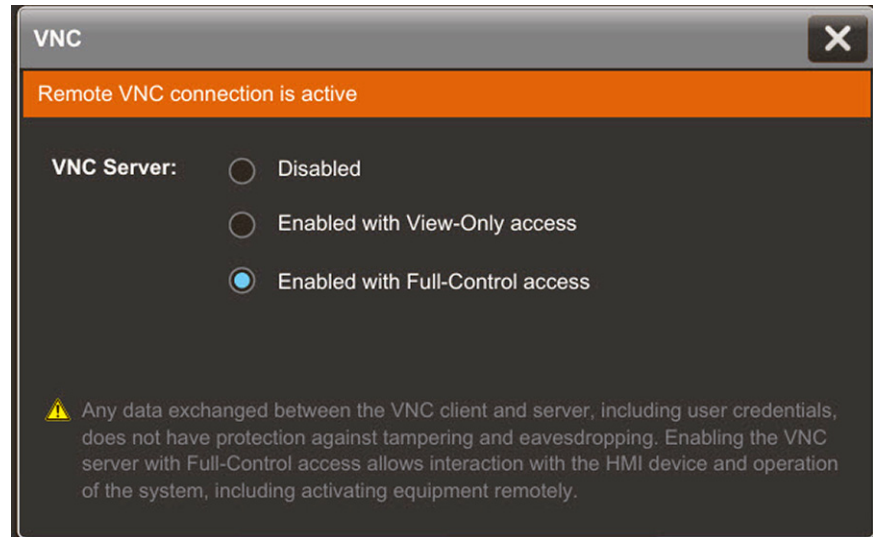

3. Select an access:
  - **Disabled:** Disables the VNC server
  - **Enabled with view-only access:** You can only view content on the HMI device
  - **Enabled with full-control access:** You can view content and interact with the HMI device

**TIP** A warning displays with full-control access that the full-control connection is unprotected.

4. To close the window, tap .

## Load an Application from Removable Media



You can load a runtime application from removable media to the HMI device.

To load a runtime application from removable media, follow these steps.

1. Insert a USB storage device or SD card with the runtime application into the HMI device.

**IMPORTANT** Verify the following before you insert removable media into the terminal:

- The format is FAT32 for the USB device or the SD card
- The media has write permissions and sufficient space

2. On an application screen, press .
3. On the Settings screen, tap .

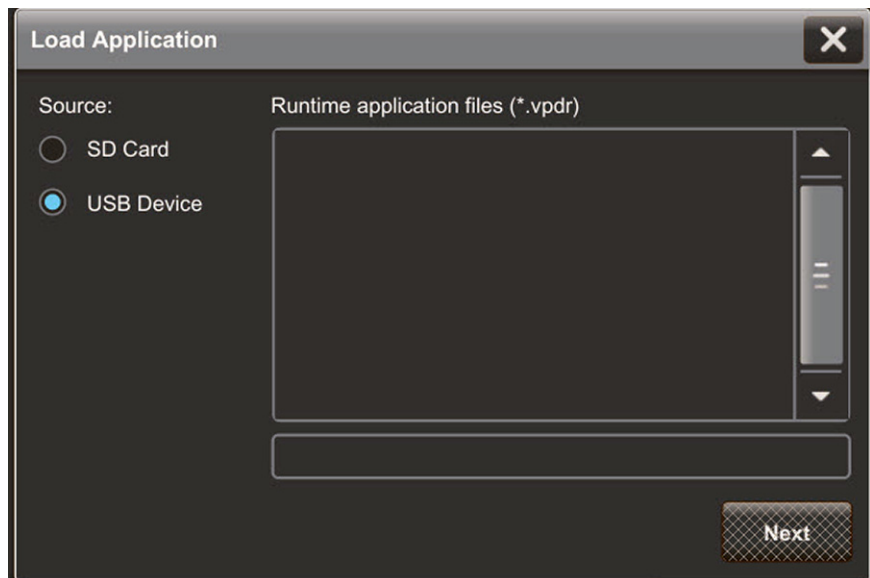

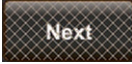
4. Select the appropriate source.
5. From the Runtime application files panel, select the runtime application to load.
6. The application appears in the box underneath the Runtime application files panel.
7. Tap .
8. Under HMI to controller path, specify the path to use to load the runtime application:
  - **Keep path currently in use on HMI device:** Use the controller path currently used on the HMI device; the current HMI to controller path appears
  - **Load path defined in the runtime application file:** Use the controller path configured in the runtime application on the removable media

9. Tap Load.



The Home screen of the runtime application opens on the HMI device.

**TIP** If an event exists to load an application, performing that event loads the application.

10. To close the window, tap .

## Reboot the Terminal

To restart the terminal, follow these steps.

1. On an application screen, press .
2. On the Settings screen, tap .

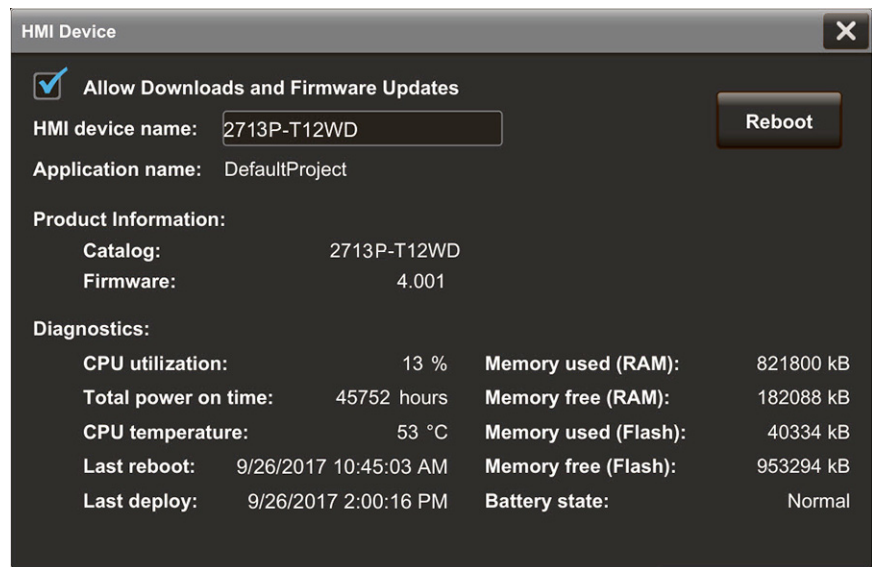

3. Tap .

You are prompted to confirm the reboot.

4. To reboot the terminal, tap Yes.



If you tap Yes to reboot the terminal, it restarts and displays the project that is downloaded to the terminal.

To cancel, tap No, and then tap  to close the window.

## Change the Date and Time

You can change the date and time that is used for terminal operations. The date and time is displayed on the terminal screen and recorded in log files. You can also change the time zone for the terminal.

To change the date and time that is used for terminal operations, follow these steps.

1. On an application screen, press .
2. On the Settings screen, tap .

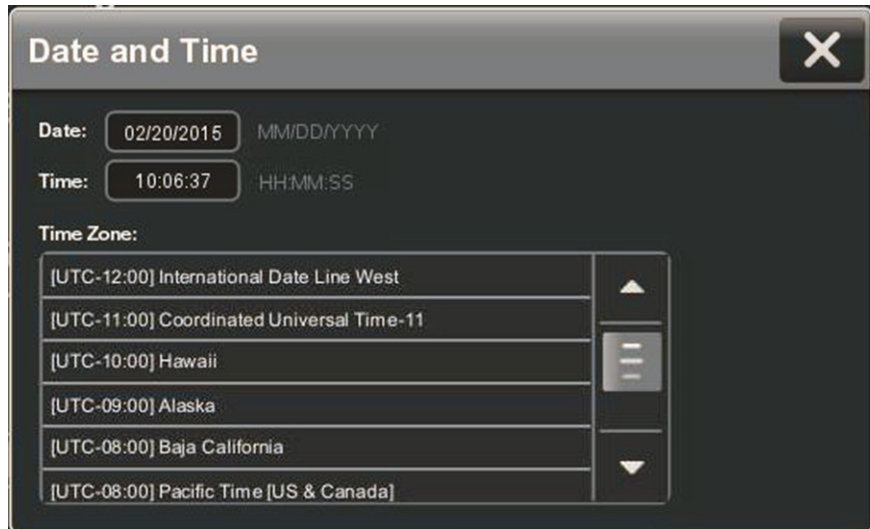

3. Change the Date and Time fields as appropriate.
  - a. Tap a Date or Time field.  
The virtual keyboard opens.
  - b. Enter a value and tap OK.

Date and Time Parameters		Valid Values
Date MM/DD/YYYY Enter the date format including the '/' characters.	Year	Up to 2999
	Month	1...12
	Day	0...31
Time HH:MM:SS (24-hour format) Enter the time format including the ':' characters.	Hour	0...23
	Minute	0...60
	Second	0...60

4. Change the time zone, if desired.
  - a. To move up and down the list, press and drag the scroll bar (or press and hold an arrow button).  
Or tab to the list and use the arrows keys on the physical keypad of the terminal.
  - b. Tap the time zone for the terminal.  
The time on the terminal is adjusted to match the selected time zone.
5. To close the window, tap .

## View General Information for the Configured Controller

You can view general information for the controller that is configured to operate with the terminal.

To view the general information for the controller, follow these steps.

1. On an application screen, press .
2. On the Settings screen, tap Controllers.



The general information for the controller includes these data.

Data Type	Description
Reference	The name of the controller reference that is configured in the View Designer application. The name does not appear if a controller is not configured for the project.
Path	The communication path for the controller. The path does not appear if a controller is not configured for the project.
Controller name	The name of the controller that is configured in the Logix Designer application. The name does not appear if a controller is not configured for the project.
Tag information	The synchronization state to process changes from the controller. For example, the state can be Synchronized, Updating, or Detecting changes. Some tag information cannot appear if the controller tag information is not synchronized (UNINITIATED).
Mode	The operating mode of the controller. For example, the mode can be Run, Program, or Fault. The mode does not appear if the controller is disconnected from the network.
Catalog	The Catalog number of the controller. The catalog number does not appear if the controller is disconnected from the network.
Firmware	The major and minor revision numbers for the firmware in the controller. The firmware revision numbers do not appear if the controller is disconnected from the network.

3. To close the window, tap .



## Monitor and Manage Control System Alarms

Topic	Page
Alarm Indicator	65
Alarm Help Menu	66
View the Alarm Summary	68
Manage the Alarms	69
Alarm Detail Pane Descriptions	70
Filter the Alarms	72

### Alarm Indicator

The Unacked icon in the system banner displays the number of unacknowledged alarms for the system.

To open the alarm summary and view the system alarms, tap .





## Alarm Help Menu

To view a brief description of the alarm function keys and status counts, follow these steps.

1. Open the Alarm Summary ([page 68](#)) or Alarm Manager ([page 69](#)) screen.
2. Tap .

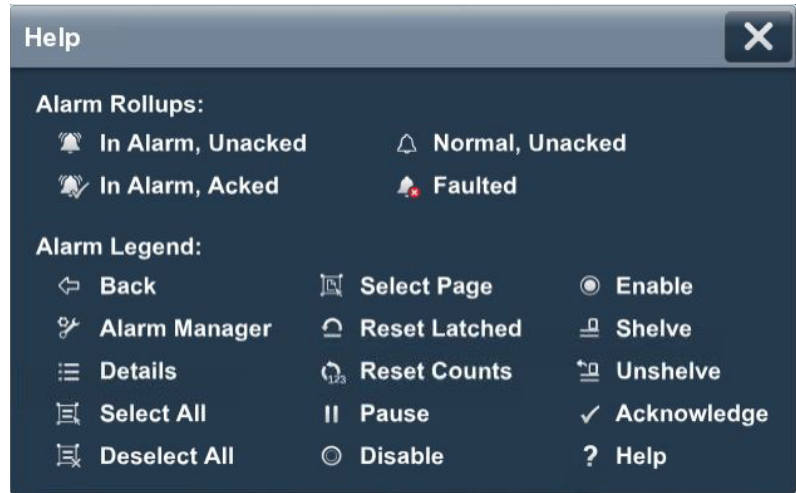





The Help window displays a brief description of the alarm function keys and status counts.















3. To close the window, tap .

See [Table 17](#) for a detailed description of the alarm function keys and alarm status counts.

**Table 17 - Alarm Function Key Descriptions**

Symbol	Function Key or Message	Description
	Acknowledge	Indicates that you are aware of the alarm. This button changes the state of the alarm from unacknowledged to acknowledged.
	Alarm Manager	Opens the alarm manager screen. The alarm manager lists all alarms that are configured in the system and their current states. Therefore, the alarm manager shows alarms that are not shown in the alarm summary, and provides additional tasks for alarms.
	Back	Opens the previously displayed screen. When you open the alarm manager screen from the alarm summary screen, this button reopens the alarm summary screen.
	Deselect All	Deselects all alarms in the alarm table, including the alarms that are not displayed on the current page of alarms.
	Details	Hides or shows the details pane, which contains the details of the last selected alarm. The details pane appears on the bottom half of large alarm tables and replaces the list of alarms in medium alarm tables. If no alarm is selected, the details pane is empty.
	Disable	Stops the alarm condition from being evaluated. In effect, turns off the selected alarm. You can only disable an entire alarm. You cannot disable an individual alarm condition.

**Table 17 - Alarm Function Key Descriptions (Continued)**

Symbol	Function Key or Message	Description
	Enable	Enables the selected alarms in the alarm manager table, which allows the alarm condition to be evaluated, which turns on the alarm. An enabled alarm enables all conditions for that alarm. You cannot enable an individual alarm condition.
	Faulted	Provides a count of the alarms in a faulted state.
	Help	Provides a description of the help buttons and alarm status.
	In Alarm, Acked	Provides a count of the alarms in an acknowledged state.
	In Alarm, Unacked	Provides a count of the alarms in an unacknowledged state.
	Normal, Unacked	Provides a count of the alarms where the input of the alarm has returned to normal, but the alarm has not yet been acknowledged.
	Pause	Stops updates to the alarm summary table for 10 seconds, or until another operation is performed on the table. While updates to the alarm summary table are paused, alarms in the controller are still evaluated. When the table is no longer paused, any changes to alarm states are reflected in the table and updates resume.
	Reset Counts	Resets the alarm count in the controller and the alarm count value in the details pane of the alarm manager table to zero. The reset is performed for all conditions of the currently selected alarm.
	Reset Latched	Sets the selected digital latched state of the alarm to normal if the input of the alarm has returned to normal. A reset of a digital latched alarm acknowledges the alarm, if it is not acknowledged.
	Select All	Selects all alarms in the alarm table, including the alarms that are not displayed on the current page of alarms.
	Select Page	Selects all alarms that are displayed on the current page of alarms.
	Shelve	Helps prevent the notification of new state changes to the selected alarm if the alarm is acknowledged. Updates to the alarm do not appear. The alarm remains shelved until the shelf duration from the controller expires automatically or you unshelve the alarm manually. Updates to the alarm then resume.  When you shelve an alarm in the alarm summary table, you shelve only the selected alarm conditions. When you shelve an alarm in the alarm manager table, you shelve all conditions of the alarm. From the condition list in the details pane of the alarm manager table, you can also shelve individual alarm conditions.
	Unshelve	Unshelves the selected alarm in the alarm manager table, which allows notification of new state changes to alarms. From the condition list in the details pane of the alarm manager table, unshelve individual alarm conditions.

## View the Alarm Summary

The alarm summary lists alarms that are in alarm or out of alarm but still unacknowledged. It displays one alarm condition per row. Use the alarm summary to monitor and interact with alarms.

To view the alarm summary for the control system, follow these steps.

1. On an application screen, press .

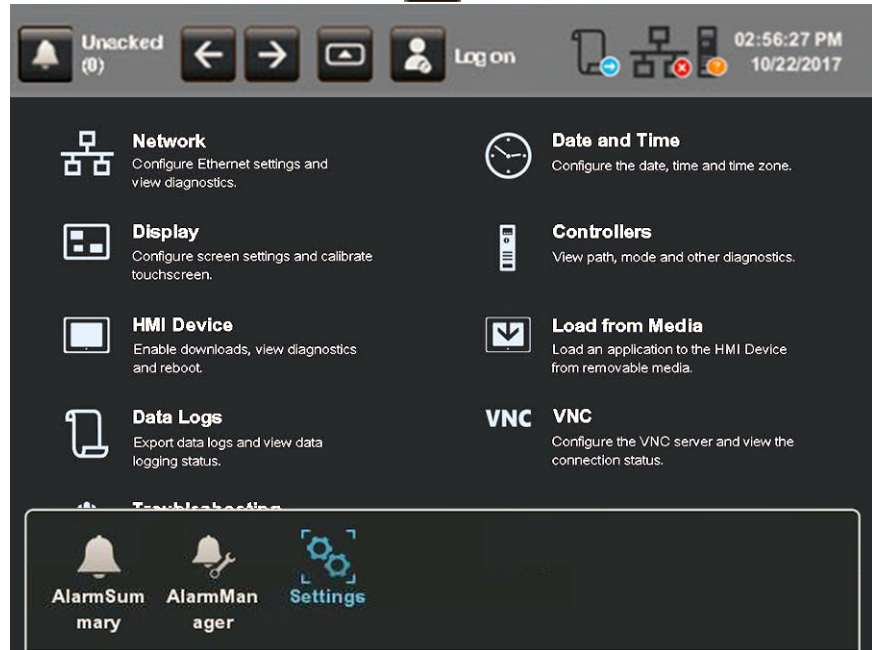

2. Tap , or tab to the menu item and press Enter.

3. To view the alarms, tap the alarm function keys.

See [Alarm Help Menu on page 66](#) for a description of the keys.

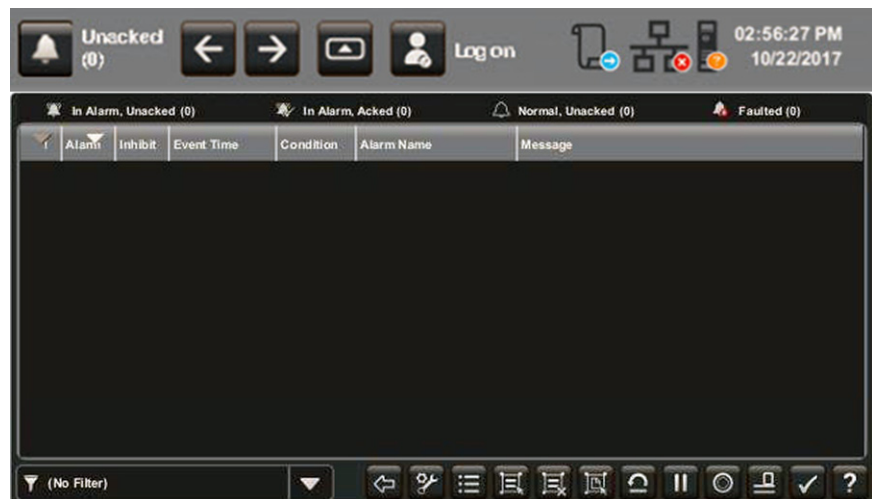

4. To return to the navigation menu, tap the navigation button on an application screen.
5. To return to the application screens, tap an application icon.

## Manage the Alarms

The Alarm Manager lists all alarms that are configured in a system and their current states.

To manage the alarms for the control system, follow these steps.

1. On an application screen, press .

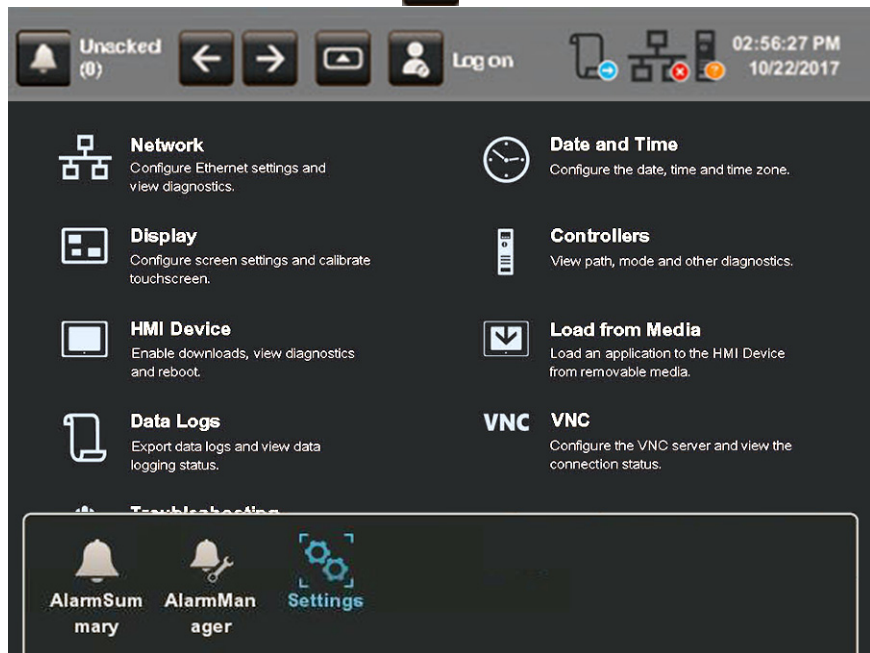

2. Tap  or tab to the menu item and press Enter.

3. To manage the alarms, tap the alarm function keys.

See [Alarm Help Menu on page 66](#) for a description of the keys.

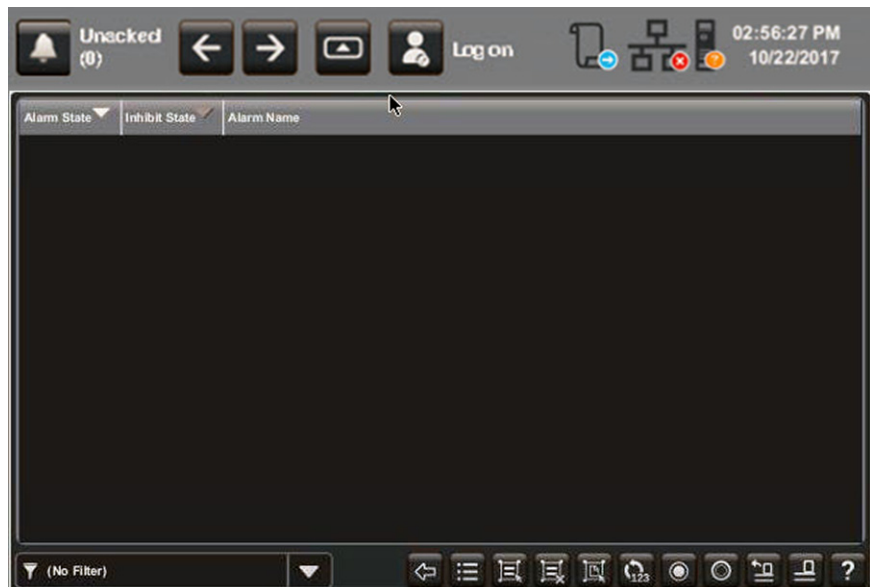

4. To return to the navigation menu, tap  on an application screen.
5. To return to the application screens, tap an application icon.

## Alarm Detail Pane Descriptions

The details pane shows details for the selected alarm condition of a selected alarm. Condition details display the selected alarm condition in the alarm manager table.

To view the details pane for a selected alarm, follow these steps.

1. Open the Alarm Summary ([page 68](#)) or Alarm Manager ([page 69](#)) screen.
2. Tap .

The details pane displays a list of alarm states and conditions.

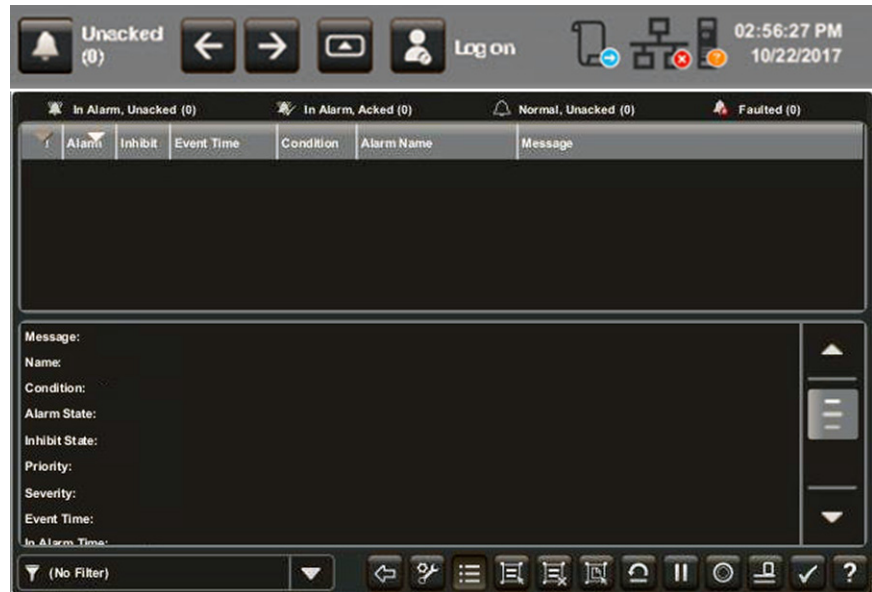





Tap  again to toggle off the details pane.

See [Table 18](#) for a description of the alarm details.

**Table 18 - Alarm Detail Descriptions**

Alarm Detail	Description
Acknowledge Time	The time the selected alarm was acknowledged.
Alarm Class	The user-defined class that is assigned to the alarm in the Studio 5000 Logix Designer project.
Alarm Count	The number of times the alarm condition has entered the In Alarm state.
Alarm State	The state of the alarm condition: <ul style="list-style-type: none"> <li>• Normal Unacknowledged (Normal, Unacked)</li> <li>• In Alarm Acknowledged (In Alarm, Acked)</li> <li>• In Alarm Unacknowledged (In Alarm, Unacked)</li> <li>• Normal Acknowledged (Acknowledged)</li> </ul>
Condition	<ul style="list-style-type: none"> <li>• Analog conditions include: HIHI, HI, LO, LOLO, ROC_POS, and ROC_NEG</li> <li>• Discrete conditions include: TRIP and TRIP_L</li> </ul>
Current Value	The current tag input value that results in the alarm state.
Disable Time	The time the selected alarm was disabled.
Enable Time	The time the selected alarm was enabled.

**Table 18 - Alarm Detail Descriptions (Continued)**

Alarm Detail	Description
Event Category	<ul style="list-style-type: none"> <li>Digital events are categorized as discrete.</li> <li>Analog events are categorized as level.</li> </ul>
Event Time	The date and time the alarm event occurred.
In Alarm Time	The time the selected alarm entered the In Alarm state.
Inhibit State	<p>The value that is applied to the alarm condition that inhibits the alarm at some level. These states, indicated by an icon in the alarm table, include:</p> <ul style="list-style-type: none"> <li>Bad Quality </li> <li>Disabled </li> <li>Suppressed </li> <li>Shelved </li> </ul> <p>These states can be combined. When an alarm has multiple inhibit states that are applied, the icon of the highest inhibit state appears in the table.</p>
Limit Value Exceeded	The condition limit that is assigned to the alarm in the Studio 5000 Logix Designer application project.
Max Shelve Duration	The maximum time the alarm can be shelved.
Message	The message that is assigned to the alarm in the Studio 5000 Logix Designer application project.
Name	<p>The name of the alarm. This name includes the controller name of the alarm and the tag name. It can also include the name of the program if the tag is defined at the program level. Therefore, the alarm name can be configured in these configurations:</p> <p>::ControllerName.TagName</p> <p>Or</p> <p>::ControllerName\ProgramName.TagName</p>
Out of Alarm Time	The time the selected alarm entered the Normal or Inactive state.
Priority	<p>The urgency of the alarm condition:</p> <ul style="list-style-type: none"> <li>Low</li> <li>Medium</li> <li>High</li> <li>Urgent</li> </ul>
Quality	The list of reasons why the alarm is of bad quality. This field is blank in the alarm summary because the alarm summary does not show bad quality alarms.
Severity	<p>The numeric value that is mapped to the assigned priority of the alarm condition:</p> <ul style="list-style-type: none"> <li>1...250 (low)</li> <li>251...500 (medium)</li> <li>501...750 (high)</li> <li>751...1000 (urgent)</li> </ul>
Shelve Duration	The default time for which the selected alarm condition is shelved to help prevent the notification of new state changes. Shelve duration is assigned to the alarm in the Studio 5000 Logix Designer project.
Shelve Time	The time the selected alarm was shelved.
Suppress Time	The time the selected alarm was suppressed.
Tag 1 Value	The value of the associated tag parameter 1.
Tag 2 Value	The value of the associated tag parameter 2.
Tag 3 Value	The value of the associated tag parameter 3.
Tag 4 Value	The value of the associated tag parameter 4.
Unshelve Time	The time the selected alarm was unshelved. If the alarm is shelved, this time is the time that the alarm is unshelved automatically when the shelve duration expires.
Unsuppress Time	The time the selected alarm was unsuppressed.

## Filter the Alarms

You can filter the alarms to view only the alarms in the selected alarm state.

To filter the alarms, follow these steps.

1. To the right of the filter field, tap .

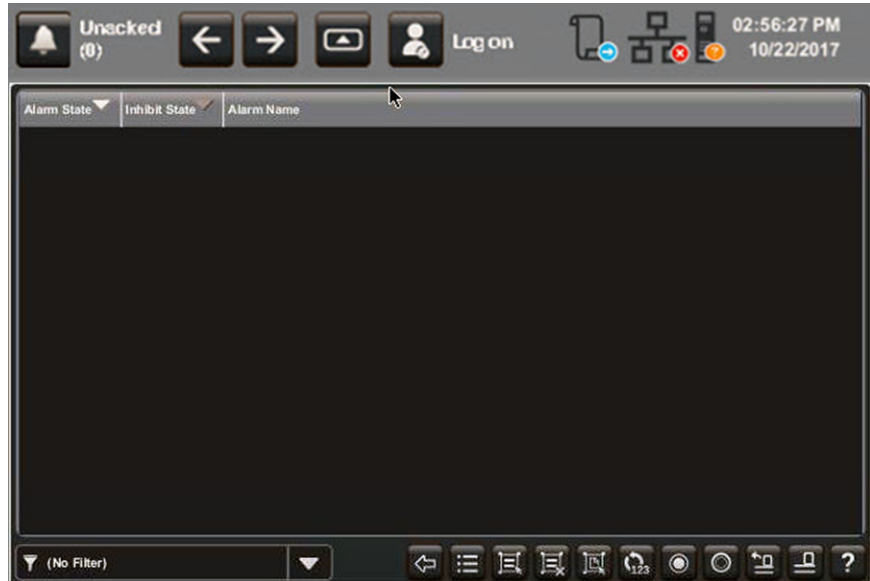

2. To scroll through the filter choices, tap the up or down arrows on the scroll bar.



3. Tap the alarm filter that you want to use.



The selected filter displays in the filter pull-down menu.

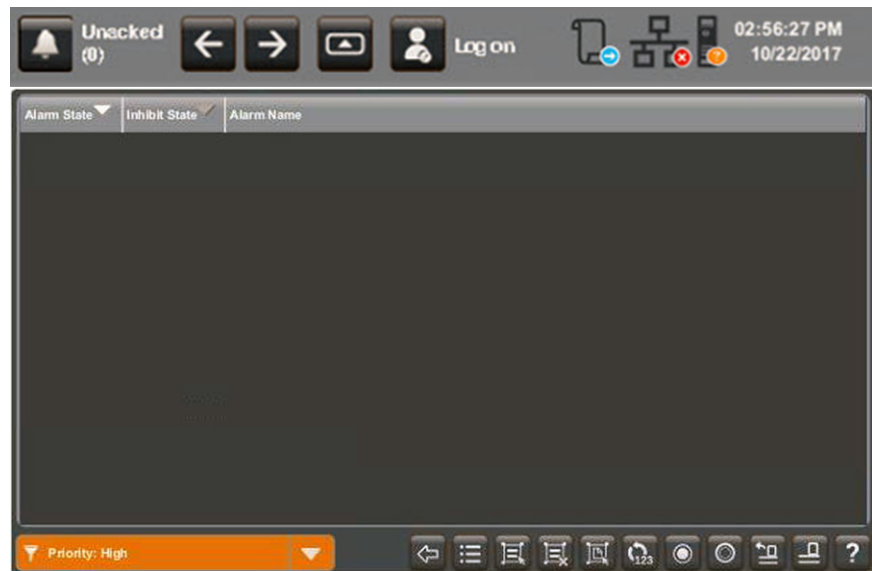

To change the filter, tap the filter pull-down menu and select another filter.

To turn off the filter, tap **Priority: High**.

**Notes:**

## Install and Replace Components

Topic	Page
Accessories and Replacement Parts	75
Voltage Precautions	75
Electrostatic Discharge Precautions	76
Connect to USB Ports	76
Insert an SD Card	77
Replace the Battery	78

### Accessories and Replacement Parts

You can view a list of accessories and replacement parts in [Table 3](#) through [Table 7](#) in [Chapter 1](#).

Review the specifications of a new component before you install it to verify that it is compatible with the terminal. Record the model, serial number, and any other pertinent information of new components for future reference.

---

**IMPORTANT** We recommend that you use only Allen-Bradley® approved accessories and replacement parts.

---

### Voltage Precautions

The terminals contain line voltages. Disconnect all power to the terminal before you install or remove components.



**SHOCK HAZARD:** Disconnect all power to the terminal before you remove components.

Failure to disconnect power can result in severe electrical shock to an individual or damage to the terminal.

---

## Electrostatic Discharge Precautions



**ATTENTION:** Electrostatic discharge (ESD) can damage static-sensitive devices or microcircuitry.

- Disconnect all power before you work on the terminal as detailed in [Voltage Precautions on page 75](#).
- Observe proper packaging and grounding techniques to help prevent damage.

Follow these ESD precautions when you handle this terminal:

- Touch a grounded object to discharge potential static.
- Use an anti-static wriststrap connected to the work surface.
- Use properly grounded tools and equipment.
- Avoid touching pins, leads, or circuitry.
- Always hold components with a printed circuit board (PCB) by its edges and place it with the assembly side down.

## Connect to USB Ports

Each terminal has one USB 2.0 (type A) host connection and one USB 2.0 (type B) device connection.

**IMPORTANT** The USB host connection is intended for temporary use with USB drives during deployment (user application file transfers) or maintenance (file transfers and troubleshooting profiles). It can be used with an external hub, keyboard, and mouse during runtime operations but it is not recommended for data logging or user application runtime files.

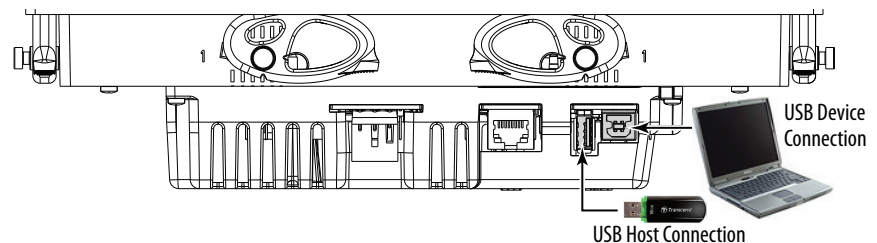

Icons identify the USB host connections. The USB host connection supports 0.5 A at 5V DC. Connected USB devices must not exceed this power load.

**Table 19 - USB Connector Pinout**

USB Port	USB Icon	USB Connector	Pin	Signal	Description
Host			1	VCC	+5V
			2	D-	Data -
Device			3	D+	Data +
			4	GND	Ground



**ATTENTION:** USB devices that are not powered by the USB port must adhere to the following:

- The USB device must be within the same enclosure as the terminal.
- The USB device must be connected to a ground system common with the terminal or used with a USB hub that provides galvanic isolation.
- The USB device port is not for runtime operation.

Connect only externally powered USB hubs to the terminal that are USB 2.0 compatible. Before you attach devices to a USB hub, make sure that the power adapter is connected and powered on.

## USB Cables

Use high-speed, USB 2.0 certified cables for error-free transmissions.

**IMPORTANT** The terminals have not been tested with USB 3.0 cables. We recommend only the use of USB 2.0 certified cables.

## Insert an SD Card

Only use a SD™ or SDHC™ card to load troubleshooting profiles and to save troubleshooting logs. For a list of cards recommended by Rockwell Automation, see [Table 6 on page 18](#). The SD cards are hot-swappable; they can be inserted and removed while the terminal is powered on and in operation.

The SD card slot is accessible from the inside or back of the panel when the operator terminal is installed.

Follow these steps to install an SD card in the card slot.

1. Verify that the SD card is locked or unlocked according to your preference.
  - If unlocked, the terminal can write data to or read data from the card.
  - If locked, the terminal can only read data from the card.

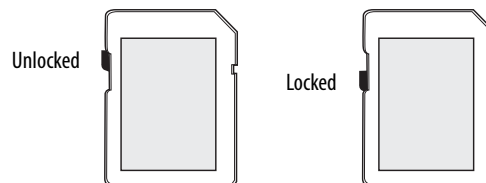

**ATTENTION:** Orient the SD card correctly before inserting into slot. If you force the card into the slot, you can damage the card or the terminal.

2. Insert the SD card firmly into the slot.  
The SD card snaps into the retention feature.

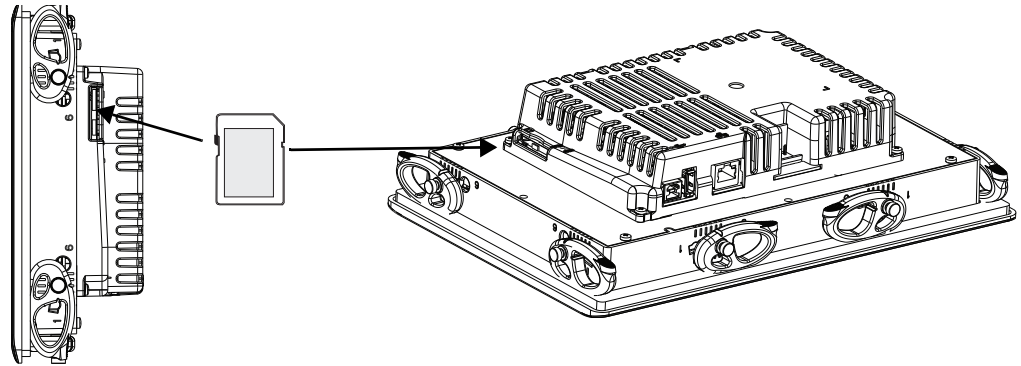

To remove the card, press the card so the retention feature releases the card, and pull out the card.

## Replace the Battery

The product has a lithium battery that provides backup power for the real-time clock and static RAM. The battery can be replaced while the product is mounted in the panel. No special tools are required to replace the battery.



This product contains a sealed lithium battery, which may need to be replaced during the life of the product.

At the end of its life, the battery contained in this product should be collected separately from any unsorted municipal waste.

The collection and recycling of batteries helps protect the environment and contributes to the conservation of natural resources as valuable materials are recovered.



**WARNING:** There is a danger of explosion if the lithium battery or real-time clock module in this product is incorrectly replaced. Do not replace the battery or real-time clock module unless power has been removed.

Replace the battery only with catalog number 2711P-RY2032 or an equivalent CR2032 coin-cell battery.

Do not dispose of the lithium battery or real-time clock module in a fire or incinerator. Dispose of used batteries in accordance with local regulations.

For safety information on the handling of lithium batteries, including handling and disposal of leaking batteries, see Guidelines for Handling Lithium Batteries, publication [AG 5-4](#).

Perchlorate material – special handling may apply. See [www.dtsc.ca.gov/hazardouswaste/perchlorate](http://www.dtsc.ca.gov/hazardouswaste/perchlorate).

This perchlorate warning only applies to primary Lithium Manganese Dioxide (LiMnO<sub>2</sub>) cells or batteries, and products containing these cells or batteries, sold or distributed in California, USA.

To replace the battery, follow these steps.

1. Disconnect power from the terminal.
2. Remove the screws from the logic module.

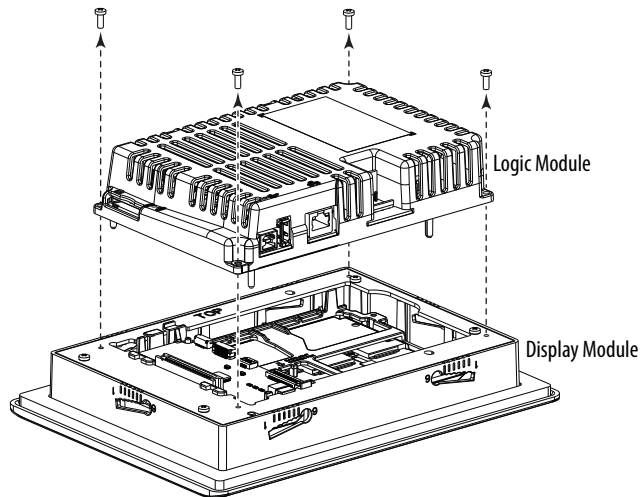

3. Carefully lift the logic module away from the display module and turn over to expose the circuit board.
4. Locate the coin-cell battery on the circuit board.

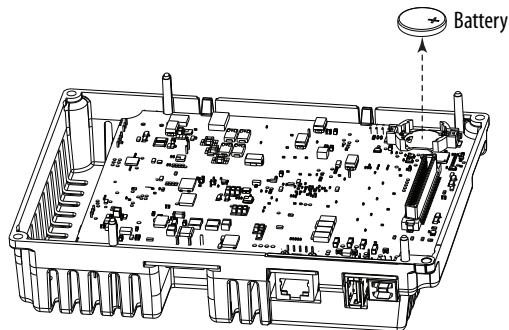

5. Remove the battery by lifting the side of the battery.
6. Insert the new battery so the positive (+) polarity faces up.

7. Reattach the logic module by aligning the connector on the bottom of the logic module with the connector on the display module.

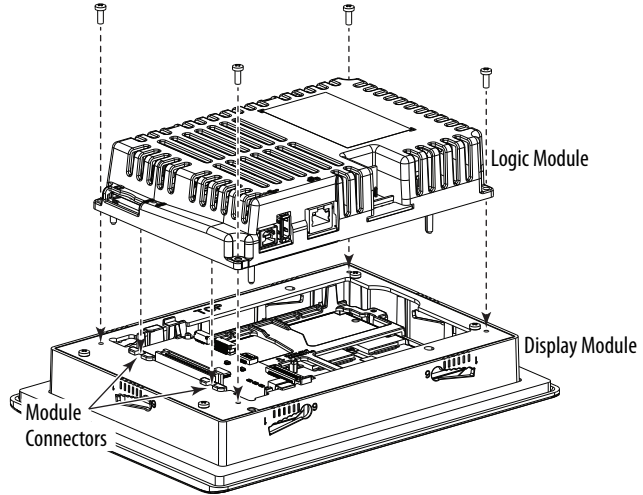

8. Push down on the logic module and make sure that it is fully seated.
9. Torque the screws to 0.68...0.90 N•m (6...8 lb•in).



## Update Firmware

Topic	Page
Before You Begin	81
Firmware Requirements	81
Get the Terminal Firmware	82
Install the ControlFLASH Software	82
Update the Firmware by Using ControlFLASH Software	83
Verify the Firmware Update	85

### Before You Begin

Perform these tasks to prepare for the update:

- Verify that RSLinx® Classic software is configured with an Ethernet driver to communicate with the terminal.
- Back up your application files to a computer.
- Verify that downloads to the terminal are allowed. If downloads are disabled, you cannot update the terminal firmware.

See [Disable Downloads to the Terminal on page 56](#) and make sure that downloads are allowed to the terminal.

- Verify the catalog number of your product and the current firmware revision on the terminal.

See [View the Firmware Revision on page 58](#) to get the catalog number and current firmware revision.

### Firmware Requirements

ControlFLASH™ software is used to update firmware in the PanelView™ 5310 terminal on the network. The update performs these actions:

- Installs updated binary files
- Preserves configuration data, such as Ethernet settings, display brightness, time and date, and touch screen settings

Use [Table 20](#) to determine requirements for the firmware update.

**Table 20 - Firmware Requirements for PanelView 5310 Terminals**

Software	Firmware Revision
Studio 5000® that also includes: <ul style="list-style-type: none"> <li>• RSLinx Classic software</li> <li>• ControlFLASH software</li> </ul>	30.01 or later 4.00.00.16 or later 14.00.10.12 or later
PanelView 5310 Terminal firmware	4.001 or later
Know the catalog number of the PanelView 5310 terminal you want to update	
Know the RSLinx network path to the targeted PanelView 5310 terminal	

## Get the Terminal Firmware

To download terminal firmware and release notes, see [Product Firmware and Release Notes on page 8](#).

## Install the ControlFLASH Software

ControlFLASH software is required to update firmware on the PanelView 5310 terminal. This software is included in the Studio 5000® installation package.

For details on how to install ControlFLASH software, see the ControlFLASH Firmware Upgrade Software User Manual, publication [1756-UM105](#).

## Update the Firmware by Using ControlFLASH Software

To use the ControlFLASH software to update the firmware in a PanelView 5310 terminal, follow these steps.

1. Click Start>Programs>FLASH Programming Tools>ControlFLASH.
2. Make sure that you know the required information in the Welcome dialog box, then click Next.



3. Select the catalog number of the PanelView 5310 terminal you want to update and click Next.

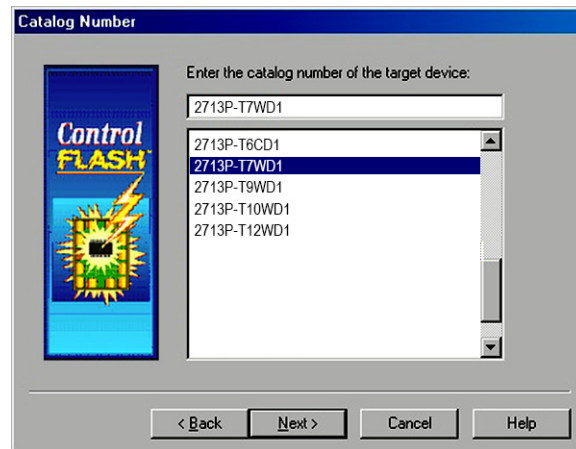

- Browse to and select the device to update on the EtherNet/IP™ network and click OK.

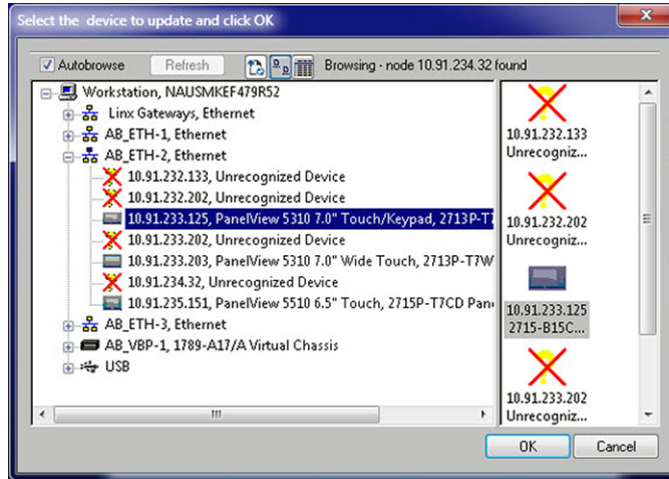

- Select the firmware revision to install and click Next.



- Read the Danger information in the Summary dialog, then click Finish.



- Click Yes to confirm that you want to update the target device.

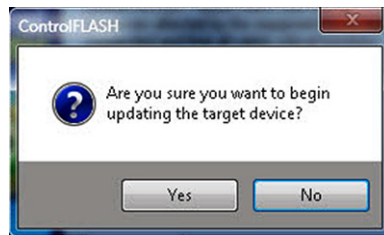

The update starts and can take several minutes to complete.

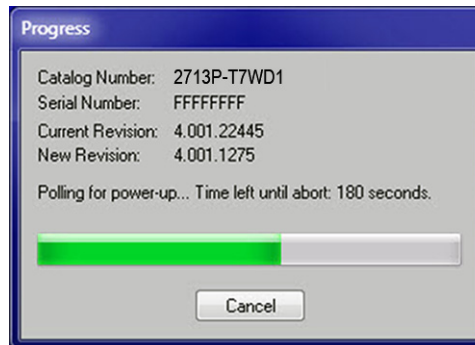



---

**IMPORTANT** Do not cycle power to the terminal during this process or the firmware update does not complete successfully.

---

When the firmware is sent to the terminal, the terminal resets and performs diagnostics.

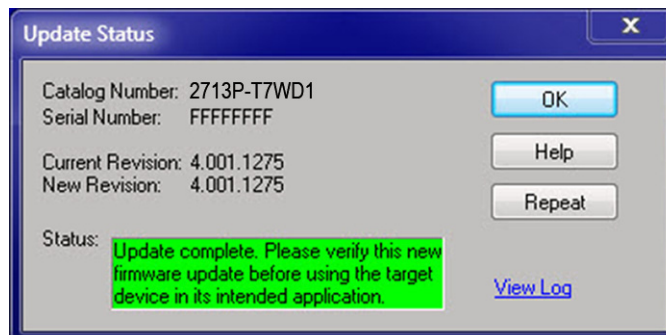
The Update Status dialog opens when the update is complete. If the update was successful, the Status area is green.



- Click OK.

If the update fails, the status area is red and reads Update failure. See the ControlFlash firmware update Kit User Manual, publication [1756-UM105](#) for troubleshooting information.

- Close the ControlFLASH software.

## Verify the Firmware Update

See [View General Information for the Configured Controller on page 64](#) to view the current firmware revision for the terminal.

**Notes:**

## Troubleshooting

<b>Topic</b>	<b>Page</b>
Status Indicators	88
View Diagnostic Information for the Configured Controller	89
Troubleshooting Profiles	89
Terminal Does Not Start Up	93
Terminal Restarts Intermittently	93
Touch Screen Issues	93
Display Issues	94
Ethernet Issues	95
Cannot Download Application to Terminal	95
Performance Is Slow	95
Resistance to Chemicals	96
Clean the Display	96
Ship the Terminal	97
Restore Factory Defaults	97
Dispose of the Terminal	98

## Status Indicators

The back of the terminal has two indicators to identify system status:

- Status (STS) indicates that the terminal is on and in use. Its light color is green.
- Error (ERR) indicates hardware and firmware faults. Its light color is red.

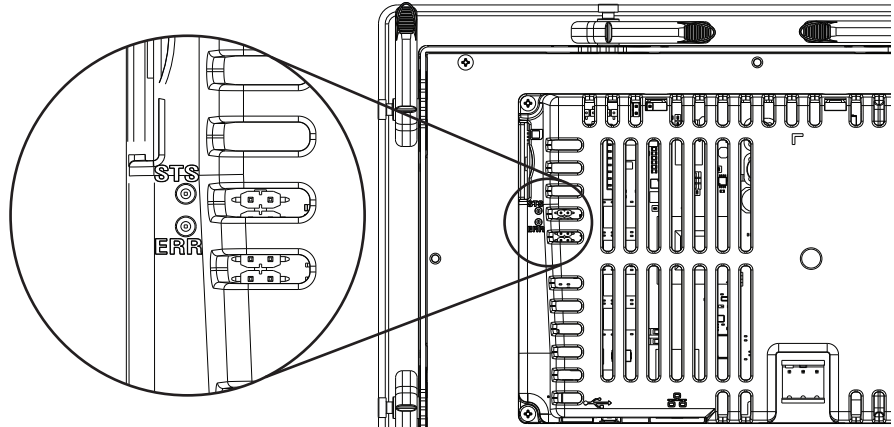

At startup, the STS and ERR indicators blink on and off, then the STS indicator blinks to signal progress during startup. If the indicators remain off, check the power cable.

After a successful startup, the STS indicator remains on.

[Table 21](#) shows indicator states if the terminal stops during startup.

**Table 21 - Fault Indicator States during Terminal during Startup**

ERR (red) Indicator	STS (green) Indicator	Description	Recommended Action
Blinking	On	Recoverable firmware error.	Reload the firmware.
	Off	Recoverable configuration failure	Restore factory defaults. Refer to <a href="#">Restore Factory Defaults on page 97</a> .
On	On	Fatal hardware error	Replace the terminal.
	Blinking	Fatal display hardware error	Replace the terminal.



## View Diagnostic Information for the Configured Controller

You can view diagnostic information for the controller that is configured to operate with the terminal.

To view diagnostic information for the controller, follow these steps.



1. Press the navigation button on an application screen.
2. On the Settings screen, tap Controllers.
3. Tap the Diagnostics tab.

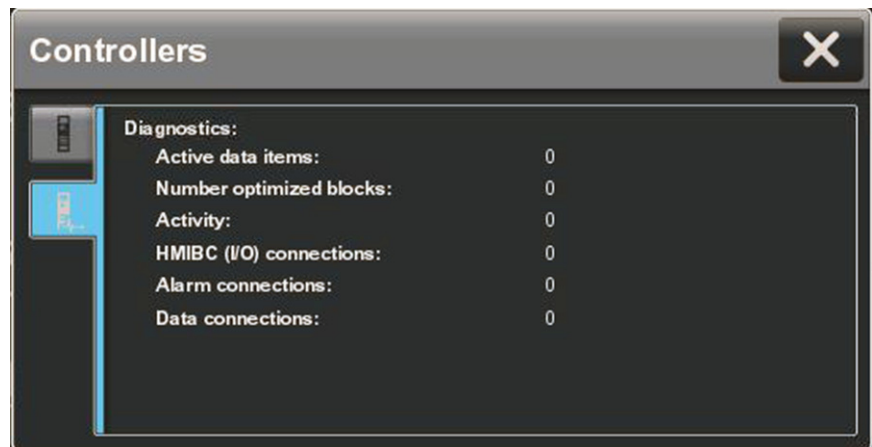

The diagnostic information for the controller includes these data.

Data Type	Description
Active data items	The number of data items on scan for the controller.
Number optimized blocks	The numeric of optimized data blocks on scan for the controller.
Activity	A count that increments each time a communication packet is received from the controller.
HMIBC (I/O) connections	The number of Class 1 Common Industrial Protocol (CIP) connections to the controller.
Alarm connections	The number of alarm CIP connections to the controller.
Data connections	The number of Class 3 CIP connections to the controller.

4. To close the window, tap

## Troubleshooting Profiles

Rockwell Automation compiles data about your system in a secure, encrypted format. This profile is stored on the terminal and can be used to improve usability and assist with troubleshooting.

If you contact technical support, a representative can ask you to export the troubleshooting log to a USB drive, or SD™ or SDHC™ card. You can also import a troubleshooting profile from a USB drive or SD card to capture additional data.

**TIP** If removable media is needed, then the USB device or SD card must be FAT32 formatted, have write permissions, and sufficient space.

## Import a Troubleshooting Profile

The Troubleshooting window indicates whether a default or imported troubleshooting profile is being used in the terminal. If an imported file is in use, a green check mark and the name of the imported file appears next to the Import Profile button.

To import a troubleshooting profile from a USB drive or SD card, follow these steps.

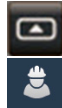

1. Press the navigation button on an application screen.
2. On the Settings screen, tap Troubleshooting.
3. Insert a USB drive or SD card that contains the troubleshooting profile into the appropriate slot on the terminal.
4. Tap Import Profile.



5. Tap to select the target USB device or SD card that contains the profile.
6. Tap Save.

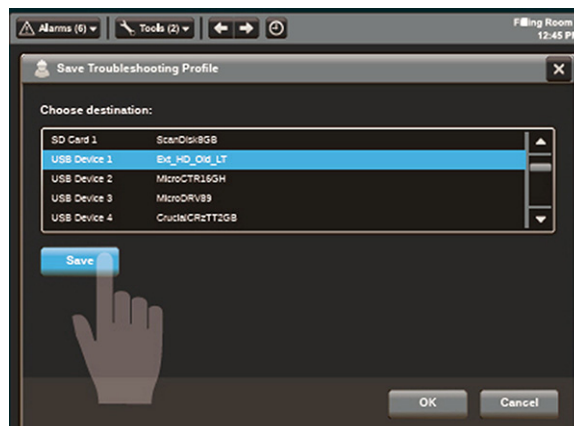

7. To close the window, tap OK.

The name of the imported file is displayed. A green check next to the file name means that the import is complete.

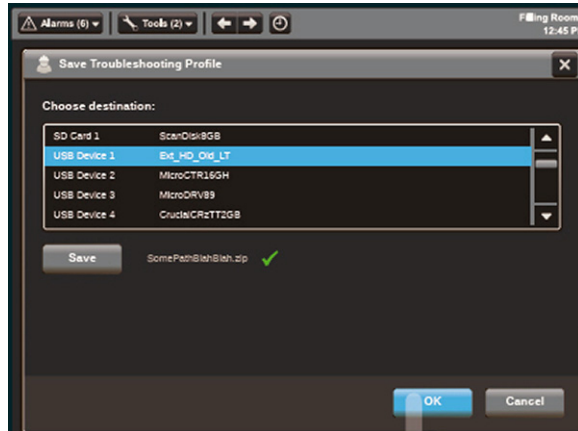

**ATTENTION:** Do not remove the USB drive or SD card before the import operation is complete. Otherwise, the USB drive or SD card can become corrupt.

8. Tap OK.

The file is stored on the terminal and captures data in an encrypted format for use by Rockwell Automation technical support.

## Export a Troubleshooting Log

To export the troubleshooting log to a USB device or SD card, follow these steps.

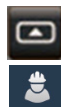

1. Press the navigation button on an application screen.
2. On the Settings screen, tap Troubleshooting.
3. Insert a USB drive or SD card into the appropriate slot on the terminal.
4. Tap Export.



5. Tap Save Troubleshooting Profile.

6. Insert a USB drive or SD card into a slot on the terminal.



7. Tap Export.

The troubleshooting log is exported and the date a time of the last export is displayed next to the Export button.



**ATTENTION:** Do not remove the USB drive or SD card before the import operation is complete. Otherwise, the USB drive or SD card can become corrupt.

---

8. To close the window, tap .

Your technical support contact at Rockwell Automation can provide you with information on where to send the profile.

## Terminal Does Not Start Up

If the terminal does not start up normally, check the table for possible causes.

**Table 22 - Terminal Does Not Start Up Properly**

Check For	What to Do	See
Insufficient power	Make sure that device is receiving adequate power: <ul style="list-style-type: none"> <li>• Check the DC power requirements.</li> </ul>	<a href="#">page 33</a>
Improper power wiring	Verify that the power wiring is correct: <ul style="list-style-type: none"> <li>• Check the wiring specifications.</li> <li>• Check the DC power wiring.</li> </ul>	<a href="#">page 33</a> <a href="#">page 33</a>
Status indicators	Check the status indicators during startup.	<a href="#">page 88</a>
Stalled progress indicator	If a terminal stalls at the progress indicator and does not load an application or configuration screens, restore the factory defaults.	<a href="#">page 97</a>
Does an object touch the display	Verify that nothing is pressing against the display or that you are not touching the display during startup.	

## Terminal Restarts Intermittently

If the terminal restarts intermittently, check the table for possible causes.

**Table 23 - Terminal Restarts Intermittently**

Check For	What to Do	See
Improper power wiring	Verify that the power wiring is correct: <ul style="list-style-type: none"> <li>• Check the wiring specifications.</li> <li>• Check the DC power wiring.</li> </ul>	<a href="#">page 32</a> <a href="#">page 33</a>
Over-temperature conditions	Make sure that the processor is not exceeding temperatures for normal terminal operations: <ul style="list-style-type: none"> <li>• Check the processor temperature.</li> <li>• Check for adequate clearances around the terminal in the panel.</li> <li>• Check for the proper operating temperature.</li> </ul>	<a href="#">page 59</a> <a href="#">page 23</a> <a href="#">page 59</a>

## Touch Screen Issues

If the touch screen does not operate or respond correctly to touches with a finger or stylus, check the table for possible causes.

**Table 24 - Touch Screen Not Responding**

Check For	What to Do	See
Improper calibration	Check for activation points offset from touch points. Calibrate the touch screen.	<a href="#">page 54</a>
Non-functional touch screen	Check the touch screen for damage, such as cuts or excessive wear. If there is damage, replace the terminal.	
Multiple input elements touched	Application screens contain graphic input elements that are configured in the View Designer application. When touched, these elements perform operations in a predictable manner. For example, an input element is configured to navigate to a specific screen in the application or start a motor when touched.  Multiple operations cannot be conducted simultaneously. Doing so results in an unintended operation. <ul style="list-style-type: none"> <li>• Do not touch multiple input elements at one time.</li> <li>• Do not rest a hand or multiple fingers on the display.</li> </ul>	

## Display Issues

The display is unreadable or dims unexpectedly.



**ATTENTION:** If the display darkens, or if the backlight is not functioning properly, the screen can be difficult to read and use of this touch screen could result in a potentially hazardous outcome. **Do not use the touch screen under these circumstances.** The design of the system must take into account the possibility of the touch screen losing functionality and unable to be used to maintain or change control of the system. The touch screen shall not be the single point of control of critical functions and is not intended to replace an E-stop.

Design of the system should follow all applicable code and good engineering practice. Factors to consider include:

- The possibility of an unreadable display
- The possibility of an inoperable touch screen
- Unexpected communication errors or delays
- Operator error in the control of the system
- Proper use of E-stops and other safety practices

The user shall provide means to achieve a safe state during anomalies and make sure the system has adequate redundancy for critical functions.

**Failure to follow these instructions can result in death, serious injury, or equipment damage.**

**Table 25 - Dim Display**

Check for	See
Low display brightness setting	<a href="#">Adjust the Brightness of the Display on page 52</a>
Low brightness level of screen saver	<a href="#">Configure the Display Screen Saver on page 53</a>

**TIP** Extend the life of the backlight by reducing the display brightness, by using the screen saver with reduced brightness, or operating at lower temperatures.

## Ethernet Issues

[Table 26](#) provides tips on how to isolate Ethernet anomalies.

**Table 26 - Ethernet Connection Issues**

Check for	Description
Status of invalid Ethernet connection	<ul style="list-style-type: none"> <li>Green indicator is on when a link is established.</li> <li>Yellow indicator blinks when activity is detected.</li> <li>Verify network connections.</li> </ul>
Poor cable connections	Check the Ethernet cabling for the following: <ul style="list-style-type: none"> <li>Make sure that the cable is fully connected.</li> <li>Check for cable crimping.</li> <li>Check the Ethernet switch connections.</li> <li>Check the Uplink ports.</li> </ul>
Invalid IP address of terminal	If DHCP is enabled, the terminal automatically acquires a valid IP address from the network after startup. The TCP/IP protocol automatically assigns 169.254.xxx.xxx when it fails to acquire an IP address from the network. In general, an IP address that begins with 169 does not support a network connection. See <a href="#">Configure the IP Address of the Terminal on page 46</a> .
Conflict Between IP addresses	If DHCP is not enabled and a static IP address is specified, make sure that the IP address does not conflict with the address of another device on the network. See <a href="#">Configure the IP Address of the Terminal on page 46</a> .

## Cannot Download Application to Terminal

You are unable to download an application to the terminal.

**Table 27 - Unable to Download Project to Terminal**

Check for	Description
Application downloads are disabled in Settings screens	Verify that downloads are enabled. See <a href="#">Disable Downloads to the Terminal on page 56</a> .
Download of project to correct HMI device	Check the following in the View Designer application: <ul style="list-style-type: none"> <li>The project that is downloaded to the correct HMI device</li> <li>IP address of HMI device is correct</li> </ul>
Ethernet connection	Make sure that an Ethernet cable is connected between the computer and terminal. Verify that the Ethernet port is configured properly. See <a href="#">Configure the Ethernet Port on page 49</a> .

## Performance Is Slow

If the response time of the application is slow, for example screen changes or text display changes, check for the following conditions:

- Application screens that contain too many elements
- A controller that is programmed for feedback can cause delays
- Slow network performance or noise can result in retries

## Resistance to Chemicals

The outer surfaces of the terminal including the bezel, touch screen overlay, and panel gasket are tested for chemical resistance. Some of the chemicals can cause discoloration, but they do not interfere with the operation of the terminal.

**TIP** For more information on chemical resistance of the product, go to <https://rockwellautomation.custhelp.com/> and search the Knowledgebase for keywords 'Chemical Resistance PanelView Plus'.

---

**IMPORTANT** Do not operate the terminal in direct sunlight. Direct exposure to ultraviolet light can discolor the touch screen.

---

## Clean the Display



**ATTENTION:** Do not use abrasive cleaners or solvents, they can damage the display. Do not scrub or use brushes.

Do not apply cleaning solution directly on the terminal screen, the solution can drip or seep onto the gasket. Apply cleaning solution to a clean sponge or soft cloth, and gently wipe the screen to remove the dirt and grime.

---

To clean the display, follow these steps.

1. Disconnect power from the terminal at the power source.



**ATTENTION:** Do not clean a display while power is applied. If you clean a display while power is applied, you can unintentionally activate screen items.

---

2. To clean the display and help prevent scratches, use a clean sponge or soft cloth with mild soap or detergent.
3. Dry the display with a chamois or moist cellulose sponge to avoid water spots.

## Remove Paint and Grease

To remove paint or grease from the bezel that is properly mounted in a NEMA, UL Type, or IP rated enclosure, follow these steps.

1. Rub lightly with isopropyl alcohol (70% concentration).
2. To remove residue, use a mild soap or detergent solution.
3. Rinse with clean water.



## Equipment Wash Downs



**ATTENTION:** Do not use a high-pressure washer for cleaning the front bezel of the terminal. A high-pressure washer can damage the terminal.

Do not use a high-pressure washer for cleaning vented enclosures. Water can enter the enclosure and damage the terminal and other equipment.

## Ship the Terminal

If you ship the enclosure with the terminal installed, make sure that the terminal is properly secured and protected against damage from impact, sharp objects, or abrasive materials.



**ATTENTION:** Rockwell Automation is not responsible for damage to a product that is shipped or transported while installed in a panel or enclosure.

## Restore Factory Defaults

Restore a terminal to its default settings to refresh the terminal or to recover from an invalid application configuration. The restore process does not affect the firmware revision on the terminal.



**ATTENTION:** The process that restores factory defaults also removes some data.

- Upload the application with the View Designer application.
- Record the terminal settings so you can update them after the restore.

**TIP**

If a terminal stalls at the progress indicator after a restart and does not load the application or configuration screens, you can restore the factory defaults.

The restore procedure performs the following actions:

- Removes the user application
- Restores the terminal settings to their default state

**Table 28 - Factory-default Terminal Settings**

Terminal Settings	Factory Default Setting
Backlight intensity: 1...100%	100%
Screen saver <ul style="list-style-type: none"> <li>• Enabled or disabled</li> <li>• Timeout</li> <li>• Dimmer: 1...100%</li> </ul>	<ul style="list-style-type: none"> <li>• Disabled</li> <li>• 10 minutes</li> <li>• 10%</li> </ul>
Touch screen calibration	Factory calibrated
Ethernet <ul style="list-style-type: none"> <li>• DHCP-enabled or static IP address</li> <li>• Speed: 10 Mbps, 100 Mbps, Auto sense</li> <li>• Duplex: Half, full, auto sense</li> </ul>	<ul style="list-style-type: none"> <li>• DHCP-enabled</li> <li>• Auto sense link speed</li> <li>• Auto sense duplex mode</li> </ul>

To restore the terminal to its default state, follow these steps.

1. Cycle power to the terminal.  
The Allen-Bradley logo displays during startup.
2. Wait a few seconds, and then touch the Allen-Bradley logo when the copyright line becomes brighter.

Copyright ©2017 Rockwell Automation

**TIP** Wait a few seconds before you touch the logo. If you touch the logo too soon during startup, this error text is displayed under the copyright line.

**ERROR! FEHLER! ERREUR! ERRORE!**

If this error text is displayed, cycle power to the terminal and wait a few seconds longer before you touch the logo.

The normal startup is suspended so the restore procedure can initiate. You are asked if you want to restore the terminal to its defaults.

3. To continue, tap Yes, or tap Cancel to resume a normal startup.  
You are asked to confirm the removal of all user files such as applications.
4. To continue, tap Yes, or tap Cancel to resume a normal startup.  
Progress messages appear on the screen during the restore operation. When the restore is complete, the terminal performs a normal startup.
5. From the Settings menu, update the terminal network settings.
6. Download an application to the terminal by using the View Designer application.
7. From the Settings menu, update any remaining terminal settings as appropriate.

Refer to [Disable Downloads to the Terminal on page 56](#) for details on how to modify device configuration settings.

## Dispose of the Terminal



At the end of its life, collect the terminal separately from any unsorted municipal waste.

These terminals contain heavy metals that can contaminate the earth. Therefore, check with local health and sanitation agencies for ways to dispose this equipment safely.

**A**

- accessories** 16
- ACD file** 15
- alarm**
  - condition 70
  - details 70
  - filter 72
  - function keys 66
  - manager 69
  - summary 68
- application**
  - overview 15
- application download security** 56

**B**

- back-up power** 78
- battery**
  - back-up power 78
  - lithium 78
  - replacement 79
  - state 59
- branch circuit** 21

**C**

- cable**
  - lengths between Ethernet ports 35
- calibration**
  - touch screen 54
- catalog numbers**
  - accessories 16
  - battery replacement 17
  - explanation 16
  - mounting hardware 16
  - PanelView 5300 terminals 16
  - power supplies 16
  - power terminal blocks 16
  - SD cards 17
  - USB programming cable 17
- circuit breaker rating** 21
- ControlFLASH software** 81, 82
- cutout dimensions** 24

**D**

- date and time**
  - setting 63
- DC power bus** 33
- device name** 57
- DHCP** 46
- diagnostics**
  - data 59
  - network 50
- dimensions**
  - product 25

- disable downloads to the terminal** 56

**display**

- brightness 52
- unreadable or dimming 94

**DNS address**

- primary 48
- secondary 48
- tertiary 48

**E****earth ground**

- connection 34
- wire 34

- electrostatic discharge** 75

- environment and enclosure specifications** 20, 21

- equipment wash downs** 97

**Ethernet**

- connector pinout 35
- status indicators 35

**Ethernet port**

- duplex mode 49
- link speed 49

- explosion hazard** 78

**F**

- factory defaults** 97

- firmware revision** 58

- firmware update** 81

- firmware upgrade**

- requirements 82

- fuse rating** 21

**H****hardware specifications**

- display/touch screen 12
- Ethernet port 12
- SD card slot 12
- status indicators 12
- USB device port 12
- USB host port 12

- hazardous location** 21

**I****indicators**

- ERR 88
- error 88
- fault 88
- status 88
- STS 88

**installation**

- environment and enclosure 22
- hazardous location 21
- product dimensions 25

**IP address**

- DHCP 46
- static 47

**IP settings**

- configuration 47

**K****keyboard**

- virtual 41

**L****ladder logic 7****lithium batteries**

- safe handling 78

**log off of the terminal 44****log on to the terminal 43****Logix Designer 14****M****mount the terminal**

- ambient temperature 23
- cutout dimensions 24
- minimum clearances 23
- mounting levers 26
- panel guidelines 24
- preparation 26

**N****network**

- types supported 34

**network diagnostics 50****network topology**

- linear 36
- star 36

**numeric keypad**

- virtual 41

**P****power**

- 24V DC nominal 33
- connection 33
- DC bus 33
- ratings 33
- specification 12
- supplies 33
- terminal block
  - install 32
  - remove 32
- wire specifications 32

**power supply**

- PELV 33
- SELV 33

**product compatibility and download center 8****product dimensions 25****publications**

- download 9

**R****reboot the terminal 62****release notes 8****restore factory defaults 97****RJ45 connector 35****runtime 15, 39****S****safety notices**

- battery replacement 78
- earth ground connection 34
- electrical arc 32, 35
- mounting the terminal 29
- unintended operation 13
- water or chemical damage 29

**screen saver 53****SD card**

- installing 77
- slot 77

**startup sequence 37****status indicators**

- Ethernet 35

**Studio 5000 Logix Designer 7**

- see also Logix Designer

**Studio 5000 View Designer 7**

- see also View Designer

**T**

- tag browser** 15
- terminal block**
  - power 32
- time and date**
  - setting 63
- touch screen**
  - calibration 54
  - input 13
- troubleshooting** 87
  - log, exporting 91
  - profile, importing 90

**U**

- USB**
  - cables 77
  - host connections 76
  - hubs 76
- USB to serial port adapters** 17

**V**

- View Designer** 14
- virtual**
  - keyboard 41
  - numeric keypad 41
- VPD file** 15

**W**

- wash downs** 97
- wiring and safety guidelines** 21

**Notes:**



# Rockwell Automation Support

Use the following resources to access support information.

<b>Technical Support Center</b>	Knowledgebase Articles, How-to Videos, FAQs, Chat, User Forums, and Product Notification Updates.	<a href="https://rockwellautomation.custhelp.com/">https://rockwellautomation.custhelp.com/</a>
<b>Local Technical Support Phone Numbers</b>	Locate the phone number for your country.	<a href="https://rockwellautomation.custhelp.com/app/phone">https://rockwellautomation.custhelp.com/app/phone</a>
<b>Direct Dial Codes</b>	Find the Direct Dial Code for your product. Use the code to route your call directly to a technical support engineer.	<a href="https://rockwellautomation.custhelp.com/app/phone">https://rockwellautomation.custhelp.com/app/phone</a>
<b>Literature Library</b>	Installation Instructions, Manuals, Brochures, and Technical Data.	<a href="https://www.rockwellautomation.com/global/literature-library/overview.page">https://www.rockwellautomation.com/global/literature-library/overview.page</a>
<b>Product Compatibility and Download Center (PCDC)</b>	Get help determining how products interact, check features and capabilities, and find associated firmware.	<a href="https://compatibility.rockwellautomation.com/Pages/home.aspx">https://compatibility.rockwellautomation.com/Pages/home.aspx</a>

## Documentation Feedback

Your comments will help us serve your documentation needs better. If you have any suggestions on how to improve this document, complete the How Are We Doing? form at [https://literature.rockwellautomation.com/idc/groups/literature/documents/du/ra-du002\\_-en-e.pdf](https://literature.rockwellautomation.com/idc/groups/literature/documents/du/ra-du002_-en-e.pdf).

Rockwell Automation maintains current product environmental information on its website at <http://www.rockwellautomation.com/rockwellautomation/about-us/sustainability-ethics/product-environmental-compliance.page>.

Allen-Bradley, CompactLogix, ControlFLASH, ControlLogix, FLEX I/O, Kinetix, PanelView, POINT I/O, Rockwell Automation, Rockwell Software, RSLinx, Stratix, Studio 5000 Logix Designer, and Studio 5000 View Designer are trademarks of Rockwell Automation, Inc.

EtherNet/IP is a trademark of ODVA.

SD and SDHC are trademarks of SD-3C LLC.

Rockwell Otomasyon Ticaret A.Ş., Kar Plaza İş Merkezi E Blok Kat:6 34752 İçerenköy, İstanbul, Tel: +90 (216) 5698400

**[www.rockwellautomation.com](http://www.rockwellautomation.com)**

### Power, Control and Information Solutions Headquarters

Americas: Rockwell Automation, 1201 South Second Street, Milwaukee, WI 53204-2496 USA, Tel: (1) 414.382.2000, Fax: (1) 414.382.4444

Europe/Middle East/Africa: Rockwell Automation NV, Pegasus Park, De Kleetlaan 12a, 1831 Diegem, Belgium, Tel: (32) 2 663 0600, Fax: (32) 2 663 0640

Asia Pacific: Rockwell Automation, Level 14, Core F, Cyberport 3, 100 Cyberport Road, Hong Kong, Tel: (852) 2887 4788, Fax: (852) 2508 1846

Publication 2713P-UM001D-EN-P - March 2019

Supersedes Publication 2713P-UM001C-EN-P - October 2018

Copyright © 2019 Rockwell Automation, Inc. All rights reserved. Printed in the U.S.A.