

# PowerFlex Digital DC Drive

Catalog Numbers 20P, 23P



## Important User Information

Read this document and the documents listed in the additional resources section about installation, configuration, and operation of this equipment before you install, configure, operate, or maintain this product. Users are required to familiarize themselves with installation and wiring instructions in addition to requirements of all applicable codes, laws, and standards.

Activities including installation, adjustments, putting into service, use, assembly, disassembly, and maintenance are required to be carried out by suitably trained personnel in accordance with applicable code of practice.

If this equipment is used in a manner not specified by the manufacturer, the protection provided by the equipment may be impaired.

In no event will Rockwell Automation, Inc. be responsible or liable for indirect or consequential damages resulting from the use or application of this equipment.

The examples and diagrams in this manual are included solely for illustrative purposes. Because of the many variables and requirements associated with any particular installation, Rockwell Automation, Inc. cannot assume responsibility or liability for actual use based on the examples and diagrams.

No patent liability is assumed by Rockwell Automation, Inc. with respect to use of information, circuits, equipment, or software described in this manual.

Reproduction of the contents of this manual, in whole or in part, without written permission of Rockwell Automation, Inc., is prohibited.

Throughout this manual, when necessary, we use notes to make you aware of safety considerations.



**WARNING:** Identifies information about practices or circumstances that can cause an explosion in a hazardous environment, which may lead to personal injury or death, property damage, or economic loss.



**ATTENTION:** Identifies information about practices or circumstances that can lead to personal injury or death, property damage, or economic loss. Attentions help you identify a hazard, avoid a hazard, and recognize the consequence.

---

### **IMPORTANT**

Identifies information that is critical for successful application and understanding of the product.

---

Labels may also be on or inside the equipment to provide specific precautions.



**SHOCK HAZARD:** Labels may be on or inside the equipment, for example, a drive or motor, to alert people that dangerous voltage may be present.



**BURN HAZARD:** Labels may be on or inside the equipment, for example, a drive or motor, to alert people that surfaces may reach dangerous temperatures.



**ARC FLASH HAZARD:** Labels may be on or inside the equipment, for example, a motor control center, to alert people to potential Arc Flash. Arc Flash will cause severe injury or death. Wear proper Personal Protective Equipment (PPE). Follow ALL Regulatory requirements for safe work practices and for Personal Protective Equipment (PPE).

---

**Preface** .....9  
 Summary of Changes ..... 10  
 Conventions ..... 11  
 Drive Storage Conditions ..... 11  
 Drive Nameplate Data ..... 12  
     Drive Series Letter ..... 12  
     Drive Frame Sizes ..... 12  
     Drive Firmware Revision ..... 12  
 Drive Specifications ..... 12  
 Standard Drive Catalog Number Explanation ..... 13  
 Standard Drive Catalog Number Explanation, Cont..... 14  
 Standalone-Alone Regulator Catalog Numbers ..... 14  
 Additional Resources ..... 15

**Chapter 1**

**Installation and Wiring**

Product Advisories ..... 18  
 Mount the Drive ..... 19  
     Operating Conditions and Temperatures ..... 19  
     Minimum Mounting Clearances ..... 19  
     Maximum Surrounding Air Temperature Specifications ..... 19  
 Approximate Drive Dimensions and Weights ..... 20  
 Lifting PowerFlex DC Drives ..... 26  
     Mount Frame C and D Drives ..... 26  
 Remove the Drive Covers ..... 28  
     Frame A Drives ..... 28  
     Frame B and C Drives ..... 29  
     Frame D ..... 30  
 Isolation Transformers / Line Reactors ..... 30  
 Contactors ..... 31  
     AC Input Contactors ..... 32  
     DC Output Contactors ..... 32  
     Dynamic Brake Resistors ..... 32  
 General Grounding Requirements ..... 33  
     Safety Ground (PE) ..... 34  
     Power Feeder ..... 34  
     Encoder/Resolver Ground Connections ..... 34  
     Tachometer Ground Connections ..... 34  
 Grounding for Installations in an Ungrounded or  
 High-Impedance, Neutral Ground, or System ..... 35  
     Power Distribution ..... 35  
 CE Conformity ..... 40  
     Low Voltage Directive ..... 40  
     EMC Directive ..... 40  
     General Considerations ..... 40

Installation Requirements Related to the Low Voltage Directive .....	41
Installation Requirements Related to EN 61800-3 and the EMC Directive .....	41
Pollution Degree Ratings According to EN 61800-5-1 .....	42
Power Circuit Protection .....	43
Control Power Circuit Protection .....	43
Cable and Wiring Recommendations .....	44
Power Wiring .....	45
AC Input Voltages .....	45
DC Output Voltages .....	46
Typical Power Wiring Diagrams .....	46
Armature Converter Connections .....	51
Armature Voltage Feedback Connections .....	54
Field Converter Connections .....	57
Field Current Configuration .....	61
Set DIP Switch S14 to the Correct Value .....	62
Relay Outputs .....	64
Thermistors and Thermal Switches .....	64
Control Circuit Input Power .....	67
Frame C Heatsink Cooling Fan Specifications .....	71
Frame D, Series B and C Heatsink Cooling Fan Specifications .....	73
Frame C and D Armature Fuse Signal Terminals .....	75
DIP Switch and Jumper Settings .....	77
I/O Wiring .....	82
I/O Signal and Control Wiring .....	83
Digital Encoder Terminal Block .....	88
DC Analog Tachometer Terminal Block .....	90
Resolver Feedback Module .....	90
I/O and Control Wire Routing .....	91

## Chapter 2

### Drive Start Up

Drive Start Up Checklist .....	93
Before Applying Power to the Drive .....	94
Verify all Drive Configuration Settings .....	94
Verify the Power Wiring .....	94
Verify the Control and I/O Wiring .....	94
Apply Power to the Drive .....	95
Apply Voltage to the Control Circuits .....	95
Verify the Control Voltages .....	96
Load the Default Settings .....	97
Configure the Most Commonly Used Parameters .....	97
Tune the Current Regulator .....	102
Verify Motor Rotation and Run Feedback Polarity Checks .....	104
Configure the Speed Feedback Parameters .....	107
Tune the Speed Regulator .....	109



Verify Speed Reference Settings and Drive Operation. . . . .	111
--	-----

### Chapter 3

## Programming and Parameters

About Parameters . . . . .	116
Parameters Table Example . . . . .	117
How Parameters are Organized. . . . .	118
File–Group–Parameter Order . . . . .	118
Numbered List View. . . . .	118
Cross Reference Tables . . . . .	118
Basic Parameter View . . . . .	119
Advanced Parameter View . . . . .	121
Monitor File . . . . .	126
Motor Control File. . . . .	131
Speed Command File. . . . .	148
Dynamic Control File . . . . .	155
Applications File . . . . .	161
Utility File. . . . .	177
Communications File. . . . .	191
Input / Output File . . . . .	195
Parameter Cross Reference – by Name . . . . .	207
Parameter Cross Reference – by Number. . . . .	213

### Chapter 4

## Troubleshooting

Faults and Alarms . . . . .	219
Drive Status . . . . .	220
HIM Indicators . . . . .	221
Manually Clearing Faults . . . . .	221
Fault Descriptions. . . . .	222
How to Clear an Alarm. . . . .	228
Alarm Descriptions. . . . .	228
Common Drive Symptoms and Corrective Actions . . . . .	231
Drive does not start . . . . .	231
Drive starts but motor does not turn and no armature current . . . . .	232
The motor does not reach commanded speed . . . . .	232
The motor is turning in the wrong direction . . . . .	232
The motor reaches maximum speed immediately . . . . .	233
The motor speed cannot be controlled and the drive does not stop . . . . .	233
Testpoint Codes and Functions . . . . .	233

	<b>Appendix A</b>	
<b>Supplemental Drive Information</b>	Certifications and Specifications . . . . .	236
	IP20 NEMA / UL Type Open Watts Loss . . . . .	236
	Communication Configurations . . . . .	240
	Typical Programmable-Controller Configurations . . . . .	240
	Logic Command/Status Words . . . . .	241
	Drive Power Circuit Protection . . . . .	243
	Frame A and B Fuse Information . . . . .	243
	Frame C and D Fuse Information . . . . .	251
	Control Power Circuit Protection Fuses . . . . .	259
	Switching Power Supply Circuit Board Fuses . . . . .	259
	Frame B Pulse Transformer Circuit Board Fuses . . . . .	261
	Frame C Transient Noise Filter Circuit Board Fuses . . . . .	262
	Frame D Overvoltage Clipping Circuit Board Fuses . . . . .	263
	AC Input Line Reactors and AC Input Contactors . . . . .	264
	Isolation Transformers . . . . .	267
	Dynamic Brake Resistor Kits and DC Output Contactors . . . . .	269
	DC Contactor Crimp Lug Kit Specifications . . . . .	271
	Alternate Dynamic Brake Resistor Kits and DC Output Contactors . . . . .	272
Alternate EMC Filters . . . . .	273	
Terminal Adapter Kits for Frame D Drives . . . . .	279	
	<b>Appendix B</b>	
<b>HIM Overview</b>	External and Internal Connections . . . . .	281
	LCD Display Elements . . . . .	282
	ALT Functions . . . . .	282
	Using the S.M.A.R.T. List Screen . . . . .	283
	Menu Structure . . . . .	284
	Viewing and Editing Parameters . . . . .	286
	LCD HIM . . . . .	286
	Removing/Installing the HIM . . . . .	287
	<b>Appendix C</b>	
<b>Application Notes</b>	Alpha Test Mode . . . . .	289
	Alpha Test Setup and Operation . . . . .	290
	Analog Input Configuration . . . . .	292
	Example 1: . . . . .	292
	Example 2: . . . . .	292
	Analog-input Signal Comparison . . . . .	293
	Current / Speed Curve . . . . .	294
	Drive Reference and Feedback Scaling . . . . .	296
	Armature Voltage Feedback . . . . .	296
	DC Analog Tachometer Feedback . . . . .	296
Encoder Feedback . . . . .	297	
Drive Reference and Feedback Scaling Examples . . . . .	297	

Valid Speed Feedback Values .....	300
Droop Compensation .....	302
Field-weakening Mode Configuration (v1.006) .....	302
Using a DC Contactor Only (Firmware v1.006 Only) .....	303
Using a DC Contactor and a Dynamic Brake (Firmware v1.006 Only) .....	303
Using an Inverting Fault Device Only (Firmware v1.006 Only) .....	304
Using a DC Contactor and an Inverting Fault Device (Firmware v1.006 Only) .....	304
Using a DC Contactor, a Dynamic Brake and an Inverting Fault Device (Firmware v1.006 Only) .....	305
Lifting/Torque Proving .....	306
Tuning The Motor For Torque Prove Applications .....	308
Crane Setup with Encoder/Resolver Feedback .....	308
Crane Setup - Encoderless .....	313
Manually Tuning the Speed Regulator for Firmware Revision 6.001 and Later .....	317
Multiple Motor Applications .....	319
Considerations for Multiple Motors Connected in Parallel ..	319
Considerations for Multiple Motors Connected in Series ...	319
Parameter 21 [Min Firing Angle] Configuration .....	320
PID Function .....	321
Configure a Line Speed Signal .....	321
Configure the Feedback Signal in the Follower Drive/Drives .....	323
Configure the Tension Set Point Signal in the Follower Drive/Drives .....	324
Reference Control .....	325
“Auto” Speed Sources .....	325
“Manual” Speed Sources .....	325
Speed Source Changes .....	326
Torque Reference Source .....	326
Auto/Manual Examples .....	326
Resolver Cable Balance Tuning Test .....	328
Performing the Cable Balance Tuning Test .....	328
Resolver Type Selection .....	329
Scale Blocks .....	330
Link Parameters Via the Scale Block Parameters .....	331
SCR Diagnostic Tests .....	331
Open SCR Test .....	332
Shorted SCR Test .....	333
S-curve Configuration .....	333
S-curve Acceleration Ramp Example: .....	335
Speed Regulation Functions .....	335
Adaptive Speed Regulator .....	335
Speed Up Function .....	338

Speed Threshold Indicators ..... 339

Speed Zero Function..... 340

Speed Draw Function..... 341

Speed / Torque Mode Selection ..... 342

    Zero Torque Mode ..... 342

    Speed Regulation Mode ..... 343

    Torque Regulation Mode ..... 343

    Speed Limited Adjustable Torque (SLAT) Min Mode  
    and SLAT Max Mode..... 343

    Sum Mode..... 347

Start At Powerup..... 348

Fine-Tuning the Regulators ..... 349

    Manually Adjusting the Current Regulator Tune Settings... 350

    Fine-Tuning the Field Current Regulator..... 352

    Fine-Tuning the Speed Regulator ..... 354

    Fine-Tuning the Voltage Regulator in the Field Converter ... 356

    Tuning the Field Current Curve..... 358

**Control Block Diagrams**

**Appendix D**

Diagram Conventions ..... 361

**Installing a Communication  
Adapter**

**Appendix E**

Communication Adapter Kits..... 385

What The Communication Adapter Kit Includes..... 385

Tools That You Need ..... 385

Safety Precautions..... 386

Installing the Communication Adapter Module in the Drive.... 386

    Frame A ..... 387

    Frames B and C ..... 388

    Frame D ..... 389

**Optional Analog and Digital I/O  
Expansion Circuit Board**

**Appendix F**

What This Option Board Provides ..... 391

I/O Expansion Board Wiring ..... 391

**Optional 115V AC to 24V DC I/O  
Converter Circuit Board**

**Appendix G**

What This Option Board Provides ..... 393

I/O Converter Board Wiring..... 394

**PowerFlex DC Standalone  
Regulator Installation**

**Appendix H**

Installation and Wiring Instructions..... 397

**Index** ..... 399

Topic	Page
Summary of Changes	10
Conventions	11
Drive Storage Conditions	11
Drive Nameplate Data	12
Drive Specifications	12
Additional Resources	15
Standard Drive Catalog Number Explanation	13
Standalone-Alone Regulator Catalog Numbers	14
Additional Resources	15

The purpose of this manual is to provide you with the basic information required to install, start-up, and troubleshoot the PowerFlex® DC drive. This manual is intended for qualified personnel. You must be able to program and operate DC drives. In addition, you must have an understanding of the parameter settings and functions that are detailed in this manual.

For PowerFlex DC Stand-Alone Regulator (SAR) installations, see [Appendix H](#) beginning on page [397](#) for important installation and configuration information.

This contents of this manual pertain to PowerFlex DC drive and PowerFlex Standalone Regulator firmware revisions 1.006...7.001.

## Summary of Changes

This manual contains new and updated information.

Topic	Page
Moved the product firmware revision information from the front cover to the Preface.	<a href="#">9</a>
Moved the General Precautions section to Chapter 1 - Installation and Wiring.	<a href="#">18</a>
Removed the Technical Support information from the Preface. See the back cover of this manual for Rockwell Automation support information.	–
Updated the guidance on multiple motor applications.	<a href="#">17</a>
Updated the weights for frame A drives.	<a href="#">20</a>
Updated the Field Current Configuration section with information on configuring the field current for an external, three-phase field and permanent magnet motor.	<a href="#">61</a>
Updated the DIP switch S14 settings description in the Control Circuit Board Jumper and DIP Switch Settings table.	<a href="#">78</a>
Updated the Drive Start Up procedures to include configuration of the field current for an external, three-phase field and permanent magnet motor use.	<a href="#">93</a>
Add the new parameters to the Advanced Parameter View table.	<a href="#">121</a>
Added the following new parameters to Chapter 3 - Programming and Parameters:	–
<b>Parameter</b>	<b>Page</b>
165 [Firing Angle]	<a href="#">129</a>
21 [Min Firing Angle]	<a href="#">131</a>
410 [Ext FC Curr Hyst]	<a href="#">133</a>
411 [FC Lim Ramp]	<a href="#">137</a>
412 [FC Lim Ramp Time]	<a href="#">137</a>
409 [SSC Threshold]	<a href="#">186</a>
Updated the description for Par 500 [Flux Ref Pct].	<a href="#">129</a>
Updated the description for Par 280 [Nom Mtr Fld Amps] to include details for PowerFlex DC Field Controller applications.	<a href="#">132</a>
Changed the maximum value for parameter 374 [Drv Fld Brdg Cur] from 80.00 to 570.00 Amps.	<a href="#">132</a>
Added options 4...7 to parameter 469 [Field Mode Sel] for PowerFlex DC Field Controller operating mode selections.	<a href="#">134</a>
Changed the maximum value for parameter 1381 [Testpoint Sel] from 574 to 585.	<a href="#">183</a>
Added option 26 "FC Fdbk" to the [Anlg Inx Sel] parameters (70, 75, and 80).	<a href="#">195</a>
Changed option 24 "Field Ref" to "Flux Ref Pct" for the [Anlg Outx Sel] parameters (66...69).	<a href="#">198</a>
Added option 36 "Fld Cur Ref" to the [Anlg Outx Sel] parameters (66...69).	<a href="#">198</a>
Added options 73 "Wired FC En", 74 "Wired FC Inv", and 75 "Wired FC Act" to the digital input parameters 133...144 [Digital Inx Sel].	<a href="#">199</a>
Corrected the number for the Open SCR fault to 89.	<a href="#">223</a>
Corrected the number for the Shorted SCR fault to 90.	<a href="#">224</a>
Added the new SSC Error (20) fault.	<a href="#">225</a>
Added the Open SCR alarm.	<a href="#">229</a>
Added new codes 582...585 to the Testpoint Codes and Functions table.	<a href="#">233</a>
Added the Multiple Motor Applications topic to Appendix C.	<a href="#">319</a>
Added the Parameter 21 [Min Firing Angle] Configuration topic to Appendix C.	<a href="#">320</a>
Removed Appendix I - History of Changes (obsoleted).	–

## Conventions

- To help differentiate parameter names and LCD display text from other text, the following conventions are used:
  - Parameter names appear in [brackets].  
For example: [Armature Voltage].
  - Display text appears in “quotes.” For example: “Enabled.”




## Drive Storage Conditions

If it is necessary to store the drive for any length of time before installation, follow these storage guidelines to provide satisfactory start-up operation and retain warranty coverage:

- After receipt and inspection, repack the drive in its original shipping container and store in a clean, dry place.
- Place where the ambient temperatures do not exceed  $-25^{\circ}\text{C}$  ( $-13^{\circ}\text{F}$ ) or  $55^{\circ}\text{C}$  ( $131^{\circ}\text{F}$ )
- Place where the range of relative air humidity does not exceed 5...95%.
- At an altitude of less than 3,000 meters (10,000 ft.) above sea level.

## Drive Nameplate Data

The PowerFlex DC drive contains a data nameplate label on the side of each drive. This nameplate identifies the specific model number, applicable AC input power, and DC output power data. Include this information when communicating with Rockwell Automation personnel about this product.

Cat No. 20P41AD4P1RA0NNN		Series: A	Drive series letter
UL Type OPEN/IP20		I/O: 24VDC (Standard)	Firmware revision
Input: 460VAC 50/60 Hz 3.3A 3 Phase		Original Firmware V.1.001	Certification Marks Location.
Output: 500VDC 4.1A REGEN 2.0HP			See the data nameplate label on your drive for actual agency certifications.
1 Min Overload Amps	6.2		
3 Sec Overload Amps	8.2		
DC Field: Input: 460VAC 50/60 Hz 10A max. 1 Phase Output: 360VDC 10A max.			
Regulator Power: 115/230VAC 50/60 Hz 1.0/0.5A 1 Phase			
MFD. in 2XXX on MMM DD		Frame: A	Drive frame size
		Serial Number: A23E0042	Drive serial number
			

### Drive Series Letter

Series B drives are identified as such on the data nameplate label. The drive series letter is on the top, right side of the label.

### Drive Frame Sizes

Similar PowerFlex DC drive ratings are grouped into frame sizes to make ordering spare parts and drive dimensions simpler. The drive frame size is listed just above the serial number on the data nameplate label. See the Standard Drive Catalog Number Explanation on page 13 for a list of drive catalog numbers and their respective frame sizes.

### Drive Firmware Revision

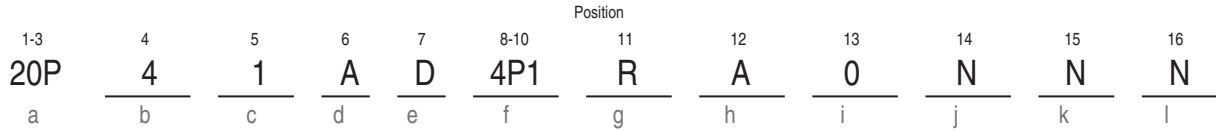
The original firmware revision of the drive as shipped from the factory appears on the data nameplate label just above the certifications. If the firmware revision has been upgraded since the drive was shipped, you can view the current revision on the HIM (if installed). See Diagnostics Menu on page 284 for details.

## Drive Specifications

For drive specification information, see the PowerFlex Digital DC Drive, Technical Data, [20P-TD001](#).



# Standard Drive Catalog Number Explanation



**a**

Drive	
Code	Type
20P	PowerFlex DC

**b**

Motor Operation	
Code	Type
2	Two Quadrant Operation *
4	Four Quadrant Operation

\* Not available for 230V AC input drives.

**C**

Input Type	
Code	Type
1	6 Pulse

**d**

Enclosure		
Code	Enclosure Rating	Conform. Coat
A	IP20, NEMA/UL Type Open	Yes

**e**

Input Voltage	
Code	Voltage
B	230V AC
D	460V AC *
E	600V AC
F	690V AC

\* Use this code for 400V AC input applications.

**f1**

230V, 60 Hz Input					
Code	Hp	kW	Armature Amps	Frame	Field Amps
7P0	1.5	1.2	7	A	10
9P0	2	1.5	9	A	10
012	3	2.2	12	A	10
020	5	3.7	20	A	10
029	7.5	5.5	29	A	10
038	10	7.5	38	A	10
055	15	11	55	A	10
073	20	15	73	A	14
093	25	18.5	93	A	14
110	30	22	110	A	14
146	40	30	146	B	20
180	50	37	180	B	20
218	60	45	218	B	20
265	75	56	265	B	20
360	100	75	360	B	20
434	125	93	434	B	20
521	150	112	521	C	20
700	200	149	700	C	20
875	250	186	875	D	40
1K0	300	224	1050	D	40

**f2**

460V, 60 Hz Input					
Code	Hp	kW	Armature Amps	Frame	Field Amps
4P1	2	1.5	4.1	A	10
6P0	3	2.2	6	A	10
010	5	3.7	10	A	10
014	7.5	5.5	14	A	10
019	10	7.5	19	A	10
027	15	11	27	A	10
035	20	15	35	A	10
045	25	18.5	45	A	10
052	30	22	52	A	10
073	40	30	73	A	14
086	50	37	86	A	14
100	60	45	100	A	14
129	75	56	129	A	14
167	100	75	167	B	20
207	125	93	207	B	20
250	150	112	250	B	20
330	200	149	330	B	20
412	250	187	412	B	20
495	300	224	495	C	20
667	400	298	667	C	20
830	500	373	830	D	40
996	600	447	996	D	40
1K1	700	552	1162	D	70
1K3	800	597	1238	D	70
1K4	900	671	1494	D	70

**f3**

575V, 60 Hz Input					
Code	Hp	kW	Armature Amps	Frame	Field Amps
067	50	37	67.5	B	20
101	75	56	101.3	B	20
135	100	75	135	B	20
270	200	149	270	B	20
405	300	224	405	B	20
540	400	298	540	C	20
675	500	373	675	C	20
810	600	447	810	D	40
1K0	800	597	1080	D	40
1K2	900	671	1215	D	40
1K3	1000	746	1350	D	40
1K6	1250	932	1668	D	40

**f4**

690V, 60 Hz Input					
Code	Hp	kW	Armature Amps	Frame	Field Amps
452	400	298	452	C	20
565	500	373	565	C	20
678	600	447	678	D	40
791	700	552	791	D	40
904	800	597	904	D	40
1K0	900	671	1017	D	40
1K1	1000	746	1130	D	70
1K2	1100	820	1243	D	70
1K4	1250	932	1413	D	70
1K5	1400	1044	1582	D	70

## Standard Drive Catalog Number Explanation, Cont.

1-3	4	5	6	7	8-10	11	12	13	14	15	16
20P	4	1	A	D	4P1	R	A	0	N	N	N
<i>a</i>	<i>b</i>	<i>c</i>	<i>d</i>	<i>e</i>	<i>f</i>	<i>g</i>	<i>h</i>	<i>i</i>	<i>j</i>	<i>k</i>	<i>l</i>

*g*

Field Supply	
Code	Type
R	Single-Phase Regulated

*h*

Packaging/Documentation		
Code	Shipping Carton	User Manual
A	Yes	Yes

*i*

HIM	
Code	Operator Interface
0	Blank Cover *

\* Standard - for user installed options, see Human Interface and Wireless Interface Modules on page 9.

*j*

I/O Options *	
Code	Control
N	None (8 - 24V DC Digital Inputs, 4 Digital Outputs, 3 Analog Inputs, and 2 Analog Outputs are Standard)

\* All I/O Options are purchased separately and are user installed. See I/O Options on page 9.

*k*

Communication Options	
Code	Description
N	None *

\* Standard - for user installed options, see Communication Option Kits on page 10.

*l*

Cabinet Options	
Code	Type
N	None

## Standalone-Alone Regulator Catalog Numbers

Conformally coated circuit boards are provided with the following catalog numbers.

230V / 460V AC Input Regulators	575V / 690V AC Input Regulators	Field Amps
Cat. No.	Cat. No.	
23PMD4	23PMF4	40
23PMD7	23PMF7	70
23PAMP <sup>(1)</sup>	23PAMP <sup>(1)</sup>	(1)

(1) Gate Amplifier - used with all voltage classes of the Stand-Alone Regulator. The Stand-Alone Regulator and Gate Amplifier are currently sold through Rockwell Automation Drive Systems only. Consult the factory for availability.

## Additional Resources

These documents contain additional information concerning related products from Rockwell Automation.

Resource	Description
PowerFlex Digital DC Drive and PowerFlex DC Field Controller Technical Data, publication <a href="#">20P-TD001</a>	Provides detailed information on drive, field controller and option specifications.
Preventive Maintenance of Industrial Control and Drive System Equipment, publication <a href="#">DRIVES-TD001</a>	Provides a checklist for performing preventive maintenance.
PowerFlex Digital DC Drive - Frame A Hardware Service Manual, publication <a href="#">20P-TG001</a>	Provides hardware test procedures and spare parts replacement instructions for Frame A PowerFlex DC drives and field controllers.
PowerFlex Digital DC Drive - Frame B Hardware Service Manual, publication <a href="#">20P-TG002</a>	Provides hardware test procedures and spare parts replacement instructions for Frame B PowerFlex DC drives and field controllers.
PowerFlex Digital DC Drive - Frame C Hardware Service Manual, publication <a href="#">20P-TG003</a>	Provides hardware test procedures and spare parts replacement instructions for Frame C PowerFlex DC drives and field controllers.
PowerFlex Digital DC Drive - Frame D Hardware Service Manual, publication <a href="#">20P-TG004</a>	Provides hardware test procedures and spare parts replacement instructions for Frame D PowerFlex DC drives and field controllers.
Safety Guidelines for the Application, Installation, and Maintenance of Solid-State Control, publication <a href="#">SGI-1.1</a>	Provides general guidelines for the application, installation, and maintenance of solid-state control in the form of individual devices or packaged assemblies that incorporate solid-state components.
Industrial Automation Wiring and Grounding Guidelines, publication <a href="#">1770-4.1</a>	Provides general guidelines for installing a Rockwell Automation industrial system.
Product Certifications website, <a href="http://www.rockwellautomation.com/global/certification/overview.page">http://www.rockwellautomation.com/global/certification/overview.page</a>	Provides declarations of conformity, certificates, and other certification details.

You can view or download publications at <http://www.rockwellautomation.com/global/literature-library/overview.page>. To order paper copies of technical documentation, contact your local Allen-Bradley distributor or Rockwell Automation sales representative.

**Notes:**

## Installation and Wiring

Topic	Page	Topic	Page
Product Advisories	18	CE Conformity	40
Mount the Drive	19	Power Circuit Protection	43
Approximate Drive Dimensions and Weights	20	Control Power Circuit Protection	43
Lifting PowerFlex DC Drives	26	Cable and Wiring Recommendations	44
Remove the Drive Covers	28	Power Wiring	45
Isolation Transformers / Line Reactors	30	DIP Switch and Jumper Settings	77
Contactors	31	I/O Wiring	82
General Grounding Requirements	33		

This chapter provides information on how to install the PowerFlex® DC drive.

Most start-up difficulties are the result of incorrect wire connections. Take all precautions to assure that wire connections are done as instructed. All items must be read and understood before the actual installation begins.

For PowerFlex DC Stand-Alone Regulator (SAR) installations, see [Appendix H](#) beginning on page [397](#) for important installation and configuration information. A 23PMDx catalog number on the data nameplate on the drive identifies a SAR. (see Drive Nameplate Data on page [12](#) for location).

The PowerFlex DC drive can be used in multiple motor applications. The motors can be configured for parallel or series connections. See Multiple Motor Applications on page [319](#) for installation and configuration guidance.

---

**IMPORTANT** The PowerFlex DC drive is not designed for use with resistive or magnetic loads.

---



---

**IMPORTANT** The recommended drive to motor horsepower ratio is 2:1.

---



**ATTENTION:** The following information is merely a guide for proper installation. Rockwell Automation cannot assume responsibility for the compliance or the noncompliance to any code, national, local or otherwise for the proper installation of this drive or associated equipment. If codes are ignored during installation, a hazard of personal injury and equipment damage exists.

---

## Product Advisories



**ATTENTION:** This drive contains ESD (Electrostatic Discharge) sensitive parts and assemblies. Static control precautions are required when you install, test, service, or repair this assembly. If ESD control procedures are not followed, component damage can result. If you are not familiar with static control procedures, see publication 8000-4.5.2, “Guarding Against Electrostatic Damage” or any other applicable ESD protection handbook.



**ATTENTION:** An incorrectly applied or installed drive can result in component damage or a reduction in product life. Installation or application errors, such as, an undersized motor, incorrect or inadequate AC supply, or excessive air temperatures around the drive can result in malfunction of the system.



**ATTENTION:** Allow only qualified personnel, familiar with DC drives and associated machinery, to plan or implement the installation, start-up and subsequent maintenance of the system. Failure to comply can result in personal injury and equipment damage.



**ATTENTION:** An incorrectly applied or installed bypass system can result in component damage or reduction in product life. The most common causes are:

- An AC line connection to the drive output or control terminals.
- Improper bypass or output circuits that are not Allen-Bradley approved.
- Output circuits that do not connect directly to the motor.

Contact Allen-Bradley for assistance with your application or installation.

---

## Mount the Drive

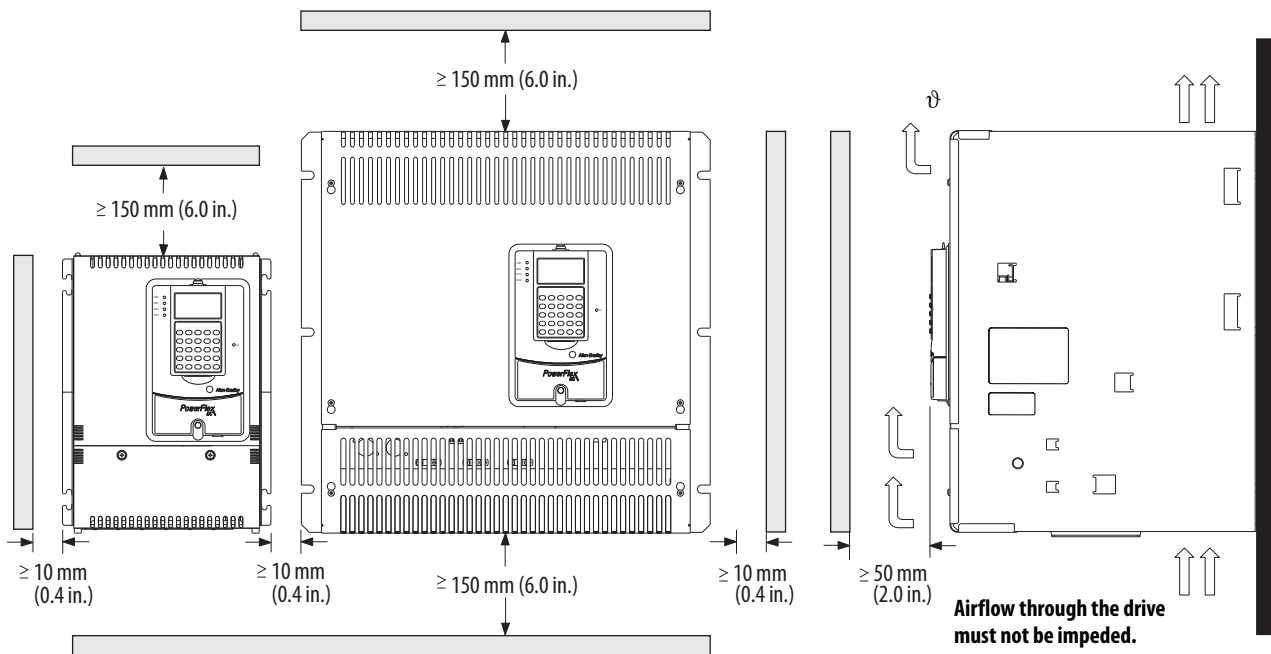
## Operating Conditions and Temperatures

PowerFlex DC drives are designed to operate at 0...50 °C (32...122 °F) surrounding air temperature without derating. The drive must be mounted in a clean, dry location. Contaminants such as oils, corrosive vapors, and abrasive debris must be kept out of the enclosure. NEMA / UL Type Open, IP20 enclosures are intended for indoor use primarily to provide a degree of protection against contact with enclosed equipment. These enclosures offer no protection against airborne contaminants.

## Minimum Mounting Clearances

Minimum clearance requirements are intended to be from drive to drive. Other objects can occupy this space; however, reduced airflow can cause protection circuits to fault the drive. The drive must be mounted in a vertical orientation as shown in [Figure 1](#) and must not be mounted at an angle greater than 30° from vertical. Intake air temperature must not exceed the product specification.

**Figure 1 - Drive Enclosure Minimum Mounting Clearances**



## Maximum Surrounding Air Temperature Specifications

- 0...50 °C (32...122 °F), typical
- De-rate 1.25% for every 1 °C (°F) over 50 °C (122 °F), to 55 °C (131 °F)
- Additional air cooling is required for temperatures above 55 °C (131 °F)

## Approximate Drive Dimensions and Weights

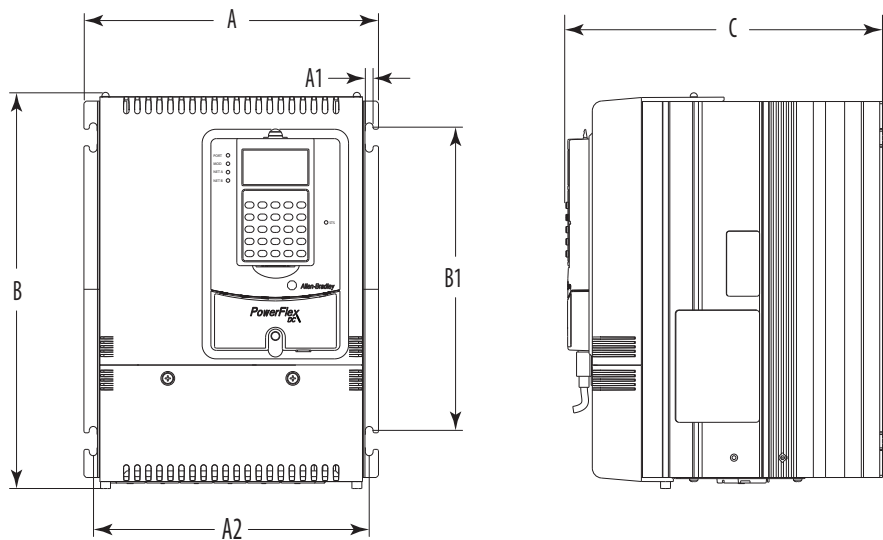
The PowerFlex DC drive is available in a NEMA / UL Type Open, IP20 enclosure only. Follow all mounting clearances to provide proper drive operation.



**ATTENTION:** Remove all loose packing materials, including the containers of desiccants (if any), from the drive enclosure before you mount and energize the drive.

**Figure 2 - Frame A Drive Dimensions**

A	B	C	A1	A2	B1
mm (in.)	mm (in.)	mm (in.)	mm (in.)	mm (in.)	mm (in.)
267 (10.5)	359 (14.0)	287 (11.3)	7 (0.3)	250 (9.8)	275 (10.8)



**Table 1 - Frame A Weights**

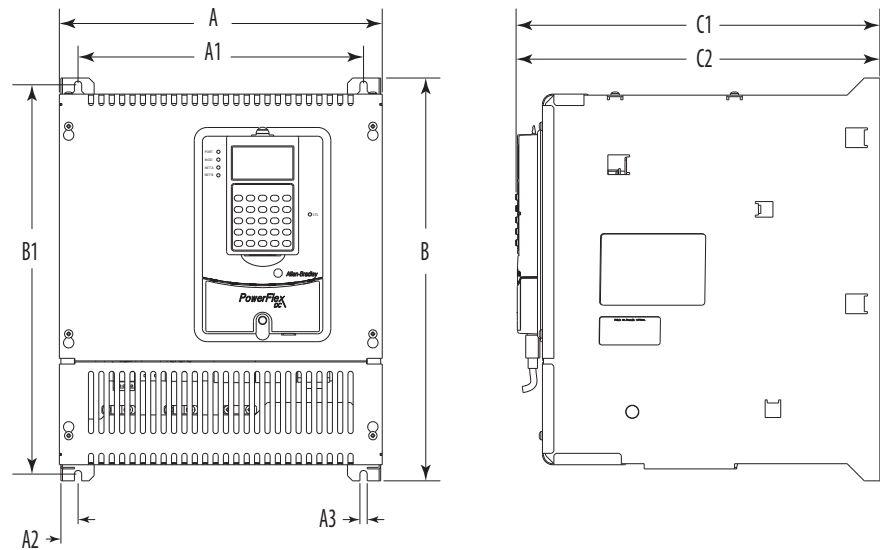
Drive Current Rating Code		Drive Weight	Drive and Packaging Weight
230V	460V	kg (lb)	kg (lb)
7P0	4P1	11.0 (24.25)	13.0 (28.7)
9P0	6P0		
012	010		
020	014		
–	019		
029	027		
038	035	11.5 (25.4)	13.5 (29.8)
055	045		
–	052	12.0 (26.5)	14.0 (30.9)
073	073		
093	086		
110	100		
–	129		



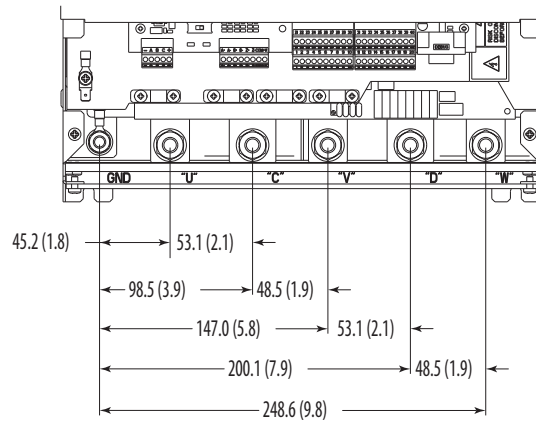
**Figure 3 - Frame B Drive Dimensions**

A	A1	A2	A3	B	B1	C1	C2 <sup>(1)</sup>
mm (in.)	mm (in.)	mm (in.)	mm (in.)	mm (in.)	mm (in.)	mm (in.)	mm (in.)
311 (12.2)	275 (10.8)	16.5 (0.65)	7 (0.3)	388 (15.3)	375 (14.8)	350 (13.8)	380 (15.0)

(1) Only frame B drive catalog numbers 20P21AD330, 20P21AD412, 20P21AE405, 20P41AB360, 20P41AB434, 20P41AD330, 20P41AD412, 20P41AE405.



Terminal Details - Dimensions in mm (in.)

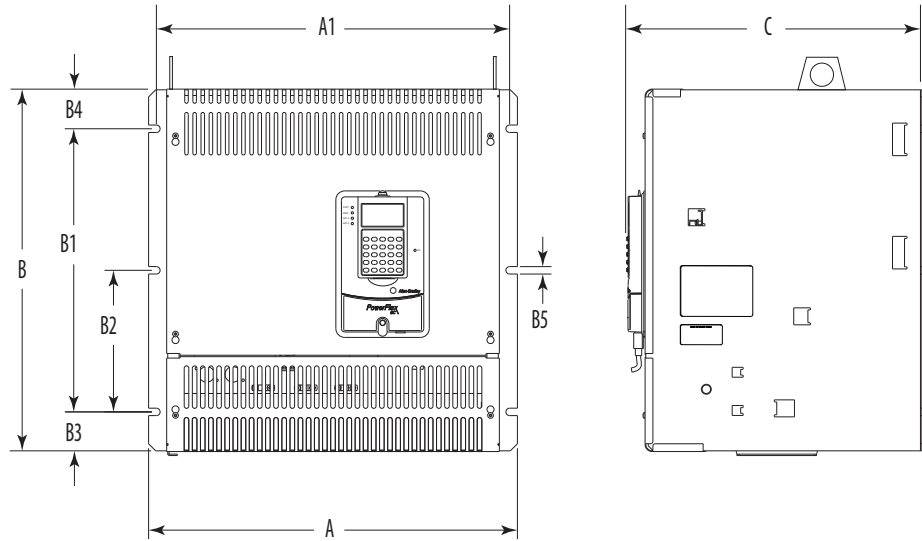


**Table 2 - Frame B Weights**

Drive w/ND Rating Code			Drive Weight	Drive and Packaging Weight
230V	460V	575V	kg (lb)	kg (lb)
146	167	067	25.5 (56.2)	27.5 (60.6)
180	207	101		
218	—	135		
265	250	270	29.5 (65.0)	31.5 (69.5)
360	330	405	32 (70.5)	34 (75)
434	412	—		

Figure 4 - Frame C Drive Dimensions

A	A1	B	B1	B2	B3	B4	B5	C
mm (in.)	mm (in.)	mm (in.)	mm (in.)	mm (in.)	mm (in.)	mm (in.)	mm (in.)	mm (in.)
521 (20.5)	499 (19.7)	511 (20.1)	400 (15.7)	200 (7.9)	55 (2.2)	56 (2.2)	10.5 (0.4)	416 (16.4)



Terminal Details - Dimensions in mm (in.)

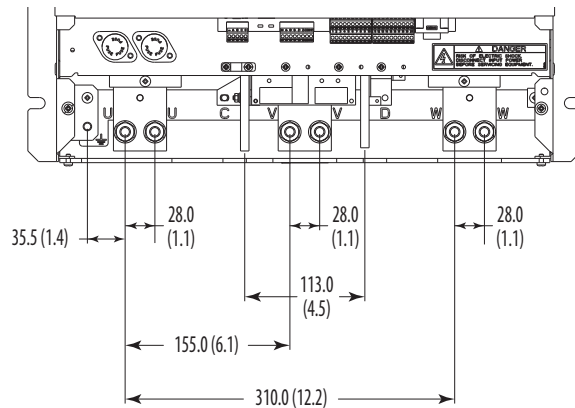
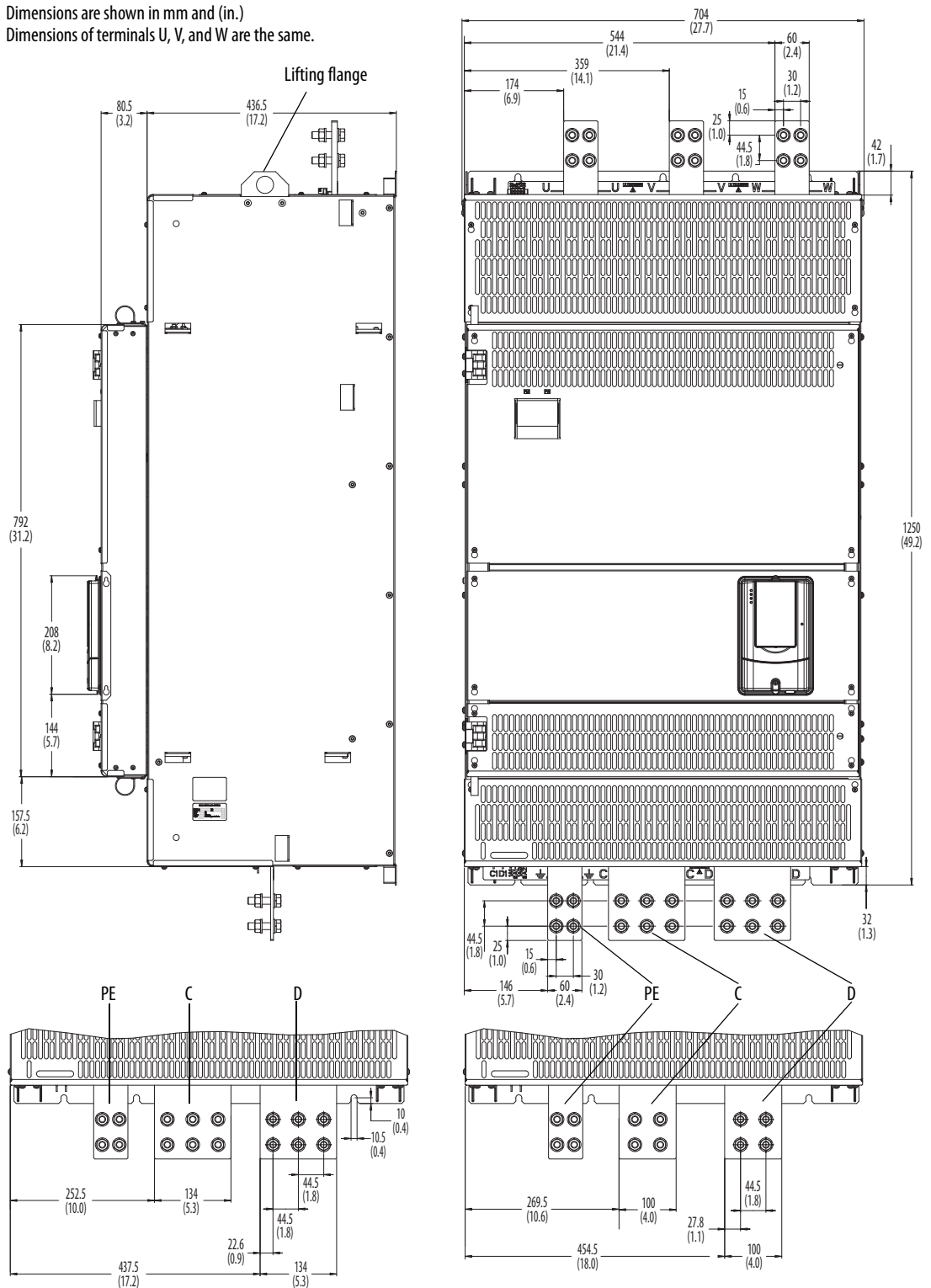


Table 3 - Frame C Weights

Drive w/ND Rating Code				Weight - Regenerative Drives		Weight - Non-regenerative Drives	
				Drive	Drive and Packaging	Drive	Drive and Packaging
230V	460V	575V	690V	kg (lb)	kg (lb)	kg (lb)	kg (lb)
–	495	–	–	61 (134.5)	83 (183.0)	57 (125.7)	79 (174.2)
521	667	–	–	65 (143.3)	87 (191.8)	62 (136.7)	84 (185.2)
700	–	–	–	–	–	–	–
–	–	540	452	72 (158.7)	94 (207.2)	68 (150.0)	90 (198.4)
–	–	675	565	–	–	–	–

**Figure 5 - Frame D Dimensions - Right Side and Front Views**

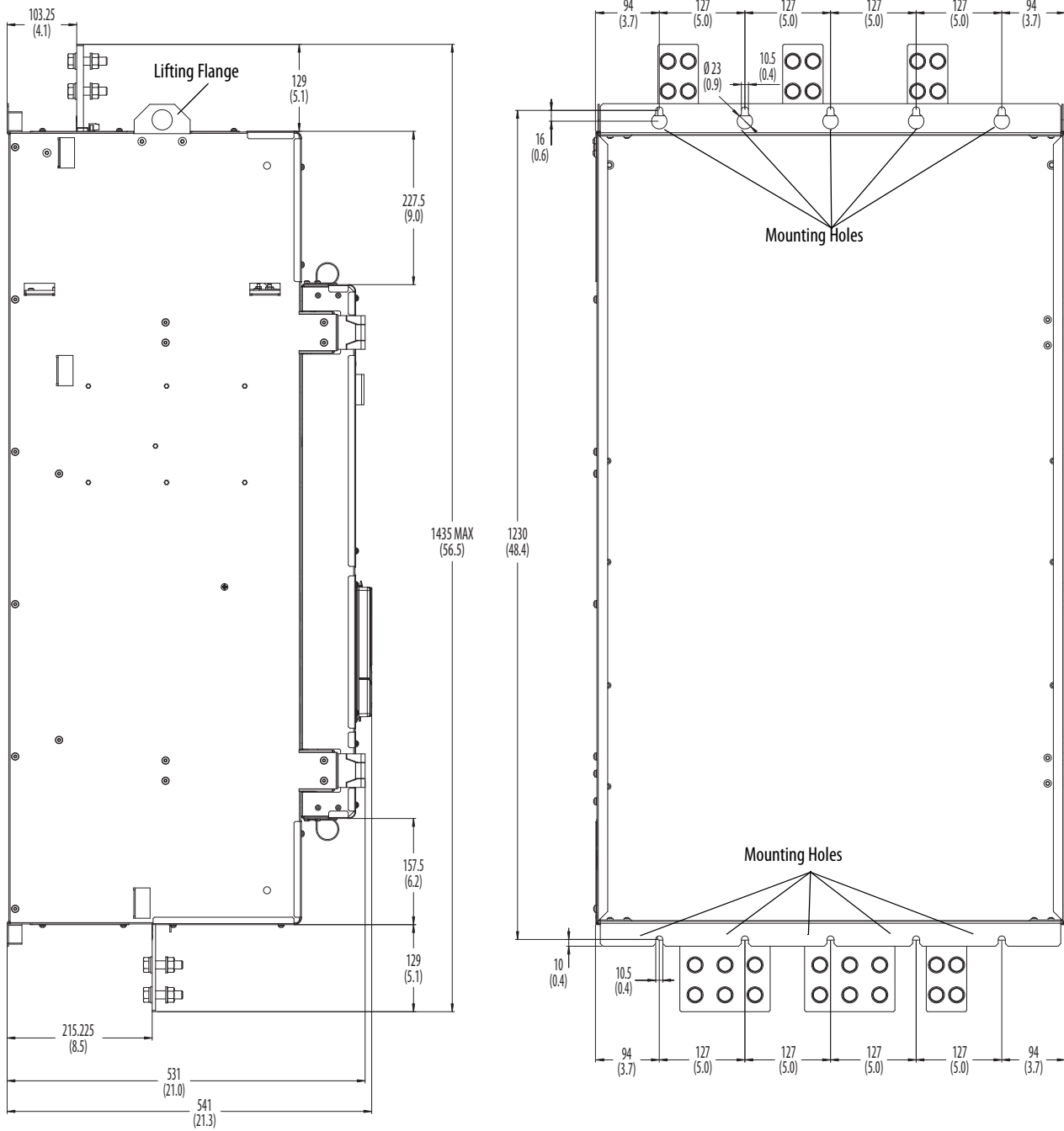
Dimensions are shown in mm and (in.)  
 Dimensions of terminals U, V, and W are the same.



- Terminals C and D are 134 mm (5.3 in.) on drives with these ratings only:
- 460V AC input: 800 Hp and 900 Hp
  - 575V AC input: 1000 Hp
  - 690V AC input: 1100 Hp, 1200 Hp, 1250 Hp, and 1400 Hp
- All other frame D drive ratings have 100 mm (4.0 in.) C and D terminals.

Figure 6 - Frame D Dimensions - Left Side and Back Views

Dimensions are shown in mm and (in.)



**Table 4 - Frame D - 230V AC Input Drive Weights**

Drive w/ND Rating Code	Weight - Regenerative Drives		Weight - Non-regenerative Drives	
	Drive	Drive and Packaging	Drive	Drive and Packaging
	kg (lb)	kg (lb)	kg (lb)	kg (lb)
875	203 (447.5)	281 (619.5)	152 (335.1)	230 (507.1)
1K0				

**Table 5 - Frame D - 460V AC Input Drive Weights**

Drive w/ND Rating Code	Weight - Regenerative Drives		Weight - Non-regenerative Drives	
	Drive	Drive and Packaging	Drive	Drive and Packaging
	kg (lb)	kg (lb)	kg (lb)	kg (lb)
830	202 (445.3)	280 (617.3)	152 (335.1)	230 (507.1)
996				
1K1	215 (474.0)	293 (646.0)	165 (363.8)	243 (535.7)
1K3				
1K4				

**Table 6 - Frame D - 575V AC Input Drive Weights**

Drive w/ND Rating Code	Weight - Regenerative Drives		Weight - Non-regenerative Drives	
	Drive	Drive and Packaging	Drive	Drive and Packaging
	kg (lb)	kg (lb)	kg (lb)	kg (lb)
810	198 (436.5)	276 (608.5)	148 (326.3)	226 (498.2)
1K0				
1K2	215 (474.0)	293 (646.0)	165 (363.8)	243 (535.7)
1K3	222 (489.4)	300 (661.4)	172 (379.2)	250 (551.2)
1K6	241 (531.3)	319 (703.3)	191 (421.1)	269 (593.0)

**Table 7 - Frame D - 690V AC Input Drive Weights**

Drive w/ND Rating Code	Weight - Regenerative Drives		Weight - Non-regenerative Drives	
	Drive	Drive and Packaging	Drive	Drive and Packaging
	kg (lb)	kg (lb)	kg (lb)	kg (lb)
678	198 (436.5)	276 (608.5)	148 (326.3)	226 (498.2)
791				
904	200 (440.9)	278 (612.9)	150 (330.7)	228 (502.7)
1K0	202 (445.3)	280 (617.3)	152 (335.1)	230 (507.1)
1K1	215 (474.0)	293 (646.0)		
1K2			165 (363.8)	243 (535.7)
1K4	241 (531.3)	319 (703.3)	172 (379.2)	250 (551.2)
1K5			191 (421.1)	269 (593.0)

## Lifting PowerFlex DC Drives

The dimensions and weights that are specified in [Table 3](#) on page [22](#) and [Table 4...Table 7](#) on page [25](#) must be considered when the device is lifted and mounted. Use the proper equipment to lift and hold the weight of the drive while it is mounted.



**ATTENTION:** Follow this guidance to guard against possible personal injury or equipment damage:

- Inspect all lifting hardware for proper attachment before the drive is lifted.
- Do not let any part of the drive or lift mechanism to contact electrically charged conductors or components.
- Do not subject the drive to high rates of acceleration or deceleration while the drive is transported to the installation location or is lifted.
- Do not let personnel or their limbs be directly underneath the drive when it is lifted and mounted.

## Mount Frame C and D Drives

All lifting equipment and components (hooks, bolts, lifts, slings, and chains) must have a minimum lifting capacity of 453.6 kg (1,000 lb).

**IMPORTANT** Verify that all mounting screws are properly tightened before and after drive operation.

1. Verify the hole pattern on the panel on which you intend to mount the drive. See [Figure 4](#) on page [22](#) or [Figure 5](#) on page [23](#).
2. Install the mounting hardware:
  - For frame C drives, insert, but do not tighten, a bolt in one of the top holes in the panel. The bolt must be fully threaded into the panel before hanging the drive.
  - For Frame D drives, insert, but do not tighten, the six bolts for the top mounting flange on the drive into the panel. The bolts must be fully threaded into the panel before hanging the drive.
3. To limit the pull in forces on the drive, the lifting devices that are connected to the hooks must be long enough to make the angle between the chain or cable and a vertical line that extends up from the flange center less than 45° angle as illustrated in [Figure 7](#) or [Figure 8](#) on page [27](#).
  - For frame C drives, insert the properly sized and rated lifting hooks into the holes on the lifting flanges at the top of the drive. See [Figure 7](#) on page [27](#).
  - For frame D drives, insert the properly sized lifting rod into the holes on the lifting flanges at the top of the drive. See [Figure 8](#) on page [27](#).

Figure 7 - Lift Frame C Drives

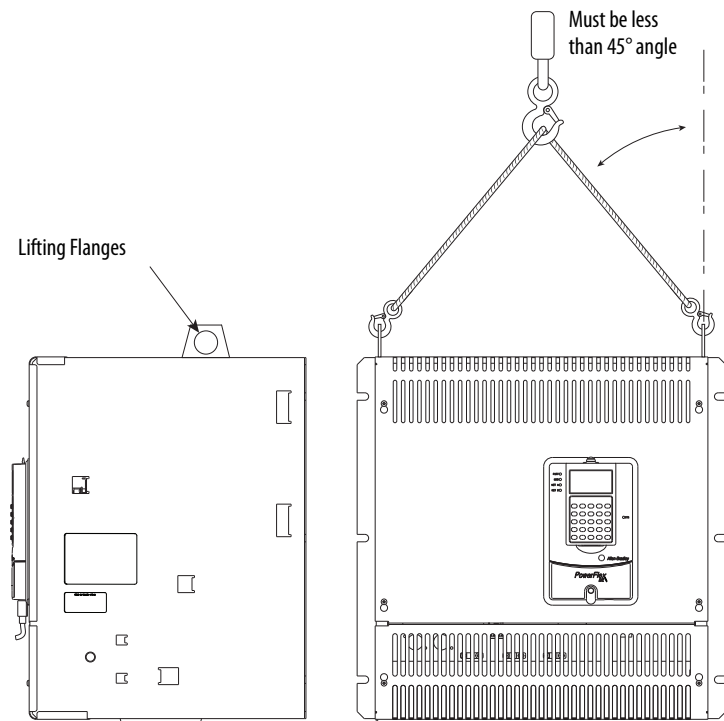
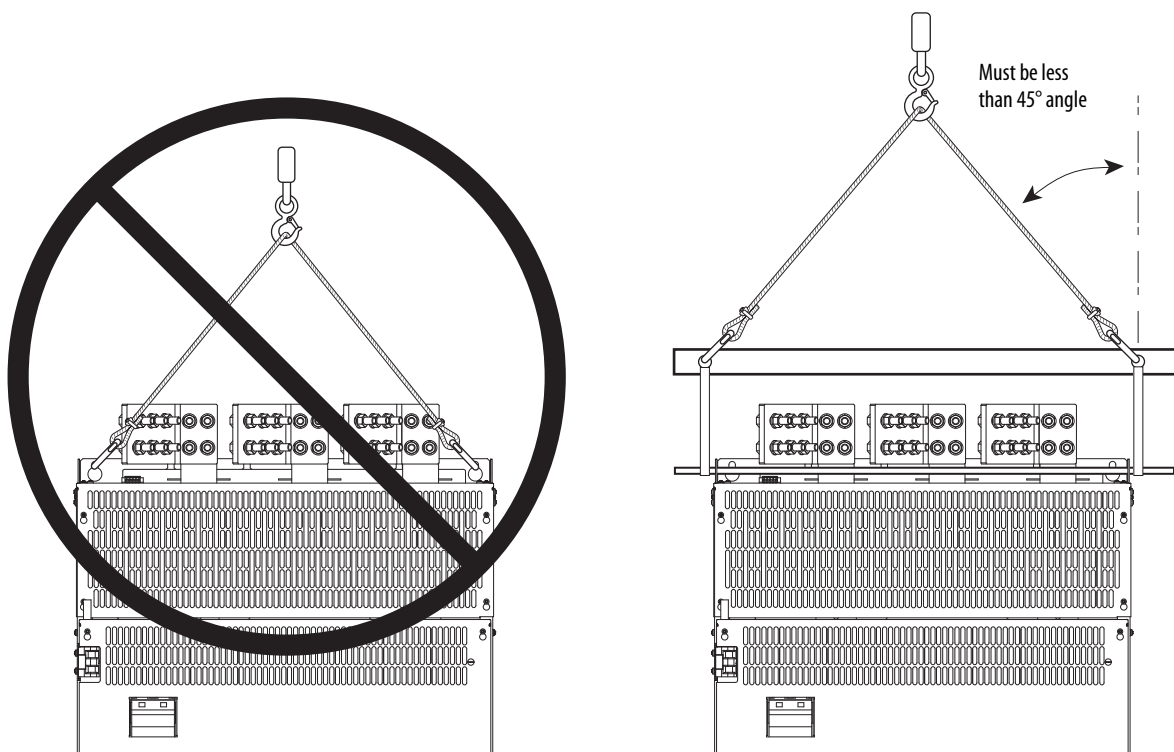


Figure 8 - Lift Frame D Drives



4. Lift the drive into place onto the bolts that are installed in the panel.
5. Install the remaining bolts into the panel. Tighten M8 bolts to a minimum torque of 15 N•m (132.7 lb•in) and M10 bolts to a minimum torque of 25 N•m (221.2 lb•in).

## Remove the Drive Covers

Some protective covers must be removed to provide access to the power and I/O terminals on the drive. Remove the upper cover only to install an optional communication adapter or service the drive. See *Installing a Communication Adapter* on page [385](#) for information.

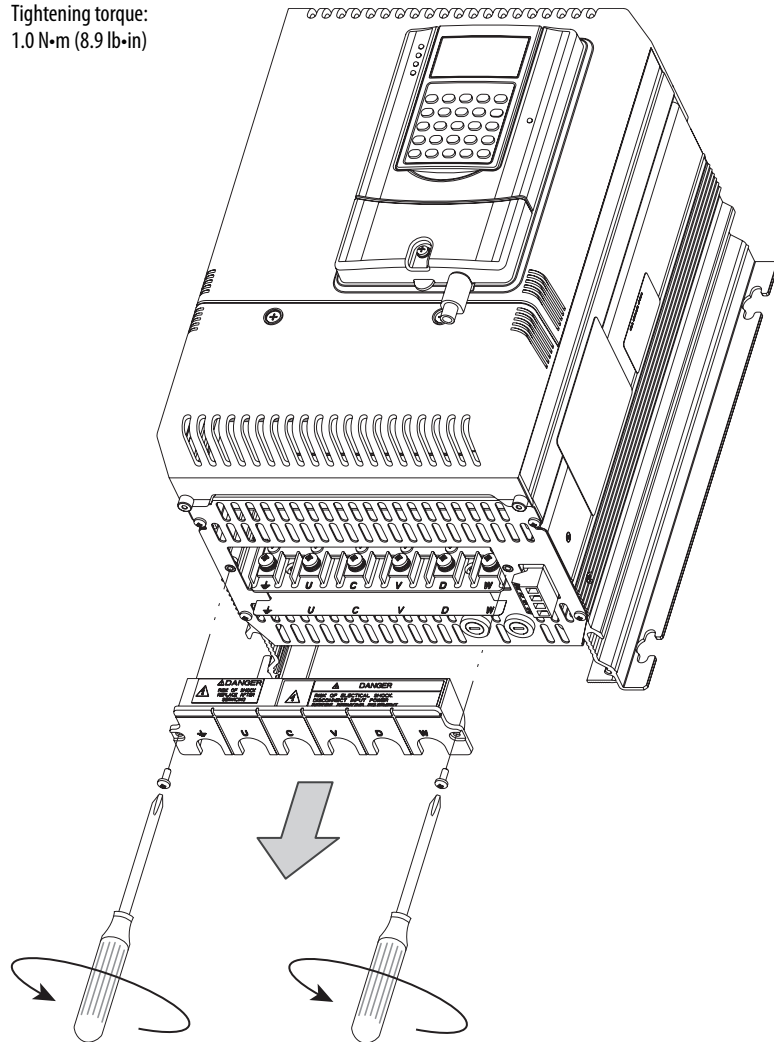
### Frame A Drives

You must remove both the lower protective cover and the power terminal cover on frame A drives to access the power terminals.

#### *Remove the Power Terminal Cover*

Remove the two screws as shown here and slide the cover down and off the chassis.

Tightening torque:  
1.0 N•m (8.9 lb•in)

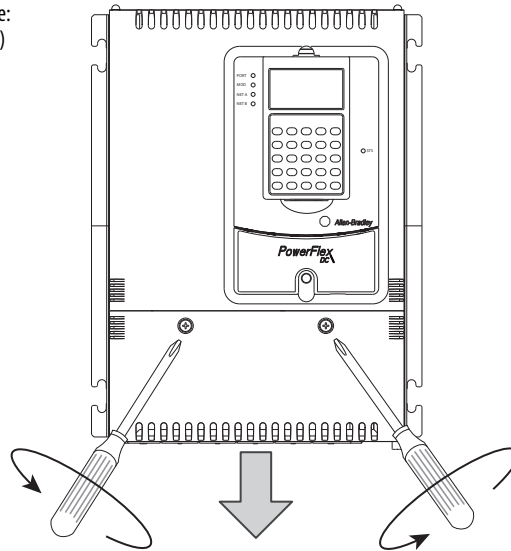




### Remove the Lower Protective Cover

Remove the two screws as shown here and, while gently lifting along the top edge, slide the cover down and off the chassis.

Tightening torque:  
1.5 N·m (13 lb·in)

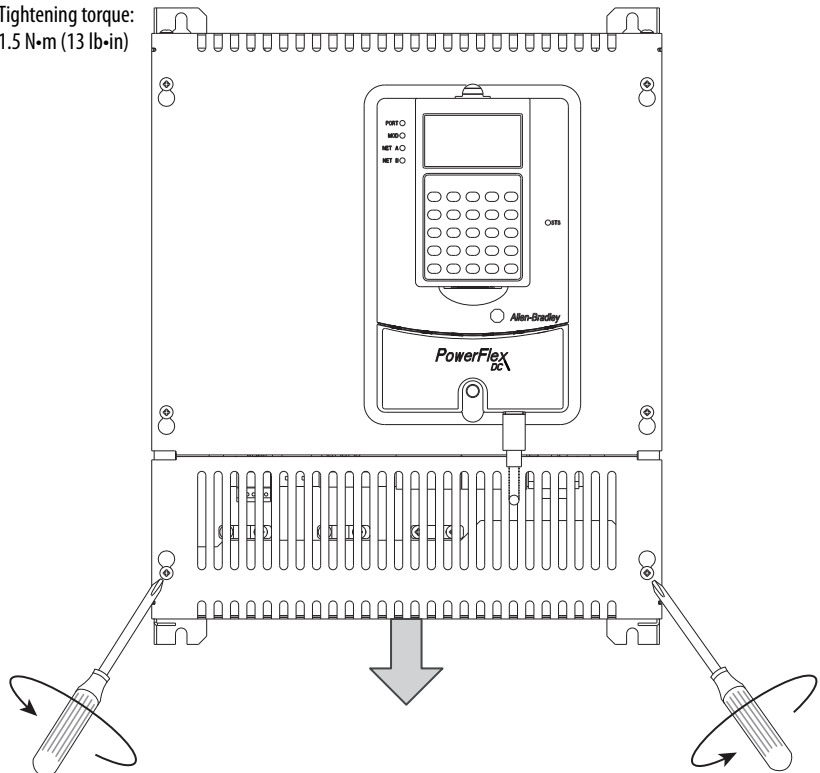


### Frame B and C Drives

1. Loosen, but do not remove, the two screws that secure the bottom cover.
2. Slide the cover down until the screw heads align with the key holes and lift the cover off the chassis.

Frame B Shown

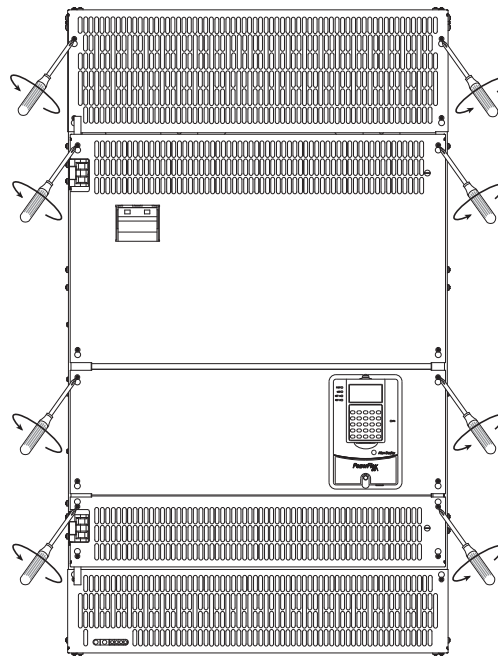
Tightening torque:  
1.5 N·m (13 lb·in)



## Frame D

1. For any protective cover, loosen, but do not remove, the hexalobular head screws that secure the cover to the drive frame.
2. Slide the cover up until the screw heads align with the key holes and lift the cover off the chassis. The top and bottom most covers are also secured with screws at the top and bottom of the drive, respectively.

Tightening torque:  
1.5 N·m (13 lb·in)



## Isolation Transformers / Line Reactors

When connecting the drive directly to the main distribution system, an isolation transformer or 3...5% impedance AC line reactor must be used to guard against system disturbance. If the isolation transformer provides the required 3...5% impedance, a line reactor is not required.

See Isolation Transformers on page [267](#) for a list of recommended isolation transformers.

See AC Input Line Reactors and AC Input Contactors on page [264](#) for a list of recommended AC line reactors. The type of line reactor that is used depends upon the following:

- Current absorbed by the AC input
- AC input voltage
- Relative short-circuit voltage
- AC input frequency

## Contactors

When an AC input contactor is used, the IEC AC1 rating of the contactor must be equal to the rated thermal (RMS) current value at the main input of the drive.

Drive configurations for AC or DC contactors, with or without a dynamic brake (DB), are as follows (see Typical Power Wiring Diagrams on page 46 for examples):

- When only an AC contactor is used:
  - Set parameter [1391](#) [ContactorControl] to 1 “AC Cntcr” (default value) <sup>(1)</sup>
  - Set one [Relay Out *x* Sel] parameter and one [Digital In*x* Sel] parameter to “Contactor” (default value for parameters [1392](#) [Relay Out 1 Sel] and [140](#) [Digital In8 Sel])
- When only a DC contactor is used:
  - Set parameter [1391](#) [ContactorControl] to 3 “DC Cntcr” <sup>(1)</sup>
  - Set one [Relay Out *x* Sel] parameter and one [Digital In*x* Sel] to “Contactor” (default value for parameters [1392](#) [Relay Out 1 Sel] and [140](#) [Digital In8 Sel])
- When an AC contactor and dynamic brake contactor are used:
  - Set parameter [1391](#) [ContactorControl] to “AC Cntcr+DB” <sup>(1)</sup>
  - Set one [Relay Out *x* Sel] parameter ([1392](#) [Relay Out 1 Sel] or [629](#) [Relay Out 2 Sel]) to “Contactor” and the other relay output to “ContactorDB”
  - Set one [Digital In*x* Sel] parameter to “Contactor” (default value for parameter [140](#) [Digital In8 Sel])
- When a DC contactor and dynamic brake contactor are used:
  - Set parameter [1391](#) [ContactorControl] to “DC Cntcr+DB” <sup>(1)</sup>
  - Set one [Relay Out *x* Sel] parameter ([1392](#) [Relay Out 1 Sel] or [629](#) [Relay Out 2 Sel]) to “Contactor” and the other relay output to “ContactorDB”
  - Set one [Digital In*x* Sel] parameter to “Contactor” (default value for parameter [140](#) [Digital In8 Sel])

(1) Par 1391 [ContactorControl] is contained in the “Advanced” parameter configuration group. See How Parameters are Organized on page [118](#) for more information.

- When a contactor is NOT used:
  - Set parameter [1391](#) [ContactorControl] to “None” <sup>(1)</sup>
  - Do NOT set either [Relay Out *x* Sel] parameter to “Contactor” or “ContactorDB”
  - Do NOT set any [Digital In*x* Sel] parameter to “Contactor”

When operating a drive with firmware revision 1.006 in field weakening mode with a DC contactor or inverting fault device that is installed in the armature circuit, see Field-weakening Mode Configuration (v1.006) on page [302](#).

## AC Input Contactors

See AC Input Line Reactors and AC Input Contactors on page [264](#) for a list of recommended AC input contactors.

## DC Output Contactors

A DC output contactor can be used to connect the output of the armature circuit to the DC motor. If a DC output contactor is used, an AC input contactor is not needed.

See Dynamic Brake Resistor Kits and DC Output Contactors on page [269](#) for a list of recommended DC output contactors.

## Dynamic Brake Resistors

See Dynamic Brake Resistor Kits and DC Output Contactors on page [269](#) for a list of recommended dynamic brake resistor kits.

## General Grounding Requirements

**The drive Safety Ground (PE) must be connected to system ground.**

Ground impedance must conform to the requirements of national and local industrial safety regulations and electrical codes. Periodically check the integrity of all ground connections.

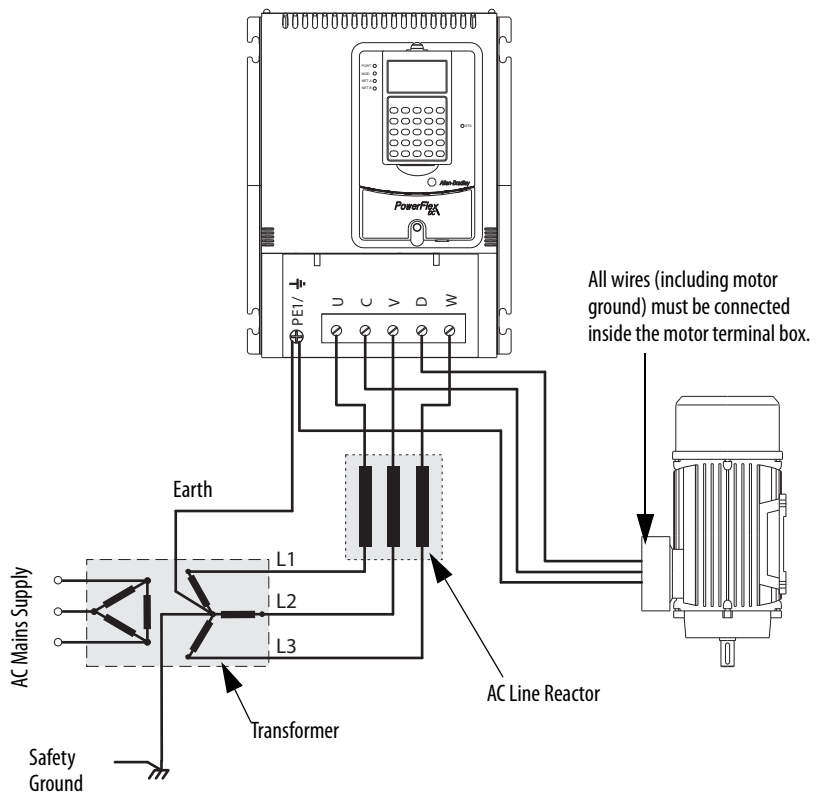
For installations within a cabinet, use a safety ground point or ground bus bar connected directly to building steel. Ground all circuits, including the AC input ground conductor, independently and directly to this point/bar.

For installations in distribution systems that have ungrounded or high impedance, neutral connections or systems, see Grounding for Installations in an Ungrounded or High-Impedance, Neutral Ground, or System on page 35.



**ATTENTION:** To comply with the essential requirements of the CE Low Voltage Directive 2006/95/EC, PowerFlex DC drives cannot be powered from a corner-earthed (TN with one phase earthed) supply system. When operating PowerFlex DC drives from an IT or impedance-earthed supply system, only temporary operation is permitted after an earth fault is detected in the power system.

**Figure 9 - Typical Grounding**



## Safety Ground (PE)

The drive Safety Ground-PE must be connected to adjacent building steel (girder, joist), a floor ground rod, or bus bar (see [Figure 9](#) on page [33](#)). Ground points must comply with national and local industrial safety regulations and electrical codes.

## Power Feeder

Each power feeder from the substation transformer to the drive must be provided with properly sized ground cables. Bond the conduit or cable armor to the substation ground at both ends. Each transformer enclosure or frame must be bonded to ground at a minimum of two locations.

## Encoder/Resolver Ground Connections

If used, the encoder or resolver ground connections must be routed in grounded steel conduit. The conduit must be grounded at both ends. The encoder/resolver cable shield must be connected to the shield ground on the drive side. Do not connect the encoder/resolver cable shield to ground on the motor side.

## Tachometer Ground Connections

If used, ground connections must be routed in grounded steel conduit. The conduit must be grounded at both ends. Ground the cable shield at the drive end by using only the shield clamps on the grounded metal plate that supports the control board. See [Figure 58](#) on page [83](#) for shield clamp location.

## Grounding for Installations in an Ungrounded or High-Impedance, Neutral Ground, or System

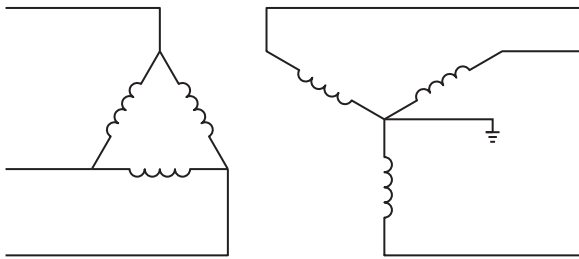
The PowerFlex DC drive was designed to work in distribution systems where the isolation transformer Wye neutral is connected to earth ground. PowerFlex DC drives are **not** designed to work in distribution systems that have ungrounded or high-impedance, neutral connections, or systems that have a phase that is referenced to earth. Symmetrical incoming power is required for correct drive operation.

The use of a grounded Wye neutral is highly recommended to prevent common-mode rejection problems with the feedback measurement circuits in the drive. Possible drive damage can occur because of inaccurate feedback measurements of the incoming AC voltage, armature voltage, or field current.

If the PowerFlex DC drive is installed in a system with an ungrounded Wye neutral or with an impedance ground connection, see [Table 8](#) on page 36. Table 8 contains the drive modifications that are required for proper installation.

### Power Distribution

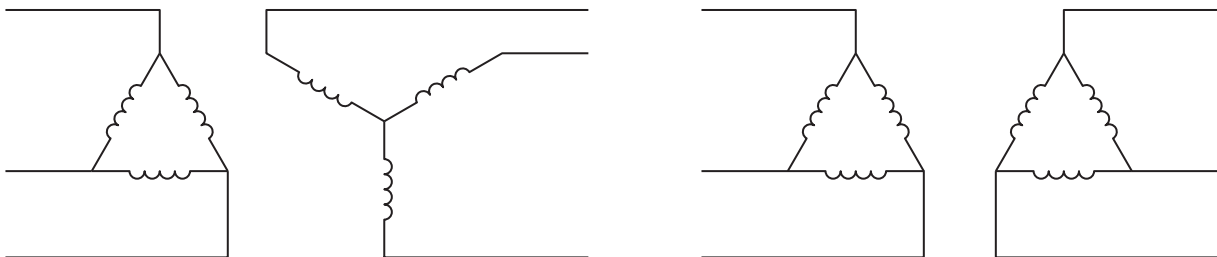
Figure 10 - Delta/Wye with Grounded Wye Neutral



Rockwell Automation strongly recommends the use of grounded neutral systems for the following reasons:

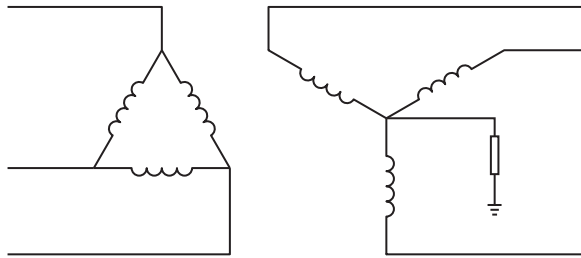
- Controlled path for common mode noise current
- Consistent line to ground voltage reference, which minimizes insulation stress
- Accommodation for system-surge protection schemes

Figure 11 - Ungrounded Secondary



Grounding the transformer secondary is essential to the safety of personnel and safe operation of the drive. A floating secondary can allow dangerously high voltages occur between the chassis of the drive and the internal power-structure components.

**Figure 12 - High-impedance Ground**



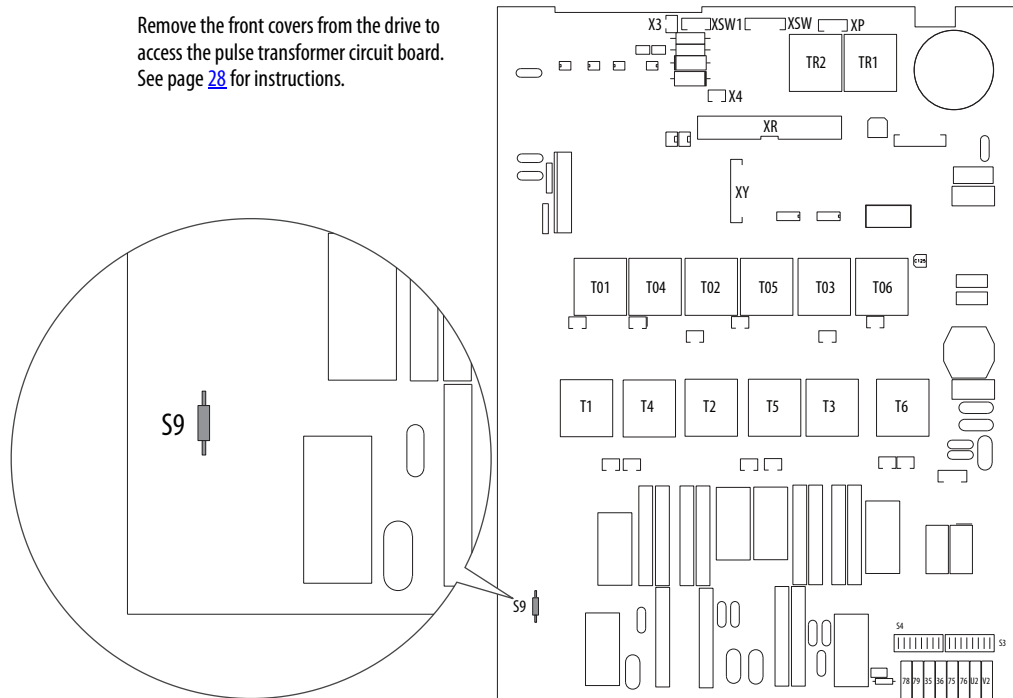
Grounding the Wye secondary neutral through a resistor is an acceptable method of grounding. In this case, in a short-circuited secondary condition, none of the output phases to ground will exceed the normal line to line voltage. The resistor is often used to detect ground current by monitoring the associated voltage drop.

**Table 8 - Drive Modifications to Support Ungrounded Wye Neutral or Impedance Grounded Connections**

Frame	Circuit Board	Jumper/Connection	Figure to see for Details
A	Pulse transformer (FIR1-xx-xx)	Remove jumper S9	<a href="#">Figure 13</a> on page 36
B	Pulse transformer (FIR2-xx-xx)	Remove jumper S9	<a href="#">Figure 14</a> on page 37
C	Pulse transformer (FIR3-xx-xx)	Remove jumper S9	<a href="#">Figure 15</a> on page 37
	Transient noise filter (FIL-31), 200V...500V AC drives	Disconnect the filter board yellow/green (ground) wire from the PE connection on the drive chassis	<a href="#">Figure 16</a> on page 38
	Transient noise filter (FIL-57, FIL-69), 575V...690V AC drives	Remove jumper S1	<a href="#">Figure 17</a> on page 38
D	Pulse transformer (FIR-D-xx-xx)	Remove capacitors C121 and C122	<a href="#">Figure 18</a> on page 39
	Overvoltage clipping (CFSF-xxx)	Remove jumper S1	<a href="#">Figure 19</a> on page 39

**Figure 13 - Frame A Pulse Transformer Circuit Board S9 Jumper Location**

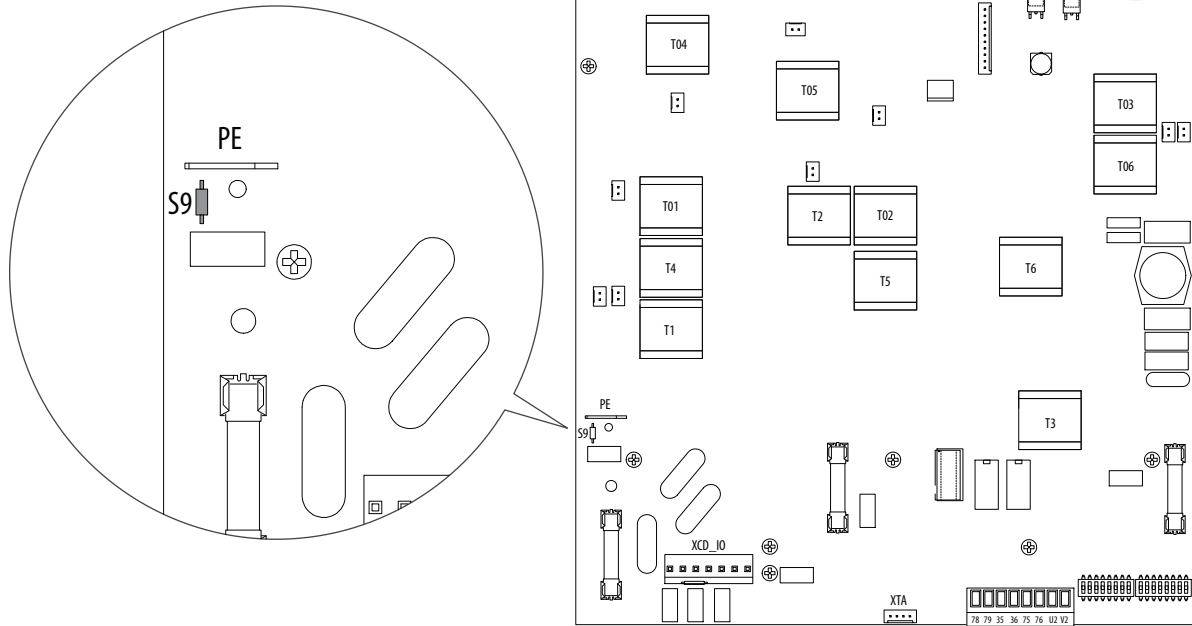
Remove the front covers from the drive to access the pulse transformer circuit board. See page 28 for instructions.





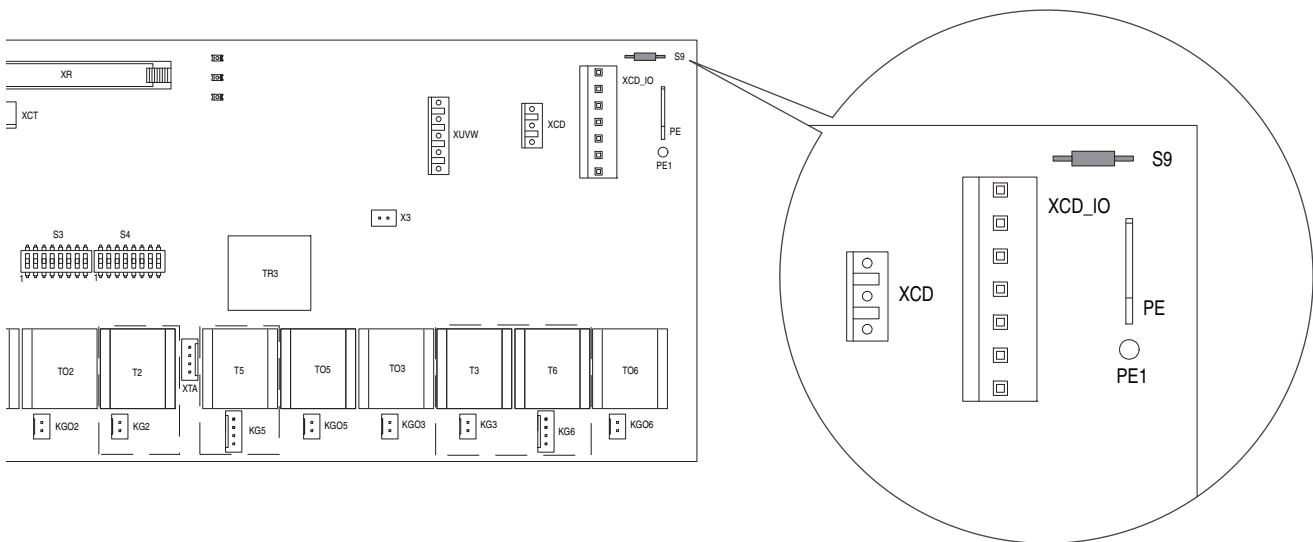
**Figure 14 - Frame B Pulse Transformer Circuit Board S9 Jumper Location**

Remove the front covers from the drive to access the pulse transformer circuit board. See page 29 for instructions.



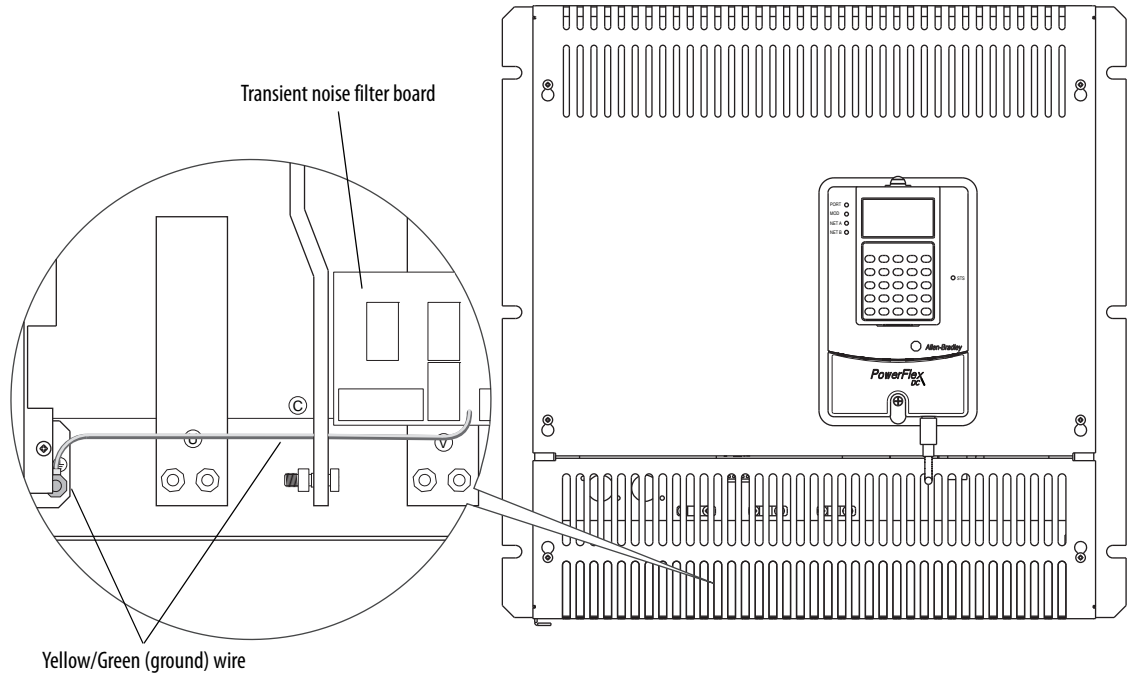
**Figure 15 - Frame C Pulse Transformer Circuit Board S9 Jumper Location**

The pulse transformer circuit board is behind the control EMI shield, near the top of the drive. See page 29 for instructions on removing the front covers from the drive and page 70 for instructions on moving the control EMI shield.



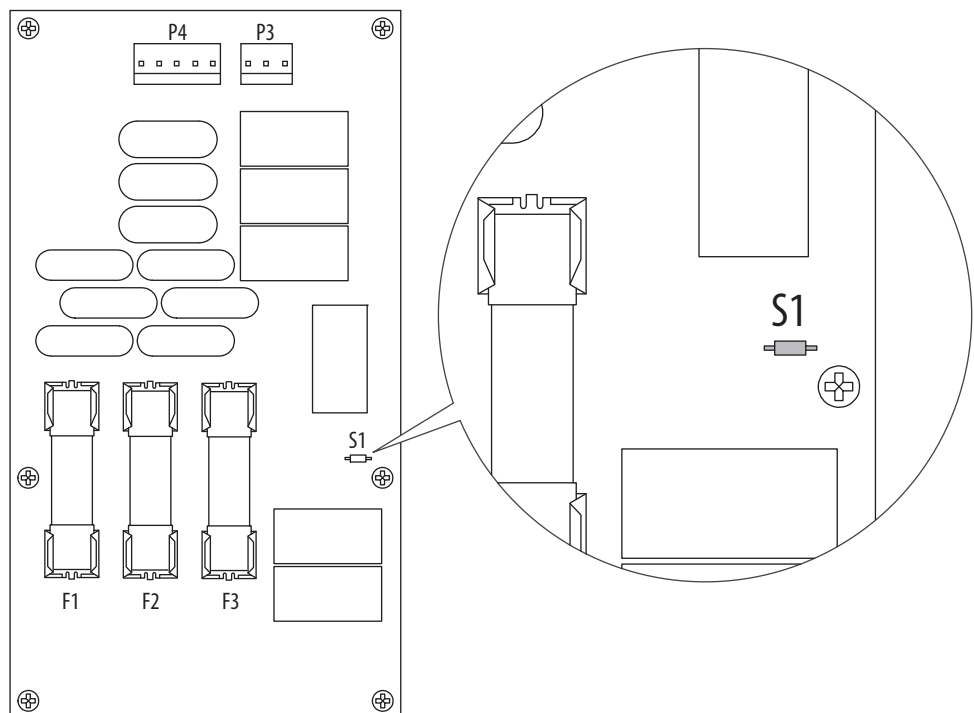
**Figure 16 - Frame C Transient Noise Filter Circuit Board (FIL-31), 200V...500V AC Input Drives, Ground Wire Location**

Remove the front covers from the drive to access the transient noise filter circuit board. See page 29 for instructions. The transient noise filter board is between terminals C and D below the control EMI shield.



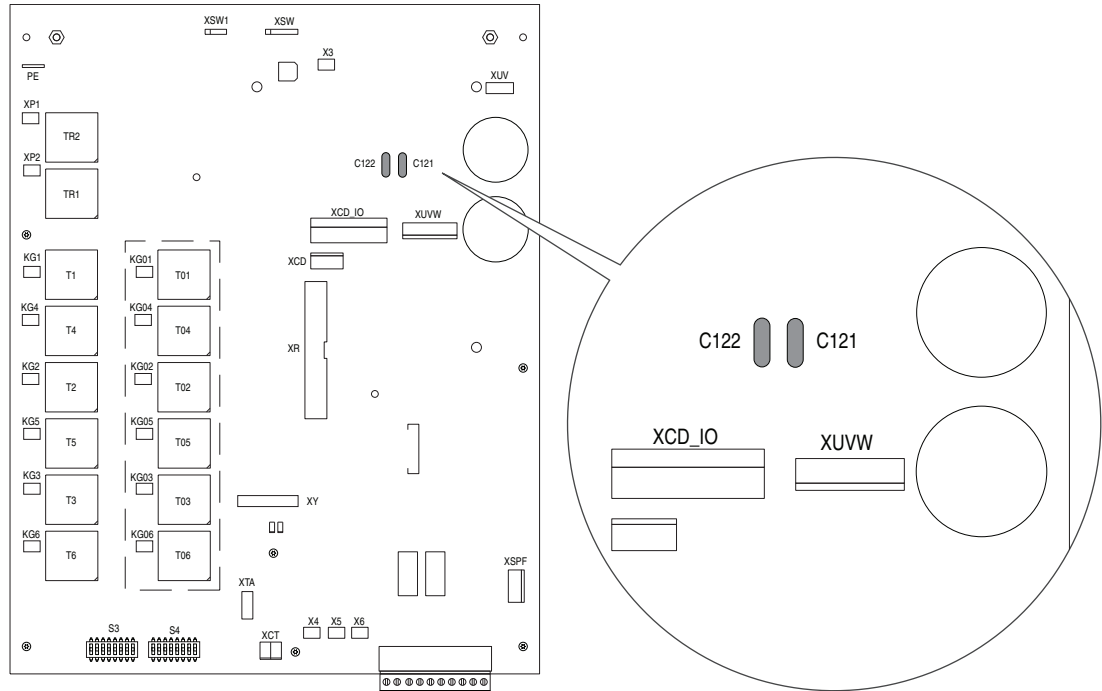
**Figure 17 - Frame C Transient Noise Filter Circuit Board (FIL-57, FIL-69), 575V...690V AC Input Drives, S1 Jumper Location**

Remove the front covers from the drive to access the transient noise filter circuit board. See page 29 for instructions. The transient noise filter board is on the left side of the control EMI shield.



**Figure 18 - Frame D Pulse Transformer Circuit Board S1 Jumper Location**

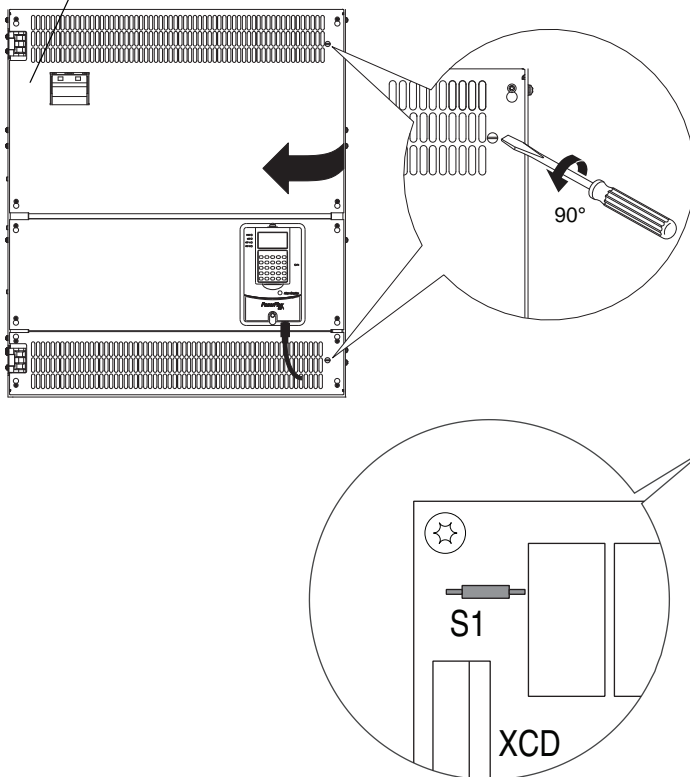
The pulse transformer circuit board is behind the top and bottom control-panel covers. See page 30 for instructions on removing the covers from the drive.



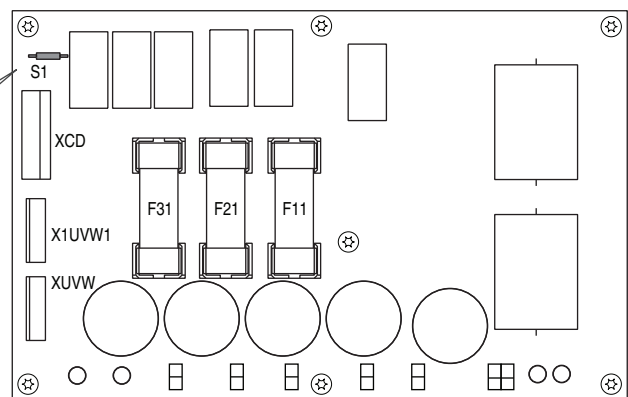
**Figure 19 - Frame D Overvoltage Clipping Circuit Board S1 Jumper Location**

The overvoltage clipping circuit board is behind the control panel on the upper left side of the drive chassis. Instructions on opening the control panel are shown in the illustration on the left.

Overvoltage clipping board location inside drive



1. Disconnect the DPI cable from the HIM (if present).
2. Insert a flathead screwdriver into the holes in the right side of the protective covers on the drive and turn the latch 90° counter-clockwise.
3. Open the control panel to the left.



## CE Conformity

Compliance with the Low Voltage Directive and Electromagnetic Compatibility Directive has been demonstrated by using harmonized European Norm (EN) standards. References to European Norm standards are published in the Official Journal of the European Communities. PowerFlex DC drives comply with the EN standards listed here when installed according to this User Manual.

EU Declarations of Conformity are available online at:  
[www.rockwellautomation.com/products/certification/ce/](http://www.rockwellautomation.com/products/certification/ce/)

## Low Voltage Directive

- EN 50178 Electronic equipment for use in power installations.

## EMC Directive

- EN 61800-3 Adjustable speed electrical power drive systems Part 3: EMC product standard including specific test methods.

## General Considerations

- For CE compliance, the drive installation must satisfy requirements that are related to both EN 50178 and EN 61800-3 provided in this document.
- PowerFlex DC drives comply with the EMC requirements of EN 61800-3 when installed according to good EMC practices and the instructions that are provided in this document. However, many factors can influence the EMC compliance of an entire machine or installation, and compliance of the drive itself does not ensure compliance of all applications.
- PowerFlex DC drives are not intended to be used on public low-voltage networks that supply domestic premises. Without additional mitigation, radio frequency interference is expected if used on such a network. The installer is responsible to take measures such as supplementary line filters and enclosures to prevent interference and follow all installation requirements of this document.
- PowerFlex DC drives generate notching and harmonic current emissions on the AC supply system. When operated on a public low-voltage network, it is the responsibility of the installer or user to be sure that applicable requirements of the distribution network operator have been met.



**ATTENTION:** PowerFlex DC drives can produce DC current in the protective earthing conductor. This DC current can reduce the ability of residual current-operated protective devices (RCD) or residual current-operated monitoring devices (RCM), of type A or AC, to provide protection for other equipment in the installation.

---

### Installation Requirements Related to the Low Voltage Directive

- PowerFlex DC drives are designed to be CE-compliant only if they are NOT connected to “corner-earthed” supply systems where one of the three phases of the supply system has been earthed.
- PowerFlex DC drives are compliant with the CE LV Directive when used at altitudes no greater than 2,000 m (6,562 ft).
- PowerFlex DC drives provided in enclosure type IP20 must be installed in a pollution degree 1 or 2 environment to be compliant with the CE LV Directive. Characteristics of the different pollution degree ratings are provided on [page 42](#).
- PowerFlex DC drives can produce leakage current in the protective earthing conductor that exceeds 3.5 mA AC or 10 mA DC. The minimum size of the protective earthing (ground) conductor that is used in the application must comply with local safety regulations for high-protective earthing conductor current equipment.
- Frame D PowerFlex DC drives must be installed in a supplementary enclosure that provides protection from electric shock to be compliant with the CE LV Directive.

### Installation Requirements Related to EN 61800-3 and the EMC Directive

- The drive must be earthed (grounded) as described in this User Manual.
- PowerFlex DC drives require the use of an external EMC filter to comply with the EMC Directive and emission limits of EN 61800-3: 2004. PowerFlex DC drives have been tested and verified for compliance to the emission limits of EN 61800-3: 2004 by using only the specific input filters and motor cable lengths that are identified in [Table 9](#). See Typical Power Wiring Diagrams on [page 46](#) for more installation information.

**Table 9 - Standards and Limits for EMC Input Filters**

Drive Frame Cat. No.	Standard / Limits (Compliance with any of the limits in the Pollution Degree Ratings According to EN 61800-5-1 table on <a href="#">page 42</a> satisfies RF emission requirements for the EMC Directive)				
	EN61800-3 Category C1 EN61000-6-3 CISPR 11 Group 1 Class B	EN61800-3 Category C2 EN61000-6-4 CISPR11 Group 1 Class A...P ≤ 20kVA	CISPR11 Group 1 Class A...P > 20kVA	EN61800-3 Category C3...I ≤ 100A	EN61800-3 Category C3...I > 100A
Frame A 20Px1Ax4P1... 20Px1Ax129	Compliance may be possible with supplementary mitigation (Consult factory)	Compliance may be possible with supplementary mitigation (Consult factory)	RF line filter required <sup>(2)</sup> 50 m motor cable limit	RF line filter required <sup>(2)</sup> 50 m motor cable limit	RF line filter required <sup>(2)</sup> 50 m motor cable limit
Frame B 20Px1Ax167... 20Px1Ax412	Compliance may be possible with supplementary mitigation (Consult factory)	RF line filter required <sup>(1)</sup> 50 m motor cable limit	RF line filter required <sup>(1)</sup> 50 m motor cable limit	RF line filter required <sup>(1)</sup> 50 m motor cable limit	RF line filter required <sup>(1)</sup> 50 m motor cable limit
Frame C 20Px1Ax495... 20Px1Ax667	Compliance may be possible with supplementary mitigation (Consult factory)	Compliance may be possible with supplementary mitigation (Consult factory)	RF line filter required <sup>(1)</sup> 50 m motor cable limit	RF line filter required <sup>(1)</sup> 50 m motor cable limit	RF line filter required <sup>(1)</sup> 50 m motor cable limit
Frame D 20Px1Ax... 20Px1Ax	Compliance may be possible with supplementary mitigation (Consult factory)	Compliance may be possible with supplementary mitigation (Consult factory)	Compliance may be possible with supplementary mitigation (Consult factory)	RF line filter required <sup>(3)</sup> 50 m motor cable limit	RF line filter required <sup>(4)</sup> 50 m motor cable limit
	More Stringent Limits ←			→ Less Stringent Limits	

(1) RF 3xxx-MHU EMC filter manufactured by Rasmi Electronics Ltd. xxx designates filter current rating. See the manufacturer published literature for details.  
 (2) RF 3xxx-SIEI EMC filter manufactured by Rasmi Electronics Ltd. xxx designates filter current rating. See the manufacturer published literature for details.  
 (3) EPCOS B84143B Type S081 EMC filter manufactured by EPCOS AG. See the manufacturer published literature for details.

**IMPORTANT** Use of EMC filters not listed in [Table 9](#) on page [41](#) must be verified in the application. Additional filters are listed in Alternate EMC Filters on page [273](#).

- Output power wiring to the motor must employ one of the following solutions.
  - Cable with a braided shield providing 75% or greater coverage
  - Cables that are housed in metal conduit
  - Cables with equivalent shielding

Continuous shielding must be provided from the drive enclosure to the motor enclosure. Both ends of the motor cable shield (or conduit) must terminate with a low-impedance connection to earth.

- The motor-end cable shield or conduit must terminate in a shielded connector and be properly installed in an earthed motor wiring box that is attached to the motor. The motor wiring-box cover must be installed and earthed.
- All control (I/O) and signal wiring to the drive must use one of the following solutions.
  - Cable with a braided shield providing 75% or greater coverage
  - Cables that are housed in metal conduit
  - Cables with equivalent shielding

When shielded cable is used, terminate only the drive end of the cable shield to earth with a low-impedance connection.

- Motor cables must be separated from control and signal wiring wherever possible.
- The maximum length of the motor cable must not exceed the length that is specified in the table on page [41](#). The maximum length that is specified is required for compliance with radio-frequency emission limits for the specific standard and installation environment.

### Pollution Degree Ratings According to EN 61800-5-1

Pollution Degree	Description
1	No pollution or only dry, non-conductive pollution occurs. The pollution has no influence.
2	Normally, only non-conductive pollution occurs. Occasionally, however, a temporary conductivity due to condensation can be expected, when the drive is out of operation.
3	Conductive pollution or dry non-conductive pollution occurs, which becomes conductive due to condensation, which can be expected.
4	The pollution generates persistent conductivity that is caused, for example, by conductive dust, rain, or snow.

## Power Circuit Protection

It is recommended that you install fast-acting fuses on four-quadrant, frame A, and B drives to protect the armature converter on the input and output sides. Internally mounted fuses for armature converter protection are provided with frame C and D PowerFlex DC drives. See Drive Power Circuit Protection on page [243](#) for a list of replacement fuses and general fuse locations.

## Control Power Circuit Protection

The 115V / 230V AC control circuit power input terminals U2 and V2 are required to be short-circuit protected. This protection can be provided by using standard time-delay fuses or a circuit breaker (device). Either protective device must survive the short-circuit available current of the feeder source for this circuit and the inrush current of the drive power supply.

Size the device(s) to protect the wiring between the fuses or circuit breaker connections to terminals U2 and V2, and not nuisance trip or blow from the inrush current.

[Table 10](#) lists the input current characteristics of the control power.

**Table 10 - Control Power Protection**

Frame	Control Power Supply					
	Circuit Board ID / Revision	Power	Rated input current		Inrush input current	
			115V AC	230V AC	115V AC	230V AC
A & D	SW1-31 / H and below	60 W	1 A	0.5 A	20 A	10 A
	SW1-31 / I and above	80 W	1 A	0.5 A	6 A	10 A
B	SW2-32 / H and below	110 W	1.2 A	0.7 A	15 A	7.5 A
	SW2-32 / I and above	90 W	1.2 A	0.6 A	6 A	10 A
C	SW3-32 / H and below	110 W	1.2 A	0.7 A	15 A	7.5 A
	SW3-32 / I and above	90 W	1.2 A	0.6 A	6 A	10 A

Provide a power source for the control power input that is stabilized and buffered from the power system transients. The control power of many drives can be fed from one source, as long as proper distribution protection is provided.

## Cable and Wiring Recommendations

Use the following cable and space recommendations for all drives sizes:

Category	Wiring Class	Signal Definition	Signal Example	Cable Type	Minimum Spacing Between Classes - Steel Conduit/Tray					See Cable Spacing Notes, on page 45
					1	2/3/4	5/6	7/8	9/10/11	
Power	1	AC Power (600V Or Greater)	2.3kV 3/ph AC Lines	Per NEC and Local Codes	0	3/9 in. (76/229 mm)	3/9 in. (76/229 mm)	3/18 in. (76/457 mm)	See Note 6	1/2/5
	2	AC Power (Less Than 600V)	460V 3/ph AC Lines		3/9 in. (76/229 mm)	0	3/6 in. (76/152 mm)	3/12 in. (76/305 mm)	See Note 6	1/2/5
	3	DC Power	DC Motor Armature							
	4	DC Power	DC Motor Field							
Control	5	115V AC/DC Logic	Relay Logic/PLC I/O Motor Thermostat		3/9 in. (76/229 mm)	3/6 in. (76/152 mm)	0	3/9 in. (76/229 mm)	See Note 6	1/2/5
		115V AC Power	Power Supplies, Instruments							
	6	24V AC/DC Logic	PLC I/O							
Signal (Process)	7	Analog Signals, DC Supplies	Reference/Feedback Signal, 5 To 24V DC	Shielded Cable – Belden 8735, 8737, 8404	3/18 in. (76/457 mm)	3/12 in. (76/305 mm)	3/9 in. (76/229 mm)	0	1/3 in. (25/76 mm)	2/3/4/5
		Digital (Low Speed)	TTL							
	8	Digital (High Speed)	I/O, Encoder, Resolver, Count Pulse Tach	Shielded Cable – Belden 9728, 9730						
Signal (Comm.)	9	Serial Communication	RS-232 (20-COMM-R), 422 To Terminals/ printers	Shielded Cable – Belden RS-232 – 8735, 8737 RS-422 – 9729, 9730	See Note 6			1/3 in. (25/76 mm)	0	–
	11	Serial Communication (Greater Than 20k Baud)	PLC Remote I/O, PLC Data Highway	Twinaxial Cable – Belden 9463, A-B 1770-CD						

*Example:*

Space relationship between 480V AC incoming power leads and 24V DC logic leads:

- 480V AC leads are Class 2; 24V DC leads are Class 6
- For separate steel conduits, the conduits must be 3 inches (76 mm) apart
- In a cable tray, the two groups of leads are to be 6 inches (152 mm) apart

Category	Wiring Class	Signal Definition	Signal Example	Minimum Spacing Between Classes Steel Conduit/Tray		
				1	2/3/4	5/6
Power	2	AC Power (less than 600V)	460V 3/Ph AC Lines		→	3/6 in. (76/152 mm)
Control	6	24V AC/DC Logic	PLC I/O	←	→	3/6 in. (76/152 mm)



**Cable Spacing Notes:**

1. Both outgoing and return current-carrying conductors must be routed in the same conduit or laid next to each other in a cable tray.
2. Cables of the following classes can be grouped.
  - a. Class 1; Equal to or above 601V.
  - b. Classes 2, 3 and 4 can have their respective circuits that are routed in the same conduit or layered in the same tray.
  - c. Classes 5 and 6 can have their respective circuits that are routed in the same conduit or layered in the same tray. The bundle cannot exceed the conditions of NEC 310.
  - d. Classes 7 and 8 can have their respective circuits that are routed in the same conduit or layered in the same tray. Encoder cables that are run in a bundle can experience some amount of EMI coupling. The circuit application can dictate separate space requirements.
  - e. Classes 9, 10 and 11 can have their respective circuits that are routed in the same conduit or layered in the same tray. Communication cables that are run in a bundle can experience some amount of EMI coupling and associated communication faults. The application can dictate separate space requirements.
3. All wires of class 7...11 **MUST** be shielded per the recommendations.
4. In cable trays, steel separators are advisable between the class groupings.
5. If conduit is used, it must be continuous and composed of magnetic steel.
6. Space requirements for communication cables, classes 2...6 are listed in this table:

<b>Conduit Spacing:</b>	<b>Through Air:</b>
115V – 25 mm (1 in.)	115V – 51 mm (2 in.)
230V – 38 mm (1.5 in.)	230V – 01.5 mm (4 in.)
380/575V – 76 mm (3 in.)	380/575V – 203 mm (8 in.)
575V – proportional to 152 mm (6 in.) per 1000V.	575V – proportional to 305 mm (12 in.) per 1000V.

**Power Wiring****AC Input Voltages**

PowerFlex DC drives are rated for the following AC input voltages @ 50/60 Hz  $\pm 5\%$ :

*Mains Circuit (Terminals U, V, W)*

- 230V  $\pm 10\%$ , 3Ph
- 400V  $\pm 10\%$ , 3Ph
- 440V  $\pm 10\%$ , 3Ph
- 460V  $\pm 10\%$ , 3Ph
- 480V  $\pm 10\%$ , 3Ph
- 575V  $\pm 10\%$ , 3Ph
- 690V  $\pm 10\%$ , 3Ph

*Field Circuit (Terminals U1, V1)*

- 230V  $\pm 10\%$ , 1Ph
- 400V  $\pm 10\%$ , 1Ph
- 460V  $\pm 10\%$ , 1Ph

*Control Circuit (Terminals U2, V2)*

- 115V ±15% or 230V ±15%, 1Ph

---

**IMPORTANT** For frame B and C drives only, a jumper must be placed between terminals SA-SB on the switching power supply circuit board for the control circuits to work with 115V AC input. See [Figure 47](#) on page 70 for terminal block location on frame B drives and [Figure 48](#) on page 70 for terminal block location on frame C drives.

---

## DC Output Voltages

The output voltages shown here include an AC input undervoltage within the stated tolerance limits and a voltage drop of 4% due to an AC input line reactor. It is the same as the rated armature voltage suggested for the connected motor.

*Armature Circuit*

AC Input Voltage (Terminals U, V, W)	DC Output Armature Voltage (Terminals C & D)	
	Two Quadrant Drive	Four Quadrant Drive
230V ±10%, 3Ph	260V	240V
400V ±10%, 3Ph	470V	420V
440V ±10%, 3Ph	530V	460V
460V ±10%, 3Ph	560V	480V
480V ±10%, 3Ph	580V	500V
575V ±10%, 3Ph	680V	600V
690V ±10%, 3Ph	810V	720V

*Field Circuit*

AC Input Voltage (Terminals U1 & V1)	DC Output Field Voltage <sup>(1)</sup> (Terminals C1 & D1)	
	Fixed Field	Adjustable Field
230V ±10%, 1Ph	200V	200V
400V ±10%, 1Ph	310V	310V
460V ±10%, 1Ph	360V	360V

(1) The max field voltage is equal to 0.85 x AC input line voltage

## Typical Power Wiring Diagrams

[Figure 20](#) on page 47...[Figure 22](#) on page 49 represent recommended power wiring configurations for standard PowerFlex DC drive installations. For SAR installations, see [Appendix H](#) on page 397.

Figure 20 - Power Wiring with AC Input Contactor

See Power Wiring Diagrams Notes on page 50 for footnotes.

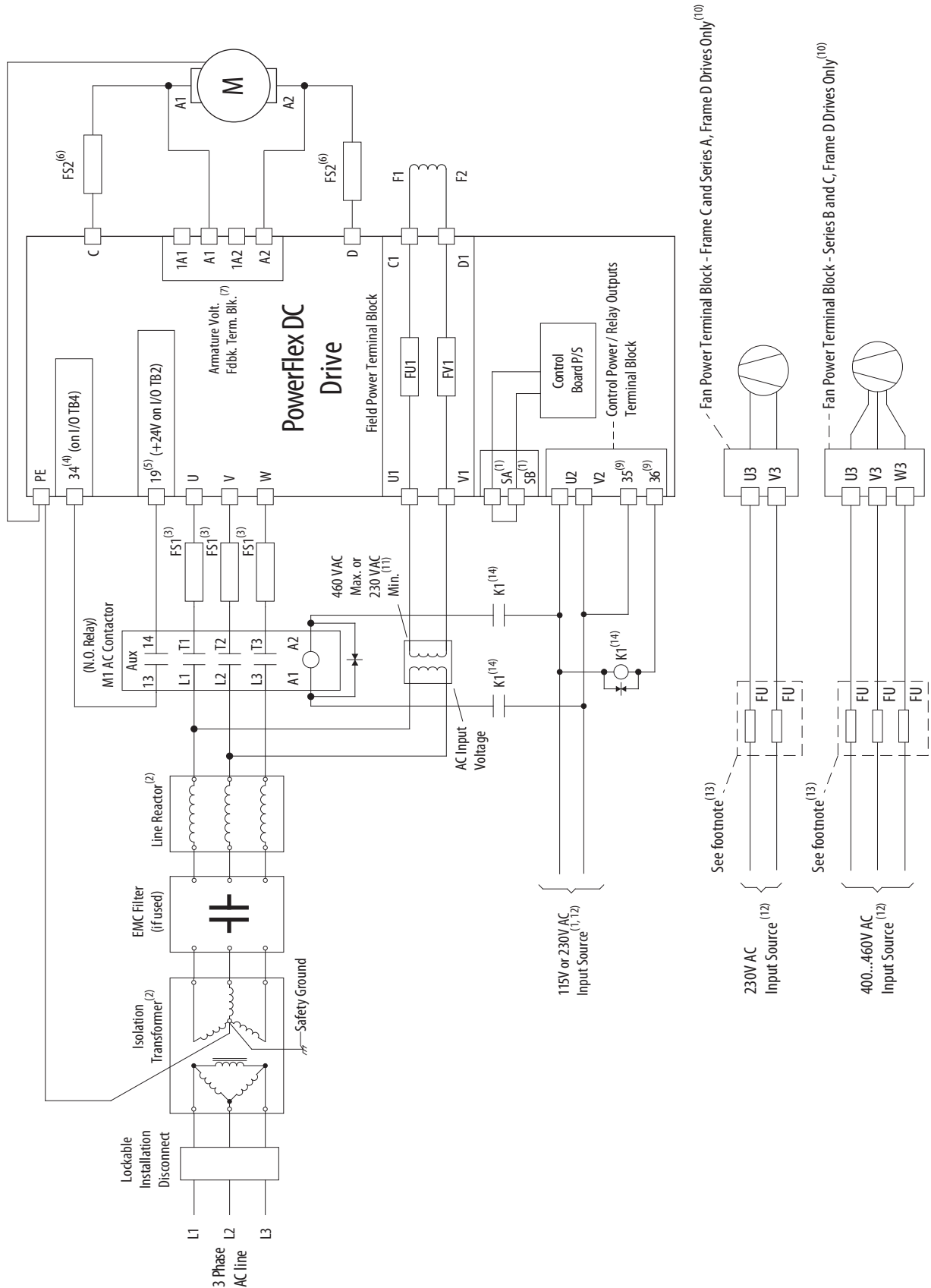


Figure 21 - Power Wiring with DC Output Contactor

See Power Wiring Diagrams Notes on page 50 for footnotes.

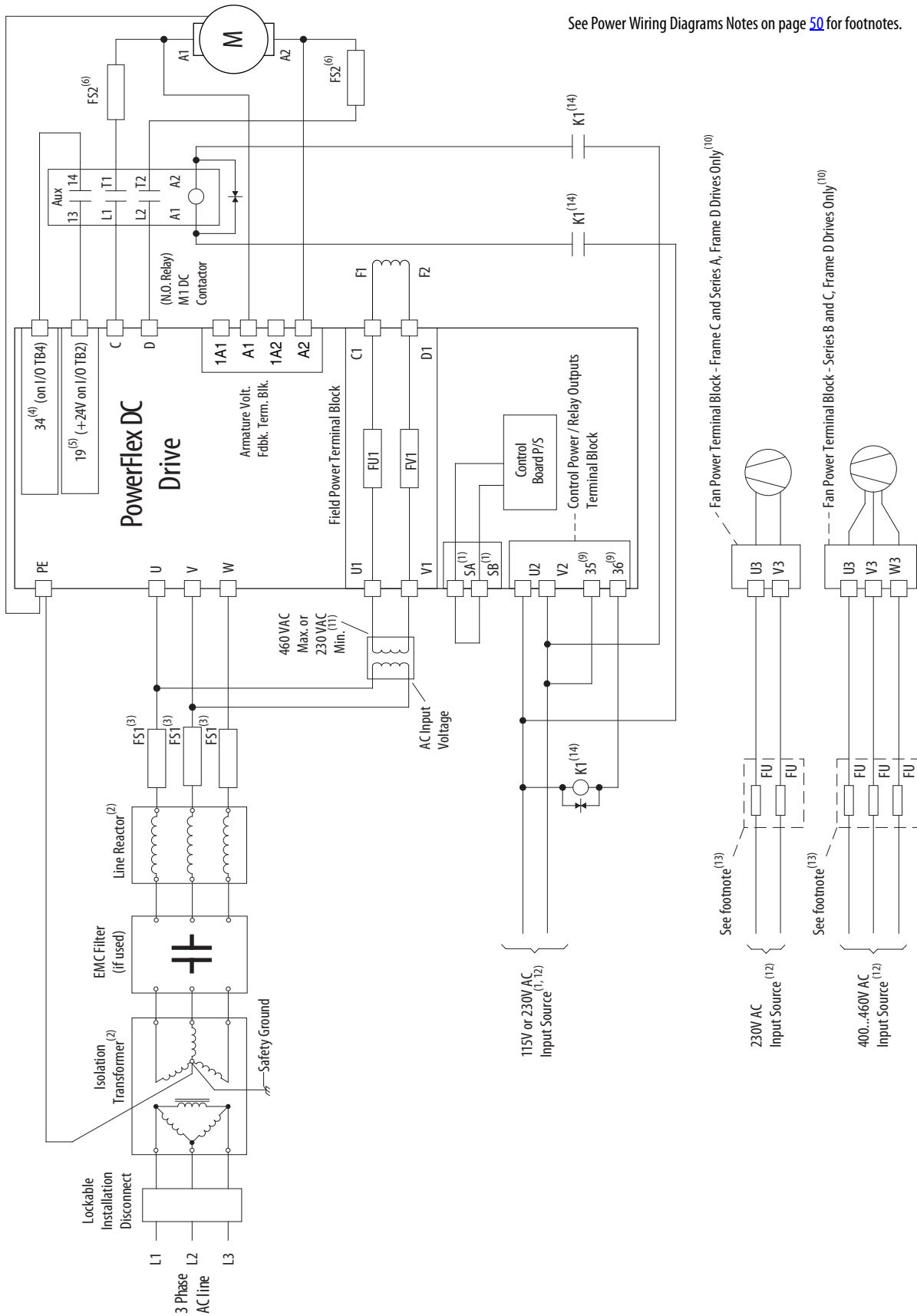
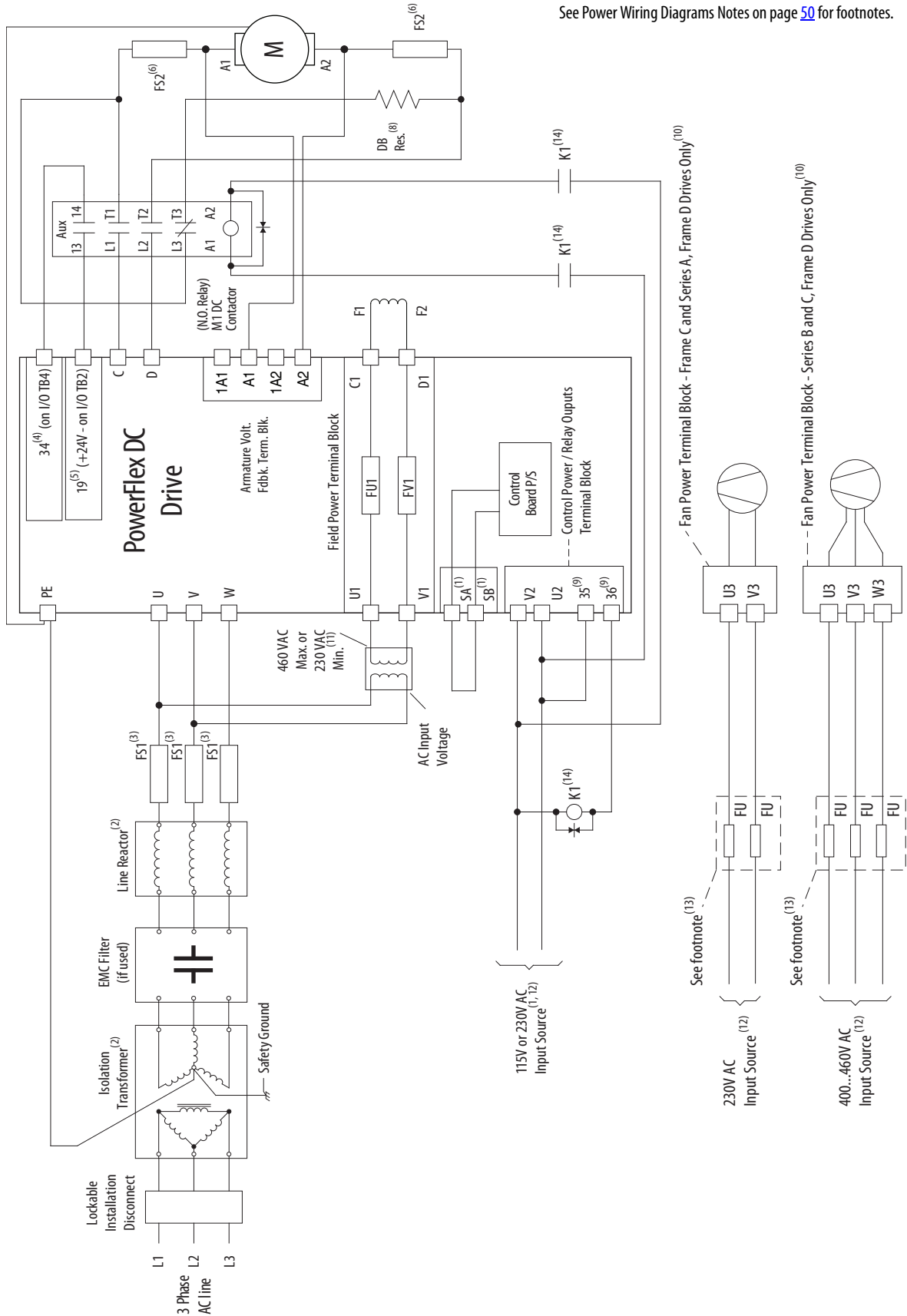


Figure 22 - Power Wiring with DC Output/Dynamic Braking Contactor and a Dynamic Brake

See Power Wiring Diagrams Notes on page 50 for footnotes.



*Power Wiring Diagrams Notes*

1. For frame B and C drives only, a jumper is required between terminals SA and SB for 115V AC control input power. See Control Circuit Input Power on page Control Circuit Input Power for more information.
2. An Isolation Transformer and/or 3...5% impedance Line Reactor is required. If the Isolation Transformer provides the required 3...5% impedance, a Line Reactor is not required. See AC Input Line Reactors and AC Input Contactors on page [264](#) and Isolation Transformers on page [267](#) for recommendations. It is recommended that the isolation transformer has a grounded Wye secondary neutral. If the PowerFlex DC drive is installed in a system with an ungrounded Wye neutral or with an impedance ground connection, see Grounding for Installations in an Ungrounded or High-Impedance, Neutral Ground, or System on page [35](#) for more information.
3. AC input fuses for the armature converter are not provided with frame A and B drives, but are provided and internally mounted in frame C and D drives. See Drive Power Circuit Protection on page [243](#) for fuse recommendations.
4. Par 140 [Digital In8 Sel] set to 31 “Contactor.”
5. If the +24V internal power supply is used, a jumper wire must be installed between terminals 18 (24V common) and 35 (digital input common).
6. Customer supplied armature output fuses are required on four quadrant and are recommended on two quadrant Frame A and B drives. See Drive Power Circuit Protection on page [243](#) for fuse recommendations.
7. Optional armature voltage feedback sensing not required with AC contactor.
8. The “Enable” input must be removed to perform a dynamic braking stop.
9. Par 1391 [ContactorControl] = 1 “AC Cntcr” and Par 1392 [Relay Out 1 Sel] = 25 “Contactor”. Important: Terminal 35 and 36 are on the Control Power / Relay Outputs Terminal block, NOT the I/O terminal blocks. See [Figure 37](#) on page [65](#)...[Figure 41](#) on page [67](#).
10. Only frame C and D drives require an external power supply for the heatsink cooling fan(s). See Frame C Heatsink Cooling Fan Specifications on page [71](#) and Frame D, Series B and C Heatsink Cooling Fan Specifications on page [73](#) for more information.
11. See Field Converter Connections on page [57](#).
12. If sourced from the main 3-phase AC input, the connections must be taken from the primary side of the isolation transformer or line reactor (clean power).
13. Fuses or a circuit breaker. See Frame C Heatsink Cooling Fan Specifications on page [71](#) and Frame D, Series B and C Heatsink Cooling Fan Specifications on page [73](#) for detailed information.
14. For frames B, C, and D drives, a pilot relay is required for the contactor coil.

## Armature Converter Connections

Terminals	Description
U, V, W	Three-phase AC input to the armature converter
C, D	DC output to the motor armature
PE	Safety ground

**Table 11 - Armature and Safety Ground (PE) Terminal Specifications**

Frame	Drive Current Rating Code <sup>(1)</sup>				Terminals	Wire Size and Type	Terminal Bolt Size (mm)	Recommended Torque N•m (lb•in)
	230V	460V	575	690				
A	7P0...055	4P1...052	–	–	U, V, W, C, D, PE	See Cable and Wiring Recommendations on page 44	5	6 (53)
	073...110	073...129	–	–			Terminal Block	12 (106)
B	All	All	All	–	U, V, W, C, D		10	25 (221)
					PE		8	15 (132.75)
C	All	All	All	All	U, V, W, C, D		10	25 (221)
					PE		8	15 (132.75)
D	All	All	All	All	U, V, W, C, D, PE		12	45 (398.2)

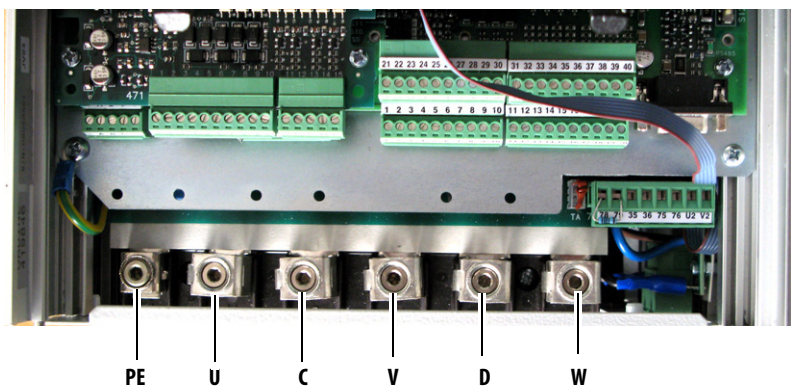
(1) See Standard Drive Catalog Number Explanation on page 13, positions 8, 9 and 10 for the applicable drive HP rating, armature amp rating, and field amp rating.

**IMPORTANT** To meet UL installation requirements, certain frame D drives require the use of a terminal adapter kit for terminals U, V, W, and C and D. See Terminal Adapter Kits for Frame D Drives on page 279 for details.

**Figure 23 - Frame A Armature Converter Terminal Locations**

**Front View**

Front view of drive that is shown with bottom protective and power terminal covers removed. See Remove the Drive Covers on page 28 for information on removing the drive covers.



**ATTENTION:** Do not operate the drive with the power terminal cover removed. Drive operation with the power terminal covers removed may result in a hazardous condition that could cause personal injury and/or equipment damage.

Figure 24 - Frame B Armature Converter Terminal Locations

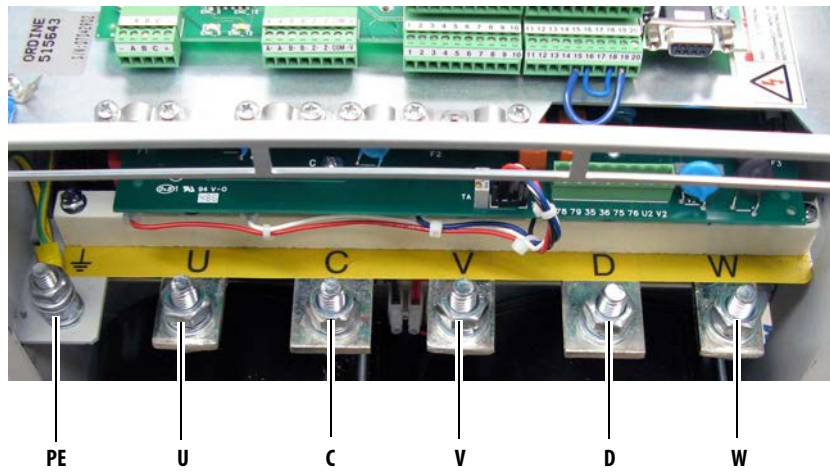


Figure 25 - Frame C Armature Converter Terminal Locations

Front View

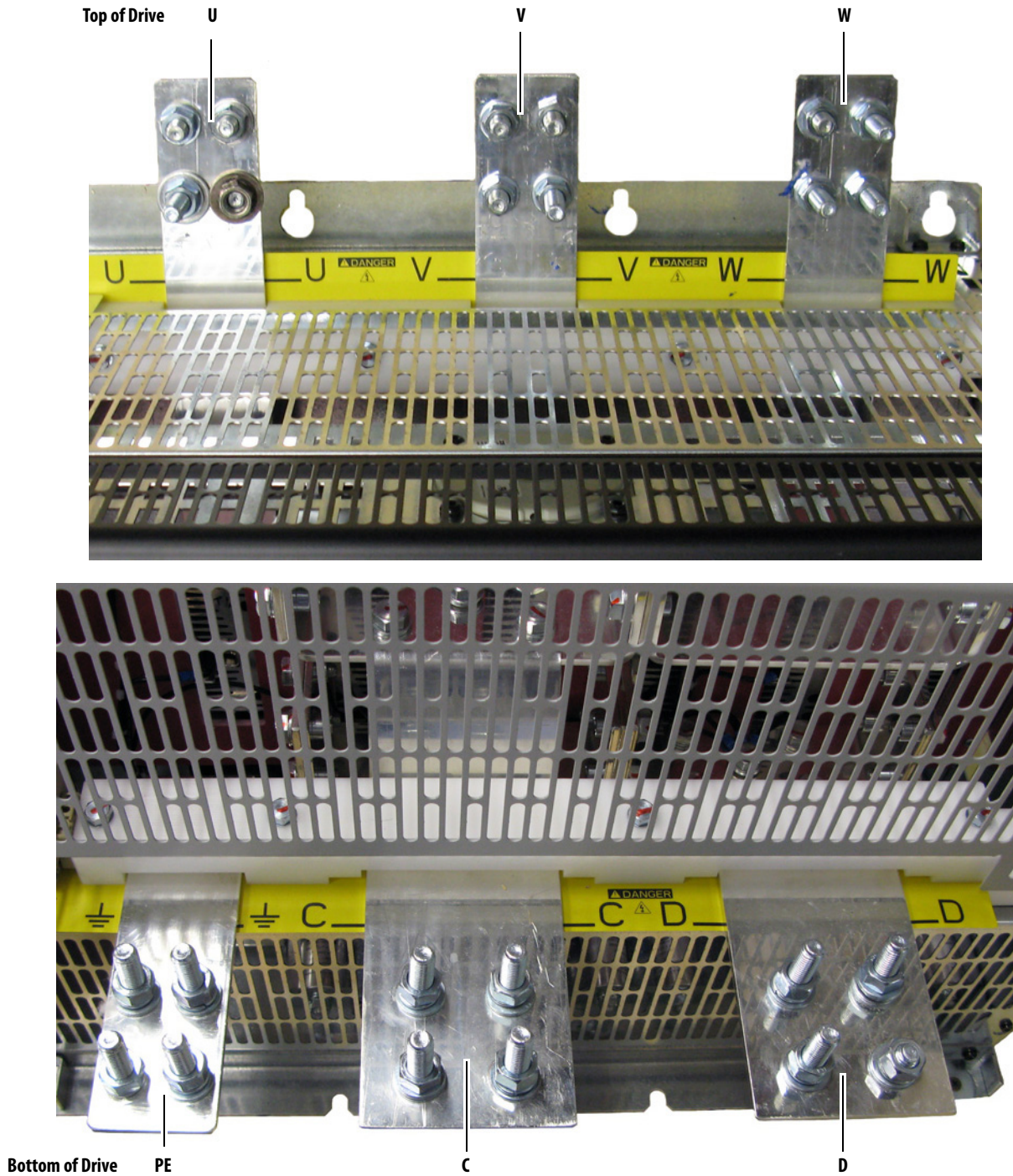


Bottom View



Figure 26 - Frame D Armature Converter Terminal Locations

**IMPORTANT** To meet UL installation requirements, certain frame D drives require the use of a terminal adapter kit(s) for terminals U, V, W, C, and D. See Terminal Adapter Kits for Frame D Drives on page 279 for details.



## Armature Voltage Feedback Connections

The armature voltage feedback terminals can be used to monitor the armature voltage at the motor, regardless of the state of a DC output contactor or inverting fault device that is used with the drive. When this terminal block is not connected to the motor armature terminals, jumper wires must be installed at the terminals described in [Table 12](#). When jumpers are installed in the armature voltage feedback terminals, the armature voltage feedback is only monitored internally in the drive. In this case, when a DC contactor is used without a speed feedback device, the drive cannot calculate motor speed from the armature voltage feedback signal.

---

**IMPORTANT** By default, jumpers are installed between these terminals - 1A1 to A1 and 1A2 to A2. If these terminals are not wired to the motor terminals, the jumpers must be installed.

---

This terminal block is not present on drives that are shipped from the factory with firmware revision 2.006 or earlier installed. However, new pulse transformer circuit boards that are shipped as replacement parts from the factory contain this terminal block and can be used with any firmware revision.

**Table 12 - Armature Voltage Feedback Terminal Jumper Positions**

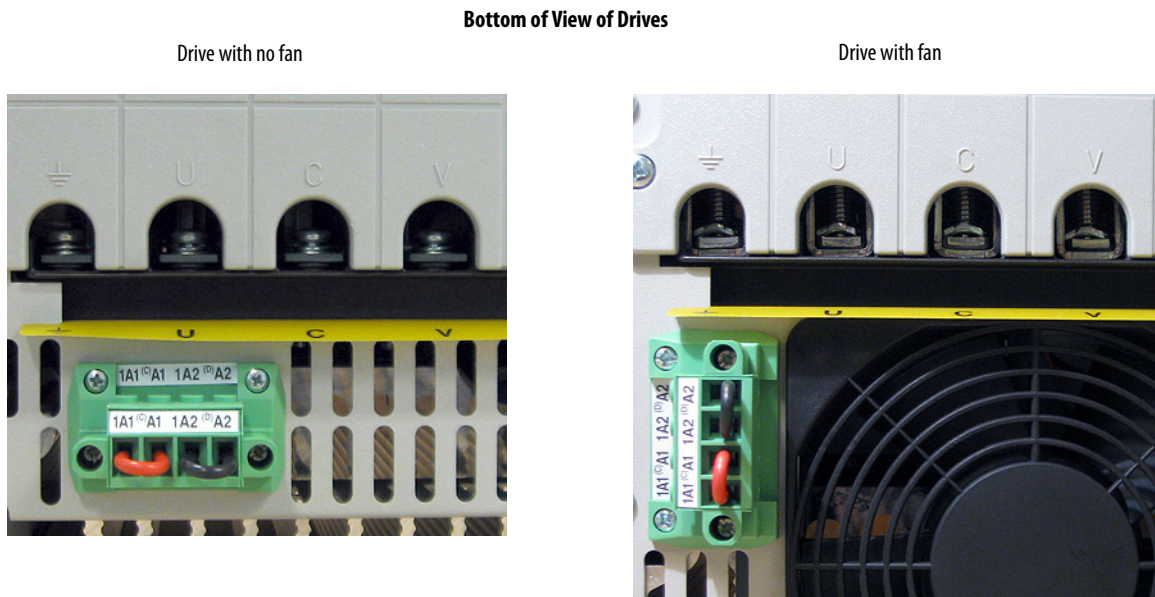
Terminals	Description
1A1	Connected to A1 with a jumper wire when internal armature voltage feedback is used. Not used when A1 is connected to motor terminal A1.
A1	Voltage feedback from motor terminal A1.
1A2	Connected to A2 with a jumper wire when internal armature voltage feedback is used. Not used when A2 is connected to motor terminal A2.
A2	Voltage feedback from motor terminal A2.

**Table 13 - Armature Voltage Feedback Circuit Wire Sizes and Terminal Specifications**

Frame	Terminals	Wire Size and Type <sup>(1)</sup>	Recommended Torque N•m (lb•in)
A, B & C	1A1, A1, 1A2, A2	24...10 AWG/kcmils	0.5...0.6 (4.4...5.3)
D		22...8 AWG/kcmils	0.8...1.6 (7.1...14.2)

(1) Wire with an insulation rating of 600V or greater is recommended. See Cable and Wiring Recommendations on page 44 for cable space requirements.

**Figure 27 - Frame A Armature Voltage Feedback Circuit Terminal Block Location**



Shown with terminals jumpered for internal armature voltage feedback.

**Figure 28 - Frame B Armature Voltage Feedback Circuit Terminal Block Location**

**Top of Drive**  
 Shown with terminals jumpered for internal armature voltage feedback.





Figure 29 - Frame C Armature Voltage Feedback Circuit Terminal Block Location

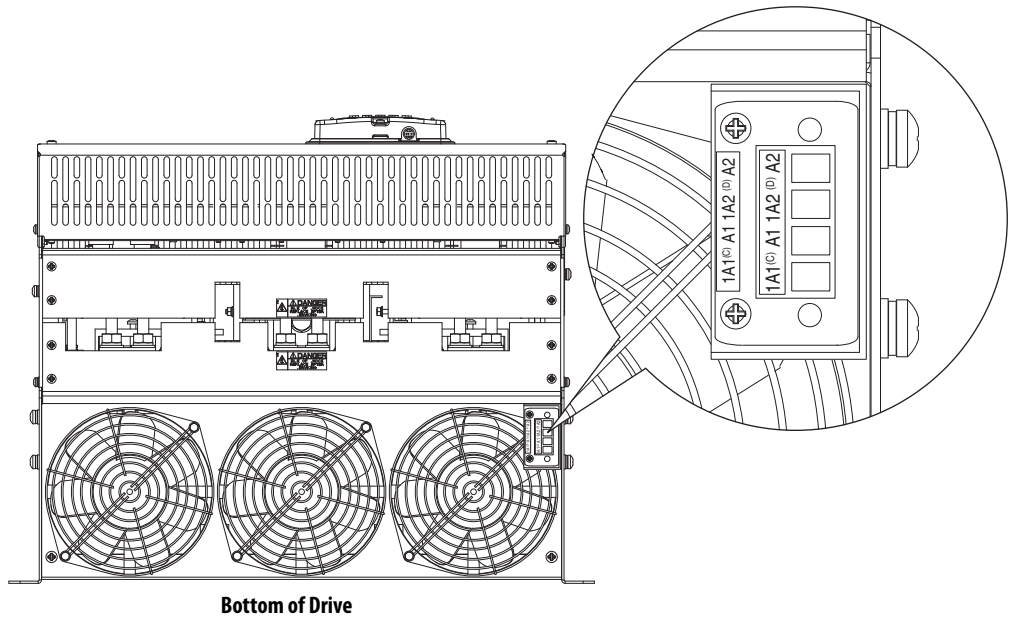
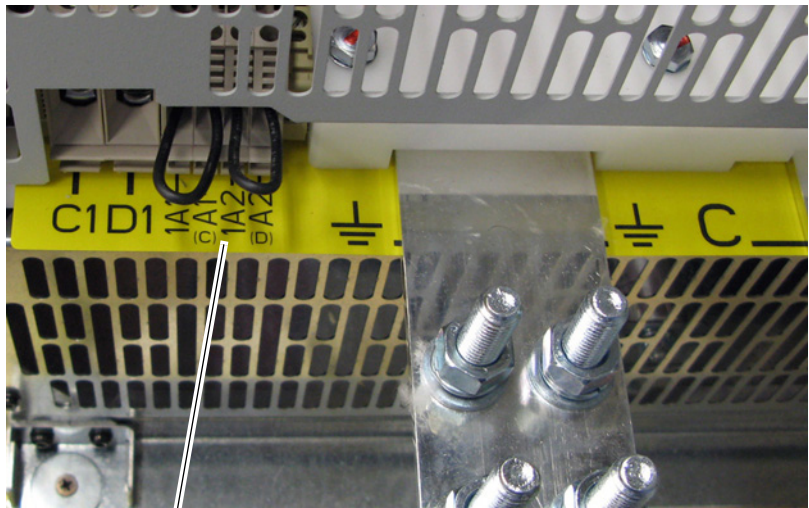


Figure 30 - Frame D Armature Voltage Feedback Circuit Terminal Block Location



Shown with terminals jumpered for internal armature voltage feedback.

Bottom of Drive, Left Side

## Field Converter Connections

**IMPORTANT** This section applies only when the drive internal, single-phase field controller will be used. Continue to the Field Current Configuration section on page 61 if an external field controller or permanent magnet motor is used.

For 575V and 690V AC input drives only, a step-down transformer must be installed ahead of the input to the field control circuit (terminals U1, V1). The step-down transformer must meet one of the secondary to motor field voltage characteristics listed here.

- 230VAC secondary for a 150V motor field
- 460VAC secondary for a 300V motor field

Also, If the rated voltage of the DC motor field is not compatible with the field DC output voltage of the drive, an external field-control transformer must be used. See the following example for transformer selection information.

Example: 10 Hp, 240V Armature, 17.2 A, 240V Field, 2.0 A motor

1. The field control transformer must have a 230V primary, a 460V secondary, and be single-phase, 60 Hz
2.  $kVA = 2 \text{ A} \times 460\text{VAC} \times 1.5 = 1.38 \text{ kVA}$  (1.5 kVA is closest)
3. The following configuration must be completed in the PowerFlex DC drive:
  - Control board DIP switch S14 must be set to select a value of 2 A.
  - Parameter 374 [Drv Fld Brdg Cur] must be programmed to match DIP switch S14 = “2.”
  - Parameter 280 [Nom Mtr Fld Amps] must be programmed to the rated motor nameplate field current = “2.”

### Field Converter Terminal Designations

Terminals	Description
U1, V1	Single phase AC input to the field circuit
C1, D1	DC output to the motor field

**Table 14 - Frames A...C Field Circuit Wire Sizes and Terminal Specifications**

Terminals	Wire Size and Type <sup>(1)</sup>	Recommended Torque N•m (lb•in)
U1, V1, C1, D1	24...10 AWG/kcmils	0.5...0.8 (4.4...7.1)

(1) See Cable and Wiring Recommendations on page 44 for more information.

**Table 15 - Frame D Field Circuit Wire Sizes and Terminal Specifications**

Drive Current Rating Code <sup>(1)</sup>				Terminals	Wire Size <sup>(2)</sup>	Recommended Torque N•m (lb•in)
230V	460V	575V	690V			
875	830	810	678	U1, V1, C1, D1	6 AWG	4.0 (35.4)
1K0	996	1K0	791			
–	–	1K2	904			
–	–	1K3	1K0			
–	–	1K6	–			
–	1K1	–	1K1		2 AWG	
–	1K3	–	1K2			
–	1K4	–	1K4			
–	–	–	1K5			
–	–	–	–			

- (1) See Standard Drive Catalog Number Explanation on page 13, positions 8, 9 and 10 for the applicable drive HP rating, armature amp rating, and field amp rating.
- (2) See Cable and Wiring Recommendations on page 44 for more information on wire types.

**Figure 31 - Frame A Field Circuit Terminal Block Location**

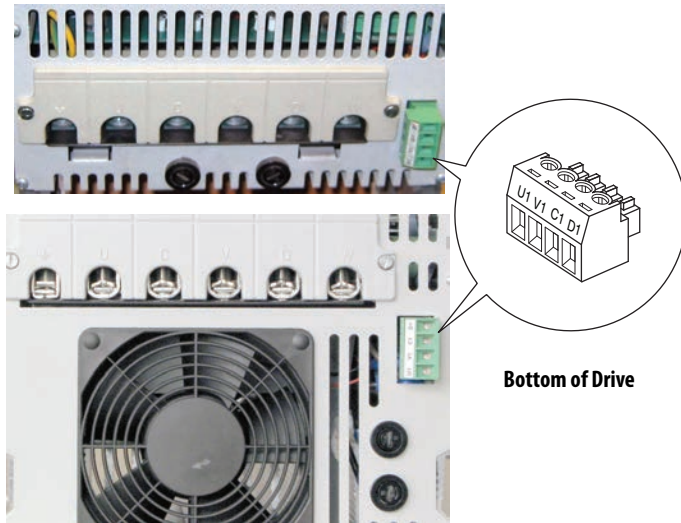


Figure 32 - Frame B Field Circuit Terminal Block Location

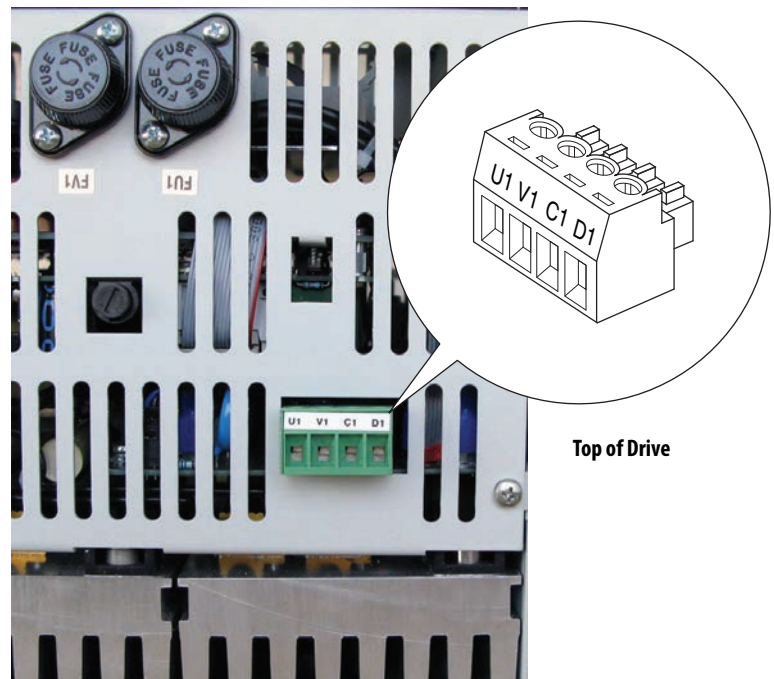


Figure 33 - 230V/460V AC Input Frame C Field Circuit Terminal Block Location

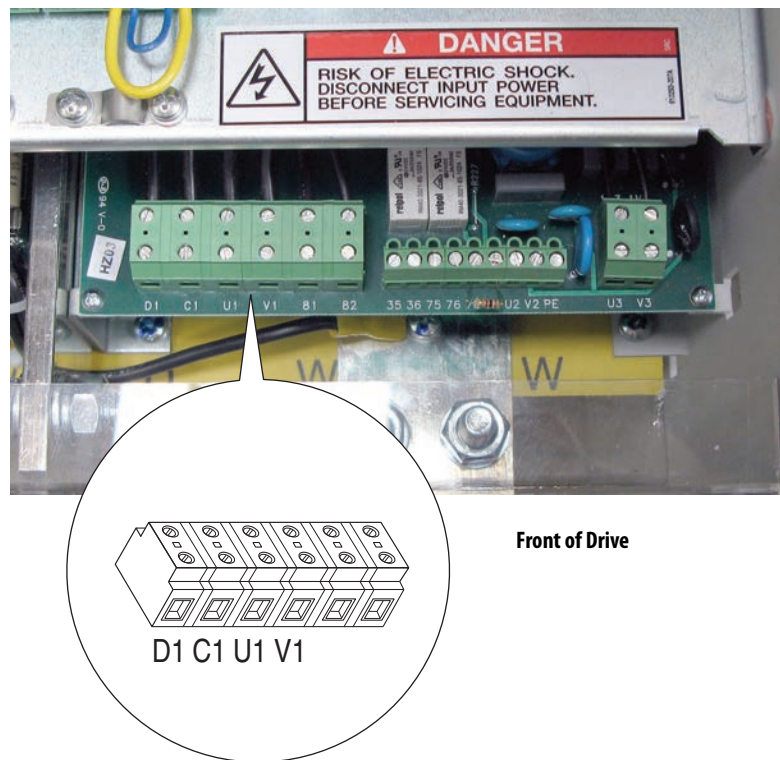




Figure 34 - 575V/690V AC Input Frame C Field Circuit Terminal Block Location

Top, Left Side of Drive

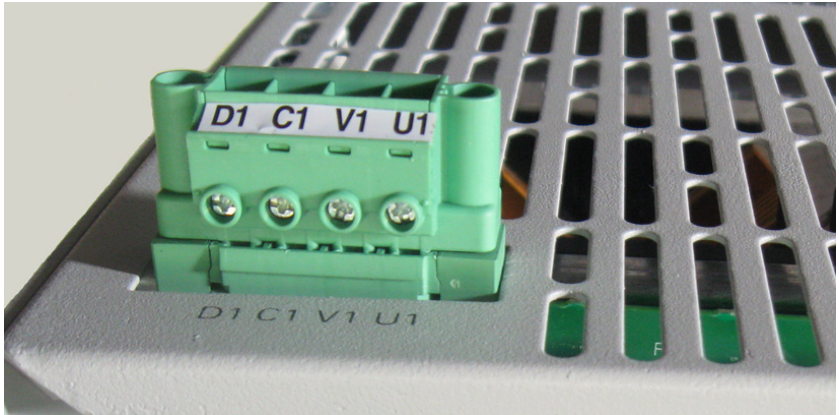


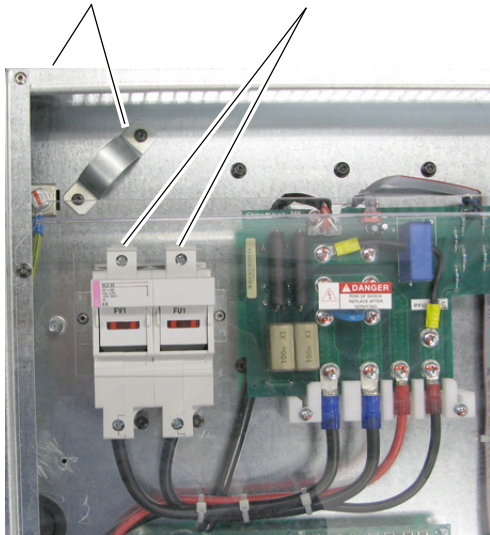
Figure 35 - Frame D Field Circuit Terminal Block Location

Top of Drive

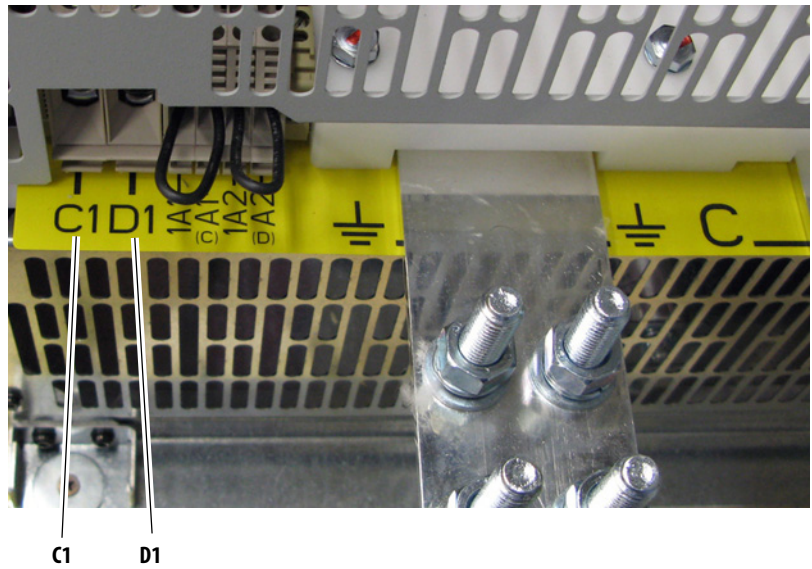
Shown with control cover removed.  
Remove control cover to access terminals.

Wire routing hole  
Cable clamp

AC input for field is at top of fuse holder (marked FU1, FV1)



Bottom of Drive, Left Side





## Field Current Configuration

DIP switch S14 on the drive control circuit board is factory set to the minimum field current rating based on the drive size. See DIP Switch and Jumper Settings on page 77 for S14 location. The field current configuration depends on the application. Follow the instructions for your application.

- If you are using the PowerFlex DC Drive with a PowerFlex DC Field Controller, see External Three-Phase Field Controller Current Configuration.
- If you are using the PowerFlex DC Drive with a permanent magnet motor, see Permanent Magnet Motor Field Controller Current Configuration.
- If you are using the PowerFlex DC Drive to control the motor field, see PowerFlex DC Drive Field Controller Current Configuration.

### *External Three-Phase Field Controller Current Configuration*

If the PowerFlex DC field controller (cat no. 23PFC) is used with a PowerFlex DC drive, leave DIP switch S14 set to the factory default settings. Make these parameter configuration changes:

- Set Par 374 [Drv Fld Brdg Cur] to the rated field current specified on the motor nameplate.
- Set Par 280 [Nom Mtr Fld Amps] equal to the value of Par 374 [Drv Fld Brdg Cur].

### *Permanent Magnet Motor Field Controller Current Configuration*

If the PowerFlex DC drive internal, single-phase field controller and a permanent magnet motor is used, leave DIP switch S14, Par 374 [Drv Fld Brdg Cur], and Par 280 [Nom Mtr Fld Amps] set to the factory default values.

### *PowerFlex DC Drive Field Controller Current Configuration*

If the PowerFlex DC drive internal, single-phase field controller is used to control the motor field, follow the configuration instructions in this section.

The configuration of this switch must be changed to be greater than or equal to the rated field current specified on the motor nameplate or possible motor damage may result. In addition, the value that is selected with switch S14 must be entered in parameter 374 [Drv Fld Brdg Cur] in the control software when the drive is commissioned (see Drive Start Up on page 93.)



**ATTENTION:** DIP switch S14 must be set to a value that is greater than or equal to the rated field current specified on the motor nameplate or possible motor damage may result.

## Set DIP Switch S14 to the Correct Value

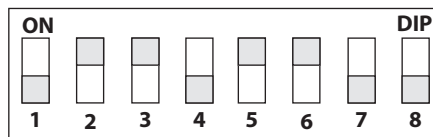
Complete the following steps to set switch S14 to the correct field current value.

1. Locate and record the frame size and field supply amp rating that is listed on the drive data nameplate (see Drive Nameplate Data on page [12](#) for location).
2. Locate and record the rated field current value that is listed on the motor data nameplate.
3. For frame A, B, and C drives:
  - Use [Table 16](#) on page [62](#) to set switch S14 to be the equivalent or next higher value as compared to the rated field current of the motor.

For frame D drives:

- Use [Table 17](#) or [Table 18](#) on page [63](#) to set switch S14 to be the equivalent or next higher value as compared to rated field current of the motor.

**Figure 36 - Example DIP Switch S14 Configuration**



This illustration is an example configuration for a drive with a field supply amp rating of 20 A and a motor with a rated field current less than or equal to 17 A.

The configuration of switch S14 is not required if the single-phase motor field control is provided via an external source. In this case, however, it is recommended that the switch settings be completed as described in Set DIP Switch S14 to the Correct Value.

**Table 16 - DIP Switch S14 Field Current Configuration Settings Frames A, B, and C Drives**

Switch ohms >	168.5	333.3	182	36.4	845	1668	3333	–	Equivalent Resistance
Field Current Scale	S14-1	S14-2	S14-3	S14-4	S14-5	S14-6	S14-7	S14-8	Ohms
1 A	OFF	OFF	OFF	OFF	OFF	ON	Not used (OFF)		1668
2 A	OFF	OFF	OFF	OFF	ON	OFF		845	
3 A	OFF	OFF	OFF	OFF	ON	ON		560.9	
5 A	OFF	ON	OFF	OFF	OFF	OFF		333.3	
10 A	ON	OFF	OFF	OFF	OFF	OFF		168.5	
13 A	ON	OFF	OFF	OFF	ON	ON		129.6	
17 A	OFF	ON	ON	OFF	ON	ON		97.3	
20 A	ON	OFF	ON	OFF	OFF	ON		83.1	

**Table 17 - DIP Switch S14 Field Current Configuration Settings for Frame D Drives and Standalone Regulators with a Rated Field Supply of 40 A**

Switch ohms >	168.5	333.3	182	36.4	845	1668	3333	–	Equivalent Resistance
Field Current Scale	S14-1	S14-2	S14-3	S14-4	S14-5	S14-6	S14-7	S14-8	Ohm
1 A	OFF	OFF	OFF	OFF	OFF	OFF	ON	Not used (OFF)	3333
2 A	OFF	OFF	OFF	OFF	OFF	ON	OFF		1668
4 A	OFF	OFF	OFF	OFF	ON	OFF	OFF		845
6 A	OFF	OFF	OFF	OFF	ON	ON	OFF		560.9
10 A	OFF	ON	OFF	OFF	OFF	OFF	OFF		333.3
20 A	ON	OFF	OFF	OFF	OFF	OFF	OFF		168.5
30 A	ON	ON	OFF	OFF	OFF	OFF	OFF		111.9
40 A	ON	OFF	ON	OFF	OFF	ON	OFF		83.1

**Table 18 - DIP Switch S14 Field Current Configuration Settings for Frame D Drives and Standalone Regulators with a Rated Field Supply of 70 A**

Switch ohms >	168.5	333.3	182	36.4	845	1668	3333	–	Equivalent Resistance
Field Current Scale	S14-1	S14-2	S14-3	S14-4	S14-5	S14-6	S14-7	S14-8	Ohm
1 A	OFF	OFF	OFF	OFF	OFF	ON	OFF	Not used (OFF)	1668
5 A	OFF	ON	OFF	OFF	OFF	OFF	OFF		333.3
10 A	ON	OFF	OFF	OFF	OFF	OFF	OFF		168.5
20 A	ON	OFF	ON	OFF	OFF	ON	OFF		83.1
50 A	OFF	ON	OFF	ON	OFF	OFF	OFF		32.8
70 A	ON	ON	ON	ON	OFF	OFF	OFF		23.9

## Relay Outputs

Terminals 35 and 36 and 75 and 76 are N.O. relay outputs. The relay output between terminals 35 and 36 is configured with parameter [1392](#) [Relay Out 1 Sel]. The relay output between terminals 75 and 76 is configured with parameter [629](#) [Relay Out 2 Sel]. See Contactors on page [31](#) for more information.

Terminals	Description	Maximum Voltage	Maximum Current
35, 36	Normally open contact. Configured with parameter 1392 [Relay Out 1 Sel], set to 25 "Contactor" by default.	250V AC	1 A
75, 76	Normally open contact. Configured with parameter 629 [Relay Out 2 Sel], set to 5 "Ready" by default.		
78, 79	Motor thermistor (PTC) or thermal switch connections		

If external contactor coil current ratings are greater than one amp, use an interposing relay between the drive relay 1 or relay 2 output and the contactor coil.

## Thermistors and Thermal Switches

To detect motor overheating and protect the motor from overloading, an external, user-supplied thermistor (PTC) or thermal switch must be connected to terminals 78 and 79. The drive response to a motor over temperature fault is configured in parameter [365](#) [OverTemp Flt Cfg]. If a thermistor or thermal switch is not used, a 1 k $\Omega$  resistor must be connected between terminals 78 and 79 (installed at the factory). Follow the appropriate thermal sensor (thermistor or thermal switch) installation instructions.

### *Thermistors (PTC)*

PTC thermistors that are installed in the motor can be connected directly to the drive via terminals 78 and 79. In this case, the 1 k $\Omega$  resistor is not required between terminals 78 and 79.

### *Thermal Switches (Klixon<sup>®</sup>) in the Motor Windings*

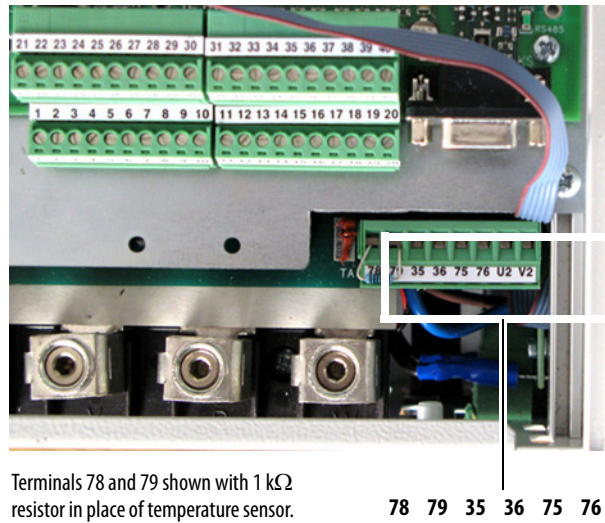
"Klixon" type temperature-dependent contacts can disconnect the drive from the motor via an external control or be configured as an external fault by using a drive digital input. Though not recommended, a Klixon can also be connected to terminals 78 and 79 to indicate a drive "Motor Over Temp" fault (F16). This connection can cause noise sensitivity of the current threshold circuitry. If a thermal switch is used, a 1 k $\Omega$  resistor must be placed in series between the switch and one of the terminals.

**Table 19 - Relay Outputs and Thermistor/Thermal Switch Wire Sizes and Specifications**

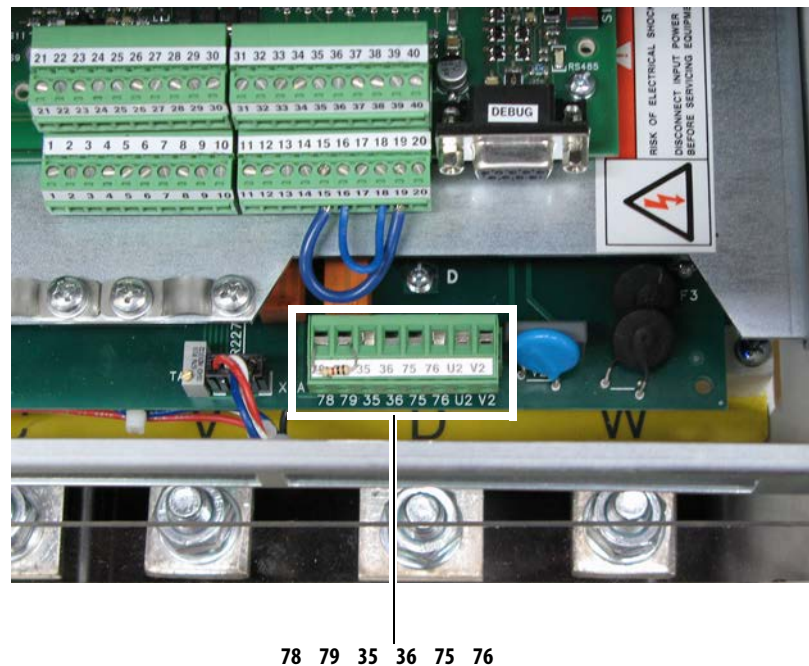
Signal Type	Terminals	Wire Size and Type <sup>(1)</sup>			Recommended Torque N•m (lb•in)
		Flexible (mm <sup>2</sup> )	Multi-core (mm <sup>2</sup> )	AWG	
Relay Outputs	35 / 36 and 75 / 76	0.140...1.500	0.140...1.500	26...14	0.5 (4.4)
Thermistor and Thermal Switches	78 / 79				

(1) See Cable and Wiring Recommendations on page 44 for more information.

**Figure 37 - Frame A Relay and Thermistor/Thermal Switch Terminal Block Locations**

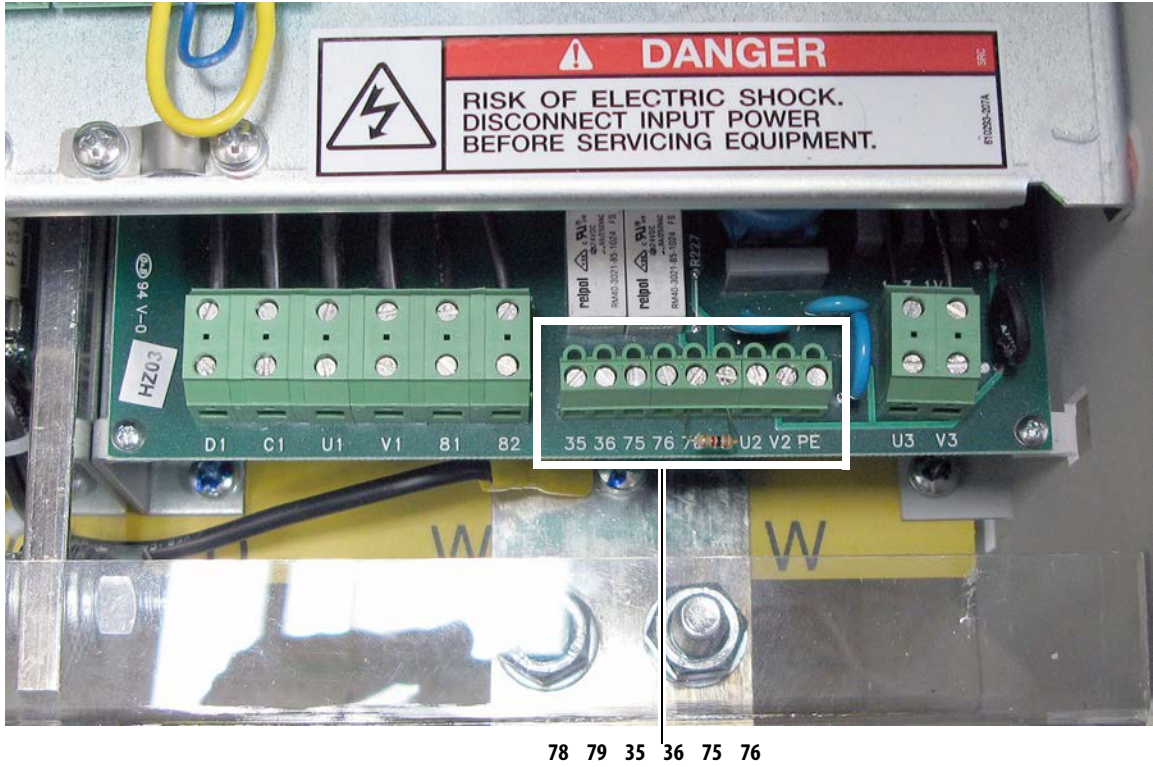


**Figure 38 - Frame B Relay and Thermistor/Thermal Switch Terminal Block Locations**



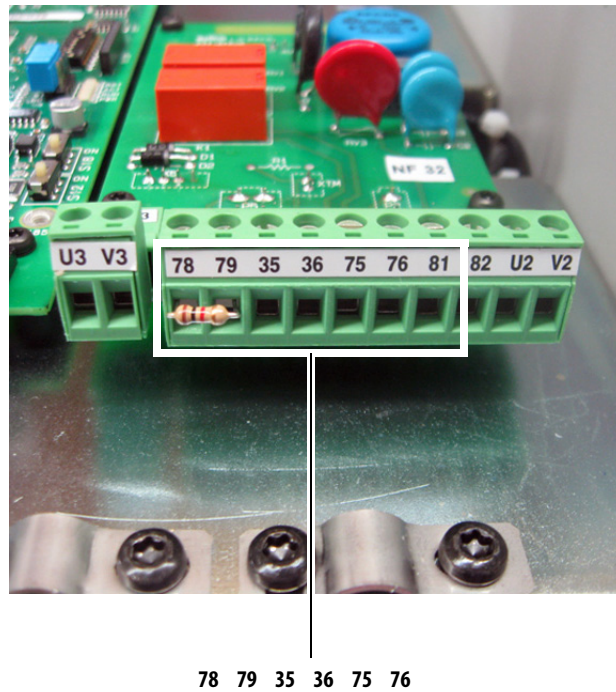


**Figure 39 - 230V/460C AC Input Frame C Relay and Thermistor/Thermal Switch Terminal Block Locations**

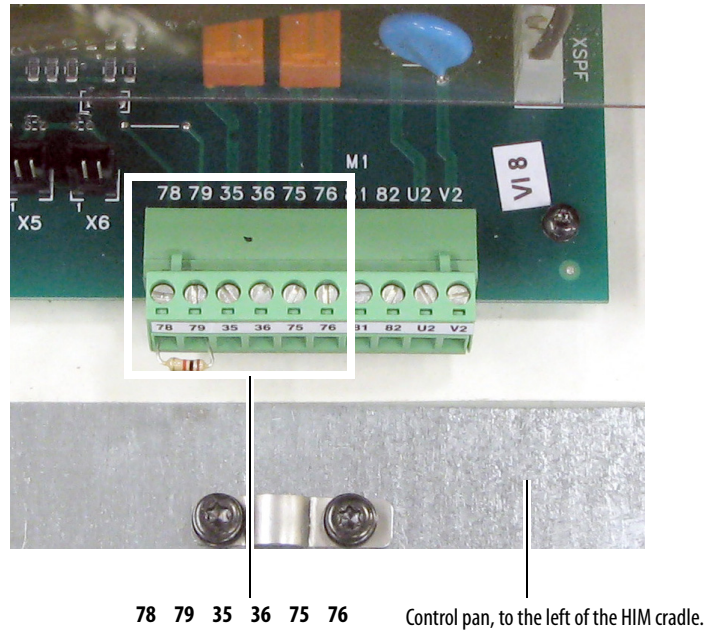


**Figure 40 - 575V/690C AC Input Frame C Relay and Thermistor/Thermal Switch Terminal Block Locations**

Lower, right side of the control pan.



**Figure 41 - Frame D Relay and Thermistor/Thermal Switch Terminal Block Locations**



### Control Circuit Input Power

Only power the control circuit by using a clean, external 230V AC, or 115V AC single phase power supply. For frame B and C drives only, a jumper is required between terminals SA and SB for 115V AC control input power. For frame B drive SA-SB terminal block location, see [Figure 47](#) on page 70. For frame C drive SA-SB terminal block location, see [Figure 47](#) on page 70.

Terminals	Description
U2, V2	Single phase AC power for the control circuits
PE	Safety ground (on frame C drive terminal blocks only)
SA-SB	Frame B and C control circuit input power source configuration

**Table 20 - Control Circuit Wire Sizes and Terminal Specifications**

Terminals	Wire Size and Type <sup>(1)</sup>			Recommended Torque N•m (lb•in)
	Flexible (mm <sup>2</sup> )	Multi-core (mm <sup>2</sup> )	AWG	
U2, V2	0.14...1.5	0.14...2.5	26...14	0.5 (4.4)
SA-SB	0.8...1.5	0.8...2.5	18...14	0.5 (4.4)
PE	2.5...10	2.5...10	12...8	2.0 (18.0)

(1) See Cable and Wiring Recommendations on page 44 for more information.

Figure 42 - Frame A Control Circuit Terminal Block Location

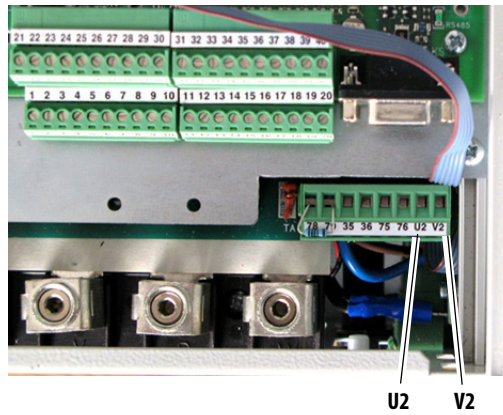


Figure 43 - Frame B Control Circuit Terminal Block Location

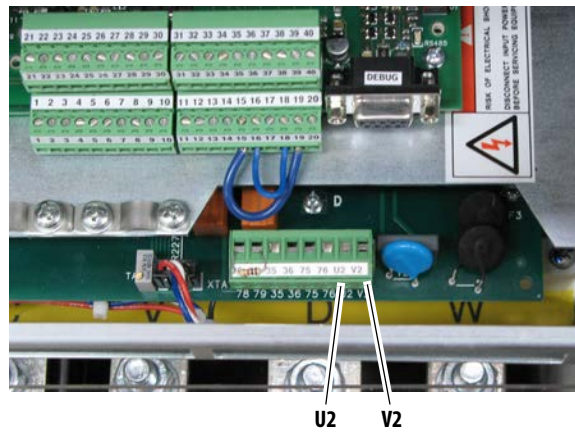
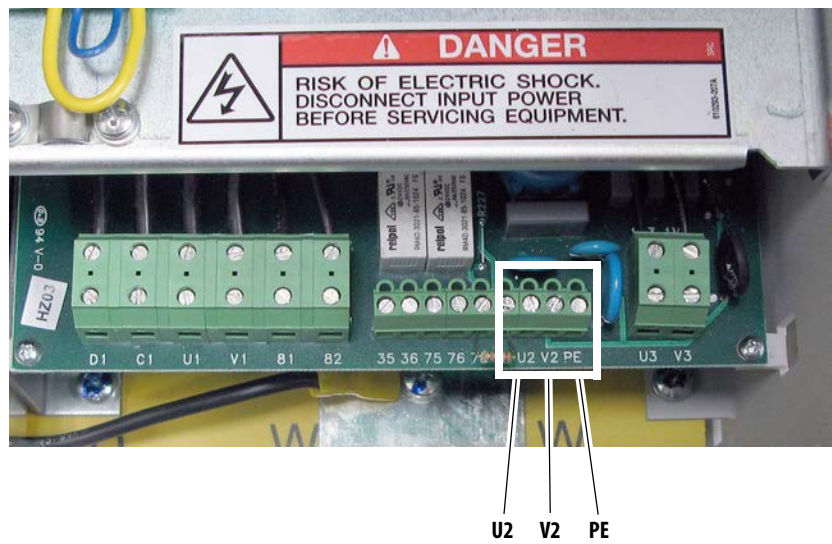


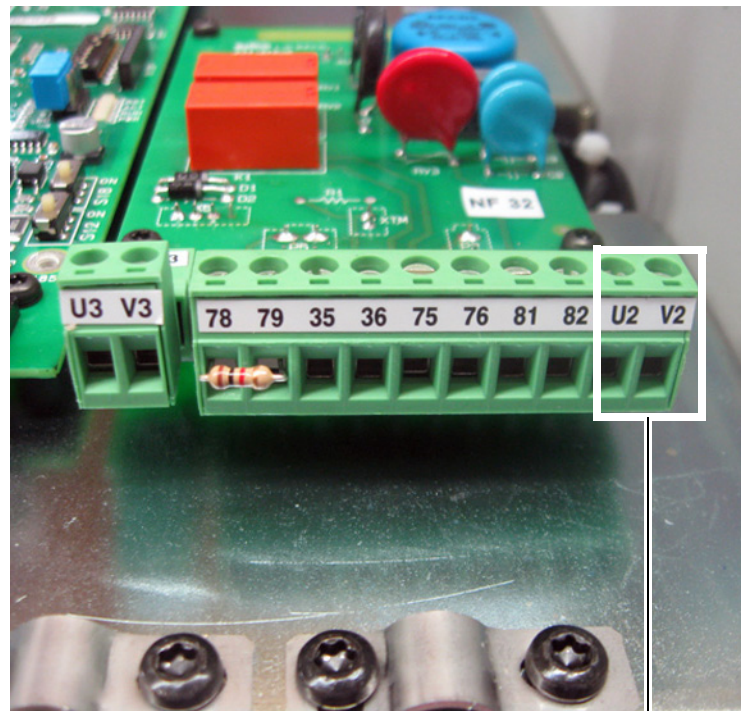
Figure 44 - 230V/460V AC Input Frame C Control Circuit Terminal Block Location





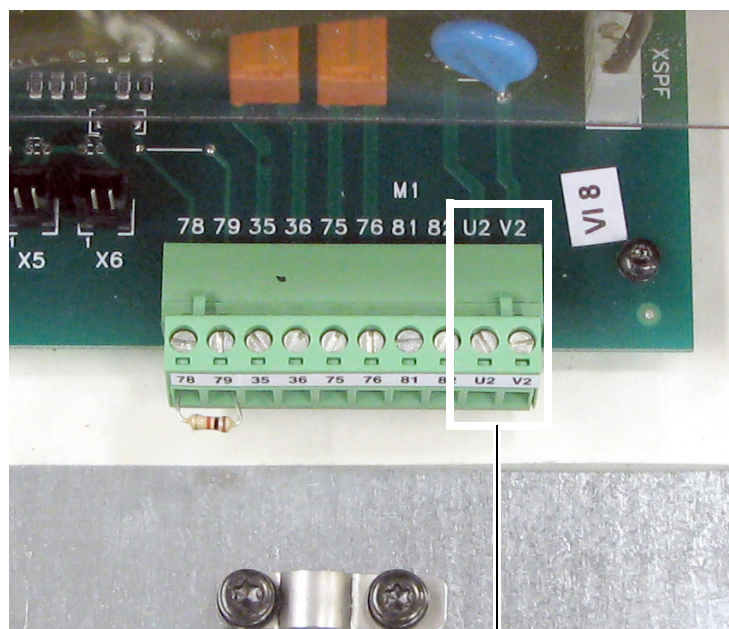
**Figure 45 - 575V/690V AC Input Frame C Control Circuit Terminal Block Location**

Lower, right side of the control pan.



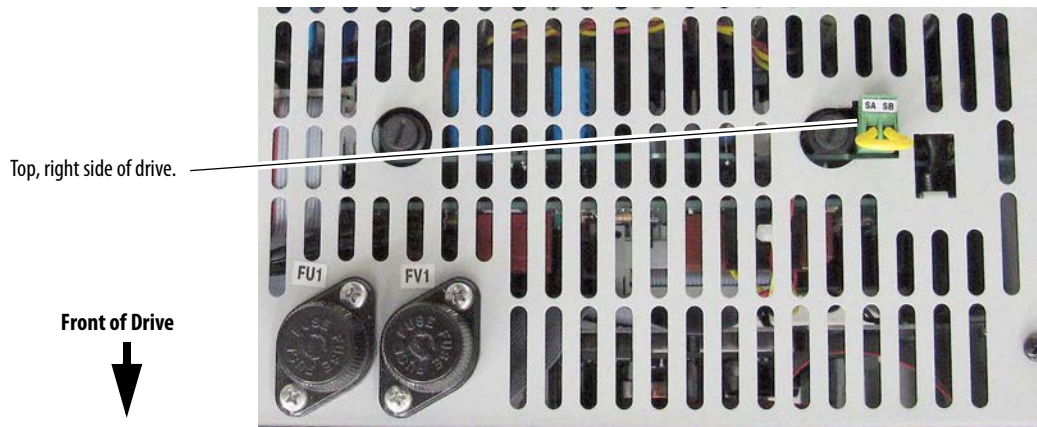
U2 V2

**Figure 46 - Frame D Control Circuit Terminal Block Location**



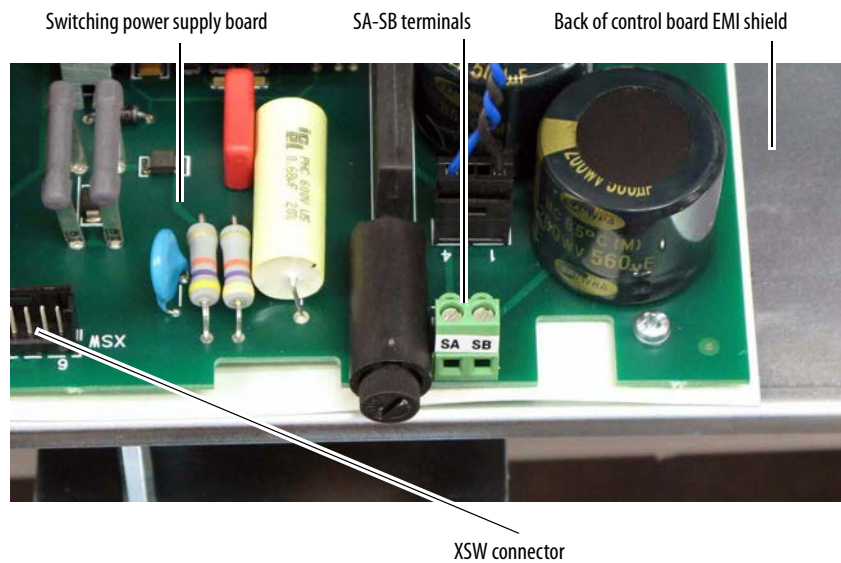
U2 V2

**Figure 47 - SA-SB Terminal Block Location on Frame B Drives**



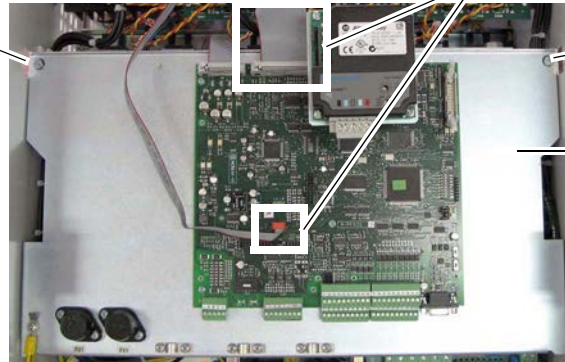
**Figure 48 - SA-SB Terminal Block Location on Frame C Drives**

The SA-SB terminal block is on the switching power supply circuit board on the back of the control board EMI shield.



To access the SA-SB terminal block:

1. Remove the top protective cover from the drive.
2. Disconnect cables XFCD and XR.
3. Loosen captive screws.
4. Lower control board EMI shield and disconnect cable XSW from switching power supply board (see above).



## Frame C Heatsink Cooling Fan Specifications

Frame C drives require an external 230V AC power supply for the heatsink cooling fans. If sourced from the main 3-phase AC input, the power supply connections must be taken from the primary side of the installed Isolation Transformer or Line Reactor (clean power).

In addition, the fan power input terminals U3 and V3 are required to be short-circuit protected. This protection can be provided by using a circuit breaker or fuses.

- If a circuit breaker is used, it must be rated for the short-circuit available current of the feeder source for this circuit and the inrush current of the fan. Size the circuit breaker to protect the wiring from the circuit breaker connections to terminals U3 and V3, and not nuisance trip or blow from the inrush current.
- If fuses are used, they must be rated for either 230V AC, 2.0 Amps (slow blow).

**Table 21 - Frame C Heatsink Cooling Fans Terminal Designations**

Terminal	Description	Maximum Voltage	Maximum Current
U3	Single-phase AC input power for cooling fans.	230V AC	1 A
V3			

**Table 22 - Frame C Heatsink Cooling Fans Wire Sizes and Terminal Specifications**

Terminals	Wire Size and Type <sup>(1)</sup>			Recommended Torque N•m (lb•in)
	Flexible (mm <sup>2</sup> )	Multi-core (mm <sup>2</sup> )	AWG	
U3, V3	0.14...1.5	0.14...2.5	26...16	0.4 (3.5)

(1) See Cable and Wiring Recommendations on page 44 for more information.



Figure 49 - 230V/460V AC Input Frame C Heatsink Cooling Fan Terminal Block Location

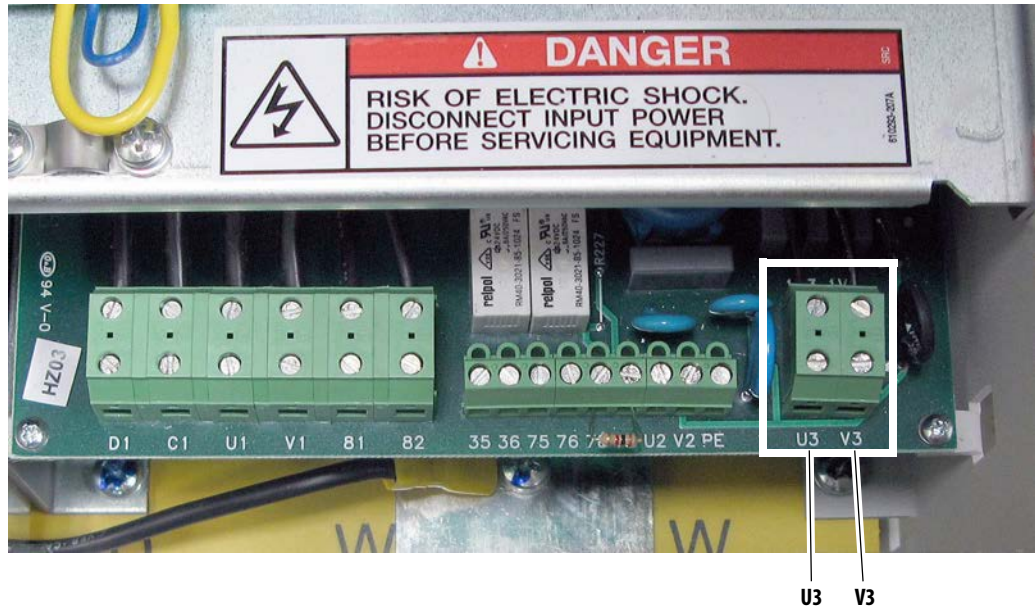
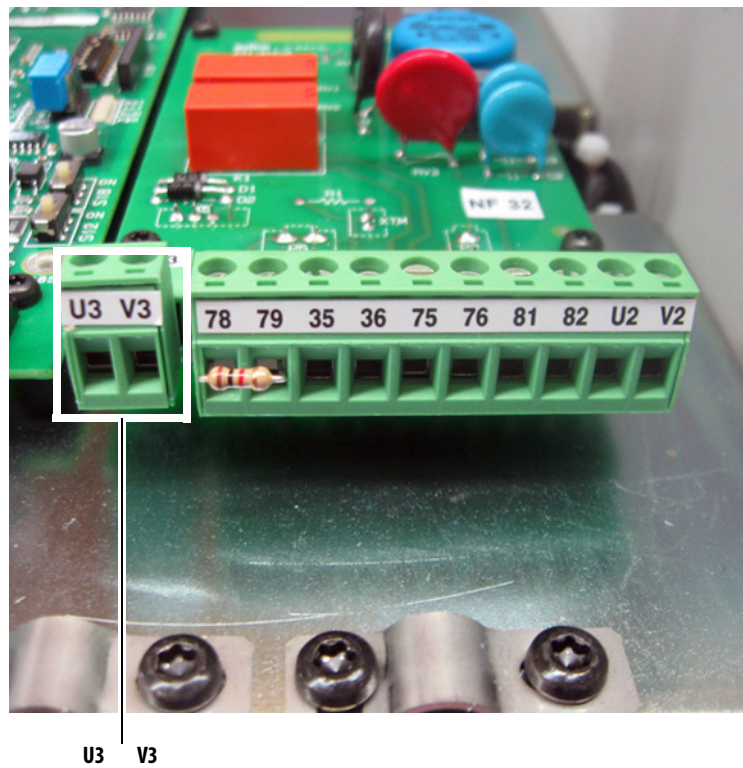


Figure 50 - 575V/690V AC Input Frame C Heatsink Cooling Fan Terminal Block Location

Lower, right side of the control pan.



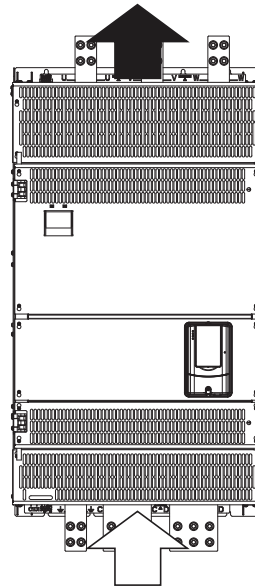
## Frame D, Series B and C Heatsink Cooling Fan Specifications

The Frame D, series B and C drive cooling fan requires 3-phase, 400V...460V AC input power. If sourced from the main 3-phase AC input, the power supply connections must be taken from the primary side of the installed isolation transformer or line reactor (clean power).

---

**IMPORTANT** When connecting the fan power wiring, verify that the airflow enters through the bottom and exits through the top of the drive. If the airflow is incorrect, switch the leads on terminals U3 and V3.

---




The cooling fan power input terminals U3, V3, and W3 are required to be short-circuit protected. This protection can be provided by using a circuit breaker or fuses.

- If a circuit breaker is used, it must be rated for the short-circuit available current of the feeder source for this circuit and the inrush current of the fan. Size the circuit breaker to protect the wiring from the circuit breaker connections to terminals U3, V3, and W3, and not nuisance trip or blow from the inrush current.
- If fuses are used, they must be rated for either 400V AC, 2.5 Amps (slow blow), or 460V AC, 3.15 Amps (slow blow).

To indicate a fan power supply failure, a normally closed contact can be wired between terminals 31 and 32 on the fan circuit board and one of the following selections.

- A drive digital input, configured for 14 “Aux Fault” in the applicable parameter (133...144)
- An external fault indication device

**Table 23 - Frame D, Series B and C Heatsink Cooling Fan Terminal Designations**

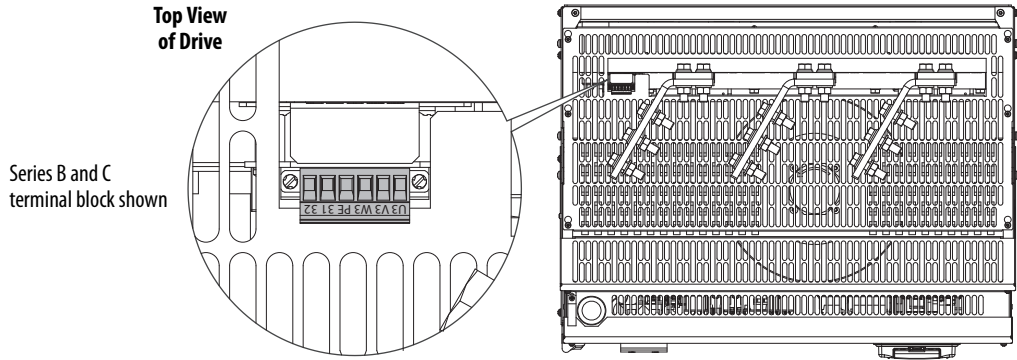
Terminal Block	Terminal	Description	AC Voltage	Max Current
	U3	Three-phase AC input power connections	400V AC / 50 Hz 460V AC / 60 Hz	1.5 A
	V3			
	W3			
	PE	Safety ground	–	–
	31	Normally closed contact	250V AC	1 A
	32			

**Table 24 - Frame D, Series B and C Heatsink Cooling Fan Signal Wire Sizes and Terminal Specifications**

Terminals	Wire Size and Type <sup>(1)</sup>			Recommended Torque N•m (lb•in)
	Flexible (mm <sup>2</sup> )	Multi-core (mm <sup>2</sup> )	AWG	
U3, V3, W3, 31, 32, PE	0.14...1.5	0.14...2.5	28...12	0.5...0.6 (4.4...5.3)

(1) See Cable and Wiring Recommendations on page 44 for more information.

**Figure 51 - Frame D Heatsink Cooling Fan Terminal Block Location**



## Frame C and D Armature Fuse Signal Terminals

Terminals 81 and 82 on frame C and D drives are connected to the indicating switch mounted on each of the internal armature circuit protection fuses. These terminals can be connected to an external device to provide indication that the fuses have opened. Alternatively, terminals 81 and 82 can be wired to drive digital input terminals that are configured for 64 “Invert Flt” (via Pars 133...144).

**Table 25 - Armature Fuse Signal Terminal Designations**

Terminal	Description	Maximum Voltage	Maximum Current
81	Internal armature fuse intervention signal.	250V AC	1 A
82			

**Table 26 - Armature Fuse Signal Wire Size and Terminal Specifications**

Terminals	Wire Size and Type <sup>(1)</sup>			Recommended Torque N•m (lb•in)
	Flexible (mm <sup>2</sup> )	Multi-core (mm <sup>2</sup> )	AWG	
81, 82	0.14...1.5	0.14...2.5	26...16	0.4 (3.5)

(1) See Cable and Wiring Recommendations on page 44 for more information.

**Figure 52 - 230V/460V AC Input Frame C Internal Armature Fuse Signal Terminal Block Location**

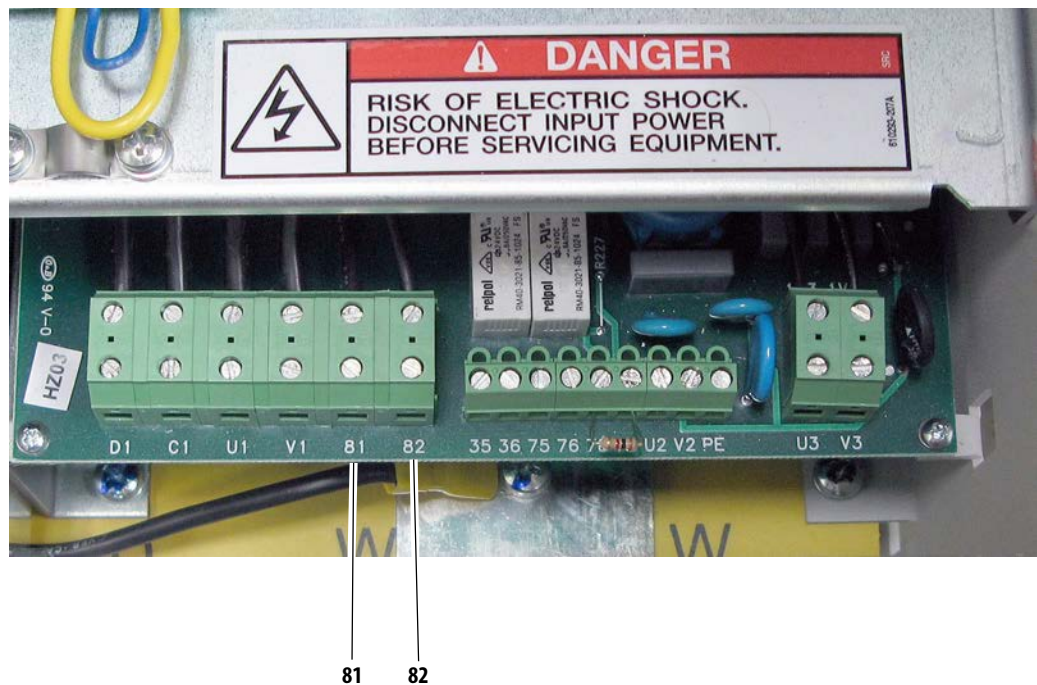




Figure 53 - 575V/690V AC Input Frame C Internal Armature Fuse Signal Terminal Block Location

Lower, right side of the control pan.

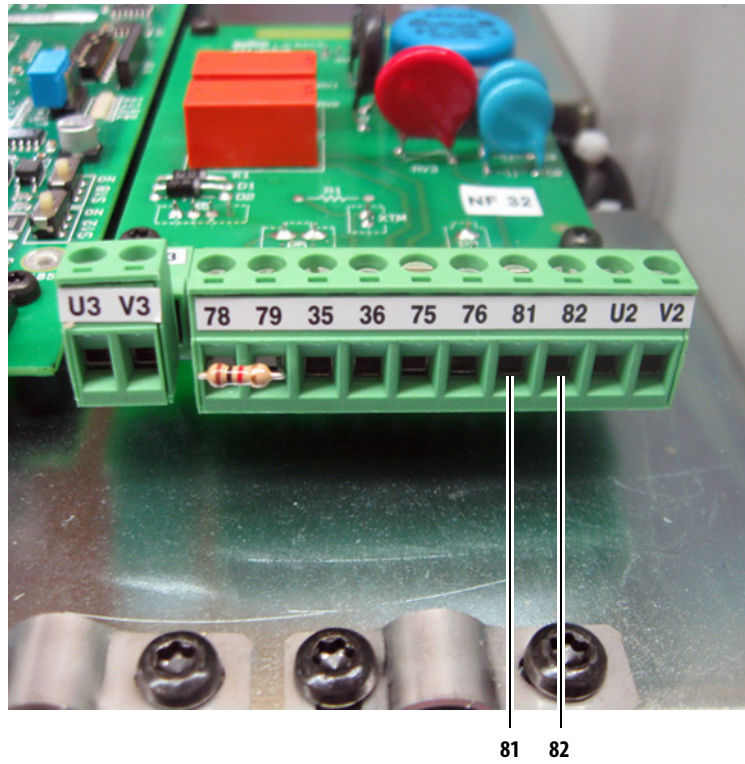
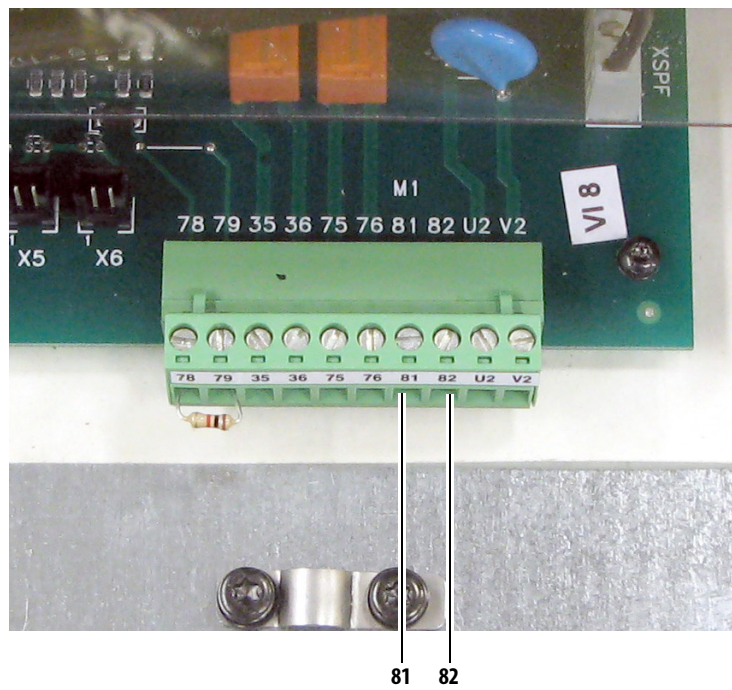


Figure 54 - Frame D Internal Armature Fuse Signal Terminal Block Location





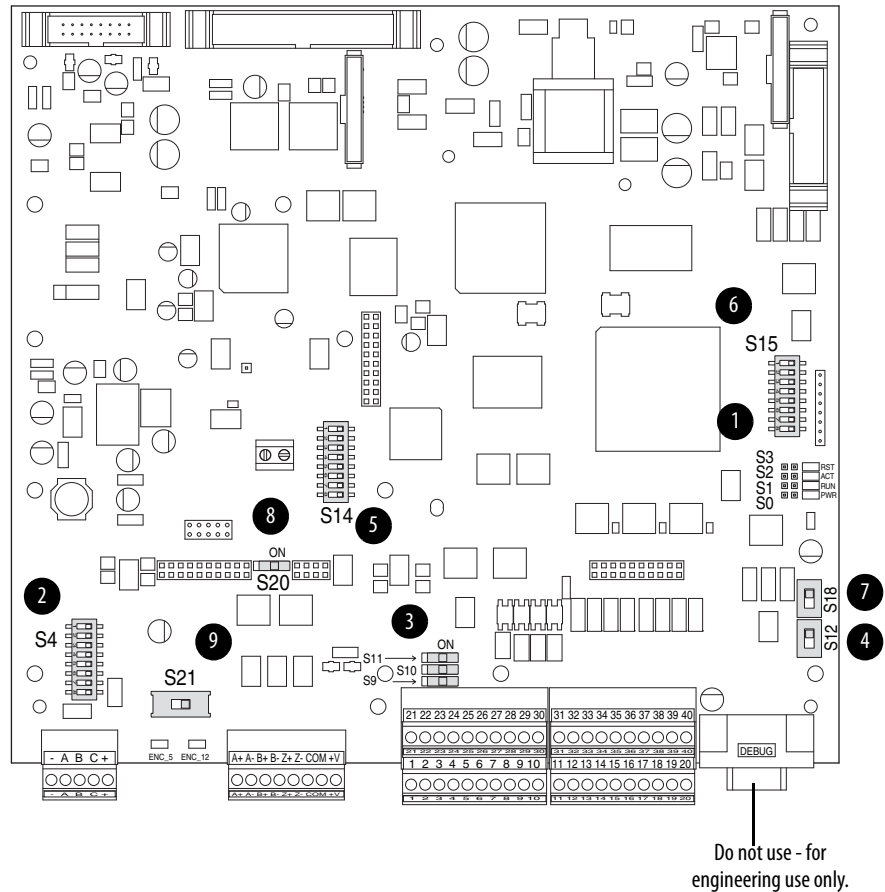
# DIP Switch and Jumper Settings

DIP switches and jumpers on the control circuit board are used to configure the drive for the following features:

- Firmware flash updates to the control board EEPROM
- Speed feedback device settings
- Analog input signal sources
- Minimum field current

See [Table 27](#) on page 78 for descriptions corresponding to the ID numbers shown here.

**Figure 55 - Control Circuit Board DIP Switch and Jumper Locations**



**Table 27 - Control Circuit Board Jumper and DIP Switch Settings**

ID	Jumper/Switch	Function	Factory Default	Example
1	S0	For factory boot flashing only. Leave set to the factory setting. Jumper On           Firmware boot Jumper Off           Normal function	Jumper Off	
	S1	For factory boot flashing only. Leave set to the factory setting. Jumper On           Write firmware boot code Jumper Off           Boot code on flash is protected	Jumper Off	
	S2	Not used. Leave set to the factory setting.	Jumper Off	
	S3	For factory boot flashing only. Leave set to the factory setting. Jumper On           Reset Jumper Off           Normal function	Jumper Off	
2	S4	Configures the input voltage of the DC analog tachometer. See <a href="#">Table 28</a> on page 79 for configuration.	90V	–
3	S9	Configures the input signal of Analog Input 1 (terminals 1 and 2): Off Position        0...20 mA / 4...20 mA On Position        0...10V / ±10V Par 71 [Anlg In1 Config] must be programmed to match the input signal type selected with this switch.	On	
	S10	Configures the input signal of Analog Input 2 (terminal 3 and 4): Off Position        0...20 mA / 4...20 mA On Position        0...10V / ±10V Par 76 [Anlg In2 Config] must be programmed to match the input signal type selected with this switch.	On	
	S11	Configures the input signal of Analog Input 3 (terminals 5 and 6): Off Position        0...20 mA / 4...20 mA On Position        0...10V / ±10V Par 81 [Anlg In3 Config] must be programmed to match the input signal type selected with this switch.	On	
4	S12	Not used. Leave set to the factory setting.	Off	–
5	S14	Field current resistors setting, see Field Current Configuration on page 61. The value that is selected with switch S14 must be entered in Par 374 [Drv Fld Brdg Cur] when the drive is commissioned. For permanent magnet motor or external field controller applications, leave set to the factory default settings.	Minimum field current rating based on the drive size.	–
6	S15	Configuration of the control circuit board to the appropriate drive size. Leave set to the factory setting, unless the control board has been supplied as a spare part. See DIP Switch S15 Settings on page 79 for switch configuration that is based on drive current rating code.	Armature current based on drive size.	–
7	S18	Not used. Leave set to the factory setting.	Off	–
8	S20	Monitoring (reported by Par 652 [Encoder Err Chk]) of the Z channel of the Digital Encoder on connector XE2. This switch adds/removes the Z channel in the encoder hardware check circuit. Par 652 enables/disables reading the result of that hardware check. Off Position        Z channel monitored On Position        Z channel not monitored	On	
9	S21	Encoder power supply voltage and input selection: This switch setting determines both the power supply (input) and feedback level (output) voltage of the connected encoder. When control power is supplied to the drive, the appropriate LED lights to indicate the selection of the switch. ENC_5            +5V encoder (2.5...5.4V input range) ENC_12           +12...15V encoder (+5.4V...15.2V input range)	12...5V	

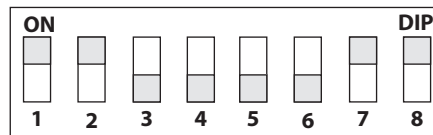
*DIP Switch S4 Settings*



**ATTENTION:** The drive can overspeed if DIP switch S4 is set incorrectly or the tachometer is wired incorrectly. Failure to observe this precaution could result in damage to, or destruction of, the equipment.

DIP switch S4 must be configured to be greater than or equal to the maximum DC input voltage. Maximum DC Input Voltage = (Tach Volts/1000 rpm) x Par 45 [Max Ref Speed] x 1.1. See Drive Reference and Feedback Scaling on page 296 for details on speed feedback value configuration.

**Figure 56 - DC Analog Tachometer DIP Switch S4 Example**



The illustration depicts the DIP switch settings for 90V (factory default).

**Table 28 - DC Analog Tachometer DIP Switch S4 Configuration**

Maximum DC Input Voltage	S4-1 S4-8	S4-2 S4-7	S4-3 S4-6	S4-4 S4-5
22V	ON	ON	ON	ON
45V	ON	ON	ON	OFF
90V	ON	ON	OFF	OFF
180V	ON	OFF	OFF	OFF
300V	OFF	OFF	OFF	OFF

*DIP Switch S15 Settings*

DIP Switch S15 is configured for the appropriate drive size at the factory. Do not change the settings unless you are installing a replacement control board.

**Figure 57 - Drive Size DIP Switch S15 Example**



Illustration for example only.

**Table 29 - Drives with 230V Input - DIP Switch S15 Configuration**

Frame	Drive Current Rating Code	S15-1	S15-2	S15-3	S15-4	S15-5	S15-6	S15-7	S15-8
A	7P0	ON	OFF	OFF	OFF	OFF	OFF	OFF	OFF
	9P0	OFF	ON	OFF	OFF	OFF	OFF	OFF	OFF
	012	ON	ON	OFF	OFF	OFF	OFF	OFF	OFF
	020	OFF	OFF	ON	OFF	OFF	OFF	OFF	OFF
	029	ON	OFF	ON	OFF	OFF	OFF	OFF	OFF
	038	OFF	ON	ON	OFF	OFF	OFF	OFF	OFF
	055	ON	ON	ON	OFF	OFF	OFF	OFF	OFF
	073	OFF	OFF	OFF	ON	OFF	OFF	OFF	OFF
	093	ON	OFF	OFF	ON	OFF	OFF	OFF	OFF
	110	OFF	ON	OFF	ON	OFF	OFF	OFF	OFF
B	146	ON	ON	OFF	ON	OFF	OFF	OFF	OFF
	180	OFF	OFF	ON	ON	OFF	OFF	OFF	OFF
	218	ON	OFF	ON	ON	OFF	OFF	OFF	OFF
	265	OFF	ON	ON	ON	OFF	OFF	OFF	OFF
	360	ON	ON	ON	ON	OFF	OFF	OFF	OFF
	434	OFF	OFF	OFF	OFF	ON	OFF	OFF	OFF
C	521	ON	OFF	OFF	OFF	ON	OFF	OFF	OFF
	700	OFF	ON	OFF	OFF	ON	OFF	OFF	OFF
D	875	ON	ON	OFF	OFF	ON	OFF	OFF	OFF
	1K0	OFF	OFF	ON	OFF	ON	OFF	OFF	OFF

**Table 30 - Drives with 460V Input - DIP Switch S15 Configuration**

Frame	Drive Current Rating Code	S15-1	S15-2	S15-3	S15-4	S15-5	S15-6	S15-7	S15-8
A	4P1	OFF	OFF	OFF	OFF	OFF	OFF	ON	OFF
	6P0	ON	OFF	OFF	OFF	OFF	OFF	ON	OFF
	010	OFF	ON	OFF	OFF	OFF	OFF	ON	OFF
	014	ON	ON	OFF	OFF	OFF	OFF	ON	OFF
	019	OFF	OFF	ON	OFF	OFF	OFF	ON	OFF
	027	ON	OFF	ON	OFF	OFF	OFF	ON	OFF
	035	OFF	ON	ON	OFF	OFF	OFF	ON	OFF
	045	ON	ON	ON	OFF	OFF	OFF	ON	OFF
	052	OFF	OFF	OFF	ON	OFF	OFF	ON	OFF
	073	ON	OFF	OFF	ON	OFF	OFF	ON	OFF
	086	OFF	ON	OFF	ON	OFF	OFF	ON	OFF
	100	ON	ON	OFF	ON	OFF	OFF	ON	OFF
	129	OFF	OFF	ON	ON	OFF	OFF	ON	OFF

**Table 30 - Drives with 460V Input - DIP Switch S15 Configuration (continued)**

Frame	Drive Current Rating Code	S15-1	S15-2	S15-3	S15-4	S15-5	S15-6	S15-7	S15-8
B	167	ON	OFF	ON	ON	OFF	OFF	ON	OFF
	207	OFF	ON	ON	ON	OFF	OFF	ON	OFF
	250	ON	ON	ON	ON	OFF	OFF	ON	OFF
	330	OFF	OFF	OFF	OFF	ON	OFF	ON	OFF
	412	ON	OFF	OFF	OFF	ON	OFF	ON	OFF
C	495	OFF	ON	OFF	OFF	ON	OFF	ON	OFF
	667	ON	ON	OFF	OFF	ON	OFF	ON	OFF
D	830	OFF	OFF	ON	OFF	ON	OFF	ON	OFF
	996	ON	OFF	ON	OFF	ON	OFF	ON	OFF
	1K1	OFF	ON	ON	OFF	ON	OFF	ON	OFF
	1K3	ON	ON	ON	OFF	ON	OFF	ON	OFF
	1K4	OFF	OFF	OFF	ON	ON	OFF	ON	OFF

**Table 31 - Drives with 575V Input - DIP Switch S15 Configuration**

Frame	Drive Current Rating Code	S15-1	S15-2	S15-3	S15-4	S15-5	S15-6	S15-7	S15-8
B	067	OFF	OFF	OFF	OFF	OFF	OFF	OFF	ON
	101	ON	OFF	OFF	OFF	OFF	OFF	OFF	ON
	135	OFF	ON	OFF	OFF	OFF	OFF	OFF	ON
	270	ON	ON	OFF	OFF	OFF	OFF	OFF	ON
	405	OFF	OFF	ON	OFF	OFF	OFF	OFF	ON
C	540	ON	OFF	ON	OFF	OFF	OFF	OFF	ON
	675	OFF	ON	ON	OFF	OFF	OFF	OFF	ON
D	810	ON	ON	ON	OFF	OFF	OFF	OFF	ON
	1K0	OFF	OFF	OFF	ON	OFF	OFF	OFF	ON
	1K2	ON	OFF	OFF	ON	OFF	OFF	OFF	ON
	1K3	OFF	ON	OFF	ON	OFF	OFF	OFF	ON
	1K6	ON	ON	OFF	ON	OFF	OFF	OFF	ON

**Table 32 - Drives with 690V Input - DIP Switch S15 Configuration**

Frame	Drive Current Rating Code	S15-1	S15-2	S15-3	S15-4	S15-5	S15-6	S15-7	S15-8
C	452	OFF	OFF	OFF	OFF	OFF	OFF	ON	ON
	565	ON	OFF	OFF	OFF	OFF	OFF	ON	ON
D	678	OFF	ON	OFF	OFF	OFF	OFF	ON	ON
	791	ON	ON	OFF	OFF	OFF	OFF	ON	ON
	904	ON	OFF	ON	OFF	OFF	OFF	ON	ON
	1K0	OFF	ON	ON	OFF	OFF	OFF	ON	ON
	1K1	ON	ON	ON	OFF	OFF	OFF	ON	ON
	1K2	OFF	OFF	OFF	ON	OFF	OFF	ON	ON
	1K4	OFF	ON	OFF	ON	OFF	OFF	ON	ON
	1K5	ON	ON	OFF	ON	OFF	OFF	ON	ON

## I/O Wiring

Observe the following points when installing I/O wiring:

- Use copper wire only.
- Wire with an insulation rating of 600V or greater is recommended.

---

**IMPORTANT** I/O terminals that are labeled “(-)” or “Common” are not referenced to earth ground and are designed to reduce common mode interference. Grounding these terminals can cause signal noise.

---



**ATTENTION:** An analog input configured for current operation and driven from a voltage source could cause component damage. Verify the proper switch configuration before input signals are applied. See DIP Switch and Jumper Settings on page [77](#).



**ATTENTION:** Hazard of personal injury or equipment damage exists when bipolar input sources are used. Noise and drift in sensitive input circuits can cause unpredictable changes in motor speed and direction. Use speed command parameters to help reduce input source sensitivity.

---

## I/O Signal and Control Wiring

Eight digital inputs, four digital outputs, three analog inputs, and two analog outputs are available on the standard I/O terminal blocks that are provided with the drive. One digital input (1...8) must be configured for “Enable” (digital input 4 by default = “Enable”). See I/O and Control Wire Routing on page 91 for information on routing I/O signal and control wires.

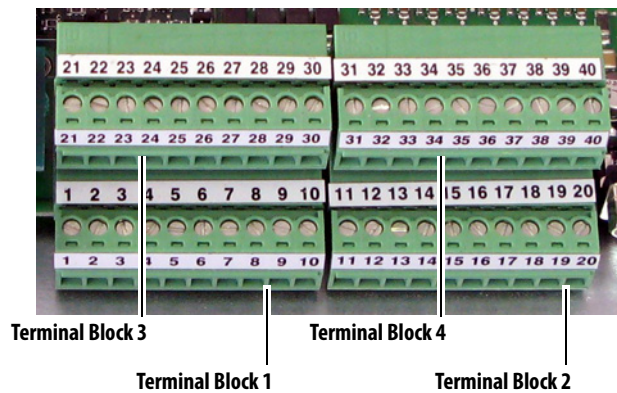
Additional digital and analog I/O is available when the optional I/O expansion circuit board is installed. See Appendix F on page 391 for more information. The optional 115V AC converter circuit board can be used to convert 115V AC digital input signals to 24V DC digital inputs signals. This board can be used to interface with the digital inputs on the standard I/O terminal blocks. See Appendix G on page 393 for more information.

**Table 33 - Analog I/O, Digital I/O, and DC Analog Tachometer Wire Sizes and Terminal Specifications**

Signal Type	Terminal Block (Terminals)	Wire Size and Type <sup>(1)</sup>			Recommended Torque N•m (lb•in)
		Flexible (mm <sup>2</sup> )	Multi-core (mm <sup>2</sup> )	AWG	
Analog and Digital I/O	TB1...4 (1...40)	0.140...1.500	0.140...1.500	26...16	0.4 (3.5)
DC Analog Tach	M3 (+ and -)				

(1) See Cable and Wiring Recommendations on page 44 for more information.

**Figure 58 - I/O Terminal Block Locations**

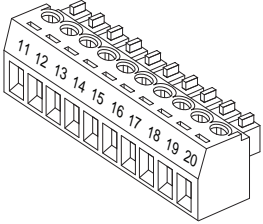


**Table 34 - I/O Terminal Block 1 Designations**

No.	Signal	Description	Factory Default	Config. Parameter
1	Analog Input 1 (+)	Isolated <sup>(1)</sup> , bipolar, differential	1 “Speed Ref A”	70 [Anlg In1 Sel]
2	Analog Input 1 (-)	±10V / 0...20 mA or 4...20 mA.		
3	Analog Input 2 (+)	<b>Important:</b> 0...20 mA or 4...20 mA operation requires that switch S9, S10, and S11 on the control board be in the “Off” position. Drive damage may occur if the switch is not in the correct position based on the type of input signal. See Table 27 on page 55.	0 “Off”	75 [Anlg In2 Sel]
4	Analog Input 2 (-)			
5	Analog Input 3 (+)	Max ±10V, Max 0.25 mA.	0 “Off”	80 [Anlg In3 Sel]
6	Analog Input 3 (-)			
7	+10V Pot Reference	2...5 kΩ load. Max ±10V, 10 mA.	–	–
8	-10V Pot Reference			
9	Pot Common	For (+) and (-) 10V pot references.	–	–
10	PE ground	PE ground to drive chassis.	–	–

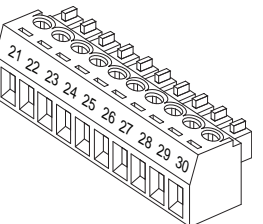
(1) Differential Isolation - External source must be maintained at less than 160V with respect to PE. Input provides high common-mode immunity.

Table 35 - I/O Terminal Block 2 Designations



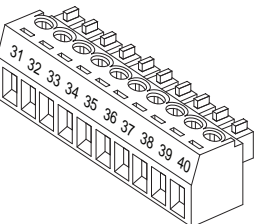
No.	Signal	Description	Factory Default	Config. Parameter
11	Internal 0V (Gnd)		–	–
12	Digital Input 1	Max +30V, 15V/3.2 mA, 24V/5 mA, and 30V/6.4 mA.	2 “Stop/CF”	133 [Digital In1 Sel]
13	Digital Input 2	A digital input (1...8) must be configured for “Enable”.	3 “Start”	134 [Digital In2 Sel]
14	Digital Input 3		11 “Jog”	135 [Digital In3 Sel]
15	Digital Input 4		1 “Enable”	136 [Digital In4 Sel]
16	Digital Input Common		<b>Important:</b> When the internal +24V DC supply (terminal 19) is used for digital inputs 1...4, you must connect the digital input common (terminal 16) to the +24V supply common (terminal 18).	–
17	Not Used		–	–
18	24V Supply Common	Common for the internal power supply.	–	–
19	Internal +24V DC Supply	Drive supplied +24V DC I/O power. Max. +20...30V, 200 mA The total current draw is the sum of encoder power, digital outputs, and any other loads that are connected to terminal 19.	–	–
20	PE ground	PE ground to drive chassis.	–	–

Table 36 - I/O Terminal Block 3 Designations



No.	Signal	Description	Factory Default	Config. Parameter
21	Analog Output 1 (+)	Max. ±10V, 5 mA.	12 “Motor Speed”	66 [Anlg Out1 Sel]
22	Analog Output 1 (-)			
23	Analog Output 2 (+)		13 “Motor Curr”	67 [Anlg Out2 Sel]
24	Analog Output 2 (-)			
25	Digital Output Common		–	–
26	Digital Output 1	Max. +30V, 50 mA	5 “Ready”	145 [Digital Out1 Sel]
27	Digital Output 2		9 “Fault”	146 [Digital Out2 Sel]
28	Digital Output 3		2 “Spd Thresh”	147 [Digital Out3 Sel]
29	Digital Output 4		4 “CurrentLimit”	148 [Digital Out4 Sel]
30	Digital Output +24V DC Source	Tie point for the internal supply or customer supplied voltage for the digital outputs. See the for sourcing digital outputs on page 87 for more information. Max. +30V DC, 80 mA. <b>Important:</b> When the internal +24V DC supply (terminal 19) is used for digital outputs 1...4, you must connect terminal 19 to terminal 30 and the digital output common (terminal 25) to the +24V supply common (terminal 18).	–	–

Table 37 - I/O Terminal Block 4 Designations



No.	Signal	Description	Factory Default	Config. Parameter
31	Digital Input 5	Max +30V, 15V/3.2 mA, 24V/5 mA, and 30V/6.4 mA.	17 “Speed Sel 1”	137 [Digital In5 Sel]
32	Digital Input 6	A digital input (1...8) must be configured for “Enable”.	18 “Speed Sel 2”	138 [Digital In6 Sel]
33	Digital Input 7		19 “Speed Sel 3”	139 [Digital In7 Sel]
34	Digital Input 8		31 “Contactor”	140 [Digital In8 Sel]
35	Digital Input Common		<b>Important:</b> When the internal +24V DC supply (terminal 19) is used for digital inputs 5...8, you must connect the digital input common (terminal 35) to the +24V supply common (terminal 18).	–
36	Not Used		–	–
...				
40				



Table 38 - I/O Wiring Examples

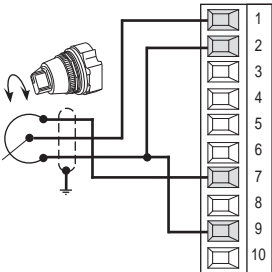
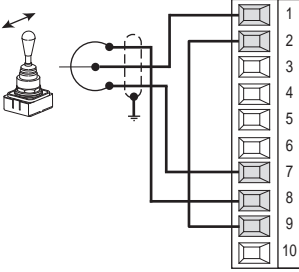
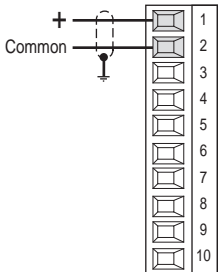
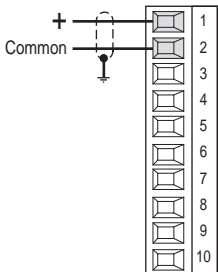
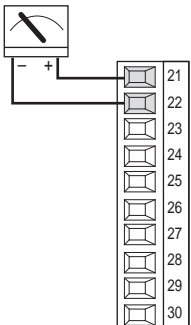
Input/Output	Connection Example	Required Parameter Changes
<p><b>Potentiometer Unipolar Speed Reference</b>                      10 k<math>\Omega</math> Pot. Recommended                      (2 k<math>\Omega</math> Minimum)</p>		<ul style="list-style-type: none"> <li>Adjust Scaling: 72 [Anlg In1 Scale] and 73 [Anlg1 Tune Scale]</li> <li>View Signal Value: 1404 [Analog In1 Value]</li> <li>View Signal Output: 385 [Speed Ref Out]</li> </ul> <p>Verify that DIP switch S9 is set to "On" (0...10V). See <a href="#">Table 27</a> on page 55.</p>
<p><b>Joystick Bipolar Speed Reference</b>  <math>\pm</math>10V Input</p> <p><b>Important:</b> See the Attention statement on page 82 for important bipolar wiring information.</p>		<ul style="list-style-type: none"> <li>Set Direction Mode: 1322 [Direction Mode] = 1 "Bipolar"</li> <li>Adjust Scaling: 72 [Anlg In1 Scale] and 73 [Anlg1 Tune Scale]</li> <li>View Signal Value: 1404 [Analog In1 Value]</li> <li>View Signal Output: 385 [Speed Ref Out]</li> </ul> <p>Verify that DIP switch S9 is set to "On" (0...10V). See <a href="#">Table 27</a> on page 55.</p>
<p><b>Analog Input Bipolar Speed Reference</b>  <math>\pm</math>10V Input</p> <p><b>Important:</b> See the Attention statement on page 82 for important bipolar wiring information.</p>		<ul style="list-style-type: none"> <li>Set Direction Mode: 1322 [Direction Mode] = 1 "Bipolar"</li> <li>Adjust Scaling: 72 [Anlg In1 Scale] and 73 [Anlg1 Tune Scale]</li> <li>View Signal Value: 1404 [Analog In1 Value]</li> <li>View Signal Output: 385 [Speed Ref Out]</li> </ul> <p>Verify that DIP switch S9 is set to "On" (0...10V). See <a href="#">Table 27</a> on page 55.</p>
<p><b>Analog Input Unipolar Speed Reference</b>                      0...10V Input, or                      0...20 mA or 4...20 mA</p>		<ul style="list-style-type: none"> <li>Configure for Voltage or Current: 71 [Anlg In1 Config]</li> <li>Adjust Scaling: 72 [Anlg In1 Scale] and 73 [Anlg1 Tune Scale]</li> <li>View Signal Value: 1404 [Analog In1 Value]</li> <li>View Signal Output: 385 [Speed Ref Out]</li> </ul> <p>Verify that DIP switch S9 is set to "On" for 0...10V operation, or "Off" for 0...20 mA or 4...20 mA operation. See <a href="#">Table 27</a> on page 55.</p>
<p><b>Analog Output Bipolar Signal</b>  <math>\pm</math>10V Bipolar (based on the signal of the assigned input source - for example Analog Input 1), or                      0...10V Unipolar (<i>shown</i>)</p>		<ul style="list-style-type: none"> <li>Select Source Value: 66 [Anlg Out1 Sel]</li> <li>Adjust Scaling: 62 [Anlg Out1 Scale]</li> </ul>

Table 38 - I/O Wiring Examples (continued)

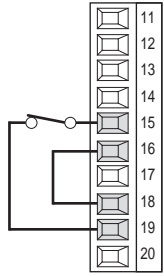
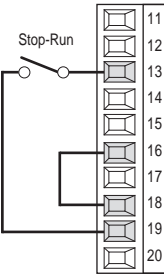
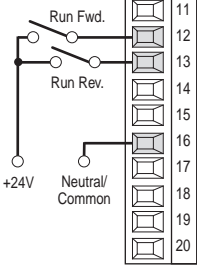
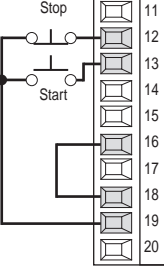
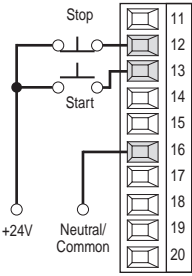
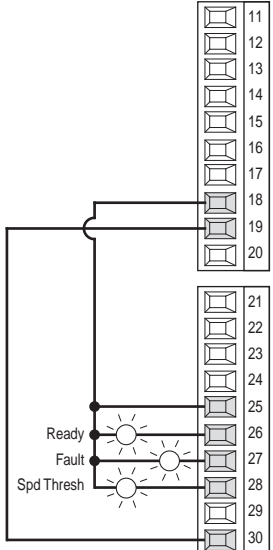
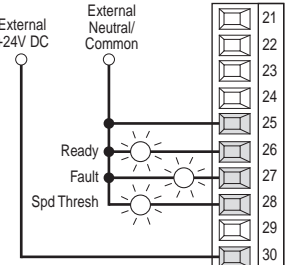
Input/Output	Connection Example	Required Parameter Changes
<p><b>Enable Input</b> 24V DC internal supply</p>		<ul style="list-style-type: none"> <li>No Changes Required.</li> </ul> <p>If the digital input used for "Enable" is changed from the default setting of digital input 4, the wiring must be changed accordingly.</p>
<p><b>2-Wire Control Non-Reversing</b> 24V DC internal supply</p> <p><b>Important:</b> Programming inputs for 2-wire control deactivates the HIM Start and Jog buttons.</p>		<ul style="list-style-type: none"> <li>Disable Digital Input 1: 133 [Digital In1 Sel] = 0 "Not Used"</li> <li>Set Digital Input 2: 134 [Digital In2 Sel] = 5 "Run"</li> </ul>
<p><b>2-Wire Control Reversing</b> 24V DC external supply</p> <p><b>Important:</b> Programming inputs for 2-wire control deactivates the HIM Start and Jog buttons.</p>		<ul style="list-style-type: none"> <li>Set Digital Input 1: 133 [Digital In1 Sel] = 6 "Run Forward"</li> <li>Set Digital Input 2: 134 [Digital In2 Sel] = 7 "Run Reverse"</li> </ul>
<p><b>3-Wire Control</b> 24V DC internal supply</p>		<ul style="list-style-type: none"> <li>No Changes Required.</li> </ul>

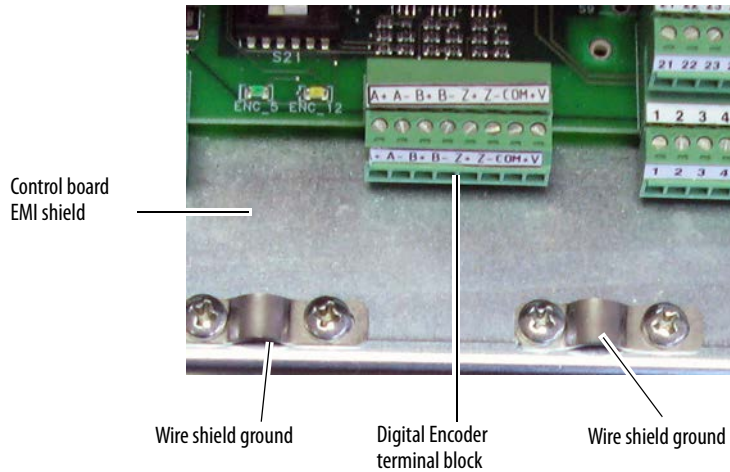
Table 38 - I/O Wiring Examples (continued)

Input/Output	Connection Example	Required Parameter Changes
<p><b>3-Wire Control</b>                      24V DC external supply                      Requires 3-wire functions only ([Digital In1 Sel]).                      Configuring 2-wire selections causes a type 2 alarm (see page <a href="#">228</a>).</p>		<ul style="list-style-type: none"> <li>No Changes Required</li> </ul>
<p><b>Sourcing Digital Outputs</b>                      Internal 24V DC supply</p>		<ul style="list-style-type: none"> <li>No Changes Required</li> </ul>
<p><b>Sourcing Digital Outputs</b>                      External 24V DC supply</p>		<ul style="list-style-type: none"> <li>No Changes Required</li> </ul>

## Digital Encoder Terminal Block

Always connect the encoder connection cables directly to the terminals on the encoder terminal block. The encoder cable must be composed of twisted pairs with the shield connected to the shield ground on the drive side. Do not connect the shield to ground on the motor side. In some cases (for example, cable lengths that exceed 100 meters), it may be necessary to ground the shield of each twisted pair on the power supply. See the PowerFlex Digital DC Drive Technical Data, publication [20P-TD001](#), for digital encoder specifications.

**Figure 59 - Digital Encoder Terminal Block Location**



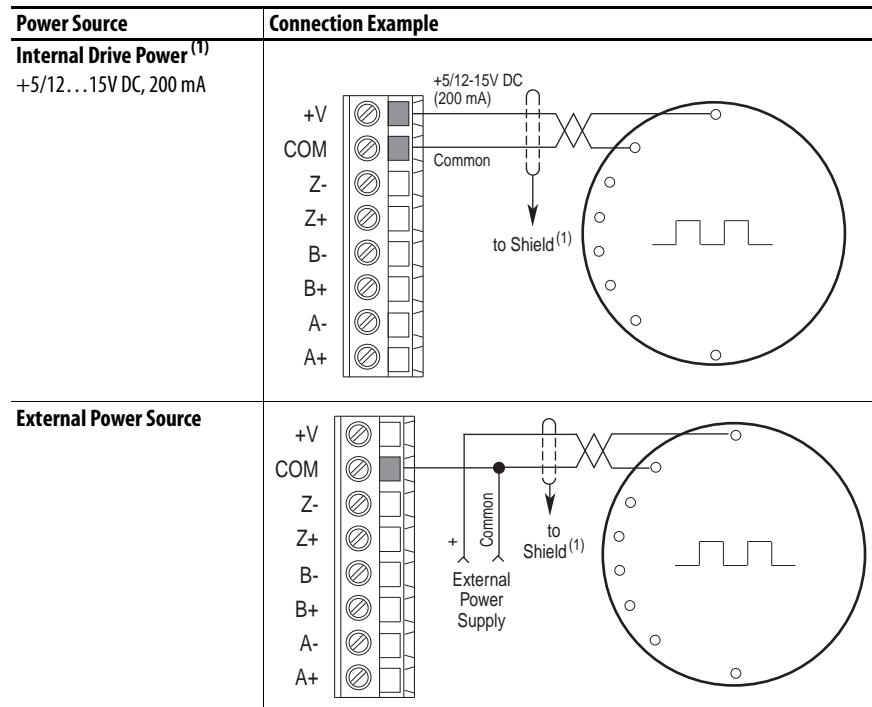
**Table 39 - Digital Encoder Terminal Designations**

Terminal Block	Label	Signal	Description
	A+	Encoder A	Single channel A or dual channel quadrature A input
	A-	Encoder A (NOT)	
	B+	Encoder B	Single channel B or dual channel quadrature B input
	B-	Encoder B (NOT)	
	Z+	Encoder Z	Pulse, marker, or registration input <sup>(2)</sup>
	Z-	Encoder Z (NOT)	
	COM	+5/12...15V <sup>(1)</sup> DC Return	Internal power common
	+V	+5/12...15V <sup>(1)</sup> DC Power	Internal power source 200 mA

(1) Selectable via switch S21 on the control board. See [Table 27](#) on page 78.

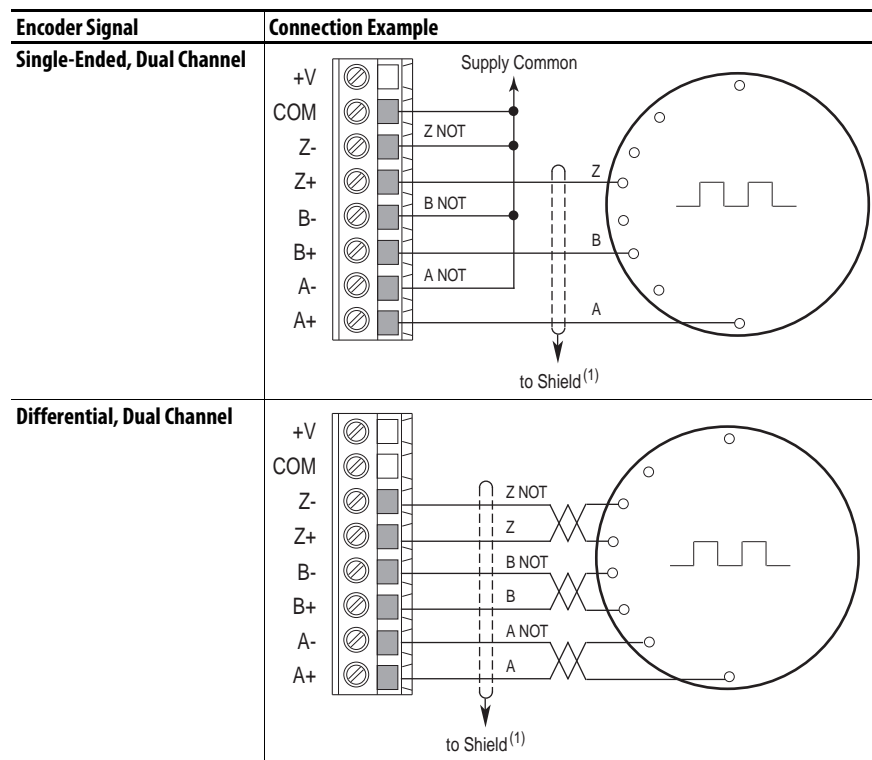
(2) Selectable via switch S20 on the control board. See [Table 27](#) on page 78.

**Figure 60 - Sample Encoder Power Wiring**



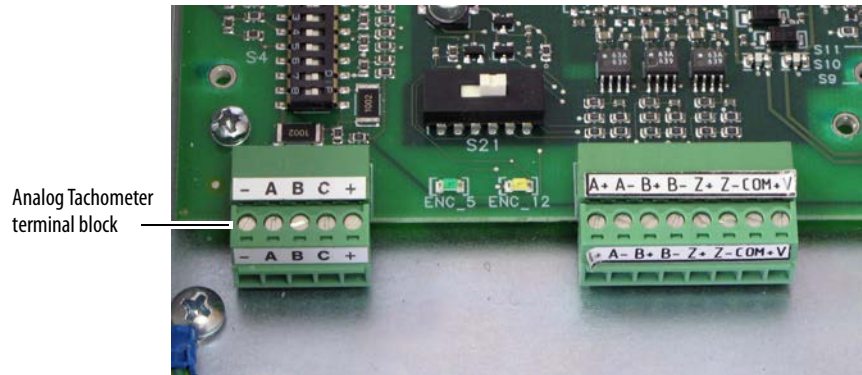
(1) Shield connection is on drive control board EMI shield. See [Figure 59](#) on page 88.

**Figure 61 - Sample Encoder Signal Wiring**



## DC Analog Tachometer Terminal Block

Figure 62 - Analog Tachometer Terminal Block Location



See the PowerFlex Digital DC Drive Technical Data, publication [20P-TD001](#), for DC analog tachometer specifications.



**ATTENTION:** The drive can overspeed if DIP switch S4 is set incorrectly, or the tachometer is wired incorrectly. Failure to observe this precaution could result in damage to, or destruction of, the equipment.

Table 40 - DC Analog Tachometer Terminal Designations

	Label	Signal	Description
	-	Negative input	-
	A	(Not Used)	
	B		
	C		
	+	Positive input See Verify Motor Rotation and Run Feedback Polarity Checks on page 104 for information on how to determine feedback polarity.	22.7 / 45.4 / 90.7 / 181.6 / 302.9V <sup>(1)</sup> 8 mA max. current

(1) Maximum voltage depends on the configuration of DIP switch S4. See DC Analog Tachometer DIP Switch S4 Example on page 79.

## Resolver Feedback Module

The resolver feedback module (catalog number 20P-RES-A0), which provides a drive interface to a selection of compatible resolvers, must be ordered and purchased separately from the drive. The resolver option module includes the PowerFlex DC Drive Resolver Feedback Module Installation Instructions, publication [20P-IN071](#), which provides installation and wiring information. See Resolver Type Selection on page [329](#) for more information on compatible resolvers.

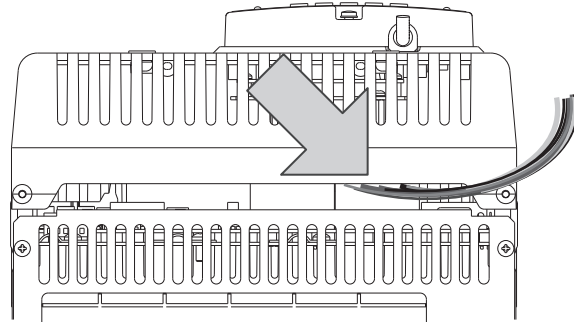
## I/O and Control Wire Routing

Follow the guidance in this section to route all I/O and control wires when the protective covers are installed.

### Frames A...C

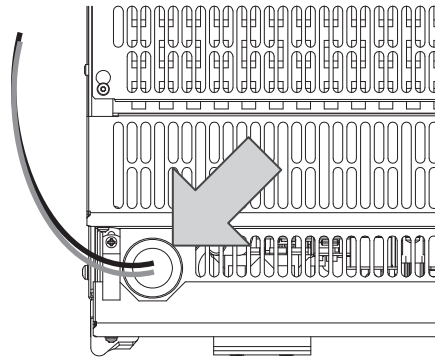
Route all I/O and control wires from the bottom of the drive, between the lower front cover and the metal (frame A) or plastic (frames B and C) terminal cover.

#### Frame A

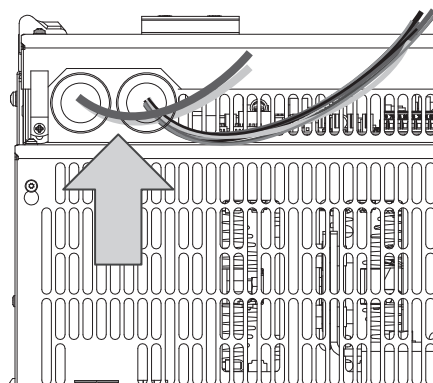


#### Frame D

Route the field control power input cables through the opening at the top left side of the control panel.



Route I/O and control cables through the opening at the bottom left side of the control panel.



**Notes:**



## Drive Start Up

This chapter describes how to start up the PowerFlex® DC drive. If you use the LCD HIM (Human Interface Module) to commission the drive, it is recommended that you read the HIM Overview on page [281](#) before performing these procedures.



**ATTENTION:** Power must be applied to the drive to perform the following start-up procedure. Some of the voltages present are at incoming line potential. To avoid electric shock hazard or damage to equipment, allow only qualified service personnel to perform the following procedure. Thoroughly read and understand the procedure before beginning. If an event does not occur while performing this procedure, **Do Not Proceed. Remove Power** including user supplied control voltages. Correct the malfunction before continuing.

**IMPORTANT** It is recommended that you uncouple the motor from all loads, until otherwise directed.

### Drive Start Up Checklist

This checklist contains the major steps that are required to commission the drive.

- Verify all Drive Configuration Settings - [page 94](#).
- Verify the Power Wiring - [page 94](#).
- Verify the Control and I/O Wiring - [page 94](#).
- Apply Voltage to the Control Circuits - [page 95](#).
- Verify the Control Voltages - [page 96](#).
- Load the Default Settings - [page 97](#).
- Configure the Most Commonly Used Parameters - [page 97](#).
- Tune the Current Regulator - [page 102](#).
- Verify Motor Rotation and Run Feedback Polarity Checks - [page 104](#).
- Configure the Speed Feedback Parameters - [page 107](#).
- Tune the Speed Regulator - [page 109](#).
- Verify Speed Reference Settings and Drive Operation - [page 111](#).

## Before Applying Power to the Drive

Complete these procedures before you apply power to the drive.

### Verify all Drive Configuration Settings

1. With the bottom cover removed from the drive (see Remove the Drive Covers on page [28](#)), verify that DIP switch S14 is set correctly. When the internal single-phase field controller is used, the switch setting must be greater than, or equal to, the rated field current that is specified on the motor nameplate. See [Table 16](#) on page [62](#).
2. Verify all switch settings (S9, S10, and S11) for the analog inputs. See [Table 27](#) on page [78](#).
3. Verify all DIP switch and jumper settings for the digital encoder or analog tachometer. See [Table 27](#) on page [78](#) and [Figure 56](#) on page [79](#).



**ATTENTION:** The Drive can overspeed if DIP switch S4 is set incorrectly, or the tachometer is wired incorrectly. Failure to observe this precaution could result in damage to, or destruction of, the equipment.

---

### Verify the Power Wiring

- Verify that the AC line power at the disconnect device is within the rated value of the drive and that all power wiring is correct. See Power Wiring on page [45](#) for further information.



**ATTENTION:** Do not connect any external power to the armature output terminals, personal injury and/or equipment damage can occur.

---

### Verify the Control and I/O Wiring

1. Verify that control power and I/O wiring is correct. A digital input (1...8 only) must be wired and configured as a drive enable. See Control Circuit Input Power on page [67](#) and I/O Wiring on page [82](#) for further information.
2. If you are using a PTC thermistor or thermal switch to protect the motor from overloading, remove the 1 k $\Omega$  resistor between terminals 78 and 79. See Thermistors and Thermal Switches on page [64](#)

## Apply Power to the Drive

The remainder of the “Drive Start Up” procedure in this manual uses a HIM to configure and autotune the drive.

You can use the DriveTools™ SP (v4.01 or later) or Connected Components Workbench™ (v10 or later) software to program drive parameters. A drive “Start Up” wizard (basic application configuration only) is available with Connected Components Workbench software. You must use DriveTools SP with a PowerFlex DC drive specific software patch. The software patch can be downloaded from the Product Compatibility and Download Center at: <https://compatibility.rockwellautomation.com/Pages/home.aspx>

If an operator interface is not available, use a remote device to start up the drive. For information on how to use the HIM, see the HIM Overview on page [281](#).

---

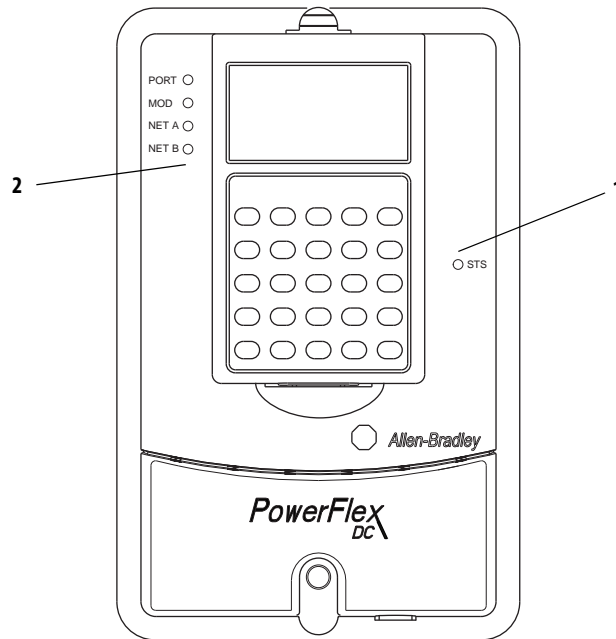
**IMPORTANT** When power is first applied, the HIM can require approximately 5 seconds until commands are recognized (including the Stop key).

---

## Apply Voltage to the Control Circuits

1. Apply power to the control circuits (terminals U2 and V2) of the drive.
2. If any of the digital inputs are configured to “Stop/CF” (CF = Clear Fault), “Enable” or “Aux Fault,” verify that signals are present or reconfigure [Digital Inx Sel]. If a fault code displays, see Chapter 4 - Troubleshooting on page [219](#).
3. If the STS LED is not currently flashing green, see [Figure 63](#) on page [96](#).

Figure 63 - Drive Status Indicators



#	Name	Color	State	Description
1	STS (Status)	Green	Flashing	Drive ready, but not running and no faults are present.
			Steady	Drive running, no faults are present.
		Yellow	Flashing, Drive Stopped	A condition exists that is preventing the drive from starting. Check parameters 1403 [Start Inhibits] and/or 1380 [Drive Alarm 1].
			Flashing, Drive Running	An intermittent type 1 alarm condition is occurring. Check parameter 1380 [Drive Alarm 1]. See Fault Descriptions on page 222 and/or Alarm Descriptions on page 228.
			Steady, Drive Running	A continuous type 1 alarm condition exists. Check parameter 1380 [Drive Alarm 1]. See Fault Descriptions on page 222 and/or Alarm Descriptions on page 228.
		Red	Flashing	A fault has occurred. Check [Fault x Code] or view the Fault Queue on the HIM. See Fault Descriptions on page 222.
Steady	A non-resettable, non-configurable fault has occurred. Check [Fault x Code] or view the Fault Queue on the HIM. See Fault Descriptions on page 222.			
2	PORT	See the Communication Adapter User Manual.		Status of DPI port internal communications (if present).
	MOD			Status of communications module (when installed).
	NET A			Status of network (if connected).
	NET B			Status of secondary network (if connected).

### Verify the Control Voltages

Verify that the following voltages are present at I/O terminal block 1 and 2. See I/O Signal and Control Wiring on page 83:

Terminal Number...	Voltage	To Terminal Number...
7	+10V	9
8	-10V	9
19	24...30V	18

## Load the Default Settings

It is recommended that you reset the drive to the default settings. By resetting the drive to the default settings, any previous parameter modifications you have made are overwritten.

1. On the HIM, from the “Main” menu scroll to the “Memory Storage” menu.
2. Press Enter.
3. Scroll to “Reset To Defaults” and press Enter.\
4. A message displays to verify that you want to reset the drive to the factory settings.
5. Press Enter.

A “Params Defaulted” (F48) entry is made in the drive Fault Queue to indicate the change.

## Configure the Most Commonly Used Parameters

If your application only requires basic drive parameter setup, you can use the S.M.A.R.T. list screen available on the HIM to program the drive. See Using the S.M.A.R.T. List Screen on page [283](#) for more information.

---

**IMPORTANT** To access all parameters in this procedure, you must set the Parameter View option to “Advanced”.

---

1. At the Main menu, scroll to the Parameter option.
2. Press ALT and then Sel.
3. Scroll to the Numbered List option.
4. Press Enter.
5. Type 211.
6. Press Enter.
7. Press Sel.
8. Type 1.
9. Press Enter.
10. Press Esc.
11. Press ALT and then Sel.
12. Scroll to the File-Group-Par option.
13. Press Enter.
14. Scroll to the “Motor Control” file.
15. Press Enter.

16. With the “Motor Data” group selected, press Enter.

17. Configure the following parameters:

Parameters 45 [Max Ref Speed] and 162 [Max Feedback Spd] are typically set to the motor nameplate base speed. However, if a speed feedback device is used (encoder or tachometer), see Drive Reference and Feedback Scaling on page [296](#) for details on setting these parameters.

- 45 [Max Ref Speed] - Enter the motor nameplate base speed.
- 162 [Max Feedback Spd] - Enter the motor nameplate base speed.
- 175 [Rated Motor Volt] - Enter the rated motor nameplate armature voltage. This value is the measured armature voltage when the motor is running at base speed with rated field current. This value also represents 100% of the rated armature voltage when field weakening is not used. If field weakening is used, set this value to 90% of the rated armature voltage. This prevents a possible overvoltage condition when the drive transitions to the field weakening mode.
- 179 [Nom Mtr Arm Amps] - Enter the rated motor nameplate armature current. To prevent current scaling/resolution issues, the drive size cannot exceed the motor size (as set by Par 179) by more than three times. The drive size is set at the factory with DIP switch S15 and is displayed in Par 465 [Drive Size].
- 374 [Drv Fld Brdg Cur] - Configure this parameter to the appropriate setting based on your application:
  - When the drive internal, single-phase field controller is used, enter the rated current of the field bridge regulator to match the value set by using the DIP switch S14.
  - When a drive and a permanent magnet motor is used, leave Par 374 and DIP switch S14 set to the factory default values.
  - When the external, three-phase field controller of the PowerFlex DC field controller is used, set Par 374 to rated field current specified on the motor nameplate.

See Field Current Configuration on page [61](#) for more information.

- 280 [Nom Mtr Fld Amps] - Configure this parameter to the appropriate setting based on your application:
  - When the drive internal, single-phase field controller is used, enter rated motor nameplate field current.
  - When a permanent magnet motor is used, leave this parameter set to the default value.
  - When the external, three-phase field controller of the PowerFlex DC field controller is used, set Par 280 equal to Par 374.

18. Access the “Field Config” group.

19. Configure the following parameters:

- If the motor field power is supplied by an external source, set Par 497 [Field Reg Enable] = 0 “Disabled”. Otherwise, verify that this parameter is set to 1 “Enabled” (default). Leave set to the default value when a permanent magnet motor is used.
- If you are utilizing field economy, set Par 1407 [Field Econ Delay] to the desired amount of time to elapse after the drive stops or reaches zero speed before field economy becomes active. The default value is 300 seconds. The minimum field current (value of field economy) is set in Par 468 [Min Fld Curr Pct]. Leave Par 1407 set to the default value when a permanent magnet motor is used.
- Par 469 [Field Mode Sel] - select the desired field mode (default = 0 “Base Speed”, constant field current):
  - 1 “Field Weaken”, field weakening mode
  - 2 “External”, power to the field is supplied externally
  - 3 “PM External”, a permanent magnet motor creates an external field
  - 4 “Wired FC FW”, field weakening mode and an analog I/O connection to a PowerFlex DC field controller
  - 5 “Fiber FC FW”, field weakening mode and a digital I/O connection to a PowerFlex DC field controller
  - 6 “Wired FC BS”, base speed and an analog I/O connection to a PowerFlex DC field controller
  - 7 “Fiber FC BS”, base speed and a digital I/O connection to a PowerFlex DC field controller
- If you are utilizing field economy at zero speed, set 468 [Min Fld Curr Pct] to the desired minimum field current for field economy (default = 30%). Leave set to the default value when a permanent magnet motor is used.
- If you are operating the drive in field weakening mode, set Par 456 [Fld Weaken Ratio] = Motor nameplate base speed / Par 45 [Max Ref Speed] x 100. Leave set to the default value when a permanent magnet motor is used.

---

**IMPORTANT** When operating the drive in field weakening mode, it is necessary to refer to the CEMF value or to the crossover data. If the maximum field current is not within 10% of the maximum value of the internal field converter, configure the current feedback by using DIP switch S14. See Field Current Configuration on page [61](#).

---

20. Access the “Utility” file.
21. Press Enter.
22. Access the “Alarms” group.
23. Configure the following parameters:
  - ❑ Par 481 [UnderVolt Thresh] - Enter the value at which the drive detects an AC under voltage condition. The default value is 200V on a 240V AC line and 400V on a 480V AC line. Typically, this value is approximately 85% of the nominal AC line voltage.
  - ❑ Par 584 [OverCurrent Thr] - Enter the value at which a drive over current condition is detected (default = 175%). Set the threshold level at least 10% above the selected operating current limit (Par 7 [Current Limit]).
24. Par 585 [OverSpeed Val] - Enter a value that is 10% above the maximum speed that the motor achieves. Typically 10% higher than Par 162 [Max Feedback Spd].
25. Access the “Input & Output” file.
26. Press Enter.
27. Access the “Analog Inputs” group.
28. Configure the following:
  - ❑ If you have connected a potentiometer to analog input 1 for a speed reference:
    - Verify that Par 70 [Anlg In1 Sel] is set to 1 “Speed Ref A” (default).
    - Verify that switch S9 and Par 71 [Anlg In1 Config] are configured to match (voltage versus a current signal). See DIP Switch and Jumper Settings on page [77](#).
    - Set Par 72 [Anlg In1 Scale] and Par 74 [Anlg In1 Offset] appropriately.
  - ❑ If you are using the HIM on the drive cover (Port 1) for the speed reference, set Par 70 [Anlg In1 Sel] to 0 “Off”.



29. Access the “Digital Inputs” group.

30. Configure the following parameters:

- Par 1391 [ContactorControl] - Select the type of contactor that is used with the drive: 1 “Contactor” (default, AC input, or DC output contactor), 2 “Contactor+DB” (AC input or DC output contactor and dynamic brake contactor), or 0 “None”.

If you select 0 “None” for Par 1391 [ContactorControl], a “CntrCflct” alarm displays. The alarm is resolved and automatically cleared when you complete the Digital Output configuration in the next sub step.

If Par 1391 [ContactorControl] is set to 1 or 2, an Auxiliary Status contactor must be wired to a digital input (default for digital input 8).

- Par 140 [Digital In8 Sel] - If a contactor is NOT used, set to other than 31 “Contactor” (for example, 0 “Not Used”).
- If an auxiliary status contactor is wired to a digital input, set the appropriate [Digital Inx Sel] parameter to 31 “Contactor”.

31. Access the “Digital Outputs” group.

32. Configure the following parameters:

- If a contactor and a dynamic brake resistor are used:
  - Par 629 [Relay Out 2 Sel] = 24 “ContactorDB”.
- If a contactor or a dynamic brake resistor is not used:
  - Par 629 [Relay Out 2 Sel] = Set to other than 24 “ContactorDB” or 25 “Contactor” (for example, 0 “Not Used”).
  - Par 1392 [Relay Out 1 Sel] = Set to other than 24 “ContactorDB” or 25 “Contactor” (for example, 0 “Not Used”).

33. If you are using the HIM on the drive cover (Port 1) for the speed reference, complete the following steps:
- Access the “DPI Inputs” group.
  - Set Par 1323 [DPI P1 Select] to 1 “Speed Ref A”.
  - Access the “Analog Inputs” group.
  - Set Par 70 [Anlg In1 Sel] to 0 “Not Used”.
34. If you are using a source other than the HIM for the speed reference, complete the following steps:
- Select one of the parameter sources that are listed here and set it to 1 “Speed Ref A”.
    - [DPI Px Select]
    - [Anlg Inx Sel]
  - Set Par 70 [Anlg In1 Sel] to 0 “Not Used”, if appropriate.

## Tune the Current Regulator

---

**IMPORTANT** Because the field cannot be disconnected in a permanent magnet motor, tuning the current regulator, as directed, does not work. The appropriate procedure for tuning the current regulator for a permanent magnet motor is performed later in the Drive Start Up procedures. When a permanent magnet motor is used, continue with Verify Motor Rotation and Run Feedback Polarity Checks on page [104](#).

---

**IMPORTANT** If the PowerFlex DC drive is wired for two-wire control, with a digital input programmed for “Run,” the HIM Start/Stop cannot be used for autotune. Maintain the “Run” input for autotune.

---



**ATTENTION:** Do not attempt to perform the “Tune the Current Regulator” procedure with a PowerFlex DC drive and permanent magnet motor combination. Drive and/or motor damage may occur.



**ATTENTION:** Before tuning the current regulator, you must provide a hard-wired, maintained, external operator accessible coast/stop push button to disable the machine in case of improper operation. If a means to coast/stop the drive is not provided, uncontrolled machine operation can result. Failure to observe this precaution could result in severe bodily injury or loss of life.



**ATTENTION:** Current regulator tuning may cause unintentional motor rotation or incorrect speed references that can damage connected equipment. Before tuning the current regulator, uncouple the motor from equipment.

---

Complete this test before running the drive for the first time. Upon completing this tuning procedure, the armature resistance value is stored in Par 453 [Arm Resistance] and the armature inductance value is stored in Par 454 [Arm Inductance].

1. If an external supply is used to power the motor field, disconnect the wires from the motor field terminals. If the drive supplies power to the motor field, the internal field circuit is automatically disabled during this test.

---

**IMPORTANT** Verify that the motor does not start rotating (less than one-half a full turn) during the Current Regulator tuning test (due to remnant magnetization, series field, and so forth). If necessary, mechanically block the motor shaft so it does not turn.

---

2. Access the “Motor Control” file and the “Torq Attributes” group.
3. Set Par 7 [Current Limit] to the appropriate level for your application. This parameter defaults to 150%. The drive armature output current corresponds to Par 179 [Nom Mtr Arm Amps] x Par 7 [Current Limit].

Par 8 [Current Lim Pos] is the drive current limit for the positive direction. Par 9 [Current Lim Neg] is the drive current limit for the negative direction. These parameters are set to 150% by default. If necessary, you can change the value of these parameters to suit your application.

4. Access the “Speed Feedback” group.
5. Verify that Par 414 [Fdbk Device Type] is set to 3 “Armature” (default).
6. Press the Esc key until you return to the “File” menu.
7. Access Par 452 [CurrReg Autotune] in the “Autotune” group, in the “Motor Control” file, and select 1 “On.”
8. Press Enter.
9. The HIM displays “Ready for RL.”
10. Press the Start button on the HIM.

The current regulator auto tuning test starts, which could take several minutes.

---

**IMPORTANT** Programming inputs for 2-wire control deactivates the HIM start and jog buttons.

---

At the end of the test, Par 453 [Arm Resistance] and Par 454 [Arm Inductance] are updated. The drive is automatically stopped and Par 452 [CurrReg Autotune] is set to 0 “Off”.

It is also possible to tune the current regulator manually (other than permanent magnet motors). See Manually Adjusting the Current Regulator Tune Settings on page [350](#) for more information.

If a drive fault occurs during the tuning procedure, see the list of Fault Descriptions that starts on page [222](#) for possible causes and actions.

## Verify Motor Rotation and Run Feedback Polarity Checks

The jog function (on the HIM or terminal block) is used to check motor direction and encoder/resolver operation. If the STS LED is not currently flashing green, see [Figure 63](#) on page 96 for more information.



**ATTENTION:** Before running the motor direction and polarity checks, you must provide a hard-wired, maintained, external operator accessible coast/stop push button to disable the machine in case of improper operation. If a means to coast/stop the drive is not provided, uncontrolled machine operation can result. Failure to observe this precaution could result in severe bodily injury or loss of life.

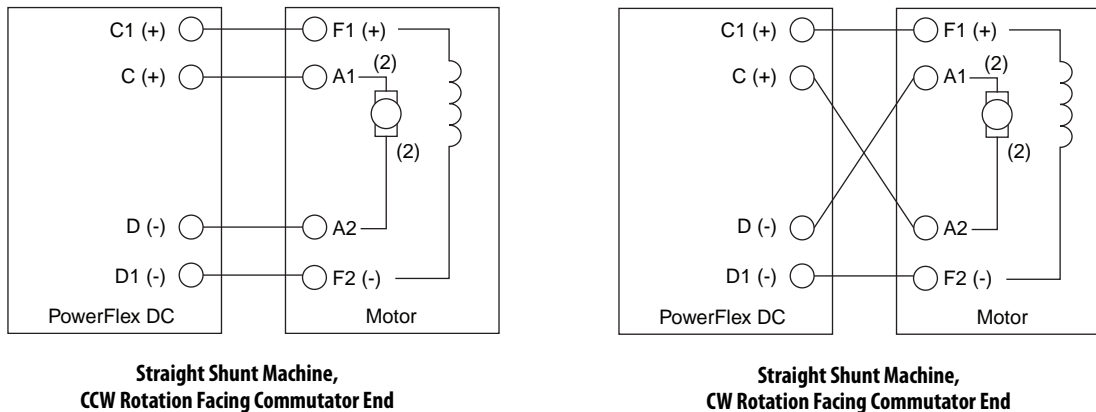


**ATTENTION:** The motor direction and polarity checks may cause unintentional motor rotation or incorrect speed references that can damage connected equipment. Before tuning the motor direction and polarity checks, uncouple the motor from equipment.

1. When the motor polarity check is run, power is applied to the drive and the motor rotates. Verify that the motor is uncoupled from the load. If the motor cannot be uncoupled from the load, the following motor checks are recommended.
  - All electrical connections are tight.
  - The brushes are properly seated.
  - The motor shaft is free to rotate.
2. Access the “Motor Control” file, “Speed Feedback” group.
3. Verify that Par 414 [Fdbk Device Type] is set to 3 “Armature” (default).
4. Access the “Speed Command” file, “Discrete Speeds” group.
5. Verify that Par 266 [Jog Speed] is set to the default value (100 rpm) or to an acceptable speed level for this test.
6. If analog input 1 is wired, access the “Analog Inputs” group, and verify that the voltage level is 0V in Par 1404 [Analog In1 Value].
7. View Par 233 [Output Voltage], assert a Jog command (via the HIM keypad or digital input on the I/O terminal block), and observe the motor rotation direction.
8. Verify whether Par 233 [Output Voltage] is positive.
9. If the observed rotation direction is correct, continue with [step 15](#) on page [105](#). If the observed rotation direction is incorrect, continue with [step 10](#), while referring to the motor connection diagrams in [Figure 64](#) on page [105](#).
10. Remove power from the drive.
11. Verify that power is turned off and locked out.

12. Switch the armature leads connected to C (+) and D (-).

Figure 64 - Motor Connections



13. Apply power to the drive.
14. Repeat [step 6](#)... step 9 on page [104](#). When the motor rotation direction is correct, continue with [step 15](#).
15. Complete the appropriate procedure for the type of feedback device that is used for the application:
- For armature voltage feedback - Continue with [step 16](#).
  - For analog tachometer feedback, assert a Jog command and verify that the sign and value of Par 1408 [Tachometer Speed] corresponds with the actual direction of the motor. If the sign and value of Par 1408 [Tachometer Speed] and the motor direction do not correspond, remove power from the drive and reverse the tachometer connections at the drive. Verify proper motor rotation and continue with [step 16](#).
  - For encoder feedback, assert a Jog command and verify that the sign and value of Par 420 [Encoder Speed] correspond with the actual direction of the motor. If the sign and value of [Par 420 [Encoder Speed]] and the motor direction do not correspond, remove power from the drive and reverse the encoder connections at the drive. Reverse the polarity of only one channel, for example, B and B NOT. See [Table 39](#) on page [88](#) for digital encoder terminal block designations. Verify proper motor rotation and continue with [step 16](#).
  - For resolver feedback, assert a Jog command and verify that the sign and value of Par 428 [Resolver Speed] correspond with the actual direction of the motor. If the sign and value of Par 428 [Resolver Speed] and the motor direction do not correspond, do one of the following:
    - Change the setting of bit 5 “Resolver Dir” in Par 425 [Resolver Config]. Verify proper motor rotation and continue with [step 16](#).
    - Remove power from the drive and verify the correct resolver connections to the drive (refer to resolver installation instructions for details).

16. For permanent magnet motors only, continue with Tune the Current Regulator for a Permanent Magnet Motor on page [106](#). For all other motors, continue with Configure the Speed Feedback Parameters on page [107](#).

### *Tune the Current Regulator for a Permanent Magnet Motor*

Only complete this procedure when you are using a permanent magnet motor.



**ATTENTION:** Before tuning the current regulator, you must provide a hard-wired, maintained, external operator accessible coast/stop push button to disable the machine in case of improper operation. If a means to coast/stop the drive is not provided, uncontrolled machine operation can result. Failure to observe this precaution could result in severe bodily injury or loss of life.



**ATTENTION:** Current regulator tuning requires motor rotation and applied speed references that can damage material or process loads. Before tuning the current regulator, remove any material or process load.

1. Verify that Par 414 [Fdbk Device Type] is set to 3 “Armature” (default).
2. Set the value of Par 453 [Arm Resistance], calculated as:  
 $(\text{Par 175 [Rated Motor Volt]} / \text{Par 179 [Nom Mtr Arm Amps]}) \times 0.04$
3. Leave Par 454 [Arm Inductance] set to the default value (based on drive size).
4. Verify that there is no material or process load present and the motor shaft is free to rotate.
5. Start the drive and run the motor at approximately 50% of base speed. Observe the value of Par 587 [I Reg Err] after it has settled to a value and do one of the following.
  - If Par 587 [I Reg Err] is positive, increase the value of Par 454 [Arm Inductance]. The value of Par 587 determines the magnitude of change. Generally, make large increases (for example, double) when Par 587 is large (greater than 40) and smaller increases as Par 587 gets closer to zero.
  - If Par 587 [I Reg Err] is negative, decrease the value of Par 454 [Arm Inductance]. The value of Par 587 determines the magnitude of change. Generally, make large increases (for example, double) when Par 587 is large (greater than -40) and smaller increases as Par 587 gets closer to zero.
6. Repeat step 4 until Par 587 [I Reg Err] is as close to zero as possible. Values less than 20/-20 are acceptable as close to zero. However, with some motors, the minimum value of Par 587 may only be 60/-60. Stop the drive and continue with Configure the Speed Feedback Parameters on page [107](#).

## Configure the Speed Feedback Parameters

1. Access the “Speed Feedback” group.
2. Configure the following parameters:

If an encoder or tachometer is used, see Drive Reference and Feedback Scaling on page [296](#) for instructions on associated parameter settings.

- Par 414 [Fdbk Device Type] - Select the source for motor velocity feedback:

- 1 “Encoder”
- 2 “DC Tach”
- 3 “Armature” (default)
- 4 “Resolver”

If operating the drive in field weakening mode, Par 414 [Fdbk Device Type] must be set to 1 “Encoder”, 2 “DC Tach”, or 4 “Resolver.”

- Par 457 [Spd Fdbk Control] - If you are using an encoder, tachometer, or resolver set this parameter to 1 “Enabled” to activate speed feedback control.
- If the speed feedback source is an analog tachometer, set the fine scaling value in Par 562 [Anlg Tach Gain]. After the drive hardware conditions the value of Par 562, it is used to scale the analog tachometer feedback signal.



**ATTENTION:** The drive can overspeed if DIP switch S4 is set incorrectly, or the tachometer is wired incorrectly. Failure to observe this precaution could result in damage to the drive or process equipment. See [Table 56](#) on page [79](#).

---

- If the speed feedback source is a digital encoder, complete the following steps:
  - a. Enter the pulses per revolution from the encoder nameplate in Par 169 [Encoder PPR]. See Valid Speed Feedback Values on page [300](#) for more information on setting the value of this parameter.
  - b. Set Par 652 [Encoder Err Chk] to 1 “Enabled” to activate monitoring of the digital encoder signals (verifies the presence of the A, B, A-, B-, or Z channel signals).

Par 457 [Spd Fdbk Control] must be set to 1 “Enabled” for encoder monitoring to occur.

Switch S20 must be set correctly to prevent encoder faults. See [Table 27](#) on page [78](#).

- If the speed feedback source is a resolver, complete the following steps:
  - a. Select the type of resolver that is used in Par 423 [Reslvr Type Sel]. See Resolver Type Selection on page [329](#) for details on compatible resolver types.
  - b. Select the appropriate ratio of resolver electrical to mechanical turns in Par 424 [Reslvr Spd Ratio].
  - c. Configure the resolver to digital conversion resolution and moving average speed filter period in par 425 [Resolver Config].
  - d. Cycle power to the drive to apply these changes in the resolver board.
- 3. Access the “Speed Command” file.
- 4. Press Enter.
- 5. With the “Limits” group selected, press Enter.
- 6. Configure the following parameters:
  - Par 1 [Minimum Speed] - Enter the minimum speed reference limit.
  - Par 2 [Maximum Speed] - Enter the required maximum speed for the application. The maximum speed can be above the motor base speed if field weakening is used.
- 7. Access the “Dynamic Control” file.
- 8. Press Enter.
- 9. Access the “Ramp Rates” group and configure the following parameters:
  - Par 660 [Accel Time 1] - Set the desired acceleration ramp time.
  - Par 662 [Decel Time 1] - Set the desired deceleration ramp time.



## Tune the Speed Regulator

The speed regulator auto tuning test detects the total inertia value of the motor shaft (in  $\text{Kg}\cdot\text{m}^2$ ), the friction value (in  $\text{N}\cdot\text{m}$ ), and the calculation of the proportional (P) and integral (I) gains of the speed regulator.

---

**IMPORTANT** If upgrading a drive to firmware revision 6.001 or later (from firmware revision 5.007 or earlier) and it is not possible to perform speed regulator autotuning, see Appendix C, Manually Tuning the Speed Regulator for Firmware Revision 6.001 and Later on page [317](#) for instructions on setting the proper gains in the Speed Loop.

---



---

**IMPORTANT** This test requires the free rotation of the motor shaft and load. The auto tuning test of the speed loop cannot be conducted on machines with a limited stroke.

---



---

**IMPORTANT** If the PowerFlex DC drive is wired for two-wire control, with a digital input programmed for “Run,” the HIM Start/Stop cannot be used for autotune. Maintain the “Run” input for autotune.

---



**ATTENTION:** The motor rotates during this tuning procedure. Hazard of personal injury exists due to motor shaft rotation and/or machinery motion.

---



---

**IMPORTANT** The test is conducted by using the torque limit value set in the Par 1048 [Autotune Cur Lim] (recommended value = 20%). The torque reference is applied via a step reference (without a ramp). Therefore, there must not be any “backlash” in the mechanical transmission and it must be compatible with those operations using the torque limit value set in the Par 1048 [Autotune Cur Lim]. You can modify the torque limit value via this parameter.

---



---

**IMPORTANT** In applications where the system total inertia value is high, it is necessary to increase the value of Par 1048 [Autotune Cur Lim] to avoid “Time out” errors. The speed regulator auto tuning test of the speed loop is not suitable for drives that are used in “elevator” and/or lifting system applications.

---

1. While still in the “Autotune” group, configure the motor shaft rotation direction via Par 1029 [Speed Tune Dir], with reference to the motor commutator end.
  - 1 “Forward” = clockwise
  - 2 “Reverse” = counter-clockwise

2. Speed Regulator Autotune assumes that full field is applied. Verify that parameters 280 [Nom Mtr Fld Amps] and 467 [Max Fld Flux Pct] are set correctly. Tuning with less than full field current results in different gains because of the lower motor torque values.
3. Select Par 1027 [Spd Reg Autotune] and enter “1.”
4. Press Enter.
5. Press the Start button on the HIM. The speed regulator auto tuning test starts, which could take several minutes. When the test has been completed, the drive automatically stops.

During the test the following are completed:

- An acceleration test, with the torque limit value set in the Par 1048 [Autotune Cur Lim].
- A deceleration test, with a lower torque limit value applied, until zero speed has been reached.
- Par 1013 [Torque Const] is calculated and updated based on the entered motor data.

The test threshold speed is 33% of the lowest value set in the following parameters:

- 45 [Max Ref Speed]
- 3 [Max Speed Fwd] or 4 [Max Speed Rev] based on the rotation direction that is chosen in Par 1029 [Speed Tune Dir]

The drive determines the speed loop gains (Pars 87 [Spd Reg Kp] and 88 [Spd Reg Ki]) based on the motor and load inertia and friction characteristics.

If any faults occur during the test, see Auto Tuning Faults on page [112](#) for a description and more information.

**Note:** If any manual adjustments are required (due to vibrations, and so on), make them based on the value of the integral gain in Par 88 [Spd Reg Ki]. If the speed regulator auto tuning test does not provide satisfactory results, see Fine-Tuning the Regulators on page [349](#).

The values that result from the Speed Regulator tuning test are updated and displayed, respectively, in the parameter pairs that are listed here.

- 87 [Spd Reg Kp], 1032 [Speed Tune Kp]
- 88 [Spd Reg Ki], 1033 [Speed Tune Ki]
- 1014 [Inertia], 1030 [Spd Tune Inertia]
- 1015 [Friction], 1031 [Spd Tune Friction]

The values of Pars 1030...1033 can be used as a record of the Speed Regulator auto tuning results. This is helpful, if the values of Pars 87, 88, 1014 and 1015 are later changed.

## Verify Speed Reference Settings and Drive Operation

Verify the following speed and direction (for four quadrant drives) references of the drive under a load.



**ATTENTION:** This test requires the free rotation of the motor shaft and load. The steps in the “Drive Start Up” procedure must have been completed before completing this step.

---

1. Set the speed reference to “0” (zero) by using the assigned source (HIM or analog potentiometer). See Reference Control on page [325](#) for more information on speed reference sources.
2. View Par 385 [Speed Ref Out] and verify that the value is “0”.
3. Press the Start button on the HIM and slowly increase the speed reference until full speed is reached (viewed in Par 385 [Speed Ref Out]).
4. For only four quadrant (regenerative) drive applications, press the Direction button on the HIM and verify that the motor ramps down to “0” speed and then to full speed in the opposite direction.
5. Press the Stop button on the HIM.
6. Verify that the drive ramps to “0” speed and stops.

### Auto Tuning Faults

[Table 41](#) lists faults that can display during the speed regulator auto tuning test. In some cases, the drive control circuits can detect a value that is out of range for the configuration settings during the speed regulator auto tuning test. In these cases, make the suggested adjustments and repeat the test. If the fault occurs again, complete the Fine-Tuning the Regulators procedures on page [349](#).

**Table 41 - Speed Regulator Auto Tuning Faults**

Fault	No.	Description	Action
STune Overspeed	56	The measured motor speed is too high during the speed regulator auto tuning procedure.	Decrease the value of Par 1048 [Autotune Cur Lim] and repeat the auto tune procedure.
STune Stalled	57	The drive has stalled during the speed regulator auto tuning procedure.	Increase the value of Par 1048 [Autotune Cur Lim] and repeat the auto tune procedure.
STune LoadHi	58	One of the following has occurred:	
		<ul style="list-style-type: none"> <li>The loading torque value is too high at zero speed to complete the speed regulator auto tuning procedure.</li> <li>Par 107 [Speed Zero Level] and/or 108 [Speed Zero Delay] is set too high.</li> </ul>	Decrease the load torque, where applicable, and repeat the auto tune procedure. Set Pars 107 and 108 to their default values when performing the Speed Loop Autotuning function.
STune CurLimit	59	One of the following has occurred:	
		<ul style="list-style-type: none"> <li>The value of Par 1048 [Autotune Cur Lim] for auto tuning the speed regulator is set too high.</li> <li>Par 107 [Speed Zero Level] and/or 108 [Speed Zero Delay] is set too high.</li> </ul>	Decrease the value of Par 1048 [Autotune Cur Lim] and repeat the auto tune procedure. Set Pars 107 and 108 to their default values when performing the Speed Loop Autotuning function.
STune FrictionLo	60	The friction value that is attained during the auto tuning procedure is zero or lower than the control precision limit.	Decrease the value of Par 1048 [Autotune Cur Lim] and repeat the auto tune procedure.
STune Timeout	61	The speed regulator auto tuning procedure did not complete within the available time.	Verify the value in Par 1048 [Autotune Cur Lim]. If this value is set too low, the motor does not reach a maximum speed of 33% of the lowest value of one of these parameters: <ul style="list-style-type: none"> <li>Par 45 [Max Ref Speed]</li> <li>Par 3 [Max Speed Fwd]</li> <li>Par 4 [Max Speed Rev]</li> </ul> In this case, the test does not run. Set these values appropriately and repeat the auto tuning procedure.
STune Aborted	62	The speed regulator auto tuning procedure was manually stopped.	Informational only.

For additional regulator fine-tuning procedures, see Fine-Tuning the Regulators on page [349](#).

### *Speed-Up Function*

Oscillation can occur during a speed change with loads presenting a high moment of inertia. These oscillations can be reduced by enabling the “Speed Up” function. See Speed Up Function on page [338](#) for more information.

### *Configuring the Speed Zero Logic*

The speed zero logic is factory set to 0 “Disabled”. See Speed Zero Function on page [340](#) for more information.

### *Adaptive Speed Regulation*

The adaptive function of the speed regulator is factory set to 0 “Disabled”. Only use this function when the gain of the speed regulator must go higher than the speed range. For instructions on how to configure these parameters, see Adaptive Speed Regulator on page [335](#).

**Notes:**

## Programming and Parameters

Topic	Page
About Parameters	116
How Parameters are Organized	118
Monitor File	126
Motor Control File	131
Speed Command File	148
Dynamic Control File	155
Applications File	161
Utility File	177
Communications File	191
Input / Output File	195
Parameter Cross Reference – by Name	207
Parameter Cross Reference – by Number	213

This chapter provides a complete listing of the PowerFlex® DC drive parameters. The list contains a description, default value, minimum and maximum values, units, and data type for each drive parameter. The parameters can be viewed and edited (programmed) using a Human Interface Module (HIM). As an alternative, programming can also be performed using DriveTools™ SP<sup>(1)</sup> or Connected Components Workbench™ software<sup>(2)</sup> and a personal computer. See [Appendix B](#) for a brief description of the LCD HIM. See [Appendix D](#) for drive control block diagrams.

- (1) You must use DriveTools SP software v4.01 or later with a PowerFlex DC drive specific software patch. The software patch can be downloaded from the Product Compatibility and Download Center at: <https://compatibility.rockwellautomation.com/Pages/home.aspx>
- (2) You must use Connected Components Workbench software v2.00 or later. The software can be downloaded from <https://www.rockwellautomation.com/global/support/connected-components/workbench.page?>

## About Parameters




To configure a drive to operate in a specific way, certain parameters may need to be changed from the default value. Three types of parameters exist:



- **ENUM Parameters**  
ENUM parameters provide a selection of two or more items. The LCD HIM will display a text message for each item.
- **Bit Parameters**  
Bit parameters have individual bits associated with features or conditions. If the bit is “0”, the feature is off or the condition is false. If the bit is “1”, the feature is on or the condition is true.
- **Numeric Parameters**  
These parameters have a single numerical value and unit (for example, 0.1 Volts).

The Parameters Table Example on page [117](#) describes how each parameter type is presented in this manual.



### Parameters Table Example

1	2	3	4	5	6	7																																																			
File	Group	No.	Parameter Name & Description	Values	Data Type	Related																																																			
<b>SPEED COMMAND</b>	<b>Speed Regulator</b>	<b>388</b> 	<b>[Flying Start En]</b> Enables/Disables the ability of the drive to connect to a spinning motor at actual rpm when a start command is issued. <ul style="list-style-type: none"> <li>“Enabled” = When the drive is turned on, the speed of the motor is measured and the ramp output is set accordingly. The drive then runs at the set reference value.</li> <li>“Disabled” = When the drive is turned on, the ramp starts from zero.</li> </ul> Main uses: <ul style="list-style-type: none"> <li>To connect to a motor that is already spinning due to its load (for example, in the case of a pump, the flowing medium).</li> <li>Re-connection to a spinning motor after a fault or alarm.</li> </ul> Note: If the Flying Start function is disabled, be sure that the motor is not spinning when the drive is turned on, or harsh motor deceleration in current limit may occur.	Default: 0 = “Disabled” Options: 0 = “Disabled”, 1 = “Enabled”	16-bit Int																																																				
		<b>445</b> 	<b>[Spd Up Gain Pct]</b> The Speed Up function gain as a percentage of Par 446 [Speed Up Base].	Default: 0.00 Min/Max: 0.00 / 100.00 Units: %	Real																																																				
<b>COMMUNICATIONS</b>	<b>Masks &amp; Owners</b>	<b>591</b> 	<b>[Logic Mask]</b> Determines which ports can control the drive when Par 1377 [Write Mask Act], bit 15 is set to “1.” If the bit for a port is set to “0,” the port will have no control functions except for stop. 0 = Control Masked, 1 = Control Permitted, x = Reserved.	<table border="1" style="width: 100%; border-collapse: collapse; text-align: center;"> <thead> <tr> <th>Options</th> <th>Reserved</th> <th>Reserved</th> <th>Reserved</th> <th>Reserved</th> <th>Reserved</th> <th>Reserved</th> <th>Reserved</th> <th>Reserved</th> <th>Reserved</th> <th>Reserved</th> <th>DPI Port 5</th> <th>DPI Port 4</th> <th>DPI Port 3</th> <th>DPI Port 2</th> <th>DPI Port 1</th> <th>Digital In</th> </tr> </thead> <tbody> <tr> <td>Default</td> <td>x</td> <td>x</td> <td>x</td> <td>x</td> <td>x</td> <td>x</td> <td>x</td> <td>x</td> <td>x</td> <td>x</td> <td>0</td> <td>0</td> <td>0</td> <td>0</td> <td>1</td> <td>1</td> </tr> <tr> <td>Bit</td> <td>15</td> <td>14</td> <td>13</td> <td>12</td> <td>11</td> <td>10</td> <td>9</td> <td>8</td> <td>7</td> <td>6</td> <td>5</td> <td>4</td> <td>3</td> <td>2</td> <td>1</td> <td>0</td> </tr> </tbody> </table>	Options	Reserved	Reserved	Reserved	Reserved	Reserved	Reserved	Reserved	Reserved	Reserved	Reserved	DPI Port 5	DPI Port 4	DPI Port 3	DPI Port 2	DPI Port 1	Digital In	Default	x	x	x	x	x	x	x	x	x	x	0	0	0	0	1	1	Bit	15	14	13	12	11	10	9	8	7	6	5	4	3	2	1	0		<a href="#">1377</a>
Options	Reserved	Reserved	Reserved	Reserved	Reserved	Reserved	Reserved	Reserved	Reserved	Reserved	DPI Port 5	DPI Port 4	DPI Port 3	DPI Port 2	DPI Port 1	Digital In																																									
Default	x	x	x	x	x	x	x	x	x	x	0	0	0	0	1	1																																									
Bit	15	14	13	12	11	10	9	8	7	6	5	4	3	2	1	0																																									

No.	Description						
1	<b>File</b> – Lists the major parameter file category.						
2	<b>Group</b> – Lists the parameter group within a file.						
3	No. – Parameter number.  = The parameter is only accessible when Par 211 [Param Access Lvl] = 1 “Advanced”.  = The parameter value cannot be changed until the drive is stopped.						
4	<b>Parameter Name &amp; Description</b> – Parameter name as it appears on an LCD HIM, with a brief description of the parameters function.						
5	<b>Values</b> – Defines the various operating characteristics of the parameter. Three types exist. <table border="1" style="width: 100%; border-collapse: collapse;"> <tr> <td style="width: 15%;"><b>ENUM</b></td> <td style="width: 15%;">                         Default: Lists the value assigned at the factory. “Read Only” indicates that the parameter is not configurable.                          Options: Displays the programming selections available.                     </td> </tr> <tr> <td><b>Bit</b></td> <td>                         Options: Bit name.                          Default: Default setting.                          Bit: Lists the bit place holder and definition for each bit.                     </td> </tr> <tr> <td><b>Numeric</b></td> <td>                         Default: Lists the value assigned at the factory. “Read Only” indicates that the parameter is not configurable.                          Min/Max: The range (lowest and highest setting) possible for the parameter.                          Units: Unit of measure and resolution as shown on the LCD HIM.  <b>Important:</b> Some parameters will have two unit values:                          • For example: Analog inputs can be set for current or voltage as with Par 71 [Anlg Inx Config].                     </td> </tr> </table>	<b>ENUM</b>	Default: Lists the value assigned at the factory. “Read Only” indicates that the parameter is not configurable. Options: Displays the programming selections available.	<b>Bit</b>	Options: Bit name. Default: Default setting. Bit: Lists the bit place holder and definition for each bit.	<b>Numeric</b>	Default: Lists the value assigned at the factory. “Read Only” indicates that the parameter is not configurable. Min/Max: The range (lowest and highest setting) possible for the parameter. Units: Unit of measure and resolution as shown on the LCD HIM. <b>Important:</b> Some parameters will have two unit values: • For example: Analog inputs can be set for current or voltage as with Par 71 [Anlg Inx Config].
<b>ENUM</b>	Default: Lists the value assigned at the factory. “Read Only” indicates that the parameter is not configurable. Options: Displays the programming selections available.						
<b>Bit</b>	Options: Bit name. Default: Default setting. Bit: Lists the bit place holder and definition for each bit.						
<b>Numeric</b>	Default: Lists the value assigned at the factory. “Read Only” indicates that the parameter is not configurable. Min/Max: The range (lowest and highest setting) possible for the parameter. Units: Unit of measure and resolution as shown on the LCD HIM. <b>Important:</b> Some parameters will have two unit values: • For example: Analog inputs can be set for current or voltage as with Par 71 [Anlg Inx Config].						
6	<b>Data Type</b> - Identifies the parameter data type (i.e. integer, real).						
7	<b>Related</b> – Lists parameters (if any) that interact with the selected parameter.						

## How Parameters are Organized

The LCD HIM displays parameters in a **File–Group–Parameter** or **Numbered List** view order. To switch display mode, access the Main Menu, press ALT, then Sel (View) while the cursor is on the Parameter menu selection. In addition, using Par 211 [[Param Access Lvl](#)], you have the option to display the most commonly used parameters (Basic Parameter view) or all parameters (Advanced Parameter View).

### File–Group–Parameter Order

This simplifies programming by grouping parameters that are used for similar functions. The parameters are organized into files. Each file is divided into groups, and each parameter is an element in a group. By default, the LCD HIM displays parameters by File–Group–Parameter view.

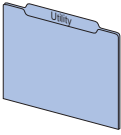
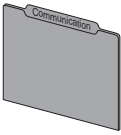
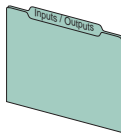
### Numbered List View

All parameters are in numerical order.

### Cross Reference Tables

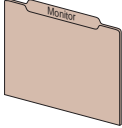
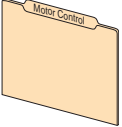
See Parameter Cross Reference – by Name on page [207](#) and Parameter Cross Reference – by Number on page [213](#) for a list of parameters and page numbers.

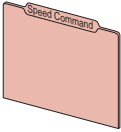
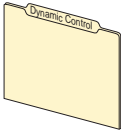


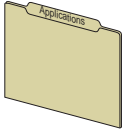
File	Group	Parameters					
 Utility	<b>Reference Config</b>	[Direction Mode]	1322	[Man Ref Preload]	210	[MOP Select]	1375
		[Save HIM Ref]	209	[MOP Ref Config]	249		
	<b>Drive Memory</b>	[Param Access Lvl]	211	[Reset Defaults]	258	[Language]	302
	<b>Diagnostics</b>	[Drive Status 1]	381	[Last Stop Source]	1402	[At Zero Speed]	395
		[Drive Status 2]	382	[Start Inhibits]	1403	[CurrLimit Active]	349
		[Speed Ref Source]	1329	[Drive Logic Rslt]	1328	[Spd Limit Active]	372
[Spd Ref Sel Sts]		1330	[At Speed]	394			
<b>Faults</b>	[Clear Fault Que]	263	[Status2 at Fault]	1350	[Fault Voltage]	1374	
	[Fault Clear]	1347	[Fault Arm Amps]	1371	[Fault 1 Code]	1351	
	[Fault Clr Mode]	1348	[Fault Speed]	1372			
	[Status1 at Fault]	1349	[Fault Field Amps]	1373			
<b>Alarms</b>	[Drive Alarm 1]	1380					
 Communications	<b>Comm Control</b>	[DPI Baud Rate]	589	[DPI Fdbk Select]	1321	[DPI Port Value]	1343
		[DPI Port Sel]	590				
	<b>Masks &amp; Owners</b>	[Logic Mask]	591	[MOP Mask]	598	[Reference Owner]	604
		[Start Mask]	592	[Local Mask]	599	[Accel Owner]	605
		[Jog Mask]	593	[Decel Mask]	631	[Fault Clr Owner]	606
		[Direction Mask]	594	[Stop Owner]	600	[MOP Owner]	607
		[Reference Mask]	595	[Start Owner]	601	[Local Owner]	608
		[Accel Mask]	596	[Jog Owner]	602	[Decel Owner]	609
		[Fault Clr Mask]	597	[Direction Owner]	603		
<b>Datalinks</b>	[Data In A1]	610	[Data In D1]	616	[Data Out C1]	622	
	[Data In A2]	611	[Data In D2]	617	[Data Out C1]	623	
	[Data In B1]	612	[Data Out A1]	618	[Data Out D1]	624	
	[Data In B2]	613	[Data Out A2]	619	[Data Out D2]	625	
	[Data In C1]	614	[Data Out B1]	620	[Data In Val Sel]	1319	
	[Data In C2]	615	[Data Out B2]	621	[Data In SelData]	1320	
<b>Security</b>	[Logic Mask]	591					
 Input / Output	<b>Analog Inputs</b>	[Anlg In1 Sel]	70	[Anlg In1 Target]	295	[Anlg In1 Cmp Eq]	1045
		[Anlg In1 Config]	71	[Anlg In2 Target]	296	[Analog In1 Value]	1404
		[Anlg In2 Sel]	75	[Anlg In3 Target]	297	[Analog In2 Value]	1405
		[Anlg In2 Config]	76	[Anlg In1 Cmp]	1042	[Analog In3 Value]	1406
		[Anlg In3 Sel]	80	[Anlg In1 Cmp Err]	1043		
		[Anlg In3 Config]	81	[Anlg In1 Cmp Dly]	1044		
	<b>Analog Outputs</b>	[Anlg Out1 Sel]	66	[Anlg Out4 Sel]	69	[Analog Out3 Scale]	64
		[Anlg Out2 Sel]	67	[Analog Out1 Scale]	62	[Analog Out4 Scale]	65
		[Anlg Out3 Sel]	68	[Analog Out2 Scale]	63		
	<b>Digital Inputs</b>	[Dig In Status]	564	[Digital In9 Sel]	141	[Dig In Term 6]	570
		[Digital In1 Sel]	133	[Digital In10 Sel]	142	[Dig In Term 7]	571
		[Digital In2 Sel]	134	[Digital In11 Sel]	143	[Dig In Term 8]	572
		[Digital In3 Sel]	135	[Digital In12 Sel]	144	[Dig In Term 9]	573
		[Digital In4 Sel]	136	[Dig In Term 1]	565	[Dig In Term 10]	574
		[Digital In5 Sel]	137	[Dig In Term 2]	566	[Dig In Term 11]	575
		[Digital In6 Sel]	138	[Dig In Term 3]	567	[Dig In Term 12]	576
[Digital In7 Sel]		139	[Dig In Term 4]	568			
[Digital In8 Sel]		140	[Dig In Term 5]	569			
<b>Digital Outputs</b>		[Dig Out Status]	581	[Digital Out4 Sel]	148	[Digital Out8 Sel]	152
		[Digital Out1 Sel]	145	[Digital Out5 Sel]	149	[Relay Out 1 Sel]	1392
		[Digital Out2 Sel]	146	[Digital Out6 Sel]	150	[Relay Out 2 Sel]	629
	[Digital Out3 Sel]	147	[Digital Out7 Sel]	151			
<b>DPI Inputs</b>	[DPI P1 Select]	1323	[DPI P3 Select]	1325	[DPI P5 Select]	1327	
	[DPI P2 Select]	1324	[DPI P4 Select]	1326			

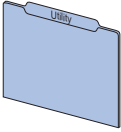
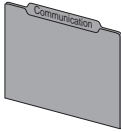
## Advanced Parameter View

Parameter 211 [Param Access Lvl] set to option 1 “Advanced”.

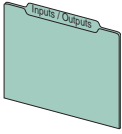
File	Group	Parameters						
	<b>Speed Meters</b>	[Speed Ref A]	44	[Ramp Out Pct]	114	[Spd Reg Fdbk]	1008	
		[Speed Ref A Pct]	47	[Speed Draw Out]	1018	[Spd Reg Fdbk Pct]	1009	
		[Speed Ref B]	48	[Spd Draw Out Pct]	1019	[Spd Feedback]	122	
		[Speed Ref B Pct]	49	[Droop Out]	1006	[Spd Feedback Pct]	121	
		[Speed Ref Out]	385	[Droop Out Pct]	1007	[Actual Speed]	924	
		[Spd Ref Out Pct]	384	[Speed Reg In]	118	[Encoder Speed]	420	
		[Ramp In]	110	[Speed Reg In Pct]	117	[Tachometer Speed]	1408	
		[Ramp In Pct]	111	[Spd Reg Err]	1010	[Resolver Speed]	428	
		[Ramp Out]	113	[Spd Reg Err Pct]	1011			
		<b>Current Meters</b>	[Inertia Comp Out]	232	[Fld Current Pct]	234	[Flux Ref Pct]	500
			[Spd Reg Out Pct]	236	[SpdReg PosLmOut]	89	[Field Curve Out]	476
			[Current Reg In]	41	[SpdReg NegLmOut]	90	[Selected TorqRef]	14
			[Arm Current]	200	[Cur Lim Pos Out]	10	[Motor Trq Ref]	17
			[Arm Current Pct]	199	[Cur Lim Neg Out]	11		
			[Field Current]	351	[Flt TorqCur Pct]	928		
		<b>Drive Data</b>	[FaultCode]	57	[Output Power]	1052	[Elapsed Lifetime]	235
[AC Line Voltage]	466		[Firing Angle]	165	[Software Version]	331		
[AC Line Freq]	588		[Drive Type]	300	[Drive Checksum]	332		
[Output Voltage]	233		[Drive Size]	465				
	<b>Motor Data</b>	[Max Ref Speed]	45	[Nom Mtr Fld Amps]	280	[MtrOvrlD Speed]	334	
		[Max Feedback Spd]	162	[Drv Fld Brdg Cur]	374	[SAR Volts Scale]	464	
		[Rated Motor Volt]	175	[MtrOvrlD Type]	376	[Drive Type Sel]	201	
		[Nom Mtr Arm Amps]	179	[MtrOvrlD Factor]	333	[Min Firing Angle]	21	
	<b>Field Config</b>	[Field Reg Enable]	497	[Arm Volt Kp Base]	495	[Reset Fld Curve]	920	
		[Field Economy En]	499	[Arm Volt Ki Base]	496	[Fld Const 40 Pct]	916	
		[Field Econ Delay]	1407	[Fld Reg Kp]	91	[Fld Const 70 Pct]	917	
		[Field Mode Sel]	469	[Fld Reg Ki]	92	[Fld Const 90 Pct]	918	
		[Max Fld Flux Pct]	467	[Force Min Field]	498	[Flux Divide]	462	
		[Min Fld Curr Pct]	468	[Out Volt Level]	921	[Flux Filter BW]	463	
		[Fld Weaken Ratio]	456	[Fld Reg Kp Base]	97	[Ext FC Curr Hyst]	410	
		[Arm Volt Kp]	493	[Fld Reg Ki Base]	98			
		[Arm Volt Ki]	494	[Set Fld Curve]	919			
	<b>Torq Attributes</b>	[Current Limit]	7	[Torque Reduction]	342	[TrqTpr Lim3]	754	
		[Current Lim Pos]	8	[Zero Torque]	353	[TrqTpr Lim4]	755	
		[Current Lim Neg]	9	[TrqTpr Enable]	750	[TrqTpr Spd]	756	
[Current Rate Lim]		12	[TrqTpr Lim0]	751	[Torq Cur Filter]	926		
[Torque Ref]		39	[TrqTpr Lim1]	752	[FC Lim Ramp]	411		
[Trim Torque]		40	[TrqTpr Lim2]	753	[FC Lim Ramp Time]	412		
<b>Speed Feedback</b>	[Fdbk Device Type]	414	[Spd FB Filt BW]	915	[Reslvr Type Sel]	423		
	[Anlg Tach Gain]	562	[Act Spd Filter]	923	[Reslvr Spd Ratio]	424		
	[Feedback Offset]	563	[Encoder PPR]	169	[Resolver Config]	425		
	[Spd Fdbk Control]	457	[Encoder Config]	170	[Resolver Status]	426		
	[SpdReg FB Bypass]	458	[Encoder Out Sel]	1021	[Reslvr Position]	427		
	[Spd Fdbk Invert]	461	[Encoder Err Chk]	652	[Resolver Pos Sel]	429		
	[Spd FB Loss Lvl]	455	[Encoder Counts]	1022	[Resolver Spd Sel]	430		
	[Spd FB Filt Gain]	914	[Fdbk Option ID]	422	[Reslvr Cable Bal]	431		
<b>Autotune</b>	[Autotune Cur Lim]	1048	[Speed Tune Kp]	1032	[Torque Const]	1013		
	[CurrReg Autotune]	452	[Speed Tune Ki]	1033	[Inertia]	1014		
	[Arm Resistance]	453	[Spd Tune Inertia]	1030	[Friction]	1015		
	[Arm Inductance]	454	[SpdTune Friction]	1031	[Spd Reg Kp Base]	93		
	[Spd Reg Autotune]	1027	[I Reg Error]	587	[Spd Reg Ki Base]	94		
	[Speed Tune Dir]	1029	[Inertia C Filter]	1012	[SpdReg Kp Pct]	1034		
					[SpdReg Ki Pct]	1035		
<b>Test Generator</b>	[TstGen Output]	58	[Arm Test Angle]	167	[OpenSCR Flt Cfg]	216		
	[TstGen Frequency]	59	[Fld Test Angle]	168	[OpenSCR Threshld]	217		
	[TstGen Amplitude]	60	[SCR Diag Test En]	213	[OpenSCR Trip Lvl]	218		
	[TstGen Offset]	61	[SCR Diag Status]	214				
	[Alpha Test]	166	[OpenSCR WarnLvl]	215				

File	Group	Parameters					
	<b>Limits</b>	[Minimum Speed]	1	[Min Speed Rev]	6	[Max Speed Fwd]	3
		[Min Speed Fwd]	5	[Maximum Speed]	2	[Max Speed Rev]	4
	<b>Discrete Speeds</b>	[Jog Speed]	266	[Preset Speed 3]	156	[Preset Speed 7]	160
		[Jog Off Delay]	1409	[Preset Speed 4]	157	[TB Manual Ref]	267
		[Preset Speed 1]	154	[Preset Speed 5]	158		
		[Preset Speed 2]	155	[Preset Speed 6]	159		
	<b>Speed References</b>	[Trim Ramp]	42	[Trim Speed]	43	[Speed Ratio]	1017
		[Trim Ramp Pct]	378	[Trim Speed Pct]	379		
	<b>Speed Regulator</b>	[Speed Reg En]	242 <sup>(1)</sup>	[SpdOut FiltBW]	239	[Spd Zero P Gain]	126
		[Spd Reg Kp]	87	[Speed Thresh Pos]	101	[Lock Speed Integ]	348
		[Spd Reg Ki]	88	[Speed Thresh Neg]	102	[Flying Start En]	388
		[Total Inertia]	433	[Threshold Delay]	103	[SpdReg AntiBckup]	643
		[Spd Reg BW]	434	[At Speed Error]	104	[Spd Reg P Filter]	444
		[Act Spd Reg BW]	435	[At Speed Delay]	105	[Spd Up Gain Pct]	445
[Spd Reg Damping]		436	[Ref Zero Level]	106	[Speed Up Base]	446	
[Spd Reg Kp Outpt]		99	[Speed Zero Level]	107	[Speed Up Filter]	447	
[Spd Reg Ki Outpt]		100	[Speed Zero Delay]	108	[SpdReg Kp Bypass]	459	
[Spd Reg Pos Lim]		95	[Spd Zero I En]	123	[SpdReg Ki Bypass]	460	
[Spd Reg Neg Lim]		96	[Spd Ref Zero En]	124	[SpdReg BW Bypass]	448	
[SpdOut FiltGain]		238	[Spd Zero P En]	125	[SpdFuncSelect]	1016	
(1) This parameter available for use with firmware revision 2.005 and lower only.							
		<b>Control Config</b>	[Spd Trq Mode Sel]	241	[SLAT Err Stpt]	15	[SLAT Dwell Time]
	<b>Ramp Rates</b>	[Speed Ramp En]	245	[MOP Accel Time]	22	[S Curve Accel 2]	667
		[Ramp Type Select]	18	[MOP Decel Time]	30	[S Curve Decel 2]	668
		[Accel Time 1]	660	[Jog Ramp Time]	1410	[Ramp Delay]	20
		[Decel Time 1]	662	[S Curve Time]	19	[Zero Ramp Output]	344
		[Accel Time 2]	24	[S Curve Accel 1]	665	[Zero Ramp Input]	345
		[Decel Time 2]	32	[S Curve Decel 1]	666	[Freeze Ramp]	373
	<b>Load Limits</b>	[Enable Droop]	699	[Droop Limit]	700	[Torq Limit Type]	715
		[Droop Percent]	696	[Load Comp]	698		
		[Droop Filter]	697	[Torq Red CurLim]	13		
	<b>Stop Modes</b>	[Fast Stop Time]	38	[Closing Speed]	1262	[Ramp In Zero En]	1265
		[Spd 0 Trip Delay]	627	[Opening Delay]	1263	[Actuator Delay]	1266
	<b>Restart Modes</b>	[Start At Powerup]	1344	[Powerup Delay]	1345		
	<b>Adaptv Regulator</b>	[Adaptive Spd En]	181	[Adaptive Joint 1]	186	[Adaptive I Gain2]	191
[Adaptive Reg Typ]		182	[Adaptive Joint 2]	187	[Adaptive P Gain3]	192	
[Adaptive Ref]		183	[Adaptive P Gain1]	188	[Adaptive I Gain3]	193	
[Adaptive Spd 1]		184	[Adaptive I Gain1]	189			
[Adaptive Spd 2]		185	[Adaptive P Gain2]	190			

File	Group	Parameters					
	<b>PI Control</b>	[Enable PI]	769	[PI Prop Gain PID]	765	[PI Central v3]	778
		[PI Output]	771	[PI Integral Gain]	764	[PI Central v sel]	779
		[PI Steady Thrsh]	695	[PI Upper Limit]	784	[PI Central vs0]	780
		[PID Steady Delay]	731	[PI Lower Limit]	785	[PI Central vs1]	781
		[PI Init Prop Gn]	793	[PI Central v1]	776	[PI integr freeze]	783
		[PI Init Intgl Gn]	734	[PI Central v2]	777		
	<b>PD Control</b>	[Enable PD]	770	[PD Prop Gain 2]	788	[PD Deriv Gain 1]	766
		[PD Output PID]	421	[PD Prop Gain 3]	790	[PD Deriv Gain 2]	789
		[PD Prop Gain 1]	768	[PD Deriv Filter]	767	[PD Deriv Gain 3]	791
	<b>PID Control</b>	[Enable PI PD]	1258	[PID Target]	782	[PID Clamp]	757
[PID Output]		774	[PID Output Scale]	773	[PID Setpoint 0]	760	
[Feed Fwd PID]		758	[PID Output Sign]	772	[PID Setpoint 1]	761	
[Real FF PID]		418	[PID Feedback]	763	[PID Setpoint Sel]	762	
[PID Source]		786	[PID Error]	759	[PID Accel Time]	1046	
[PID Source Gain]		787	[PID Error Gain]	1254	[PID Decel Time]	1047	
<b>Init Diam Calc</b>	[Diameter Calc]	794	[Gear Box Ratio]	797	[Diameter Calc St]	800	
	[DncrPosSpd]	795	[Dancer Constant]	798			
	[Max Deviation]	796	[Minimum Diameter]	799			
<b>Diameter Calc</b>	[Minimum Diameter]	799	[Line Speed Pct]	1160	[Diam Preset 1]	1165	
	[Max Diameter]	1153	[Line Spd Thresh]	1155	[Diam Preset 2]	1166	
	[Roll Diameter]	1154	[Base Omega]	1163	[Diam Preset 3]	1167	
	[Diam Threshold]	1158	[Diameter Filter]	1162	[Diam Preset Sel]	1168	
	[Diameter Reached]	1159	[Diam Init Filter]	1206	[Diameter Reset]	1157	
	[Winder Type]	1187	[Diam Stdy Delay]	1207	[Diam Calc Dis]	1161	
	[Line Spd Source]	1204	[Diam Inc Dec En]	1205			
	[Line Spd Gain]	1156	[Diam Preset 0]	1164			
<b>Winder Functions</b>	[Torque Winder En]	1209	[InertiaCompCnst]	1191	[Ref Line Speed]	1286	
	[Tension Ref]	1180	[InertiaCompVar]	1192	[W Target]	1210	
	[Act Ten Ref Pct]	1194	[Static Friction]	1174	[W Reference]	1217	
	[Torq Current Pct]	1193	[Static F Zero]	1287	[Winder Side]	1201	
	[Int Acc Calc En]	1183	[Dynamic Friction]	1175	[W Gain]	1202	
	[Time AccDec Min]	1182	[Actual Comp]	1213	[W Offset]	1199	
	[Acc Dec Filter]	1212	[Closed Loop En]	1214	[Offs Accel Time]	1198	
	[Line Accel Pct]	1184	[Close Loop Comp]	1208	[Speed Match]	1195	
	[Line Decel Pct]	1185	[Tension Scale]	1181	[Spd Match Gain]	1200	
	[Line FastStp Pct]	1186	[Taper Enable]	1176	[Spd Match Acc]	1196	
	[Accel Status]	1188	[Initial Diameter]	1177	[Spd Match Dec]	1197	
	[Decel Status]	1189	[Final Diameter]	1178	[Spd Match Torque]	1216	
	[Fast Stop Status]	1190	[Tension Reduct]	1179	[Spd Match Compl]	1203	
	[Variable J Comp]	1171	[Speed Demand En]	1215	[Jog TW Enable]	1256	
	[Constant J Comp]	1172	[Ref Spd Source]	1284	[Jog TW Speed]	1255	
	[Materl Width Pct]	1173	[Ref Speed Gain]	1285			
	<b>Torque Prove</b>	[Torq Prove Cfg]	1100	[Spd Band Intgrtr]	1106	[Float Tolerance]	1111
[Torq Prove Setup]		1101	[Brk Release Time]	1107	[MicroPsnScalePct]	1112	
[Torq Prove Sts]		1103	[Brk Set Time]	1108	[ZeroSpdFloatTime]	1113	
[Torq Limit Slew]		1104	[Brk Alarm Travel]	1109	[Brake Test Torq]	1114	
[Speed Dev Band]		1105	[Brk Slip Count]	1110			
<b>Scale Blocks</b>	[Scale1 Input]	484	[Scale3 Input]	1218	[Scale5 Input]	1236	
	[Scale1 Output]	485	[Scale3 Output]	1219	[Scale5 Output]	1237	
	[Scale1 Mul]	486	[Scale3 Mul]	1220	[Scale5 Mul]	1238	
	[Scale1 Div]	487	[Scale3 Div]	1221	[Scale5 Div]	1239	
	[Scale1 In Max]	488	[Scale3 In Max]	1222	[Scale5 In Max]	1240	
	[Scale1 In Min]	489	[Scale3 In Min]	1223	[Scale5 In Min]	1241	
	[Scale1 In Off]	490	[Scale3 In Off]	1224	[Scale5 In Off]	1242	
	[Scale1 Out Off]	491	[Scale3 Out Off]	1225	[Scale5 Out Off]	1243	
	[Scale1 In Abs]	492	[Scale3 In Abs]	1226	[Scale5 In Abs]	1244	
	[Scale2 Input]	553	[Scale4 Input]	1227	[Scale6 Input]	1245	
	[Scale2 Output]	554	[Scale4 Output]	1228	[Scale6 Output]	1246	
	[Scale2 Mul]	555	[Scale4 Mul]	1229	[Scale6 Mul]	1247	
	[Scale2 Div]	556	[Scale4 Div]	1230	[Scale6 Div]	1248	
	[Scale2 In Max]	557	[Scale4 In Max]	1231	[Scale6 In Max]	1249	
	[Scale2 In Min]	558	[Scale4 In Min]	1232	[Scale6 In Min]	1250	
	[Scale2 In Off]	559	[Scale4 In Off]	1233	[Scale6 In Off]	1251	
	[Scale2 Out Off]	560	[Scale4 Out Off]	1234	[Scale6 Out Off]	1252	
	[Scale2 In Abs]	561	[Scale4 In Abs]	1235	[Scale6 In Abs]	1253	

File	Group	Parameters					
 Utility	<b>Reference Config</b>	[Direction Mode]	1322	[Man Ref Preload]	210	[MOP Select]	1375
		[Save HIM Ref]	209	[MOP Ref Config]	249		
	<b>Drive Memory</b>	[Param Access Lvl]	211	[Reset Defaults]	258	[Language]	302
	<b>Diagnostics</b>	[Drive Status 1]	381	[Spd Limit Active]	372	[Ramp Select 1]	404
		[Drive Status 2]	382	[Speed Threshold]	393	[Spd Fdbk State]	651
		[Speed Ref Source]	1329	[Torque Positive]	346	[Reslvr Error Cnt]	432
		[Spd Ref Sel Sts]	1330	[Torque Negative]	347	[MtrOvrld Status]	1290
		[Last Stop Source]	1402	[MOP Inc Active]	396	[TestPoint Sel]	1381
		[Start Inhibits]	1403	[MOP Dec Active]	397	[TestPoint Data]	1382
		[Drive Logic Rslt]	1328	[Spd Select 0]	400	[TaskLoad 1 ms]	1384
		[At Speed]	394	[Spd Select 1]	401	[TaskLoad 2 ms]	1385
		[At Zero Speed]	395	[Spd Select 2]	402	[TaskLoad 8 ms]	1386
		[CurrLimit Active]	349	[Ramp Select 0]	403		
		<b>Faults</b>	[Clear Fault Que]	263	[Fault 2 Code]	1352	[Fault 2 Time]
	[Fault Clear]		1347	[Fault 3 Code]	1353	[Fault 3 Time]	1363
	[Fault Clr Mode]		1348	[Fault 4 Code]	1354	[Fault 4 Time]	1364
	[Status1 at Fault]		1349	[Fault 5 Code]	1355	[Fault 5 Time]	1365
	[Status2 at Fault]		1350	[Fault 6 Code]	1356	[Fault 6 Time]	1366
	[Fault Arm Amps]		1371	[Fault 7 Code]	1357	[Fault 7 Time]	1367
	[Fault Speed]		1372	[Fault 8 Code]	1358	[Fault 8 Time]	1368
	[Fault Field Amps]		1373	[Fault 9 Code]	1359	[Fault 9 Time]	1369
	[Fault Voltage]		1374	[Fault 10 Code]	1360	[Fault 10 Time]	1370
	[Fault 1 Code]		1351	[Fault 1 Time]	1361		
	<b>Alarms</b>	[Drive Alarm 1]	1380	[FldLoss Flt Cfg]	473	[UnderVlt Flt Dly]	470
		[Drive Alarm 2]	1394	[FldLoss Flt Dly]	475	[OverCurrent Thr]	584
[OverVolt Flt Cfg]		203	[Spd Loss Flt Cfg]	478	[Overspeed Val]	585	
[Aux Inp Flt Cfg]		354	[MtrOvrld Flt Cfg]	479	[SSC Threshold]	409	
[OverTemp Flt Cfg]		365	[UnderVlt Thresh]	481			
<b>User Defined</b>	[UsrDsplyMult0]	50	[UserDefined14]	517	[UsrDefBitWrdA15]	535	
	[UsrDsplyDiv0]	51	[UserDefined15]	518	[UsrDefBitWrdB]	536	
	[UsrValMult1]	53	[UsrDefBitWrdA]	519	[UsrDefBitWrdB0]	537	
	[UsrValDiv1]	54	[UsrDefBitWrdA0]	520	[UsrDefBitWrdB1]	538	
	[UserDefined0]	503	[UsrDefBitWrdA1]	521	[UsrDefBitWrdB2]	539	
	[UserDefined1]	504	[UsrDefBitWrdA2]	522	[UsrDefBitWrdB3]	540	
	[UserDefined2]	505	[UsrDefBitWrdA3]	523	[UsrDefBitWrdB4]	541	
	[UserDefined3]	506	[UsrDefBitWrdA4]	524	[UsrDefBitWrdB5]	542	
	[UserDefined4]	507	[UsrDefBitWrdA5]	525	[UsrDefBitWrdB6]	543	
	[UserDefined5]	508	[UsrDefBitWrdA6]	526	[UsrDefBitWrdB7]	544	
	[UserDefined6]	509	[UsrDefBitWrdA7]	527	[UsrDefBitWrdB8]	545	
	[UserDefined7]	510	[UsrDefBitWrdA8]	528	[UsrDefBitWrdB9]	546	
	[UserDefined8]	511	[UsrDefBitWrdA9]	529	[UsrDefBitWrdB10]	547	
	[UserDefined9]	512	[UsrDefBitWrdA10]	530	[UsrDefBitWrdB11]	548	
[UserDefined10]	513	[UsrDefBitWrdA11]	531	[UsrDefBitWrdB12]	549		
[UserDefined11]	514	[UsrDefBitWrdA12]	532	[UsrDefBitWrdB13]	550		
[UserDefined12]	515	[UsrDefBitWrdA13]	533	[UsrDefBitWrdB14]	551		
[UserDefined13]	516	[UsrDefBitWrdA14]	534	[UsrDefBitWrdB15]	552		
 Communications	<b>Comm Control</b>	[DPI Baud Rate]	589	[DPI Fdbk Select]	1321	[DPI Port Value]	1343
		[DPI Port Sel]	590				
	<b>Masks &amp; Owners</b>	[Logic Mask]	591	[MOP Mask]	598	[Reference Owner]	604
		[Start Mask]	592	[Local Mask]	599	[Accel Owner]	605
		[Jog Mask]	593	[Decel Mask]	631	[Fault Clr Owner]	606
		[Direction Mask]	594	[Stop Owner]	600	[MOP Owner]	607
		[Reference Mask]	595	[Start Owner]	601	[Local Owner]	608
		[Accel Mask]	596	[Jog Owner]	602	[Decel Owner]	609
		[Fault Clr Mask]	597	[Direction Owner]	603		
	<b>Datalinks</b>	[Data In A1]	610	[Data In D1]	616	[Data Out C1]	622
		[Data In A2]	611	[Data In D2]	617	[Data Out C1]	623
		[Data In B1]	612	[Data Out A1]	618	[Data Out D1]	624
		[Data In B2]	613	[Data Out A2]	619	[Data Out D2]	625
		[Data In C1]	614	[Data Out B1]	620	[Data In Val Sel]	1319
		[Data In C2]	615	[Data Out B2]	621	[Data In SelData]	1320
	<b>Security</b>	[Logic Mask]	591	[Write Mask Act]	1377	[Port Mask Act]	1379
		[Logic Mask Act]	1376	[Write Mask Cfg]	1378		



File	Group	Parameters						
<b>Input / Output</b> 	<b>Analog Inputs</b>	[Anlg In1 Sel]	70	[Anlg In2 Offset]	79	[Anlg In2 Target]	296	
		[Anlg In1 Config]	71	[Anlg In2 Tune]	260	[Anlg In3 Target]	297	
		[Anlg In1 Scale]	72	[Anlg In2 Filter]	801	[Anlg In1 Cmp]	1042	
		[Anlg 1 Tune Scale]	73	[Anlg In3 Sel]	80	[Anlg In1 Cmp Err]	1043	
		[Anlg In1 Offset]	74	[Anlg In3 Config]	81	[Anlg In1 Cmp Dly]	1044	
		[Anlg In1 Tune]	259	[Anlg In3 Scale]	82	[Anlg In1 Cmp Eq]	1045	
		[Anlg In1 Filter]	792	[Anlg 3 Tune Scale]	83	[Analog In1 Value]	1404	
		[Anlg In2 Sel]	75	[Anlg In3 Offset]	84	[Analog In2 Value]	1405	
		[Anlg In2 Config]	76	[Anlg In3 Tune]	261	[Analog In3 Value]	1406	
		[Anlg In2 Scale]	77	[Anlg In3 Filter]	802			
		[Anlg 2 Tune Scale]	78	[Anlg In1 Target]	295			
		<b>Analog Outputs</b>	[Anlg Out1 Sel]	66	[Anlg Out4 Sel]	69	[Analog Out3 Scale]	64
			[Anlg Out2 Sel]	67	[Analog Out1 Scale]	62	[Analog Out4 Scale]	65
			[Anlg Out3 Sel]	68	[Analog Out2 Scale]	63		
		<b>Digital Inputs</b>	[ContactorControl]	1391	[Digital In12 Sel]	144	[Dig In Term 1]	565
			[Dig In Status]	564	[Inversion In 1]	1276	[Dig In Term 2]	566
			[Digital In1 Sel]	133	[Inversion In 2]	1277	[Dig In Term 3]	567
			[Digital In2 Sel]	134	[Inversion In 3]	1278	[Dig In Term 4]	568
	[Digital In3 Sel]		135	[Inversion In 4]	1279	[Dig In Term 5]	569	
	[Digital In4 Sel]		136	[Inversion In 5]	1280	[Dig In Term 6]	570	
	[Digital In5 Sel]		137	[Inversion In 6]	1281	[Dig In Term 7]	571	
	[Digital In6 Sel]		138	[Inversion In 7]	1282	[Dig In Term 8]	572	
	[Digital In7 Sel]		139	[Inversion In 8]	1283	[Dig In Term 9]	573	
	[Digital In8 Sel]		140	[Inversion In 9]	1387	[Dig In Term 10]	574	
	[Digital In9 Sel]		141	[Inversion In 10]	1388	[Dig In Term 11]	575	
	[Digital In10 Sel]		142	[Inversion In 11]	1389	[Dig In Term 12]	576	
	<b>Digital Outputs</b>	[Dig Out Status]	581	[Digital Out7 Sel]	151	[Inversion Out 4]	1270	
		[Digital Out1 Sel]	145	[Digital Out8 Sel]	152	[Inversion Out 5]	1271	
		[Digital Out2 Sel]	146	[Relay Out 1 Sel]	1392	[Inversion Out 6]	1272	
		[Digital Out3 Sel]	147	[Relay Out 2 Sel]	629	[Inversion Out 7]	1273	
		[Digital Out4 Sel]	148	[Inversion Out 1]	1267	[Inversion Out 8]	1274	
		[Digital Out5 Sel]	149	[Inversion Out 2]	1268	[Inversion Relay1]	1393	
		[Digital Out6 Sel]	150	[Inversion Out 3]	1269	[Inversion Relay2]	1275	
		<b>DPI Inputs</b>	[DPI P1 Select]	1323	[DPI P3 Select]	1325	[DPI P5 Select]	1327
	[DPI P2 Select]		1324	[DPI P4 Select]	1326			

## Monitor File

File	Group	No.	Parameter Name & Description <small>See page 117 for symbol descriptions</small>	Values	Data Type	Related
MONITOR	Speed Meters	44	<b>[Speed Ref A]</b> Displays the first speed reference of the drive in rpm. This parameter can be sourced from many signals and is the factory default selection for Par 70 [Anlg In1 Sel]. See block diagram Speed Reference Selection on page 365 for possible source signals. Note: The maximum value of this parameter was changed from -/+ Par 45 for firmware revision 3.001.	Default: Read Only Min/Max: -/+ 1.3 x Par 45 [Max Ref Speed] <sup>(1)</sup> Units: rpm  <small>(1) The value of [Max Ref Speed] cannot exceed 6000 rpm.</small>	16-bit Int	45
		47	<b>[Speed Ref A Pct]</b> Displays the first speed reference of the drive as a percentage of Par 45 [Max Ref Speed]. This parameter can be sourced from many signals. See block diagram Speed Reference Selection on page 365 for possible source signals. Notes: This parameter can be assigned to an analog input. The min. and max. values of this parameter were changed from -/+100.0 for firmware revision 3.001.	Default: Read Only Min/Max: -/+130.0 Units: %	Real	45
		48	<b>[Speed Ref B]</b> Displays the second speed reference of the drive in rpm. This parameter can be sourced from many signals. See block diagram Speed Reference Selection on page 365 for possible source signals. Note: The maximum value of this parameter was changed from -/+ Par 45 for firmware revision 3.001.	Default: Read Only Min/Max: -/+ 1.3 x Par 45 [Max Ref Speed] <sup>(1)</sup> Units: rpm  <small>(1) The value of [Max Ref Speed] cannot exceed 6000 rpm.</small>	16-bit Int	45
		49	<b>[Speed Ref B Pct]</b> Displays the second speed reference of the drive as a percentage of Par 45 [Max Ref Speed]. This parameter can be sourced from many signals. See block diagram Speed Reference Selection on page 365 for possible source signals. Note: The min. and max. values of this parameter were changed from -/+100.0 for firmware revision 3.001.	Default: Read Only Min/Max: -/+130.0 Units: %	Real	45
		110	<b>[Ramp In]</b> Total reference value input to the ramp in rpm. Notes: This parameter can be assigned to an analog output. The min. and max. values of this parameter were changed from -/+32766 for firmware revision 3.001	Default: Read Only Min/Max: -/+8192 Units: rpm	16-bit Int	
		111	<b>[Ramp In Pct]</b> Total reference value input to the ramp as a percentage of Par 45 [Max Ref Speed]. Notes: This parameter can be assigned to an analog output. The min. and max. values of this parameter were changed from -/+100.0 for firmware revision 3.001.	Default: Read Only Min/Max: -/+200.0 Units: %	Real	45
		113	<b>[Ramp Out]</b> Output of the ramp in rpm. Notes: This parameter can be assigned to an analog output. The min. and max. values of this parameter were changed from -/+32766 for firmware revision 3.001	Default: Read Only Min/Max: -/+8192 Units: rpm	16-bit Int	
		114	<b>[Ramp Out Pct]</b> Output of the ramp as a percentage of Par 45 [Max Ref Speed]. Note: The min. and max. values of this parameter were changed from -/+100.0 for firmware revision 3.001.	Default: Read Only Min/Max: -/+200.0 Units: %	Real	45
		117	<b>[Speed Reg In Pct]</b> Total reference value input to the Speed Regulator as a percentage of Par 45 [Max Ref Speed]. Notes: This parameter can be assigned to an analog output. The min. and max. values of this parameter were changed from -/+100.0 for firmware revision 3.001.	Default: Read Only Min/Max: -/+200.0 Units: %	Real	



File	Group	No.	Parameter Name & Description <small>See page 117 for symbol descriptions</small>	Values	Data Type	Related	
MONITOR	Speed Meters	118	<b>[Speed Reg In]</b> Total reference value input to the Speed Regulator in rpm. Notes: This parameter can be assigned to an analog output. The min. and max. values of this parameter were changed from -/+32766 for firmware revision 3.001	Default: Min/Max: Units:	Read Only -/+8192 rpm	16-bit Int	
		121	<b>[Spd Feedback Pct]</b> Actual speed as a percentage of the Par 162 [Max Feedback Spd]. Notes: This parameter can be assigned to an analog output and is the factory default selection for Par 66 [Anlg Out1 Sel]. The min. and max. values of this parameter were changed from -/+100.0 for firmware revision 3.001.	Default: Min/Max: Units:	Read Only -/+200.0 %	Real	66, 162
		122	<b>[Spd Feedback]</b> Actual speed in rpm. Notes: This parameter can be assigned to an analog output. The min. and max. values of this parameter were changed from -/+32766 for firmware revision 3.001	Default: Min/Max: Units:	Read Only -/+8192 rpm	16-bit Int	
		428	<b>[Resolver Speed]</b> Displays the speed feedback from the resolver module. Note: This parameter was added for firmware revision 5.002.	Default: Min/Max: Units:	Read Only -/+8192 rpm	16-bit Int	
		384	<b>[Spd Ref Out Pct]</b> Output of the Speed Reference selection as a percentage of Par 45 [Max Ref Speed]. Notes: This parameter can be assigned to an analog output. The min. and max. values of this parameter were changed from -/+100.0 for firmware revision 3.001.	Default: Min/Max: Units:	Read Only -/+200.0 %	Real	45
		385	<b>[Speed Ref Out]</b> Output of the Speed Reference selection. Notes: This parameter can be assigned to an analog output. The min. and max. values of this parameter were changed from -/+32766 for firmware revision 3.001	Default: Min/Max: Units:	Read Only -/+8192 rpm	16-bit Int	
		420	<b>[Encoder Speed]</b> Actual speed measured by the digital encoder.	Default: Min/Max: Units:	Read Only -/+8192 rpm	16-bit Int	
		924	<b>[Actual Speed]</b> Filtered value of Par 122 [Spd Feedback]. Par 923 [Act Spd Filter] can be used to provide limited (first order low pass) filtering of this value. Notes: This parameter can be assigned to an analog output. The min. and max. values of this parameter were changed from -/+32766 for firmware revision 3.001	Default: Min/Max: Units:	Read Only -/+8192 rpm	16-bit Int	121, 222, 923
		1006	<b>[Droop Out]</b> Displays the output of the Droop Compensation function. The [Droop Out] signal (if enabled by Par 699 [Enable Droop]) is summed with Par 1018 [Speed Draw Out] and 43 [Trim Speed]. Droop compensation specifies the amount of adjustment in speed reference when operating at full load current. Note: This parameter was added for firmware revision 4.001.	Default: Min/Max: Units:	Read Only -/+ Par 45 [Max Ref Speed] rpm	16-bit Int	45
		1007	<b>[Droop Out Pct]</b> The value of Par 1006 [Droop Out] shown as a percentage of Par 45 [Max Ref Speed]. Note: This parameter was added for firmware revision 4.001.	Default: Min/Max: Units:	Read Only -/+100.0 %	Real	45
		1008	<b>[Spd Reg Fdbk]</b> Speed Regulator Feedback signal after all filtering has been applied. Note: This parameter was added for firmware revision 4.001.	Default: Min/Max: Units:	Read Only -/+8192 rpm	16-bit Int	
1009	<b>[Spd Reg Fdbk Pct]</b> Par 1008 [Spd Reg Fdbk] shown as a percentage of Par 162 [Max Feedback Spd]. Note: This parameter was added for firmware revision 4.001.	Default: Min/Max: Units:	Read Only -/+200.0 %	Real	162		







File	Group	No.	Parameter Name & Description <small>See page 117 for symbol descriptions</small>	Values	Data Type	Related
MONITOR	Speed Meters	1010	<b>[Spd Reg Err]</b> Speed Regulator Error signal, the difference between Par 118 [Speed Reg In] and 1008 [Spd Reg Fdbk]. Note: This parameter was added for firmware revision 4.001.	Default: Read Only Min/Max: -/+8192 Units: rpm	16-bit Int	118, 1008
		1011	<b>[Spd Reg Err Pct]</b> Par 1010 [Spd Reg Err] shown as a percentage of Par 45 [Max Ref Speed]. Note: This parameter was added for firmware revision 4.001.	Default: Read Only Min/Max: -/+200.0 Units: %	Real	45
		1018	<b>[Speed Draw Out]</b> Speed draw output value. Notes: This parameter can be assigned to an analog output. See Speed Draw Function on page 341 for more information.	Default: Read Only Min/Max: -/+ Par 45 [Max Ref Speed] <sup>1</sup> Units: rpm <small>(<sup>1</sup>) The value of [Max Ref Speed] cannot exceed 8192 rpm.</small>	16-bit Int	45
		1019	<b>[Spd Draw Out Pct]</b> Speed draw output as a percentage of Par 45 [Max Ref Speed]. Notes: This parameter can be assigned to an analog output. The min. and max. values of this parameter were changed from -/+100.00 for firmware revision 3.001.	Default: Read Only Min/Max: -/+100.0 Units: %	Real	45
		1408	<b>[Tachometer Speed]</b> Actual speed measured by the DC analog tachometer. Note: The min. and max. values of this parameter were changed from -/+32770 for firmware revision 3.001	Default: Read Only Min/Max: -/+8192 Units: rpm	Real	
		10	<b>[Cur Lim Pos Out]</b> Displays the value of the current limit for the positive torque direction as a percentage of the value in Par 179 [Nom Mtr Arm Amps].	Default: Read Only Min/Max: 0 / 250 Units: %	Real	179
	11	<b>[Cur Lim Neg Out]</b> Displays the value of the current limit for the negative torque direction as a percentage of the value in Par 179 [Nom Mtr Arm Amps].	Default: Read Only Min/Max: 0 / 200 Units: %	Real	179	
	14	<b>[Selected TorqRef]</b> Displays the selected torque reference based on Par 241 [Spd Trq Mode Sel] value. Scaled as a percentage of Par 179 [Nom Mtr Arm Amps]. Note: This parameter was added for firmware revision 3.001.	Default: Read Only Min/Max: -/+250 Units: %	Real	179, 241	
	17	<b>[Motor Trq Ref]</b> Displays the total motor torque reference. Scaled as a percentage of Par 179 [Nom Mtr Arm Amps]. Note: This parameter was added for firmware revision 3.001.	Default: Read Only Min/Max: -/+250 Units: %	Real	179	
	41	<b>[Current Reg In]</b> Total current reference value expressed as a percentage of the value in Par 179 [Nom Mtr Arm Amps]. Note: This parameter can be assigned to an analog output.	Default: Read Only Min/Max: -/+250 Units: %	Real	179	
	89	<b>[SpdReg PosLmOut]</b> Indication of the positive limit value in effect on the output of the speed regulator. Note: This parameter was added for firmware revision 5.002.	Default: Read Only Min/Max: -/+250 Units: %	Real		
	90	<b>[SpdReg NegLmOut]</b> Indication of the negative limit value in effect on the output of the speed regulator. Note: This parameter was added for firmware revision 5.002.	Default: Read Only Min/Max: -/+250 Units: %	Real		
	199	<b>[Arm Current Pct]</b> Armature current expressed as a percentage of the value in Par 179 [Nom Mtr Arm Amps]. Note: This parameter can be assigned to an analog output and is the default selection for Par 67 [Anlg Out2 Sel].	Default: Read Only Min/Max: -/+250 Units: %	16-bit Int	179	
	200	<b>[Arm Current]</b> Armature current in Amperes. Note: This parameter can be assigned to an analog output.	Default: Read Only Min/Max: -/+2.5 x [Nom Mtr Arm Amps] Units: A	Real		

File	Group	No.	Parameter Name & Description <small>See page 117 for symbol descriptions</small>	Values	Data Type	Related
MONITOR	Current Meters	232	<b>[Inertia Comp Out]</b> Displays the output of the Inertia Compensation function. The [Inertia Comp Out] signal (if selected by Par 1016 [SpdFuncSelect]) is summed with Pars 14 [Selected TorqRef] and 40 [Trim Torque]. Inertia compensation provides a torque feed forward signal during changes in motor speed reference. Notes: This parameter was added for firmware revision 4.001. In revision 6.004, when Inertia Loss/Compensation is not selected, this parameter value can reach invalid values if parameter 1014 [Inertia] or 433 [Total Inertia] becomes large.	Default: Read Only Min/Max: -/+200 Units: %	Real	
		234	<b>[Fld Current Pct]</b> Field current (present value) as a percentage of Par 280 [Nom Mtr Fld Amps]. When running a permanent magnet motor, this parameter will display zero. Note: This parameter can be assigned to an analog output and is the default value for Par 68 [Anlg Out3 Sel].	Default: Read Only Min/Max: 0.00 / 100.00 Units: %	Real	280
		236	<b>[Spd Reg Out Pct]</b> Output value of the speed regulator, as a percentage of Par 179 [Nom Mtr Arm Amps], used as the reference for the current regulator.	Default: Read Only Min/Max: -/+250 Units: %	Real	179
		351	<b>[Field Current]</b> Present value of the field current. When running a permanent magnet motor, this parameter will display zero. Note: This parameter can be assigned to an analog output.	Default: Read Only Min/Max: 0.00 / 99.90 Units: A	Real	
		476	<b>[Field Curve Out]</b> Displays the output value of the field current used as a reference to the field current regulator. Note: This parameter was added for firmware revision 4.001.	Default: Read Only Min/Max: 0.00 / 100.00 Units: %	Real	
		500	<b>[Flux Ref Pct]</b> Field flux (reference) as a percentage of Par 280 [Nom Mtr Fld Amps]. When the Field Curve is linear (default setting), the field flux reference will be a linear percentage of the field current. If the Field Curve is set to values other than the defaults (in Pars 916 . . . 918), the field flux reference percentage will not be equal to the field current percentage (unless the flux is at 0% or 100%). When running a permanent magnet motor, this parameter will display zero. Notes: This parameter can be assigned to an analog output. This name of this parameter was changed from [Field Ref Pct] for firmware revision 3.001.	Default: Read Only Min/Max: 0.00 / 100.00 Units: %	Real	280
		928	<b>[Filt TorqCur Pct]</b> Filtered value of Par 1193 [Torq Current Pct]. The amount of filtering is set by Par 926 [Torq Cur Filter].	Default: Read Only Min/Max: -/+250 Units: %	16-bit Int	926, 1193
	Drive Data	57	<b>[FaultCode]</b> A code that shows the last active fault on the drive. If there are no active faults, this value will be zero (No Fault). The last 10 faults in the drive can be viewed in Pars 1351 . . . 1370. See Fault Descriptions on page 222 for a list of fault codes and descriptions.	Default: Read Only Min/Max: 0 / 65535	16-bit Int	1351
		165	<b>[Firing Angle]</b> Actual SCR firing angle. Notes: This parameter was added for firmware revision 7.001.	Default: 120.00 Min/Max: 0.00 / 180.00 Units: Deg	Real	
		233	<b>[Output Voltage]</b> Measured output armature voltage. Note: This parameter can be assigned to an analog output and is the default selection for Par 69 [Anlg Out4 Sel].	Default: Read Only Min/Max: -/+999.00 Units: Vdc	Real	
		235	<b>[Elapsed Lifetime]</b> Shows the operating time of the drive. This parameter counts the time for which the drive is energized (even if the drive is disabled).	Default: Read Only Min/Max: 0.00 / 65535.0 Units: H.m	Real	
		300	<b>[Drive Type]</b> Displays of the drive type. "10" = Non-Regenerative "11" = Regenerative	Default: Read Only Min/Max: 10 / 11	16-bit Int	









File	Group	No.	Parameter Name & Description <small>See page 117 for symbol descriptions</small>	Values		Data Type	Related
				Default:	Read Only		
MONITOR	Drive Data	331	<b>[Software Version]</b> Displays the Major and Minor (Major.Minor) firmware version numbers active in the drive.	Default:	Read Only	Real	
				Min/Max:	1.00 / 999.00		
		332	<b>[Drive Checksum]</b> Provides a checksum value that indicates whether or not a change in drive programming has occurred.	Default:	Read Only	16-bit Int	
				Min/Max:	0 / 65535		
		465	<b>[Drive Size]</b> Armature current rating (as indicated by the configuration of DIP switch S15 on the control board). This value is used to determine the Drive Overload fault (F64). Note: S15 is set to the appropriate value at the factory. However, if the control board was supplied separate from the drive and installed as a replacement part, S15 must be manually set to the appropriate drive size. See DIP Switch and Jumper Settings on page 77.	Default:	Read Only	16-bit Int	
				Min/Max:	0 / Based on drive current rating		
				Units:	A		
		466	<b>[AC Line Voltage]</b> AC input voltage.	Default:	Read Only	16-bit Int	
				Min/Max:	0 / 960		
				Units:	Vac		
		588	<b>[AC Line Freq]</b> AC input frequency.	Default:	Read Only	Real	
				Min/Max:	0.00 / 70.00		
				Units:	Hz		
		1052	<b>[Output Power]</b> Output power. Note: This parameter can be assigned to an analog output.	Default:	Read Only	Real	
				Min/Max:	0.00 / 9999.99		
				Units:	kW		




## Motor Control File


File	Group	No.	Parameter Name & Description <small>See page 117 for symbol descriptions</small>	Values	Data Type	Related
MOTOR CONTROL	Motor Data	21	<p><b>[Min Firing Angle]</b> Specifies the minimum SCR firing angle (Alpha) that the drive can command. This parameter should only be changed in applications where full speed is needed with a low AC line or operating in overload. Note: See Parameter 21 [Min Firing Angle] Configuration on page 320 for detailed configuration instructions. This parameter was added for firmware revision 7.001.</p> <p> <b>ATTENTION:</b> When the drive is capable of regenerating power back to the AC line, external inverting fault protection must be provided in the form of circuit breakers or fuses. Failure to provide this protection could result in machine or equipment damage.</p>	Default: 25 Min/Max: 5/ 25 Units: Deg	16-bit Int	165
		45	<p><b>[Max Ref Speed]</b> Highest speed reference that can be commanded. The value of this parameter also scales external speed reference values (rpm) to internal units (counts), including analog inputs (10V = Par 45 rpm). Rated motor speed is determined via Par 456 [Fld Weaken Ratio] when field weakening is used. If field weakening is not used, set this parameter to the motor base speed. Notes: If a speed feedback device is used (encoder, resolver, or tachometer), see Drive Reference and Feedback Scaling on page 296 for instructions. The maximum value was changed from "16383" for firmware revision 3.001.</p>	Default: 1750 Min/Max: 1 / 6000 Units: rpm	32-bit Int	2, 456
		162	<p><b>[Max Feedback Spd]</b> Specifies the scaling between internal (counts) and external speed feedback values. Typically, this parameter is set to the same value as Parameter 45 [Max Ref Speed]. If an analog (DC) tachometer is used, this parameter's value must be set to be compatible with the S4 switches on the control board (see DIP Switch and Jumper Settings on page 77). If armature voltage feedback is used, this parameter must be set to the motor nameplate base speed. Set Par 585 [Overspeed Val] 10% higher than the value entered into Par 162. Rated motor speed is determined via Par 456 [Fld Weaken Ratio] when field weakening is used. If field weakening is not used, set this parameter to the motor base speed. Notes: If a speed feedback device is used (encoder, resolver, or tachometer), see Drive Reference and Feedback Scaling on page 296 for instructions. The maximum value was changed from "16383" for firmware revision 3.001.</p>	Default: 1750.00 Min/Max: 1.00 / 6000 Units: rpm	Real	169, 414, 456, 458, 585
		175	<p><b>[Rated Motor Volt]</b> Maximum armature voltage of the drive. Typically, this value is set to the Motor Nameplate Armature voltage. When Par 469 [Field Mode Sel] is set to 1 "Field Weaken", 4 "Wired FC FW", or 5 "Fiber FC FW" the value in this parameter equals the voltage at which the field weakening phase begins. Note: This parameter affects the threshold of an overvoltage condition, as indicated by an "Arm Overvoltage" fault (F5).</p>	Default: 240.0 Min/Max: 20.0 / 999.0 Units: V	Real	162, 169, 469, 481
		179	<p><b>[Nom Mtr Arm Amps]</b> Rated motor nameplate armature current. The settings for the current limit and the overload function are based on this current value. Also, set this value to be greater than 1/3 the value of Par 465 [Drive Size].</p>	Default: Based on drive current rating Min/Max: 0.10 / Based on drive current rating Units: A	Real	465
		201	<p><b>[Drive Type Sel]</b> <b>Important:</b> This parameter is only applicable to non-regenerative (2-quadrant) drives. <b>A</b> Allows non-regenerative drives to use an external 4-quadrant controller. • "On" = Ramp, Speed, Torque current references and Speed measurement have the same behavior as a four quadrant drive.</p> <p> <b>ATTENTION:</b> Failure to set this parameter to a value appropriate for the intended application could result in equipment damage and/or personal injury.</p>	Default: 0 = "Off" Options: 0 = "Off" 1 = "On"	16-bit Int	



File	Group	No.	Parameter Name & Description <small>See page 117 for symbol descriptions</small>	Values	Data Type	Related
MOTOR CONTROL	Motor Data		<b>280</b> <b>[Nom Mtr Fld Amps]</b> Rated motor nameplate field current ( $I_{dFN}$ ). Leave set to the default value for permanent magnet motor applications. For PowerFlex DC Field Controller applications, set the value in this parameter equal to the value of Par 374 [Drv Fld Brdg Curr].	Default: Par 374 [Drv Fld Brdg Cur] x 0.33 Min/Max: 0.00 / [Drv Fld Brdg Cur] Units: A	Real	374
			<b>333</b> <b>[MtrOvrld Factor]</b> Sets the derating factor for motor overload. The derating begins when the motor speed is below the value set in Par 334 [MtrOvrld Speed]. The motor overload level is determined by Par 376 [MtrOvrld Type] ("StandardDuty" is 150% of Par 179 [Nom Mtr Arm Amps] for 60 sec. or 200% for 3 sec., "HeavyDuty" is 200% for 60 sec.) and is linearly decreased from its maximum to the value of the motor overload factor at zero speed (zero speed is defined by Par 107 [Zero Speed Level]). This parameter can be used to lower the level of current that will cause the motor overload function to trip based on motor speed (The trip action is determined by Par 479 [MtrOvrld Flt Cfg]). For example, a value of 70% implies continuous operation up to 100% of motor nameplate current when operating above the value of Par 334 [MtrOvrld Speed] and only 70% (1.00 * 70%) of motor nameplate current when operating at zero speed. Setting this parameter to 100% disables the motor overload derating function so the standard motor overload function is always active. Note: This parameter was added for firmware revision 6.001.	Default: 70 Min/Max: 20 / 100 Units: %	16-bit Int	
			<b>334</b> <b>[MtrOvrld Speed]</b> Sets the motor speed (as a percentage of Par 45 [Max Ref Speed]) where the derating factor (Par 333 [MtrOvrld Factor]) for motor overload capacity begins. The motor overload capacity is linearly reduced when operating below [MtrOvrld Speed]. This is to account for the reduced self-cooling capability of typical motors operating at slower speeds. For motors with low speed cooling capacity (for example, blower cooling), reduce this setting to take full advantage of the motor being used. Setting this parameter to 0% disables the motor overload derating function so the standard overload function is independent of motor speed. Note: This parameter was added for firmware revision 6.001.	Default: 0 Min/Max: 0 / 100 Units: %	16-bit Int	
			<b>374</b> <b>[Drv Fld Brdg Cur]</b> Drive rated field bridge current ( $I_{dFN}$ ). The value in this parameter must be set equal to the value chosen with DIP switch S14 on the control board (see <a href="#">Table 16</a> on page 62 for DIP switch configuration). Leave set to the default value for permanent magnet motor applications. For PowerFlex DC Field Controller applications, set the value of this parameter to the motor field rating. Note: Changed the max. value from 80.00 for firmware revision 7.001	Default: 1.00 Min/Max: 0.50 / 570.00 Units: A	Real	
		 	<b>376</b> <b>[MtrOvrld Type]</b> Allows selection of the type of motor overload calculation based on Par 179 [Motor Arm Amps]. <ul style="list-style-type: none"> <li>StandardDuty = 150% load for 1 minute or 200% load for 3 seconds before a motor overload condition is indicated.</li> <li>HeavyDuty = 200% load for 1 minute before a motor overload condition is indicated (250% for 30 sec). This selection requires that the drive be oversized relative to the motor to be able to provide the necessary current without faulting from a "Drive Overload" (F64).</li> </ul> Note: This parameter was added for firmware revision 3.001.	Default: 0 = "StandardDuty" Options: 0 = "StandardDuty" 1 = "HeavyDuty"	16-bit Int	179, 479, 1290











File	Group	No.	Parameter Name & Description <small>See page 117 for symbol descriptions</small>	Values	Data Type	Related								
MOTOR CONTROL	Motor Data	464	<b>[SAR Volts Scale]</b> Scales the following parameters so that they show actual voltage values rather than drive calculated values when in Standalone Regulator (SAR) mode: <table border="1" style="width: 100%; margin-top: 5px;"> <tr> <td>175 [Motor Rated Volt]</td> <td>495 [Arm Volt Kp Base]</td> </tr> <tr> <td>233 [Output Voltage]</td> <td>496 [Arm Volt Ki Base]</td> </tr> <tr> <td>466 [AC Line Voltage]</td> <td>1052 [Output Power]</td> </tr> <tr> <td>481 [Undervolt Thresh]</td> <td>1374 [Fault Voltage]</td> </tr> </table> <p>Notes: This parameter was added for firmware revision 4.001. See Appendix H PowerFlex DC Standalone Regulator Installation on page 397 for more information.  <b>Important:</b> When the drive is not in SAR mode, this parameter is clamped to the default value (1.0).</p>	175 [Motor Rated Volt]	495 [Arm Volt Kp Base]	233 [Output Voltage]	496 [Arm Volt Ki Base]	466 [AC Line Voltage]	1052 [Output Power]	481 [Undervolt Thresh]	1374 [Fault Voltage]	Default: 1.0 Min/Max: 0.5 / 10.0	Real	
		175 [Motor Rated Volt]	495 [Arm Volt Kp Base]											
		233 [Output Voltage]	496 [Arm Volt Ki Base]											
		466 [AC Line Voltage]	1052 [Output Power]											
		481 [Undervolt Thresh]	1374 [Fault Voltage]											
	91	 <b>[Fld Reg Kp]</b> Proportional gain ( $K_p$ ) of the flux regulator expressed as a percentage of Par 97 [Fld Reg Kp Base]. Leave set to the default value for permanent magnet motor or PowerFlex DC Field Controller applications.	Default: 2.00 Min/Max: 0.00 / 100.00 Units: %	Real	97									
	92	 <b>[Fld Reg Ki]</b> Integral gain ( $K_i$ ) of the flux regulator expressed as a percentage of Par 98 [Fld Reg Ki Base]. Leave set to the default value for permanent magnet motor or PowerFlex DC Field Controller applications.	Default: 1.00 Min/Max: 0.00 / 100.00 Units: %	Real	98									
	97	 <b>[Fld Reg Kp Base]</b> The proportional gain ( $K_{p0}$ ) of the field current regulator (base value). Leave set to the default value for permanent magnet motor or PowerFlex DC Field Controller applications.	Default: 3276.70 Min/Max: 0.10 / 32767.00	Real	91									
	98	 <b>[Fld Reg Ki Base]</b> Integral gain ( $K_{i0}$ ) of the field current regulator in (base value). Leave set to the default value for permanent magnet motor or PowerFlex DC Field Controller applications.	Default: 3276.70 Min/Max: 0.10 / 32767.00	Real	92									
	410	 <b>[Ext FC Curr Hyst]</b> Defines the armature percentage threshold in the reverse direction that causes field inversion. Note: This parameter was added for firmware revision 7.001.	Default: 5 Min/Max: 1 / 100 Units: %	16-bit Int	411, 412									
	456	 <b>[Fld Weaken Ratio]</b> The ratio of Motor Nameplate Base Speed to Par 45 [Max Ref Speed] when Par 469 [Field Mode Sel] 1 "Field Weaken", 4 "Wired FC FW", or 5 "Fiber FC FW". This value is the percentage of the maximum application speed when field weakening will begin: "Motor Base Speed" / Par 45 [Max Ref Speed] x 100. If Par 469 [Field Mode Sel] = 0 "Base Speed", this parameter must be = 100%. Leave set to the default value for permanent magnet motor applications.	Default: 100 Min/Max: 0 / 100 Units: %	16-bit Int	921, 469									
	462	 <b>[Flux Divide]</b> Selects division by flux for Inertia Compensation or Torque Reference. Leave set to the default value for permanent magnet motor applications. Note: Added for firmware revision 3.001.	Default: 0 = "Torque Ref" Options: 0 = "Torque Ref" 1 = "Inertia Comp"	16-bit Int										
	463	 <b>[Flux Filter BW]</b> Adjustable low pass filter on the value of Par 500 [Flux Ref Pct]. The filtered result is used by the Torque Reference divide by flux function. Leave set to the default value for permanent magnet motor applications. Note: Added for firmware revision 3.001.	Default: 50 Min/Max: 0 / 2000 Units: ms	16-bit Int										
		Field Config												







File	Group	No.	Parameter Name & Description <small>See page 117 for symbol descriptions</small>	Values	Data Type	Related	
MOTOR CONTROL	Field Config	467	<b>[Max Fld Flux Pct]</b> Maximum allowable field flux. The maximum value (100%) corresponds to the value set in Par 280 [Nom Mtr Fld Amps]. The value of this field linearly affects the field current, unless a flux curve is set in Pars 916, 917, and 918 [Fld Const xx Pct]. Leave set to the default value for permanent magnet motor applications. Note: This parameter can be assigned to an analog input or output.	Default: 100 Min/Max: Par 468 [Min Fld Curr Pct] / 100 Units: %	16-bit Int	468	
		 <b>ATTENTION:</b> Failure to set this parameter to a value appropriate for the intended application could result in excessive motor speed, equipment damage, and/or bodily injury.					
		468	<b>[Min Fld Curr Pct]</b> Minimum allowable field current. The value set in this parameter also influences the threshold at which the "Fld Current Loss" (F6) fault occurs. The threshold is half of the value of Par 468 [Min Fld Curr Pct]. The value of Par 351 [Field Current] equals the value of this parameter when Par 499 [Field Economy En] = 1 "Enabled" and Field Economy becomes active. Leave set to the default value for permanent magnet motor applications.	Default: 30 Min/Max: 0 / Par 467 [Max Fld Flux Pct] Units: %	16-bit Int	467, 499	
		 <b>ATTENTION:</b> Failure to set this parameter to a value appropriate for the intended application could result in excessive motor speed, equipment damage, and/or personal injury.					
		469	 <b>[Field Mode Sel]</b> Operating mode of the field controller. <ul style="list-style-type: none"> <li>"Base Speed" = The motor field is regulated with constant current and controls the motor from zero to base speed. If a curve is defined through Pars 916, 917 and 918 [Fld Const xx Pct], this value will change linearly through Par 467 [Max Fld Flux Pct] (which is a percentage of the nominal flux value set in Par 280 [Nom Mtr Fld Amps]).</li> <li>"Field Weaken" = The motor field is regulated with a combination of torque and constant power (armature and field regulation -- field weakening). The maximum armature voltage is configured in Par 175 [Rated Motor Volt]. When using a DC contactor, this parameter is set to this option, and Par 458 [SpdReg FB Bypass] is set to 1 "Enabled," the armature voltage feedback terminals A1 and A2 must be connected to the motor terminals A1 and A2, respectively.</li> <li>"External" = The motor field power is supplied by an external rectifier/converter (the drive's field output is disabled).</li> <li>"PM External" = External field created by a permanent magnet (PM) motor.</li> <li>"Wired FC FW" = Motor field with weakening regulated by PowerFlex DC Field Controller via a wired connection.</li> <li>"Fiber FC FW" = Motor field with weakening regulated by PowerFlex DC Field Controller via a fiber-optic cable connection.</li> <li>"Wired FC BS" = Motor field (no weakening) regulated by PowerFlex DC Field Controller via a wired connection.</li> <li>"Fiber FC BS" = Motor field (no weakening) regulated by PowerFlex DC Field Controller via a fiber-optic cable connection.</li> </ul> Notes: Option 3 "PM External" was added for firmware revision 5.002. Options 4...7 were added for firmware revision 7001.	Default: 0 = "Base Speed" Options: 0 = "Base Speed", 1 = "Field Weaken", 2 = "External", 3 = "PM External", 4 = "Wired FC FW", 5 = "Fiber FC FW", 6 = "Wired FC BS", 7 = "Fiber FC BS"	16-bit Int	456, 916, 917, 918, 921	
493	<b>[Arm Volt Kp]</b> Proportional gain ( $K_p$ ) of the field voltage regulator expressed as a percentage of the value defined in Par 495 [Arm Volt Kp Base]. This parameter is not used when Par 469 [Field Mode Sel] is set to 4...7 (external field is controller by a PowerFlex DC Field Controller).	Default: 30.00 Min/Max: 0.00 / 100.00 Units: %	Real	495			
494	<b>[Arm Volt Ki]</b> Integral gain ( $K_i$ ) of the field voltage regulator expressed as a percentage of the value defined in Par 496 [Arm Volt Ki Base]. This parameter is not used when Par 469 [Field Mode Sel] is set to 4...7 (external field is controller by a PowerFlex DC Field Controller).	Default: 40.00 Min/Max: 0.00 / 100.00 Units: %	Real	496			

File	Group	No.	Parameter Name & Description <small>See page 117 for symbol descriptions</small>	Values	Data Type	Related	
MOTOR CONTROL	Field Config	495	<b>[Arm Volt Kp Base]</b> The proportional gain ( $K_{p0}$ ) of the field voltage regulator (base value). This parameter is not used when Par 469 [Field Mode Sel] is set to 4...7 (external field is controller by a PowerFlex DC Field Controller).	Default: Based on drive current rating Min/Max: 0.10 / Based on drive current rating Units: A / V	Real	493	
		496	<b>[Arm Volt Ki Base]</b> The integral coefficient ( $K_{i0}$ ) of the field voltage regulator (base value). This parameter is not used when Par 469 [Field Mode Sel] is set to 4...7 (external field is controller by a PowerFlex DC Field Controller).	Default: 0.90 x P496 <sub>max</sub> Min/Max: 0.01 / Based on drive current rating Units: A / V / ms	Real	494	
		497	<b>[Field Reg Enable]</b> Enables/Disables the field regulator. Leave set to the default value for permanent magnet motor applications. • "Enabled" = The field regulator is enabled and controlling the field output. • "Disabled" = The field regulator is disabled (the field current is zero).	Default: 1 = "Enabled" Options: 0 = "Disabled" 1 = "Enabled"	16-bit Int		
		498	<b>[Force Min Field]</b> Enables/Disables the minimum field current value. Leave set to the default value for permanent magnet motor applications. • "Enabled" = The field current corresponds to the value set via Par 468 [Min Fld Curr Pct]. • "Disabled" = The field current is regulated based on the quadrant mode and situation in which the drive is operating. Note: This parameter can be assigned to a digital input (35 "Force MinFld").	Default: 0 = "Disabled" Options: 0 = "Disabled" 1 = "Enabled"	16-bit Int		
		 <b>ATTENTION:</b> Enabling (forcing) the minimum field current while the drive is running could result in excessive motor speed, equipment damage, and/or bodily injury.					
		499	<b>[Field Economy En]</b> When this parameter is set to 1 = "Enabled" and the value in Par 107 [Speed Zero Level] is reached (after the amount of time specified in Par 1407 [Field Econ Delay] has elapsed), the minimum field current (set via Par 468 [Min Fld Curr Pct]) is produced. Leave set to the default value for permanent magnet motor applications. • "Disabled" = Disables field economy • "Enabled" = Enables field economy	Default: 1 = "Enabled" Options: 0 = "Disabled" 1 = "Enabled"	16-bit Int	395, 468, 1407	
		916	<b>[Fld Const 40 Pct]</b> This value corresponds to the field current required to produce 40% armature voltage when the motor is running at base speed. Leave set to the default value for permanent magnet motor applications.	Default: 40.00 Min/Max: 0.00 / 100.00 Units: %	Real	469	
		917	<b>[Fld Const 70 Pct]</b> This value corresponds to the field current required to produce 70% armature voltage when the motor is running at base speed. Leave set to the default value for permanent magnet motor applications.	Default: 70.00 Min/Max: 0.00 / 100.00 Units: %	Real	469	
		918	<b>[Fld Const 90 Pct]</b> This value corresponds to the field current required to produce 90% armature voltage when the motor is running at base speed. Leave set to the default value for permanent magnet motor applications.	Default: 90.00 Min/Max: 0.00 / 100.00 Units: %	Real	469	
		919	<b>[Set Fld Curve]</b> When set to "0", this parameter controls the motor field current to field reference curve according to the values specified in the [Fld Const xx Pct] parameters. With this curve is defined, the result of [Max Fld Flux Pct] / [Flux Ref Pct] equals the percentage of field current according to the characteristic of the curve. This field is Write Only. After the value of this field is set to "0", it will automatically return to "1". Leave set to the default value for permanent magnet motor applications. Note: See Tuning the Field Current Curve on page 358 for more information.	Default: 1 Min/Max: 0 / 1	16-bit Int	916, 917, 918	

File	Group	No.	Parameter Name & Description <small>See page 117 for symbol descriptions</small>	Values	Data Type	Related
MOTOR CONTROL	Field Config	920 	<b>[Reset Fld Curve]</b> When set to "1", resets the drive to use a linear field curve. When this parameter is set, Par 280 [Nom Mtr Fld Amps] is linearly changed through [Max Fld Flux Pct] / [Flux Ref Pct]. This field is Write Only. After the value of this field is set to "1", it will automatically return to "0". Leave set to the default value for permanent magnet motor applications.	Default: 0 Min/Max: 0 / 1 Units:	16-bit Int	
		921 	<b>[Out Volt Level]</b> The percentage of maximum output voltage based on the value in Par 175 [Rated Motor Volt]. In regenerative, field-weakened applications (hoist, elevator, unwinder, etc.) set the value of this parameter less than 100%, to allow operation when overcoming gravity. The value of this parameter also determines the voltage where the drive begins field de-fluxing while Field Weaken mode is active (Par 469 [Field Mode Sel] = 1 "Field Weaken", 4 "Wired FC FW", or 5 "Fiber FC FW"). Leave set to the default value for permanent magnet motor applications. Notes: This parameter can be assigned to an analog output or analog input (by selecting "Out Volt Lvl"). The maximum value of this parameter was changed from "100" for firmware revision 3.001.	Default: 100.0 Min/Max: 0.0 / 110.0 Units: %	Real	469
		1407	<b>[Field Econ Delay]</b> Amount of time to elapse once the drive reaches zero speed (as determined by Par 107 [Speed Zero Level]) before field economy becomes active. Leave set to the default value for permanent magnet motor applications.	Default: 300 Min/Max: 0 / 1800 Units: s	16-bit Int	107, 499
	Torq Attributes	7	<b>[Current Limit]</b> Symmetrical current limit expressed as a percentage of the value in Par 179 [Nom Mtr Arm Amps]. This value applies to both current directions for four quadrant drives. • If Par 7 [Current Limit] is changed, Pars 8 [Current Lim Pos] and 9 [Current Lim Neg] are set to the same value. If either the value of Pars 8 [Current Lim Pos] or 9 [Current Lim Neg] is changed later, the last change is valid. Note: The maximum value for this parameter has been changed from 200% to 250% for firmware revision 5.006.	Default: 150 Min/Max: 0 / 250 Units: %	16-bit Int	8, 9, 179
		8	<b>[Current Lim Pos]</b> The drive current limit for the positive current direction expressed as a percentage of the value in Par 179 [Nom Mtr Arm Amps]. Notes: This parameter can be assigned to an analog input. The maximum value for this parameter has been changed from 200% to 250% for firmware revision 5.006.	Default: 150 Min/Max: 0 / 250 Units: %	Real	7
		9	<b>[Current Lim Neg]</b> The drive current limit for the negative current direction expressed as a percentage of the value in Par 179 [Nom Mtr Arm Amps]. This parameter is not active for two quadrant drives. Notes: This parameter can be assigned to an analog input. The maximum value for this parameter has been changed from 200% to 250% for firmware revision 5.006.	Default: 150 Min/Max: 0 / 250 Units: %	Real	7
		12	<b>[Current Rate Lim]</b> Specifies the largest change in armature current reference that will be allowed per current loop scan (2.7 ms @ 60Hz, 3.3 ms @ 50Hz AC line frequency). A value of 100% indicates that the armature current reference will not be permitted to change by more than rated motor current in a given speed loop scan period. Note: This parameter was added for firmware revision 5.002.	Default: 25 Min/Max: 0.1 / 250 Units: %	Real	
		39	<b>[Torque Ref]</b> First current reference value, before any trim signals are incorporated, as a percentage of the value set in Par 179 [Nom Mtr Arm Amps]. For firmware revision 2.005 or lower, this parameter is only used when Par 242 [Speed Reg En] = 0 "Disabled". Note: The current reference value is proportional to the armature current of the motor and determines the torque. The polarity determines the torque direction.	Default: 0 Min/Max: - / +200 Units: %	Real	

File	Group	No.	Parameter Name & Description <small>See page 117 for symbol descriptions</small>	Values	Data Type	Related
MOTOR CONTROL	Torq Attributes	40	<b>[Trim Torque]</b> Second current reference value as a percentage of the value set in Par 179 [Nom Mtr Arm Amps]. [Trim Torque] is added to Torque Reference and can be used as a correction value for the torque reference (regardless of the value of Par 242 [Speed Reg En]).	Default: 0 Min/Max: - / +200 Units: %	Real	
		342	<b>[Torque Reduction]</b> Selection for torque reduction. When the torque reduction function is active (1 "Active"), the current limit changes accordingly by the percentage defined in Par 13 [Torq Red CurLim]. When this parameter is set to 0 "Not Active", torque reduction is not active. For example: Par 7 [Current Limit] (or Pars 8 [Current Lim Pos] and 9 [Current Lim Neg]) = 80% Par 13 [Torq Red CurLim] = 70% If Par 342 [Torque Reduction] = 0 "Not Active", the current limit = 80% If Par 342 [Torque Reduction] = 1 "Active", the current limit = 70% Note: This parameter can be assigned to a digital input.	Default: 0 = "Not Active" Options: 0 = "Not Active" 1 = "Active"	16-bit Int	13
		353	<b>[Zero Torque]</b> Sets the reference value for the armature current (Par 41 [Current Reg In]) to zero so that the drive has no torque. • "Not Active" = Par 41 [Current Reg In] is not set to zero. • "Active" = Par 41 [Current Reg In] is set zero. The drive has no torque.	Default: 1 = "Not Active" Options: 0 = "Active" 1 = "Not Active"	16-bit Int	41
		411	<b>[FC Lim Ramp]</b> Enables an armature current limit ramp after a field inversion.  Note: Added for firmware revision 7.001	Default: 0 = "Disabled" Options: 0 = "Disabled" 1 = "Enabled"	16-bit Int	410, 411
		412	<b>[FC Lim Ramp Time]</b>  Armature current limit ramp time after field inversion (if enabled through P411 [FC Lim Ramp]). Note: Added for firmware revision 7.001	Default: 800 Min/Max: 200 / 10000 Units: ms	16-bit Int	410, 411
		750	<b>[TrqTpr Enable]</b>  Enables/Disables the current/speed curve function. • "Disabled" = The limits current /speed curve is disabled • "Enabled" = The limits current /speed curve is enabled Note: See Current / Speed Curve on page 294 for more information.	Default: 0 = "Disabled" Options: 0 = "Disabled" 1 = "Enabled"	16-bit Int	751, 752, 753, 754, 755, 756
		751	<b>[TrqTpr Lim0]</b>  The current limit of the current/speed curve that operates constantly up to the speed set in Par 756 [TrqTpr Spd]. When the current/speed curve function is enabled (set in Par 750 [TrqTpr Enable]), this parameter will override the current limits set in Pars 10 [Cur Lim Pos Out] and 11 [Cur Lim Neg Out].	Default: 0 Min/Max: 0 / 200 Units: %	16-bit Int	750, 756
		752	<b>[TrqTpr Lim1]</b>  First reduced current limit of the current/speed curve. The value defined in this parameter must be less than the value in Par 751 [TrqTpr Lim0] and greater than the values in Pars 753 [TrqTpr Lim2], 754 [TrqTpr Lim3] and 755 [TrqTpr Lim4].	Default: 0 Min/Max: 0 / 200 Units: %	16-bit Int	750, 756
		753	<b>[TrqTpr Lim2]</b>  Second reduced current limit of the current/speed curve. The value defined in this parameter must be less than the value in Par 752 [TrqTpr Lim1] and greater than the values in Pars 754 [TrqTpr Lim3] and 755 [TrqTpr Lim4].	Default: 0 Min/Max: 0 / 200 Units: %	16-bit Int	750, 756
		754	<b>[TrqTpr Lim3]</b>  Third reduced current limit of the current/speed curve. The value defined in this parameter must be less than the value in Par 753 [TrqTpr Lim2] and greater than the value in Par 755 [TrqTpr Lim4].	Default: 0 Min/Max: 0 / 200 Units: %	16-bit Int	750, 756
		755	<b>[TrqTpr Lim4]</b>  Last reduced current limit of the current/speed curve. The value defined in this parameter must be less than the value in Par 754 [TrqTpr Lim3]. The drive will operate at this current limit up to the value set in parameter 162 [Max Feedback Spd].	Default: 0 Min/Max: 0 / 200 Units: %	16-bit Int	750, 756







File	Group	No.	Parameter Name & Description <small>See page 117 for symbol descriptions</small>	Values	Data Type	Related																																																																																																													
MOTOR CONTROL	Torq Attributes	756 	<b>[TrqTpr Spd]</b> Threshold speed at which torque reduction begins, as determined by the current/speed curve.	Default: 0 Min/Max: 0 / Par 162 Units: rpm	16-bit Int	750, 756																																																																																																													
		926 	<b>[Torq Cur Filter]</b> First rate low-pass filter for Par 1193 [Torq Current Pct]. Note: The name of this parameter was changed from [Filt Torq Cur] for firmware revision 3.001.	Default: 0.100 Min/Max: 0.001 / 0.250 Units: s	Real	1193																																																																																																													
	Speed Feedback	169 	<b>[Encoder PPR]</b> Number of pulses per revolution of the digital encoder. The value of Pars 169 [Encoder PPR] and 162 [Max Feedback Spd] must be set as indicated in Valid Speed Feedback Values on page 300.	Default: 1024.00 Min/Max: 100.00 / 32770.00	Real	162																																																																																																													
		170 	<b>[Encoder Config]</b> Configures the encoder moving average filter. • Bits 0 "Move Avg b0", 1 "Move Avg b1", and 2 "Move Avg b2" - Select the moving average speed filter period (see Table 170A: Moving Average below). Note: This parameter was added for firmware revision 6.001.																																																																																																																
		<table border="1"> <thead> <tr> <th>Options</th> <th>Reserved</th> <th>Reserved</th> <th>Reserved</th> <th>Reserved</th> <th>Reserved</th> <th>Reserved</th> <th>Reserved</th> <th>Reserved</th> <th>Reserved</th> <th>Reserved</th> <th>Reserved</th> <th>Reserved</th> <th>Reserved</th> <th>Reserved</th> <th>Move Avg b2</th> <th>Move Avg b1</th> <th>Move Avg b0</th> </tr> </thead> <tbody> <tr> <td>Default</td> <td>x</td> <td>x</td> <td>x</td> <td>x</td> <td>x</td> <td>x</td> <td>x</td> <td>x</td> <td>x</td> <td>x</td> <td>x</td> <td>x</td> <td>x</td> <td>x</td> <td>0</td> <td>0</td> <td>1</td> </tr> <tr> <td>Bit</td> <td>15</td> <td>14</td> <td>13</td> <td>12</td> <td>11</td> <td>10</td> <td>9</td> <td>8</td> <td>7</td> <td>6</td> <td>5</td> <td>4</td> <td>3</td> <td>2</td> <td>1</td> <td>0</td> <td></td> </tr> </tbody> </table> <p><b>Table 170A - Moving Average</b></p> <table border="1"> <thead> <tr> <th colspan="4">Bit</th> <th>Filter Period</th> <th colspan="4">Bit</th> <th>Filter Period</th> </tr> <tr> <th>2</th> <th>1</th> <th>0</th> <th></th> <th></th> <th>2</th> <th>1</th> <th>0</th> <th></th> </tr> </thead> <tbody> <tr> <td>0</td> <td>0</td> <td>0</td> <td>2 ms</td> <td></td> <td>1</td> <td>0</td> <td>0</td> <td>16 ms</td> </tr> <tr> <td>0</td> <td>0</td> <td>1</td> <td>4 ms</td> <td></td> <td>1</td> <td>0</td> <td>1</td> <td>2 ms</td> </tr> <tr> <td>0</td> <td>1</td> <td>0</td> <td>8 ms</td> <td></td> <td>1</td> <td>1</td> <td>0</td> <td>2 ms</td> </tr> <tr> <td>0</td> <td>1</td> <td>1</td> <td>2 ms</td> <td></td> <td>1</td> <td>1</td> <td>1</td> <td>2 ms</td> </tr> </tbody> </table>						Options	Reserved	Reserved	Reserved	Reserved	Reserved	Reserved	Reserved	Reserved	Reserved	Reserved	Reserved	Reserved	Reserved	Reserved	Move Avg b2	Move Avg b1	Move Avg b0	Default	x	x	x	x	x	x	x	x	x	x	x	x	x	x	0	0	1	Bit	15	14	13	12	11	10	9	8	7	6	5	4	3	2	1	0		Bit				Filter Period	Bit				Filter Period	2	1	0			2	1	0		0	0	0	2 ms		1	0	0	16 ms	0	0	1	4 ms		1	0	1	2 ms	0	1	0	8 ms		1	1	0	2 ms	0	1	1	2 ms		1	1	1
	Options	Reserved	Reserved	Reserved	Reserved	Reserved	Reserved	Reserved	Reserved	Reserved	Reserved	Reserved	Reserved	Reserved	Reserved	Move Avg b2	Move Avg b1	Move Avg b0																																																																																																	
	Default	x	x	x	x	x	x	x	x	x	x	x	x	x	x	0	0	1																																																																																																	
Bit	15	14	13	12	11	10	9	8	7	6	5	4	3	2	1	0																																																																																																			
Bit				Filter Period	Bit				Filter Period																																																																																																										
2	1	0			2	1	0																																																																																																												
0	0	0	2 ms		1	0	0	16 ms																																																																																																											
0	0	1	4 ms		1	0	1	2 ms																																																																																																											
0	1	0	8 ms		1	1	0	2 ms																																																																																																											
0	1	1	2 ms		1	1	1	2 ms																																																																																																											
414 	<b>[Fdbk Device Type]</b> The source of speed feedback. It is strongly recommended that a feedback device be used when running a permanent magnet motor. • 1 "Encoder" = Digital encoder (jumpers S20, S21, see page 78) • 2 "DC Tach" = DC analog tachometer (jumper S4, see page 78) • 3 "Armature" = Internal measurement of the armature voltage • 4 "Resolver" = The resolver feedback module must be installed and configured Note: Option 4 "Resolver" was added for firmware revision 5.002.	Default: 3 = "Armature" Options: 1 = "Encoder", 2 = "DC Tach", 3 = "Armature", 4 = "Resolver"	16-bit Int																																																																																																																
422 	<b>[Fdbk Option ID]</b> Displays information about the resolver feedback option module (if installed). Module ID (bits 15...11), Version (bits 10...6), Revision High (bits 5...3), Revision Low (bits 2...0) (For example, a value of 6217 indicates Module ID 3, Version 1, Revision 1.1). If no resolver module is detected this value will be set to 0. Note: This parameter was added for firmware revision 5.002.	Default: Read Only Min/Max: 0 / 8191	16-bit Int																																																																																																																












File	Group	No.	Parameter Name & Description <small>See page 117 for symbol descriptions</small>	Values	Data Type	Related
MOTOR CONTROL	Speed Feedback	423	<p><b>[Reslvr Type Sel]</b>                         The type of resolver used. See Resolver Type Selection on page 329 for descriptions of the attributes associated with each resolver type. To use the resolver as a speed feedback device, Par 414 [Fdbk Device Type] must = 4 "Resolver".  <b>Important:</b> After changing this parameter power to the drive must be cycled to have the new value incorporated into the resolver feedback module's operation.                      Note: This parameter was added for firmware revision 5.002.</p>	Default: 1 = "T2014x1/AMCI" Options: 1 = "T2014x1/AMCI" 2 = "T2014x2/2087" 3 = "T2014x5/2087" 4 = "Resolver 04" 5 = "Resolver 05" 6 = "Resolver 06" 7 = "Resolver 07" 8 = "Resolver 08" 9 = "Resolver 09" 10 = "Resolver 10" 11 = "Resolver 11" 12 = "Resolver 12" 13 = "Resolver 13" 14 = "Resolver 14" 15 = "Resolver 15"	16-bit Int	414
		 <b>ATTENTION:</b> If the incorrect resolver type is selected in Par 423 [Reslvr Type Sel], the resolver could be subject to excessive voltage and/or the motor could run at excessive speed or become damaged, which could result in personal injury or destruction of equipment.				
		424	<p><b>[Reslvr Spd Ratio]</b>                         Ratio of resolver electrical to mechanical turns (a value of "x5" means 5 electrical turns for each mechanical revolution). The selected value must match the resolver selected in Par 423 [Reslvr Type Sel] for correct speed determination. This parameter affects the maximum speed that can be measured by the resolver, see Table 425A, in Par 425 [Resolver Config], for limitations. See Resolver Type Selection on page 329 for descriptions of the attributes associated with each resolver type.                      Note: This parameter was added for firmware revision 5.002.</p>	Default: 1 = "x1" Options: 1 = "x1" 2 = "x2" 3 = "x3" 4 = "x4" 5 = "x5"	16-bit Int	423, 425
 <b>ATTENTION:</b> If the incorrect resolver speed ratio is selected in Par 424 [Reslvr Spd Ratio], the motor could run at excessive speed or become damaged, which could result in personal injury or destruction of equipment.						







File	Group	No.	Parameter Name & Description <small>See page 117 for symbol descriptions</small>	Values	Data Type	Related																																																													
MOTOR CONTROL	Speed Feedback	425	<p><b>[Resolver Config]</b> Configures the attributes of the resolver feedback module.</p> <ul style="list-style-type: none"> <li>Bits 2 "Resolution 0" and 3 "Resolution 1" - Select the resolver to digital conversion resolution. See Table 425A: Resolution Settings below for selections. The selection of resolver resolution affects the maximum speed that can be measured by the resolver. These numbers are theoretical and actual limits could be higher based the application of the drive. Note the maximum speed of the drive is 6000 rpm.</li> <li>Bit 4 "Energize" - Energizes the resolver. Setting the bit to zero de-energizes the resolver (typically, leave set = 1).</li> <li>Bit 5 "Resolver Dir" - Determines the counting direction. This bit can be used to change the resolver direction when it doesn't match the motor direction (that is, when wired backwards). 0 = forward (counting up), 1 = reverse (counting down).</li> </ul> <hr/> <div style="display: flex; align-items: center;"> <p><b>ATTENTION:</b> Changing bit 5 "Resolver Dir" when the resolver direction matches the motor direction and Par 414 [Fdbk Device Type] is set to 4 "Resolver" may cause the motor to run at excessive speed or become damaged, which could result in personal injury or destruction of equipment.</p> </div> <hr/> <ul style="list-style-type: none"> <li>Bits 10 "Move Avg b0", 11 "Move Avg b1", and 12 "Move Avg b2" - Select the moving average speed filter period (see Table 425B: Moving Average below).</li> </ul> <p>Note: This parameter was added for firmware revision 5.002.</p>																																																																
		<table border="1" style="width: 100%; border-collapse: collapse; text-align: center;"> <thead> <tr> <th>Options</th> <th>Reserved</th> <th>Reserved</th> <th>Reserved</th> <th>Move Avg b2</th> <th>Move Avg b1</th> <th>Move Avg b0</th> <th>Reserved</th> <th>Reserved</th> <th>Reserved</th> <th>Reserved</th> <th>Resolver Dir</th> <th>Energize</th> <th>Resolution 1</th> <th>Resolution 0</th> <th>Reserved</th> <th>Reserved</th> </tr> </thead> <tbody> <tr> <td>Default</td> <td>x</td> <td>x</td> <td>x</td> <td>0</td> <td>1</td> <td>0</td> <td>x</td> <td>x</td> <td>x</td> <td>x</td> <td>0</td> <td>1</td> <td>0</td> <td>0</td> <td>x</td> <td>x</td> </tr> <tr> <td>Bit</td> <td>15</td> <td>14</td> <td>13</td> <td>12</td> <td>11</td> <td>10</td> <td>9</td> <td>8</td> <td>7</td> <td>6</td> <td>5</td> <td>4</td> <td>3</td> <td>2</td> <td>1</td> <td>0</td> </tr> </tbody> </table>			Options	Reserved	Reserved	Reserved	Move Avg b2	Move Avg b1	Move Avg b0	Reserved	Reserved	Reserved	Reserved	Resolver Dir	Energize	Resolution 1	Resolution 0	Reserved	Reserved	Default	x	x	x	0	1	0	x	x	x	x	0	1	0	0	x	x	Bit	15	14	13	12	11	10	9	8	7	6	5	4	3	2	1	0												
Options	Reserved	Reserved	Reserved	Move Avg b2	Move Avg b1	Move Avg b0	Reserved	Reserved	Reserved	Reserved	Resolver Dir	Energize	Resolution 1	Resolution 0	Reserved	Reserved																																																			
Default	x	x	x	0	1	0	x	x	x	x	0	1	0	0	x	x																																																			
Bit	15	14	13	12	11	10	9	8	7	6	5	4	3	2	1	0																																																			
<p><b>Table 425A - Resolution Settings</b></p> <table border="1" style="width: 100%; border-collapse: collapse; text-align: center;"> <thead> <tr> <th colspan="2">Bit</th> <th rowspan="2">Resolution</th> <th colspan="3">Maximum Speed (rpm)</th> </tr> <tr> <th>3</th> <th>2</th> <th>x1</th> <th>x2</th> <th>x5</th> </tr> </thead> <tbody> <tr> <td>0</td> <td>0</td> <td>10 bit</td> <td>39,000</td> <td>19,500</td> <td>7800</td> </tr> <tr> <td>0</td> <td>1</td> <td>12 bit</td> <td>13,800</td> <td>6900</td> <td>2760</td> </tr> <tr> <td>1</td> <td>0</td> <td>14 bit</td> <td>3480</td> <td>1740</td> <td>696</td> </tr> <tr> <td>1</td> <td>1</td> <td>16 bit</td> <td>900</td> <td>450</td> <td>180</td> </tr> </tbody> </table>			Bit		Resolution	Maximum Speed (rpm)			3	2	x1	x2	x5	0	0	10 bit	39,000	19,500	7800	0	1	12 bit	13,800	6900	2760	1	0	14 bit	3480	1740	696	1	1	16 bit	900	450	180	<p><b>Table 425B - Moving Average</b></p> <table border="1" style="width: 100%; border-collapse: collapse; text-align: center;"> <thead> <tr> <th colspan="4">Bit</th> <th rowspan="2">Filter Period</th> </tr> <tr> <th>12</th> <th>11</th> <th>10</th> <th>Filter Period</th> </tr> </thead> <tbody> <tr> <td>0</td> <td>0</td> <td>0</td> <td>2 ms</td> </tr> <tr> <td>0</td> <td>0</td> <td>1</td> <td>4 ms</td> </tr> <tr> <td>0</td> <td>1</td> <td>0</td> <td>8 ms</td> </tr> <tr> <td>0</td> <td>1</td> <td>1</td> <td>2 ms</td> </tr> </tbody> </table>			Bit				Filter Period	12	11	10	Filter Period	0	0	0	2 ms	0	0	1	4 ms	0	1	0	8 ms	0	1	1	2 ms		
Bit		Resolution	Maximum Speed (rpm)																																																																
3	2		x1	x2	x5																																																														
0	0	10 bit	39,000	19,500	7800																																																														
0	1	12 bit	13,800	6900	2760																																																														
1	0	14 bit	3480	1740	696																																																														
1	1	16 bit	900	450	180																																																														
Bit				Filter Period																																																															
12	11	10	Filter Period																																																																
0	0	0	2 ms																																																																
0	0	1	4 ms																																																																
0	1	0	8 ms																																																																
0	1	1	2 ms																																																																


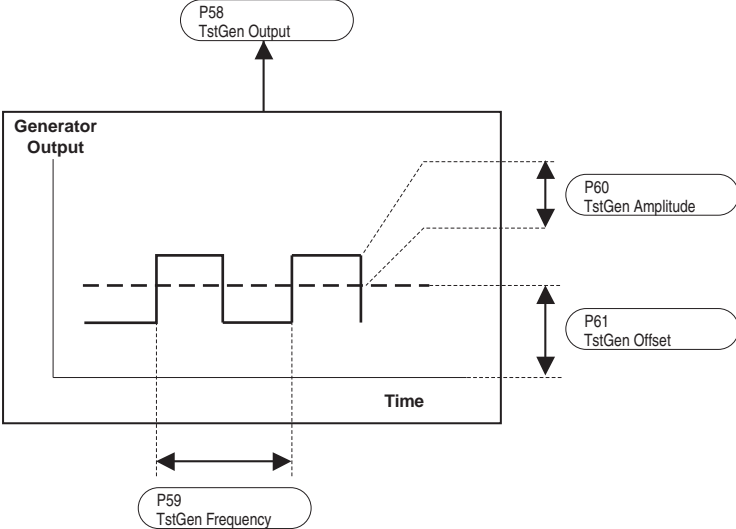





File	Group	No.	Parameter Name & Description <small>See page 117 for symbol descriptions</small>	Values	Data Type	Related																																																			
MOTOR CONTROL	Speed Feedback	426	<p><b>[Resolver Status]</b> Indicates the status of the resolver module.</p> <ul style="list-style-type: none"> <li>Bit 0 "CableBalSts" - Cable balance tuning process status. 0 = cable balanced (tuned), 1 = cable not balanced or the test is currently active. See Resolver Cable Balance Tuning Test on page 328 for details.</li> <li>Bit 1 "CableBalTest" - Cable balance tuning test results. 0 = cable balance (tuning) test completed, 1 = cable can't be balanced or the motor was not at minimum speed during test. See Resolver Cable Balance Tuning Test on page 328 for details.</li> <li>Bit 2 "ReslvrMinSpd" - Module has detected motion greater than the minimum speed. Also permits cable balance tuning test. 0 = motor turning, 1 = motor not turning.</li> <li>Bit 3 "CableCompSts" - Cable length compensation status. 0 = cable length compensation is OK, 1 = cable length compensation failed.</li> <li>Bit 4 "Energized" - Indicates the value written to Par 425 [Resolver Config], bit 4 "Energize". 0 = resolver is not energized, 1 = resolver is energized.</li> <li>Bit 8 "Open Wire" - Indicates if a problem with cable wiring or resolver configuration was detected. This bit is also set if the maximum tracking speed of the resolver is exceeded (see Table 425A in Par 425 [Resolver Config]). 0 = resolver feedback signals are OK, 1 = resolver has an open wire.</li> <li>Bit 9 "PwrSupplySts" - Indicates the resolver module power supply status. 0 = power supply is OK, 1 = power supply has an error.</li> <li>Bit 10 "HardwareSts" - Power-up hardware diagnostics status. 0 = diagnostics passed, 1 = diagnostics failed.</li> <li>Bit 11 "ParametersOK" - Indicates the resolver configuration parameters status. 0 = a parameter configuration error exists, 1 = parameter configuration is OK.</li> <li>Bit 12 "SSI Comm OK" - Resolver module communication status as determined by the drive. 0 = a communication error exists, 1 = communication is OK.</li> <li>Bit 13 "SSI Comm Err" - Latched indication of three consecutive SSI communication errors (bit 12 = 1) as determined by the drive. 0 = no error. 1 = three consecutive SSI communication errors have occurred. In this case a "Resolver Error" fault (F93) is displayed and the must be cleared using the "Clear Faults" function. See Fault Descriptions on page 222 for more information.</li> </ul> <p>Note: This parameter was added for firmware revision 5.002.</p> <table border="1"> <thead> <tr> <th>Options</th> <th>Reserved</th> <th>Reserved</th> <th>SSI Comm Err</th> <th>SSI Comm OK</th> <th>ParametersOK</th> <th>HardwareSts</th> <th>PwrSupplySts</th> <th>Open Wire</th> <th>Reserved</th> <th>Reserved</th> <th>Reserved</th> <th>Energize</th> <th>CableCompSts</th> <th>ReslvrMinSpd</th> <th>CableBalTest</th> <th>CableBalSts</th> </tr> </thead> <tbody> <tr> <td>Default</td> <td>x</td> <td>x</td> <td>0</td> <td>0</td> <td>0</td> <td>0</td> <td>0</td> <td>0</td> <td>x</td> <td>x</td> <td>x</td> <td>0</td> <td>0</td> <td>0</td> <td>0</td> <td>0</td> </tr> <tr> <td>Bit</td> <td>15</td> <td>14</td> <td>13</td> <td>12</td> <td>11</td> <td>10</td> <td>9</td> <td>8</td> <td>7</td> <td>6</td> <td>5</td> <td>4</td> <td>3</td> <td>2</td> <td>1</td> <td>0</td> </tr> </tbody> </table>	Options	Reserved	Reserved	SSI Comm Err	SSI Comm OK	ParametersOK	HardwareSts	PwrSupplySts	Open Wire	Reserved	Reserved	Reserved	Energize	CableCompSts	ReslvrMinSpd	CableBalTest	CableBalSts	Default	x	x	0	0	0	0	0	0	x	x	x	0	0	0	0	0	Bit	15	14	13	12	11	10	9	8	7	6	5	4	3	2	1	0			431
		Options	Reserved	Reserved	SSI Comm Err	SSI Comm OK	ParametersOK	HardwareSts	PwrSupplySts	Open Wire	Reserved	Reserved	Reserved	Energize	CableCompSts	ReslvrMinSpd	CableBalTest	CableBalSts																																							
		Default	x	x	0	0	0	0	0	0	x	x	x	0	0	0	0	0																																							
		Bit	15	14	13	12	11	10	9	8	7	6	5	4	3	2	1	0																																							
				427	<p><b>[Reslvr Position]</b> 32-bit indication of resolver position. 16-bit revolution count (upper word) + 16-bit position count (lower word). Note: This parameter was added for firmware revision 5.002.</p>	Default: 0 Min/Max: $-/+2^{32}$	Read Only																																																		
				429	<p><b>[Resolver Pos Sel]</b> When set to 1 "PID Feedback", resolver position data (16-bits) is routed to Par 763 [PID Feedback]. If this parameter is set to 1, Par 430 [Resolver Spd Sel] must be set to 0 "Off". Note: This parameter was added for firmware revision 5.002.</p>	Default: 0 = "Off" Options: 0 = "Off", 1 = "PID Feedback"	16-bit Int	763																																																	
		430	<p><b>[Resolver Spd Sel]</b> Routes the resolver speed to the selected parameter. If this parameter is set to a value other than 0, Par 429 [Resolver Pos Sel] must be set to 0 "Off". Note: This parameter was added for firmware revision 5.002.</p>	Default: 0 = "Off" Options: 0 = "Off", 1 = "Trim Speed" (Par 43), 2 = "Trim Ramp" (Par 42), 3 = "Speed Ref A" (Par 44), 4 = "Speed Ref B" (Par 48)	16-bit Int	42, 43, 44, 48																																																			
		431	<p><b>[Reslvr Cable Bal]</b> Starts the resolver cable balance (tuning) process. Note that this test requires the resolver to be rotating at a minimum speed. See Resolver Cable Balance Tuning Test on page 328 for cable balance tuning details. • 1 "On" = starts the test • 0 "Off" = disables the test The drive also automatically clears this value after it is initiated (similar to the drive "Autotune" tests). Note: This parameter was added for firmware revision 5.002.</p>	Default: 0 = "Off" Options: 0 = "Off", 1 = "On"	16-bit Int																																																				
		455	<p><b>[Spd FB Loss Lvl]</b> Maximum allowed value of armature voltage (as a percentage of Par 175 [Rated Motor Volt]) with less than 5% measured speed feedback (relative to Par 162 [Max Feedback Spd]) before a Speed Feedback Loss condition (fault or alarm) is reported. Note: The name of this parameter was changed from [Spd Fdbk Error], changed the default value from 22, and min./max. values from 10/100 for firmware revision 5.002.</p>	Default: 40 Min/Max: 10 / 40 Units: %	16-bit Int	457, 478																																																			

File	Group	No.	Parameter Name & Description <small>See page 117 for symbol descriptions</small>	Values	Data Type	Related	
MOTOR CONTROL	Speed Feedback	457	 <b>[Spd Fdbk Control]</b> Enables/Disables speed feedback control. The speed feedback control function is automatically disabled when armature voltage feedback is selected (Par 414 [Fdbk Device Type] = 3 "Armature").	Default: 1 = "Enabled" Options: 0 = "Disabled", 1 = "Enabled"	16-bit Int	414, 455, 478	
		 <b>ATTENTION:</b> If speed feedback control is disabled (Par 457 [Spd Fdbk Control] set to 0 "Disabled") and Par 414 [Device Type] is set to 1 "Encoder", 2 "DC Tach", or 4 "Resolver", the motor could run at excessive speed or become damaged, which could result in personal injury or destruction of equipment.					
		458	 <b>[SpdReg FB Bypass]</b> Enables/Disables an automatic switch to armature voltage feedback when a "Speed Fdbk Loss" (F91) fault occurs due to a speed feedback signal loss. When this parameter is set to "Enable", Par 478 [Spd Loss Flt Cfg] must be set to 1 "Alarm" to allow the motor to continue to run with no speed feedback signal. After an automatic switch to armature feedback, the speed regulator works with Pars 459 [SpdReg Kp Bypass] and 460 [SpdReg Ki Bypass] and the D derivative part of the speed regulator is automatically excluded. Pars [SpdReg Kp Bypass] and [SpdReg Ki Bypass] must be properly tuned.	Default: 0 = "Disabled" Options: 0 = "Disabled", 1 = "Enabled"	16-bit Int	162, 459, 460, 469, 478	
		<b>IMPORTANT</b> If Field Weakening and Speed Reg FB Bypass are both enabled when using a DC contactor, the armature voltage feedback terminals A1 And A2 on the drive must be connected to the motor terminals A1 and A2, respectively.					
		461	 <b>[Spd Fdbk Invert]</b> Enables / Disables speed feedback negation. Note: This parameter was added for firmware revision 3.001.	Default: 0 = "Disabled" Options: 0 = "Disabled", 1 = "Enabled"	16-bit Int		
		 <b>ATTENTION:</b> The Drive can overspeed if Par 461 [Spd Fdbk Invert] is set incorrectly for your application. Failure to observe this precaution could result in damage to, or destruction of, the equipment.					
		562	<b>[Anlg Tach Gain]</b> Fine scaling of the speed feedback received from the DC analog tachometer (Par 414 [Fdbk Device Type] = 2 "DC Tach"). The voltage feedback value received from the tachometer is multiplied by this value. To maximize the feedback speed resolution, this parameter can be used to scale the voltage setting selected with DIP switch S4 to Par 162 [Max Feedback Spd].	Default: 1.0000 Min/Max: 0.9000 / 3.0000	Real		
		563	<b>[Feedback Offset]</b> Offset scaling of the feedback circuit. The value of this parameter applies regardless of the type of feedback device selected in Par 414 [Fdbk Device Type]. Note: The name of this parameter was changed from [Anlg Tach Zero] for firmware revision 3.001.	Default: 0.00 Min/Max: -/+20.00 Units: rpm	Real		
		652	 <b>[Encoder Err Chk]</b> Enables/Disables monitoring of the digital encoder connection status. <ul style="list-style-type: none"> <li>Set this parameter to 1 "Enabled" when using a differential encoder and connection status monitoring is required.</li> <li>Set this parameter to "Disabled" when using a single-ended encoder. Note: The encoder error fault (F92) will only be reported while the drive is active.</li> </ul> When an alarm is detected, the HIM displays the "Spd Fdbk Loss" (F91) fault. This parameter can be programmed on a digital output. This function is activated by setting Par 457 [Spd Fdbk Control] = "Enabled".	Default: 0 = "Disabled" Options: 0 = "Disabled", 1 = "Enabled"	16-bit Int	457	

File	Group	No.	Parameter Name & Description <small>See page 117 for symbol descriptions</small>	Values	Data Type	Related
MOTOR CONTROL	Speed Feedback	914 	<b>[Spd FB Filt Gain]</b> First order lead/lag filter gain on the speed feedback signal. Note: This parameter was added for firmware revision 3.001.	Default: 1.000 Min/Max: 0.000 / 2.000	Real	915
		915 	<b>[Spd FB Filt BW]</b> First order lead/lag filter bandwidth on the speed feedback signal. Note: This parameter was added for firmware revision 3.001.	Default: 0 Min/Max: 0 / 2000 Units: ms	16-bit Int	914
		923 	<b>[Act Spd Filter]</b> First order low pass filter time constant for Par 924 [Actual Speed].	Default: 0.100 Min/Max: 0.001 / 1.000 Units: s	Real	924
		1021 	<b>[Encoder Out Sel]</b> Defines the speed reference to which the encoder signal can be input. This parameter is typically set to 0 "Off" and the encoder is used for speed feedback only. When set to other than 0 "Off", the choice of the speed reference destination must be made according to the configuration of the speed regulator (for example "Speed Ref A" cannot be used with an active ramp).	Default: 0 = "Off" Options: 0 = "Off" 1 = "Trim Speed" 2 = "Trim Ramp" 3 = "Speed Ref A" 4 = "Speed Ref B"	16-bit Int	
		1022 	<b>[Encoder Counts]</b> Displays an accumulated pulse count (32-bit integer) from the encoder. Each edge is counted, so a 1024 PPR device produces 4096 counts per revolution. Movement in either the forward or reverse direction results in an increase in the counter value. Note: This parameter was added for firmware revision 3.001.	Default: Read Only Min/Max: -/+ 2 <sup>32</sup>	32-bit Int	
		Autotune	93 	<b>[Spd Reg Kp Base]</b> The proportional gain ( $K_{p0}$ ) of the speed regulator (base value). Note: This parameter was moved from the Speed Command file and Speed Regulator group for firmware revision 6.001.	Default: 0.30 Min/Max: 0.001 / Based on drive current rating Units: A / rpm	RO
	94 		<b>[Spd Reg Ki Base]</b> The integral gain ( $K_{i0}$ ) of the speed regulator (base value). Note: This parameter was moved from the Speed Command file and Speed Regulator group for firmware revision 6.001.	Default: 0.30 Min/Max: 0.001 / Based on drive current rating Units: A / rpm x ms	RO	88, 100
	452 		<b>[CurrReg Autotune]</b> Setting this parameter to 1 "On" and pressing "Start" on the HIM keypad initiates the current regulator auto tuning procedure. When the auto tuning procedure is complete, this parameter automatically resets to 0 "Off". The resulting armature resistance and inductance values are set in parameters 453 [Arm Resistance] and 454 [Arm Inductance], respectively.	Default: 0 = "Off" Options: 0 = "Off" 1 = "On"	16-bit Int	
	 <b>ATTENTION:</b> Do not attempt to perform current regulator tuning with a PowerFlex DC drive and permanent magnet motor, drive and/or motor damage may occur.					
	453		<b>[Arm Resistance]</b> Motor armature resistance. This parameter can be manually changed to a value other than the value obtained when the current regulator auto tuning is completed.	Default: 0.50 Min/Max: Based on drive current rating Units: Ohm	Real	452
	454		<b>[Arm Inductance]</b> Motor armature inductance. This parameter can be manually changed to a value other than the value obtained when the current regulator auto tuning is completed.	Default: 4.00 Min/Max: Based on drive current rating Units: mH	Real	452
	587 	<b>[I Reg Error]</b> Current Regulator tuning status parameter that is used as part of the manual tuning process. See Fine-Tuning the Regulators on page 349 for details.	Default: Read Only Min/Max: -/+80 Units: V	16-bit Int	452	
1012 	<b>[Inertia C Filter]</b> First order low-pass filter used to reduce noise caused by the speed differentiation process in the Inertia/Loss compensation block.	Default: 0 Min/Max: 0 / 1000 Units: ms	16-bit Int			

File	Group	No.	Parameter Name & Description <small>See page 117 for symbol descriptions</small>	Values	Data Type	Related		
MOTOR CONTROL	Autotune	1013 	<b>[Torque Const]</b> The Motor torque constant used to calculate inertia and friction compensation. This value is determined during speed auto tuning. Torque Const = EMF/Sb. It should be the same as Motor Rated Torque / Motor Full Load Amps.	Default: Min/Max: Units:	Based on motor current rating 0.01 / 99.99 N·m/A	Real		
		1014 	<b>[Inertia]</b> Motor inertia value. 1 Kg·m <sup>2</sup> = 23.76 lb·ft <sup>2</sup>	Default: Min/Max: Units:	Based on drive current rating (Par 179) 0.001 / 999.999 Kg·m <sup>2</sup>	Real		
		1015 	<b>[Friction]</b> Motor friction value. 1 N·m = 0.738 lb·ft	Default: Min/Max: Units:	Based on drive current rating (Par 179) 0.000 / 99.990 N·m	Real		
		1027 	<b>[Spd Reg Autotune]</b> Starts the auto tuning procedure for the speed regulator. Setting this parameter to 1 "On" and pressing "Start" on the HIM keypad initiates the speed regulator auto tuning procedure. When the auto tuning procedure is complete, this parameter automatically resets to 0 "Off". Run this test with inertia connected to the motor (if present), but without process load (i.e., material). Speed Regulator Autotune assumes full field is applied. Verify Pars 280 [Nom Mtr Fld Amps] and 467 [Max Fld Flux Pct] are set correctly. Tuning with less than full field current will result in different gains because of the lower motor torque values. Note: Non-default values for Par 107 [Speed Zero Level] or Par 108 [Speed Zero Delay] can interfere with successful Speed Loop autotuning.	Default: Options:	0 = "Off" 0 = "Off" 1 = "On"	16-bit Int	280, 467	
		 <b>ATTENTION:</b> The motor will rotate during the Speed Regulator tuning procedure. A hazard of personal injury exists due to motor shaft rotation and/or machinery motion.						
		1029 	<b>[Speed Tune Dir]</b> Choice of the rotation direction of the motor shaft (rotation, as seen from the motor shaft side) for the speed regulator auto tuning procedure. • "Forward" = Clockwise rotation • "Reverse" = Counter-clockwise rotation	Default: Options:	1 = "Forward" 1 = "Forward" 2 = "Reverse"	16-bit Int		
		1030	<b>[Spd Tune Inertia]</b> Motor inertia value identified during the speed regulator auto tuning procedure.	Default: Min/Max: Units:	Read Only 0.001 / 999.990 Kg x m <sup>2</sup>	Real		
		1031	<b>[SpdTune Friction]</b> Motor friction value identified during the speed regulator auto tuning procedure.	Default: Min/Max: Units:	Read Only 0.00 / 99.99 N·m	Real		
		1032	<b>[Speed Tune Kp]</b> Proportional gain value of the speed regulator identified during the speed regulator auto tuning procedure.	Default: Min/Max:	Read Only 0.00 / 100.00	Real		
		1033	<b>[Speed Tune Ki]</b> Integral gain value of the speed regulator identified during the speed regulator auto tuning procedure.	Default: Min/Max:	Read Only 0.00 / 100.00	Real		
1034	<b>[SpdReg Kp Pct]</b> Internal proportional gain value, original Par 87 [Spd Reg Kp], percentage of Par 93 [Spd Reg Kp Base]. This parameter was added for firmware revision 6.001.	Default: Min/Max: Units:	Read Only 0.00 / 100.00 %	Real	87, 93			
1035	<b>[SpdReg Ki Pct]</b> Internal proportional gain value, original Par 88 [Spd Reg Ki], percentage of Par 94 [Spd Reg Ki Base]. This parameter was added for firmware revision 6.001.	Default: Min/Max: Units:	Read Only 0.00 / 100.00 %	Real	88, 94			

File	Group	No.	Parameter Name & Description <small>See page 117 for symbol descriptions</small>	Values	Data Type	Related	
MOTOR CONTROL	Autotune	1048	<b>[Autotune Cur Lim]</b> Value of the torque current limit applied during the speed regulator auto tuning procedure.	Default: 20 Min/Max: 0 / Based on drive current rating Units: %	16-bit Int		
		58	<b>[TstGen Output]</b> Allows you to select a simulated parameter as the output for the test generator. The test generator is used to manually tune the regulators. It consists of a square wave generator whose frequency, offset and amplitude can be manipulated. <ul style="list-style-type: none"> <li>• "NotConnected" - No internal parameters defined by the generator.</li> <li>• "Reserved" - Not used.</li> <li>• "Torq Cur Ref" - The output of the generator defines the reference value of the torque current. 100% corresponds to "full load torque current" (FLT).</li> <li>• "Field Ref" - The output of the generator defines the field reference value. 100% corresponds to the rated field current based on the motor nameplate data parameters.</li> <li>• "Ramp Ref" - The output of the generator defines the ramp reference value. 100% corresponds to the value specified in Par 45 [Max Ref Speed]. This is the value immediately before the Ramp function.</li> <li>• "Speed Ref" - The output of the generator defines the speed reference value. This is the value immediately before the Speed Regulator function.</li> </ul>	Default: 0 = "NotConnected" Options: 0 = "NotConnected", 1 = "Reserved", 2 = "Torq Cur Ref", 3 = "Field Ref", 4 = "Ramp Ref", 5 = "Speed Ref"	16-bit Int	59, 60, 61	
	<div style="text-align: center;">  <p><b>ATTENTION:</b> Uncontrolled machine operation could result with a motor connected during these tests and may cause personal injury and/or equipment damage. Verify that the drive is not connected to a motor armature circuit before enabling these test modes.</p> </div>						
	<div style="text-align: center;">  </div>						
			59	<b>[TstGen Frequency]</b> Output frequency of the test generator.	Default: 0.10 Min/Max: 0.10 / 62.50 Units: Hz	Real	58
		60	<b>[TstGen Amplitude]</b> Amplitude of the delta signal produced by the test generator.	Default: 0.00 Min/Max: 0.00 / 200.00 Units: %	Real	58	
		61	<b>[TstGen Offset]</b> Offset of the test generator.	Default: 0.00 Min/Max: -/+ 200.00 Units: %	Real	58	

File	Group	No.	Parameter Name & Description <small>See page 117 for symbol descriptions</small>	Values	Data Type	Related																																																	
MOTOR CONTROL	Test Generator	166	<p><b>[Alpha Test]</b> Diagnostic test mode that selects the SCR bridge to activate. The SCR firing angles are specified by Pars 167 [Arm Test Angle] and 168 [Fld Test Angle].</p> <p><b>Important:</b> Alpha Test is an open loop diagnostic tool that requires a hardware Enable input be wired and functional at the terminal block. Reading Alpha Test Mode on page 289 is required before completing this test.</p> <p>0 = Off 1 = Armature Fwd 2 = Armature Rev 3 = Field Fwd</p> <p>Note: This parameter was added for firmware revision 3.001.</p> <hr/> <p> <b>ATTENTION:</b> Allow only qualified electrical personnel familiar with the construction and operation of this equipment and the hazards involved to perform this test. Failure to observe this precaution could result in equipment damage and/or bodily injury.</p> <hr/> <p> <b>ATTENTION:</b> This is an open loop test, disconnect the motor armature and field leads and replace them with dummy loads. Failure to observe this precaution could result in machine damage and/or bodily injury.</p> <hr/> <p> <b>ATTENTION:</b> Uncontrolled machine operation could result with a motor connected during these tests and may cause personal injury and/or equipment damage. Verify that the drive is not connected to a motor armature circuit before enabling these test modes.</p>	<p>Default: 0 = "Off"</p> <p>Options: 0 = "Off" 1 = "Armature Fwd" 2 = "Armature Rev" 3 = "Field Fwd"</p>	16-bit Int	167, 168																																																	
		167	<p><b>[Arm Test Angle]</b> Sets the armature SCR firing angle for the Armature Forward and Armature Reverse tests. 180 deg = minimum voltage, 5 deg = maximum voltage. This parameter is only changeable while the Armature Alpha Test is selected. Note: This parameter was added for firmware revision 3.001.</p>	<p>Default: 180</p> <p>Min/Max: 0 / 180 deg</p> <p>Units:</p>	Real	166																																																	
		168	<p><b>[Fld Test Angle]</b> Sets the field SCR firing angle for the Field Forward test. 180 deg = minimum voltage, 5 deg = maximum voltage. This parameter is only changeable while the Field Alpha Test is selected. Notes: This parameter was added for firmware revision 3.001.</p>	<p>Default: 180</p> <p>Min/Max: 0 / 180 deg</p> <p>Units:</p>	Real	166																																																	
		213	<p><b>[SCR Diag Test En]</b> Enables/Disables the SCR diagnostic tests. Both tests can be enabled simultaneously, but the "Shorted SCR" test will take precedence over the "Open SCR" test. Note: This parameter was added for firmware revision 6.001.</p> <table border="1"> <thead> <tr> <th>Options</th> <th>Reserved</th> <th>Reserved</th> <th>Reserved</th> <th>Reserved</th> <th>Reserved</th> <th>Reserved</th> <th>Reserved</th> <th>Reserved</th> <th>Reserved</th> <th>Reserved</th> <th>Reserved</th> <th>Reserved</th> <th>Reserved</th> <th>Reserved</th> <th>ShortSCR Tst</th> <th>OpenSCR Tst</th> </tr> </thead> <tbody> <tr> <td>Default</td> <td>x</td> <td>x</td> <td>x</td> <td>x</td> <td>x</td> <td>x</td> <td>x</td> <td>x</td> <td>x</td> <td>x</td> <td>x</td> <td>x</td> <td>x</td> <td>x</td> <td>0</td> <td>0</td> </tr> <tr> <td>Bit</td> <td>15</td> <td>14</td> <td>13</td> <td>12</td> <td>11</td> <td>10</td> <td>9</td> <td>8</td> <td>7</td> <td>6</td> <td>5</td> <td>4</td> <td>3</td> <td>2</td> <td>1</td> <td>0</td> </tr> </tbody> </table>	Options	Reserved	Reserved	Reserved	Reserved	Reserved	Reserved	Reserved	Reserved	Reserved	Reserved	Reserved	Reserved	Reserved	Reserved	ShortSCR Tst	OpenSCR Tst	Default	x	x	x	x	x	x	x	x	x	x	x	x	x	x	0	0	Bit	15	14	13	12	11	10	9	8	7	6	5	4	3	2	1	0	
Options	Reserved	Reserved	Reserved	Reserved	Reserved	Reserved	Reserved	Reserved	Reserved	Reserved	Reserved	Reserved	Reserved	Reserved	ShortSCR Tst	OpenSCR Tst																																							
Default	x	x	x	x	x	x	x	x	x	x	x	x	x	x	0	0																																							
Bit	15	14	13	12	11	10	9	8	7	6	5	4	3	2	1	0																																							

File	Group	No.	Parameter Name & Description <small>See page 117 for symbol descriptions</small>	Values	Data Type	Related																																																			
<b>MOTOR CONTROL</b>	<b>Test Generator</b>	214	<p><b>[SCR Diag Status]</b>                      Bits 0...11 indicate which SCR or SCR pair is in error. The type of error is indicated in bits 13...15. Only one type of error is shown at a time. The precedence of errors is "Shorted SCR," "OpenSCR Trip," and "OpenSCR Warn." Note that "OpenSCR Warn" is independent from a SCR trip configured as an alarm. This parameter is only active when bit 0 "OpenSCR Tst" or bit 1 "ShortSCR Tst" of Par 213 is set to 1 "Enabled." The SCR numbering shown is SCR1...SCR6 for the forward power bridge and SCR11...SCR16 for the reverse bridge (regenerative drives only). In the standard drive, SCR<sub>x</sub> corresponds to the SCR package labeled KG<sub>x</sub> and SCR1<sub>x</sub> to the package labeled KG0<sub>x</sub>. See the appropriate PowerFlex DC Drive Hardware Service Manual for your drive frame size for instructions on replacing SCR modules. For frame A drives, see <a href="#">20P-TG001</a>. For frame B drives, see <a href="#">20P-TG002</a>. For frame C drives, see <a href="#">20P-TG003</a>. For frame D drives, see <a href="#">20P-TG004</a>.                      Note: This parameter was added for firmware revision 6.001.</p> <table border="1" style="width: 100%; border-collapse: collapse; text-align: center;"> <thead> <tr> <th>Options</th> <th>Shorted SCR</th> <th>OpenSCR Trip</th> <th>OpenSCR Warn</th> <th>Reserved</th> <th>SCR 16</th> <th>SCR 15</th> <th>SCR 14</th> <th>SCR 13</th> <th>SCR 12</th> <th>SCR 11</th> <th>SCR 6</th> <th>SCR 5</th> <th>SCR 4</th> <th>SCR 3</th> <th>SCR 2</th> <th>SCR 1</th> </tr> </thead> <tbody> <tr> <td>Default</td> <td>0</td> <td>0</td> <td>0</td> <td>x</td> <td>0</td> <td>0</td> <td>0</td> <td>0</td> <td>0</td> <td>0</td> <td>0</td> <td>0</td> <td>0</td> <td>0</td> <td>0</td> <td>0</td> </tr> <tr> <td>Bit</td> <td>15</td> <td>14</td> <td>13</td> <td>12</td> <td>11</td> <td>10</td> <td>9</td> <td>8</td> <td>7</td> <td>6</td> <td>5</td> <td>4</td> <td>3</td> <td>2</td> <td>1</td> <td>0</td> </tr> </tbody> </table>	Options	Shorted SCR	OpenSCR Trip	OpenSCR Warn	Reserved	SCR 16	SCR 15	SCR 14	SCR 13	SCR 12	SCR 11	SCR 6	SCR 5	SCR 4	SCR 3	SCR 2	SCR 1	Default	0	0	0	x	0	0	0	0	0	0	0	0	0	0	0	0	Bit	15	14	13	12	11	10	9	8	7	6	5	4	3	2	1	0			213, 215, 216, 217, 218
		Options	Shorted SCR	OpenSCR Trip	OpenSCR Warn	Reserved	SCR 16	SCR 15	SCR 14	SCR 13	SCR 12	SCR 11	SCR 6	SCR 5	SCR 4	SCR 3	SCR 2	SCR 1																																							
		Default	0	0	0	x	0	0	0	0	0	0	0	0	0	0	0	0																																							
		Bit	15	14	13	12	11	10	9	8	7	6	5	4	3	2	1	0																																							
		215	<p><b>[OpenSCR WarnLvl]</b>                      Sets the open SCR warning level. This value determines when Par 214 [SCR Diag Status], bit 13 "OpenSCR Warn" is set. This parameter is only active when Par 213 [SCR Diag Test En], bit 0 "OpenSCR Tst" is enabled.                      Note: This parameter was added for firmware revision 6.001.</p>	Default: 1024 Min/Max: 0 / 4096	16-bit Int	213																																																			
216	<p><b>[OpenSCR Flt Cfg]</b>                      Configures the open SCR error condition. This parameter is only active when Par 213 [SCR Diag Test En], bit 0 "OpenSCR Tst" is enabled.                      Note: This parameter was added for firmware revision 6.001.</p>	Default: 0 = "Ignore" Options: 0 = "Ignore" 1 = "Alarm" 2 = "Fault"	16-bit Int	213																																																					
217	<p><b>[OpenSCR Threshld]</b>                      Sets the open SCR error level and when exceeded begins to accumulate. This parameter is only active when Par 213 [SCR Diag Test En], bit 0 "OpenSCR Tst" is enabled.                      Note: This parameter was added for firmware revision 6.001.</p>	Default: 50 Min/Max: 0 / 100 Units: %	16-bit Int	213																																																					
218	<p><b>[OpenSCR Trip Lvl]</b>                      Sets the open SCR trip level. The action taken by the drive when as open SCR trip occurs is determined by Par 216 [OpenSCR Flt Cfg]. This parameter is only active when Par 213 [SCR Diag Test En], bit 0 "OpenSCR Tst" is enabled.                      Note: This parameter was added for firmware revision 6.001.</p>	Default: 1024 Min/Max: 0 / 4096	16-bit Int	213, 216																																																					

## Speed Command File

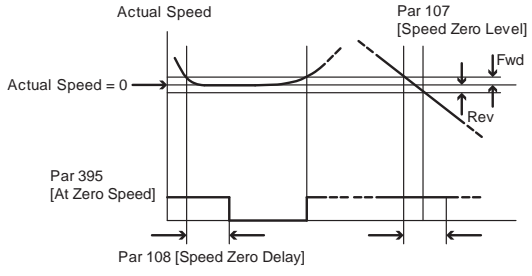
File	Group	No.	Parameter Name & Description <small>See page 117 for symbol descriptions</small>	Values	Data Type	Related
SPEED COMMAND	Limits	1	<b>[Minimum Speed]</b> Defines the minimum speed of the drive. This value applies to both directions of motor rotation for four quadrant drives. A speed below the value set in [Minimum Speed] is not possible, regardless of the set speed reference value. If the value of [Minimum Speed] is changed, Pars 5 [Min Speed Fwd] and 6 [Min Speed Rev] are set to the same value. If either Par 5 [Min Speed Fwd] or Par 6 [Min Speed Rev] is changed later, the last change is valid.	Default: 0 Min/Max: 0 / Par 45 [Max Ref Speed] Units: rpm	32-bit Int	5, 6
		2	<b>[Maximum Speed]</b> Defines the maximum speed of the drive. This value applies to both directions of motor rotation for four quadrant drives. The value of this parameter is input to the speed regulator and therefore takes into account the reference value that comes from the ramp as well as the direction of rotation. If the value of [Maximum Speed] is changed, Pars 3 [Max Speed Fwd] and 4 [Max Speed Rev] are set to the same value. If either Par 3 [Max Speed Fwd] or Par 4 [Max Speed Rev] is changed later, the last change is valid.	Default: 1750 Min/Max: 0 / Par 45 [Max Ref Speed] Units: rpm	32-bit Int	3, 4
		3	<b>[Max Speed Fwd]</b> Defines the maximum speed for forward (clockwise) rotation of the motor. The value of [Max Speed Fwd] affects the input of the speed regulator and therefore takes into account both the reference values that come from the ramp as well as the direction of motor rotation.	Default: 1750 Min/Max: 0 / Par 45 [Max Ref Speed] Units: rpm	32-bit Int	2
		4	<b>[Max Speed Rev]</b> Defines the maximum speed for reverse (counterclockwise) rotation of the motor for four quadrant drives only. The value of [Max Speed Rev] affects the input of the speed regulator and therefore takes into account both the reference values that come from the ramp as well as the direction of rotation.	Default: 1750 Min/Max: 0 / Par 45 [Max Ref Speed] Units: rpm	32-bit Int	2
		5	<b>[Min Speed Fwd]</b> Defines the minimum speed for forward (clockwise) rotation of the motor. Speed reference values below the value in this parameter are clamped until the reference exceeds this limit.	Default: 0 Min/Max: 0 / Par 45 [Max Ref Speed] Units: rpm	32-bit Int	1
		6	<b>[Min Speed Rev]</b> Defines the minimum speed for reverse (counterclockwise) rotation of the motor for four quadrant drives only. Speed reference values below the value in this parameter are clamped until the reference exceeds this limit.	Default: 0 Min/Max: 0 / Par 45 [Max Ref Speed] Units: rpm	32-bit Int	1
	Discrete Speeds	154 155 156 157 158 159 160	<b>[Preset Speed 1]</b> <b>[Preset Speed 2]</b> <b>[Preset Speed 3]</b> <b>[Preset Speed 4]</b> <b>[Preset Speed 5]</b> <b>[Preset Speed 6]</b> <b>[Preset Speed 7]</b> Provides an internal fixed speed command value. In bipolar mode, direction is commanded by the sign of the reference. Notes: [Preset Speed 1] cannot be directly selected by the Speed Sel digital inputs. However, Par 154 [Preset Speed 1] can be directed to Par 42 [Trim Ramp] via the Scale Block parameters. See Reference Control on page 325 for more information.	Default: 150 Default: 300 Default: 600 Default: 900 Default: 1200 Default: 1500 Default: 1750 Min/Max: -/+6000 Units: rpm	16-bit Int	
		266	<b>[Jog Speed]</b> Reference value for jog mode. Notes: This parameter can be assigned to an analog input. See Reference Control on page 325 for more information.	Default: 100 Min/Max: -/+6000 Units: rpm	16-bit Int	




File	Group	No.	Parameter Name & Description <small>See page 117 for symbol descriptions</small>	Values	Data Type	Related
SPEED COMMAND	Discrete Speeds	267	<b>[TB Manual Ref]</b> Reference value for the drive when the Terminal Block asserts Manual reference control. Notes: This parameter can be assigned to an analog input. See Reference Control on page 325 for more information.	Default: 0 Min/Max: -/+ Par 45 [Max Ref Speed] <sup>(1)</sup> Units: rpm <small>(1) The value of [Max Ref Speed] cannot exceed 6000 rpm.</small>	16-bit Int	45
		1409	<b>[Jog Off Delay]</b> Specifies the amount of time that will elapse between removing the Jog input and commanding the main contactor to open. The amount of time specified in [Jog Off Delay] will not begin to elapse until the measured speed feedback is less than or equal to the value of parameter 107 [Speed Zero Level]. This delay reduces the wear on the contactor when repeatedly opening and closing the Jog input over a short period of time. If a stop command is asserted before the jog off delay time has completed, the drive will stop and the delay timer is canceled. Note: This parameter was added for firmware revision 2.001.	Default: 1 Min/Max: 0 - 10 Units: s	16-bit Int	
	Speed References	42	<b>[Trim Ramp]</b> This value is added to the speed reference just before the Speed Ramp function. Notes: This parameter can be assigned to an analog input. See Reference Control on page 325 for more information.	Default: 0 Min/Max: -/+ Par 45 [Max Ref Speed] <sup>(1)</sup> Units: rpm <small>(1) The value of Par 45 [Max Ref Speed] cannot exceed 6000 rpm.</small>	16-bit Int	45, 378
		43	<b>[Trim Speed]</b> This value is added to the speed reference just before the speed regulator (and after the Speed Ramp function). Notes: This parameter can be assigned to an analog input. See Reference Control on page 325 for more information.	Default: 0 Min/Max: -/+ Par 45 [Max Ref Speed] <sup>(1)</sup> Units: rpm <small>(1) The value of Par 45 [Max Ref Speed] cannot exceed 6000 rpm.</small>	16-bit Int	45, 379
		378	<b>[Trim Ramp Pct]</b> Trim ramp value defined as a percentage of the value defined in Par 45 [Max Ref Speed].	Default: 0.00 Min/Max: -/+100.00 Units: %	Real	42
		379	<b>[Trim Speed Pct]</b> Trim speed reference value defined as a percentage of the of the value defined in Par 45 [Max Ref Speed].	Default: 0.00 Min/Max: -/+100.00 Units: %	Real	43
		1017	<b>[Speed Ratio]</b> Determines the speed ratio value for the Speed-Draw function. Notes: This value can be input to the drive digitally, or via an analog input. See Speed Draw Function on page 341 for more information.	Default: 10000 Min/Max: 0 / 32767	16-bit Int	
	Speed Regulator	87	<b>[Spd Reg Kp]</b> Proportional gain of the speed regulator that can be adjusted while the drive is running. This parameter can only be changed when Par 434 [Spd Reg BW] is set to zero. See Manually Tuning the Speed Regulator for Firmware Revision 6.001 and Later on page 317 for more information. Note: Units changed from “%” to “none” for firmware revision 6.001.	Default: 3.00 Min/Max: 0.00 / 100.00	Real	93, 99
		88	<b>[Spd Reg Ki]</b> Integral gain of the speed regulator that can be adjusted while the drive is running. This parameter can only be changed when Par 434 [Spd Reg BW] is set to zero. See Manually Tuning the Speed Regulator for Firmware Revision 6.001 and Later on page 317 for more information. Note: Units changed from “%” to “sec <sup>-1</sup> ” for firmware revision 6.001.	Default: 0.30 Min/Max: 0.00 / 100.00 Units: sec <sup>-1</sup>	Real	94, 100
		95	<b>[Spd Reg Pos Lim]</b> Positive Speed Regulator output limit. When this limit is active the positive integrator portion of the PI regulator is held to prevent windup. Note: This parameter was added for firmware revision 3.001.	Default: 200.00 Min/Max: -/+250.00 Units: %	Real	96
		96	<b>[Spd Reg Neg Lim]</b> Negative Speed Regulator output limit. When this limit is active the negative integrator portion of the PI regulator is held to prevent windup. Note: This parameter was added for firmware revision 3.001.	Default: -200.00 Min/Max: -/+250.00 Units: %	Real	95
		99	<b>[Spd Reg Kp Outpt]</b> Displays the active proportional coefficient of the speed regulator as a percentage of the value defined in Par 93 [Spd Reg Kp Base]. Note: Units changed from “%” to “none” for firmware revision 6.001.	Default: Read Only Min/Max: 0.00 / 100.00	Real	87, 93




File	Group	No.	Parameter Name & Description <small>See page 117 for symbol descriptions</small>	Values	Data Type	Related
<b>SPEED COMMAND</b>	<b>Speed Regulator</b>	<b>A</b>	<b>100 [Spd Reg Ki Outpt]</b> Displays the active integral coefficient of the speed regulator as a percentage of the value defined in Par 94 [Spd Reg Ki Base]. Note: Units changed from “%” to “sec <sup>-1</sup> ” for firmware revision 6.001.	Default: Read Only Min/Max: 0.00 / 100.00 Units: sec <sup>-1</sup>	Real	88, 94
		<b>A</b>	<b>101 [Speed Thresh Pos]</b> Threshold speed for the drive above or below which the value of Par 393 [Speed Threshold] changes. When the speed of the drive exceeds the value of this parameter, Par 393 [Speed Threshold] displays “Above Thresh” (0). When the speed of the drive is below the value of this parameter, Par 393 [Speed Threshold] displays “Below Thresh” (1). Note: See Speed Threshold Indicators on page 339 for more information.	Default: 1000 Min/Max: 1 / 6000 Units: rpm	16-bit Int	393
		<b>A</b>	<b>102 [Speed Thresh Neg]</b> Threshold speed for the drive above or below which the value of Par 393 [Speed Threshold] changes. When the speed of the drive exceeds the value specified in this parameter, Par 393 [Speed Threshold] displays “Above Thresh” (0). When the speed of the drive is below this threshold, Par 393 [Speed Threshold] displays “Below Thresh” (1). Note: See Speed Threshold Indicators on page 339 for more information.	Default: 1000 Min/Max: 1 / 6000 Units: rpm	16-bit Int	393
		<b>A</b>	<b>103 [Threshold Delay]</b> Amount of time that must elapse before indication that the drive speed is above the value set in Par 101 [Speed Thresh Pos] or below the value set in Par 102 [Speed Thresh Neg]. Note: See Speed Threshold Indicators on page 339 for more information.	Default: 100 Min/Max: 0 / 65535 Units: ms	16-bit Int	393
		<b>A</b>	<b>104 [At Speed Error]</b> Defines the speed above and below the speed reference (in Par 118 [Speed Reg In]) at which the value of Par 394 [At Speed] changes. When the difference between the speed reference and the actual speed is greater than the value of this parameter, Par 394 [At Speed] displays “Not Equal” (0). When the difference between the speed reference and the actual speed is less than the value of this parameter, Par 394 [At Speed] displays “Equal” (1). Note: See Speed Threshold Indicators on page 339 for more information.	Default: 100 Min/Max: 1 / 6000 Units: rpm	16-bit Int	394
		<b>A</b>	<b>105 [At Speed Delay]</b> Amount of time that must elapse before indication that the drive speed reference is within the range specified in Par 104 [At Speed Error] occurs. Note: See Speed Threshold Indicators on page 339 for more information.	Default: 100 Min/Max: 0 / 65535 Units: ms	16-bit Int	394
		<b>A</b>	<b>106 [Ref Zero Level]</b> Speed below which speed references are equal to zero speed. Switch used in the Speed Zero function. Note: See Speed Threshold Indicators on page 339 for more information.	Default: 20 Min/Max: 1 / 6000 Units: rpm	16-bit Int	123, 124, 125, 126

File	Group	No.	Parameter Name & Description <small>See page 117 for symbol descriptions</small>	Values	Data Type	Related
SPEED COMMAND	Speed Regulator	A	<b>107 [Speed Zero Level]</b> Speed below which the actual speed is considered equal to zero. When a Stop command is issued and actual speed goes below this value, drive output is disabled. The value applies to both rotation directions for four quadrant drives.  Notes: Setting the value of this parameter too low could prevent the proper functioning of field economy. If Par 107 and/or Par 108 are changed from their default values it can affect the Speed Loop autotune function (Par 1027). Ideally, set these parameters to the default values when autotuning the Speed Loop. Values substantially different from defaults will result in an autotuning fault. Note: See Speed Zero Function on page 340 for more information.	Default: 20 Min/Max: 1 / 6000 Units: rpm	16-bit Int	395, 1027
		A	<b>108 [Speed Zero Delay]</b> Amount of time that must elapse after the actual speed goes below the value set in Par 107 [Speed Zero Level] before Par 395 [At Zero Speed] changes state. Note: See Speed Zero Function on page 340 for more information.	Default: 100 Min/Max: 0 / 65535 Units: ms	16-bit Int	395, 1027
		O	<b>123 [Spd Zero I En]</b> Enables/Disables the output of the integral section of the speed regulator. Used in the Zero Speed function.	Default: 0 = "Disable" Options: 0 = "Disable", 1 = "Enable"	16-bit Int	
		A	• "Enabled" = The output of the integral section of the speed regulator is set to zero when the speed reference and the speed feedback are equal to zero. The I component is enabled when a reference value is entered to restart acceleration. • "Disabled" = The speed regulator keeps its integral gain component when the drive is at zero speed. Note: See Speed Zero Function on page 340 for more information.			
		O	<b>124 [Spd Ref Zero En]</b> This parameter is only active when Par 125 [Spd Zero P En] = 1 "Enabled". Used in the Zero Speed function.	Default: 0 = "Disable" Options: 0 = "Disable", 1 = "Enable"	16-bit Int	
A	• "Enabled" = The proportional gain, equal to Par 126 [Spd Zero P Gain] at zero speed, is equal to Par 87 [Spd Reg Kp] when the speed reference is higher than the value defined in Par 106 [Ref Zero Level]. • "Disabled" = The proportional gain, equal to Par 126 [Spd Zero P Gain] at zero speed, is equal to the value in Par 87 [Spd Reg Kp] when the speed reference or the actual speed is higher than the value defined in Par 106 [Ref Zero Level]. Note: See Speed Zero Function on page 340 for more information.					
O	<b>125 [Spd Zero P En]</b> "Enabled" = When both the speed reference value and the actual speed value = 0, the proportional gain value in Par 126 [Spd Zero P Gain] is active after the delay time defined in Par 108 [Speed Zero Delay]. Used in the Zero Speed function. "Disabled" = The speed regulator keeps its proportional gain component when the drive is at zero speed. Note: See Speed Zero Function on page 340 for more information.	Default: 0 = "Disable" Options: 0 = "Disable", 1 = "Enable"	16-bit Int			






File	Group	No.	Parameter Name & Description <small>See page 117 for symbol descriptions</small>	Values	Data Type	Related		
SPEED COMMAND	Speed Regulator	126	<b>[Spd Zero P Gain]</b> The proportional gain of the speed regulator that is only active when the value of the speed reference and actual speed = 0. This parameter is only active when Par 125 [Spd Zero P En] = 1 "Enabled". Used in the Zero Speed function. Note: See Speed Zero Function on page 340 for more information.	Default: 3.00 Min/Max: 0.00 / 100.00 Units: %	Real			
		238	<b>[SpdOut FiltGain]</b> First order lead/lag filter gain on the speed regulator output signal. Note: This parameter was added for firmware revision 3.001.	Default: 1.000 Min/Max: 0.000 / 2.000	Real	239		
		239	<b>[SpdOut FiltBW]</b> First order lead/lag filter bandwidth on the speed regulator output signal. Note: This parameter was added for firmware revision 3.001.	Default: 0 Min/Max: 0 / 2000 Units: ms	16-bit Int	238		
		242	<b>[Speed Reg En]</b> Enables/Disables the speed regulator output to the torque/current regulator. <ul style="list-style-type: none"> <li>"Enabled" = The speed regulator output is connected to the input of the torque/current regulator.</li> <li>"Disabled" = The speed regulator output is not connected to the input of the torque/current regulator. Par 39 [Torque Ref] is connected to the input of the current regulator.</li> </ul> Note: This parameter is only available for use with firmware revision 2.005 and lower.	Default: 1 = "Enabled" Options: 0 = "Disabled" 1 = "Enabled"	16-bit Int	39, 41, 236		
		 <b>ATTENTION:</b> Failure to correctly set speed and voltage parameters or provide overspeed protection when operating as a torque/current regulator could result in high motor speeds, equipment damage, and/or personal injury.						
		348	<b>[Lock Speed Integ]</b> Enables or disables the integral (I) function of the speed regulator. <ul style="list-style-type: none"> <li>"Not active" = The integral component of the speed regulator is enabled.</li> <li>"Active" = The integral component of the speed regulator is disabled.</li> </ul>	Default: 1 = "Not active" Options: 0 = "Active" 1 = "Not active"	16-bit Int			
		388	<b>[Flying Start En]</b> Enables/Disables the ability of the drive to connect to a spinning motor at actual rpm when a start command is issued. <ul style="list-style-type: none"> <li>"On" = When the drive is turned on, the speed of the motor is measured and the ramp output is set accordingly. The drive then runs at the set reference value.</li> <li>"Off" = When the drive is turned on, the ramp starts from zero.</li> </ul> Main uses: <ul style="list-style-type: none"> <li>To connect to a motor that is already spinning due to its load (for example, in the case of a pump, the flowing medium).</li> <li>Re-connection to a spinning motor after a fault or alarm.</li> </ul> Note: If the Flying Start function is disabled (off), be sure that the motor is not spinning when the drive is turned on, or harsh motor deceleration in current limit may occur.	Default: 0 = "Off" Options: 0 = "Off" 1 = "On"	16-bit Int			
		433	<b>[Total Inertia]</b> Time, in seconds, for a motor coupled to a load to accelerate from zero to base speed with rated motor torque applied. This value can be calculated by Autotune or entered directly. Note: This parameter was added for firmware revision 6.001.	Default: 1.0 Min/Max: 0.001 / 300.0 Units: s	Real			
434	<b>[Spd Reg BW]</b> Sets the bandwidth of the speed regulator in rad/sec. Bandwidth is also referred to as the crossover frequency. Small signal time response is approximately 1/BW and is the time to reach 63% of setpoint. A change to this parameter will cause an automatic update of Pars 87 [Spd Reg Kp] and 88 [Spd Reg Ki]. To disable the automatic gain calculation, set this parameter to a value of zero. Note: This parameter was added for firmware revision 6.001.	Default: 10.0 Min/Max: 0.0 / 100.0 Units: rad / sec	Real	87, 88				

File	Group	No.	Parameter Name & Description <small>See page 117 for symbol descriptions</small>	Values	Data Type	Related	
<b>SPEED COMMAND</b>	Speed Regulator	435 <b>A</b>	<b>[Act Spd Reg BW]</b> Displays the actual speed regulator bandwidth or crossover frequency. It represents the bandwidth in Par 434 [Spd Reg BW] after the maximum bandwidth limits have been applied. Note: This parameter was added for firmware revision 6.001.	Default: Min/Max: Units:	Read Only 0.0 / 100.0 rad / sec	Real	434
		436 <b>A</b>	<b>[Spd Reg Damping]</b> Sets the drive damping factor of the characteristic equation and factors in the calculation of the integral gain set in Par 88 [Spd Reg Ki]. A factor of 1.0 is considered critical damping. When Par 434 [Spd Reg BW] is set to zero, the damping factor has no effect on drive operation. Note: This parameter was added for firmware revision 6.001.	Default: Min/Max:	1.0 0.5 / 30.0	Real	
		444 <b>A</b>	<b>[Spd Reg P Filter]</b> Time constant used by the filter for the Speed Feedback circuit. Filtering of the high frequency components of the speed feedback signal is useful in the case of elastic coupling between the motor and load (i.e., joints or belts). Note: This parameter was renamed for firmware revision 4.001.	Default: Min/Max: Units:	0 0 / 1000 ms	16-bit Int	121, 122
		445 <b>A</b>	<b>[Spd Up Gain Pct]</b> The Speed Up function gain as a percentage of Par 446 [Speed Up Base]. Note: See Speed Up Function on page 338 for more information.	Default: Min/Max: Units:	0.00 0.00 / 100.00 %	Real	446
		446 <b>A</b>	<b>[Speed Up Base]</b> The Speed Up function maximum gain. This value corresponds to 100% of Par 445 [Spd Up Gain Pct]. Note: See Speed Up Function on page 338 for more information.	Default: Min/Max: Units:	1000.00 0.00 / 16000.00 ms	Real	445
		447 <b>A</b>	<b>[Speed Up Filter]</b> The time constant of the filter for the D (derivative) component of the Speed Up function. Note: See Speed Up Function on page 338 for more information.	Default: Min/Max: Units:	0 0 / 1000 ms	16-bit Int	
		448 <b>A</b>	<b>[SpdReg BW Bypass]</b> Sets the bandwidth of the speed regulator, when bypassed, in rad/sec. Bandwidth is also referred to as the crossover frequency. Small signal time response is approximately 1/BW and is the time to reach 63% of setpoint. A change to this parameter will cause an automatic update of Pars 459 [SpdReg Kp Bypass] and 460 [SpdReg Ki Bypass]. To disable the automatic gain calculation, set this parameter to a value of zero. Note: This parameter was added for firmware revision 6.001.	Default: Min/Max: Units:	10.0 0.0 / 100.0 rad / sec	Real	
		459 <b>A</b>	<b>[SpdReg Kp Bypass]</b> The proportional gain (K <sub>p</sub> ) of the speed regulator when an encoder or tachometer feedback signal is changed to armature feedback (Par 458 [SpdReg FB Bypass] = 1 "Enabled"). This parameter can only be modified when Par 448 [SpdReg BW Bypass] is set to zero. See Manually Tuning the Speed Regulator for Firmware Revision 6.001 and Later on page 317 for more information. Note: Units were changed from "%" to "none" for firmware revision 6.001.	Default: Min/Max:	0.90 x P459 <sub>max</sub> 0.01 / Based on drive current rating	Real	458

File	Group	No.	Parameter Name & Description <small>See <a href="#">page 117</a> for symbol descriptions</small>	Values	Data Type	Related
<b>SPEED COMMAND</b>	<b>Speed Regulator</b>	<b>460</b> 	<b>[SpdReg Ki Bypass]</b> The integral gain ( $K_i$ ) of the speed regulator when an encoder or tachometer feedback signal is changed to armature feedback (Par 458 [SpdReg FB Bypass] = 1 "Enabled"). This parameter can only be modified when Par 448 [SpdReg BW Bypass] is set to zero. See Manually Tuning the Speed Regulator for Firmware Revision 6.001 and Later on page <a href="#">317</a> for more information. Note: Units were changed from "%" to "sec <sup>-1</sup> " for firmware revision 6.001.	Default: 0.30 Min/Max: 0.00 / 100.00 Units: sec <sup>-1</sup>	Real	458
		<b>643</b>	<b>[SpdReg AntiBckup]</b> Allows control of over-shoot/under-shoot in the step response of the speed regulator. Over-shoot/under-shoot can be effectively eliminated with a setting of 0.3, which will remove backup of the motor shaft when zero speed is reached. This parameter has no affect on the drive's response to load changes. A value of zero disables this feature. Note: This parameter was added for firmware revision 4.001.	Default: 0.0 Min/Max: 0.0 / 0.50	Real	
		<b>1016</b>  	<b>[SpdFuncSelect]</b> Selection of the "Speed Up" or "Inertia/Loss compensation" function. Notes: See Speed Up Function on page <a href="#">338</a> for more information. Option 2 "Off" added for firmware revision 4.001.	Default: 2 = "Off" Options: 0 = "Speed Up" 1 = "Inertia/loss" 2 = "Off"	16-bit Int	444, 445, 447, 1012, 1013, 1014, 1015











## Dynamic Control File








File	Group	No.	Parameter Name & Description <small>See page 117 for symbol descriptions</small>	Values	Data Type	Related
DYNAMIC CONTROL	Control Config	15 	<b>[SLAT Err Stpt]</b> Configures the condition for transfer between Speed and Torque operation during “SLAT Min” or “SLAT Max” mode. If the Speed Error is greater than the value of [SLAT Err Stpt] for the amount of time specified in Par 16 [SLAT Dwell Time], then the “forced speed” mode is turned off. Max. value setting example where Par 45 = 1750: 1750/5 = 350 rpm. Note: This parameter was added for firmware revision 3.001.	Default: 0.000 Min/Max: 0.000 / Par 45/5 (see description) Units: rpm	Real	16, 241
		16 	<b>[SLAT Dwell Time]</b> Amount of time that the speed error must be greater than the value of Par 15 [SLAT Err Stpt] to return to “SLAT Min” or “SLAT Max” mode. Note: This parameter was added for firmware revision 3.001.	Default: 0 Min/Max: 0 / 5 Units: s	16-bit Int	15, 241
		241	<b>[Spd Trq Mode Sel]</b> Configures the drive for a Speed or Torque mode of operation. <ul style="list-style-type: none"> <li>“Zero Trq Ref” = The drive operates as a torque regulator with the torque reference (Par 14 [Selected TorqRef]) forced to zero.</li> <li>“Speed Reg” = The drive operates as a speed regulator with the reference = Par 236 [Spd Reg Out Pct] + inertia compensation.</li> <li>“Torque Reg” = The drive operates as a torque regulator with the reference equal to the value of Par 39 [Torque Ref].</li> <li>“SLAT Min” = The drive operates in Speed Limited Adjustable Torque (SLAT) - Minimum mode. The drive operates as a torque regulator when the value of Par 39 [Torque Ref] is algebraically smaller in value than the speed regulator’s output. The drive may automatically enter speed regulation mode based on conditions within the speed regulator and the magnitude of the speed regulator’s output relative to the torque reference.</li> <li>“SLAT Max” = The drive operates in SLAT – Maximum mode. The drive operates as a torque regulator when the value of Par 39 [Torque Ref] is algebraically larger in value than the speed regulator’s output. The drive may automatically enter speed regulation mode based on conditions within the speed regulator and the magnitude of the speed regulator’s output relative to the torque reference.</li> <li>“Sum” = The drive operates as a speed regulator. The reference is derived from the sum of the speed regulator output (Par 236 [Spd Reg Out Pct]) and the torque reference (Par 39 [Torque Ref]).</li> </ul> Notes: See Speed / Torque Mode Selection on page 342 in Appendix C for more detailed information. This parameter was added and is only available with firmware revision 3.001 and higher.	Default: 1 = “Speed Reg” Options: 0 = “Zero Trq Ref”, 1 = “Speed Reg”, 2 = “Torque Reg”, 3 = “SLAT Min”, 4 = “SLAT Max”, 5 = “Sum”	16-bit Int	39, 236, 382
	Ramp Rates	18 	<b>[Ramp Type Select]</b> Determines the type of ramp used. <ul style="list-style-type: none"> <li>0 “Linear” = Linear ramp</li> <li>1 “S shaped” = S-shaped ramp</li> </ul>	Default: 0 = “Linear” Options: 0 = “Linear”, 1 = “S shaped”	16-bit Int	
		19	<b>[S Curve Time]</b> S-shaped ramp time constant. The value of this parameter is added to the time of the linear accel and decel ramps, regardless of speed changes. Approximately half of the specified time is added at the beginning and half at the end of the accel and decel ramps. When the value of [S Curve Time] is changed, Pars 665 and 667 [S Curve Accel x] and 666 and 668 [S Curve Decel x] are set to the same value. If any of parameters 665 . . . 668 are changed later, the last change is valid. Note: See S-curve Configuration on page 333 for more information.	Default: 1.00 Min/Max: 0.10 / 15.00 Units: s	Real	18, 665, 666, 667, 668

File	Group	No.	Parameter Name & Description <small>See page 117 for symbol descriptions</small>	Values	Data Type	Related
DYNAMIC CONTROL	Ramp Rates	20 <b>A</b>	<b>[Ramp Delay]</b> Defines a ramp delay time when the ramp is active. Works with par [Digital Out Sel] set to 6 "Ramp Pos" or 7 "Ramp Neg".  	Default: 100 Min/Max: 0 / 65535 Units: ms	16-bit Int	113, 346, 347
		22	<b>[MOP Accel Time]</b> The acceleration rate for the MOP reference in response to a digital input. The MOP acceleration rate = Par 2 [Maximum Speed] / Par 22 [MOP Accel Time]. If "0" is entered in this parameter, the ramp output directly follows the reference value.	Default: 10 Min/Max: 0 / 65535 Units: s	16-bit Int	2
		24	<b>[Accel Time 2]</b> Sets the rate of acceleration for linear ramp 2. Acceleration rate for ramp 2 = Par 2 [Maximum Speed] / Par 24 [Accel Time 2].	Default: 10 Min/Max: 0 / 65535 Units: s	16-bit Int	2
		30	<b>[MOP Decel Time]</b> The deceleration rate for the MOP reference in response to a digital input. The MOP deceleration rate = Par 2 [Maximum Speed] / Par 30 [MOP Decel Time].	Default: 10 Min/Max: 0 / 65535 Units: s	16-bit Int	2
		32	<b>[Decel Time 2]</b> Sets the rate of deceleration for linear ramp 2. Deceleration rate for ramp 2 = Par 2 [Maximum Speed] / Par 32 [Decel Time 2].	Default: 10 Min/Max: 0 / 65535 Units: s	16-bit Int	2
		245 	<b>[Speed Ramp En]</b> Enables or disables the ramp function. The Ramp Reference block is bypassed when this parameter is set to 0 "Disabled".	Default: 1 = "Enabled" Options: 0 = "Disabled", 1 = "Enabled"	16-bit Int	
		344 <b>A</b>	<b>[Zero Ramp Output]</b> Activates either the ramp output (1) or the brake function (0). When this parameter is set to 0 "Active", the drive brakes through the maximum available torque and the motor will perform a Current Limit Stop. Two quadrant drives do not support a brake option. <ul style="list-style-type: none"> <li>"Active" = The ramp output is disabled and Pars 113 [Ramp Out] and 114 [Ramp Out Pct] are immediately set to zero.</li> <li>"Not Active" = The ramp output is enabled, and Pars 113 [Ramp Out] and 114 [Ramp Out Pct] follow the Ramp Reference block commands.</li> </ul>	Default: 1 = "Not Active" Options: 0 = "Active", 1 = "Not Active"	16-bit Int	
		345 <b>A</b>	<b>[Zero Ramp Input]</b> Activates or deactivates the ramp input. <ul style="list-style-type: none"> <li>"Active" = The ramp input is not active and Pars 110 [Ramp In] and 111 [Ramp In Pct] = 0.</li> <li>"Not Active" = The ramp input is activated and Pars 110 [Ramp In] and 111 [Ramp In Pct] correspond to the set reference.</li> </ul>	Default: 1 = "Not Active" Options: 0 = "Active", 1 = "Not Active"	16-bit Int	110, 111
		373 <b>A</b>	<b>[Freeze Ramp]</b> Determines whether the last ramp output reference value is retained or whether the ramp output reference value is active. <ul style="list-style-type: none"> <li>"Active" = The value of the ramp output at the time of activation is retained irrespective of any possible reference value changes at the ramp input.</li> <li>"Not Active" = The ramp output value follows the ramp input value according to the Ramp Reference Block commands.</li> </ul>	Default: 1 = "Not Active" Options: 0 = "Active", 1 = "Not Active"	16-bit Int	



File	Group	No.	Parameter Name & Description <small>See page 117 for symbol descriptions</small>	Values	Data Type	Related
DYNAMIC CONTROL	Ramp Rates	660	<b>[Accel Time 1]</b> Sets the rate of acceleration for linear ramp 1. Acceleration rate for ramp 1 = Par 2 [Maximum Speed] / Par 660 [Accel Time 1].	Default: 10 Min/Max: 0 / 65535 Units: s	16-bit Int	2
		662	<b>[Decel Time 1]</b> Sets the rate of deceleration for linear ramp 1. Deceleration rate for ramp 1 = Par 2 [Maximum Speed] / Par 662 [Decel Time 1].	Default: 10 Min/Max: 0 / 65535 Units: s	16-bit Int	2
		665 <b>A</b>	<b>[S Curve Accel 1]</b> Amount of time (approximately half at the start and half at the end) applied to the S-curve during Accel 1 changes. When Par 19 [S Curve Time] is changed this parameter is automatically set to the same value. For asymmetrical S-curve ramps, set this parameter after [S Curve Time] is changed. Note: See S-curve Configuration on page 333 for more information.	Default: 1.00 Min/Max: 0.10 / 15.00 Units: s	Real	19
		666 <b>A</b>	<b>[S Curve Decel 1]</b> Amount of time (approximately half at the start and half at the end) applied to the S-curve during Decel 1 changes. When Par 19 [S Curve Time] is changed this parameter is automatically set to the same value. For asymmetrical S-curve ramps, set this parameter after [S Curve Time] is changed. Note: See S-curve Configuration on page 333 for more information.	Default: 1.00 Min/Max: 0.10 / 15.00 Units: s	Real	19
		667 <b>A</b>	<b>[S Curve Accel 2]</b> Amount of time (approximately half at the start and half at the end) applied to the S-curve during Accel 2 changes. When Par 19 [S Curve Time] is changed this parameter is automatically set to the same value. For asymmetrical S-curve ramps, set this parameter after [S Curve Time] is changed. Note: See S-curve Configuration on page 333 for more information.	Default: 1.00 Min/Max: 0.10 / 15.00 Units: s	Real	19
		668 <b>A</b>	<b>[S Curve Decel 2]</b> Amount of time (approximately half at the start and half at the end) applied to the S-curve during Decel 2 changes. When Par 19 [S Curve Time] is changed this parameter is automatically set to the same value. For asymmetrical S-curve ramps, set this parameter after [S Curve Time] is changed. Note: See S-curve Configuration on page 333 for more information.	Default: 1.00 Min/Max: 0.10 / 15.00 Units: s	Real	19
		1410	<b>[Jog Ramp Time]</b> Sets the rate of acceleration and deceleration while the Jog function is active. The Jog rate = Par 2 [Maximum Speed] / Par 1410 [Jog Ramp Time]. Note: This parameter was added for firmware revision 2.001.	Default: 10 Min/Max: 0 / 65535 Units: s	16-bit Int	2
		13 <b>A</b>	<b>[Torq Red Curlim]</b> The armature current limit, defined as a percentage of the value defined in Par 179 [Nom Mtr Arm Amps] when Par 342 [Torque Reduction] is set to 1 "Active".	Default: 100 Min/Max: 0 / 200 Units: %	16-bit Int	342
		696 <b>A</b>	<b>[Droop Percent]</b> Droop function gain is a percentage of the ratio between Par 45 [Max Ref Speed] and the difference of Par 698 [Load Comp] – Par 41 [Current Reg In]. Therefore, when the difference between Par 698 [Load Comp] and Par 41 [Current Reg In] = 100% and Par 696 [Droop Percent] = 100%, the speed reference correction signal is equal to Par 45 [Max Ref Speed]. Note: See Droop Compensation on page 302 for more information.	Default: 0.00 Min/Max: 0.00 / 100.00 Units: %	Real	41, 45, 698
		697 <b>A</b>	<b>[Droop Filter]</b> Droop filter time constant for the Droop function. Notes: See Droop Compensation on page 302 for more information. Changed the default value from 0 to 100 for firmware revision 6.001.	Default: 100 Min/Max: 0 / 1000 Units: ms	16-bit Int	
698 <b>A</b>	<b>[Load Comp]</b> The load compensation signal. This value is typically equal to the "master" drive's current. The load compensation signal is a percentage of $I_{dn}$ .	Default: 0 Min/Max: + / -200 Units: %	16-bit Int			

File	Group	No.	Parameter Name & Description <small>See page 117 for symbol descriptions</small>	Values	Data Type	Related
DYNAMIC CONTROL	Load Limits	699 	<b>[Enable Droop]</b> Enables/Disables the Droop function. <ul style="list-style-type: none"> <li>• “Enabled” = The Droop function is enabled.</li> <li>• “Disabled” = The Droop function is disabled.</li> </ul> Note: This parameter can be assigned to a digital input.	Default: 0 = “Disabled” Options: 0 = “Disabled” 1 = “Enabled”	16-bit Int	
		700 	<b>[Droop Limit]</b> The speed reference correction range within which the droop function becomes active. Note: See Droop Compensation on page 302 for more information.	Default: 1750 Min/Max: 0 / Par 45 [Max Ref Speed] Units: rpm	16-bit Int	
		715  	<b>[Torq Limit Type]</b> This parameter determines the response of the drive during a current limiting condition. <ul style="list-style-type: none"> <li>• “T Lim PosNeg” = The active positive torque limit is set by the value defined in Par 7 [Current Limit] and the active negative torque limit is set by the value defined in Par 9 [Current Lim Neg].</li> <li>• “T Lim MtrGen” = With this option the following three conditions apply:                             <ol style="list-style-type: none"> <li>1.If the motor speed is greater than +1% of Par 162 [Max Feedback Spd], the active positive torque limit is set by the value defined in Par 8 [Current Lim Pos] and the active negative torque limit is set by the value defined in Par 9 [Current Lim Neg].</li> <li>2.If the motor speed is less than -1% of Par 162 [Max Feedback Spd] the active positive torque limit is set by the value defined in Par 9 [Current Lim Neg] and the active negative torque limit is set by the value defined in Par 8 [Current Lim Pos].</li> <li>3.If the motor speed is greater than -1% of Par 162 [Max Feedback Spd] and less than +1% of Par 162 [Max Feedback Spd] the active positive and negative torque limits are set by the value defined in Par 8 [Current Lim Pos].</li> </ol> </li> </ul> Note: The option names were corrected to those shown above for firmware revision 4.001.	Default: 0 = “T Lim PosNeg” Options: 0 = “T Lim PosNeg” 1 = “T Lim MtrGen”	16-bit Int	7, 8, 9, 162
	Stop Modes	38 	<b>[Fast Stop Time]</b> The amount of time to decelerate the drive to a complete stop and disable the drive. The deceleration rate for Fast stop = [Maximum Speed] / [Fast Stop Time]. This feature can be used when [Digital Inx Sel] is set to 30 “Fast Stop” or when certain alarms are configured for “Fast Stop”. See Pars 354 [Aux Inp Flt Cfg] and 365 [OverTemp Flt Cfg].	Default: 10 Min/Max: 0 / 65535 Units: s	16-bit Int	354, 365
		627 	<b>[Spd 0 Trip Delay]</b> The amount of time that will elapse after the drive reaches zero speed before it is disabled.	Default: 0 Min/Max: 0 / 40000 Units: ms	16-bit Int	
		1262 	<b>[Closing Speed]</b> Motor speed at which the brake is closed. Used with External Brake Control.	Default: 30 Min/Max: 0 / 200 Units: rpm	16-bit Int	
		1263 	<b>[Opening Delay]</b> Amount of time before the brake will open after the drive has been enabled. Used with External Brake Control.	Default: 0 Min/Max: 0 / 30000 Units: ms	16-bit Int	
		1265 	<b>[Ramp In Zero En]</b> Enables/Disables the setting of the ramp input to zero. Used with External Brake Control.	Default: 0 = “Disabled” Options: 0 = “Disabled” 1 = “Enabled”	16-bit Int	
		1266 	<b>[Actuator Delay]</b> Amount of time before the actuator releases the load. Used with External Brake Control.	Default: 0 Min/Max: 0 / 30000 Units: ms	16-bit Int	

File	Group	No.	Parameter Name & Description <small>See page 117 for symbol descriptions</small>	Values	Data Type	Related
DYNAMIC CONTROL	Restart Modes	1344	<b>[Start At Powerup]</b> Enables/Disables the ability to issue a “Run” command and automatically resume running at commanded speed after drive input power is restored and the time in Par 1345 [Powerup Delay] has elapsed. Requires a digital input configured for “Run” and a valid start condition. Note: See Start At Powerup on page 348 for more information.	Default: 0 = “Disabled” Options: 0 = “Disabled” 1 = “Enabled”	16-bit Int	1345
		 <b>ATTENTION:</b> Equipment damage and/or personal injury may result if this parameter is used in an inappropriate application. Do not use this function without considering applicable local, national and international codes, standards, regulations or industry guidelines.				
		1345	<b>[Powerup Delay]</b> Defines the programmed delay time, in seconds, before a start command is accepted after a power up. If a “Start”, “Run” or “Stop” command is asserted before the time in this parameter expires, the “Start At Powerup” function will be aborted. Note: See Start At Powerup on page 348 for more information.	Default: 1 Min/Max: 1 / 10800 Units: s	16-bit Int	1344
	Adapty Regulator	181	 <b>[Adaptive Spd En]</b> Enables/Disables adaptive speed regulation. The adaptive speed regulator function enables different gains of the speed regulator depending on the speed or another variable (Par 183 [Adaptive Ref]). This allows adaptation of the speed regulator to your specific application. When adaptive speed regulation is disabled, the regulator operates based on the settings in the individual regulation parameters. Note: See Adaptive Speed Regulator on page 335 for more information.	Default: 0 = “Disabled” Options: 0 = “Disabled” 1 = “Enabled”	16-bit Int	182, 183
		182	 <b>[Adaptive Reg Typ]</b> Selects the type of regulation used. <ul style="list-style-type: none"> <li>• “Speed” = The regulator parameters follow a speed reference.</li> <li>• “Adaptive Ref” = The regulator parameters follow the reference produced by Par 183 [Adaptive Ref].</li> </ul> Note: See Adaptive Speed Regulator on page 335 for more information.	Default: 0 = “Speed” Options: 0 = “Speed” 1 = “Adaptive Ref”	16-bit Int	183
		183	 <b>[Adaptive Ref]</b> The variable reference that the speed regulator parameter will follow when Par 182 [Adaptive Reg Typ] = 1 “Adaptive Ref”. Note: See Adaptive Speed Regulator on page 335 for more information.	Default: 1000 Min/Max: -/+6000 Units: rpm	16-bit Int	182
		184	 <b>[Adaptive Spd 1]</b> A percentage of Par 45 [Max Ref Speed] or the maximum value of Par 183 [Adaptive Ref]. Parameter set 1 is valid below the value set in this parameter and parameter set 2 is valid above the value set in this parameter. The transition between the values is defined by Par 186 [Adaptive Joint 1]. Note: See Adaptive Speed Regulator on page 335 for more information.	Default: 20.34 Min/Max: 0.00 / 200.00 Units: %	Real	183, 186
		185	 <b>[Adaptive Spd 2]</b> A percentage of Par 45 [Max Ref Speed] or the maximum value of Par 183 [Adaptive Ref]. Parameter set 2 is valid below the value set in this parameter and parameter set 3 is valid above the value set in this parameter. The transition between the values is defined by Par 187 [Adaptive Joint 2]. Note: See Adaptive Speed Regulator on page 335 for more information.	Default: 40.69 Min/Max: 0.00 / 200.00 Units: %	Real	183, 187
		186	 <b>[Adaptive Joint 1]</b> Defines a range above and below the value set in Par 184 [Adaptive Spd 1] within which there is a linear change in gain from parameter set 1 to parameter set 2 to prevent jumps in the adaptive speed regulator. The value in this parameter is defined as percentage of the value defined Par 45 [Max Ref Speed]. Note: See Adaptive Speed Regulator on page 335 for more information.	Default: 6.11 Min/Max: 0.00 / 200.00 Units: %	Real	184

File	Group	No.	Parameter Name & Description <small>See page 117 for symbol descriptions</small>	Values	Data Type	Related
DYNAMIC CONTROL	Adaptv Regulator	187	<b>[Adaptive Joint 2]</b> Defines a range above and below the value set in Par 185 [Adaptive Spd 2] with in which there is a linear change in gain from parameter set 2 to parameter set 3 to prevent jumps in the adaptive speed regulator. The value in this parameter is defined as percentage of the value defined Par 45 [Max Ref Speed]. Note: See Adaptive Speed Regulator on page 335 for more information.	Default: 6.11 Min/Max: 0.00 / 200.00 Units: %	Real	185
		188	<b>[Adaptive P Gain1]</b> Proportional gain for the range from zero to the value set in Par 184 [Adaptive Spd 1]. The value in this parameter is defined as percentage of the value defined in Par 93 [Spd Reg Kp Base]. Note: See Adaptive Speed Regulator on page 335 for more information.	Default: 10.00 Min/Max: 0.00 / 100.00	Real	93, 184
		189	<b>[Adaptive I Gain1]</b> Integral gain for the range from zero to Par 184 [Adaptive Spd 1]. The value in this parameter is defined as percentage of the value defined Par 94 [Spd Reg Ki Base]. Note: See Adaptive Speed Regulator on page 335 for more information.	Default: 1.00 Min/Max: 0.00 / 100.00 Units: s <sup>-1</sup>	Real	94, 184
		190	<b>[Adaptive P Gain2]</b> Proportional gain for the range of values defined beginning with the value of Par 184 [Adaptive Spd 1] to the value defined in Par 185 [Adaptive Spd 2]. The value in this parameter is defined as percentage of the value defined Par 93 [Spd Reg Kp Base]. Note: See Adaptive Speed Regulator on page 335 for more information.	Default: 10.00 Min/Max: 0.00 / 100.00	Real	93, 184, 185
		191	<b>[Adaptive I Gain2]</b> Integral gain for the range of values defined beginning with the value of Par 184 [Adaptive Spd 1] to the value defined in Par 185 [Adaptive Spd 2]. The value in this parameter is defined as percentage of the value defined Par 94 [Spd Reg Ki Base]. Note: See Adaptive Speed Regulator on page 335 for more information.	Default: 1.00 Min/Max: 0.00 / 100.00 Units: s <sup>-1</sup>	Real	94, 184, 185
		192	<b>[Adaptive P Gain3]</b> Proportional gain for the range of values beginning above the value defined in Par 185 [Adaptive Spd 2]. The value in this parameter is defined as percentage of the value defined Par 93 [Spd Reg Kp Base]. Note: See Adaptive Speed Regulator on page 335 for more information.	Default: 10.00 Min/Max: 0.00 / 100.00	Real	93, 185
		193	<b>[Adaptive I Gain3]</b> Integral gain for the range of values beginning above the value defined in Par 185 [Adaptive Spd 2]. The value in this parameter is defined as percentage of the value defined Par 94 [Spd Reg Ki Base]. Note: See Adaptive Speed Regulator on page 335 for more information.	Default: 1.00 Min/Max: 0.00 / 100.00 Units: s <sup>-1</sup>	Real	94, 185

# Applications File

File	Group	No.	Parameter Name & Description <small>See page 117 for symbol descriptions</small>	Values	Data Type	Related
APPLICATIONS	PI Control	695 <b>A</b>	<b>[PI Steady Thrsh]</b> Feed-forward threshold for PI. <ul style="list-style-type: none"> <li>If the value of Par 758 [Feed Fwd PID] is less than the value of Par 695 [PI Steady Thrsh] the integral regulation will be locked and the proportional gain assumes the value set in Par 793 [PI Init Prop Gn].</li> <li>When the value of Par 758 [Feed Fwd PID] exceeds the value of Par 695 [PI Steady Thrsh], the integral regulation with the gain set in Par 734 [PI Init Intgl Gn] will be enabled.</li> <li>The Proportional / Integral (PI) block will maintain the gain values specified in Pars 793 [PI Init Prop Gn] and 734 [PI Init Intgl Gn] for the time specified in Par 731 [PID Steady Delay]; once this time delay has elapsed, the values of [PI Init Prop Gn] and [PI Init Intgl Gn] will be brought automatically to the values specified in Pars 765 [PI Prop Gain PID] and 764 [PI Integral Gain], respectively.</li> </ul>	Default: 0 Min/Max: 0 / 10000	16-bit Int	758
		731 <b>A</b>	<b>[PID Steady Delay]</b> The amount of time for which the gains in Pars 793 [PI Init Prop Gn] and 734 [PI Init Intgl Gn] will remain enabled after feed-forward has exceeded the threshold value defined in Par 695 [PI Steady Thrsh].	Default: 0 Min/Max: 0 / 60000 Units: ms	16-bit Int	695, 734, 793
		734 <b>A</b>	<b>[PI Init Intgl Gn]</b> The initial value of the integral gain. This parameter is active when feed-forward is greater than the value defined in Par 695 [PI Steady Thrsh], or Par 769 [Enable PI] transitions from "0" (low) to "1" (high) and the amount of time defined in Par 731 [PID Steady Delay] has elapsed.	Default: 10.00 Min/Max: 0.00 / 100.00	Real	695, 731, 769
		764 <b>A</b>	<b>[PI Integral Gain]</b> Integral gain of the PI block.	Default: 10.00 Min/Max: 0.00 / 100.00	Real	
		765 <b>A</b>	<b>[PI Prop Gain PID]</b> Proportional gain of the PI block.	Default: 10.00 Min/Max: 0.00 / 100.00	Real	
		769 <b>A</b>	<b>[Enable PI]</b> Enables/Disables the PI portion of the PID regulator. If assigned to a digital input, this parameter must be brought at a high logical level (+24V).	Default: 0 = "Disabled" Options: 0 = "Disabled" 1 = "Enabled"	16-bit Int	
		771 <b>A</b>	<b>[PI Output]</b> Output value of the PI block, adapted to the value between the values defined in Pars 784 [PI Upper Limit] and 785 [PI Lower Limit]. When the drive is turned on, the value of this parameter is acquired automatically based on the value of Par 779 [PI Central v sel] x 1000.	Default: Read Only Min/Max: 0 / 10000	16-bit Int	784, 785, 779
		776 <b>A</b>	<b>[PI Central v1]</b> The first value that can be selected, via Par 779 [PI Central v sel], as the initial output of the PID regulator's integral component (corresponding to initial diameter 1). The value entered in this parameter must be less than the value set in Par 784 [PI Upper Limit] and greater than the value set in Par 785 [PI Lower Limit].	Default: 0.00 Min/Max: Par 785 [PI Lower Limit] / Par 784 [PI Upper Limit]	Real	784, 785, 779
		777 <b>A</b>	<b>[PI Central v2]</b> The second value that can be selected, via Par 779 [PI Central v sel], as the initial output of the PID regulator's integral component (corresponding to initial diameter 2). The value entered in this parameter must be less than the value set in Par 784 [PI Upper Limit] and greater than the value set in Par 785 [PI Lower Limit].	Default: 0.00 Min/Max: Par 785 [PI Lower Limit] / Par 784 [PI Upper Limit]	Real	784, 785, 779
		778 <b>A</b>	<b>[PI Central v3]</b> The third value that can be selected, via Par 779 [PI Central v sel], as the initial output of the PID regulator's integral component (corresponding to initial diameter 3). The value entered in this parameter must be less than the value set in Par 784 [PI Upper Limit] and greater than the value set in Par 785 [PI Lower Limit]. Note: This parameter can be assigned to an analog input.	Default: 0.00 Min/Max: Par 785 [PI Lower Limit] / Par 784 [PI Upper Limit]	Real	784, 785, 779


File	Group	No.	Parameter Name & Description <small>See page 117 for symbol descriptions</small>	Values	Data Type	Related															
APPLICATIONS	PI Control	779 <b>A</b>	<b>[PI Central v sel]</b> Selects one of the four possible initial output values of the PID regulator integral component (corresponding to the initial diameter) of the PI block. <ul style="list-style-type: none"> <li>“0” = When the PI block is disabled (Par 769 [Enable PI] = “Disabled”), the last value of the integral component calculated (corresponding to roll diameter) is stored in Par 771 [PI Output]. This value is used by the PID regulator when the PI block is enabled again and the drive is restarted. This function is useful when for any reason the drive must be turned off or if incoming power is removed from the drive.</li> <li>“1”, “2”, or “3” = When the PI block is disabled (Par 769 [Enable PI] = “Disabled”), the value of [PI Output] will be set to the value of the selected parameter (“1” = 776 [PI Central v1], “2” = 777, [PI Central v2], or “3” = 778 [PI Central v3] x1000). This value is only used by the PID regulator when the drive is powered up and Par 769 [Enable PI] is already enabled.</li> </ul> Note: Par 779 [PI Central v sel] can be set directly from the HIM or through two digital inputs set respectively as “PI central vs0” and “PI central vs1”. See Pars 780 [PI Central vs0] and 781 [PI Central vs1] for more information on this configuration.	Default: 1 Min/Max: 0 / 3	16-bit Int	769, 776, 777, 778, 780, 781															
		780 <b>A</b>	<b>[PI Central vs0]</b> When assigned to a digital input and used in combination with Par 781 [PI Central vs1], through binary selection, determines which of the four possible output values is used as the initial level of the integral component (corresponding to the initial diameter) of the PI block.  <table border="1"> <thead> <tr> <th>Par 780</th> <th>Par 781</th> <th>Selects the value in...</th> </tr> </thead> <tbody> <tr> <td>0</td> <td>0</td> <td>Par 771 [PI Output]</td> </tr> <tr> <td>0</td> <td>1</td> <td>Par 776 [PI Central v1]</td> </tr> <tr> <td>1</td> <td>0</td> <td>Par 777 [PI Central v2]</td> </tr> <tr> <td>1</td> <td>1</td> <td>Par 778 [PI Central v3]</td> </tr> </tbody> </table>	Par 780	Par 781	Selects the value in...	0	0	Par 771 [PI Output]	0	1	Par 776 [PI Central v1]	1	0	Par 777 [PI Central v2]	1	1	Par 778 [PI Central v3]	Default: 0 Min/Max: 0 / 1	16-bit Int	
		Par 780	Par 781	Selects the value in...																	
		0	0	Par 771 [PI Output]																	
		0	1	Par 776 [PI Central v1]																	
		1	0	Par 777 [PI Central v2]																	
		1	1	Par 778 [PI Central v3]																	
		781 <b>A</b>	<b>[PI Central vs1]</b> The output selector of the initial PI block. With the value of Par 780 [PI Central vs0] determined, through binary selection, what between the four possible settings of the integral initial level (correspondent to initial diameter) can be used. See Par 780 [PI Central vs0] for binary selections.	Default: 0 Min/Max: 0 / 1	16-bit Int																
		783 <b>A</b>	<b>[PI integr freeze]</b> Locks the selections made for the integral component of the PID regulator.	Default: 0 = “Off” Options: 0 = “Off” 1 = “On”	16-bit Int																
		784 <b>A</b>	<b>[PI Upper Limit]</b> Defines the upper limit of the adapting block for correction of the PI block.	Default: 10.00 Min/Max: Par 785 [PI Lower Limit] / 10.00	Real																
785 <b>A</b>	<b>[PI Lower Limit]</b> Defines the lower limit of the adapting block for correction of the PI block.	Default: 0.00 Min/Max: -10.00 / Par 784 [PI Upper Limit]	Real																		
793 <b>A</b>	<b>[PI Init Prop Gn]</b> The initial value of the proportional gain. This parameter is active when, <ul style="list-style-type: none"> <li>its value has exceeded the value of Par 695 [PI Steady Thrsh],</li> <li>the amount of time defined in Par 731 [PID Steady Delay] has elapsed, and feed-forward is less than the value defined in Par 695 [PI Steady Thrsh], or</li> <li>Par 769 [Enable PI] transitions from “0” (low) to “1” (high) and the amount of time defined in Par 731 [PID Steady Delay] has elapsed.</li> </ul>	Default: 10.00 Min/Max: 0.00 / 100.00	Real	695, 731, 769																	
PD Control	421 <b>A</b>	<b>[PD Output PID]</b> Proportional / Derivative (PD) block output.	Default: Read Only Min/Max: -/+10000	16-bit Int																	
	766 <b>A</b>	<b>[PD Deriv Gain 1]</b> First derivative gain of the PD block. The value specified in this field depends on the enabling and configuration of Par 181 [Adaptive Spd En].	Default: 1.00 Min/Max: 0.00 / 100.00	Real	181																
	767 <b>A</b>	<b>[PD Deriv Filter]</b> Time constant of the filter from the derivative portion of the PD block.	Default: 0 Min/Max: 1 / 1000 Units: ms	16-bit Int																	















File	Group	No.	Parameter Name & Description <small>See page 117 for symbol descriptions</small>	Values	Data Type	Related
APPLICATIONS	PD Control	768 <b>A</b>	<b>[PD Prop Gain 1]</b> First proportional gain of the block PD. The value specified in this field depends on the enabling and configuration of Par 181 [Adaptive Spd En].	Default: 10.00 Min/Max: 0.00 / 100.00	Real	181
		770 <b>A</b>	<b>[Enable PD]</b> Enables/disables the PD portion of the PID regulator. Note: This parameter can be assigned to a digital input.	Default: 0 = "Disabled" Options: 0 = "Disabled" 1 = "Enabled"	16-bit Int	
		788 <b>A</b>	<b>[PD Prop Gain 2]</b> Second proportional gain of the block PD. The value specified in this field depends on the enabling and configuration of Par 181 [Adaptive Spd En].	Default: 10.0 Min/Max: 0.0 / 100.0	Real	181
		789 <b>A</b>	<b>[PD Deriv Gain 2]</b> Second derivative gain of the PD block. The value specified in this field depends on the enabling and configuration of Par 181 [Adaptive Spd En].	Default: 10.0 Min/Max: 0.0 / 100.0	Real	181
		790 <b>A</b>	<b>[PD Prop Gain 3]</b> Third proportional gain of the block PD. The value specified in this field depends on the enabling and configuration of Par 181 [Adaptive Spd En].	Default: 10.0 Min/Max: 0.0 / 100.0	Real	181
		791 <b>A</b>	<b>[PD Deriv Gain 3]</b> Third derivative gain of the PD block. The value specified in this field depends on the enabling and configuration of Par 181 [Adaptive Spd En].	Default: 1.00 Min/Max: 0.00 / 100.00	Real	181
		418	<b>[Real FF PID]</b> Represents the feed-forward value which has been recalculated according to the PI correction. It will be calculated with the following formula: Par 418 [Real FF PID] = (Par 758 [Feed Fwd PID] / 1000) x Par 771 [PI Output] When either the negative or positive limit of this parameter has been reached, further increases in the value of Par 771 [PI Output] will be blocked to avoid undesirable saturation of the PID regulator. For example: When Par 758 [Feed Fwd PID] = +8000, the positive limit of Par 771 [PI Output] will be automatically set at 10000 / (8000 / 1000) = 1250.	Default: Read Only Min/Max: -/+10000	16-bit Int	758, 771
	757 <b>A</b>	<b>[PID Clamp]</b> The PID "clamp" allows a smooth tension setting of a controlled system winder/unwinder when the calculation of the initial diameter function cannot be used. <ul style="list-style-type: none"> <li>When enabling the drive, the dancer is at the lowest point of its full scale. In this case, with Par 759 [PID Error] at its maximum value, the motor could accelerate too fast to properly configure the dancer for its central operating position. By setting the value of Par 757 [PID Clamp] sufficiently low. e.g., = 1000, when the drive starts and Par 770 [Enable PD] = 1 "Enable", the value of Par 759 [PID Error] is limited to 1000 until the signal coming from the dancer (via Par 763 [PID Feedback]) goes above the value in this field. Then, the value of [PID Clamp] is automatically returned to its maximum value of 10000. The PID clamp is kept at 10000 until the drive stops or Par 770 [Enable PD] = 0 "Disabled".</li> </ul>	Default: 10000 Min/Max: 0 / 10000	16-bit Int	759, 763, 770	
	758 <b>A</b>	<b>[Feed Fwd PID]</b> Feedback from the transducer position (dancer) or tension.	Default: Read Only Min/Max: -/+10000	16-bit Int		
	759 <b>A</b>	<b>[PID Error]</b> Error value input to the PID function (output of the PID Clamp block).	Default: Read Only Min/Max: -/+10000	16-bit Int		
	760 <b>A</b>	<b>[PID Setpoint 0]</b> First offset value added to Par 763 [PID Feedback]. This parameter can be assigned to an analog input, for example, for the tension setting when a load cell must be used as feedback.	Default: 0 Min/Max: -/+10000	16-bit Int	763	
	761 <b>A</b>	<b>[PID Setpoint 1]</b> Second offset value added to Par 763 [PID Feedback].	Default: 0 Min/Max: -/+10000	16-bit Int	763	
	762 <b>A</b>	<b>[PID Setpoint Sel]</b> Selects the offset value added to Par 763 [PID Feedback]. This parameter can be assigned to a digital input.	Default: 0 = "Setpoint 0" Options: 0 = "Setpoint 0" 1 = "Setpoint 1"	16-bit Int	763	
		PID Control				



File	Group	No.	Parameter Name & Description <small>See page 117 for symbol descriptions</small>	Values	Data Type	Related																																																	
APPLICATIONS	PID Control	763 <b>A</b>	<b>[PID Feedback]</b> Analog input feedback value received from the transducer position (dancer) or tension (load cell).	Default: 0 Min/Max: -/+10000	16-bit Int																																																		
		772 <b>A</b>	<b>[PID Output Sign]</b> Determines whether the output of the PID regulator is bipolar or positive (clamp of the negative side).	Default: 1 = "Bipolar" Options: 0 = "Positive" 1 = "Bipolar"	16-bit Int																																																		
		773 <b>A</b>	<b>[PID Output Scale]</b> Scale factor for Par 774 [PID Output]. The value of this parameter depends on to which parameter you want to send the PID regulator output.	Default: 1.00 Min/Max: -/+100.00	Real	774																																																	
		774 <b>A</b>	<b>[PID Output]</b> Displays the PID regulator output. Note: This parameter can be assigned to an analog output to provide a cascaded reference in multi-drive systems.	Default: Read Only Min/Max: -/+10000	16-bit Int																																																		
		782 <b>A</b>	<b>[PID Target]</b> Parameter number to which the PID Output value will be written. Note: Added option 48 "Reserved" for firmware revision 5.002. Options:	Default: 0 = "Not Used"	16-bit Int																																																		
		<table border="1"> <tbody> <tr> <td>0 = "Not Used"</td> <td>17 = "Max Fld Pct" (Par 467)</td> <td>34 = "UsrDefined15" (Par 518)</td> </tr> <tr> <td>1 = "Cur Lim Pos" (Par 8)</td> <td>18 = "Reserved"</td> <td>35 = "Load Comp" (Par 698)</td> </tr> <tr> <td>2 = "Cur Lim Neg" (Par 9)</td> <td>19 = "UsrDefined0" (Par 503)</td> <td>36 = "Out Volt Lvl" (Par 921)</td> </tr> <tr> <td>3 = "Reserved"</td> <td>20 = "UsrDefined1" (Par 504)</td> <td>37 = "Reserved"</td> </tr> <tr> <td>4 = "Reserved"</td> <td>21 = "UsrDefined2" (Par 505)</td> <td>38 = "Speed Ratio" (Par 1017)</td> </tr> <tr> <td>5 = "TrqRedCurLim" (Par 13)</td> <td>22 = "UsrDefined3" (Par 506)</td> <td>39 = "Reserved"</td> </tr> <tr> <td>6 = "Torque Ref" (Par 39)</td> <td>23 = "UsrDefined4" (Par 507)</td> <td>40 = "Reserved"</td> </tr> <tr> <td>7 = "Trim Torque" (Par 40)</td> <td>24 = "UsrDefined5" (Par 508)</td> <td>41 = "Tension Red" (Par 1179)</td> </tr> <tr> <td>8 = "Reserved"</td> <td>25 = "UsrDefined6" (Par 509)</td> <td>42 = "Reserved"</td> </tr> <tr> <td>9 = "Trim Ramp" (Par 42)</td> <td>26 = "UsrDefined7" (Par 510)</td> <td>43 = "Reserved"</td> </tr> <tr> <td>10 = "Trim Speed" (Par 43)</td> <td>27 = "UsrDefined8" (Par 511)</td> <td>44 = "CloseLp Comp" (Par 1208)</td> </tr> <tr> <td>11 = "Reserved"</td> <td>28 = "UsrDefined9" (Par 512)</td> <td>45 = "Reserved"</td> </tr> <tr> <td>12 = "Reserved"</td> <td>29 = "UsrDefined10" (Par 513)</td> <td>46 = "Reserved"</td> </tr> <tr> <td>13 = "Reserved"</td> <td>30 = "UsrDefined11" (Par 514)</td> <td>47 = "Reserved"</td> </tr> <tr> <td>14 = "Adaptive Ref" (Par 183)</td> <td>31 = "UsrDefined12" (Par 515)</td> <td>48 = "Reserved"</td> </tr> <tr> <td>15 = "Reserved"</td> <td>32 = "UsrDefined13" (Par 516)</td> <td></td> </tr> <tr> <td>16 = "Reserved"</td> <td>33 = "UsrDefined14" (Par 517)</td> <td></td> </tr> </tbody> </table>			0 = "Not Used"	17 = "Max Fld Pct" (Par 467)	34 = "UsrDefined15" (Par 518)	1 = "Cur Lim Pos" (Par 8)	18 = "Reserved"	35 = "Load Comp" (Par 698)	2 = "Cur Lim Neg" (Par 9)	19 = "UsrDefined0" (Par 503)	36 = "Out Volt Lvl" (Par 921)	3 = "Reserved"	20 = "UsrDefined1" (Par 504)	37 = "Reserved"	4 = "Reserved"	21 = "UsrDefined2" (Par 505)	38 = "Speed Ratio" (Par 1017)	5 = "TrqRedCurLim" (Par 13)	22 = "UsrDefined3" (Par 506)	39 = "Reserved"	6 = "Torque Ref" (Par 39)	23 = "UsrDefined4" (Par 507)	40 = "Reserved"	7 = "Trim Torque" (Par 40)	24 = "UsrDefined5" (Par 508)	41 = "Tension Red" (Par 1179)	8 = "Reserved"	25 = "UsrDefined6" (Par 509)	42 = "Reserved"	9 = "Trim Ramp" (Par 42)	26 = "UsrDefined7" (Par 510)	43 = "Reserved"	10 = "Trim Speed" (Par 43)	27 = "UsrDefined8" (Par 511)	44 = "CloseLp Comp" (Par 1208)	11 = "Reserved"	28 = "UsrDefined9" (Par 512)	45 = "Reserved"	12 = "Reserved"	29 = "UsrDefined10" (Par 513)	46 = "Reserved"	13 = "Reserved"	30 = "UsrDefined11" (Par 514)	47 = "Reserved"	14 = "Adaptive Ref" (Par 183)	31 = "UsrDefined12" (Par 515)	48 = "Reserved"	15 = "Reserved"	32 = "UsrDefined13" (Par 516)		16 = "Reserved"	33 = "UsrDefined14" (Par 517)	
0 = "Not Used"	17 = "Max Fld Pct" (Par 467)	34 = "UsrDefined15" (Par 518)																																																					
1 = "Cur Lim Pos" (Par 8)	18 = "Reserved"	35 = "Load Comp" (Par 698)																																																					
2 = "Cur Lim Neg" (Par 9)	19 = "UsrDefined0" (Par 503)	36 = "Out Volt Lvl" (Par 921)																																																					
3 = "Reserved"	20 = "UsrDefined1" (Par 504)	37 = "Reserved"																																																					
4 = "Reserved"	21 = "UsrDefined2" (Par 505)	38 = "Speed Ratio" (Par 1017)																																																					
5 = "TrqRedCurLim" (Par 13)	22 = "UsrDefined3" (Par 506)	39 = "Reserved"																																																					
6 = "Torque Ref" (Par 39)	23 = "UsrDefined4" (Par 507)	40 = "Reserved"																																																					
7 = "Trim Torque" (Par 40)	24 = "UsrDefined5" (Par 508)	41 = "Tension Red" (Par 1179)																																																					
8 = "Reserved"	25 = "UsrDefined6" (Par 509)	42 = "Reserved"																																																					
9 = "Trim Ramp" (Par 42)	26 = "UsrDefined7" (Par 510)	43 = "Reserved"																																																					
10 = "Trim Speed" (Par 43)	27 = "UsrDefined8" (Par 511)	44 = "CloseLp Comp" (Par 1208)																																																					
11 = "Reserved"	28 = "UsrDefined9" (Par 512)	45 = "Reserved"																																																					
12 = "Reserved"	29 = "UsrDefined10" (Par 513)	46 = "Reserved"																																																					
13 = "Reserved"	30 = "UsrDefined11" (Par 514)	47 = "Reserved"																																																					
14 = "Adaptive Ref" (Par 183)	31 = "UsrDefined12" (Par 515)	48 = "Reserved"																																																					
15 = "Reserved"	32 = "UsrDefined13" (Par 516)																																																						
16 = "Reserved"	33 = "UsrDefined14" (Par 517)																																																						

















File	Group	No.	Parameter Name & Description <small>See page 117 for symbol descriptions</small>	Values	Data Type	Related
APPLICATIONS	PID Control	786	<b>[PID Source]</b> Parameter number from which the PID source value will be read. Notes: Added option 47 "Encoder Spd" for firmware revision 4.001. Added option 48 "Resolver Spd" for firmware revision 5.002. Options:	Default: 0 "Not Used"	16-bit Int	
			0 = "Not Used"      17 = "Max Fld Pct" (Par 467)      34 = "UsrDefined15" (Par 518)			
			1 = "Cur Lim Pos" (Par 8)      18 = "Fld Ref Pct" (Par 500)      35 = "Load Comp" (Par 698)			
			2 = "Cur Lim Neg" (Par 9)      19 = "UsrDefined0" (Par 503)      36 = "Out Volt Lvl" (Par 921)			
			3 = "CurlimPosOut" (Par 10)      20 = "UsrDefined1" (Par 504)      37 = "Filt Trq Cur" (Par 928)			
			4 = "CurlimNegOut" (Par 11)      21 = "UsrDefined2" (Par 505)      38 = "Speed Ratio" (Par 1017)			
			5 = "TrqRedCurlim" (Par 13)      22 = "UsrDefined3" (Par 506)      39 = "Spd Draw Out" (Par 1018)			
			6 = "Torque Ref" (Par 39)      23 = "UsrDefined4" (Par 507)      40 = "Roll Diam" (Par 1154)			
			7 = "Trim Torque" (Par 40)      24 = "UsrDefined5" (Par 508)      41 = "Tension Red" (Par 1179)			
			8 = "TorqueReg In" (Par 41)      25 = "UsrDefined6" (Par 509)      42 = "Torq Cur Pct" (Par 1193)			
			9 = "Trim Ramp" (Par 42)      26 = "UsrDefined7" (Par 510)      43 = "Ten Ref Pct" (Par 1194)			
			10 = "Trim Speed" (Par 43)      27 = "UsrDefined8" (Par 511)      44 = "CloseLp Comp" (Par 1208)			
			11 = "Ramp In" (Par 110)      28 = "UsrDefined9" (Par 512)      45 = "Actual Comp" (Par 1213)			
			12 = "Ramp Out" (Par 113)      29 = "UsrDefined10" (Par 513)      46 = "W Reference" (Par 1217)			
			13 = "Speed Reg In" (Par 118)      30 = "UsrDefined11" (Par 514)      47 = "Encoder Spd" (Par 420)			
	14 = "Adaptive Ref" (Par 183)      31 = "UsrDefined12" (Par 515)      48 = "Resolver Spd" (Par 428)					
	15 = "Arm Cur Pct" (Par 199)      32 = "UsrDefined13" (Par 516)					
	16 = "SpdRegOutPct" (Par 236)      33 = "UsrDefined14" (Par 517)					
	787	<b>[PID Source Gain]</b> Gain of the input value to Par 786 [PID Source].	Default: 1.00 Min/Max: -/+100.00	Real	786	
	1046	<b>[PID Accel Time]</b> Ramp acceleration time after the block PID offset.	Default: 0.00 Min/Max: 0.00 / 900.00 Units: s	Real		
	1047	<b>[PID Decel Time]</b> Ramp deceleration time after the block PID offset.	Default: 0.00 Min/Max: 0.00 / 900.00 Units: s	Real		
	1254	<b>[PID Error Gain]</b> Gain percentage of Par 759 [PID Error].	Default: 1.005 Min/Max: 0.000 / 32.005 Units: %	Real	759	
	1258	<b>[Enable PI PD]</b> Indicates the combined status of Par 769 [Enable PI] and 770 [Enable PD]. If both Par 769 and Par 770 are enabled then Par 1258 [Enable PI PD] displays "Enabled". If either of Par 769 or Par 770 is disabled, Par 1258 [Enable PI PD] displays "Disabled".	Default: Read Only Min/Max: Disabled / Enabled	16-bit Int	769, 770	
Init Diam Calc	794	<b>[Diameter Calc]</b> Enables/Disables the diameter calculation function. If this parameter has been programmed via a digital input, it must be brought to a logical high level. • "0" = The diameter calculation is disabled. • "1" = The diameter calculation is enabled.	Default: 0 Min/Max: 0 / 1	16-bit Int		
	795	<b>[DncrPosSpd]</b> Desired motor speed when the dancer is positioned in its central working position.	Default: 0 Min/Max: -/+100	16-bit Int		
	796	<b>[Max Deviation]</b> A value, expressed in counts of D/A, that corresponds to the position of maximum shift admitted by the dancer. This value is considered the starting measurement of the dancer movement during the initial diameter calculation phase.	Default: 8000 Min/Max: 0 / 10000	16-bit Int		
	797	<b>[Gear Box Ratio]</b> Ratio reduction between the motor and the roll (<= 1).	Default: 1.000 Min/Max: 0.001 / 1.000	Real		









File	Group	No.	Parameter Name & Description <small>See page 117 for symbol descriptions</small>	Values	Data Type	Related
APPLICATIONS	Init Diam Calc	798 	<b>[Dancer Constant]</b> The measurement corresponding to the total bunching of the material in the dancer.	Default: 1 Min/Max: 1 / 10000 Units: mm	16-bit Int	
		799  	<b>[Minimum Diameter]</b> Minimum value of the roll diameter. Note: Also included in the Diameter Calc group in the Applications file.	Default: 100 Min/Max: 1 / 2000 Units: mm	16-bit Int	
		800 	<b>[Diameter Calc St]</b> Status of the initial diameter calculation. • "0" = The initial diameter calculation has not completed. • "1" = The initial diameter calculation has completed. Note: This parameter can be assigned to a digital output.	Default: Read Only Min/Max: 0 / 1	16-bit Int	
	Diameter Calc	1153  	<b>[Max Diameter]</b> Maximum roll diameter.	Default: 1.00 Min/Max: 0.00 / 32.00 Units: m	Real	
		1154 	<b>[Roll Diameter]</b> Displays the calculated roll diameter. Note: This parameter can be assigned to an analog output as a percentage of Par 1153 [Max Diameter].	Default: Read Only Min/Max: 0.00 / 32.00 Units: m	Real	
		1155 	<b>[Line Spd Thresh]</b> Line speed detecting threshold. When the value of Par 1286 [Ref Line Speed] is lower than the value of [Line Spd Thresh], the diameter calculation stops and the diameter is kept at a constant value. When the value of [Ref Line Speed] overcomes the threshold, the diameter calculation is enabled with an initial filter corresponding to the value in Par 1206 [Diam Init Filter] for the time set in Par 1207 [Diam Stdy Delay]. At the end of this time the filter will be set to the value of Par 1162 [Diameter Filter].	Default: 5.00 Min/Max: 0.00 / 150.00 Units: %	Real	1162, 1206, 1207, 1286
		1156 	<b>[Line Spd Gain]</b> Calibration value used to obtain Par 1160 [Line Speed Pct] = 100% at its maximum value. The value of this parameter depends on the value of Par 1284 [Ref Spd Source]: $[\text{Line Spd Gain}] = [32768 \times 16384 / (\text{maximum value of } [\text{Ref Spd Source}] \times 8)] - 1$	Default: 0 Min/Max: 0 / 32767	16-bit Int	1160, 1284
		1157 	<b>[Diameter Reset]</b> Diameter reset. When this parameter is set to "1", the diameter starting value is set to the value in Par 1168 [Diam Preset Sel].	Default: 0 Min/Max: 0 / 1	16-bit Int	1168
		1158 	<b>[Diam Threshold]</b> Diameter threshold as a percentage of Par 1153 [Max Diameter]. Par 1159 [Diameter Reached] is set to "1" when the value in this parameter is exceeded.	Default: 10.00 Min/Max: 0.00 / 150.00 Units: %	Real	1153, 1159
		1159 	<b>[Diameter Reached]</b> Indication that the diameter threshold set in Par 1158 [Diam Threshold] has been exceeded. • "0" = The diameter threshold has not been exceeded. • "1" = The diameter threshold has been exceeded.	Default: Read Only Min/Max: 0 / 1	16-bit Int	1158
		1160 	<b>[Line Speed Pct]</b> Line speed.	Default: Read Only Min/Max: 0.00 / 150.00 Units: %	Real	
		1161 	<b>[Diam Calc Dis]</b> Enables/Disables the diameter calculation (see also Par 1155 [Line Spd Thresh]). The last calculated diameter value is saved if this parameter is changed to 0 "Off" while the diameter is being calculated.	Default: 1 = "On" Options: 0 = "Off" 1 = "On"	16-bit Int	1155

File	Group	No.	Parameter Name & Description <small>See page 117 for symbol descriptions</small>	Values	Data Type	Related
APPLICATIONS	Diameter Calc	1162 <b>A</b>	<b>[Diameter Filter]</b> Diameter calculation filter.	Default: 100 Min/Max: 0 / 5000 Units: ms	16-bit Int	
		1163 <b>A</b>	<b>[Base Omega]</b> Winder speed at the maximum line speed and minimum diameter of the winder/unwinder (motor shaft side).	Default: 1500 Min/Max: 0 / 8191 Units: rpm	16-bit Int	
		1164 <b>A</b>	<b>[Diam Preset 0]</b> First preset starting diameter. The value of this parameter must be set between the value of Pars 799 [Minimum Diameter] and 1153 [Max Diameter].	Default: 1.00 Min/Max: 0.00 / 32.00 Units: m	Real	799, 1153
		1165 <b>A</b>	<b>[Diam Preset 1]</b> Second preset starting diameter. The value of this parameter must be set between the value of Pars 799 [Minimum Diameter] and 1153 [Max Diameter].	Default: 1.00 Min/Max: 0.00 / 32.00 Units: m	Real	799, 1153
		1166 <b>A</b>	<b>[Diam Preset 2]</b> Third preset starting diameter. The value of this parameter must be set between the value of Pars 799 [Minimum Diameter] and 1153 [Max Diameter].	Default: 1.00 Min/Max: 0.00 / 32.00 Units: m	Real	799, 1153
		1167 <b>A</b>	<b>[Diam Preset 3]</b> Fourth preset starting diameter. The value of this parameter must be set between the value of Pars 799 [Minimum Diameter] and 1153 [Max Diameter]. This parameter can be assigned to an analog input. If an analog input is used, +10V corresponds to the value of [Max Diameter] and the voltage corresponding to the minimum diameter = 10 x ([Minimum Diameter] / [Max Diameter]).	Default: 1.00 Min/Max: 0.00 / 32.00 Units: m	Real	799, 1153
		1168 <b>A</b>	<b>[Diam Preset Sel]</b> Selects the starting diameter for the Diameter Calculation function. <ul style="list-style-type: none"> <li>• 0 = Par 1164 [Diam Preset 0]</li> <li>• 1 = Par 1165 [Diam Preset 1]</li> <li>• 2 = Par 1166 [Diam Preset 2]</li> <li>• 3 = Par 1167 [Diam Preset 3]</li> </ul> This parameter can also be set via two digital inputs programmed as 57 "Diam Preset0" and 58 "Diam Preset1"; the selection in this case is carried out with binary logic.	Default: 0 Min/Max: 0 / 3	16-bit Int	1164, 1165, 1166, 1167
		1187 <b>A</b>	<b>[Winder Type]</b> Winder/unwinder selection. If the selection is carried out via a digital input: 0V = "Winder", +24V = "Unwinder".	Default: 0 = "Winder" Options: 0 = "Winder", 1 = "Unwinder"	16-bit Int	

File	Group	No.	Parameter Name & Description <small>See page 117 for symbol descriptions</small>	Values	Data Type	Related
APPLICATIONS	Diameter Calc	1204	<b>[Line Spd Source]</b> Parameter number from which the line speed source for the winder function value will be read. Notes: Added options 0 . . . 47 for firmware revision 4.001. Added option 48 "Resolver Spd" for firmware revision 5.002. Options:	Default: 0 = "Not Used"	16-bit Int	
		0 = "Not Used"	17 = "Max Fld Pct" (Par 467)	34 = "UsrDefined15" (Par 518)		
		1 = "Cur Lim Pos" (Par 8)	18 = "Fld Ref Pct" (Par 500)	35 = "Load Comp" (Par 698)		
		2 = "Cur Lim Neg" (Par 9)	19 = "UsrDefined0" (Par 503)	36 = "Out Volt Lvl" (Par 921)		
		3 = "CurLimPosOut" (Par 10)	20 = "UsrDefined1" (Par 504)	37 = "Filt Trq Cur" (Par 928)		
		4 = "CurLimNegOut" (Par 11)	21 = "UsrDefined2" (Par 505)	38 = "Speed Ratio" (Par 1017)		
		5 = "TrqRedCurLim" (Par 13)	22 = "UsrDefined3" (Par 506)	39 = "Spd Draw Out" (Par 1018)		
		6 = "Torque Ref" (Par 39)	23 = "UsrDefined4" (Par 507)	40 = "Roll Diam" (Par 1154)		
		7 = "Trim Torque" (Par 40)	24 = "UsrDefined5" (Par 508)	41 = "Tension Red" (Par 1179)		
		8 = "TorqueReg In" (Par 41)	25 = "UsrDefined6" (Par 509)	42 = "Torq Cur Pct" (Par 1193)		
		9 = "Trim Ramp" (Par 42)	26 = "UsrDefined7" (Par 510)	43 = "Ten Ref Pct" (Par 1194)		
		10 = "Trim Speed" (Par 43)	27 = "UsrDefined8" (Par 511)	44 = "CloseLp Comp" (Par 1208)		
		11 = "Ramp In" (Par 110)	28 = "UsrDefined9" (Par 512)	45 = "Actual Comp" (Par 1213)		
		12 = "Ramp Out" (Par 113)	29 = "UsrDefined10" (Par 513)	46 = "W Reference" (Par 1217)		
		13 = "Speed Reg In" (Par 118)	30 = "UsrDefined11" (Par 514)	47 = "Encoder Spd" (Par 420)		
		14 = "Adaptive Ref" (Par 183)	31 = "UsrDefined12" (Par 515)	48 = "Resolver Spd" (Par 428)		
15 = "Arm Cur Pct" (Par 199)	32 = "UsrDefined13" (Par 516)					
16 = "SpdRegOutPct" (Par 236)	33 = "UsrDefined14" (Par 517)					
		1205	<b>[Diam Inc Dec En]</b> This parameter It is used to improve system stability for winder/unwinder applications. If this parameter is enabled and if applied to a winder, the calculated diameter can never decrease; if applied to an unwinder, the calculated diameter can never increase.	Default: 1 = "Enabled" Options: 0 = "Disabled" 1 = "Enabled"	16-bit Int	
		1206	<b>[Diam Init Filter]</b> Initial filter on the diameter calculation.	Default: 100 Min/Max: 0 / 5000 Units: ms	16-bit Int	
		1207	<b>[Diam Stdy Delay]</b> The amount of time during which the value of Par 1206 [Diam Init Filter] is kept active after the value defined in Par 1155 [Line Spd Thresh] has been overcome.	Default: 0 Min/Max: 0 / 60000 Units: ms	16-bit Int	1155, 1206
APPLICATIONS	Winder Functions	1171	<b>[Variable J Comp]</b> Torque compensation due to the wound material as a percentage of the drive rated current.	Default: 0.00 Min/Max: 0.00 / 199.99 Units: %	Real	
		1172	<b>[Constant J Comp]</b> Compensation of the fixed section (motor, reducer, pin) as a percentage of the drive rated current.	Default: 1.00 Min/Max: - / +100.00 Units: %	Real	
		1173	<b>[Materl Width Pct]</b> Width of the wound material as a percentage of the maximum width.	Default: 100.00 Min/Max: 0.00 / 100.00 Units: %	Real	
		1174	<b>[Static Friction]</b> Compensation for static friction as a percentage of the drive rated current.	Default: 0.00 Min/Max: 0.00 / 199.99 Units: %	Real	
		1175	<b>[Dynamic Friction]</b> Compensation for dynamic friction as a percentage of the drive rated current.	Default: 0.00 Min/Max: 0.00 / 199.99 Units: %	Real	


File	Group	No.	Parameter Name & Description <small>See page 117 for symbol descriptions</small>	Values	Data Type	Related
APPLICATIONS	Winder Functions	1176 	<b>[Taper Enable]</b> Enables/Disables the Taper function.	Default: 0 = "Disabled" Options: 0 = "Disabled" 1 = "Enabled"	16-bit Int	
		1177 	<b>[Initial Diameter]</b> Diameter that starts the taper tension reduction.	Default: 0.10 Min/Max: 0.00 / 32.00 Units: m	Real	
		1178 	<b>[Final Diameter]</b> Diameter that ends the taper tension reduction.	Default: 1.00 Min/Max: 0.00 / 32.00 Units: m	Real	
		1179 	<b>[Tension Reduct]</b> Taper tension reduction as a percentage of Par 1180 [Tension Ref].	Default: 0.00 Min/Max: 0.00 / 199.99 Units: %	Real	1180
		1180 	<b>[Tension Ref]</b> Tension reference. Note: This parameter can be assigned to an analog input or output.	Default: 0.00 Min/Max: 0.00 / 199.99 Units: %	Real	
		1181 	<b>[Tension Scale]</b> Scale factor of the torque current. This parameter is used when the value of the maximum winding torque must be limited or when a closed loop control is used to adjust the torque current value to the real tension on the material measured by the load cell.	Default: 100 Min/Max: 0 / 200 Units: %	16-bit Int	
		1182 	<b>[Time AccDec Min]</b> The amount of time corresponding to the lower acceleration, deceleration and fast deceleration time.	Default: 9.00 Min/Max: 0.15 / 300 Units: s	Real	
		1183 	<b>[Int Acc Calc En]</b> Enables/Disables the calculation for coil acceleration. • "Enabled" = This function carries out the calculation of the angular acceleration inside the drive. In this case it is necessary to set just the value of Par 1182 [Time AccDec Min]. • "Disabled" = It is necessary to set Pars 1184 [Line Accel Pct], 1185 [Line Decel Pct], 1186 [Line FastStp Pct] and 1182 [Time AccDec Min] and to supply the corresponding status indication to the digital inputs.	Default: 1 = "Enabled" Options: 0 = "Disabled" 1 = "Enabled"	16-bit Int	1182, 1184, 1185, 1186
		1184 	<b>[Line Accel Pct]</b> Acceleration time as a percentage Par 1182 of [Time AccDec Min].	Default: 100.00 Min/Max: 0.00 / 100.00 Units: %	Real	1182
		1185 	<b>[Line Decel Pct]</b> Deceleration time as a percentage of Par 1182 [Time AccDec Min].	Default: 100.00 Min/Max: 0.00 / 100.00 Units: %	Real	1182
		1186 	<b>[Line FastStp Pct]</b> Fast deceleration time as a percentage of Par 1182 [Time AccDec Min].	Default: 100.00 Min/Max: 0.00 / 100.00 Units: %	Real	1182
		1188 	<b>[Accel Status]</b> Indicates the drive acceleration status. • "0" = Off - Drive not accelerating • "1" = "On" - Drive accelerating Note: This parameter can be assigned to a digital output.	Default: Read Only Min/Max: 0 / 1	16-bit Int	
		1189 	<b>[Decel Status]</b> Indicates the drive deceleration status. • "0" = "Off" - Drive not decelerating • "1" = "On" - Drive decelerating Note: This parameter can be assigned to a digital output.	Default: Read Only Min/Max: 0 / 1	16-bit Int	
		1190 	<b>[Fast Stop Status]</b> Indicates the drive fast stop status. • "0" = "Off" - Drive is not fast stopping • "1" = "On" - Drive is fast stopping	Default: Read Only Min/Max: 0 / 1	16-bit Int	

File	Group	No.	Parameter Name & Description <small>See page 117 for symbol descriptions</small>	Values	Data Type	Related
APPLICATIONS	Winder Functions	1191 <b>A</b>	<b>[InertiaCompCnst]</b> Displays the active compensation of the fixed section as a percentage of the drive rated current.	Default: Read Only Min/Max: 0.00 / 200.00 Units: %	Real	
		1192 <b>A</b>	<b>[InertiaCompVar]</b> Displays the active compensation of the variable section as a percentage of the drive rated current.	Default: Read Only Min/Max: 0.00 / 200.00 Units: %	Real	
		1193 <b>A</b>	<b>[Torq Current Pct]</b> Displays the amount of torque current required. Note: This parameter can be assigned to an analog output.	Default: Read Only Min/Max: 0.00 / 200.00 Units: %	Real	
		1194 <b>A</b>	<b>[Act Ten Ref Pct]</b> Displays the percentage of tension reference less the Taper percentage set via Par 1179 [Tension Reduct]. If the Taper function is not enabled, it corresponds to the value displayed in Par 1180 [Tension Ref].	Default: Read Only Min/Max: 0.00 / 199.99 Units: %	Real	1179, 1180
		1195 <b>A</b>	<b>[Speed Match]</b> Coil "launching" phase command for automatic switching. Note: This parameter can be assigned to a digital input or output.	Default: 0 = "Off" Options: 0 = "Off" 1 = "On"	16-bit Int	
		1196 <b>A</b>	<b>[Spd Match Acc]</b> Motor acceleration time during the launching phase.	Default: 83.88 Min/Max: 0.30 / 300.00 Units: s	Real	
		1197 <b>A</b>	<b>[Spd Match Dec]</b> Motor deceleration time. If the motor decelerates during the launching phase a stop command is issued.	Default: 83.88 Min/Max: 0.30 / 300.00 Units: s	Real	
		1198 <b>A</b>	<b>[Ofs Accel Time]</b> Ramp time for the initial phase when the machine is stopped. It refers to Par 45 [Max Ref Speed].	Default: 83.88 Min/Max: 0.30 / 300.00 Units: s	Real	
		1199 <b>A</b>	<b>[W Offset]</b> Speed reference offset for the initial phase of the winder/unwinder when the line is stopped.	Default: 0 Min/Max: 0 / 1000 Units: rpm	16-bit Int	
		1200 <b>A</b>	<b>[Spd Match Gain]</b> Speed reference gain during the launching phase. 100% corresponds to a peripheral speed equal to the line speed.	Default: 100 Min/Max: 0 / 150 Units: %	16-bit Int	
		1201 <b>A</b>	<b>[Winder Side]</b> Selection of the winding/unwinding side. • "0" = Up • "1" = Down Note: This parameter can be assigned to a digital input.	Default: 0 Min/Max: 0 / 1	16-bit Int	
		1202 <b>A</b>	<b>[W Gain]</b> Sets the speed reference gain used to saturate the speed loop. This parameter is a percentage of the increasing/decreasing value of the angular speed reference.	Default: 0 Min/Max: 0 / 100 Units: %	16-bit Int	
		1203 <b>A</b>	<b>[Spd Match Compl]</b> Indicates a completed launching ramp. If this parameter is assigned to a programmed digital output, it can be used to indicate that the coil can be changed. • "1" = Launching ramp completed • "0" = Launching ramp not completed	Default: Read Only Min/Max: 0 / 32767	16-bit Int	
		1208 <b>A</b>	<b>[Close Loop Comp]</b> Active compensation status (output of the PID regulator).	Default: Read Only Min/Max: - / +32767	16-bit Int	
		1209 <b>A</b>	<b>[Torque Winder En]</b> Enables/disables the center winder function.	Default: 0 = "Disabled" Options: 0 = "Disabled" 1 = "Enabled"	16-bit Int	

File	Group	No.	Parameter Name & Description <small>See page 117 for symbol descriptions</small>	Values	Data Type	Related																																																				
APPLICATIONS	Winder Functions	1210	 <b>[W Target]</b> Number of the parameter to which the winder speed reference is written. Notes: Added options 0...47 for firmware revision 4.001. Added option 48 "Reserved" for firmware revision 5.002. Options:	Default: 0 Min/Max: 0 / 65535	16-bit Int																																																					
		<table border="1"> <tr> <td>0 = "Not Used"</td> <td>17 = "Max Fld Pct" (Par 467)</td> <td>34 = "UsrDefined15" (Par 518)</td> </tr> <tr> <td>1 = "Cur Lim Pos" (Par 8)</td> <td>18 = "Reserved"</td> <td>35 = "Load Comp" (Par 698)</td> </tr> <tr> <td>2 = "Cur Lim Neg" (Par 9)</td> <td>19 = "UsrDefined0" (Par 503)</td> <td>36 = "Out Volt Lvl" (Par 921)</td> </tr> <tr> <td>3 = "Reserved"</td> <td>20 = "UsrDefined1" (Par 504)</td> <td>37 = "Reserved"</td> </tr> <tr> <td>4 = "Reserved"</td> <td>21 = "UsrDefined2" (Par 505)</td> <td>38 = "Speed Ratio" (Par 1017)</td> </tr> <tr> <td>5 = "TrqRedCurlim" (Par 13)</td> <td>22 = "UsrDefined3" (Par 506)</td> <td>39 = "Reserved"</td> </tr> <tr> <td>6 = "Torque Ref" (Par 39)</td> <td>23 = "UsrDefined4" (Par 507)</td> <td>40 = "Reserved"</td> </tr> <tr> <td>7 = "Trim Torque" (Par 40)</td> <td>24 = "UsrDefined5" (Par 508)</td> <td>41 = "Tension Red" (Par 1179)</td> </tr> <tr> <td>8 = "Reserved"</td> <td>25 = "UsrDefined6" (Par 509)</td> <td>42 = "Reserved"</td> </tr> <tr> <td>9 = "Trim Ramp" (Par 42)</td> <td>26 = "UsrDefined7" (Par 510)</td> <td>43 = "Reserved"</td> </tr> <tr> <td>10 = "Trim Speed" (Par 43)</td> <td>27 = "UsrDefined8" (Par 511)</td> <td>44 = "CloseLp Comp" (Par 1208)</td> </tr> <tr> <td>11 = "Reserved"</td> <td>28 = "UsrDefined9" (Par 512)</td> <td>45 = "Reserved"</td> </tr> <tr> <td>12 = "Reserved"</td> <td>29 = "UsrDefined10" (Par 513)</td> <td>46 = "Reserved"</td> </tr> <tr> <td>13 = "Reserved"</td> <td>30 = "UsrDefined11" (Par 514)</td> <td>47 = "Reserved"</td> </tr> <tr> <td>14 = "Adaptive Ref" (Par 183)</td> <td>31 = "UsrDefined12" (Par 515)</td> <td>48 = "Reserved"</td> </tr> <tr> <td>15 = "Reserved"</td> <td>32 = "UsrDefined13" (Par 516)</td> <td></td> </tr> <tr> <td>16 = "Reserved"</td> <td>33 = "UsrDefined14" (Par 517)</td> <td></td> </tr> </table>			0 = "Not Used"	17 = "Max Fld Pct" (Par 467)	34 = "UsrDefined15" (Par 518)	1 = "Cur Lim Pos" (Par 8)	18 = "Reserved"	35 = "Load Comp" (Par 698)	2 = "Cur Lim Neg" (Par 9)	19 = "UsrDefined0" (Par 503)	36 = "Out Volt Lvl" (Par 921)	3 = "Reserved"	20 = "UsrDefined1" (Par 504)	37 = "Reserved"	4 = "Reserved"	21 = "UsrDefined2" (Par 505)	38 = "Speed Ratio" (Par 1017)	5 = "TrqRedCurlim" (Par 13)	22 = "UsrDefined3" (Par 506)	39 = "Reserved"	6 = "Torque Ref" (Par 39)	23 = "UsrDefined4" (Par 507)	40 = "Reserved"	7 = "Trim Torque" (Par 40)	24 = "UsrDefined5" (Par 508)	41 = "Tension Red" (Par 1179)	8 = "Reserved"	25 = "UsrDefined6" (Par 509)	42 = "Reserved"	9 = "Trim Ramp" (Par 42)	26 = "UsrDefined7" (Par 510)	43 = "Reserved"	10 = "Trim Speed" (Par 43)	27 = "UsrDefined8" (Par 511)	44 = "CloseLp Comp" (Par 1208)	11 = "Reserved"	28 = "UsrDefined9" (Par 512)	45 = "Reserved"	12 = "Reserved"	29 = "UsrDefined10" (Par 513)	46 = "Reserved"	13 = "Reserved"	30 = "UsrDefined11" (Par 514)	47 = "Reserved"	14 = "Adaptive Ref" (Par 183)	31 = "UsrDefined12" (Par 515)	48 = "Reserved"	15 = "Reserved"	32 = "UsrDefined13" (Par 516)		16 = "Reserved"	33 = "UsrDefined14" (Par 517)				
		0 = "Not Used"	17 = "Max Fld Pct" (Par 467)	34 = "UsrDefined15" (Par 518)																																																						
		1 = "Cur Lim Pos" (Par 8)	18 = "Reserved"	35 = "Load Comp" (Par 698)																																																						
		2 = "Cur Lim Neg" (Par 9)	19 = "UsrDefined0" (Par 503)	36 = "Out Volt Lvl" (Par 921)																																																						
		3 = "Reserved"	20 = "UsrDefined1" (Par 504)	37 = "Reserved"																																																						
		4 = "Reserved"	21 = "UsrDefined2" (Par 505)	38 = "Speed Ratio" (Par 1017)																																																						
		5 = "TrqRedCurlim" (Par 13)	22 = "UsrDefined3" (Par 506)	39 = "Reserved"																																																						
		6 = "Torque Ref" (Par 39)	23 = "UsrDefined4" (Par 507)	40 = "Reserved"																																																						
		7 = "Trim Torque" (Par 40)	24 = "UsrDefined5" (Par 508)	41 = "Tension Red" (Par 1179)																																																						
8 = "Reserved"	25 = "UsrDefined6" (Par 509)	42 = "Reserved"																																																								
9 = "Trim Ramp" (Par 42)	26 = "UsrDefined7" (Par 510)	43 = "Reserved"																																																								
10 = "Trim Speed" (Par 43)	27 = "UsrDefined8" (Par 511)	44 = "CloseLp Comp" (Par 1208)																																																								
11 = "Reserved"	28 = "UsrDefined9" (Par 512)	45 = "Reserved"																																																								
12 = "Reserved"	29 = "UsrDefined10" (Par 513)	46 = "Reserved"																																																								
13 = "Reserved"	30 = "UsrDefined11" (Par 514)	47 = "Reserved"																																																								
14 = "Adaptive Ref" (Par 183)	31 = "UsrDefined12" (Par 515)	48 = "Reserved"																																																								
15 = "Reserved"	32 = "UsrDefined13" (Par 516)																																																									
16 = "Reserved"	33 = "UsrDefined14" (Par 517)																																																									
		1212	<b>[Acc Dec Filter]</b> Internal acceleration/deceleration calculation filter for the Torque Winder line speed reference.	Default: 30 Min/Max: 0 / 5000 Units: ms	16-bit Int																																																					
		1213	 <b>[Actual Comp]</b> Active compensation status (sums up the static, dynamic and inertial frictions) as a percentage of the drive rated current. Note: This parameter can be assigned to an analog output.	Default: Read Only Min/Max: -/+200 Units: %	16-bit Int																																																					
		1214	 <b>[Closed Loop En]</b> Enables/Disables closed loop tension control (used with a load cell).	Default: 0 = "Disabled" Options: 0 = "Disabled", 1 = "Enabled"	16-bit Int																																																					
		1215	 <b>[Speed Demand En]</b> Enables/Disables the speed reference calculation for the Torque Winder application.	Default: 0 = "Disabled" Options: 0 = "Disabled", 1 = "Enabled"	16-bit Int																																																					
		1216	 <b>[Spd Match Torque]</b> Sets the torque current during the launching and change phase.	Default: 100 Min/Max: 0 / 200 Units: %	16-bit Int																																																					
		1217	 <b>[W Reference]</b> Angular speed reference. Note: This parameter can be assigned to an analog output; 10V = 100% of Par 45 [Max Ref Speed].	Default: Read Only Min/Max: -/+8192 Units: rpm	16-bit Int	1160																																																				
		1255	 <b>[Jog TW Speed]</b> Torque Winder jog reference. The parameter is entered as a percentage of Par 1160 [Line Speed Pct].	Default: 0 Min/Max: 0 / 100 Units: %	16-bit Int	1160																																																				
		1256	 <b>[Jog TW Enable]</b> Enables/Disables the Torque Winder jog function. Note: This parameter can be assigned to a digital input.	Default: 0 = "Disabled" Options: 0 = "Disabled", 1 = "Enabled"	16-bit Int																																																					

File	Group	No.	Parameter Name & Description <small>See page 117 for symbol descriptions</small>	Values	Data Type	Related	
APPLICATIONS	Winder Functions	1284	<b>[Ref Spd Source]</b> Parameter number from which the line speed reference (used for inertia compensation and line speed reference) will be read. Notes: Added options 0 . . . 47 for firmware revision 4.001. Added option 48 "Resolver Spd" for firmware revision 5.002. Options:	Default:      0 =      "Not Used"	16-bit Int		
		0 =	"Not Used"	17 =	"Max Fld Pct" (Par 467)	34 =	"UsrDefined15" (Par 518)
		1 =	"Cur Lim Pos" (Par 8)	18 =	"Fld Ref Pct" (Par 500)	35 =	"Load Comp" (Par 698)
		2 =	"Cur Lim Neg" (Par 9)	19 =	"UsrDefined0" (Par 503)	36 =	"Out Volt Lvl" (Par 921)
		3 =	"CurLimPosOut" (Par 10)	20 =	"UsrDefined1" (Par 504)	37 =	"Filt Trq Cur" (Par 928)
		4 =	"CurLimNegOut" (Par 11)	21 =	"UsrDefined2" (Par 505)	38 =	"Speed Ratio" (Par 1017)
		5 =	"TrqRedCurLim" (Par 13)	22 =	"UsrDefined3" (Par 506)	39 =	"Spd Draw Out" (Par 1018)
		6 =	"Torque Ref" (Par 39)	23 =	"UsrDefined4" (Par 507)	40 =	"Roll Diam" (Par 1154)
		7 =	"Trim Torque" (Par 40)	24 =	"UsrDefined5" (Par 508)	41 =	"Tension Red" (Par 1179)
		8 =	"TorqueReg In" (Par 41)	25 =	"UsrDefined6" (Par 509)	42 =	"Torq Cur Pct" (Par 1193)
		9 =	"Trim Ramp" (Par 42)	26 =	"UsrDefined7" (Par 510)	43 =	"Ten Ref Pct" (Par 1194)
		10 =	"Trim Speed" (Par 43)	27 =	"UsrDefined8" (Par 511)	44 =	"CloseLp Comp" (Par 1208)
		11 =	"Ramp In" (Par 110)	28 =	"UsrDefined9" (Par 512)	45 =	"Actual Comp" (Par 1213)
		12 =	"Ramp Out" (Par 113)	29 =	"UsrDefined10" (Par 513)	46 =	"W Reference" (Par 1217)
		13 =	"Speed Reg In" (Par 118)	30 =	"UsrDefined11" (Par 514)	47 =	"Encoder Spd" (Par 420)
		14 =	"Adaptive Ref" (Par 183)	31 =	"UsrDefined12" (Par 515)	48 =	"Resolver Spd" (Par 428)
		15 =	"Arm Cur Pct" (Par 199)	32 =	"UsrDefined13" (Par 516)		
16 =	"SpdRegOutPct" (Par 236)	33 =	"UsrDefined14" (Par 517)				
		1285	<b>[Ref Speed Gain]</b> Gain value for the line speed reference. The value of this parameter depends on the value of Par 1284 [Ref Spd Source]. The value of [Ref Speed Gain] is used to obtain a line speed reference = 100% at its maximum value.	Default:      0 Min/Max:     0 / 32767	16-bit Int	1284	
		1286	<b>[Ref Line Speed]</b> Line speed percentage.	Default:      Read Only Min/Max:     0.00 / 150.00 Units:        %	Real		
		1287	<b>[Static F Zero]</b> Enables/Disables friction compensation. <ul style="list-style-type: none"> <li>• "Enabled" = The fiction compensation value is added to all speed values.</li> <li>• "Disabled" = The static friction compensation value is added to Par 1286 [Ref Line Speed] = 1.5%.</li> </ul>	Default:      0 = "Disabled" Options:      0 = "Disabled" 1 = "Enabled"	16-bit Int	1286	






File	Group	No.	Parameter Name & Description <small>See page 117 for symbol descriptions</small>	Values	Data Type	Related																																																		
APPLICATIONS	Torque Prove	1100	<p><b>[Torq Prove Cfg]</b>                      Enables/Disables the torque/brake proving feature. When this feature is enabled, brake control comes from a digital output relay set to "Brake Set."</p> <ul style="list-style-type: none"> <li>Bit 0 "TP Enable" - When set to "1," the torque/brake proving features are enabled (regenerative drives only, non-regen. drives results in a type 2 alarm).</li> <li>Bit 1 "Encoderless" - When set to "1," enables encoderless operation. Bit 0 "TP Enable" must also be enabled and Par 414 [Fdbk Device Type] must be set to 2 "DC Tach" or a type 2 alarm is generated.</li> </ul>																																																					
		<div style="border: 1px solid black; padding: 5px; margin-bottom: 10px;">  <p><b>ATTENTION:</b> Encoderless TorqProve must be limited to lifting applications where personal safety is not a concern. Encoders offer additional protection and must be used where personal safety is a concern. Encoderless TorqProve cannot hold a load at zero speed without a mechanical brake and does not offer additional protection if the brake slips/fails. Loss of control in suspended load applications can cause personal injury and/or equipment damage. See Lifting/Torque Proving on page 306 for more information.</p> </div> <ul style="list-style-type: none"> <li>Bit 2 "Micro Psn" - When set to "0," micro positioning only activates in float zone. When set to "1" micro positioning activates whenever a digital input configured for "Micro Positioning" or Par 1101 [Torq Prove Setup], bit 1 "Float Micro" is asserted.</li> <li>Bit 3 "Preload" - When set to "0," the drive uses the last holding torque reference for preload. When set to "1," the drive uses "TorqRefA" if the commanded direction is forward and "TorqRef B" if the commanded direction is reverse.</li> <li>Bit 4 "FW LoadLimit" - When set to "1," enables a load calculation at base speed. The drive will then limit the maximum speed above base speed. Torque samples are taken every 2.5 seconds to hold the load at base speed and calculates (based on motor characteristics and measured torque) the maximum speed that holds the load. This feature limits the commanded speed if it is greater than what the motor/drive can hold. The limit remains in effect until the speed drops below base speed and a new test is activated.</li> <li>Bit 5 "BrkSlipEnds" - When set to "1," disables the partial brake slip routine when bit 1 "Encoderless" is set to 1.</li> <li>Bit 6 "BrkSlipStart" - When set to "1," automatically starts the drive if brake slippage is detected.</li> <li>Bit 7 "Test Brake" - When set to "1," the brake is tested at a start command. The torque value set in Par 1114 [Brake Test Torq] is applied against the brake while movement is monitored.</li> <li>Bit 8 "Lift Stop Bk" - When set to "1," the brake is set immediately upon receiving a "Lift Stop" input, rather than setting the brake after the ramp completes.</li> <li>Bit 9 "BkSlp SpdLmt" - When set to "1," the load is lowered at a fixed speed (Preset Speed 1) when a brake slip condition is detected.</li> </ul> <p>Note: This parameter was added for firmware revision 6.001.</p> <table border="1" style="width: 100%; border-collapse: collapse; text-align: center;"> <thead> <tr> <th>Options</th> <th>Reserved</th> <th>Reserved</th> <th>Reserved</th> <th>Reserved</th> <th>Reserved</th> <th>Reserved</th> <th>BkSlp SpdLmt</th> <th>Lift Stop Bk</th> <th>Test Brake</th> <th>BrkSlipStart</th> <th>BrkSlipEnds</th> <th>FW LoadLimit</th> <th>Preload</th> <th>Micro Psn</th> <th>Encoderless</th> <th>TP Enable</th> </tr> </thead> <tbody> <tr> <td>Default</td> <td>x</td> <td>x</td> <td>x</td> <td>x</td> <td>x</td> <td>x</td> <td>0</td> <td>0</td> <td>0</td> <td>0</td> <td>0</td> <td>0</td> <td>0</td> <td>0</td> <td>0</td> <td>0</td> </tr> <tr> <td>Bit</td> <td>15</td> <td>14</td> <td>13</td> <td>12</td> <td>11</td> <td>10</td> <td>9</td> <td>8</td> <td>7</td> <td>6</td> <td>5</td> <td>4</td> <td>3</td> <td>2</td> <td>1</td> <td>0</td> </tr> </tbody> </table>	Options	Reserved	Reserved	Reserved	Reserved	Reserved	Reserved	BkSlp SpdLmt	Lift Stop Bk	Test Brake	BrkSlipStart	BrkSlipEnds	FW LoadLimit	Preload	Micro Psn	Encoderless	TP Enable	Default	x	x	x	x	x	x	0	0	0	0	0	0	0	0	0	0	Bit	15	14	13	12	11	10	9	8	7	6	5	4	3	2	1	0			
Options	Reserved	Reserved	Reserved	Reserved	Reserved	Reserved	BkSlp SpdLmt	Lift Stop Bk	Test Brake	BrkSlipStart	BrkSlipEnds	FW LoadLimit	Preload	Micro Psn	Encoderless	TP Enable																																								
Default	x	x	x	x	x	x	0	0	0	0	0	0	0	0	0	0																																								
Bit	15	14	13	12	11	10	9	8	7	6	5	4	3	2	1	0																																								
		1101	<p><b>[Torq Prove Setup]</b>                      Lets you control specific torque proving functions through a communications device (rather than digital inputs).</p> <ul style="list-style-type: none"> <li>Bit 0 "Lift Stop" - When set to "1," initiates a current limit stop.</li> <li>Bit 1 "Float Micro" - When set to "1," activates the micro position function when the drive is running and Float when the drive is stopping.</li> <li>Bit 2 "Decel Fwd" - When set to "1," initiates a deceleration forward travel limit condition.</li> <li>Bit 3 "End Stop Fwd" - When set to "1," initiates an end forward travel limit condition.</li> <li>Bit 4 "Decel Rev" - When set to "1," initiates a deceleration reverse travel limit condition.</li> <li>Bit 5 "End Stop Rev" - When set to "1," initiates an end reverse travel limit condition.</li> <li>Bit 6 "PHdwrOvrTrvl" - When set to "1," initiates a positive hardware over travel limit: coast to stop fault.</li> <li>Bit 7 "NHdwrOvrTrvl" - When set to "1," initiates a negative hardware over travel limit: coast to stop fault.</li> </ul> <p>Note: This parameter was added for firmware revision 6.001.</p> <table border="1" style="width: 100%; border-collapse: collapse; text-align: center;"> <thead> <tr> <th>Options</th> <th>Reserved</th> <th>Reserved</th> <th>Reserved</th> <th>Reserved</th> <th>Reserved</th> <th>Reserved</th> <th>Reserved</th> <th>Reserved</th> <th>NHdwrOvrTrvl</th> <th>PHdwrOvrTrvl</th> <th>End Stop Rev</th> <th>Decel Rev</th> <th>End Stop Fwd</th> <th>Decel Fwd</th> <th>Float Micro</th> <th>Lift Stop</th> </tr> </thead> <tbody> <tr> <td>Default</td> <td>x</td> <td>x</td> <td>x</td> <td>x</td> <td>x</td> <td>x</td> <td>x</td> <td>x</td> <td>0</td> <td>0</td> <td>0</td> <td>0</td> <td>0</td> <td>0</td> <td>0</td> <td>0</td> </tr> <tr> <td>Bit</td> <td>15</td> <td>14</td> <td>13</td> <td>12</td> <td>11</td> <td>10</td> <td>9</td> <td>8</td> <td>7</td> <td>6</td> <td>5</td> <td>4</td> <td>3</td> <td>2</td> <td>1</td> <td>0</td> </tr> </tbody> </table>	Options	Reserved	Reserved	Reserved	Reserved	Reserved	Reserved	Reserved	Reserved	NHdwrOvrTrvl	PHdwrOvrTrvl	End Stop Rev	Decel Rev	End Stop Fwd	Decel Fwd	Float Micro	Lift Stop	Default	x	x	x	x	x	x	x	x	0	0	0	0	0	0	0	0	Bit	15	14	13	12	11	10	9	8	7	6	5	4	3	2	1	0		
Options	Reserved	Reserved	Reserved	Reserved	Reserved	Reserved	Reserved	Reserved	NHdwrOvrTrvl	PHdwrOvrTrvl	End Stop Rev	Decel Rev	End Stop Fwd	Decel Fwd	Float Micro	Lift Stop																																								
Default	x	x	x	x	x	x	x	x	0	0	0	0	0	0	0	0																																								
Bit	15	14	13	12	11	10	9	8	7	6	5	4	3	2	1	0																																								

File	Group	No.	Parameter Name & Description <small>See page 117 for symbol descriptions</small>	Values	Data Type	Related																																																			
APPLICATIONS	Torque Prove	1103	<b>[Torq Prove Sts]</b> Status of the Torque Proving functions. Bit 0 "EndLimitActv" - When set to "1," indicates that an end (forward or reverse) travel limit condition active. Bit 1 "DecelLmtActv" - When set to "1," indicates that a deceleration (forward or reverse) travel limit condition active. Bit 2 "Micro Psn" - When set to "1," indicates that a micro position condition active. Bit 3 "BrkSlip1 Alm" - When set to "1," indicates a brake slippage signal has been detected. Bit 4 "Brake Set" - When set to "1," indicates a brake set signal has been detected. Bit 5 "LoadTestActv" - When set to "1," indicates that a test for load above base speed operation is active. Bit 6 "RefLoadLmtd" - When set to "1," indicates that the speed reference is limited due to load test results. Bit 7 "Encoderless" - When set to "1," indicates that encoderless torque proving mode is active. Note: This parameter was added for firmware revision 6.001.			1101																																																			
			<table border="1"> <thead> <tr> <th>Options</th> <th>Reserved</th> <th>Reserved</th> <th>Reserved</th> <th>Reserved</th> <th>Reserved</th> <th>Reserved</th> <th>Reserved</th> <th>Reserved</th> <th>Encoderless</th> <th>RefLoadLmtd</th> <th>LoadTestActv</th> <th>Brake Set</th> <th>BrkSlip 1 Alm</th> <th>Micro Psn</th> <th>DecellmActv</th> <th>EndLimitActv</th> </tr> </thead> <tbody> <tr> <td>Default</td> <td>x</td> <td>x</td> <td>x</td> <td>x</td> <td>x</td> <td>x</td> <td>x</td> <td>x</td> <td>0</td> <td>0</td> <td>0</td> <td>0</td> <td>0</td> <td>0</td> <td>0</td> <td>0</td> </tr> <tr> <td>Bit</td> <td>15</td> <td>14</td> <td>13</td> <td>12</td> <td>11</td> <td>10</td> <td>9</td> <td>8</td> <td>7</td> <td>6</td> <td>5</td> <td>4</td> <td>3</td> <td>2</td> <td>1</td> <td>0</td> </tr> </tbody> </table>	Options	Reserved	Reserved	Reserved	Reserved	Reserved	Reserved	Reserved	Reserved	Encoderless	RefLoadLmtd	LoadTestActv	Brake Set	BrkSlip 1 Alm	Micro Psn	DecellmActv	EndLimitActv	Default	x	x	x	x	x	x	x	x	0	0	0	0	0	0	0	0	Bit	15	14	13	12	11	10	9	8	7	6	5	4	3	2	1	0			
		Options	Reserved	Reserved	Reserved	Reserved	Reserved	Reserved	Reserved	Reserved	Encoderless	RefLoadLmtd	LoadTestActv	Brake Set	BrkSlip 1 Alm	Micro Psn	DecellmActv	EndLimitActv																																							
		Default	x	x	x	x	x	x	x	x	0	0	0	0	0	0	0	0																																							
		Bit	15	14	13	12	11	10	9	8	7	6	5	4	3	2	1	0																																							
		1104	<b>[Torq Limit Slew]</b> Rate at which to ramp the torque limits to zero during brake proving. Note: This parameter was added for firmware revision 6.001.	Default: 10.0 Min/Max: 0.5 / 300.0 Units: s	Real																																																				
		1105	<b>[Speed Dev Band]</b> Acceptable amount of deviation between the commanded speed and the actual speed (from a feedback device) when torque proving is enabled. When this value is exceeded for the time specified in Par 1106 [SpdBand Intgrtr], a "TorqPrv Spd Band" (F94) fault occurs. Note: This parameter was added for firmware revision 6.001.	Default: Par 162 [Max Feedback Spd] x 0.03 Min/Max: Par 162 x 0.002 / Par 162 x 0.25 Units: rpm	Real	162, 1106																																																			
		1106	<b>[Spd Band Intgrtr]</b> Amount of time that the actual speed can deviate from the value set in Par 1105 [Speed Dev Band] before a "TorqPrv Spd Band" (F94) fault occurs. Note: This parameter was added for firmware revision 6.001.	Default: 60 Min/Max: 1 / 500 Units: ms	16-bit Int	1105																																																			
		1107	<b>[Brk Release Time]</b> Amount of time between the brake release command and when the drive begins to accelerate. In encoderless mode, this parameter sets the time to release the brake after the drive starts. Note: This parameter was added for firmware revision 6.001.	Default: 100 Min/Max: 0 / 1000 Units: ms	16-bit Int																																																				
		1108	<b>[Brk Set Time]</b> Amount of time between the brake set command and when the start of brake proving. Note: This parameter was added for firmware revision 6.001.	Default: 100 Min/Max: 0 / 1000 Units: ms	16-bit Int																																																				
		1109	<b>[Brk Alarm Travel]</b> Number of motor shaft revolutions allowed during the brake slippage test. Drive torque is reduced to check for brake slippage. When slippage occurs, the drive allows this number of motor shaft revolutions before regaining control. This parameter value is not used when Par 1100 [Torq Prove Cfg], Bit 1 "Encoderless" is set to "1" (enabled). Note: This parameter was added for firmware revision 6.001.	Default: 1.00 Min/Max: 0.00 / 1000.00	Real	1100																																																			
		1110	<b>[Brk Slip Count]</b> Number of encoder/resolver revolutions that define a brake slippage condition. This parameter value is not used when Par 1100 [Torq Prove Cfg], Bit 1 "Encoderless" is set to "1" (enabled). Note: This parameter was added for firmware revision 6.001.	Default: 0.25 Min/Max: 0.00 / 100.00	Real	1100																																																			
1111	<b>[Float Tolerance]</b> Speed at which the float time (set in Par 1113 [ZeroSpdFloatTime]) starts. Also, the speed at or below which the brake is closed when Par 1100 [Torq Prove Cfg], Bit 1 "Encoderless" is set to "1" (enabled). Note: This parameter was added for firmware revision 6.001.	Default: Par 162 [Max Feedback Spd] x 0.03 Min/Max: Par 162 x 0.002 / Par 162 x 0.25 Units: rpm	Real	162, 1100																																																					
1112	<b>[MicroPsnScalePct]</b> Percent of the commanded speed reference used when bit 2 "Micro Psn" is set to "1" in Par 1100 [Torq Prove Cfg]. Bit 2 "Micro Psn," also determines if the motor needs to come to a stop before the setting in this parameter will take effect. Note: This parameter was added for firmware revision 6.001.	Default: 10.0 Min/Max: 0.1 / 100.0 Units: %	Real	1100																																																					

File	Group	No.	Parameter Name & Description <small>See page 117 for symbol descriptions</small>	Values	Data Type	Related				
APPLICATIONS	Torque Prove	1113 <b>A</b>	<b>[ZeroSpdFloatTime]</b> Amount of time the drive is at or below the speed set in Par 1111 [Float Tolerance] before the brake is set. This parameter is not used when Par 1100 [Torq Prove Cfg] Bit 1 "Encoderless" is set to "1" (enabled). Note: This parameter was added for firmware revision 6.001.	Default: 5.0 Min/Max: 0.1 / 500.0 Units: s	Real	1100				
		1114 <b>A</b>	<b>[Brake Test Torq]</b> Percent of torque applied to the motor before the brake is released when Par 1100 [Torq Prove Cfg], bit 7 "Test Brake" is set to "1" (enabled). Note: This parameter was added for firmware revision 6.001.	Default: 50 Min/Max: 0 / 150 Units: %	Real	1100				
	Scale Blocks	Scale Inputs	484 553 1218 1227 1236 1245 <b>A</b>	<b>[Scale1 Input]</b> <b>[Scale2 Input]</b> <b>[Scale3 Input]</b> <b>[Scale4 Input]</b> <b>[Scale5 Input]</b> <b>[Scale6 Input]</b> Parameter number from which the value is read and used as the input quantity to the Scale block. See the Scale Blocks block diagram on page 379 for more information.	Default: 0 Min/Max: 0 / 1410	16-bit Int				
			Scale Outputs	485 554 1219 1228 1237 1246 <b>A</b>	<b>[Scale1 Output]</b> <b>[Scale2 Output]</b> <b>[Scale3 Output]</b> <b>[Scale4 Output]</b> <b>[Scale5 Output]</b> <b>[Scale6 Output]</b> Parameter number to which the value of the Scale block output is written. See the Scale Blocks block diagram on page 379 for more information.	Default: 0 Min/Max: 0 / 1410	16-bit Int			
				Scale Multipliers	486 555 1220 1229 1238 1247 <b>A</b>	<b>[Scale1 Mul]</b> <b>[Scale2 Mul]</b> <b>[Scale3 Mul]</b> <b>[Scale4 Mul]</b> <b>[Scale5 Mul]</b> <b>[Scale6 Mul]</b> Multiplier of the input quantity (after a possible limitation). Resolution: 5 digits. See the Scale Blocks block diagram on page 379 for more information.	Default: 1.00 Min/Max: -/+10000.00	Real		
					Scale Divisors	487 556 1221 1230 1239 1248 <b>A</b>	<b>[Scale1 Div]</b> <b>[Scale2 Div]</b> <b>[Scale3 Div]</b> <b>[Scale4 Div]</b> <b>[Scale5 Div]</b> <b>[Scale6 Div]</b> Divisor, through which it is possible to divide the input quantity already multiplied and limited. Resolution: 5 digits. See the Scale Blocks block diagram on page 379 for more information.	Default: 1.00 Min/Max: -/+10000.00	Real	
						Scale Maximums	488 557 1222 1231 1240 1249 <b>A</b>	<b>[Scale1 In Max]</b> <b>[Scale2 In Max]</b> <b>[Scale3 In Max]</b> <b>[Scale4 In Max]</b> <b>[Scale5 In Max]</b> <b>[Scale6 In Max]</b> Maximum limit of the input quantity. Resolution: 5 digits. See the Scale Blocks block diagram on page 379 for more information.	Default: 0.00 Min/Max: $-2^{31} / +2^{31} - 1$	Real
			Scale Minimums				489 558 1223 1232 1241 1250 <b>A</b>	<b>[Scale1 In Min]</b> <b>[Scale2 In Min]</b> <b>[Scale3 In Min]</b> <b>[Scale4 In Min]</b> <b>[Scale5 In Min]</b> <b>[Scale6 In Min]</b> Minimum limit of the input quantity. Resolution: 5 digits. See the Scale Blocks block diagram on page 379 for more information.	Default: 0.00 Min/Max: $-2^{31} / +2^{31} - 1$	Real

File	Group	No.	Parameter Name & Description <small>See page 117 for symbol descriptions</small>	Values	Data Type	Related
APPLICATIONS	Scale Blocks	490	[Scale1 In Off]	Default: 0.00	Real	
		559	[Scale2 In Off]	Min/Max: $-2^{31} / +2^{31} - 1$		
		1224	[Scale3 In Off]			
		1233	[Scale4 In Off]			
		1242	[Scale5 In Off]			
		1251	[Scale6 In Off]			
		<b>A</b>	Offset to be added to the input quantity. Resolution: 5 digits. See the Scale Blocks block diagram on page 379 for more information.			
		491	[Scale1 Out Off]	Default: 0.00	Real	
		560	[Scale2 Out Off]	Min/Max: $-2^{31} / +2^{31} - 1$		
1225	[Scale3 Out Off]					
1234	[Scale4 Out Off]					
1243	[Scale5 Out Off]					
1252	[Scale6 Out Off]					
<b>A</b>	Offset to be added to the output quantity. Resolution: 5 digits. See the Scale Blocks block diagram on page 379 for more information.					
492	[Scale1 In Abs]	Default: 0 = "Off"	16-bit Int			
561	[Scale2 In Abs]	Options: 0 = "Off"				
1226	[Scale3 In Abs]	1 = "On"				
1235	[Scale4 In Abs]					
1244	[Scale5 In Abs]					
1253	[Scale6 In Abs]					
<b>A</b>	Controls how the input value is processed. <ul style="list-style-type: none"> <li>• "Off" = The input quantity is processed with its sign.</li> <li>• "On" = The input quantity is processed with a positive sign (absolute value).</li> </ul> It is possible to have the polarity change with the signs of the [ScalexMul] or [ScalexDiv] parameters. See the Scale Blocks block diagram on page 379 for more information.					

# Utility File

File	Group	No.	Parameter Name & Description <small>See page 117 for symbol descriptions</small>	Values	Data Type	Related																																																						
UTILITY	Reference Config	209	<b>[Save HIM Ref]</b> Enables a feature to save the present reference value issued by the HIM to drive memory when a power loss occurs. The value is restored to the HIM at power up. Bit 0 - "At Pwr Down" 0 = Do not save, 1 = Save at power down  Options <table border="1"> <thead> <tr> <th></th> <th>Reserved</th> <th>Reserved</th> <th>Reserved</th> <th>Reserved</th> <th>Reserved</th> <th>Reserved</th> <th>Reserved</th> <th>Reserved</th> <th>Reserved</th> <th>Reserved</th> <th>Reserved</th> <th>Reserved</th> <th>Reserved</th> <th>Reserved</th> <th>Reserved</th> <th>Reserved</th> <th>At Pwr Down</th> </tr> </thead> <tbody> <tr> <td>Default</td> <td>x</td> <td>x</td> <td>x</td> <td>x</td> <td>x</td> <td>x</td> <td>x</td> <td>x</td> <td>x</td> <td>x</td> <td>x</td> <td>x</td> <td>x</td> <td>x</td> <td>x</td> <td>x</td> <td>1</td> </tr> <tr> <td>Bit</td> <td>15</td> <td>14</td> <td>13</td> <td>12</td> <td>11</td> <td>10</td> <td>9</td> <td>8</td> <td>7</td> <td>6</td> <td>5</td> <td>4</td> <td>3</td> <td>2</td> <td>1</td> <td>0</td> <td></td> </tr> </tbody> </table>		Reserved	Reserved	Reserved	Reserved	Reserved	Reserved	Reserved	Reserved	Reserved	Reserved	Reserved	Reserved	Reserved	Reserved	Reserved	Reserved	At Pwr Down	Default	x	x	x	x	x	x	x	x	x	x	x	x	x	x	x	x	1	Bit	15	14	13	12	11	10	9	8	7	6	5	4	3	2	1	0				
			Reserved	Reserved	Reserved	Reserved	Reserved	Reserved	Reserved	Reserved	Reserved	Reserved	Reserved	Reserved	Reserved	Reserved	Reserved	Reserved	At Pwr Down																																									
		Default	x	x	x	x	x	x	x	x	x	x	x	x	x	x	x	x	1																																									
		Bit	15	14	13	12	11	10	9	8	7	6	5	4	3	2	1	0																																										
		210	<b>[Man Ref Preload]</b> Enables/disables a feature to automatically load the present "Auto" reference value into the HIM when "Manual" is selected. Allows smooth speed transition from "Auto" to "Manual."  Default: 1 = "Enabled" Options: 0 = "Disabled", 1 = "Enabled"	16-bit Int																																																								
		249	<b>[MOP Ref Config]</b> Enables/Disables the feature that saves the present MOP reference at power down or at stop. Notes: This parameter can be assigned to a digital input. Bits 2 and 3 were added for firmware revision 6.001. <ul style="list-style-type: none"> <li>• Bit 0 "Save PwrDown" - When set to "0" = Do not save, "1" = Save</li> <li>• Bit 1 "Save At Stop" - When set to "0" = Do not save, "1" = Save</li> <li>• Bit 2 "Reset AtStop" - When set to "0" = No MOP reset, "1" = Reset MOP at Stop</li> <li>• Bit 3 "Reset At Flt" - When set to "0" = No MOP reset, "1" = Reset MOP at Fault</li> </ul> Options <table border="1"> <thead> <tr> <th></th> <th>Reserved</th> <th>Reserved</th> <th>Reserved</th> <th>Reserved</th> <th>Reserved</th> <th>Reserved</th> <th>Reserved</th> <th>Reserved</th> <th>Reserved</th> <th>Reserved</th> <th>Reserved</th> <th>Reserved</th> <th>Reset At Flt</th> <th>Reset AtStop</th> <th>Save At Stop</th> <th>Save PwrDown</th> </tr> </thead> <tbody> <tr> <td>Default</td> <td>x</td> <td>x</td> <td>x</td> <td>x</td> <td>x</td> <td>x</td> <td>x</td> <td>x</td> <td>x</td> <td>x</td> <td>x</td> <td>x</td> <td>0</td> <td>0</td> <td>0</td> <td>0</td> </tr> <tr> <td>Bit</td> <td>15</td> <td>14</td> <td>13</td> <td>12</td> <td>11</td> <td>10</td> <td>9</td> <td>8</td> <td>7</td> <td>6</td> <td>5</td> <td>4</td> <td>3</td> <td>2</td> <td>1</td> <td>0</td> </tr> </tbody> </table>		Reserved	Reserved	Reserved	Reserved	Reserved	Reserved	Reserved	Reserved	Reserved	Reserved	Reserved	Reserved	Reset At Flt	Reset AtStop	Save At Stop	Save PwrDown	Default	x	x	x	x	x	x	x	x	x	x	x	x	0	0	0	0	Bit	15	14	13	12	11	10	9	8	7	6	5	4	3	2	1	0						
			Reserved	Reserved	Reserved	Reserved	Reserved	Reserved	Reserved	Reserved	Reserved	Reserved	Reserved	Reserved	Reset At Flt	Reset AtStop	Save At Stop	Save PwrDown																																										
		Default	x	x	x	x	x	x	x	x	x	x	x	x	0	0	0	0																																										
		Bit	15	14	13	12	11	10	9	8	7	6	5	4	3	2	1	0																																										
		1322	 <b>[Direction Mode]</b> Selects the method that will be used for changing direction. <ul style="list-style-type: none"> <li>• "Unipolar" - Drive Logic determines the direction.</li> <li>• "Bipolar" - The sign of the reference determines the direction.</li> <li>• "Rev Disable" - Forward direction only (not changeable).</li> </ul> Default: 0 = "Unipolar" Options: 0 = "Unipolar", 1 = "Bipolar", 2 = "Rev Disable"	16-bit Int																																																								
1375	 <b>[MOP Select]</b> Selects the destination of the MOP signal.  Default: 0 = "OFF" Options: 0 = "OFF", 1 = "Speed Ref A", 2 = "Speed Ref B", 3 = "Trim Speed", 4 = "TB Man Ref"	16-bit Int																																																										
211	<b>[Param Access Lvl]</b> Selects the parameter display level. <ul style="list-style-type: none"> <li>• "Basic" = Reduced parameter set.</li> <li>• "Advanced" = Full parameter set.</li> </ul> Default: 0 = "Basic" Options: 0 = "Basic", 1 = "Advanced"	16-bit Int																																																										
258	 <b>[Reset Defaults]</b> Setting this parameter to 1 "Factory" will load the default settings in the drive firmware.  Default: 0 = "Ready" Options: 0 = "Ready", 1 = "Factory"	16-bit Int																																																										
302	<b>[Language]</b> Selects the operating language of the drive. Only two languages are available in the drive at any given time, English and one of the following: French, German, Italian, Portuguese, or Spanish. The drive ships with the default language options of English and Spanish only. The additional language files can be downloaded from the Product Compatibility and Download Center at: <a href="https://compatibility.rockwellautomation.com/Pages/home.aspx">https://compatibility.rockwellautomation.com/Pages/home.aspx</a> Note: This parameter was added for firmware revision 3.001.  Default: 0 = "Not Selected" Options: 0 = "Not Selected", 1 = "English", 2 = "French", 3 = "Spanish", 4 = "Italian", 5 = "German", 6 = "Reserved", 7 = "Portuguese"	16-bit Int																																																										

File	Group	No.	Parameter Name & Description See <a href="#">page 117</a> for symbol descriptions	Values		Data Type	Related
UTILITY	Diagnostics	346	<b>[Torque Positive]</b> Indicates whether the drive is operating with a positive torque reference. <ul style="list-style-type: none"> <li>1 "Active" = The drive is operating with a positive torque reference. The motor is accelerating in the forward direction or decelerating in the negative direction and Par 20 [Ramp Delay] has timed out.</li> <li>0 "Not Active" = The drive is not operating with a positive torque reference.</li> </ul> Note: This parameter can be assigned to a digital output.	Default:	Read Only	16-bit Int	20
				Min/Max:	0 / 1		
		347	<b>[Torque Negative]</b> Indicates whether the drive is operating with a negative torque reference. <ul style="list-style-type: none"> <li>1 "Active" = The drive is operating with negative torque reference. The motor is accelerating in the reverse direction or decelerating in the forward direction and Par 20 [Ramp Delay] has timed out.</li> <li>0 "Not Active" = The drive is not operating with negative torque reference.</li> </ul> Note: This parameter can be assigned to a digital output and is used for four quadrant drives only.	Default:	Read Only	16-bit Int	20
				Min/Max:	0 / 1		
349	<b>[CurrLimit Active]</b> Indicates whether or not the drive is working within the set current limits. <ul style="list-style-type: none"> <li>1 "Active" = The drive is currently in a current limited state.</li> <li>0 "Not Active" = The drive is not in a current limited state.</li> </ul> Note: This parameter is assigned to digital output 4 (Par 148 [Digital Out4 Sel]) by default.	Default:	Read Only	16-bit Int			
		Min/Max:	0 / 1				
372	<b>[Spd Limit Active]</b> Indicates whether the current speed reference value is limited by the defined minimum and maximum limit values. <ul style="list-style-type: none"> <li>1 "Active" = The reference value is currently limited because the value entered is out of range of the limit values defined.</li> <li>0 "Not Active" = The reference value is within the defined limit values.</li> </ul> Note: This parameter can be assigned to a digital output.	Default:	Read Only	16-bit Int			
		Min/Max:	0 / 1				

File	Group	No.	Parameter Name & Description See page 117 for symbol descriptions	Values	Data Type	Related																																																																																																																																																																															
UTILITY	Diagnostics	381	<p><b>[Drive Status 1]</b>                      Present operating condition of the drive.                      Bit 0 "Ready" - When set (= "1"), the drive is ready                      Bit 1 "Active" - When set, the drive is active                      Bit 2 "Command Dir" - The direction of commanded rotation, 0 = Reverse, 1 = Forward                      Bit 3 "Actual Dir" - The actual direction of the motor, 0 = Reverse, 1 = Forward                      Bit 4 "Accelerating" - When set, the drive is accelerating                      Bit 5 "Decelerating" - When set, the drive is decelerating                      Bit 6 "Alarm" - When set, the drive is in an alarm state                      Bit 7 "Fault" - When set, the drive is faulted                      Bit 8 "At Speed" - When set, the drive is at the commanded speed                      Bit 9 - 11 "Local ID 0-2" <sup>(1)</sup>                      Bit 12-15 "Spd Ref ID 0-3" <sup>(2)</sup></p>	Read Only																																																																																																																																																																																	
			<table border="1"> <thead> <tr> <th>Options</th> <th>Spd Ref ID 3 <sup>(2)</sup></th> <th>Spd Ref ID 2 <sup>(2)</sup></th> <th>Spd Ref ID 1 <sup>(2)</sup></th> <th>Spd Ref ID 0 <sup>(2)</sup></th> <th>Local ID 2 <sup>(1)</sup></th> <th>Local ID 1 <sup>(1)</sup></th> <th>Local ID 0 <sup>(1)</sup></th> <th>At Speed</th> <th>Faulted</th> <th>Alarm</th> <th>Decelerating</th> <th>Accelerating</th> <th>Actual Dir</th> <th>Command Dir</th> <th>Active</th> <th>Ready</th> </tr> </thead> <tbody> <tr> <td>Default</td> <td>0</td> <td>0</td> <td>0</td> <td>0</td> <td>0</td> <td>0</td> <td>1</td> <td>0</td> <td>0</td> <td>0</td> <td>0</td> <td>0</td> <td>1</td> <td>1</td> <td>0</td> <td>1</td> </tr> <tr> <td>Bit</td> <td>15</td> <td>14</td> <td>13</td> <td>12</td> <td>11</td> <td>10</td> <td>9</td> <td>8</td> <td>7</td> <td>6</td> <td>5</td> <td>4</td> <td>3</td> <td>2</td> <td>1</td> <td>0</td> </tr> </tbody> </table> <table border="1"> <thead> <tr> <th colspan="4"><sup>(2)</sup> Bits</th> <th>Description</th> </tr> <tr> <th>15</th> <th>14</th> <th>13</th> <th>12</th> <th></th> </tr> </thead> <tbody> <tr><td>0</td><td>0</td><td>0</td><td>0</td><td>Spd Ref A Auto</td></tr> <tr><td>0</td><td>0</td><td>0</td><td>1</td><td>Spd Ref B Auto</td></tr> <tr><td>0</td><td>0</td><td>1</td><td>0</td><td>Preset Spd 2 Auto</td></tr> <tr><td>0</td><td>0</td><td>1</td><td>1</td><td>Preset Spd 3 Auto</td></tr> <tr><td>0</td><td>1</td><td>0</td><td>0</td><td>Preset Spd 4 Auto</td></tr> <tr><td>0</td><td>1</td><td>0</td><td>1</td><td>Preset Spd 5 Auto</td></tr> <tr><td>0</td><td>1</td><td>1</td><td>0</td><td>Preset Spd 6 Auto</td></tr> <tr><td>0</td><td>1</td><td>1</td><td>1</td><td>Preset Spd 7 Auto</td></tr> <tr><td>1</td><td>0</td><td>0</td><td>0</td><td>TB Manual</td></tr> <tr><td>1</td><td>0</td><td>0</td><td>1</td><td>DPI Port 1 Manual</td></tr> <tr><td>1</td><td>0</td><td>1</td><td>0</td><td>DPI Port 2 Manual</td></tr> <tr><td>1</td><td>0</td><td>1</td><td>1</td><td>DPI Port 3 Manual</td></tr> <tr><td>1</td><td>1</td><td>0</td><td>0</td><td>DPI Port 4 Manual</td></tr> <tr><td>1</td><td>1</td><td>0</td><td>1</td><td>DPI Port 5 Manual</td></tr> <tr><td>1</td><td>1</td><td>1</td><td>0</td><td>DPI Port 6 Manual</td></tr> <tr><td>1</td><td>1</td><td>1</td><td>1</td><td>Jog Ref</td></tr> </tbody> </table> <table border="1"> <thead> <tr> <th colspan="3"><sup>(1)</sup> Bits</th> <th>Description</th> </tr> <tr> <th>11</th> <th>10</th> <th>9</th> <th></th> </tr> </thead> <tbody> <tr><td>0</td><td>0</td><td>0</td><td>Port 0 (TB)</td></tr> <tr><td>0</td><td>0</td><td>1</td><td>DPI Port 1</td></tr> <tr><td>0</td><td>1</td><td>0</td><td>DPI Port 2</td></tr> <tr><td>0</td><td>1</td><td>1</td><td>DPI Port 3</td></tr> <tr><td>1</td><td>0</td><td>0</td><td>DPI Port 4</td></tr> <tr><td>1</td><td>0</td><td>1</td><td>DPI Port 5</td></tr> <tr><td>1</td><td>1</td><td>0</td><td>DPI Port 6</td></tr> <tr><td>1</td><td>1</td><td>1</td><td>No Local Control</td></tr> </tbody> </table>				Options	Spd Ref ID 3 <sup>(2)</sup>	Spd Ref ID 2 <sup>(2)</sup>	Spd Ref ID 1 <sup>(2)</sup>	Spd Ref ID 0 <sup>(2)</sup>	Local ID 2 <sup>(1)</sup>	Local ID 1 <sup>(1)</sup>	Local ID 0 <sup>(1)</sup>	At Speed	Faulted	Alarm	Decelerating	Accelerating	Actual Dir	Command Dir	Active	Ready	Default	0	0	0	0	0	0	1	0	0	0	0	0	1	1	0	1	Bit	15	14	13	12	11	10	9	8	7	6	5	4	3	2	1	0	<sup>(2)</sup> Bits				Description	15	14	13	12		0	0	0	0	Spd Ref A Auto	0	0	0	1	Spd Ref B Auto	0	0	1	0	Preset Spd 2 Auto	0	0	1	1	Preset Spd 3 Auto	0	1	0	0	Preset Spd 4 Auto	0	1	0	1	Preset Spd 5 Auto	0	1	1	0	Preset Spd 6 Auto	0	1	1	1	Preset Spd 7 Auto	1	0	0	0	TB Manual	1	0	0	1	DPI Port 1 Manual	1	0	1	0	DPI Port 2 Manual	1	0	1	1	DPI Port 3 Manual	1	1	0	0	DPI Port 4 Manual	1	1	0	1	DPI Port 5 Manual	1	1	1	0	DPI Port 6 Manual	1	1	1	1	Jog Ref	<sup>(1)</sup> Bits			Description	11	10	9		0	0	0	Port 0 (TB)	0	0	1	DPI Port 1	0	1	0	DPI Port 2	0	1	1	DPI Port 3	1	0	0	DPI Port 4	1	0	1	DPI Port 5	1	1
Options	Spd Ref ID 3 <sup>(2)</sup>	Spd Ref ID 2 <sup>(2)</sup>	Spd Ref ID 1 <sup>(2)</sup>	Spd Ref ID 0 <sup>(2)</sup>	Local ID 2 <sup>(1)</sup>	Local ID 1 <sup>(1)</sup>	Local ID 0 <sup>(1)</sup>	At Speed	Faulted	Alarm	Decelerating	Accelerating	Actual Dir	Command Dir	Active	Ready																																																																																																																																																																					
Default	0	0	0	0	0	0	1	0	0	0	0	0	1	1	0	1																																																																																																																																																																					
Bit	15	14	13	12	11	10	9	8	7	6	5	4	3	2	1	0																																																																																																																																																																					
<sup>(2)</sup> Bits				Description																																																																																																																																																																																	
15	14	13	12																																																																																																																																																																																		
0	0	0	0	Spd Ref A Auto																																																																																																																																																																																	
0	0	0	1	Spd Ref B Auto																																																																																																																																																																																	
0	0	1	0	Preset Spd 2 Auto																																																																																																																																																																																	
0	0	1	1	Preset Spd 3 Auto																																																																																																																																																																																	
0	1	0	0	Preset Spd 4 Auto																																																																																																																																																																																	
0	1	0	1	Preset Spd 5 Auto																																																																																																																																																																																	
0	1	1	0	Preset Spd 6 Auto																																																																																																																																																																																	
0	1	1	1	Preset Spd 7 Auto																																																																																																																																																																																	
1	0	0	0	TB Manual																																																																																																																																																																																	
1	0	0	1	DPI Port 1 Manual																																																																																																																																																																																	
1	0	1	0	DPI Port 2 Manual																																																																																																																																																																																	
1	0	1	1	DPI Port 3 Manual																																																																																																																																																																																	
1	1	0	0	DPI Port 4 Manual																																																																																																																																																																																	
1	1	0	1	DPI Port 5 Manual																																																																																																																																																																																	
1	1	1	0	DPI Port 6 Manual																																																																																																																																																																																	
1	1	1	1	Jog Ref																																																																																																																																																																																	
<sup>(1)</sup> Bits			Description																																																																																																																																																																																		
11	10	9																																																																																																																																																																																			
0	0	0	Port 0 (TB)																																																																																																																																																																																		
0	0	1	DPI Port 1																																																																																																																																																																																		
0	1	0	DPI Port 2																																																																																																																																																																																		
0	1	1	DPI Port 3																																																																																																																																																																																		
1	0	0	DPI Port 4																																																																																																																																																																																		
1	0	1	DPI Port 5																																																																																																																																																																																		
1	1	0	DPI Port 6																																																																																																																																																																																		
1	1	1	No Local Control																																																																																																																																																																																		



File	Group	No.	Parameter Name & Description <small>See page 117 for symbol descriptions</small>	Values	Data Type	Related																																																			
UTILITY	Diagnostics	382	<p><b>[Drive Status 2]</b>                      Present operating condition of the drive.                      Bit 0 "Ready" - When set (= "1"), the drive is ready                      Bit 1 "Active" - When set, the drive is active                      Bit 2 "Running" - When set, the drive is running                      Bit 3 "Jogging" - When set, the drive is being jogged                      Bit 4 "Stopping" - When set, the drive is stopping                      Bit 6 "Auto Tuning" - When set, the drive is auto tuning                      Bit 7 "Forced Spd" - When set, the drive is in forced speed mode                      Bit 8 "Speed Mode" - When set, the drive is in speed mode                      Bit 9 "Torque Mode" - When set, the drive is in torque mode                      Bit 10 "SpdRegPosLim" - When set, the Speed Regulator PI positive limit is active                      Bit 11 "SpdRegNegLim" - When set, the Speed Regulator PI negative limit is active                      Bit 12 "ArmAlphaTest" - When set, the Armature Alpha test is active                      Bit 13 "FldAlphaTest" - When set, the Field Alpha test is active                      Notes: Added bits 7...13 for firmware revision 3.001. See Torque Mode Selection Status Bits on page 347 for more information.</p> <table border="1" style="width: 100%; border-collapse: collapse;"> <thead> <tr> <th>Options</th> <th>Reserved</th> <th>Reserved</th> <th>FldAlphaTest</th> <th>ArmAlphaTest</th> <th>SpdRegNegLim</th> <th>SpdRegPosLim</th> <th>Torque Mode</th> <th>Speed Mode</th> <th>Forced Spd</th> <th>Auto Tuning</th> <th>Curr Limit</th> <th>Stopping</th> <th>Jogging</th> <th>Running</th> <th>Active</th> <th>Ready</th> </tr> </thead> <tbody> <tr> <td>Default</td> <td>x</td> <td>x</td> <td>0</td> <td>0</td> <td>0</td> <td>0</td> <td>0</td> <td>0</td> <td>0</td> <td>0</td> <td>0</td> <td>0</td> <td>0</td> <td>0</td> <td>0</td> <td>1</td> </tr> <tr> <td>Bit</td> <td>15</td> <td>14</td> <td>13</td> <td>12</td> <td>11</td> <td>10</td> <td>9</td> <td>8</td> <td>7</td> <td>6</td> <td>5</td> <td>4</td> <td>3</td> <td>2</td> <td>1</td> <td>0</td> </tr> </tbody> </table>	Options	Reserved	Reserved	FldAlphaTest	ArmAlphaTest	SpdRegNegLim	SpdRegPosLim	Torque Mode	Speed Mode	Forced Spd	Auto Tuning	Curr Limit	Stopping	Jogging	Running	Active	Ready	Default	x	x	0	0	0	0	0	0	0	0	0	0	0	0	0	1	Bit	15	14	13	12	11	10	9	8	7	6	5	4	3	2	1	0	Read Only		
		Options	Reserved	Reserved	FldAlphaTest	ArmAlphaTest	SpdRegNegLim	SpdRegPosLim	Torque Mode	Speed Mode	Forced Spd	Auto Tuning	Curr Limit	Stopping	Jogging	Running	Active	Ready																																							
		Default	x	x	0	0	0	0	0	0	0	0	0	0	0	0	0	1																																							
		Bit	15	14	13	12	11	10	9	8	7	6	5	4	3	2	1	0																																							
		393	<b>A</b>	<p><b>[Speed Threshold]</b>                      Indicates if the drive is above or below the threshold speed specified in parameters 101 [Speed Thresh Pos] (clockwise rotation) and 102 [Speed Thresh Neg] (counter-clockwise rotation).                      • "0 Above Thresh" = The speed has exceeded the set speed threshold.                      • "1 Below Thresh" = The speed has not exceeded the set speed threshold.                      Notes: This parameter can be assigned to a digital output. See Speed Threshold Indicators on page 339 for more information.</p>	Default: 0 / 1 Min/Max: 0 / 1	Read Only	16-bit Int	101, 102, 103																																																	
394		<p><b>[At Speed]</b>                      Indicates whether or not the current speed of the drive corresponds to the speed reference (specified in Par 118 [Speed Reg In]) before the speed regulator and the ramp reference (if enabled) are applied. The speed above and below the speed reference at which [At Speed] will indicate "1 Equal" is set in Par 104 [At Speed Error].                      • "0 Not Equal" - The drive is not working at the set speed reference.                      • "1 Equal" - The drive is working at the set speed reference.                      Notes: This parameter can be assigned to a digital output. It also corresponds to the "At Speed" indication on the Status Line of the HIM. See Speed Threshold Indicators on page 339 for more information.</p>	Default: 0 / 1 Min/Max: 0 / 1	Read Only	16-bit Int	104, 105																																																			
395		<p><b>[At Zero Speed]</b>                      Indicates whether or not the actual speed of the motor is below the zero speed threshold as specified in Par 107 [Speed Zero Level].                      • "0 Equal" - The actual speed is below the value of Par 107 [Speed Zero Level] and Par 108 [Speed Zero Delay] has timed out.                      • "1 Not Equal" - The actual speed is above the value of Par 107 [Speed Zero Level].                      Notes: This parameter can be assigned to a digital output. See Speed Threshold Indicators on page 339 for more information.</p>	Default: 0 / 1 Min/Max: 0 / 1	Read Only	16-bit Int	107, 108																																																			
396	<b>A</b>	<p><b>[MOP Inc Active]</b>                      Indicates whether or not the drive is accelerating using the preselected ramp.                      • 0 "No Accel" = the drive is not accelerating using a preselected ramp                      • 1 "Accel" = the drive is accelerating using a preselected ramp</p>	Default: 0 / 1 Min/Max: 0 / 1	Read Only	16-bit Int																																																				

















File	Group	No.	Parameter Name & Description See page 117 for symbol descriptions	Values	Data Type	Related	
UTILITY	Diagnostics	397 <b>A</b>	<b>[MOP Dec Active]</b> Indicates whether the drive is decelerating using the preselected ramp. <ul style="list-style-type: none"> <li>• 0 "No Decel" = The drive is not decelerating using a preselected ramp</li> <li>• 1 "Decel" = The drive is decelerating using a preselected ramp</li> </ul>	Default: Min/Max:	Read Only 0 / 1	16-bit Int	
		400 <b>A</b>	<b>[Spd Select 0]</b> Indicates the state of the assigned digital input, [Digital Inx Sel], set to 17 "Speed Sel 1". See Option Definitions for [Digital Inx Sel] on page 200 for instructions on how to set digital input speed selects to different speed references. <ul style="list-style-type: none"> <li>• "0" = Digital input [Digital Inx Sel] set to 17 "Speed Sel 1" not asserted</li> <li>• "1" = Digital input [Digital Inx Sel] set to 17 "Speed Sel 1" asserted</li> </ul> Note: By default, the state of this parameter is determined by digital input 5.	Default: Min/Max:	Read Only 0 / 1	16-bit Int	401, 402
		401 <b>A</b>	<b>[Spd Select 1]</b> Indicates the state of the assigned digital input, [Digital Inx Sel], set to 18 "Speed Sel 2". See Option Definitions for [Digital Inx Sel] on page 200 for instructions on how to set digital input speed selects to different speed references. <ul style="list-style-type: none"> <li>• "0" = Digital input [Digital Inx Sel] set to 18 "Speed Sel 2" not asserted</li> <li>• "1" = Digital input [Digital Inx Sel] set to 18 "Speed Sel 2" asserted</li> </ul> Note: By default, the state of this parameter is determined by digital input 6.	Default: Min/Max:	Read Only 0 / 1	16-bit Int	400, 402
		402 <b>A</b>	<b>[Spd Select 2]</b> Indicates the state of the assigned digital input, [Digital Inx Sel], set to 19 "Speed Sel 3". See Option Definitions for [Digital Inx Sel] on page 200 for instructions on how to set digital input speed selects to different speed references. <ul style="list-style-type: none"> <li>• "0" = Digital input [Digital Inx Sel] set to 19 "Speed Sel 3" not asserted</li> <li>• "1" = Digital input [Digital Inx Sel] set to 19 "Speed Sel 3" asserted</li> </ul> Note: By default, the state of this parameter is determined by digital input 7.	Default: Min/Max:	Read Only 0 / 1	16-bit Int	400, 401
		403 <b>A</b>	<b>[Ramp Select 0]</b> Indicates the state of the assigned digital input, [Digital Inx Sel], set to 25 "Acc2 & Dec2" or 26 "Accel 2". <ul style="list-style-type: none"> <li>• "0" = Accel 1 ramp rate is selected</li> <li>• "1" = Accel 2 ramp rate is selected</li> </ul> Note: This parameter can be assigned to indicate the state of a digital input.	Default: Min/Max:	Read Only 0 / 1	16-bit Int	404
		404 <b>A</b>	<b>[Ramp Select 1]</b> Indicates the state of the assigned digital input, [Digital Inx Sel], set to 25 "Acc2 & Dec2" or 27 "Decel 2". <ul style="list-style-type: none"> <li>• "0" = Decel 1 ramp rate is selected</li> <li>• "1" = Decel 2 ramp rate is selected</li> </ul> Note: This parameter can be assigned to indicate the state of a digital input.	Default: Min/Max:	Read Only 0 / 1	16-bit Int	403
		432 <b>A</b>	<b>[Reslvr Error Cnt]</b> Increments (16-bit unsigned) for every SSI communication message that contains an error (for example, CRC). The value of this parameter is reset to zero at drive power-up or when the "Clear Faults" function is used. Note: This parameter was added for firmware revision 5.002.	Default: Min/Max:	0 0 / 65536	Read Only	
		651 <b>A</b>	<b>[Spd Fdbk State]</b> Indicates the status of the selected speed feedback device (DC tach, encoder, or resolver). A speed feedback loss can be configured as a fault or alarm in Par 478 [Spd Loss Flt Cfg]. <ul style="list-style-type: none"> <li>• "0" = Error</li> <li>• "1" = OK</li> </ul> Notes: This parameter can be assigned to a digital output. The name of this parameter was changed from [Encoder State] for firmware revision 5.002.	Default: Min/Max:	Read Only 0 / 1	16-bit Int	414, 478
		1290 <b>A</b>	<b>[MtrOvrd Status]</b> Current percentage of motor overload (100% = motor overload). The current percentage displays regardless of the configuration of the motor overload condition (Par 479 [MtrOvrd Flt Cfg] = Fault, Alarm, or Ignore). Note: This parameter was added for firmware revision 3.001.	Default: Min/Max: Units:	Read Only 0 / 100 %	Real	376, 479




File	Group	No.	Parameter Name & Description <small>See page 117 for symbol descriptions</small>	Values	Data Type	Related																																																																																											
UTILITY	Diagnostics	1328	<p><b>[Drive Logic Rslt]</b></p> <p>The final logic command resulting from the combination of all DPI and discrete inputs. This parameter has the same structure as the product specific logic command received via DPI and is used in peer-to-peer communications. For each bit, 1=Condition true and 0=Condition false.</p> <p>Bit 0 "Stop" - Stop command                      Bit 1 "Start" - Start command                      Bit 2 "Jog" - Jog command                      Bit 3 "Clear Faults" - Clear faults command                      Bit 4 "Forward" - Forward direction command                      Bit 5 "Reverse" - Reverse direction command                      Bit 6 "Local" - Local control command                      Bit 7 "MOP Inc" - MOP Increment command                      Bit 8 "Accel 1" - Acceleration Rate 1 command                      Bit 9 "Accel 2" - Acceleration Rate 2 command                      Bit 10 "Decel 1" - Deceleration Rate 1 command                      Bit 11 "Decel 2" - Deceleration Rate 2 command                      Bit 12...14 "Spd Ref ID 0"... "Spd Ref ID 2" - Speed reference source<sup>(1)</sup>                      Bit 15 "MOP Dec" - MOP Decrement command</p> <table border="1" style="width: 100%; border-collapse: collapse; text-align: center;"> <thead> <tr> <th>Options</th> <th>MOP Dec</th> <th>Spd Ref ID 2</th> <th>Spd Ref ID 1</th> <th>Spd Ref ID 0</th> <th>Decel 2</th> <th>Decel 1</th> <th>Accel 2</th> <th>Accel 1</th> <th>MOP Inc</th> <th>Local</th> <th>Reverse</th> <th>Forward</th> <th>Clear Faults</th> <th>Jog</th> <th>Start</th> <th>Stop</th> </tr> </thead> <tbody> <tr> <td>Default</td> <td>0</td> <td>0</td> <td>0</td> <td>0</td> <td>0</td> <td>0</td> <td>0</td> <td>0</td> <td>0</td> <td>0</td> <td>0</td> <td>0</td> <td>0</td> <td>0</td> <td>0</td> <td>1</td> </tr> <tr> <td>Bit</td> <td>15</td> <td>14</td> <td>13</td> <td>12</td> <td>11</td> <td>10</td> <td>9</td> <td>8</td> <td>7</td> <td>6</td> <td>5</td> <td>4</td> <td>3</td> <td>2</td> <td>1</td> <td>0</td> </tr> </tbody> </table> <table border="1" style="width: 100%; border-collapse: collapse; text-align: center;"> <thead> <tr> <th colspan="3">(1) Bits</th> <th>Description</th> </tr> <tr> <th>14</th> <th>13</th> <th>12</th> <th></th> </tr> </thead> <tbody> <tr> <td>0</td> <td>0</td> <td>0</td> <td>No Command - Manual Mode</td> </tr> <tr> <td>0</td> <td>0</td> <td>1</td> <td>Spd Ref A Auto</td> </tr> <tr> <td>0</td> <td>1</td> <td>0</td> <td>Spd Ref B Auto</td> </tr> <tr> <td>0</td> <td>1</td> <td>1</td> <td>Preset Spd 3 Auto</td> </tr> <tr> <td>1</td> <td>0</td> <td>0</td> <td>Preset Spd 4 Auto</td> </tr> <tr> <td>1</td> <td>0</td> <td>1</td> <td>Preset Spd 5 Auto</td> </tr> <tr> <td>1</td> <td>1</td> <td>0</td> <td>Preset Spd 6 Auto</td> </tr> <tr> <td>1</td> <td>1</td> <td>1</td> <td>Preset Spd 7 Auto</td> </tr> </tbody> </table>	Options	MOP Dec	Spd Ref ID 2	Spd Ref ID 1	Spd Ref ID 0	Decel 2	Decel 1	Accel 2	Accel 1	MOP Inc	Local	Reverse	Forward	Clear Faults	Jog	Start	Stop	Default	0	0	0	0	0	0	0	0	0	0	0	0	0	0	0	1	Bit	15	14	13	12	11	10	9	8	7	6	5	4	3	2	1	0	(1) Bits			Description	14	13	12		0	0	0	No Command - Manual Mode	0	0	1	Spd Ref A Auto	0	1	0	Spd Ref B Auto	0	1	1	Preset Spd 3 Auto	1	0	0	Preset Spd 4 Auto	1	0	1	Preset Spd 5 Auto	1	1	0	Preset Spd 6 Auto	1	1	1	Preset Spd 7 Auto			
		Options	MOP Dec	Spd Ref ID 2	Spd Ref ID 1	Spd Ref ID 0	Decel 2	Decel 1	Accel 2	Accel 1	MOP Inc	Local	Reverse	Forward	Clear Faults	Jog	Start	Stop																																																																															
Default	0	0	0	0	0	0	0	0	0	0	0	0	0	0	0	1																																																																																	
Bit	15	14	13	12	11	10	9	8	7	6	5	4	3	2	1	0																																																																																	
(1) Bits			Description																																																																																														
14	13	12																																																																																															
0	0	0	No Command - Manual Mode																																																																																														
0	0	1	Spd Ref A Auto																																																																																														
0	1	0	Spd Ref B Auto																																																																																														
0	1	1	Preset Spd 3 Auto																																																																																														
1	0	0	Preset Spd 4 Auto																																																																																														
1	0	1	Preset Spd 5 Auto																																																																																														
1	1	0	Preset Spd 6 Auto																																																																																														
1	1	1	Preset Spd 7 Auto																																																																																														
		1329	<p><b>[Speed Ref Source]</b></p> <p>Displays the number of the parameter that is the source of the drive's speed reference (Par 118 [Speed Reg In]). For example, if the value of this parameter is "70," then Par 70 [Analog In 1] is the source of the speed reference value shown in Par 118 [Speed Reg In].</p> <p>Note: This parameter was added for firmware revision 6.001.</p>	Default: Min/Max:	Read Only 0 / (highest possible parameter number)	16-bit Int 118																																																																																											





File	Group	No.	Parameter Name & Description <small>See page 117 for symbol descriptions</small>	Values	Data Type	Related																																																		
UTILITY	Diagnostics	1330	<b>[Spd Ref Sel Sts]</b> Status of the speed reference selections. <ul style="list-style-type: none"> <li>Bit 0 "Ref A Auto" - When set (= 1), the value of the speed reference is Par 44 [Speed Ref A] and the source in Par 1329 [Speed Ref Source] (Par 1328 [Drive Logic Rslt], bits 12...14 = 001).</li> <li>Bit 1 "Ref B Auto" - When set, the value of the speed reference is Par 49 [Speed Ref B] and the source in Par 1329 [Speed Ref Source] (Par 1328 [Drive Logic Rslt], bits 12...14 = 010).</li> <li>Bit 2 "Min Spd Lim" - When set, the speed reference value is clamped to the value of Par 5 [Min Speed Fwd] or 6 [Min Speed Rev], based on direction.</li> <li>Bit 3 "Max Spd Lim" - When set, the speed reference value is clamped to the value of Par 3 [Max Speed Fwd] or 4 [Max Speed Rev], based on direction.</li> <li>Bit 4 "MicroPsnMult" - When set, the selected speed reference is multiplied by the value of Par 1112 [MicroPsnScalePct].</li> <li>Bit 5 "Trim Ramp" - When set, the speed reference is offset (non-zero) by the value in Par 42 [Trim Ramp].</li> <li>Bit 6 "Trim Speed" - When set, the speed reference is offset (non-zero) by the value in Par 43 [Trim Speed].</li> <li>Bit 7 "Preset Auto" - When set, the speed reference is the "Preset Spd x Auto" source selected in Par 1328 [Drive Logic Rslt], bits 12...14 = 011...111.</li> <li>Bit 8 "Manual Ref" - When set, the speed reference is the manual reference selected in Par 1328 [Drive Logic Rslt], bits 12...14 = 000.</li> <li>Bit 9 "Scaled Ref" - When set, the speed reference is the result of the scale block configured to write to the parameter specified in Par 1329 [Speed Ref Source]. Note that if no speed reference is selected (Par 1329 [Speed Ref Source] = 0), this bit will be set (=1) if any of the Scale Block input parameters are at their default value of 0.</li> <li>Bit 10 "Bipolar Ref" - When set, Par 1322 [Direction Mode] = 1 "Bipolar" and the sign of the reference determines motor rotation direction.</li> <li>Bit 11 "Rev Disable" - When set, Par 1322 [Direction Mode] = 2 "Rev Disable" and negative speed reference values are clamped to zero.</li> <li>Bit 12 "Unipolar Ref" - When set, Par 1322 [Direction Mode] = 0 "Unipolar" and the sign of the speed reference (and motor rotation direction) is selected by Par 1328 [Drive Logic Rslt], bit 4 "Forward" or bit 5 "Reverse."</li> <li>Bit 13 "Decel Lmt Sw" - When set, torque proving logic detected an active deceleration limit switch and selected Par 154 [Preset Speed 1] for the reference.</li> <li>Bit 14 "End Lim Sw" - When set, torque proving logic detected an active end limit switch and selected zero speed for the reference.</li> </ul> Note: This parameter was added for firmware revision 6.001.		16-bit Int																																																			
			<table border="1"> <thead> <tr> <th>Options</th> <th>Reserved</th> <th>End Lim Sw</th> <th>Decel Lmt Sw</th> <th>Unipolar Ref</th> <th>Rev Disable</th> <th>Bipolar Ref</th> <th>Scale Ref</th> <th>Manual Ref</th> <th>Preset Auto</th> <th>Trim Speed</th> <th>Trim Ramp</th> <th>MicroPsnMult</th> <th>Max Spd Lim</th> <th>Min Spd Lim</th> <th>Ref B Auto</th> <th>Ref A Auto</th> </tr> </thead> <tbody> <tr> <td>Default</td> <td>x</td> <td>0</td> <td>0</td> <td>0</td> <td>0</td> <td>0</td> <td>0</td> <td>0</td> <td>0</td> <td>0</td> <td>0</td> <td>0</td> <td>0</td> <td>0</td> <td>0</td> <td>0</td> </tr> <tr> <td>Bit</td> <td>15</td> <td>14</td> <td>13</td> <td>12</td> <td>11</td> <td>10</td> <td>9</td> <td>8</td> <td>7</td> <td>6</td> <td>5</td> <td>4</td> <td>3</td> <td>2</td> <td>1</td> <td>0</td> </tr> </tbody> </table>	Options	Reserved	End Lim Sw	Decel Lmt Sw	Unipolar Ref	Rev Disable	Bipolar Ref	Scale Ref	Manual Ref	Preset Auto	Trim Speed	Trim Ramp	MicroPsnMult	Max Spd Lim	Min Spd Lim	Ref B Auto	Ref A Auto	Default	x	0	0	0	0	0	0	0	0	0	0	0	0	0	0	0	Bit	15	14	13	12	11	10	9	8	7	6	5	4	3	2	1	0		
		Options	Reserved	End Lim Sw	Decel Lmt Sw	Unipolar Ref	Rev Disable	Bipolar Ref	Scale Ref	Manual Ref	Preset Auto	Trim Speed	Trim Ramp	MicroPsnMult	Max Spd Lim	Min Spd Lim	Ref B Auto	Ref A Auto																																						
		Default	x	0	0	0	0	0	0	0	0	0	0	0	0	0	0	0																																						
		Bit	15	14	13	12	11	10	9	8	7	6	5	4	3	2	1	0																																						
		<b>A</b>	1381	<b>[TestPoint Sel]</b> Selects the function whose value is displayed in [TestPoint Data]. These are internal values that are not accessible through any other parameters. Typically, these are internal drive variables and registers. See Testpoint Codes and Functions on page 233 for more information. Note: Max value changed from 574 for firmware revision 7.001.	Default: 566 Min/Max: 566 / 585	16-bit Int																																																		
		<b>A</b>	1382	<b>[TestPoint Data]</b> The present value of the function selected in Par 1381 [Testpoint Sel].	Default: Read Only Min/Max: -2 <sup>31</sup> / 2 <sup>31</sup> - 1	16-bit Int																																																		
		<b>A</b>	1384	<b>[TaskLoad 1 ms]</b> The load percentage of the 1 ms task in the firmware.	Default: Read Only Min/Max: 0.00 / 100.00	Real																																																		
<b>A</b>	1385	<b>[TaskLoad 2 ms]</b> The load percentage of the 2 ms task in the firmware.	Default: Read Only Min/Max: 0.00 / 100.00	Real																																																				
<b>A</b>	1386	<b>[TaskLoad 8 ms]</b> The load percentage of the 8 ms task in the firmware.	Default: Read Only Min/Max: 0.00 / 100.00	Real																																																				
	1402	<b>[Last Stop Source]</b> Displays the source that initiated the most recent stop sequence.	Default: Read Only Options: <ul style="list-style-type: none"> <li>0 = "Pwr Removed"</li> <li>1 - 5 = "DPI Port 1-5"</li> <li>6 = "Reserved"</li> <li>7 = "Digital In"</li> <li>8 = "Fault"</li> <li>9 = "Not Enabled"</li> <li>10 = "Reserved"</li> <li>11 = "Jog"</li> <li>12 = "Selftune"</li> <li>13 = "Reserved"</li> </ul>	16-bit Int																																																				

File	Group	No.	Parameter Name & Description <small>See page 117 for symbol descriptions</small>	Values	Data Type	Related																																																			
UTILITY	Diagnostics	1403	<b>[Start Inhibits]</b> Displays the inputs currently preventing the drive from starting. For each bit, 1=Inhibit condition true and 0=Inhibit condition false.																																																						
		<table border="1"> <thead> <tr> <th>Options</th> <th>Reserved</th> <th>Reserved</th> <th>DPI Port 5</th> <th>DPI Port 4</th> <th>DPI Port 3</th> <th>DPI Port 2</th> <th>DPI Port 1</th> <th>Digital In</th> <th>Reserved</th> <th>Startup Actv</th> <th>Reserved</th> <th>Stop Assertd</th> <th>Reserved</th> <th>Enable</th> <th>Type 2 Alarm</th> <th>Fault</th> </tr> </thead> <tbody> <tr> <td>Default</td> <td>x</td> <td>x</td> <td>x</td> <td>0</td> <td>0</td> <td>0</td> <td>0</td> <td>0</td> <td>x</td> <td>0</td> <td>0</td> <td>1</td> <td>x</td> <td>0</td> <td>0</td> <td>0</td> </tr> <tr> <td>Bit</td> <td>15</td> <td>14</td> <td>13</td> <td>12</td> <td>11</td> <td>10</td> <td>9</td> <td>8</td> <td>7</td> <td>6</td> <td>5</td> <td>4</td> <td>3</td> <td>2</td> <td>1</td> <td>0</td> </tr> </tbody> </table>			Options	Reserved	Reserved	DPI Port 5	DPI Port 4	DPI Port 3	DPI Port 2	DPI Port 1	Digital In	Reserved	Startup Actv	Reserved	Stop Assertd	Reserved	Enable	Type 2 Alarm	Fault	Default	x	x	x	0	0	0	0	0	x	0	0	1	x	0	0	0	Bit	15	14	13	12	11	10	9	8	7	6	5	4	3	2	1	0		
	Options	Reserved	Reserved	DPI Port 5	DPI Port 4	DPI Port 3	DPI Port 2	DPI Port 1	Digital In	Reserved	Startup Actv	Reserved	Stop Assertd	Reserved	Enable	Type 2 Alarm	Fault																																								
	Default	x	x	x	0	0	0	0	0	x	0	0	1	x	0	0	0																																								
	Bit	15	14	13	12	11	10	9	8	7	6	5	4	3	2	1	0																																								
	263	 <b>[Clear Fault Que]</b> Allows you to clear the fault queue. See Chapter 4 Troubleshooting on page 219 for information on clearing the fault queue.	Default: Options:	0 = "Ready" 0 = "Ready" 1 = "Clr Flt Que"	16-bit Int																																																				
	1347	<b>[Fault Clear]</b> Allows you to reset drive faults and/or clear the fault queue.	Default: Options:	0 = "Ready" 0 = "Ready" 1 = "Clear Faults" 2 = "Clr Flt Que"	16-bit Int																																																				
	1348	<b>[Fault Clr Mode]</b> Enables/Disables a fault reset (clear faults) attempt from any source. This does not apply to fault codes which are cleared indirectly via other actions.	Default: Options:	1 = "Enabled" 0 = "Disabled" 1 = "Enabled"	16-bit Int																																																				
	1349	<b>[Status1 at Fault]</b> Captures and displays Par 381 [Drive Status 1] bit pattern at the time of the last fault. 0=Condition False, 1=Condition True.				381																																																			
	<table border="1"> <thead> <tr> <th>Options</th> <th>Spd Ref ID 3</th> <th>Spd Ref ID 2</th> <th>Spd Ref ID 1</th> <th>Spd Ref ID 0</th> <th>Local ID 2</th> <th>Local ID 1</th> <th>Local ID 0</th> <th>At Speed</th> <th>Faulted</th> <th>Alarm</th> <th>Decelerating</th> <th>Accelerating</th> <th>Actual Dir</th> <th>Command Dir</th> <th>Active</th> <th>Ready</th> </tr> </thead> <tbody> <tr> <td>Default</td> <td>0</td> <td>0</td> <td>0</td> <td>0</td> <td>1</td> <td>1</td> <td>1</td> <td>0</td> <td>1</td> <td>0</td> <td>0</td> <td>0</td> <td>1</td> <td>1</td> <td>0</td> <td>0</td> </tr> <tr> <td>Bit</td> <td>15</td> <td>14</td> <td>13</td> <td>12</td> <td>11</td> <td>10</td> <td>9</td> <td>8</td> <td>7</td> <td>6</td> <td>5</td> <td>4</td> <td>3</td> <td>2</td> <td>1</td> <td>0</td> </tr> </tbody> </table>			Options	Spd Ref ID 3	Spd Ref ID 2	Spd Ref ID 1	Spd Ref ID 0	Local ID 2	Local ID 1	Local ID 0	At Speed	Faulted	Alarm	Decelerating	Accelerating	Actual Dir	Command Dir	Active	Ready	Default	0	0	0	0	1	1	1	0	1	0	0	0	1	1	0	0	Bit	15	14	13	12	11	10	9	8	7	6	5	4	3	2	1	0			
Options	Spd Ref ID 3	Spd Ref ID 2	Spd Ref ID 1	Spd Ref ID 0	Local ID 2	Local ID 1	Local ID 0	At Speed	Faulted	Alarm	Decelerating	Accelerating	Actual Dir	Command Dir	Active	Ready																																									
Default	0	0	0	0	1	1	1	0	1	0	0	0	1	1	0	0																																									
Bit	15	14	13	12	11	10	9	8	7	6	5	4	3	2	1	0																																									
Faults	1350	<b>[Status2 at Fault]</b> Captures and displays Par 382 [Drive Status 2] bit pattern at the time of the last fault. 0=Condition False, 1=Condition True.				382																																																			
<table border="1"> <thead> <tr> <th>Options</th> <th>Reserved</th> <th>Reserved</th> <th>Reserved</th> <th>Reserved</th> <th>Reserved</th> <th>Reserved</th> <th>Reserved</th> <th>Reserved</th> <th>Reserved</th> <th>Auto Tuning</th> <th>Curr Limit</th> <th>Stopping</th> <th>Jogging</th> <th>Running</th> <th>Active</th> <th>Ready</th> </tr> </thead> <tbody> <tr> <td>Default</td> <td>x</td> <td>x</td> <td>x</td> <td>x</td> <td>x</td> <td>x</td> <td>x</td> <td>x</td> <td>x</td> <td>0</td> <td>0</td> <td>0</td> <td>1</td> <td>1</td> <td>0</td> <td>0</td> </tr> <tr> <td>Bit</td> <td>15</td> <td>14</td> <td>13</td> <td>12</td> <td>11</td> <td>10</td> <td>9</td> <td>8</td> <td>7</td> <td>6</td> <td>5</td> <td>4</td> <td>3</td> <td>2</td> <td>1</td> <td>0</td> </tr> </tbody> </table>			Options	Reserved	Reserved	Reserved	Reserved	Reserved	Reserved	Reserved	Reserved	Reserved	Auto Tuning	Curr Limit	Stopping	Jogging	Running	Active	Ready	Default	x	x	x	x	x	x	x	x	x	0	0	0	1	1	0	0	Bit	15	14	13	12	11	10	9	8	7	6	5	4	3	2	1	0				
Options	Reserved	Reserved	Reserved	Reserved	Reserved	Reserved	Reserved	Reserved	Reserved	Auto Tuning	Curr Limit	Stopping	Jogging	Running	Active	Ready																																									
Default	x	x	x	x	x	x	x	x	x	0	0	0	1	1	0	0																																									
Bit	15	14	13	12	11	10	9	8	7	6	5	4	3	2	1	0																																									
1351	<b>[Fault 1 Code]</b>	Default:	Read Only	16-bit Int																																																					
1352	<b>[Fault 2 Code]</b>	Min/Max:	0 / 32768																																																						
1353	<b>[Fault 3 Code]</b>																																																								
1354	<b>[Fault 4 Code]</b>																																																								
1355	<b>[Fault 5 Code]</b>																																																								
1356	<b>[Fault 6 Code]</b>																																																								
1357	<b>[Fault 7 Code]</b>																																																								
1358	<b>[Fault 8 Code]</b>																																																								
1359	<b>[Fault 9 Code]</b>																																																								
1360	<b>[Fault 10 Code]</b>																																																								
		A code that represents the fault that tripped the drive. The codes will appear in these parameters in the order they occur (i.e., [Fault 1 Code] = the most recent fault). See Fault Descriptions on page 222 for a list of possible codes. Note: Par 1351 [Fault 1 Code] is accessible via the Basic Parameter view.																																																							

File	Group	No.	Parameter Name & Description See page 117 for symbol descriptions	Values	Data Type	Related
UTILITY	Faults	1361	[Fault 1 Time]	Default:	Read Only	Real
		1362	[Fault 2 Time]	Min/Max:	0.000 / 134000000.000	
		1363	[Fault 3 Time]	Units:	hr.	
		1364	[Fault 4 Time]			
		1365	[Fault 5 Time]			
		1366	[Fault 6 Time]			
		1367	[Fault 7 Time]			
		1368	[Fault 8 Time]			
		1369	[Fault 9 Time]			
		1370	[Fault 10 Time]			
		The time between initial drive power up and the occurrence of the associated trip fault.				
	1371	[Fault Arm Amps]	Captures and displays the armature current (as a percentage of rated current) at the time of the last fault.	Default: Min/Max: Units:	Read Only -/+200 %	16-bit Int
	1372	[Fault Speed]	Captures and displays the output speed (rpm) of the drive at the time of the last fault.	Default: Min/Max: Units:	Read Only - / +8192 rpm	16-bit Int
	1373	[Fault Field Amps]	Captures and displays the field current (as a percentage of rated current) at the time of the last fault.	Default: Min/Max: Units:	Read Only 0.00 / 100.00 %	Real
	1374	[Fault Voltage]	Captures and displays the armature voltage at the time of the last fault.	Default: Min/Max: Units:	Read Only - / + 999.00 Vdc	Real
	203	 [OverVolt Flt Cfg]	Determines the response of the drive to an overvoltage condition (F5 "Arm Overvoltage"). Note: See <a href="#">Chapter 4</a> for a list of alarm and fault descriptions.	Default: Options:	2 = "Fault" 0 = "Ignore" 1 = "Alarm" 2 = "Fault"	16-bit Int
		 <b>ATTENTION:</b> Setting this parameter to 0 "Ignore" or 1 "Alarm", could result in motor and/or equipment damage. If set to "Ignore" or "Alarm", it is strongly recommended that an external means of protecting against this condition be provided.				
	354	 [Aux Inp Flt Cfg]	Determines the response of the drive to an external fault condition (F2 "Auxiliary Input"), i.e., no voltage at the digital input terminal assigned to [Digital Inx Sel] with a value of 14 "Aux Fault". Notes: See <a href="#">Chapter 4</a> for a list of alarm and fault descriptions. Option 3 was changed from "Quick Stop" to "Fast Stop" for firmware revision 2.001.	Default: Options:	2 = "Fault" 1 = "Alarm" 2 = "Fault" 3 = "Fast Stop" 4 = "Normal Stop" 5 = "CurrLim Stop"	16-bit Int
		 <b>ATTENTION:</b> Setting this parameter to 1 "Alarm", could result in motor and/or equipment damage. If set to "Alarm", it is strongly recommended that an external means of protecting against this condition be provided.				
	365	 [OverTemp Flt Cfg]	Determines the response of the drive to a motor over temperature condition (F16 "Motor Over Temp"). Notes: See <a href="#">Chapter 4</a> for a list of alarm and fault descriptions. Option 3 was changed from "Quick Stop" for firmware revision 2.001.	Default: Options:	2 = "Fault" 0 = "Ignore" 1 = "Alarm" 2 = "Fault" 3 = "Fast Stop" 4 = "Normal Stop" 5 = "CurrLim Stop"	16-bit Int
		 <b>ATTENTION:</b> Setting this parameter to 0 "Ignore" or 1 "Alarm", could result in motor and/or equipment damage. If set to "Ignore" or "Alarm", it is strongly recommended that an external means of protecting against this condition be provided.				

File	Group	No.	Parameter Name & Description <small>See page 117 for symbol descriptions</small>	Values	Data Type	Related	
UTILITY	Alarms	409	<b>[SSC Threshold]</b> Specifies the amount of time invalid fiber communication packets can be received before a fault is generated (2 ms per packet). Note: This parameter was added for firmware revision 7.001.	Default: 50 Min/Max: 0 / 250 Units: ms	16-bit Int		
		470	<b>[UnderVlt Flt Dly]</b> Configures the length of time that an AC Line undervoltage condition can persist before an AC undervoltage fault (F4) is activated. The condition must persist for the entire delay time or the delay timer is reset. Note: This parameter was added for firmware revision 6.001.	Default: 10 Min/Max: 0 / 100 Units: ms	16-bit Int		
		 <b>ATTENTION:</b> Setting this value incorrectly for the application could result in damage to the drive SCR(s) and/or fuses.					
		473	<b>[FldLoss Flt Cfg]</b> Determines the response of the drive to a field loss condition (F6 "Fld Current Loss"). If Par 497 [Field Reg Enable] is set to 0 "Disabled", set this parameter to 0 "Ignore". Note: See Chapter 4 for a list of alarm and fault descriptions.	Default: 2 = "Fault" Options: 0 = "Ignore", 1 = "Alarm", 2 = "Fault"	16-bit Int	497	
		 <b>ATTENTION:</b> Setting this parameter to 0 "Ignore" or 1 "Alarm", could result in motor and/or equipment damage. If set to "Ignore" or "Alarm", it is strongly recommended that an external means of protecting against this condition be provided.					
		475	<b>[FldLoss Flt Dly]</b> Configures the length of time that the measured field current feedback can be less than one half of Par 468 [Min Fld Curr Pct] before a field loss condition (fault or alarm) is activated. The condition must persist for the entire delay time or the delay timer is reset. Note that this parameter is not used when armature voltage speed feedback is configured. Note: This parameter was added for firmware revision 6.001.	Default: 500 Min/Max: 0 / 5000 Units: ms	16-bit Int	468	
		478	<b>[Spd Loss Flt Cfg]</b> Determines the response of the drive to a speed feedback loss condition. Note: See Chapter 4 for a list of fault and alarm descriptions.	Default: 2 = "Fault" Options: 1 = "Alarm", 2 = "Fault"	16-bit Int	458	
		 <b>ATTENTION:</b> Par 478 [Spd Loss Flt Cfg] must be set to 1 "Fault" if Par 458 [SpdReg FB Bypass] is set to 0 "Disabled". Failure to observe this precaution could result in high motor speeds, equipment damage, and/or bodily injury if a "Spd Fdbk Loss" alarm condition were encountered.					
479	<b>[MtrOvrd Flt Cfg]</b> Determines the response of the drive to a motor overload condition (F7 "Motor Overload"). Notes: See Chapter 4 for a list of fault and alarm descriptions. This parameter was added for firmware revision 3.001.	Default: 2 = "Fault" Options: 0 = "Ignore", 1 = "Alarm", 2 = "Fault"	16-bit Int	376, 1290			
 <b>ATTENTION:</b> Setting Par 479 [MtrOvrd Flt Cfg] to 0 "Ignore" or 1 "Alarm", could result in motor and/or equipment damage. Verify that the motor is properly sized for the application and that a separate device is installed that monitors for and signals a motor overload condition.							
481	<b>[UnderVlt Thresh]</b> The AC input voltage level below which an undervoltage fault (F4 "AC Undervoltage") will be detected. A typical value is 85% of the nominal AC line voltage (Par 466 [AC Line Voltage]). This fault can only occur while the drive is running. Note: See Chapter 4 for a list of fault descriptions.	Default: 230 Min/Max: 0 / 1000 Units: Vac	16-bit Int				

File	Group	No.	Parameter Name & Description <small>See page 117 for symbol descriptions</small>	Values	Data Type	Related																																																			
UTILITY	Alarms	584 	<b>[OverCurrent Thr]</b> Value at which an overcurrent condition (F13 "Overcurrent") will be detected. Note: See <a href="#">Chapter 4</a> for a list of fault descriptions.	Default: 175 Min/Max: 0 / 250 Units: %	16-bit Int																																																				
		585 	<b>[Overspeed Val]</b> Speed value (rpm) at which an "Overspeed" fault (F25) will occur. Notes: Typically set at 110% of Par 162 [Max Feedback Spd]. See <a href="#">Chapter 4</a> for a list of fault and alarm descriptions. This parameter was added for firmware revision 3.001.	Default: 1925 Min/Max: 0 / 7800 Units: rpm	16-bit Int	162																																																			
		 <b>ATTENTION:</b> Verify that you have correctly set this parameter appropriately for your application. Incorrectly setting this parameter may cause a hazard of personal injury and/or equipment damage.																																																							
		1380	<b>[Drive Alarm 1]</b> Alarm conditions that currently exist in the drive. For each bit, 1 = condition true, and 0 = condition false. Bit 0 "DigInCfctA" - Digital input functions are in conflict. Bit 1 "DigInCfctB" - A digital Start input has been configured without a Stop input or other functions are in conflict. Bit 2 "DigInCfctC" - More than one physical input has been configured for the same input function. Bit 3 "BipolarCfct" - Parameter 1322 [Direction Mode] is set to "Bipolar" or "Reverse Dis" and one or more of the following digital input functions is configured: "Fwd/Reverse," "Run Forward," "Run Reverse," "Jog Forward" or "Jog Reverse." Bit 4 "Ref Cfct" - Multiple speed or position references are configured. Bit 5 "CntactrCfct" - Contactor input functions are in conflict. Bit 6 "FB Cfg Cfct" - A speed feedback configuration error has occurred or is being provided by multiple sources. Bit 7 "Overvoltage" - There is an overvoltage on the armature circuit. Bit 8 "Over Temp" - The motor has exceeded its temperature rating [as signaled by the thermistor (PTC) or thermal switch connected to the drive terminals 78 and 79]. Bit 9 "Aux Input" - An auxiliary input interlock is open or a voltage (15...30 V) or reference signal is missing for the digital input set to 14 "Aux Fault" (only updates if Par 354 [Aux Inp Flt Cfg] is set to 1 "Alarm"). Bit 10 "Field Loss" - The field current is too low. Bit 11 "SpdFdbk Loss" - The drive is not receiving a speed feedback signal. Bit 12 "PwrUp Start" - Indicates that the drive is starting or has automatically resumed running at commanded speed after drive input power was restored. Bit 13 "Mtr Overload" - Indicates when the Motor Overload alarm level has been reached. Bit 14 "FldCf Cfg Cfct" - Indicates a field configuration conflict. Bit 15 "Spd Fdbk Err" - Indicates an encoder or resolver error. Notes: See <a href="#">Chapter 4</a> - Troubleshooting on page 219 for more information on faults/alarms. The name of bit 11 was changed from "Encoder Loss" and bits 13 and 14 were added for firmware revision 3.001. The name of bit 4 "AnalogCfct", bit 6 "Encoder Cfct", and bit 11 "Feedback Loss" were changed and bit 15 was added for firmware revision 5.002.		16-bit Int	1322																																																			
			<table border="1"> <thead> <tr> <th>Options</th> <th>Spd Fdbk Err</th> <th>FldCf Cfg Cfct</th> <th>Mtr Overload</th> <th>PwrUp Start</th> <th>SpdFdbk Loss</th> <th>Field Loss</th> <th>Aux Input</th> <th>Over Temp</th> <th>Overvoltage</th> <th>FB Cfg Cfct</th> <th>CntactrCfct</th> <th>Ref Cfct</th> <th>BipolarCfct</th> <th>DigInCfctC</th> <th>DigInCfctB</th> <th>DigInCfctA</th> </tr> </thead> <tbody> <tr> <td>Default</td> <td>0</td> <td>0</td> <td>0</td> <td>0</td> <td>0</td> <td>0</td> <td>0</td> <td>0</td> <td>0</td> <td>0</td> <td>0</td> <td>0</td> <td>0</td> <td>0</td> <td>0</td> <td>0</td> </tr> <tr> <td>Bit</td> <td>15</td> <td>14</td> <td>13</td> <td>12</td> <td>11</td> <td>10</td> <td>9</td> <td>8</td> <td>7</td> <td>6</td> <td>5</td> <td>4</td> <td>3</td> <td>2</td> <td>1</td> <td>0</td> </tr> </tbody> </table>	Options	Spd Fdbk Err	FldCf Cfg Cfct	Mtr Overload	PwrUp Start	SpdFdbk Loss	Field Loss	Aux Input	Over Temp	Overvoltage	FB Cfg Cfct	CntactrCfct	Ref Cfct	BipolarCfct	DigInCfctC	DigInCfctB	DigInCfctA	Default	0	0	0	0	0	0	0	0	0	0	0	0	0	0	0	0	Bit	15	14	13	12	11	10	9	8	7	6	5	4	3	2	1	0			
Options	Spd Fdbk Err	FldCf Cfg Cfct	Mtr Overload	PwrUp Start	SpdFdbk Loss	Field Loss	Aux Input	Over Temp	Overvoltage	FB Cfg Cfct	CntactrCfct	Ref Cfct	BipolarCfct	DigInCfctC	DigInCfctB	DigInCfctA																																									
Default	0	0	0	0	0	0	0	0	0	0	0	0	0	0	0	0																																									
Bit	15	14	13	12	11	10	9	8	7	6	5	4	3	2	1	0																																									

File	Group	No.	Parameter Name & Description <small>See page 117 for symbol descriptions</small>	Values	Data Type	Related																																																						
<b>UTILITY</b>	<b>Alarms</b>	1394	<p><b>[Drive Alarm 2]</b>                      Alarm conditions that currently exist in the drive. For each bit, 1 = condition true, and 0 = condition false.                      Bit 0 "BrakeSlipped" - The torque prove function encountered a brake slip condition.                      Bit 1 "TrqProvCflct" - The torque prove function is not properly configured.                      Bit 2 "TP Encls Cfg" - The torque prove function encountered an encoderless configuration conflict.                      Bit 3 "OpenSCR Trip" - An open SCR trip level has been reached.                      Notes: See <a href="#">Chapter 4 - Troubleshooting</a> on page 219 for more information on faults/alarms. This parameter was added for firmware revision 6.001.</p> <table border="1" style="width: 100%; border-collapse: collapse;"> <thead> <tr> <th>Options</th> <th>Reserved</th> <th>Reserved</th> <th>Reserved</th> <th>Reserved</th> <th>Reserved</th> <th>Reserved</th> <th>Reserved</th> <th>Reserved</th> <th>Reserved</th> <th>Reserved</th> <th>Reserved</th> <th>Reserved</th> <th>Reserved</th> <th>OpenSCR Trip</th> <th>TP Encls Cfg</th> <th>TrqProvCflct</th> <th>BrakeSlipped</th> </tr> </thead> <tbody> <tr> <td>Default</td> <td>x</td> <td>x</td> <td>x</td> <td>x</td> <td>x</td> <td>x</td> <td>x</td> <td>x</td> <td>x</td> <td>x</td> <td>x</td> <td>x</td> <td>x</td> <td>0</td> <td>0</td> <td>0</td> <td>0</td> </tr> <tr> <td>Bit</td> <td>15</td> <td>14</td> <td>13</td> <td>12</td> <td>11</td> <td>10</td> <td>9</td> <td>8</td> <td>7</td> <td>6</td> <td>5</td> <td>4</td> <td>3</td> <td>2</td> <td>1</td> <td>0</td> <td></td> </tr> </tbody> </table>	Options	Reserved	Reserved	Reserved	Reserved	Reserved	Reserved	Reserved	Reserved	Reserved	Reserved	Reserved	Reserved	Reserved	OpenSCR Trip	TP Encls Cfg	TrqProvCflct	BrakeSlipped	Default	x	x	x	x	x	x	x	x	x	x	x	x	x	0	0	0	0	Bit	15	14	13	12	11	10	9	8	7	6	5	4	3	2	1	0			16-bit Int	
		Options	Reserved	Reserved	Reserved	Reserved	Reserved	Reserved	Reserved	Reserved	Reserved	Reserved	Reserved	Reserved	Reserved	OpenSCR Trip	TP Encls Cfg	TrqProvCflct	BrakeSlipped																																									
		Default	x	x	x	x	x	x	x	x	x	x	x	x	x	0	0	0	0																																									
		Bit	15	14	13	12	11	10	9	8	7	6	5	4	3	2	1	0																																										
		<b>User Defined</b>	<b>50</b> 		<p><b>[UsrDsplyMult0]</b>                      Numerator in the calculation for user-defined, drive speed display units.                      Note: This parameter is not used.</p>	Default: 1 Min/Max: 1 / 1073741823	32-bit Int																																																					
<b>51</b> 				<p><b>[UsrDsplyDiv0]</b>                      Denominator in the calculation for user-defined, drive speed display units.                      Note: This parameter is not used.</p>	Default: 1 Min/Max: 1 / 1073741823	32-bit Int																																																						
	<b>53</b> 				<p><b>[UsrValMult1]</b>                      Numerator in the calculation for scaling the user-defined, drive speed display units.                      Note: This parameter is not used.</p>	Default: 1 Min/Max: 1 / 32767	16-bit Int																																																					
				<b>54</b> 	<p><b>[UsrValDiv1]</b>                      Denominator in the calculation for scaling the user-defined, drive speed display units.                      Note: This parameter is not used.</p>	Default: 1 Min/Max: 1 / 32767	16-bit Int																																																					



File	Group	No.	Parameter Name & Description See <a href="#">page 117</a> for symbol descriptions	Values	Data Type	Related			
UTILITY	User Defined	503	[UserDefined0]	Default: 0	16-bit Int				
		504	[UserDefined1]	Min/Max: -32768/+32767					
		505	[UserDefined2]						
		506	[UserDefined3]						
		507	[UserDefined4]						
		508	[UserDefined5]						
		509	[UserDefined6]						
		510	[UserDefined7]						
		511	[UserDefined8]						
		512	[UserDefined9]						
		513	[UserDefined10]						
		514	[UserDefined11]						
		515	[UserDefined12]						
		516	[UserDefined13]						
		517	[UserDefined14]						
		518	[UserDefined15]						
			<b>A</b>	General use signed 16 bit variables used for data exchange. Note: Pars 503...506 can be assigned to analog inputs. The values of Pars 503, 504, and 507...509 can be assigned to an analog output.					
			<b>A</b>	<b>[UsrDefBitWrdA]</b> A bitmap of Pars 520 [UsrDefBitWrdA0] through 535 [UsrDefBitWrdA15]. With a parameter it is possible to read or write all of the bits inside a word. Example: <pre> [UsrDefBitWrdA0]      0 [UsrDefBitWrdA1]      1 = 2<sup>1</sup> = 2 [UsrDefBitWrdA2]      0 [UsrDefBitWrdA3]      0 [UsrDefBitWrdA4]      0 [UsrDefBitWrdA5]      1 = 2<sup>5</sup> = 32 [UsrDefBitWrdA6]      1 = 2<sup>6</sup> = 64 [UsrDefBitWrdA7]      0 [UsrDefBitWrdA8]      0 [UsrDefBitWrdA9]      0 [UsrDefBitWrdA10]     1 = 2<sup>10</sup> = 1024 [UsrDefBitWrdA11]     0 [UsrDefBitWrdA12]     1 = 2<sup>12</sup> = 4096 [UsrDefBitWrdA13]     0 [UsrDefBitWrdA14]     0 [UsrDefBitWrdA15]     0 [UsrDefBitWrdA] = 2 + 32 + 64 + 1024 + 4096 = 5218 </pre> Notes: The value of digital inputs 1...12 can be written to any of bits 0...7 ([UsrDefBitWrdA0]...[UsrDefBitWrdA7]) of this parameter. For example, to assign digital input 1 to bit 0 of this parameter, select option 37 "UsrDefined0" in parameter 133 [Digital In1 Sel].  The value of bits 0...7 of this parameter can be written to digital outputs 1...8, sequentially. In other words, when parameters 145 [Digital Out1 Sel]...152 [Digital Out8 Sel] are assigned option 11 "UserDefinedA", bit 0 of this parameter is written to digital output 1, bit 1 is written to digital output 2, bit 2 is written to digital output 3, etc.  Bits 14 and 15 of this parameter are written to relay outputs 1 and 2, respectively, when parameters 1392 [Relay Out 1 Sel] and 629 [Relay Out 2 Sel] are assigned option 11 "UserDefinedA".			Default: 0 Min/Max: 0 / 65535	16-bit Int	520 - 535

File	Group	No.	Parameter Name & Description See page 117 for symbol descriptions	Values	Data Type	Related			
UTILITY	User Defined	520	[UsrDefBitWrdA0]	Default: 0	16-bit Int	519			
		521	[UsrDefBitWrdA1]	Min/Max: 0 / 1					
		522	[UsrDefBitWrdA2]						
		523	[UsrDefBitWrdA3]						
		524	[UsrDefBitWrdA4]						
		525	[UsrDefBitWrdA5]						
		526	[UsrDefBitWrdA6]						
		527	[UsrDefBitWrdA7]						
		528	[UsrDefBitWrdA8]						
		529	[UsrDefBitWrdA9]						
		530	[UsrDefBitWrdA10]						
		531	[UsrDefBitWrdA11]						
		532	[UsrDefBitWrdA12]						
		533	[UsrDefBitWrdA13]						
		534	[UsrDefBitWrdA14]						
		535	[UsrDefBitWrdA15]						
			<b>A</b>	Bit variables. The individual "User Defined" bits can be read or written to. It is possible to process a word with Par 519 [UsrDefBitWrdA] (see example). Note: You can read bits 0...7 of a digital input with Par 519 [UsrDefBitWrdA] and write all of the bits associated with [UsrDefBitWrdA] to a digital output.					
		536	[UsrDefBitWrdB]	Default: 0			16-bit Int	537 - 552	
			<b>A</b>	A bitmap of Pars 537 [UsrDefBitWrdB0] through 552 [UsrDefBitWrdB15]. With a parameter it is possible to read or write all of the bits inside a word. Example: [UsrDefBitWrdB0] 0 [UsrDefBitWrdB1] 1 = 2 <sup>1</sup> = 2 [UsrDefBitWrdB2] 0 [UsrDefBitWrdB3] 0 [UsrDefBitWrdB4] 0 [UsrDefBitWrdB5] 1 = 2 <sup>5</sup> = 32 [UsrDefBitWrdB6] 1 = 2 <sup>6</sup> = 64 [UsrDefBitWrdB7] 0 [UsrDefBitWrdB8] 0 [UsrDefBitWrdB9] 0 [UsrDefBitWrdB10] 1 = 2 <sup>10</sup> = 1024 [UsrDefBitWrdB11] 0 [UsrDefBitWrdB12] 1 = 2 <sup>12</sup> = 4096 [UsrDefBitWrdB13] 0 [UsrDefBitWrdB14] 0 [UsrDefBitWrdB15] 0 [UsrDefBitWrdB] = 2 + 32 + 64 + 1024 + 4096 = 5218  Notes: The value of bits 0...7 of this parameter can be written to digital outputs 1...8, sequentially. In other words, when parameters 145 [Digital Out1 Sel]...152 [Digital Out8 Sel] are assigned option 12 "UserDefinedB", bit 0 of this parameter is written to digital output 1, bit 1 is written to digital output 2, bit 2 is written to digital output 3, etc.  Bits 14 and 15 of this parameter are written to relay outputs 1 and 2, respectively, when parameters 1392 [Relay Out 1 Sel] and 629 [Relay Out 2 Sel] are assigned option 12 "UserDefinedB"					Min/Max: 0 / 65535

File	Group	No.	Parameter Name & Description <small>See page 117 for symbol descriptions</small>	Values	Data Type	Related
UTILITY	User Defined	537	[UsrDefBitWrdB0]	Default: 0	16-bit Int	536
		538	[UsrDefBitWrdB1]	Min/Max: 0 / 1		
		539	[UsrDefBitWrdB2]			
		540	[UsrDefBitWrdB3]			
		541	[UsrDefBitWrdB4]			
		542	[UsrDefBitWrdB5]			
		543	[UsrDefBitWrdB6]			
		544	[UsrDefBitWrdB7]			
		545	[UsrDefBitWrdB8]			
		546	[UsrDefBitWrdB9]			
		547	[UsrDefBitWrdB10]			
		548	[UsrDefBitWrdB11]			
		549	[UsrDefBitWrdB12]			
		550	[UsrDefBitWrdB13]			
		551	[UsrDefBitWrdB14]			
552	[UsrDefBitWrdB15]					
	<b>A</b>	Bit variables. The individual "User Defined" bits can be read or written to. It is possible to process a word with Par 536 [UsrDefBitWrdB]. See the example in Par 536 [UsrDefBitWrdB]. Note: You can read bits 0 . . . 7 of a digital input with Par 536 [UsrDefBitWrdB] and write all of the bits associated with [UsrDefBitWrdB] to a digital output.				

## Communications File

File	Group	No.	Parameter Name & Description <small>See page 117 for symbol descriptions</small>	Values	Data Type	Related	
COMMUNICATIONS	Comm Control	589	[DPI Baud Rate] Shows the data transfer rate for attached drive peripherals. "1" - 500 kbps	Default: Read Only Min/Max: 1 / 1	16-bit Int		
		590	[DPI Port Sel] Selects which DPI port reference value (unscaled) will appear in Par 1343 [DPI Port Value].	Default: 1 "DPI Port 1" Options: 1 = "DPI Port 1" 2 = "DPI Port 2" 3 = "DPI Port 3" 4 = "DPI Port 4" 5 = "DPI Port 5"	16-bit Int	1343	
		1321	[DPI Fdbk Select] Selects the feedback variable and DPI units displayed on the feedback line of the HIM. • 0 "Speed" = Speed feedback units are in rpm • 1 "Current" = Current feedback units are in percent (%)	Default: 0 = "Speed" Options: 0 = "Speed" 1 = "Current"	16-bit Int		
		1343	[DPI Port Value] Unscaled value of the DPI reference selected in Par 590 [DPI Port Sel].	Default: Read Only Min/Max: -/+32767	16-bit Int	590	
	Masks & Owners	591	[Logic Mask] Determines which ports can control the drive. If the bit for a port is set to "0," the port will have no control functions except for stop. 0 = Control Masked, 1 = Control Permitted, x = Reserved.				
		592	[Start Mask] Controls which adapters can issue start commands.	See [Logic Mask]			




Options	Reserved	Reserved	Reserved	Reserved	Reserved	Reserved	Reserved	Reserved	Reserved	Reserved	DPI Port 5	DPI Port 4	DPI Port 3	DPI Port 2	DPI Port 1	Digital In
Default	x	x	x	x	x	x	x	x	x	x	1	1	1	1	1	1
Bit	15	14	13	12	11	10	9	8	7	6	5	4	3	2	1	0

File	Group	No.	Parameter Name & Description <small>See page 117 for symbol descriptions</small>	Values	Data Type	Related																																																			
COMMUNICATIONS	Masks & Owners	593	<b>[Jog Mask]</b> Controls which adapters can issue jog commands.		See [Logic Mask]																																																				
		594	<b>[Direction Mask]</b> Controls which adapters can issue forward/reverse direction commands.		See [Logic Mask]																																																				
		595	<b>[Reference Mask]</b> <b>Controls which adapters can select a manual reference.</b>		See [Logic Mask]																																																				
		596	<b>[Accel Mask]</b> Controls which adapters can select the acceleration ramp rates (Pars 660 [Accel Time 1] and 24 [Accel Time 2]) of the drive.		See [Logic Mask]	24, 660																																																			
		597	<b>[Fault Clr Mask]</b> Controls which adapters can clear a fault.		See [Logic Mask]																																																				
		598	<b>[MOP Mask]</b> Controls which adapters can issue MOP commands to the drive.		See [Logic Mask]																																																				
		599	<b>[Local Mask]</b> Controls which adapters are allowed to take exclusive control of drive logic commands (except stop). Exclusive "local" control can only be taken while the drive is stopped.		See [Logic Mask]																																																				
		600	<b>[Stop Owner]</b> The adapters that are presently issuing a valid stop command. 0 = No Command, 1 = Issuing Command, x = Reserved.  <table border="1" style="width: 100%; border-collapse: collapse;"> <thead> <tr> <th>Options</th> <th>Reserved</th> <th>Reserved</th> <th>Reserved</th> <th>Reserved</th> <th>Reserved</th> <th>Reserved</th> <th>Reserved</th> <th>Reserved</th> <th>Reserved</th> <th>Reserved</th> <th>DPI Port 5</th> <th>DPI Port 4</th> <th>DPI Port 3</th> <th>DPI Port 2</th> <th>DPI Port 1</th> <th>Digital In</th> </tr> </thead> <tbody> <tr> <td>Default</td> <td>x</td> <td>x</td> <td>x</td> <td>x</td> <td>x</td> <td>x</td> <td>x</td> <td>x</td> <td>x</td> <td>x</td> <td>0</td> <td>0</td> <td>0</td> <td>0</td> <td>0</td> <td>0</td> </tr> <tr> <td>Bit</td> <td>15</td> <td>14</td> <td>13</td> <td>12</td> <td>11</td> <td>10</td> <td>9</td> <td>8</td> <td>7</td> <td>6</td> <td>5</td> <td>4</td> <td>3</td> <td>2</td> <td>1</td> <td>0</td> </tr> </tbody> </table>	Options	Reserved	Reserved	Reserved	Reserved	Reserved	Reserved	Reserved	Reserved	Reserved	Reserved	DPI Port 5	DPI Port 4	DPI Port 3	DPI Port 2	DPI Port 1	Digital In	Default	x	x	x	x	x	x	x	x	x	x	0	0	0	0	0	0	Bit	15	14	13	12	11	10	9	8	7	6	5	4	3	2	1	0			
		Options	Reserved	Reserved	Reserved	Reserved	Reserved	Reserved	Reserved	Reserved	Reserved	Reserved	DPI Port 5	DPI Port 4	DPI Port 3	DPI Port 2	DPI Port 1	Digital In																																							
		Default	x	x	x	x	x	x	x	x	x	x	0	0	0	0	0	0																																							
		Bit	15	14	13	12	11	10	9	8	7	6	5	4	3	2	1	0																																							
		601	<b>[Start Owner]</b> The adapters that are presently issuing a valid start command.		See [Stop Owner]																																																				
		602	<b>[Jog Owner]</b> The adapters that are presently issuing a valid jog command.		See [Stop Owner]																																																				
		603	<b>[Direction Owner]</b> The adapter that currently has exclusive control of direction changes.		See [Stop Owner]																																																				
		604	<b>[Reference Owner]</b> The adapter that has the exclusive control of the reference source selection.		See [Stop Owner]																																																				
605	<b>[Accel Owner]</b> The adapter that has exclusive control of the acceleration ramp rate (Pars 660 [Accel Time 1] and 24 [Accel Time 2]) for the drive.		See [Stop Owner]	24, 660																																																					
606	<b>[Fault Clr Owner]</b> Adapter that is presently clearing a fault.		See [Stop Owner]																																																						
607	<b>[MOP Owner]</b> Adapters that are currently issuing increases or decreases in MOP referenced.		See [Stop Owner]																																																						
608	<b>[Local Owner]</b> Adapter that has requested exclusive control of all drive logic functions. If an adapter is in local lockout, all other functions (except stop) on all other adapters are locked out and non-functional. Local control can only be obtained when the drive is not running.		See [Stop Owner]																																																						
609	<b>[Decel Owner]</b> The adapter that has exclusive control of the deceleration ramp rate (Pars 662 [Decel Time 1] and 32 [Decel Time 2]) for the drive.		See [Stop Owner]	32, 662																																																					





File	Group	No.	Parameter Name & Description <small>See page 117 for symbol descriptions</small>	Values	Data Type	Related	
COMMUNICATIONS	Masks & Owners	631	<b>[Decel Mask]</b> Controls which adapters can select the deceleration ramp rate (Pars 662 [Decel Time 1] and 32 [Decel Time 2]) of the drive.	See [Logic Mask]		32, 662	
		610 611	<b>[Data In A1] – Link A Word 1</b> <b>[Data In A2] – Link A Word 2</b> Parameter number whose value will be written from a communications device data table. The number will not be updated until the drive is stopped. See your communications option manual for datalink information.	Default: 0 (0 = “Disabled”) Min/Max: 0 / 1410	16-bit Int		
	DataLinks	612 613	<b>[Data In B1] – Link B Word 1</b> <b>[Data In B2] – Link B Word 2</b>	See [Data In A1] – Link A Word 1.	16-bit Int		
			614 615	<b>[Data In C1] – Link C Word 1</b> <b>[Data In C2] – Link C Word 2</b>	See [Data In A1] – Link A Word 1.	16-bit Int	
		616 617		<b>[Data In D1] – Link D Word 1</b> <b>[Data In D2] – Link D Word 2</b>	See [Data In A1] – Link A Word 1.	16-bit Int	
			618 619	<b>[Data Out A1] – Link A Word 1</b> <b>[Data Out A2] – Link A Word 2</b> Parameter number whose value will be written to a communications device data table.	Default: 0 (0 = “Disabled”) Min/Max: 0 / 1410	16-bit Int	
		620 621		<b>[Data Out B1] – Link B Word 1</b> <b>[Data Out B2] – Link B Word 2</b>	See [Data Out A1] – Link A Word 1.	16-bit Int	
			622 623	<b>[Data Out C1] – Link C Word 1</b> <b>[Data Out C2] – Link C Word 2</b>	See [Data Out A1] – Link A Word 1.	16-bit Int	
		624 625		<b>[Data Out D1] – Link D Word 1</b> <b>[Data Out D2] – Link D Word 2</b>	See [Data Out A1] – Link A Word 1.	16-bit Int	
			1319	<b>[Data In Val Sel]</b> Selects the Datalink parameter register to display in Par 1320 [Data In Sel Data].	Default: 610 Min/Max: 610 / 617	16-bit Int	1320
		1320		<b>[Data In SelData]</b> Displays the value selected in Par 1319 [Data In Val Sel].	Default: Read Only Min/Max: 0 / 2 <sup>31</sup>	32-bit Int	1319
		Security	591	<b>[Logic Mask]</b> Determines which ports can control the drive. If the bit for a port is set to “0,” the port will have no control functions except for stop. 0 = Control Masked, 1 = Control Permitted, x = Reserved.			
				1376	<b>[Logic Mask Act]</b> Indicates the status of the logic mask for the DPI ports. When bit 15 is set, network security is controlling the logic mask instead of Par 591 [Logic Mask]. 0 = Control Masked, 1 = Control Permitted, x = Reserved.	Read Only	

Options	Reserved	Reserved	Reserved	Reserved	Reserved	Reserved	Reserved	Reserved	Reserved	Reserved	DPI Port 5	DPI Port 4	DPI Port 3	DPI Port 2	DPI Port 1	Digital In
Default	x	x	x	x	x	x	x	x	x	x	1	1	1	1	1	1
Bit	15	14	13	12	11	10	9	8	7	6	5	4	3	2	1	0

Options	Security	Reserved	Reserved	Reserved	Reserved	Reserved	Reserved	Reserved	Reserved	Reserved	DPI Port 5	DPI Port 4	DPI Port 3	DPI Port 2	DPI Port 1	Digital In
Default	0	x	x	x	x	x	x	x	x	x	1	1	1	1	1	1
Bit	15	14	13	12	11	10	9	8	7	6	5	4	3	2	1	0

File	Group	No.	Parameter Name & Description <small>See page 117 for symbol descriptions</small>	Values	Data Type	Related													
COMMUNICATIONS	Security	1377	<b>[Write Mask Act]</b> The status of write access for the DPI ports. When bit 15 is set, network security is controlling the write mask instead of Par 1378 [Write Mask Cfg]. 0 = Read Only, 1 = Write Permitted, x = Reserved.	Read Only		1378													
			Options	Security	Reserved	Reserved	Reserved	Reserved	Reserved	Reserved	Reserved	Reserved	DPI Port 5	DPI Port 4	DPI Port 3	DPI Port 2	DPI Port 1	Reserved	
		Default	0	x	x	x	x	x	x	x	x	x	1	1	1	1	1	x	
		Bit	15	14	13	12	11	10	9	8	7	6	5	4	3	2	1	0	
		1378	<b>[Write Mask Cfg]</b> Enables/Disables parameter write access for the DPI ports. Masking of the Port that is writing to this parameter is prohibited. Changes to this parameter only become effective after power is cycled, the drive is reset, or bit 15 of [Write Mask Act] transitions from "1" to "0". 0 = Read Only, 1 = Write Permitted, x = Reserved.			1377													
			Options	Reserved	Reserved	Reserved	Reserved	Reserved	Reserved	Reserved	Reserved	Reserved	DPI Port 5	DPI Port 4	DPI Port 3	DPI Port 2	DPI Port 1	Reserved	
			Default	x	x	x	x	x	x	x	x	x	1	1	1	1	1	x	
			Bit	15	14	13	12	11	10	9	8	7	6	5	4	3	2	1	0
		1379	<b>[Port Mask Act]</b> Bits 0 . . . 5 indicate status for DPI port communication. Bit 15 indicates when security software is controlling the parameter. 0 = Not Active, 1 - Active, x - Reserved.	Read Only															
			Options	Security	Reserved	Reserved	Reserved	Reserved	Reserved	Reserved	Reserved	Reserved	DPI Port 5	DPI Port 4	DPI Port 3	DPI Port 2	DPI Port 1	Digital In	
			Default	0	x	x	x	x	x	x	x	x	1	1	1	1	1	1	
			Bit	15	14	13	12	11	10	9	8	7	6	5	4	3	2	1	0

# Input / Output File




File	Group	No.	Parameter Name & Description <small>See page 117 for symbol descriptions</small>	Values	Data Type	Related																											
INPUT / OUTPUT	Analog Inputs	70 75 80	 <p><b>[Anlg In1 Sel]</b> <b>[Anlg In2 Sel]</b> <b>[Anlg In3 Sel]</b></p> <p>Selects the parameter to which a value will be written from the analog input. Note: See Analog Input Configuration on page 292 for more information. Options:</p> <table border="1" data-bbox="321 556 1247 844"> <tr> <td>0 = "Off" (No signal)</td> <td>9 = "Neg Cur Lim" (Par 9)</td> <td>18 = "Pl CentralV3" (Par 778)</td> </tr> <tr> <td>1 = "Speed Ref A" (Par 44)</td> <td>10 = "Jog Ref" (Par 266)</td> <td>19 = "PID Feedback" (Par 763)</td> </tr> <tr> <td>2 = "Speed Ref B" (Par 48)</td> <td>11 = "Adaptive Ref" (Par 183)</td> <td>20 = "Fld Cur Max" (Par 467) <sup>(1)</sup></td> </tr> <tr> <td>3 = "Trim Ramp" (Par 42)</td> <td>12 = "UserDefined0" (Par 503)</td> <td>21 = "OutVoltLevel" (Par 921)</td> </tr> <tr> <td>4 = "Trim Speed" (Par 43)</td> <td>13 = "UserDefined1" (Par 504)</td> <td>22 = "Speed Ratio" (Par 1017)</td> </tr> <tr> <td>5 = "Torque Ref" (Par 39)</td> <td>14 = "UserDefined2" (Par 505)</td> <td>23 = "Tension Red" (Par 1179)</td> </tr> <tr> <td>6 = "Trim Torque" (Par 40)</td> <td>15 = "UserDefined3" (Par 506)</td> <td>24 = "Tension Ref" (Par 1180)</td> </tr> <tr> <td>7 = "TB Man Ref" (Par 267)</td> <td>16 = "Load Comp" (Par 698)</td> <td>25 = "Diam Preset3" (Par 1167)</td> </tr> <tr> <td>8 = "Pos Cur Lim" (Par 8)</td> <td>17 = "PID Setpt 0" (Par 760)</td> <td>26 = "FC Fdbk" <sup>(2)</sup></td> </tr> </table> <p>(1) Not used for permanent magnet motor applications. (2) For use with PowerFlex DC Field Controller only.</p>	0 = "Off" (No signal)	9 = "Neg Cur Lim" (Par 9)	18 = "Pl CentralV3" (Par 778)	1 = "Speed Ref A" (Par 44)	10 = "Jog Ref" (Par 266)	19 = "PID Feedback" (Par 763)	2 = "Speed Ref B" (Par 48)	11 = "Adaptive Ref" (Par 183)	20 = "Fld Cur Max" (Par 467) <sup>(1)</sup>	3 = "Trim Ramp" (Par 42)	12 = "UserDefined0" (Par 503)	21 = "OutVoltLevel" (Par 921)	4 = "Trim Speed" (Par 43)	13 = "UserDefined1" (Par 504)	22 = "Speed Ratio" (Par 1017)	5 = "Torque Ref" (Par 39)	14 = "UserDefined2" (Par 505)	23 = "Tension Red" (Par 1179)	6 = "Trim Torque" (Par 40)	15 = "UserDefined3" (Par 506)	24 = "Tension Ref" (Par 1180)	7 = "TB Man Ref" (Par 267)	16 = "Load Comp" (Par 698)	25 = "Diam Preset3" (Par 1167)	8 = "Pos Cur Lim" (Par 8)	17 = "PID Setpt 0" (Par 760)	26 = "FC Fdbk" <sup>(2)</sup>	Default: 1 = "Speed Ref A" Default: 0 = "Off" Default: 0 = "Off"	16-bit Int	
		0 = "Off" (No signal)	9 = "Neg Cur Lim" (Par 9)	18 = "Pl CentralV3" (Par 778)																													
		1 = "Speed Ref A" (Par 44)	10 = "Jog Ref" (Par 266)	19 = "PID Feedback" (Par 763)																													
		2 = "Speed Ref B" (Par 48)	11 = "Adaptive Ref" (Par 183)	20 = "Fld Cur Max" (Par 467) <sup>(1)</sup>																													
		3 = "Trim Ramp" (Par 42)	12 = "UserDefined0" (Par 503)	21 = "OutVoltLevel" (Par 921)																													
4 = "Trim Speed" (Par 43)	13 = "UserDefined1" (Par 504)	22 = "Speed Ratio" (Par 1017)																															
5 = "Torque Ref" (Par 39)	14 = "UserDefined2" (Par 505)	23 = "Tension Red" (Par 1179)																															
6 = "Trim Torque" (Par 40)	15 = "UserDefined3" (Par 506)	24 = "Tension Ref" (Par 1180)																															
7 = "TB Man Ref" (Par 267)	16 = "Load Comp" (Par 698)	25 = "Diam Preset3" (Par 1167)																															
8 = "Pos Cur Lim" (Par 8)	17 = "PID Setpt 0" (Par 760)	26 = "FC Fdbk" <sup>(2)</sup>																															
		71 76 81	 <p><b>[Anlg In1 Config]</b> <b>[Anlg In2 Config]</b> <b>[Anlg In3 Config]</b></p> <p>Selects the signal input (voltage or current) mode for the analog input. Configure switches S9, S10, and S11 on the control board according to the input signal used. The inputs of the drive are factory set for voltage signals. See DIP Switch and Jumper Settings on page 77 for information on switch configuration.</p> <ul style="list-style-type: none"> <li>"+/-10V" = A maximum voltage of ±10V is connected to the analog input. If the signal is used as a reference value, a polarity reversal can be used to reverse the rotation direction of the drive (four quadrant only) when Par 1322 [Direction Mode] = 1 "Bipolar". Two quadrant drives accept only positive references as the speed reference. Negative references are not accepted and the drive will run at zero speed.</li> <li>"0-10V" = A maximum voltage of 10V is connected to the analog input. For reference values, only positive references are allowed.</li> <li>"0 - 20mA" = A maximum current signal of 0 – 20 mA is connected to the analog input. The signal must be positive.</li> <li>"4 to 20mA" = A current signal of 4 – 20 mA is connected to the analog input. The signal must be positive.</li> </ul> <p>Note: See Analog Input Configuration on page 292 for more information.</p>	Default: 0 = "+/-10V" Options: 0 = "+/-10V" 1 = "0-10V" 2 = "0 - 20mA" 3 = "4 to 20mA"	16-bit Int	1322																											
		72 77 82	 <p><b>[Anlg In1 Scale]</b> <b>[Anlg In2 Scale]</b> <b>[Anlg In3 Scale]</b></p> <p>Scales the value in the corresponding [Anlg Inx Sel] parameter. Note: See Analog Input Configuration on page 292 for more information.</p>	Default: 1.00 Min/Max: -/+10.00	Real																												
		73 78 83	 <p><b>[Anlg1 Tune Scale]</b> <b>[Anlg2 Tune Scale]</b> <b>[Anlg3 Tune Scale]</b></p> <p>Fine tuning of the analog input when the maximum signal does not correspond exactly to the rated value. Scales according to the following equation: [Anlg Inx Sel] – [Anlg Inx Offset] x [Anlg Inx Scale] x [Ainx Tune Scale] Note: See Analog Input Configuration on page 292 for more information.</p>	Default: 1.00 Min/Max: 0.10 / 10.00	Real																												

File	Group	No.	Parameter Name & Description <small>See page 117 for symbol descriptions</small>	Values	Data Type	Related
INPUT / OUTPUT	Analog Inputs	74 79 84 <b>A</b>	<b>[Anlg In1 Offset]</b> <b>[Anlg In2 Offset]</b> <b>[Anlg In3 Offset]</b> Offset value for the analog inputs. If the input has an offset or if the variable assigned to the input already has a value although there is no input signal present, this can be compensated for via the value in this parameter.	Default: 0 Min/Max: -32768/+32767	16-bit Int	
		259 260 261 <b>A</b>	<b>[Anlg In1 Tune]</b> <b>[Anlg In2 Tune]</b> <b>[Anlg In3 Tune]</b> Automatic fine tuning of the analog inputs. If this command is given, parameter [Ainx Tune Scale] is automatically selected so that the input signal present, normally full scale, corresponds to the maximum variable value, such as the value of Par 45 [Max Ref Speed]. Two conditions are necessary for automatic fine tuning: <ul style="list-style-type: none"> <li>• An input voltage greater than 1V or an input current greater than 2 mA.</li> <li>• Positive polarity. The value found is automatically set for the opposite direction for four quadrant drives.</li> </ul> Note: The automatically calculated value can, if necessary, be modified manually via parameter [Ainx Tune Scale]. When using analog input tuning, Pars [Analog Inx Scale] are normally set to 1.0.	Default: 0 = "Ready" Options: 0 = "Ready" 1 = "Tune"	16-bit Int	
		295 296 297	<b>[Anlg In1 Target]</b> <b>[Anlg In2 Target]</b> <b>[Anlg In3 Target]</b> Enables sampling for the analog inputs.	Default: 0 = "Assigned" Options: 0 = "Assigned" 1 = "Not Assigned"	16-bit Int	
		792 <b>A</b>	<b>[Anlg In1 Filter]</b> Analog input 1 filter.	Default: 0 Min/Max: 0 / 1000 Units: ms	16-bit Int	
		801 <b>A</b>	<b>[Anlg In2 Filter]</b> Analog input 2 filter. Note: This parameter was added for firmware revision 4.001.	Default: 0 Min/Max: 0 / 1000 Units: ms	16-bit Int	
		802 <b>A</b>	<b>[Anlg In3 Filter]</b> Analog input 3 filter. Note: This parameter was added for firmware revision 4.001.	Default: 0 Min/Max: 0 / 1000 Units: ms	16-bit Int	
		1042	<b>[Anlg In1 Cmp]</b> Defines a reference point for the signal of analog input 1 around which a comparison range can be set (via Par 1043 [Anlg In1 Cmp Err]) and monitored. [Anlg In1 Cmp] = (comparison value) x 10000 / (max. reference value), where the values of "comparison" and "max. reference" are determined by the min/max of the related parameter selected via Par 70 [Anlg In1 Sel]. Note: See Analog-input Signal Comparison on page 293 for more information.	Default: 0 Min/Max: - / +10000	16-bit Int	1043, 1044, 1045
		1043	<b>[Anlg In1 Cmp Err]</b> Defines a value above and below the value set in parameter 1042 [Anlg In1 Cmp] at which Par 1045 [Anlg In1 Cmp Eq] will transition. [Anlg In1 Cmp Err] = (tolerance value) x 10000 / (max. reference value), where the values of "tolerance" and "max. reference" are determined by the min/max of the parameter selected via Par 70 [Anlg In1 Sel]. Note: See Analog-input Signal Comparison on page 293 for more information.	Default: 0 Min/Max: 0 / 10000	16-bit Int	1042, 1044, 1045
		1044	<b>[Anlg In1 Cmp Dly]</b> Amount of time that must elapse, after the value in Par 1043 [Anlg In1 Cmp Err] has been reached, before Par 1045 [Anlg In1 Cmp Eq] transitions.	Default: 0 Min/Max: 0 / 65000 Units: ms	16-bit Int	1042, 1043, 1045







File	Group	No.	Parameter Name & Description <small>See <a href="#">page 117</a> for symbol descriptions</small>	Values		Data Type	Related
<b>INPUT / OUTPUT</b>	<b>Analog Inputs</b>	1045	<b>[Anlg In1 Cmp Eq]</b> Provides an indication, after the amount of time specified in Par 1044 [Anlg In1 Cmp Dly] has elapsed, when the value set in parameter 1043 [Anlg In1 Cmp Err] has been reached. <ul style="list-style-type: none"> <li>• "0" = The value of analog input 1 is above or below the value set in Par 1043 [Anlg In1 Cmp Err].</li> <li>• "1" = The value of analog input 1 is within the range set in Par 1043 [Anlg In1 Cmp Err].</li> </ul> Notes: This parameter can be assigned to a digital output. See Analog-input Signal Comparison on <a href="#">page 293</a> for more information.	Default: Min/Max:	Read Only 0 / 1	16-bit Int	1042, 1043, 1044
		1404	<b>[Analog In1 Value]</b> Value of the signal at analog input 1. Units based on the value set in Par 71 [Anlg In1 Config].	Default: Min/Max: Units:	Read Only -/+20.00 V or mA	Real	71
		1405	<b>[Analog In2 Value]</b> Value of the signal at analog input 2. Units based on the value set in Par 76 [Anlg In2 Config].	Default: Min/Max: Units:	Read Only -/+20.00 V or mA	Real	76
		1406	<b>[Analog In3 Value]</b> Value of the signal at analog input 3. Units based on the value set in Par 81 [Anlg In3 Config].	Default: Min/Max: Units:	Read Only -/+20.00 V or mA	Real	81
	<b>Analog Outputs</b>	62 63 64 65	<b>[Anlg Out1 Scale]</b> <b>[Anlg Out2 Scale]</b> <b>[Anlg Out3 Scale]</b> <b>[Anlg Out4 Scale]</b> Scaling of the analog outputs.	Default: Min/Max:	1.00 -/+10.00	Real	


File	Group	No.	Parameter Name & Description See page 117 for symbol descriptions	Values	Data Type	Related																																																																																																																							
INPUT / OUTPUT	Analog Outputs	66	<b>[Anlg Out1 Sel]</b> <b>[Anlg Out2 Sel]</b> <b>[Anlg Out3 Sel]*</b> <b>[Anlg Out4 Sel]*</b> Selects the source of the value that drives the analog output. *This parameter is used to configure an analog output on the I/O Expansion circuit board. See <a href="#">Appendix F</a> - Optional Analog and Digital I/O Expansion Circuit Board. Notes: Option 9 "Torque Ref" was changed to "Sel Torq Ref" for firmware revision 6.001. Option 24 "Field Ref" was changed and 36 "Fld Cur Ref" was added for firmware revision 7.001. Options:	Default:	12 = "Motor Speed"	16-bit Int																																																																																																																							
		67		Default:	13 = "Motor Curr"																																																																																																																								
		68		Default:	18 = "Fld Current"																																																																																																																								
		69		Default:	14 = "Motor Volts"																																																																																																																								
					<table border="1"> <thead> <tr> <th>No.</th> <th>Option (Par)</th> <th>Scaling of Analog Output Value</th> <th>No.</th> <th>Option (Par)</th> <th>Scaling of Analog Output Value</th> </tr> </thead> <tbody> <tr> <td>0 =</td> <td>"Off" (Not used)</td> <td>n/a</td> <td>19 =</td> <td>"UserDefined0" (Par 503)</td> <td>±10V = ±2047 in Par 503 [UserDefined0]</td> </tr> <tr> <td>1 =</td> <td>"Spd Ref Out" (Par 385)</td> <td>±10V = ±100% of Par 45 [Max Ref Speed]</td> <td>20 =</td> <td>"UserDefined1" (Par 504)</td> <td>±10V = ±2047 in Par 504 [UserDefined1]</td> </tr> <tr> <td>2 =</td> <td>"Trim Ramp" (Par 42)</td> <td>±10V = ±100% of Par 45 [Max Ref Speed]</td> <td>21 =</td> <td>"UserDefined4" (Par 507)</td> <td>±10V = ±2047 in Par 507 [UserDefined4]</td> </tr> <tr> <td>3 =</td> <td>"Ramp In" (Par 110)</td> <td>±10V = ±100% of Par 45 [Max Ref Speed]</td> <td>22 =</td> <td>"UserDefined5" (Par 508)</td> <td>±10V = ±2047 in Par 508 [UserDefined5]</td> </tr> <tr> <td>4 =</td> <td>"Ramp Out" (Par 113)</td> <td>±10V = ±100% of Par 45 [Max Ref Speed]</td> <td>23 =</td> <td>"UserDefined6" (Par 509)</td> <td>±10V = ±2047 in Par 509 [UserDefined6]</td> </tr> <tr> <td>5 =</td> <td>"Spd Draw Out" (Par 1018)</td> <td>±10V = ±100% of Par 45 [Max Ref Speed]</td> <td>24 =</td> <td>"Flux Ref Pct" (Par 500) <sup>(1)</sup></td> <td>0-10V = 0-100% of Par 280 [Nom Mtr Fld Amps]</td> </tr> <tr> <td>6 =</td> <td>"Trim Speed" (Par 43)</td> <td>±10V = ±100% of Par 45 [Max Ref Speed]</td> <td>25 =</td> <td>"PID Output" (Par 774)</td> <td>±10V = ±10000 in Par 774 [PID Output]</td> </tr> <tr> <td>7 =</td> <td>"Spd Reg In" (Par 118)</td> <td>±10V = ±100% of Par 45 [Max Ref Speed]</td> <td>26 =</td> <td>"Out Volt Lvl" (Par 921)</td> <td>±10V = ±100% Par 175 [Rated Motor Volt]</td> </tr> <tr> <td>8 =</td> <td>"Spd Reg Out" (Par 236)</td> <td>±10V = ±100% of Par 179 [Nom Mtr Arm Amps]</td> <td>27 =</td> <td>"Fld Cur Max" (Par 467)</td> <td>0-10V = 0-100% of Par 280 [Nom Mtr Fld Amps]</td> </tr> <tr> <td>9 =</td> <td>"Sel Torq Ref" (Par 14)</td> <td>±10V = ±100% of Par 179 [Nom Mtr Arm Amps]</td> <td>28 =</td> <td>"Filtered Spd" (Par 924)</td> <td>±10V = ±100% of Par 45 [Max Ref Speed]</td> </tr> <tr> <td>10 =</td> <td>"Trim Torque" (Par 40)</td> <td>±10V = ±100% of Par 179 [Nom Mtr Arm Amps]</td> <td>29 =</td> <td>"Filtered Cur" (Par 928)</td> <td>±10V = ±200% of Par 179 [Nom Mtr Arm Amps]</td> </tr> <tr> <td>11 =</td> <td>"Torq Reg In" (Par 41)</td> <td>±10V = ±100% of Par 179 [Nom Mtr Arm Amps]</td> <td>30 =</td> <td>"Output Power" (Par 1052)</td> <td>±10V = ±200% of Par 179 [Nom Mtr Arm Amps] x Par 175 [Rated Motor Volt]</td> </tr> <tr> <td>12 =</td> <td>"Motor Speed" (Par 121)</td> <td>±10V = ±100% of Par 45 [Max Ref Speed]</td> <td>31 =</td> <td>"Roll Diam" (Par 1154)</td> <td>0-10V = 0-100% of Par 1153 [Max Diameter]</td> </tr> <tr> <td>13 =</td> <td>"Motor Curr" (Par 199)</td> <td>±10V = ±200% of Par 179 [Nom Mtr Arm Amps]</td> <td>32 =</td> <td>"Tension Ref" (Par 1180)</td> <td>0-10V = 0-100% of Par 1153 [Max Diameter]</td> </tr> <tr> <td>14 =</td> <td>"Motor Volts" (Par 233)</td> <td>±10V = ±100% of Par 175 [Rated Motor Volt]</td> <td>33 =</td> <td>"Torque Curr" (Par 1193)</td> <td>±10V = ±200% of Par 179 [Nom Mtr Arm Amps]</td> </tr> <tr> <td>15 =</td> <td>"Analog In 1" (Par 70)</td> <td>±10V = ±10V on Analog Input 1</td> <td>34 =</td> <td>"Winder Ref" (Par 1217)</td> <td>±10V = ±100% of Par 45 [Max Ref Speed]</td> </tr> <tr> <td>16 =</td> <td>"Analog In 2" (Par 75)</td> <td>±10V = ±10V on Analog Input 2</td> <td>35 =</td> <td>"Active Comp" (Par 1213)</td> <td>±10V = ±200% of Par 179 [Nom Mtr Arm Amps]</td> </tr> <tr> <td>17 =</td> <td>"Analog In 3" (Par 80)</td> <td>±10V = ±10V on Analog Input 3</td> <td>36 =</td> <td>"Fld Cur Ref" (Par 469 when set to 4 "Wired FC FW" or 6 "Wired FC BS")</td> <td>±10V = ±100%</td> </tr> <tr> <td>18 =</td> <td>"Fld Current" (Par 234)</td> <td>0-10V = 0-100% of Par 280 [Nom Mtr Fld Amps]</td> <td></td> <td></td> <td></td> </tr> </tbody> </table>	No.	Option (Par)	Scaling of Analog Output Value	No.	Option (Par)	Scaling of Analog Output Value	0 =	"Off" (Not used)	n/a	19 =	"UserDefined0" (Par 503)	±10V = ±2047 in Par 503 [UserDefined0]	1 =	"Spd Ref Out" (Par 385)	±10V = ±100% of Par 45 [Max Ref Speed]	20 =	"UserDefined1" (Par 504)	±10V = ±2047 in Par 504 [UserDefined1]	2 =	"Trim Ramp" (Par 42)	±10V = ±100% of Par 45 [Max Ref Speed]	21 =	"UserDefined4" (Par 507)	±10V = ±2047 in Par 507 [UserDefined4]	3 =	"Ramp In" (Par 110)	±10V = ±100% of Par 45 [Max Ref Speed]	22 =	"UserDefined5" (Par 508)	±10V = ±2047 in Par 508 [UserDefined5]	4 =	"Ramp Out" (Par 113)	±10V = ±100% of Par 45 [Max Ref Speed]	23 =	"UserDefined6" (Par 509)	±10V = ±2047 in Par 509 [UserDefined6]	5 =	"Spd Draw Out" (Par 1018)	±10V = ±100% of Par 45 [Max Ref Speed]	24 =	"Flux Ref Pct" (Par 500) <sup>(1)</sup>	0-10V = 0-100% of Par 280 [Nom Mtr Fld Amps]	6 =	"Trim Speed" (Par 43)	±10V = ±100% of Par 45 [Max Ref Speed]	25 =	"PID Output" (Par 774)	±10V = ±10000 in Par 774 [PID Output]	7 =	"Spd Reg In" (Par 118)	±10V = ±100% of Par 45 [Max Ref Speed]	26 =	"Out Volt Lvl" (Par 921)	±10V = ±100% Par 175 [Rated Motor Volt]	8 =	"Spd Reg Out" (Par 236)	±10V = ±100% of Par 179 [Nom Mtr Arm Amps]	27 =	"Fld Cur Max" (Par 467)	0-10V = 0-100% of Par 280 [Nom Mtr Fld Amps]	9 =	"Sel Torq Ref" (Par 14)	±10V = ±100% of Par 179 [Nom Mtr Arm Amps]	28 =	"Filtered Spd" (Par 924)	±10V = ±100% of Par 45 [Max Ref Speed]	10 =	"Trim Torque" (Par 40)	±10V = ±100% of Par 179 [Nom Mtr Arm Amps]	29 =	"Filtered Cur" (Par 928)	±10V = ±200% of Par 179 [Nom Mtr Arm Amps]	11 =	"Torq Reg In" (Par 41)	±10V = ±100% of Par 179 [Nom Mtr Arm Amps]	30 =	"Output Power" (Par 1052)	±10V = ±200% of Par 179 [Nom Mtr Arm Amps] x Par 175 [Rated Motor Volt]	12 =	"Motor Speed" (Par 121)	±10V = ±100% of Par 45 [Max Ref Speed]	31 =	"Roll Diam" (Par 1154)	0-10V = 0-100% of Par 1153 [Max Diameter]	13 =	"Motor Curr" (Par 199)	±10V = ±200% of Par 179 [Nom Mtr Arm Amps]	32 =	"Tension Ref" (Par 1180)	0-10V = 0-100% of Par 1153 [Max Diameter]	14 =	"Motor Volts" (Par 233)	±10V = ±100% of Par 175 [Rated Motor Volt]	33 =	"Torque Curr" (Par 1193)	±10V = ±200% of Par 179 [Nom Mtr Arm Amps]	15 =	"Analog In 1" (Par 70)	±10V = ±10V on Analog Input 1	34 =	"Winder Ref" (Par 1217)	±10V = ±100% of Par 45 [Max Ref Speed]	16 =	"Analog In 2" (Par 75)	±10V = ±10V on Analog Input 2	35 =	"Active Comp" (Par 1213)	±10V = ±200% of Par 179 [Nom Mtr Arm Amps]	17 =	"Analog In 3" (Par 80)	±10V = ±10V on Analog Input 3	36 =	"Fld Cur Ref" (Par 469 when set to 4 "Wired FC FW" or 6 "Wired FC BS")	±10V = ±100%	18 =	"Fld Current" (Par 234)	0-10V = 0-100% of Par 280 [Nom Mtr Fld Amps]			
		No.	Option (Par)	Scaling of Analog Output Value	No.	Option (Par)	Scaling of Analog Output Value																																																																																																																						
		0 =	"Off" (Not used)	n/a	19 =	"UserDefined0" (Par 503)	±10V = ±2047 in Par 503 [UserDefined0]																																																																																																																						
		1 =	"Spd Ref Out" (Par 385)	±10V = ±100% of Par 45 [Max Ref Speed]	20 =	"UserDefined1" (Par 504)	±10V = ±2047 in Par 504 [UserDefined1]																																																																																																																						
		2 =	"Trim Ramp" (Par 42)	±10V = ±100% of Par 45 [Max Ref Speed]	21 =	"UserDefined4" (Par 507)	±10V = ±2047 in Par 507 [UserDefined4]																																																																																																																						
		3 =	"Ramp In" (Par 110)	±10V = ±100% of Par 45 [Max Ref Speed]	22 =	"UserDefined5" (Par 508)	±10V = ±2047 in Par 508 [UserDefined5]																																																																																																																						
		4 =	"Ramp Out" (Par 113)	±10V = ±100% of Par 45 [Max Ref Speed]	23 =	"UserDefined6" (Par 509)	±10V = ±2047 in Par 509 [UserDefined6]																																																																																																																						
		5 =	"Spd Draw Out" (Par 1018)	±10V = ±100% of Par 45 [Max Ref Speed]	24 =	"Flux Ref Pct" (Par 500) <sup>(1)</sup>	0-10V = 0-100% of Par 280 [Nom Mtr Fld Amps]																																																																																																																						
		6 =	"Trim Speed" (Par 43)	±10V = ±100% of Par 45 [Max Ref Speed]	25 =	"PID Output" (Par 774)	±10V = ±10000 in Par 774 [PID Output]																																																																																																																						
		7 =	"Spd Reg In" (Par 118)	±10V = ±100% of Par 45 [Max Ref Speed]	26 =	"Out Volt Lvl" (Par 921)	±10V = ±100% Par 175 [Rated Motor Volt]																																																																																																																						
		8 =	"Spd Reg Out" (Par 236)	±10V = ±100% of Par 179 [Nom Mtr Arm Amps]	27 =	"Fld Cur Max" (Par 467)	0-10V = 0-100% of Par 280 [Nom Mtr Fld Amps]																																																																																																																						
		9 =	"Sel Torq Ref" (Par 14)	±10V = ±100% of Par 179 [Nom Mtr Arm Amps]	28 =	"Filtered Spd" (Par 924)	±10V = ±100% of Par 45 [Max Ref Speed]																																																																																																																						
		10 =	"Trim Torque" (Par 40)	±10V = ±100% of Par 179 [Nom Mtr Arm Amps]	29 =	"Filtered Cur" (Par 928)	±10V = ±200% of Par 179 [Nom Mtr Arm Amps]																																																																																																																						
		11 =	"Torq Reg In" (Par 41)	±10V = ±100% of Par 179 [Nom Mtr Arm Amps]	30 =	"Output Power" (Par 1052)	±10V = ±200% of Par 179 [Nom Mtr Arm Amps] x Par 175 [Rated Motor Volt]																																																																																																																						
		12 =	"Motor Speed" (Par 121)	±10V = ±100% of Par 45 [Max Ref Speed]	31 =	"Roll Diam" (Par 1154)	0-10V = 0-100% of Par 1153 [Max Diameter]																																																																																																																						
		13 =	"Motor Curr" (Par 199)	±10V = ±200% of Par 179 [Nom Mtr Arm Amps]	32 =	"Tension Ref" (Par 1180)	0-10V = 0-100% of Par 1153 [Max Diameter]																																																																																																																						
14 =	"Motor Volts" (Par 233)	±10V = ±100% of Par 175 [Rated Motor Volt]	33 =	"Torque Curr" (Par 1193)	±10V = ±200% of Par 179 [Nom Mtr Arm Amps]																																																																																																																								
15 =	"Analog In 1" (Par 70)	±10V = ±10V on Analog Input 1	34 =	"Winder Ref" (Par 1217)	±10V = ±100% of Par 45 [Max Ref Speed]																																																																																																																								
16 =	"Analog In 2" (Par 75)	±10V = ±10V on Analog Input 2	35 =	"Active Comp" (Par 1213)	±10V = ±200% of Par 179 [Nom Mtr Arm Amps]																																																																																																																								
17 =	"Analog In 3" (Par 80)	±10V = ±10V on Analog Input 3	36 =	"Fld Cur Ref" (Par 469 when set to 4 "Wired FC FW" or 6 "Wired FC BS")	±10V = ±100%																																																																																																																								
18 =	"Fld Current" (Par 234)	0-10V = 0-100% of Par 280 [Nom Mtr Fld Amps]																																																																																																																											
(1) Not used for permanent magnet motor applications.																																																																																																																													

File	Group	No.	Parameter Name & Description <small>See page 117 for symbol descriptions</small>	Values	Data Type	Related					
INPUT / OUTPUT	Digital Inputs	133	[Digital In1 Sel]	Default: 2 = "Stop/CF"	16-bit Int						
		134	[Digital In2 Sel]	Default: 3 = "Start"							
		135	[Digital In3 Sel]	Default: 11 = "Jog"							
		136	[Digital In4 Sel]	Default: 1 = "Enable" <sup>(1)</sup>							
		137	[Digital In5 Sel]	Default: 17 = "Speed Sel 1"							
		138	[Digital In6 Sel]	Default: 18 = "Speed Sel 2"							
		139	[Digital In7 Sel]	Default: 19 = "Speed Sel 3"							
		140	[Digital In8 Sel]	Default: 31 = "Contactor"							
		141	[Digital In9 Sel]*	Default: 0 = "Not Used"							
		142	[Digital In10 Sel]*	Default: 0 = "Not Used"							
		143	[Digital In11 Sel]*	Default: 0 = "Not Used"							
		144	[Digital In12 Sel]*	Default: 0 = "Not Used"							
		 <p>Selects the function driven by the digital input. See Option Definitions for [Digital Inx Sel] on page 200 and 201. *These parameters are used to configure the digital inputs on the I/O Expansion circuit board. Do not use these parameters if the I/O Expansion circuit board is <u>not</u> installed. Notes: Option 35 was changed from "Fld Weaken En" and option 64 "Invert Flt" was added for firmware revision 2.001. Option 34 "Field Reg En" was changed for firmware revision 3.001. Options 65...72 were added for firmware revision 6.001. Added options 73...75 for firmware revision 7.001. Options:</p>									
		0 =	"Not Used" (Off)	19 =			"Speed Sel 3"	38 =	"UsrDefinedA1"	57 =	"Diam Preset0"
		1 =	"Enable" <sup>(1)(2)</sup>	20 =			"PI Enable"	39 =	"UsrDefinedA2"	58 =	"Diam Preset1"
		2 =	"Stop/CF" <sup>(2)</sup>	21 =			"PI Hold"	40 =	"UsrDefinedA3"	59 =	"Taper Enable"
		3 =	"Start" <sup>(2)</sup>	22 =			"PI Reset"	41 =	"UsrDefinedA4"	60 =	"Spd DemandEn"
		4 =	"Fwd/Reverse" <sup>(2)</sup>	23 =			"PI Invert"	42 =	"UsrDefinedA5"	61 =	"Winder Side"
		5 =	"Run" <sup>(2)</sup>	24 =			"Local"	43 =	"UsrDefinedA6"	62 =	"PI-PD Enable"
		6 =	"Run Forward" <sup>(2)</sup>	25 =			"Acc2 & Dec2"	44 =	"UsrDefinedA7"	63 =	"Jog TW En"
7 =	"Run Reverse" <sup>(2)</sup>	26 =	"Accel 2"	45 =	"Droop Enable"	64 =	"Invert Flt"				
8 =	"Run Level" <sup>(2)</sup>	27 =	"Decel 2"	46 =	"PD Enable"	65 =	"Flt MicroPsn"				
9 =	"RunFwd Level" <sup>(2)</sup>	28 =	"MOP Inc"	47 =	"PID SetptSel"	66 =	"Fwd EndLimit"				
10 =	"RunRev Level" <sup>(2)</sup>	29 =	"MOP Dec"	48 =	"PI Cent vs0"	67 =	"Fwd Declimit"				
11 =	"Jog" <sup>(2)</sup>	30 =	"Fast Stop"	49 =	"PI Cent vs1"	68 =	"Rev EndLimit"				
12 =	"Jog Forward" <sup>(2)</sup>	31 =	"Contactor" <sup>(5)</sup>	50 =	"Diam Calc"	69 =	"Rev Declimit"				
13 =	"Jog Reverse" <sup>(2)</sup>	32 =	"MOP Reset"	51 =	"Diam Reset"	70 =	"Fwd Ovr Trvl"				
14 =	"Aux Fault"	33 =	"TorqueReduce"	52 =	"DiamCalc Dis"	71 =	"Rev Ovr Trvl"				
15 =	"Clear Faults"	34 =	"Reserved"	53 =	"Torq Wind En"	72 =	"Lift Stop"				
16 =	"Auto/Manual"	35 =	"Force MinFld" <sup>(3)(4)</sup>	54 =	"Speed Match"	73 =	"Wired FC En" <sup>(6)</sup>				
17 =	"Speed Sel 1"	36 =	"Freeze Ramp"	55 =	"Diam I/D En"	74 =	"Wired FC inv" <sup>(6)</sup>				
18 =	"Speed Sel 2"	37 =	"UsrDefinedA0"	56 =	"Wind/Unwind"	75 =	"Wired FC Act" <sup>(6)</sup>				
 <p><b>ATTENTION:</b> Enabling (forcing) the minimum field current while the drive is running could result in excessive motor speed, equipment damage and/or bodily injury.</p>											
 <p><b>ATTENTION:</b> Contactor status can only be used by the drive. Contactor status can not be used to initiate any external action (for example, mechanical braking) or equipment damage and/or bodily injury can occur.</p>											
<p>(1) A digital input (1...8 only) must be configured for "Enable".                  (2) For digital inputs 9...12, this option displays as "Reserved", indicating that it is not available for use - do not select "Reserved" options.                  (3) Not used for permanent magnet motor applications.                  (4)                  (5)                  (6) For use with PowerFlex DC Field Controller only.</p>											

File	Group	No.	Parameter Name & Description <small>See page 117 for symbol descriptions</small>	Values	Data Type	Related	
INPUT / OUTPUT	Digital Inputs	<b>Option Definitions for [Digital Inx Sel]</b>					
		Note: When assigning digital inputs to certain options that are associated with parameters, those parameter values may be overwritten by the state of the digital input.					
		<b>Option</b>	<b>Description</b>				
		Enable <sup>(1)(2)</sup>	Removing the enable input causes the motor to coast-to-stop without generating a fault.				
		Stop/CF <sup>(2)</sup>	Stops the drive if running or jogging or clears a fault if the drive is already stopped.				
		Start <sup>(2)</sup>	Issues a Start command, removal does not Stop the drive (3-wire control).				
		Fwd/Reverse <sup>(2)</sup>	Selects the operating direction of the drive. 0 = Forward, 1 = Reverse				
		Run <sup>(2)</sup>	Issues a Start command, removal causes the drive to Stop (2-wire control).				
		Run Forward <sup>(2)</sup>	Issues a Run command in the Forward direction.				
		Run Reverse <sup>(2)</sup>	Issues a Run command in the Reverse direction.				
		Run Level <sup>(2)</sup>	Level sensitive Run command (no off-to-on transition required).				
		RunFwd Level <sup>(2)</sup>	Run Level command in the Forward direction.				
		RunRev Level <sup>(2)</sup>	Run Level command in the Reverse direction.				
		Jog <sup>(2)</sup>	Starts the drive and runs at the speed in Par 266 [Jog Speed], removal causes the drive to Stop.				
		Jog Forward <sup>(2)</sup>	Issues a Jog command in the Forward direction.				
		Jog Reverse <sup>(2)</sup>	Issues a Jog command in the Reverse direction.				
		Aux Fault	Asserting causes an Auxiliary Input fault (F2).				
		Clear Faults	Issues a Clear Faults command.				
		Auto/Manual	Selects between Automatic and Manual speed reference values.				
		Speed Sel 1 - 3	Selects one of eight speed references. Bit enumerations: 000 = Par 44 [Speed Ref A], 001 = Par 48 [Speed Ref B], 010 = Par 155 [Preset Speed 2], 011 = Par 156 [Preset Speed 3], 100 = Par 157 [Preset Speed 4], 101 = Par 158 [Preset Speed 5], 110 = Par 159 [Preset Speed 6], 111 = Par 160 [Preset Speed 7]				
		PI Enable	Enables/disables the PI block of the PID regulator (Par 769 [Enable PI]).				
		PI Hold	Enables/disables a hold on the PI output.				
		PI Reset	Asserting causes a reset of the PI output.				
		PI Invert	Asserting causes an inversion of the PI output.				
		Local	Enables exclusive drive control via the I/O Terminal Block only.				
		Acc2 & Dec2	Switches between the Accel/Decel 1 and Accel/Decel 2 ramp rates.				
		Accel 2	Switches between the Accel 1 and Accel 2 ramp rates.				
		Decel 2	Switches between the Decel 1 and Decel 2 ramp rates.				
		MOP Inc	Asserting causes the MOP reference to increment at the rate set in Par 22 [MOP Accel Time].				
		MOP Dec	Asserting causes the MOP reference to decrement at the rate set in Par 30 [MOP Decel Time].				
		Fast Stop	Causes the drive to Stop at the rate set in Par 38 [Fast Stop Time].				
		Contactor	Indicates the status of the main contactor/DB contactor. Must be assigned and asserted to run drive when Par 1391 [ContactorControl] = "Contactor" or "Contactor+DB".				
		MOP Reset	Asserting resets the MOP reference to zero.				
		TorqueReduce	Turns on /off Torque Reduction using the reduced current limit set in Par 13 [Torq Red CurLim].				
		Force MinFld	When asserted, the field current is set to the value specified in Par 498 [Force Min Field]. <b>Important:</b> See Attention statement on page 199 for this option. Not used for permanent magnet motor applications.				
		Freeze Ramp	Holds the speed ramp at the present value (Par 373 [Freeze Ramp]).				
		UsrDefinedA0-7	Writes the value of the digital input to Pars 520 [UsrDefBitWrdA0] - 527 [UsrDefBitWrdA7].				
		Droop Enable	Enables/disables the Droop function (699 [Enable Droop]).				
		PD Enable	Enables/disables the PD block of the PID regulator (Par 770 [Enable PD]).				
		PI Cent vs0 - 1	In combination, the digital inputs set to "PI Central vs0" and "PI Central vs1", through binary selection, determine which of the four possible output values is used as the initial level of the integral component (corresponding to the initial diameter) of the PI block. See Par 780 [PI Central vs0] for binary selection values.				
		Diam Calc	When asserted initiates the diameter calculation (Par 794 [Diameter Calc]).				
		Digital input option definitions continued on the following page.					
		1 A digital input (1...8 only) must be configured for "Enable".					
		2 For digital inputs 9...12, this option is not available (displays as "Reserved").					






File	Group	No.	Parameter Name & Description <small>See page 117 for symbol descriptions</small>	Values	Data Type	Related		
INPUT / OUTPUT	Digital Inputs	<b>Option Definitions for [Digital Inx Sel], Continued</b>						
		Note: When assigning digital inputs to certain options that are associated with parameters, those parameter values may be overwritten by the state of the digital input.						
			<b>Option</b>	<b>Description</b>				
			Diam Reset	Sets the diameter starting value to the value in Par 1168 [Diam Preset Sel].				
			DiamCalc Dis	Enables/disables the diameter calculation (Par 1161 [Diameter Calc Dis]).				
			Torq Wind En	Enables/disables the Center wind function (Par 1209 [Torque Winder En]).				
			Speed Match	When asserted, issues the coil 'launch phase' command for automatic switching (Par 1195 [Speed Match]).				
			Diam I/D En	Enables/disables the ability of the diameter calculation to increase for an unwinder or decrease for a winder (Par 1205 [Diam Inc Dec En]).				
			Wind/Unwind	Sets the value of Par 1187 [Winder Type] to "0" Winder or "1" Unwinder.				
			Diam Preset0-1	Selects the value of Par 1164 [Diam Preset 0], 1165 [Diam Preset 1], Par 1166 [Diam Preset 2], or Par 1167 [Diam Preset 3] See Par 1168 [Diam Preset Sel].				
			Taper Enable	Enables/disables the Taper function (Par 1176 [Taper Enable]).				
			Spd DemandEn	Enables/disables the speed reference calculation (winder operation), (Par 1215 [Speed Demand En]).				
			Winder Side	Selection of the winding/unwinding side (0 = up, 1 = down).				
			PI-PD Enable	Selection between PI and PD (winder operation), (Par 1201 [Winder Side]).				
			Jog TW En	Enables/disables the Torque Winder jog function (Par 1256 [Jog TW Enable]).				
			Invert Flt	Must be used when the digital input is wired to the status of an inverting fault device (fuse, circuit breaker, etc.). Removing the input causes an "Inverting Fault" (F37).				
			Flt MicroPsn	Dual function when Torque Prove mode is enabled. When the drive is operating within the float tolerance zone, the input will hold the drive in the "float" function. The float function is defined as holding off the setting of the brake while the drive holds zero speed. When the input is active and the drive is operating outside the float tolerance zone, the drive will operate at a percentage (set in Par 1112 [MicroPsnScalePct]) of the commanded reference. Operation is also affected by the value of Par 1100 [Torq Prove Cfg], bit 2 "Micro Psn."				
			Fwd EndLimit	Assigns a digital input, that when asserted, triggers a "forward end limit" function that results in the drive executing a "Fast Stop" command. This condition is latched so that, while active, starting in the same direction only provides a zero speed reference. Latching also lets the load travel past the end limit (digital input opens) when stopping. Starting in the opposite direction will use the normal speed reference and the condition will unlatch only after this digital input opens and the load moves past the forward end limit. This function is usually used with a limit switch near the point at which the drive stops.				
			Fwd DecLimit	Assigns a digital input, that when asserted, triggers a "forward decel limit" function that results in forcing the speed reference to Preset Speed 1 (Par 154). The forced reference remains in effect until the direction is changed. This function is usually used with a limit switch and initiates the slowing down process prior to encountering the end limit.				
			Rev EndLimit	Assigns a digital input, that when asserted, triggers a "reverse end limit" function that results in the drive executing a "Fast Stop" command. This condition is latched so that so that, while active, starting in the same direction will only provides a zero speed reference. Latching also lets the load travel past the end limit (digital input opens) when stopping. Starting in the opposite direction will use the normal speed reference and the condition will unlatch only after this digital input opens and the load moves past the reverse end limit. This function is usually used with a limit switch near the point at which the drive stops.				
			Rev DecLimit	Assigns a digital input, that when asserted, triggers a "reverse decel limit" function that results in forcing the speed reference to Preset Speed 1 (Par 154). The forced reference remains in effect until the direction is changed. This function is usually used with a limit switch and initiates the slowing down process prior to encountering the end limit.				
			Fwd Ovr Trvl	Assigns a digital input, that when asserted, triggers a "forward over-travel" function which results in an immediate fault (and zero torque). After resetting the fault, the drive will only restart in the opposite direction. The fault is prevented from reoccurring until the digital input becomes unasserted. This function is usually used with a limit switch in a position beyond the end limit, as an extra safety limit to prevent torque from damaging the machine in an over-travel situation.				
			Rev Ovr Trvl	Assigns a digital input, that when asserted, triggers a "reverse over-travel" function which results in an immediate fault (and zero torque). After resetting the fault, the drive will only restart in the opposite direction. The fault is prevented from reoccurring until the digital input becomes unasserted. This function is usually used with a limit switch in a position beyond the end limit, as an extra safety limit to prevent torque from damaging the machine in an over-travel situation.				
			Lift Stop	Assigns a digital input, that when asserted triggers a "lift stop" function which results in a current limit stop (0 sec). This function is enabled by setting Par 1100 [Torq Prove Cfg], bit 8 "Lift Stop Bk" (=1).				
			Wired FC En	All three of these selections must be defined as a separate digital input when Par 469 [Field Mode Sel] is set to "Wired FC FW" or "Wired FC BS". The corresponding digital outputs on the PowerFlex DC Field Controller must be set to the same value and be physically connected to the PowerFlex DC drive.				
			Wired FC Inv					
			Wired FC Act					








File	Group	No.	Parameter Name & Description <small>See page 117 for symbol descriptions</small>	Values	Data Type	Related																																																			
INPUT / OUTPUT	Digital Inputs	564	<b>[Dig In Status]</b> Status of the digital inputs.	Read Only																																																					
		<table border="1" style="width: 100%; border-collapse: collapse;"> <thead> <tr> <th>Options</th> <th>Reserved</th> <th>Reserved</th> <th>Reserved</th> <th>Reserved</th> <th>Digital In12</th> <th>Digital In11</th> <th>Digital In10</th> <th>Digital In9</th> <th>Digital In8</th> <th>Digital In7</th> <th>Digital In6</th> <th>Digital In5</th> <th>Digital In4</th> <th>Digital In3</th> <th>Digital In2</th> <th>Digital In1</th> </tr> </thead> <tbody> <tr> <td>Default</td> <td>x</td> <td>x</td> <td>x</td> <td>x</td> <td>0</td> <td>0</td> <td>0</td> <td>0</td> <td>0</td> <td>0</td> <td>0</td> <td>0</td> <td>0</td> <td>0</td> <td>0</td> <td>0</td> </tr> <tr> <td>Bit</td> <td>15</td> <td>14</td> <td>13</td> <td>12</td> <td>11</td> <td>10</td> <td>9</td> <td>8</td> <td>7</td> <td>6</td> <td>5</td> <td>4</td> <td>3</td> <td>2</td> <td>1</td> <td>0</td> </tr> </tbody> </table>		Options	Reserved	Reserved	Reserved	Reserved	Digital In12	Digital In11	Digital In10	Digital In9	Digital In8	Digital In7	Digital In6	Digital In5	Digital In4	Digital In3	Digital In2	Digital In1	Default	x	x	x	x	0	0	0	0	0	0	0	0	0	0	0	0	Bit	15	14	13	12	11	10	9	8	7	6	5	4	3	2	1	0			
		Options	Reserved	Reserved	Reserved	Reserved	Digital In12	Digital In11	Digital In10	Digital In9	Digital In8	Digital In7	Digital In6	Digital In5	Digital In4	Digital In3	Digital In2	Digital In1																																							
Default	x	x	x	x	0	0	0	0	0	0	0	0	0	0	0	0																																									
Bit	15	14	13	12	11	10	9	8	7	6	5	4	3	2	1	0																																									
565	<b>[Dig In Term 1]</b>	Default:	Read Only	16-bit Int																																																					
566	<b>[Dig In Term 2]</b>	Min/Max:	0 / 1																																																						
567	<b>[Dig In Term 3]</b>																																																								
568	<b>[Dig In Term 4]</b>																																																								
569	<b>[Dig In Term 5]</b>																																																								
570	<b>[Dig In Term 6]</b>																																																								
571	<b>[Dig In Term 7]</b>																																																								
572	<b>[Dig In Term 8]</b>																																																								
573	<b>[Dig In Term 9]</b>																																																								
574	<b>[Dig In Term 10]</b>																																																								
575	<b>[Dig In Term 11]</b>																																																								
576	<b>[Dig In Term 12]</b> Status of the digital inputs. 0 = Low 1 = High																																																								
1276	<b>[Inversion In 1]</b>	Default:	0 "Disabled"	16-bit Int																																																					
1277	<b>[Inversion In 2]</b>	Options:	0 = "Disabled"																																																						
1278	<b>[Inversion In 3]</b>		1 = "Enabled"																																																						
1279	<b>[Inversion In 4]</b>																																																								
1280	<b>[Inversion In 5]</b>																																																								
1281	<b>[Inversion In 6]</b>																																																								
1282	<b>[Inversion In 7]</b>																																																								
1283	<b>[Inversion In 8]</b>																																																								
1387	<b>[Inversion In 9]</b>																																																								
1388	<b>[Inversion In 10]</b>																																																								
1389	<b>[Inversion In 11]</b>																																																								
1390	<b>[Inversion In 12]</b> inverts the digital input signal.																																																								
																																																									
																																																									
1391	<b>[ContactorControl]</b> Selects the type of contactor to be controlled by the drive. Either style of contactor (AC or DC) can be used, with or without dynamic braking (DB) contactor.	Default: Options:	1 = "AC Cntcr" 0 = "None" 1 = "AC Cntcr" 2 = "AC Cntcr+DB" 3 = "DC Cntcr" 4 = "DC Cntcr+DB"	16-bit Int																																																					
																																																									
																																																									
	<ul style="list-style-type: none"> <li>"AC Cntcr" indicates an AC contactor is used. See note 1 below.</li> <li>"AC Cntcr+DB" indicates that an AC contactor and dynamic brake resistor is used. See note 1 below.</li> <li>"DC Cntcr" indicates a DC contactor is used.</li> <li>"DC Cntcr+DB" indicates that a DC contactor and dynamic brake resistor is used.</li> </ul> The type of control selected determines how many I/O points will be required for contactor control and status.																																																								
	<ul style="list-style-type: none"> <li>"AC Cntcr" or "DC Cntcr" = 1 (relay) digital output, 1 digital input is used.</li> <li>"AC Cntcr+DB" or "DC Cntcr+DB" = 2 (relay) digital outputs, 1 digital input is used.</li> </ul> Notes:																																																								
	<ul style="list-style-type: none"> <li>1. When 1 "AC Cntcr" or 2 "AC Cntcr+DB" is selected, there is a 400 ms delay to power up before SCR firing can begin. The delay is needed to determine correct input voltage phasing.</li> <li>2. Option 1 was changed from "Contactor", option 2 was changed from "Contactor+DB", and options 3 and 4 were added for firmware revision 2.001.</li> </ul>																																																								

File	Group	No.	Parameter Name & Description <small>See page 117 for symbol descriptions</small>	Values	Data Type	Related																														
INPUT / OUTPUT	Digital Outputs	145	[Digital Out1 Sel]	Default: 5 = "Ready"	16-bit Int																															
		146	[Digital Out2 Sel]	Default: 9 = "Fault"																																
		147	[Digital Out3 Sel]	Default: 2 = "Spd Thresh"																																
		148	[Digital Out4 Sel]	Default: 4 = "CurrentLimit"																																
		149	[Digital Out5 Sel]*	Default: 26 = "Alarm"																																
		150	[Digital Out6 Sel]*	Default: 0 = "Not Used"																																
		151	[Digital Out7 Sel]*	Default: 0 = "Not Used"																																
		152	[Digital Out8 Sel]*	Default: 0 = "Not Used"																																
							Selects the source of the value that drives the digital output. See Option Definitions for [Digital Outx Sel], [Relay Out 1 Sel] and [Relay Out 2 Sel] on page 204. *These parameters are used to configure the digital outputs on the I/O Expansion circuit board. Notes: Option 16 "Encoder Err" was changed for firmware revision v5.002. Option 30 "Brake Slip" was added for firmware revision 6.001. Options:																													
		<table border="1" style="width: 100%; border-collapse: collapse;"> <tr> <td>0 = "Not Used" (Off)</td> <td>8 = "Spd Limited"</td> <td>16 = "Spd Fdbk Err"</td> <td>24 = "Reserved"</td> </tr> <tr> <td>1 = "Spd Zero Thr"</td> <td>9 = "Fault"</td> <td>17 = "Diam Calc"</td> <td>25 = "Reserved"</td> </tr> <tr> <td>2 = "Spd Thresh"</td> <td>10 = "Power Loss"</td> <td>18 = "Input1 Cmp"</td> <td>26 = "Alarm"</td> </tr> <tr> <td>3 = "At Speed"</td> <td>11 = "UserDefinedA"</td> <td>19 = "Diam Reached"</td> <td>27 = "Running"</td> </tr> <tr> <td>4 = "CurrentLimit"</td> <td>12 = "UserDefinedB"</td> <td>20 = "Speed Match"</td> <td>28 = "Jogging"</td> </tr> <tr> <td>5 = "Ready"</td> <td>13 = "Stop Control"</td> <td>21 = "Accelerating"</td> <td>29 = "Active"</td> </tr> <tr> <td>6 = "Ramp Pos"</td> <td>14 = "Field Loss"</td> <td>22 = "Decelerating"</td> <td>30 = Brake Slip</td> </tr> <tr> <td>7 = "Ramp Neg"</td> <td>15 = "Spd Fbk Loss"</td> <td>23 = "Brake Cmd"</td> <td></td> </tr> </table>					0 = "Not Used" (Off)	8 = "Spd Limited"	16 = "Spd Fdbk Err"	24 = "Reserved"	1 = "Spd Zero Thr"	9 = "Fault"	17 = "Diam Calc"	25 = "Reserved"	2 = "Spd Thresh"	10 = "Power Loss"	18 = "Input1 Cmp"	26 = "Alarm"	3 = "At Speed"	11 = "UserDefinedA"	19 = "Diam Reached"	27 = "Running"	4 = "CurrentLimit"	12 = "UserDefinedB"	20 = "Speed Match"	28 = "Jogging"	5 = "Ready"	13 = "Stop Control"	21 = "Accelerating"	29 = "Active"	6 = "Ramp Pos"	14 = "Field Loss"	22 = "Decelerating"	30 = Brake Slip	7 = "Ramp Neg"	15 = "Spd Fbk Loss"
0 = "Not Used" (Off)	8 = "Spd Limited"	16 = "Spd Fdbk Err"	24 = "Reserved"																																	
1 = "Spd Zero Thr"	9 = "Fault"	17 = "Diam Calc"	25 = "Reserved"																																	
2 = "Spd Thresh"	10 = "Power Loss"	18 = "Input1 Cmp"	26 = "Alarm"																																	
3 = "At Speed"	11 = "UserDefinedA"	19 = "Diam Reached"	27 = "Running"																																	
4 = "CurrentLimit"	12 = "UserDefinedB"	20 = "Speed Match"	28 = "Jogging"																																	
5 = "Ready"	13 = "Stop Control"	21 = "Accelerating"	29 = "Active"																																	
6 = "Ramp Pos"	14 = "Field Loss"	22 = "Decelerating"	30 = Brake Slip																																	
7 = "Ramp Neg"	15 = "Spd Fbk Loss"	23 = "Brake Cmd"																																		

File	Group	No.	Parameter Name & Description <small>See page 117 for symbol descriptions</small>	Values	Data Type	Related	
INPUT / OUTPUT	Digital Outputs	<b>Option Definitions for [Digital Outx Sel], [Relay Out 1 Sel] and [Relay Out 2 Sel]</b>					
		<b>Option</b>	<b>Description</b>				
		Spd Zero Thr	"0" indicates that the drive is operating below the value set in Par 107 [Speed Zero Level], "1" indicates that the drive is operating above Par 107 [Speed Zero Level].				
		Spd Thresh	"0" indicates that the drive is operating above the value set in Par 101 [Speed Thresh Pos], "1" indicates that the drive is operating below Par 101 [Speed Thresh Pos].				
		At Speed	"0" indicates that the actual speed is within the range specified in Par 104 [At Speed Error], "1" indicates that the actual speed is outside the range specified in Par 104 [At Speed Error].				
		CurrentLimit	"0" indicates that the drive is not limiting output current, "1" indicates that the drive is limiting the output current.				
		Ready	"1" indicates that the drive is powered, Enabled and no Start Inhibits exist. The state of the assigned digital output matches the state of bit 2 "Ready" of Par 381 [Drive Status 1].				
		Ramp Pos	"1" indicates that the actual speed of the drive is going positive. Follows the state of Par 346 [Torque Positive]. Not asserted until after the amount of time in Par 20 [Ramp Delay] has elapsed.				
		Ramp Neg	"1" indicates that the actual speed of the drive is going negative. Follows the state of Par 347 [Torque Negative]. Not asserted until after the amount of time in Par 20 [Ramp Delay] has elapsed.				
		Spd Limited	"1" indicates that the speed is being limited to the value of Par 3 [Max Speed Fwd], "0" indicates that the speed is not being limited.				
		Fault	"0" indicates that a drive fault has occurred. See Par 57 [FaultCode].				
		Power Loss	"0" indicates that the drive has detected a loss of the internal power supply.				
		UserDefinedA	Indicates the status of Par 519 [UsrDefBitWrda] (digital output 1 uses bit 0, digital output 2 uses bit 1, etc.). Par 1392 [Relay Out 1 Sel] uses bit 14 (only). Par 629 [Relay Out 2 Sel] uses bit 15 (only).				
		UserDefinedB	Indicates the status of Par 536 [UsrDefBitWrdb] (digital output 1 uses bit 0, digital output 2 uses bit 1, etc.). Par 1392 [Relay Out 1 Sel] uses bit 14 (only). Par 629 [Relay Out 2 Sel] uses bit 15 (only).				
		Stop Control	Energized ("1") at run and de-energized ("0") based on the value of Par 627 [Spd 0 Trip Delay].				
		Field Loss	"0" indicates the loss of the field voltage/current while the drive is running.				
		Spd Fbk Loss	"0" indicates the loss of speed feedback/encoder due to an excessive calculated error, as determined by the drive firmware.				
		Spd Fdbk Err	"0" indicates an error in the selected speed feedback device (DC tachometer, encoder, or resolver). Matches the state of Par 651 [Spd Fdbk State].				
		Diam Calc	Energized ("1") when Par 800 [Diameter Calc St] = 1 and de-energized ("0") when [Diameter Calc St] = 0.				
		Input1 Cmp	"1" indicates that the value of analog input 1 is inside the comparison window,"0" indicates that the value of analog input 1 is outside the comparison window (Par 1045 [Anlg In1 Cmp Eq]).				
		Diam Reached	Energized ("1") when the value of Par 1158 [Diam Threshold] has been exceeded.				
		Speed Match	Energized ("1") when the value of Par 1203 [Spd Match Compl] = "1" (launching ramp completed).				
		Accelerating	"1" indicates that the drive is actively accelerating. The state of the assigned digital output matches the state of bit 4 "Accelerating" of Par 381 [Drive Status 1] and the state of Par 1188 [Accel Status].				
		Decelerating	When set to "1" the drive is actively decelerating. The state of the assigned digital output matches the state of bit 5 "Decelerating" of Par 381 [Drive Status 1] and the state of Par 1189 [Decel Status].				
		Brake Cmd	Energized ("1") at run (opens the brake) after the value in Par 1263 [Opening Delay] has been exceeded. De-energized ("0") at stop (closes the brake) after the drive speed goes below the value of Par 1262 [Closing Speed].				
		ContactordB	"1" issues the close command to the main contactor and dynamic brake contactor.				
		Contactord	"1" issues the close command to the main contactor.				
		Alarm	"0" indicates that a drive alarm has occurred. See Par 1380 [Drive Alarm 1].				
		Running	"1" indicates that the drive is active in Run mode. The state of the assigned digital output matches the state of bit 2 "Running" of Par 382 [Drive Status 2].				
		Jogging	"1" indicates that the drive is active in Jog mode. The state of the assigned digital output matches the state of bit 3 "Jogging" of Par 382 [Drive Status 2].				
Active	"1" indicates that the drive is active in Run or Jog mode. The state of the assigned digital output matches the state of bit 1 "Active" of Par 382 [Drive Status 2].						
Brake Slip	"1" indicates that torque proving brake slip is active.						
TP Brake Cmd	Torque proving brake command is output to the brake.						



File	Group	No.	Parameter Name & Description <small>See page 117 for symbol descriptions</small>	Values	Data Type	Related																																																			
INPUT / OUTPUT	Digital Outputs	581	<b>[Dig Out Status]</b> Status of the standard digital outputs and relay outputs on the drive and on the optional I/O Expansion circuit board (if present).  Options <table border="1" style="width: 100%; border-collapse: collapse; text-align: center;"> <thead> <tr> <th></th> <th>Relay Out2</th> <th>Relay Out1</th> <th>Reserved</th> <th>Reserved</th> <th>Reserved</th> <th>Reserved</th> <th>Reserved</th> <th>Reserved</th> <th>Digital Out8</th> <th>Digital Out7</th> <th>Digital Out6</th> <th>Digital Out5</th> <th>Digital Out4</th> <th>Digital Out3</th> <th>Digital Out2</th> <th>Digital Out1</th> </tr> </thead> <tbody> <tr> <td>Default</td> <td>0</td> <td>0</td> <td>x</td> <td>x</td> <td>x</td> <td>x</td> <td>x</td> <td>x</td> <td>0</td> <td>0</td> <td>0</td> <td>0</td> <td>0</td> <td>0</td> <td>0</td> <td>0</td> </tr> <tr> <td>Bit</td> <td>15</td> <td>14</td> <td>13</td> <td>12</td> <td>11</td> <td>10</td> <td>9</td> <td>8</td> <td>7</td> <td>6</td> <td>5</td> <td>4</td> <td>3</td> <td>2</td> <td>1</td> <td>0</td> </tr> </tbody> </table>		Relay Out2	Relay Out1	Reserved	Reserved	Reserved	Reserved	Reserved	Reserved	Digital Out8	Digital Out7	Digital Out6	Digital Out5	Digital Out4	Digital Out3	Digital Out2	Digital Out1	Default	0	0	x	x	x	x	x	x	0	0	0	0	0	0	0	0	Bit	15	14	13	12	11	10	9	8	7	6	5	4	3	2	1	0	Read Only		
			Relay Out2	Relay Out1	Reserved	Reserved	Reserved	Reserved	Reserved	Reserved	Digital Out8	Digital Out7	Digital Out6	Digital Out5	Digital Out4	Digital Out3	Digital Out2	Digital Out1																																							
		Default	0	0	x	x	x	x	x	x	0	0	0	0	0	0	0	0																																							
		Bit	15	14	13	12	11	10	9	8	7	6	5	4	3	2	1	0																																							
		629	 <b>[Relay Out 2 Sel]</b> Selects the source of the value that drives the N.O. relay between the terminals 75 and 76. See "Option Definitions" on page 204. Notes: Option 16 "Encoder Err" was changed for firmware revision v5.002. Options 30 and 31 were added for firmware revision 6.001. Options: <table border="1" style="width: 100%; border-collapse: collapse; text-align: center;"> <tbody> <tr> <td>0 = "Not Used" (Off)</td> <td>8 = "Spd Limited"</td> <td>16 = "Spd Fdbk Err"</td> <td>24 = "ContactDB"</td> </tr> <tr> <td>1 = "Spd Zero Thr"</td> <td>9 = "Fault"</td> <td>17 = "Diam Calc"</td> <td>25 = "Contactor"</td> </tr> <tr> <td>2 = "Spd Thresh"</td> <td>10 = "Power Loss"</td> <td>18 = "Input1 Cmp"</td> <td>26 = "Alarm"</td> </tr> <tr> <td>3 = "At Speed"</td> <td>11 = "UserDefinedA"</td> <td>19 = "Diam Reached"</td> <td>27 = "Running"</td> </tr> <tr> <td>4 = "CurrentLimit"</td> <td>12 = "UserDefinedB"</td> <td>20 = "Speed Match"</td> <td>28 = "Jogging"</td> </tr> <tr> <td>5 = "Ready"</td> <td>13 = "Stop Control"</td> <td>21 = "Accelerating"</td> <td>29 = "Active"</td> </tr> <tr> <td>6 = "Ramp Pos"</td> <td>14 = "Field Loss"</td> <td>22 = "Decelerating"</td> <td>30 = "Brake Slip"</td> </tr> <tr> <td>7 = "Ramp Neg"</td> <td>15 = "Spd Fbk Loss"</td> <td>23 = "Brake Cmd"</td> <td>31 = "TP Brake Cmd"</td> </tr> </tbody> </table>	0 = "Not Used" (Off)	8 = "Spd Limited"	16 = "Spd Fdbk Err"	24 = "ContactDB"	1 = "Spd Zero Thr"	9 = "Fault"	17 = "Diam Calc"	25 = "Contactor"	2 = "Spd Thresh"	10 = "Power Loss"	18 = "Input1 Cmp"	26 = "Alarm"	3 = "At Speed"	11 = "UserDefinedA"	19 = "Diam Reached"	27 = "Running"	4 = "CurrentLimit"	12 = "UserDefinedB"	20 = "Speed Match"	28 = "Jogging"	5 = "Ready"	13 = "Stop Control"	21 = "Accelerating"	29 = "Active"	6 = "Ramp Pos"	14 = "Field Loss"	22 = "Decelerating"	30 = "Brake Slip"	7 = "Ramp Neg"	15 = "Spd Fbk Loss"	23 = "Brake Cmd"	31 = "TP Brake Cmd"	Default: 5 = "Ready"	16-bit Int																				
0 = "Not Used" (Off)	8 = "Spd Limited"	16 = "Spd Fdbk Err"	24 = "ContactDB"																																																						
1 = "Spd Zero Thr"	9 = "Fault"	17 = "Diam Calc"	25 = "Contactor"																																																						
2 = "Spd Thresh"	10 = "Power Loss"	18 = "Input1 Cmp"	26 = "Alarm"																																																						
3 = "At Speed"	11 = "UserDefinedA"	19 = "Diam Reached"	27 = "Running"																																																						
4 = "CurrentLimit"	12 = "UserDefinedB"	20 = "Speed Match"	28 = "Jogging"																																																						
5 = "Ready"	13 = "Stop Control"	21 = "Accelerating"	29 = "Active"																																																						
6 = "Ramp Pos"	14 = "Field Loss"	22 = "Decelerating"	30 = "Brake Slip"																																																						
7 = "Ramp Neg"	15 = "Spd Fbk Loss"	23 = "Brake Cmd"	31 = "TP Brake Cmd"																																																						
1267 1268 1269 1270 1271 1272 1273 1274	  <b>[Inversion Out 1]</b> <b>[Inversion Out 2]</b> <b>[Inversion Out 3]</b> <b>[Inversion Out 4]</b> <b>[Inversion Out 5]</b> <b>[Inversion Out 6]</b> <b>[Inversion Out 7]</b> <b>[Inversion Out 8]</b> Reverses the digital output signal.	Default: 0 = "Disabled" Options: 0 = "Disabled", 1 = "Enabled"	16-bit Int																																																						
1275	  <b>[Inversion Relay2]</b> Inverts the signal for Relay Output 2.	Default: 0 = "Disabled" Options: 0 = "Disabled", 1 = "Enabled"	16-bit Int																																																						

File	Group	No.	Parameter Name & Description <small>See page 117 for symbol descriptions</small>	Values	Data Type	Related																																	
INPUT / OUTPUT	Digital Outputs	1392	 <b>[Relay Out 1 Sel]</b> Selects the source of the value that drives the N.O. relay between the terminals 35 and 36. See "Option Definitions" on page 204. Notes: Option 16 "Encoder Err" was changed for firmware revision v5.002. Options 30 and 31 were added for firmware revision v6.001. Options:	Default: 25 = "Contactor"	16-bit Int																																		
		<table border="1"> <tr> <td>0 = "Not Used" (Off)</td> <td>8 = "Spd Limited"</td> <td>16 = "Spd Fdbk Err"</td> <td>24 = "ContactDB"</td> </tr> <tr> <td>1 = "Spd Zero Thr"</td> <td>9 = "Fault"</td> <td>17 = "Diam Calc"</td> <td>25 = "Contactor"</td> </tr> <tr> <td>2 = "Spd Thresh"</td> <td>10 = "Power Loss"</td> <td>18 = "Input1 Cmp"</td> <td>26 = "Alarm"</td> </tr> <tr> <td>3 = "At Speed"</td> <td>11 = "UserDefinedA"</td> <td>19 = "Diam Reached"</td> <td>27 = "Running"</td> </tr> <tr> <td>4 = "CurrentLimit"</td> <td>12 = "UserDefinedB"</td> <td>20 = "Speed Match"</td> <td>28 = "Jogging"</td> </tr> <tr> <td>5 = "Ready"</td> <td>13 = "Stop Control"</td> <td>21 = "Accelerating"</td> <td>29 = "Active"</td> </tr> <tr> <td>6 = "Ramp Pos"</td> <td>14 = "Field Loss"</td> <td>22 = "Decelerating"</td> <td>30 = "Brake Slip"</td> </tr> <tr> <td>7 = "Ramp Neg"</td> <td>15 = "Spd Fbk Loss"</td> <td>23 = "Brake Cmd"</td> <td>31 = "TP Brake Cmd"</td> </tr> </table>			0 = "Not Used" (Off)	8 = "Spd Limited"	16 = "Spd Fdbk Err"	24 = "ContactDB"	1 = "Spd Zero Thr"	9 = "Fault"	17 = "Diam Calc"	25 = "Contactor"	2 = "Spd Thresh"	10 = "Power Loss"	18 = "Input1 Cmp"	26 = "Alarm"	3 = "At Speed"	11 = "UserDefinedA"	19 = "Diam Reached"	27 = "Running"	4 = "CurrentLimit"	12 = "UserDefinedB"	20 = "Speed Match"	28 = "Jogging"	5 = "Ready"	13 = "Stop Control"	21 = "Accelerating"	29 = "Active"	6 = "Ramp Pos"	14 = "Field Loss"	22 = "Decelerating"	30 = "Brake Slip"	7 = "Ramp Neg"	15 = "Spd Fbk Loss"	23 = "Brake Cmd"	31 = "TP Brake Cmd"			
		0 = "Not Used" (Off)	8 = "Spd Limited"	16 = "Spd Fdbk Err"	24 = "ContactDB"																																		
		1 = "Spd Zero Thr"	9 = "Fault"	17 = "Diam Calc"	25 = "Contactor"																																		
		2 = "Spd Thresh"	10 = "Power Loss"	18 = "Input1 Cmp"	26 = "Alarm"																																		
		3 = "At Speed"	11 = "UserDefinedA"	19 = "Diam Reached"	27 = "Running"																																		
		4 = "CurrentLimit"	12 = "UserDefinedB"	20 = "Speed Match"	28 = "Jogging"																																		
		5 = "Ready"	13 = "Stop Control"	21 = "Accelerating"	29 = "Active"																																		
		6 = "Ramp Pos"	14 = "Field Loss"	22 = "Decelerating"	30 = "Brake Slip"																																		
		7 = "Ramp Neg"	15 = "Spd Fbk Loss"	23 = "Brake Cmd"	31 = "TP Brake Cmd"																																		
1393	 <b>[Inversion Relay1]</b> Inverts the signal for Relay Output 1.	Default: 0 = "Disabled" Options: 0 = "Disabled", 1 = "Enabled"	16-bit Int																																				
1323	 <b>[DPI P1 Select]</b> Selects the destination of the reference value from DPI Port 1 (HIM on drive cover, when installed).	Default: 0 = "OFF" Options: 0 = "OFF", 1 = "Speed Ref A" (Par 44), 2 = "Speed Ref B" (Par 48), 3 = "Trim Ramp" (Par 42), 4 = "Trim Speed" (Par 43), 5 = "Torque Ref" (Par 39), 6 = "Trim Torque" (Par 40), 7 = "Pos Cur Lim" (Par 8), 8 = "Neg Cur Lim" (Par 9)	16-bit Int																																				
1324	 <b>[DPI P2 Select]</b> Selects the destination of the reference value from DPI Port 2 (handheld, remote, and external communication [20-XCOMM-DC-BASE] option, when installed).	See Par 1323 [DPI P1 Select].	16-bit Int																																				
1325	 <b>[DPI P3 Select]</b> Selects the destination of the reference value from DPI Port 3 (handheld, remote, and external communication [20-XCOMM-DC-BASE] option, when installed).	See Par 1323 [DPI P1 Select].	16-bit Int																																				
1326	 <b>[DPI P4 Select]</b> Selects the destination of the reference value from DPI Port 4.	See Par 1323 [DPI P1 Select].	16-bit Int																																				
1327	 <b>[DPI P5 Select]</b> Selects the destination of the reference value from DPI Port 5 (communications adapter, when installed).	See Par 1323 [DPI P1 Select].	16-bit Int																																				
	DPI Inputs																																						

## Parameter Cross Reference – by Name

Name	No.	Group	Page
AC Line Freq	588	Drive Data	<a href="#">130</a>
AC Line Voltage	466	Drive Data	<a href="#">130</a>
Acc Dec Filter	1212	Winder Functions	<a href="#">171</a>
Accel Mask	596	Masks & Owners	<a href="#">192</a>
Accel Owner	605	Masks & Owners	<a href="#">192</a>
Accel Status	1188	Winder Functions	<a href="#">169</a>
Accel Time 1	660	Ramp Rates	<a href="#">157</a>
Accel Time 2	24	Ramp Rates	<a href="#">156</a>
Act Spd Filter	923	Speed Feedback	<a href="#">143</a>
Act Spd Reg BW	435	Speed Regulator	<a href="#">153</a>
Act Ten Ref Pct	1194	Winder Functions	<a href="#">170</a>
Actual Comp	1213	Winder Functions	<a href="#">171</a>
Actual Speed	924	Speed Meters	<a href="#">127</a>
Actuator Delay	1266	Stop Modes	<a href="#">158</a>
Adaptive I Gain1	189	Adaptv Regulator	<a href="#">160</a>
Adaptive I Gain2	191	Adaptv Regulator	<a href="#">160</a>
Adaptive I Gain3	193	Adaptv Regulator	<a href="#">160</a>
Adaptive Joint 1	186	Adaptv Regulator	<a href="#">159</a>
Adaptive Joint 2	187	Adaptv Regulator	<a href="#">160</a>
Adaptive P Gain1	188	Adaptv Regulator	<a href="#">160</a>
Adaptive P Gain2	190	Adaptv Regulator	<a href="#">160</a>
Adaptive P Gain3	192	Adaptv Regulator	<a href="#">160</a>
Adaptive Ref	183	Adaptv Regulator	<a href="#">159</a>
Adaptive Reg Typ	182	Adaptv Regulator	<a href="#">159</a>
Adaptive Spd 1	184	Adaptv Regulator	<a href="#">159</a>
Adaptive Spd 2	185	Adaptv Regulator	<a href="#">159</a>
Adaptive Spd En	181	Adaptv Regulator	<a href="#">159</a>
Alpha Test	166	Test Generator	<a href="#">146</a>
Analog In1 Value	1404	Analog Inputs	<a href="#">197</a>
Analog In2 Value	1405	Analog Inputs	<a href="#">197</a>
Analog In3 Value	1406	Analog Inputs	<a href="#">197</a>
Anlg In 1 Filter	792	Analog Inputs	<a href="#">196</a>
Anlg In1 Cmp	1042	Analog Inputs	<a href="#">196</a>

Name	No.	Group	Page
Anlg In1 Cmp Dly	1044	Analog Inputs	<a href="#">196</a>
Anlg In1 Cmp Eq	1045	Analog Inputs	<a href="#">197</a>
Anlg In1 Cmp Err	1043	Analog Inputs	<a href="#">196</a>
Anlg In1 Config	71	Analog Inputs	<a href="#">195</a>
Anlg In1 Offset	74	Analog Inputs	<a href="#">196</a>
Anlg In1 Scale	72	Analog Inputs	<a href="#">195</a>
Anlg In1 Sel	70	Analog Inputs	<a href="#">195</a>
Anlg In1 Target	295	Analog Inputs	<a href="#">196</a>
Anlg In1 Tune	259	Analog Inputs	<a href="#">196</a>
Anlg In2 Config	76	Analog Inputs	<a href="#">195</a>
Anlg In2 Filter	801	Analog Inputs	<a href="#">196</a>
Anlg In2 Offset	79	Analog Inputs	<a href="#">196</a>
Anlg In2 Scale	77	Analog Inputs	<a href="#">195</a>
Anlg In2 Sel	75	Analog Inputs	<a href="#">195</a>
Anlg In2 Target	296	Analog Inputs	<a href="#">196</a>
Anlg In2 Tune	260	Analog Inputs	<a href="#">196</a>
Anlg In3 Config	81	Analog Inputs	<a href="#">195</a>
Anlg In3 Filter	802	Analog Inputs	<a href="#">196</a>
Anlg In3 Offset	84	Analog Inputs	<a href="#">196</a>
Anlg In3 Scale	82	Analog Inputs	<a href="#">195</a>
Anlg In3 Sel	80	Analog Inputs	<a href="#">195</a>
Anlg In3 Target	297	Analog Inputs	<a href="#">196</a>
Anlg In3 Tune	261	Analog Inputs	<a href="#">196</a>
Anlg Out1 Scale	62	Analog Outputs	<a href="#">197</a>
Anlg Out1 Sel	66	Analog Outputs	<a href="#">198</a>
Anlg Out2 Scale	63	Analog Outputs	<a href="#">197</a>
Anlg Out2 Sel	67	Analog Outputs	<a href="#">198</a>
Anlg Out3 Scale	64	Analog Outputs	<a href="#">197</a>
Anlg Out3 Sel	68	Analog Outputs	<a href="#">198</a>
Anlg Out4 Scale	65	Analog Outputs	<a href="#">197</a>
Anlg Out4 Sel	69	Analog Outputs	<a href="#">198</a>
Anlg Tach Gain	562	Speed Feedback	<a href="#">142</a>
Anlg1 Tune Scale	73	Analog Inputs	<a href="#">195</a>
Anlg2 Tune Scale	78	Analog Inputs	<a href="#">195</a>
Anlg3 Tune Scale	83	Analog Inputs	<a href="#">195</a>
Arm Current	200	Current Meters	<a href="#">128</a>
Arm Current Pct	199	Current Meters	<a href="#">128</a>
Arm Inductance	454	Autotune	<a href="#">143</a>
Arm Resistance	453	Autotune	<a href="#">143</a>
Arm Test Angle	167	Test Generator	<a href="#">146</a>
Arm Volt Ki	494	Field Config	<a href="#">134</a>
Arm Volt Ki Base	496	Field Config	<a href="#">135</a>
Arm Volt Kp	493	Field Config	<a href="#">134</a>
Arm Volt Kp Base	495	Field Config	<a href="#">135</a>
At Speed	394	Diagnostics	<a href="#">180</a>
At Speed Delay	105	Speed Regulator	<a href="#">150</a>
At Speed Error	104	Speed Regulator	<a href="#">150</a>
At Zero Speed	395	Diagnostics	<a href="#">180</a>
Autotune Cur Lim	1048	Auto Tune	<a href="#">145</a>
Aux Inp Flt Cfg	354	Alarms	<a href="#">185</a>

Name	No.	Group	Page
Base Omega	1163	Diameter Calc	<a href="#">167</a>
Brake Test Torq	1114	Torque Prove	<a href="#">175</a>
Brk Alarm Travel	1109	Torque Prove	<a href="#">174</a>
Brk Release Time	1107	Torque Prove	<a href="#">174</a>
Brk Set Time	1108	Torque Prove	<a href="#">174</a>
Brk Slip Count	1110	Torque Prove	<a href="#">174</a>
Clear Fault Que	263	Faults	<a href="#">184</a>
Close Loop Comp	1208	Winder Functions	<a href="#">170</a>
Closed Loop En	1214	Winder Functions	<a href="#">171</a>
Closing Speed	1262	Stop Modes	<a href="#">158</a>
Constant J Comp	1172	Winder Functions	<a href="#">168</a>
ContactControl	1391	Digital Inputs	<a href="#">202</a>
Cur Lim Neg Out	11	Current Meters	<a href="#">128</a>
Cur Lim Pos Out	10	Current Meters	<a href="#">128</a>
Current Lim Neg	9	Torq Attributes	<a href="#">136</a>
Current Lim Pos	8	Torq Attributes	<a href="#">136</a>
Current Limit	7	Torq Attributes	<a href="#">136</a>
Current Rate Lim	12	Torq Attributes	<a href="#">136</a>
Current Reg In	41	Current Meters	<a href="#">128</a>
CurrLimit Active	349	Diagnostics	<a href="#">178</a>
CurrReg Autotune	452	Autotune	<a href="#">143</a>
Dancer Constant	798	Init Diam Calc	<a href="#">166</a>
Data In A1	610	Datalinks	<a href="#">193</a>
Data In A2	611	Datalinks	<a href="#">193</a>
Data In B1	612	Datalinks	<a href="#">193</a>
Data In B2	613	Datalinks	<a href="#">193</a>
Data In C1	614	Datalinks	<a href="#">193</a>
Data In C2	615	Datalinks	<a href="#">193</a>
Data In D1	616	Datalinks	<a href="#">193</a>
Data In D2	617	Datalinks	<a href="#">193</a>
Data In SelData	1320	Datalinks	<a href="#">193</a>
Data In Val Sel	1319	Datalinks	<a href="#">193</a>
Data Out A1	618	Datalinks	<a href="#">193</a>
Data Out A2	619	Datalinks	<a href="#">193</a>
Data Out B1	620	Datalinks	<a href="#">193</a>
Data Out B2	621	Datalinks	<a href="#">193</a>
Data Out C1	622	Datalinks	<a href="#">193</a>
Data Out C2	623	Datalinks	<a href="#">193</a>
Data Out D1	624	Datalinks	<a href="#">193</a>
Data Out D2	625	Datalinks	<a href="#">193</a>
Decel Mask	631	Masks & Owners	<a href="#">193</a>
Decel Owner	609	Masks & Owners	<a href="#">192</a>
Decel Status	1189	Winder Functions	<a href="#">169</a>
Decel Time 1	662	Ramp Rates	<a href="#">157</a>
Decel Time 2	32	Ramp Rates	<a href="#">156</a>
Diam Calc Dis	1161	Diameter Calc	<a href="#">166</a>
Diam Inc Dec En	1205	Diameter Calc	<a href="#">168</a>

Name	No.	Group	Page
Diam Init Filter	1206	Diameter Calc	<a href="#">168</a>
Diam Preset 0	1164	Diameter Calc	<a href="#">167</a>
Diam Preset 1	1165	Diameter Calc	<a href="#">167</a>
Diam Preset 2	1166	Diameter Calc	<a href="#">167</a>
Diam Preset 3	1167	Diameter Calc	<a href="#">167</a>
Diam Preset Sel	1168	Diameter Calc	<a href="#">167</a>
Diam Stdy Delay	1207	Diameter Calc	<a href="#">168</a>
Diam Threshold	1158	Diameter Calc	<a href="#">166</a>
Diameter Calc	794	Init Diam Calc	<a href="#">165</a>
Diameter Calc St	800	Init Diam Calc	<a href="#">166</a>
Diameter Filter	1162	Diameter Calc	<a href="#">167</a>
Diameter Reached	1159	Diameter Calc	<a href="#">166</a>
Diameter Reset	1157	Diameter Calc	<a href="#">166</a>
Dig In Status	564	Digital Inputs	<a href="#">202</a>
Dig In Term 1	565	Digital Inputs	<a href="#">202</a>
Dig In Term 10	574	Digital Inputs	<a href="#">202</a>
Dig In Term 11	575	Digital Inputs	<a href="#">202</a>
Dig In Term 12	576	Digital Inputs	<a href="#">202</a>
Dig In Term 2	566	Digital Inputs	<a href="#">202</a>
Dig In Term 3	567	Digital Inputs	<a href="#">202</a>
Dig In Term 4	568	Digital Inputs	<a href="#">202</a>
Dig In Term 5	569	Digital Inputs	<a href="#">202</a>
Dig In Term 6	570	Digital Inputs	<a href="#">202</a>
Dig In Term 7	571	Digital Inputs	<a href="#">202</a>
Dig In Term 8	572	Digital Inputs	<a href="#">202</a>
Dig In Term 9	573	Digital Inputs	<a href="#">202</a>
Dig Out Status	581	Digital Outputs	<a href="#">205</a>
Digital In1 Sel	133	Digital Inputs	<a href="#">199</a>
Digital In10 Sel	142	Digital Inputs	<a href="#">199</a>
Digital In11 Sel	143	Digital Inputs	<a href="#">199</a>
Digital In12 Sel	144	Digital Inputs	<a href="#">199</a>
Digital In2 Sel	134	Digital Inputs	<a href="#">199</a>
Digital In3 Sel	135	Digital Inputs	<a href="#">199</a>
Digital In4 Sel	136	Digital Inputs	<a href="#">199</a>
Digital In5 Sel	137	Digital Inputs	<a href="#">199</a>
Digital In6 Sel	138	Digital Inputs	<a href="#">199</a>
Digital In7 Sel	139	Digital Inputs	<a href="#">199</a>
Digital In8 Sel	140	Digital Inputs	<a href="#">199</a>
Digital In9 Sel	141	Digital Inputs	<a href="#">199</a>
Digital Out1 Sel	145	Digital Outputs	<a href="#">203</a>
Digital Out2 Sel	146	Digital Outputs	<a href="#">203</a>
Digital Out3 Sel	147	Digital Outputs	<a href="#">203</a>
Digital Out4 Sel	148	Digital Outputs	<a href="#">203</a>
Digital Out5 Sel	149	Digital Outputs	<a href="#">203</a>
Digital Out6 Sel	150	Digital Outputs	<a href="#">203</a>
Digital Out7 Sel	151	Digital Outputs	<a href="#">203</a>
Digital Out8 Sel	152	Digital Outputs	<a href="#">203</a>
Direction Mask	594	Masks & Owners	<a href="#">192</a>
Direction Mode	1322	Reference Config	<a href="#">177</a>
Direction Owner	603	Masks & Owners	<a href="#">192</a>

Name	No.	Group	Page
DncrPosSpd	795	Init Diam Calc	<a href="#">165</a>
DPI Baud Rate	589	Comm Control	<a href="#">191</a>
DPI Fdbk Select	1321	Comm Control	<a href="#">191</a>
DPI P1 Select	1323	DPI Inputs	<a href="#">206</a>
DPI P2 Select	1324	DPI Inputs	<a href="#">206</a>
DPI P3 Select	1325	DPI Inputs	<a href="#">206</a>
DPI P4 Select	1326	DPI Inputs	<a href="#">206</a>
DPI P5 Select	1327	DPI Inputs	<a href="#">206</a>
DPI Port Sel	590	Comm Control	<a href="#">191</a>
DPI Port Value	1343	Comm Control	<a href="#">191</a>
Drive Alarm 1	1380	Alarms	<a href="#">187</a>
Drive Alarm 2	1394	Alarms	<a href="#">188</a>
Drive Checksum	332	Drive Data	<a href="#">130</a>
Drive Logic Rslt	1328	Diagnostics	<a href="#">182</a>
Drive Size	465	Drive Data	<a href="#">130</a>
Drive Status 1	381	Diagnostics	<a href="#">179</a>
Drive Status 2	382	Diagnostics	<a href="#">180</a>
Drive Type	300	Drive Data	<a href="#">129</a>
Drive Type Sel	201	Motor Data	<a href="#">131</a>
Droop Filter	697	Load Limits	<a href="#">157</a>
Droop Limit	700	Load Limits	<a href="#">158</a>
Droop Out	1006	Speed Meters	<a href="#">127</a>
Droop Out Pct	1007	Speed Meters	<a href="#">127</a>
Droop Percent	696	Load Limits	<a href="#">157</a>
Drv Fld Brdg Cur	374	Motor Data	<a href="#">132</a>
Dynamic Friction	1175	Winder Functions	<a href="#">168</a>
Elapsed Lifetime	235	Drive Data	<a href="#">129</a>
Enable Droop	699	Load Limits	<a href="#">158</a>
Enable PD	770	PD Control	<a href="#">163</a>
Enable PI	769	PI Control	<a href="#">161</a>
Enable PI PD	1258	PID Control	<a href="#">165</a>
Encoder Config	170	Speed Feedback	<a href="#">138</a>
Encoder Counts	1022	Speed Feedback	<a href="#">143</a>
Encoder Err Chk	652	Speed Feedback	<a href="#">142</a>
Encoder Out Sel	1021	Speed Feedback	<a href="#">143</a>
Encoder PPR	169	Speed Feedback	<a href="#">138</a>
Encoder Speed	420	Speed Meters	<a href="#">127</a>
Ext FC Curr Hyst	410	Field Config	<a href="#">133</a>
Fast Stop Status	1190	Winder Functions	<a href="#">169</a>
Fast Stop Time	38	Stop Modes	<a href="#">158</a>
Fault 1 Code	1351	Faults	<a href="#">184</a>
Fault 1 Time	1361	Faults	<a href="#">185</a>
Fault 10 Code	1360	Faults	<a href="#">184</a>
Fault 10 Time	1370	Faults	<a href="#">185</a>
Fault 2 Code	1352	Faults	<a href="#">184</a>
Fault 2 Time	1362	Faults	<a href="#">185</a>
Fault 3 Code	1353	Faults	<a href="#">184</a>
Fault 3 Time	1363	Faults	<a href="#">185</a>

Name	No.	Group	Page
Fault 4 Code	1354	Faults	<a href="#">184</a>
Fault 4 Time	1364	Faults	<a href="#">185</a>
Fault 5 Code	1355	Faults	<a href="#">184</a>
Fault 5 Time	1365	Faults	<a href="#">185</a>
Fault 6 Code	1356	Faults	<a href="#">184</a>
Fault 6 Time	1366	Faults	<a href="#">185</a>
Fault 7 Code	1357	Faults	<a href="#">184</a>
Fault 7 Time	1367	Faults	<a href="#">185</a>
Fault 8 Code	1358	Faults	<a href="#">184</a>
Fault 8 Time	1368	Faults	<a href="#">185</a>
Fault 9 Code	1359	Faults	<a href="#">184</a>
Fault 9 Time	1369	Faults	<a href="#">185</a>
Fault Arm Amps	1371	Faults	<a href="#">185</a>
Fault Clear	1347	Faults	<a href="#">184</a>
Fault Clr Mask	597	Masks & Owners	<a href="#">192</a>
Fault Clr Mode	1348	Faults	<a href="#">184</a>
Fault Clr Owner	606	Masks & Owners	<a href="#">192</a>
Fault Field Amps	1373	Diagnostics	<a href="#">185</a>
Fault Speed	1372	Diagnostics	<a href="#">185</a>
Fault Voltage	1374	Diagnostics	<a href="#">185</a>
FaultCode	57	Drive Data	<a href="#">129</a>
FC Lim Ramp	411	Tor Attributes	<a href="#">137</a>
FC Lim Ramp Time	412	Tor Attributes	<a href="#">137</a>
Fdbk Device Type	414	Speed Feedback	<a href="#">138</a>
Fdbk Option ID	422	Speed Feedback	<a href="#">138</a>
Feed Fwd PID	758	PID Control	<a href="#">163</a>
Feedback Offset	563	Speed Feedback	<a href="#">142</a>
Field Current	351	Current Meters	<a href="#">129</a>
Field Curve Out	476	Current Meters	<a href="#">129</a>
Field Econ Delay	1407	Field Config	<a href="#">136</a>
Field Economy En	499	Field Config	<a href="#">135</a>
Field Mode Sel	469	Field Config	<a href="#">134</a>
Field Reg Enable	497	Field Config	<a href="#">135</a>
Filt TorqCur Pct	928	Current Meters	<a href="#">129</a>
Final Diameter	1178	Winder Functions	<a href="#">169</a>
Float Tolerance	1111	Torque Prove	<a href="#">174</a>
Firing Angle	165	Drive Data	<a href="#">129</a>
Fld Const 40 Pct	916	Field Config	<a href="#">135</a>
Fld Const 70 Pct	917	Field Config	<a href="#">135</a>
Fld Const 90 Pct	918	Field Config	<a href="#">135</a>
Fld Current Pct	234	Current Meters	<a href="#">129</a>
Fld Reg Ki	92	Field Config	<a href="#">133</a>
Fld Reg Ki Base	98	Field Config	<a href="#">133</a>
Fld Reg Kp	91	Field Config	<a href="#">133</a>
Fld Reg Kp Base	97	Field Config	<a href="#">133</a>
Fld Test Angle	168	Test Generator	<a href="#">146</a>
Fld Weaken Ratio	456	Field Config	<a href="#">133</a>
FldLoss Flt Cfg	473	Alarms	<a href="#">186</a>
FldLoss Flt Dly	475	Alarms	<a href="#">186</a>

Name	No.	Group	Page
Flux Divide	462	Field Config	<a href="#">133</a>
Flux Filter BW	463	Field Config	<a href="#">133</a>
Flux Ref Pct	500	Current Meters	<a href="#">129</a>
Flying Start En	388	Speed Regulator	<a href="#">152</a>
Force Min Field	498	Field Config	<a href="#">135</a>
Freeze Ramp	373	Ramp Rates	<a href="#">156</a>
Friction	1015	Autotune	<a href="#">144</a>
Gear Box Ratio	797	Init Diam Calc	<a href="#">165</a>
I Reg Error	587	Autotune	<a href="#">143</a>
Inertia	1014	Autotune	<a href="#">144</a>
Inertia C Filter	1012	Autotune	<a href="#">143</a>
Inertia Comp Out	232	Current Meters	<a href="#">129</a>
InertiaCompCnst	1191	Winder Functions	<a href="#">170</a>
InertiaCompVar	1192	Winder Functions	<a href="#">170</a>
Initial Diameter	1177	Winder Functions	<a href="#">169</a>
Int Acc Calc En	1183	Winder Functions	<a href="#">169</a>
Inversion In 1	1276	Digital Inputs	<a href="#">202</a>
Inversion In 10	1388	Digital Inputs	<a href="#">202</a>
Inversion In 11	1389	Digital Inputs	<a href="#">202</a>
Inversion In 12	1390	Digital Inputs	<a href="#">202</a>
Inversion In 2	1277	Digital Inputs	<a href="#">202</a>
Inversion In 3	1278	Digital Inputs	<a href="#">202</a>
Inversion In 4	1279	Digital Inputs	<a href="#">202</a>
Inversion In 5	1280	Digital Inputs	<a href="#">202</a>
Inversion In 6	1281	Digital Inputs	<a href="#">202</a>
Inversion In 7	1282	Digital Inputs	<a href="#">202</a>
Inversion In 8	1283	Digital Inputs	<a href="#">202</a>
Inversion In 9	1387	Digital Inputs	<a href="#">202</a>
Inversion Out 1	1267	Digital Outputs	<a href="#">205</a>
Inversion Out 2	1268	Digital Outputs	<a href="#">205</a>
Inversion Out 3	1269	Digital Outputs	<a href="#">205</a>
Inversion Out 4	1270	Digital Outputs	<a href="#">205</a>
Inversion Out 5	1271	Digital Outputs	<a href="#">205</a>
Inversion Out 6	1272	Digital Outputs	<a href="#">205</a>
Inversion Out 7	1273	Digital Outputs	<a href="#">205</a>
Inversion Out 8	1274	Digital Outputs	<a href="#">205</a>
Inversion Relay1	1393	Digital Outputs	<a href="#">206</a>
Inversion Relay2	1275	Digital Outputs	<a href="#">205</a>
Jog Mask	593	Masks & Owners	<a href="#">192</a>
Jog Owner	602	Masks & Owners	<a href="#">192</a>
Jog Off Delay	1409	Discrete Speeds	<a href="#">149</a>
Jog Ramp Time	1410	Ramp Rates	<a href="#">157</a>
Jog Speed	266	Discrete Speeds	<a href="#">148</a>
Jog TW Enable	1256	Winder Functions	<a href="#">171</a>
Jog TW Speed	1255	Winder Functions	<a href="#">171</a>

Name	No.	Group	Page
Language	302	Drive Memory	<a href="#">177</a>
Last Stop Source	1402	Diagnostics	<a href="#">183</a>
Line Accel Pct	1184	Winder Functions	<a href="#">169</a>
Line Decel Pct	1185	Winder Functions	<a href="#">169</a>
Line FastStp Pct	1186	Winder Functions	<a href="#">169</a>
Line Spd Gain	1156	Diameter Calc	<a href="#">166</a>
Line Spd Source	1204	Diameter Calc	<a href="#">168</a>
Line Spd Thresh	1155	Diameter Calc	<a href="#">166</a>
Line Speed Pct	1160	Diameter Calc	<a href="#">166</a>
Load Comp	698	Load Limits	<a href="#">157</a>
Local Mask	599	Masks & Owners	<a href="#">192</a>
Local Owner	608	Masks & Owners	<a href="#">192</a>
Lock Speed Integ	348	Speed Regulator	<a href="#">152</a>
Logic Mask	591	Masks & Owners Security	<a href="#">191</a> <a href="#">193</a>
Logic Mask Act	1376	Security	<a href="#">193</a>
Man Ref Preload	210	HIM Ref Config	<a href="#">177</a>
Materl Width Pct	1173	Winder Functions	<a href="#">168</a>
Max Deviation	796	Init Diam Calc	<a href="#">165</a>
Max Diameter	1153	Diameter Calc	<a href="#">166</a>
Max Feedback Spd	162	Motor Data	<a href="#">131</a>
Max Fld Flux Pct	467	Field Config	<a href="#">134</a>
Max Ref Speed	45	Motor Data	<a href="#">131</a>
Max Speed Fwd	3	Limits	<a href="#">148</a>
Max Speed Rev	4	Limits	<a href="#">148</a>
Maximum Speed	2	Limits	<a href="#">148</a>
MicroPsnScalePct	1112	Torque Prove	<a href="#">174</a>
Min Fld Curr Pct	468	Field Config	<a href="#">134</a>
Min Firing Angle	21	Motor Data	<a href="#">131</a>
Min Speed Fwd	5	Limits	<a href="#">148</a>
Min Speed Rev	6	Limits	<a href="#">148</a>
Minimum Diameter	799	Init Diam Calc / Diameter Calc	<a href="#">166</a>
Minimum Speed	1	Limits	<a href="#">148</a>
MOP Accel Time	22	Ramp Rates	<a href="#">156</a>
MOP Dec Active	397	Diagnostics	<a href="#">181</a>
MOP Decel Time	30	Ramp Rates	<a href="#">156</a>
MOP Inc Active	396	Diagnostics	<a href="#">180</a>
MOP Mask	598	Masks & Owners	<a href="#">192</a>
MOP Owner	607	Masks & Owners	<a href="#">192</a>
MOP Ref Config	249	Reference Config	<a href="#">177</a>
MOP Select	1375	Reference Config	<a href="#">177</a>
Motor Trq Ref	17	Current Meters	<a href="#">128</a>
MtrOvrld Factor	333	Motor Data	<a href="#">132</a>
MtrOvrld Flt Cfg	479	Alarms	<a href="#">186</a>
MtrOvrld Speed	334	Motor Data	<a href="#">132</a>
MtrOvrld Status	1290	Diagnostics	<a href="#">181</a>

Name	No.	Group	Page
MtrOvrld Type	376	Motor Data	<a href="#">156</a>
Nom Mtr Arm Amps	179	Motor Data	<a href="#">131</a>
Nom Mtr Fld Amps	280	Motor Data	<a href="#">132</a>
Offs Accel Time	1198	Winder Functions	<a href="#">170</a>
Opening Delay	1263	Stop Modes	<a href="#">158</a>
OpenSCR Flt Cfg	216	Test Generator	<a href="#">147</a>
OpenSCR Threshld	217	Test Generator	<a href="#">147</a>
OpenSCR Trip Lvl	218	Test Generator	<a href="#">147</a>
OpenSCR WarnLvl	215	Test Generator	<a href="#">147</a>
Out Volt Level	921	Field Config	<a href="#">136</a>
Output Power	1052	Drive Data	<a href="#">130</a>
Output Voltage	233	Drive Data	<a href="#">129</a>
OverCurrent Thr	584	Alarms	<a href="#">187</a>
Overspeed Val	585	Alarms	<a href="#">187</a>
OverTemp Flt Cfg	365	Alarms	<a href="#">185</a>
OverVolt Flt Cfg	203	Alarms	<a href="#">185</a>
Param Access Lvl	211	Drive Memory	<a href="#">177</a>
PD Deriv Filter	767	PD Control	<a href="#">162</a>
PD Deriv Gain 1	766	PD Control	<a href="#">162</a>
PD Deriv Gain 2	789	PD Control	<a href="#">163</a>
PD Deriv Gain 3	791	PD Control	<a href="#">163</a>
PD Output PID	421	PD Control	<a href="#">162</a>
PD Prop Gain 1	768	PD Control	<a href="#">163</a>
PD Prop Gain 2	788	PD Control	<a href="#">163</a>
PD Prop Gain 3	790	PD Control	<a href="#">163</a>
PI Central v sel	779	PI Control	<a href="#">162</a>
PI Central v1	776	PI Control	<a href="#">161</a>
PI Central v2	777	PI Control	<a href="#">161</a>
PI Central v3	778	PI Control	<a href="#">161</a>
PI Central vs0	780	PI Control	<a href="#">162</a>
PI Central vs1	781	PI Control	<a href="#">162</a>
PI Init Intgl Gn	734	PI Control	<a href="#">161</a>
PI Init Prop Gn	793	PI Control	<a href="#">162</a>
PI integr freeze	783	PI Control	<a href="#">162</a>
PI Integral Gain	764	PI Control	<a href="#">161</a>
PI Lower Limit	785	PI Control	<a href="#">162</a>
PI Output	771	PI Control	<a href="#">161</a>
PI Prop Gain PID	765	PI Control	<a href="#">161</a>
PI Steady Thr	695	PI Control	<a href="#">161</a>
PI Upper Limit	784	PI Control	<a href="#">162</a>
PID Accel Time	1046	PID Control	<a href="#">165</a>
PID Clamp	757	PID Control	<a href="#">163</a>
PID Decel Time	1047	PID Control	<a href="#">165</a>
PID Error	759	PID Control	<a href="#">163</a>
PID Error Gain	1254	PID Control	<a href="#">165</a>
PID Feedback	763	PID Control	<a href="#">164</a>
PID Output	774	PID Control	<a href="#">164</a>
PID Output Scale	773	PID Control	<a href="#">164</a>
PID Output Sign	772	PID Control	<a href="#">164</a>



Name	No.	Group	Page
PID Setpoint 0	760	PID Control	<a href="#">163</a>
PID Setpoint 1	761	PID Control	<a href="#">163</a>
PID Setpoint Sel	762	PID Control	<a href="#">163</a>
PID Source	786	PID Control	<a href="#">165</a>
PID Source Gain	787	PID Control	<a href="#">165</a>
PID Steady Delay	731	PI Control	<a href="#">161</a>
PID Target	782	PID Control	<a href="#">164</a>
Port Mask Act	1379	Security	<a href="#">194</a>
Powerup Delay	1345	Restart Modes	<a href="#">159</a>
Preset Speed 1	154	Discrete Speeds	<a href="#">148</a>
Preset Speed 2	155	Discrete Speeds	<a href="#">148</a>
Preset Speed 3	156	Discrete Speeds	<a href="#">148</a>
Preset Speed 4	157	Discrete Speeds	<a href="#">148</a>
Preset Speed 5	158	Discrete Speeds	<a href="#">148</a>
Preset Speed 6	159	Discrete Speeds	<a href="#">148</a>
Preset Speed 7	160	Discrete Speeds	<a href="#">148</a>
Ramp Delay	20	Ramp Rates	<a href="#">156</a>
Ramp In	110	Speed Meters	<a href="#">126</a>
Ramp In Pct	111	Speed Meters	<a href="#">126</a>
Ramp In Zero En	1265	Stop Modes	<a href="#">158</a>
Ramp Out	113	Speed Meters	<a href="#">126</a>
Ramp Out Pct	114	Speed Meters	<a href="#">126</a>
Ramp Select 0	403	Diagnostics	<a href="#">181</a>
Ramp Select 1	404	Diagnostics	<a href="#">181</a>
Ramp Type Select	18	Ramp Rates	<a href="#">155</a>
Rated Motor Volt	175	Motor Data	<a href="#">131</a>
Real FF PID	418	PID Control	<a href="#">163</a>
Ref Line Speed	1286	Winder Functions	<a href="#">172</a>
Ref Spd Source	1284	Winder Functions	<a href="#">172</a>
Ref Speed Gain	1285	Winder Functions	<a href="#">172</a>
Ref Zero Level	106	Speed Regulator	<a href="#">150</a>
Reference Mask	595	Masks & Owners	<a href="#">192</a>
Reference Owner	604	Masks & Owners	<a href="#">192</a>
Relay Out 1 Sel	1392	Digital Outputs	<a href="#">206</a>
Relay Out 2 Sel	629	Digital Outputs	<a href="#">205</a>
Reset Defaults	258	Drive Memory	<a href="#">177</a>
Reset Fld Curve	920	Field Config	<a href="#">136</a>
Reslvr Cable Bal	431	Speed Feedback	<a href="#">141</a>
Reslvr Error Cnt	432	Diagnostics	<a href="#">181</a>
Reslvr Position	427	Speed Feedback	<a href="#">141</a>
Reslvr Spd Ratio	424	Speed Feedback	<a href="#">139</a>
Reslvr Type Sel	423	Speed Feedback	<a href="#">139</a>
Resolver Config	425	Speed Feedback	<a href="#">140</a>
Resolver Pos Sel	429	Speed Feedback	<a href="#">141</a>
Resolver Spd Sel	430	Speed Feedback	<a href="#">141</a>
Resolver Speed	428	Speed Meters	<a href="#">127</a>
Resolver Status	426	Speed Feedback	<a href="#">141</a>
Roll Diameter	1154	Diameter Calc	<a href="#">166</a>

Name	No.	Group	Page
S Curve Accel 1	665	Ramp Rates	<a href="#">157</a>
S Curve Accel 2	667	Ramp Rates	<a href="#">157</a>
S Curve Decel 1	666	Ramp Rates	<a href="#">157</a>
S Curve Decel 2	668	Ramp Rates	<a href="#">157</a>
S Curve Time	19	Ramp Rates	<a href="#">155</a>
SAR Volts Scale	464	Motor Data	<a href="#">133</a>
Save HIM Ref	209	HIM Ref Config	<a href="#">177</a>
Scale1 Div	487	Scale Blocks	<a href="#">175</a>
Scale1 In Abs	492	Scale Blocks	<a href="#">176</a>
Scale1 In Max	488	Scale Blocks	<a href="#">175</a>
Scale1 In Min	489	Scale Blocks	<a href="#">175</a>
Scale1 In Off	490	Scale Blocks	<a href="#">176</a>
Scale1 Input	484	Scale Blocks	<a href="#">175</a>
Scale1 Mul	486	Scale Blocks	<a href="#">175</a>
Scale1 Out Off	491	Scale Blocks	<a href="#">176</a>
Scale1 Output	485	Scale Blocks	<a href="#">175</a>
Scale2 Div	556	Scale Blocks	<a href="#">175</a>
Scale2 In Abs	561	Scale Blocks	<a href="#">176</a>
Scale2 In Max	557	Scale Blocks	<a href="#">175</a>
Scale2 In Min	558	Scale Blocks	<a href="#">175</a>
Scale2 In Off	559	Scale Blocks	<a href="#">176</a>
Scale2 Input	553	Scale Blocks	<a href="#">175</a>
Scale2 Mul	555	Scale Blocks	<a href="#">175</a>
Scale2 Out Off	560	Scale Blocks	<a href="#">176</a>
Scale2 Output	554	Scale Blocks	<a href="#">175</a>
Scale3 Div	1221	Scale Blocks	<a href="#">175</a>
Scale3 In Abs	1226	Scale Blocks	<a href="#">176</a>
Scale3 In Max	1222	Scale Blocks	<a href="#">175</a>
Scale3 In Min	1223	Scale Blocks	<a href="#">175</a>
Scale3 In Off	1224	Scale Blocks	<a href="#">176</a>
Scale3 Input	1218	Scale Blocks	<a href="#">175</a>
Scale3 Mul	1220	Scale Blocks	<a href="#">175</a>
Scale3 Out Off	1225	Scale Blocks	<a href="#">176</a>
Scale3 Output	1219	Scale Blocks	<a href="#">175</a>
Scale4 Div	1230	Scale Blocks	<a href="#">175</a>
Scale4 In Abs	1235	Scale Blocks	<a href="#">176</a>
Scale4 In Max	1231	Scale Blocks	<a href="#">175</a>
Scale4 In Min	1232	Scale Blocks	<a href="#">175</a>
Scale4 In Off	1233	Scale Blocks	<a href="#">176</a>
Scale4 Input	1227	Scale Blocks	<a href="#">175</a>
Scale4 Mul	1229	Scale Blocks	<a href="#">175</a>
Scale4 Out Off	1234	Scale Blocks	<a href="#">176</a>
Scale4 Output	1228	Scale Blocks	<a href="#">175</a>
Scale5 Div	1239	Scale Blocks	<a href="#">175</a>
Scale5 In Abs	1244	Scale Blocks	<a href="#">176</a>
Scale5 In Max	1240	Scale Blocks	<a href="#">175</a>
Scale5 In Min	1241	Scale Blocks	<a href="#">175</a>
Scale5 In Off	1242	Scale Blocks	<a href="#">176</a>
Scale5 Input	1237	Scale Blocks	<a href="#">175</a>
Scale5 Mul	1238	Scale Blocks	<a href="#">175</a>

Name	No.	Group	Page
Scale5 Out Off	1243	Scale Blocks	<a href="#">176</a>
Scale5 Output	1236	Scale Blocks	<a href="#">175</a>
Scale6 Div	1248	Scale Blocks	<a href="#">175</a>
Scale6 In Abs	1253	Scale Blocks	<a href="#">176</a>
Scale6 In Max	1249	Scale Blocks	<a href="#">175</a>
Scale6 In Min	1250	Scale Blocks	<a href="#">175</a>
Scale6 In Off	1251	Scale Blocks	<a href="#">176</a>
Scale6 Input	1246	Scale Blocks	<a href="#">175</a>
Scale6 Mul	1247	Scale Blocks	<a href="#">175</a>
Scale6 Out Off	1252	Scale Blocks	<a href="#">176</a>
Scale6 Output	1245	Scale Blocks	<a href="#">175</a>
SCR Diag Status	213	Test Generator	<a href="#">146</a>
SCR Diag Test En	214	Test Generator	<a href="#">147</a>
Selected TorqRef	14	Current Meters	<a href="#">157</a>
Set Fld Curve	919	Field Config	<a href="#">135</a>
SLAT Dwell Time	16	Control Config	<a href="#">155</a>
SLAT Err Stpt	15	Control Config	<a href="#">155</a>
Software Version	331	Configuration	<a href="#">130</a>
Spd Band Intgrtr	1106	Torque Prove	<a href="#">174</a>
Spd 0 Trip Delay	627	Stop Modes	<a href="#">158</a>
Spd Draw Out Pct	1019	Speed Meters	<a href="#">128</a>
Spd FB Filt BW	915	Speed Feedback	<a href="#">143</a>
Spd FB Filt Gain	914	Speed Feedback	<a href="#">143</a>
Spd FB Loss Lvl	455	Speed Feedback	<a href="#">141</a>
Spd Fdbk Control	457	Speed Feedback	<a href="#">142</a>
Spd Fdbk State	651	Diagnostics	<a href="#">181</a>
Spd Reg Err	1010	Speed Meters	<a href="#">128</a>
Spd Reg Err Pct	1011	Speed Meters	<a href="#">128</a>
Spd Reg Fdbk	1008	Speed Meters	<a href="#">127</a>
Spd Reg Fdbk Pct	1009	Speed Meters	<a href="#">127</a>
Spd Reg P Filter	444	Speed Regulator	<a href="#">153</a>
Spd Fdbk Invert	461	Speed Feedback	<a href="#">142</a>
Spd Feedback	122	Speed Meters	<a href="#">127</a>
Spd Feedback Pct	121	Speed Meters	<a href="#">127</a>
Spd Limit Active	372	Diagnostics	<a href="#">178</a>
Spd Loss Flt Cfg	478	Alarms	<a href="#">186</a>
Spd Match Acc	1196	Winder Functions	<a href="#">170</a>
Spd Match Compl	1203	Winder Functions	<a href="#">170</a>
Spd Match Dec	1197	Winder Functions	<a href="#">170</a>
Spd Match Gain	1200	Winder Functions	<a href="#">170</a>
Spd Match Torque	1216	Winder Functions	<a href="#">171</a>
Spd Ref Out Pct	384	Speed Meters	<a href="#">127</a>
Spd Ref Sel Sts	1330	Diagnostics	<a href="#">183</a>
Spd Ref Zero En	124	Speed Regulator	<a href="#">151</a>
Spd Reg Autotune	1027	Autotune	<a href="#">144</a>
Spd Reg BW	434	Speed Regulator	<a href="#">152</a>

Name	No.	Group	Page
Spd Reg Damping	436	Speed Regulator	<a href="#">153</a>
Spd Reg Ki	88	Speed Regulator	<a href="#">149</a>
Spd Reg Ki Base	94	Autotune	<a href="#">143</a>
Spd Reg Ki Outpt	100	Speed Regulator	<a href="#">150</a>
Spd Reg Kp	87	Speed Regulator	<a href="#">149</a>
Spd Reg Kp Base	93	Autotune	<a href="#">143</a>
Spd Reg Kp Outpt	99	Speed Regulator	<a href="#">149</a>
Spd Reg Neg Lim	96	Speed Regulator	<a href="#">149</a>
Spd Reg Out Pct	236	Speed Regulator	<a href="#">127</a>
Spd Reg Pos Lim	95	Speed Regulator	<a href="#">149</a>
Spd Select 0	400	Diagnostics	<a href="#">181</a>
Spd Select 1	401	Diagnostics	<a href="#">181</a>
Spd Select 2	402	Diagnostics	<a href="#">181</a>
Spd Trq Mode Sel	241	Control Config	<a href="#">152</a>
Spd Tune Inertia	1030	Autotune	<a href="#">144</a>
Spd Up Gain Pct	445	Speed Regulator	<a href="#">153</a>
Spd Zero I En	123	Speed Regulator	<a href="#">151</a>
Spd Zero P En	125	Speed Regulator	<a href="#">151</a>
SpdFuncSelect	1016	Speed Regulator	<a href="#">154</a>
SpdReg AntiBckup	643	Speed Regulator	<a href="#">154</a>
SpdReg BW Bypass	448	Speed Regulator	<a href="#">153</a>
SpdOut FiltBW	239	Speed Regulator	<a href="#">152</a>
SpdOut FiltGain	238	Speed Regulator	<a href="#">152</a>
SpdReg FB Bypass	458	Speed Feedback	<a href="#">142</a>
SpdReg Ki Bypass	460	Speed Regulator	<a href="#">154</a>
SpdReg Ki Pct	1035	Autotune	<a href="#">144</a>
SpdReg Kp Bypass	459	Speed Regulator	<a href="#">154</a>
SpdReg Kp Pct	1034	Autotune	<a href="#">144</a>
SpdReg NegLmOut	90	Current Meters	<a href="#">128</a>
SpdReg PosLmOut	89	Current Meters	<a href="#">128</a>
SpdTune Friction	1031	Autotune	<a href="#">144</a>
Speed Demand En	1215	Winder Functions	<a href="#">171</a>
Speed Dev Band	1105	Torque Prove	<a href="#">174</a>
Speed Draw Out	1018	Speed Meters	<a href="#">128</a>
Speed Match	1195	Winder Functions	<a href="#">170</a>
Speed Ramp En	245	Ramp Rates	<a href="#">156</a>
Speed Ratio	1017	Speed References	<a href="#">149</a>
Speed Ref A	44	Speed Meters	<a href="#">126</a>
Speed Ref A Pct	47	Speed Meters	<a href="#">126</a>
Speed Ref B	48	Speed Meters	<a href="#">126</a>
Speed Ref B Pct	49	Speed Meters	<a href="#">126</a>
Speed Ref Out	385	Speed Meters	<a href="#">127</a>
Speed Ref Source	1329	Diagnostics	<a href="#">182</a>
Speed Reg En	242	Speed Regulator	<a href="#">152</a>
Speed Reg In	118	Speed Meters	<a href="#">127</a>
Speed Reg In Pct	117	Speed Meters	<a href="#">126</a>
Speed Thresh Neg	102	Speed Regulator	<a href="#">150</a>
Speed Thresh Pos	101	Speed Regulator	<a href="#">150</a>

Name	No.	Group	Page
Speed Threshold	393	Diagnostics	<a href="#">180</a>
Speed Tune Dir	1029	Autotune	<a href="#">144</a>
Speed Tune Ki	1033	Autotune	<a href="#">144</a>
Speed Tune Kp	1032	Autotune	<a href="#">144</a>
Speed Up Base	446	Speed Regulator	<a href="#">153</a>
Speed Up Filter	447	Speed Regulator	<a href="#">153</a>
Speed Zero Delay	108	Speed Regulator	<a href="#">151</a>
Speed Zero Level	107	Speed Regulator	<a href="#">151</a>
Spd Zero P Gain	126	Speed Regulator	<a href="#">152</a>
SSC Threshold	409	Alarms	<a href="#">186</a>
Start At Powerup	1344	Restart Modes	<a href="#">159</a>
Start Inhibits	1403	Diagnostics	<a href="#">184</a>
Start Mask	592	Masks & Owners	<a href="#">191</a>
Start Owner	601	Masks & Owners	<a href="#">192</a>
Static F Zero	1287	Winder Functions	<a href="#">172</a>
Static Friction	1174	Winder Functions	<a href="#">168</a>
Status1 at Fault	1349	Faults	<a href="#">184</a>
Status2 at Fault	1350	Faults	<a href="#">184</a>
Stop Owner	600	Masks & Owners	<a href="#">192</a>
Tachometer Speed	1408	Speed Meters	<a href="#">128</a>
Taper Enable	1176	Winder Functions	<a href="#">169</a>
TaskLoad 1 ms	1384	Diagnostics	<a href="#">183</a>
TaskLoad 2 ms	1385	Diagnostics	<a href="#">183</a>
TaskLoad 8 ms	1386	Diagnostics	<a href="#">183</a>
TB Manual Ref	267	Discrete Speeds	<a href="#">149</a>
Tension Reduct	1179	Winder Functions	<a href="#">169</a>
Tension Ref	1180	Winder Functions	<a href="#">169</a>
Tension Scale	1181	Winder Functions	<a href="#">169</a>
TestPoint Data	1382	Diagnostics	<a href="#">183</a>
TestPoint Sel	1381	Diagnostics	<a href="#">183</a>
Threshold Delay	103	Speed Regulator	<a href="#">150</a>
Time AccDec Min	1182	Winder Functions	<a href="#">169</a>
Torq Cur Filter	926	Torq Attributes	<a href="#">138</a>
Torq Current Pct	1193	Winder Functions	<a href="#">170</a>
Torq Limit Slew	1104	Torque Prove	<a href="#">174</a>
Torq Limit Type	715	Load Limits	<a href="#">158</a>
Torq Prove Cfg	1100	Torque Prove	<a href="#">173</a>
Torq Prove Setup	1101	Torque Prove	<a href="#">173</a>
Torq Prove Sts	1103	Torque Prove	<a href="#">174</a>
Torq Red CurLim	13	Load Limits	<a href="#">157</a>
Torque Const	1013	Autotune	<a href="#">144</a>
Torque Negative	347	Diagnostics	<a href="#">178</a>
Torque Positive	346	Diagnostics	<a href="#">178</a>
Torque Reduction	342	Torq Attributes	<a href="#">137</a>

Name	No.	Group	Page
Torque Ref	39	Torq Attributes	<a href="#">136</a>
Torque Winder En	1209	Winder Functions	<a href="#">170</a>
Total Inertia	433	Speed Regulator	<a href="#">152</a>
Trim Ramp	42	Speed Reference	<a href="#">149</a>
Trim Ramp Pct	378	Speed Reference	<a href="#">149</a>
Trim Speed	43	Speed Reference	<a href="#">149</a>
Trim Speed Pct	379	Speed Reference	<a href="#">149</a>
Trim Torque	40	Torq Attributes	<a href="#">137</a>
TrqTpr Enable	750	Torq Attributes	<a href="#">137</a>
TrqTpr Lim0	751	Torq Attributes	<a href="#">137</a>
TrqTpr Lim1	752	Torq Attributes	<a href="#">137</a>
TrqTpr Lim2	753	Torq Attributes	<a href="#">137</a>
TrqTpr Lim3	754	Torq Attributes	<a href="#">137</a>
TrqTpr Lim4	755	Torq Attributes	<a href="#">137</a>
TrqTpr Spd	756	Torq Attributes	<a href="#">138</a>
TstGen Amplitude	60	Test Generator	<a href="#">145</a>
TstGen Frequency	59	Test Generator	<a href="#">145</a>
TstGen Offset	61	Test Generator	<a href="#">145</a>
TstGen Output	58	Test Generator	<a href="#">145</a>
UnderVlt Flt Dly	470	Alarms	<a href="#">186</a>
UnderVolt Thresh	481	Alarms	<a href="#">186</a>
UserDefined0	503	User Defined	<a href="#">189</a>
UserDefined1	504	User Defined	<a href="#">189</a>
UserDefined10	513	User Defined	<a href="#">189</a>
UserDefined11	514	User Defined	<a href="#">189</a>
UserDefined12	515	User Defined	<a href="#">189</a>
UserDefined13	516	User Defined	<a href="#">189</a>
UserDefined14	517	User Defined	<a href="#">189</a>
UserDefined15	518	User Defined	<a href="#">189</a>
UserDefined2	505	User Defined	<a href="#">189</a>
UserDefined3	506	User Defined	<a href="#">189</a>
UserDefined4	507	User Defined	<a href="#">189</a>
UserDefined5	508	User Defined	<a href="#">189</a>
UserDefined6	509	User Defined	<a href="#">189</a>
UserDefined7	510	User Defined	<a href="#">189</a>
UserDefined8	511	User Defined	<a href="#">189</a>
UserDefined9	512	User Defined	<a href="#">189</a>
UsrDefBitWrdA	519	User Defined	<a href="#">189</a>
UsrDefBitWrdA0	520	User Defined	<a href="#">190</a>
UsrDefBitWrdA1	521	User Defined	<a href="#">190</a>
UsrDefBitWrdA10	530	User Defined	<a href="#">190</a>
UsrDefBitWrdA11	531	User Defined	<a href="#">190</a>
UsrDefBitWrdA12	532	User Defined	<a href="#">190</a>
UsrDefBitWrdA13	533	User Defined	<a href="#">190</a>
UsrDefBitWrdA14	534	User Defined	<a href="#">190</a>
UsrDefBitWrdA15	535	User Defined	<a href="#">190</a>
UsrDefBitWrdA2	522	User Defined	<a href="#">190</a>
UsrDefBitWrdA3	523	User Defined	<a href="#">190</a>
UsrDefBitWrdA4	524	User Defined	<a href="#">190</a>

Name	No.	Group	Page
UsrDefBitWrdA5	525	User Defined	<a href="#">190</a>
UsrDefBitWrdA6	526	User Defined	<a href="#">190</a>
UsrDefBitWrdA7	527	User Defined	<a href="#">190</a>
UsrDefBitWrdA8	528	User Defined	<a href="#">190</a>
UsrDefBitWrdA9	529	User Defined	<a href="#">190</a>
UsrDefBitWrdB	536	User Defined	<a href="#">190</a>
UsrDefBitWrdB0	537	User Defined	<a href="#">191</a>
UsrDefBitWrdB1	538	User Defined	<a href="#">191</a>
UsrDefBitWrdB10	547	User Defined	<a href="#">191</a>
UsrDefBitWrdB11	548	User Defined	<a href="#">191</a>
UsrDefBitWrdB12	549	User Defined	<a href="#">191</a>
UsrDefBitWrdB13	550	User Defined	<a href="#">191</a>
UsrDefBitWrdB14	551	User Defined	<a href="#">191</a>
UsrDefBitWrdB15	552	User Defined	<a href="#">191</a>
UsrDefBitWrdB2	539	User Defined	<a href="#">191</a>
UsrDefBitWrdB3	540	User Defined	<a href="#">191</a>
UsrDefBitWrdB4	541	User Defined	<a href="#">191</a>
UsrDefBitWrdB5	542	User Defined	<a href="#">191</a>
UsrDefBitWrdB6	543	User Defined	<a href="#">191</a>
UsrDefBitWrdB7	544	User Defined	<a href="#">191</a>
UsrDefBitWrdB8	545	User Defined	<a href="#">191</a>
UsrDefBitWrdB9	546	User Defined	<a href="#">191</a>
UsrDsplyDiv0	51	User Defined	<a href="#">188</a>
UsrDsplyMult0	50	User Defined	<a href="#">188</a>
UsrValDiv1	54	User Defined	<a href="#">188</a>
UsrValMult1	53	User Defined	<a href="#">188</a>
Variable J Comp	1171	Winder Functions	<a href="#">168</a>
W Gain	1202	Winder Functions	<a href="#">170</a>
W Offset	1199	Winder Functions	<a href="#">170</a>
W Reference	1217	Winder Functions	<a href="#">171</a>
W Target	1210	Winder Functions	<a href="#">171</a>
Winder Side	1201	Winder Functions	<a href="#">170</a>
Winder Type	1187	Diameter Calc	<a href="#">167</a>
Write Mask Act	1377	Security	<a href="#">194</a>
Write Mask Cfg	1378	Security	<a href="#">194</a>
Zero Ramp Input	345	Ramp Rates	<a href="#">156</a>
Zero Ramp Output	344	Ramp Rates	<a href="#">156</a>
Zero Torque	353	Torq Attributes	<a href="#">137</a>
ZeroSpdFloatTime	1113	Torque Prove	<a href="#">175</a>



## Parameter Cross Reference – by Number

No.	Parameter Name	Group	Page
1	Minimum Speed	Limits	<a href="#">148</a>
2	Maximum Speed	Limits	<a href="#">148</a>
3	Max Speed Fwd	Limits	<a href="#">148</a>
4	Max Speed Rev	Limits	<a href="#">148</a>
5	Min Speed Fwd	Limits	<a href="#">148</a>
6	Min Speed Rev	Limits	<a href="#">148</a>
7	Current Limit	Torq Attributes	<a href="#">136</a>
8	Current Lim Pos	Torq Attributes	<a href="#">136</a>
9	Current Lim Neg	Torq Attributes	<a href="#">136</a>
10	Cur Lim Pos Out	Current Meters	<a href="#">128</a>
11	Cur Lim Neg Out	Current Meters	<a href="#">128</a>
12	Current Rate Lim	Torq Attributes	<a href="#">136</a>
13	Torq Red CurLim	Load Limits	<a href="#">157</a>
14	Selected TorqRef	Current Meters	<a href="#">128</a>
15	SLAT Err Stpt	Control Config	<a href="#">155</a>
16	SLAT Dwell Time	Control Config	<a href="#">155</a>
17	Motor Trq Ref	Current Meters	<a href="#">128</a>
18	Ramp Type Select	Ramp Rates	<a href="#">155</a>
19	S Curve Time	Ramp Rates	<a href="#">155</a>
20	Ramp Delay	Ramp Rates	<a href="#">156</a>
22	MOP Accel Time	Ramp Rates	<a href="#">156</a>
21	Min Firing Angle	Motor Data	<a href="#">131</a>
24	Accel Time 2	Ramp Rates	<a href="#">156</a>
30	MOP Decel Time	Ramp Rates	<a href="#">156</a>
32	Decel Time 2	Ramp Rates	<a href="#">156</a>
38	Fast Stop Time	Stop Modes	<a href="#">158</a>
39	Torque Ref	Torq Attributes	<a href="#">136</a>
40	Trim Torque	Torq Attributes	<a href="#">137</a>
41	Current Reg In	Current Meters	<a href="#">128</a>
42	Trim Ramp	Speed Reference	<a href="#">149</a>
43	Trim Speed	Speed Reference	<a href="#">149</a>
44	Speed Ref A	Speed Meters	<a href="#">126</a>
45	Max Ref Speed	Motor Data	<a href="#">131</a>
47	Speed Ref A Pct	Speed Meters	<a href="#">126</a>
48	Speed Ref B	Speed Meters	<a href="#">126</a>
49	Speed Ref B Pct	Speed Meters	<a href="#">126</a>
50	UsrDsplyMult0	User Defined	<a href="#">188</a>
51	UsrDsplyDiv0	User Defined	<a href="#">188</a>
53	UsrValMult1	User Defined	<a href="#">188</a>
54	UsrValDiv1	User Defined	<a href="#">188</a>
57	FaultCode	Drive Data	<a href="#">129</a>
58	TstGen Output	Test Generator	<a href="#">145</a>
59	TstGen Frequency	Test Generator	<a href="#">145</a>
60	TstGen Amplitude	Test Generator	<a href="#">145</a>
61	TstGen Offset	Test Generator	<a href="#">145</a>
62	Anlg Out1 Scale	Analog Outputs	<a href="#">197</a>

No.	Parameter Name	Group	Page
63	Anlg Out2 Scale	Analog Outputs	<a href="#">197</a>
64	Anlg Out3 Scale	Analog Outputs	<a href="#">197</a>
65	Anlg Out4 Scale	Analog Outputs	<a href="#">197</a>
66	Anlg Out1 Sel	Analog Outputs	<a href="#">198</a>
67	Anlg Out2 Sel	Analog Outputs	<a href="#">198</a>
68	Anlg Out3 Sel	Analog Outputs	<a href="#">198</a>
69	Anlg Out4 Sel	Analog Outputs	<a href="#">198</a>
70	Anlg In1 Sel	Analog Inputs	<a href="#">195</a>
71	Anlg In1 Config	Analog Inputs	<a href="#">195</a>
72	Anlg In1 Scale	Analog Inputs	<a href="#">195</a>
73	Anlg1 Tune Scale	Analog Inputs	<a href="#">195</a>
74	Anlg In1 Offset	Analog Inputs	<a href="#">196</a>
75	Anlg In2 Sel	Analog Inputs	<a href="#">195</a>
76	Anlg In2 Config	Analog Inputs	<a href="#">195</a>
77	Anlg In2 Scale	Analog Inputs	<a href="#">195</a>
78	Anlg2 Tune Scale	Analog Inputs	<a href="#">195</a>
79	Anlg In2 Offset	Analog Inputs	<a href="#">196</a>
80	Anlg In3 Sel	Analog Inputs	<a href="#">195</a>
81	Anlg In3 Config	Analog Inputs	<a href="#">195</a>
82	Anlg In3 Scale	Analog Inputs	<a href="#">195</a>
83	Anlg3 Tune Scale	Analog Inputs	<a href="#">195</a>
84	Anlg In3 Offset	Analog Inputs	<a href="#">196</a>
87	Spd Reg Kp	Speed Regulator	<a href="#">149</a>
88	Spd Reg Ki	Speed Regulator	<a href="#">149</a>
89	SpdReg PosLmOut	Current Meters	<a href="#">128</a>
90	SpdReg NegLmOut	Current Meters	<a href="#">128</a>
91	Fld Reg Kp	Field Config	<a href="#">133</a>
92	Fld Reg Ki	Field Config	<a href="#">133</a>
93	Spd Reg Kp Base	Autotune	<a href="#">143</a>
94	Spd Reg Ki Base	Autotune	<a href="#">143</a>
95	Spd Reg Pos Lim	Speed Regulator	<a href="#">149</a>
96	Spd Reg Neg Lim	Speed Regulator	<a href="#">149</a>
97	Fld Reg Kp Base	Field Config	<a href="#">133</a>
98	Fld Reg Ki Base	Field Config	<a href="#">133</a>
99	Spd Reg Kp Outpt	Speed Regulator	<a href="#">149</a>
100	Spd Reg Ki Outpt	Speed Regulator	<a href="#">150</a>
101	Speed Thresh Pos	Speed Regulator	<a href="#">150</a>
102	Speed Thresh Neg	Speed Regulator	<a href="#">150</a>
103	Threshold Delay	Speed Regulator	<a href="#">150</a>
104	At Speed Error	Speed Regulator	<a href="#">150</a>
105	At Speed Delay	Speed Regulator	<a href="#">150</a>
106	Ref Zero Level	Speed Regulator	<a href="#">150</a>
107	Speed Zero Level	Speed Regulator	<a href="#">151</a>
108	Speed Zero Delay	Speed Regulator	<a href="#">151</a>
110	Ramp In	Speed Meters	<a href="#">126</a>
111	Ramp In Pct	Speed Meters	<a href="#">126</a>
113	Ramp Out	Speed Meters	<a href="#">126</a>
114	Ramp Out Pct	Speed Meters	<a href="#">126</a>
117	Speed Reg In Pct	Speed Meters	<a href="#">126</a>
118	Speed Reg In	Speed Meters	<a href="#">127</a>

No.	Parameter Name	Group	Page
121	Spd Feedback Pct	Speed Meters	<a href="#">127</a>
122	Spd Feedback	Speed Meters	<a href="#">127</a>
123	Spd Zero I En	Speed Regulator	<a href="#">151</a>
124	Spd Ref Zero En	Speed Regulator	<a href="#">151</a>
125	Spd Zero P En	Speed Regulator	<a href="#">151</a>
126	Spd Zero P Gain	Speed Regulator	<a href="#">152</a>
133	Digital In1 Sel	Digital Inputs	<a href="#">199</a>
134	Digital In2 Sel	Digital Inputs	<a href="#">199</a>
135	Digital In3 Sel	Digital Inputs	<a href="#">199</a>
136	Digital In4 Sel	Digital Inputs	<a href="#">199</a>
137	Digital In5 Sel	Digital Inputs	<a href="#">199</a>
138	Digital In6 Sel	Digital Inputs	<a href="#">199</a>
139	Digital In7 Sel	Digital Inputs	<a href="#">199</a>
140	Digital In8 Sel	Digital Inputs	<a href="#">199</a>
141	Digital In9 Sel	Digital Inputs	<a href="#">199</a>
142	Digital In10 Sel	Digital Inputs	<a href="#">199</a>
143	Digital In11 Sel	Digital Inputs	<a href="#">199</a>
144	Digital In12 Sel	Digital Inputs	<a href="#">199</a>
145	Digital Out1 Sel	Digital Outputs	<a href="#">203</a>
146	Digital Out2 Sel	Digital Outputs	<a href="#">203</a>
147	Digital Out3 Sel	Digital Outputs	<a href="#">203</a>
148	Digital Out4 Sel	Digital Outputs	<a href="#">203</a>
149	Digital Out5 Sel	Digital Outputs	<a href="#">203</a>
150	Digital Out6 Sel	Digital Outputs	<a href="#">203</a>
151	Digital Out7 Sel	Digital Outputs	<a href="#">203</a>
152	Digital Out8 Sel	Digital Outputs	<a href="#">203</a>
154	Preset Speed 1	Discrete Speeds	<a href="#">148</a>
155	Preset Speed 2	Discrete Speeds	<a href="#">148</a>
156	Preset Speed 3	Discrete Speeds	<a href="#">148</a>
157	Preset Speed 4	Discrete Speeds	<a href="#">148</a>
158	Preset Speed 5	Discrete Speeds	<a href="#">148</a>
159	Preset Speed 6	Discrete Speeds	<a href="#">148</a>
160	Preset Speed 7	Discrete Speeds	<a href="#">148</a>
162	Max Feedback Spd	Motor Data	<a href="#">131</a>
166	Alpha Test	Test Generator	<a href="#">146</a>
165	Firing Angle	Drive Data	<a href="#">129</a>
167	Arm Text Angle	Test Generator	<a href="#">146</a>
168	Fld Test Angle	Test Generator	<a href="#">146</a>
169	Encoder PPR	Speed Feedback	<a href="#">138</a>
170	Encoder Config	Speed Feedback	<a href="#">138</a>
175	Rated Motor Volt	Motor Data	<a href="#">131</a>
179	Nom Mtr Arm Amps	Motor Data	<a href="#">131</a>
181	Adaptive Spd En	Adaptv Regulator	<a href="#">159</a>
182	Adaptive Reg Typ	Adaptv Regulator	<a href="#">159</a>
183	Adaptive Ref	Adaptv Regulator	<a href="#">159</a>
184	Adaptive Spd 1	Adaptv Regulator	<a href="#">159</a>

No.	Parameter Name	Group	Page
185	Adaptive Spd 2	Adaptv Regulator	<a href="#">159</a>
186	Adaptive Joint 1	Adaptv Regulator	<a href="#">159</a>
187	Adaptive Joint 2	Adaptv Regulator	<a href="#">160</a>
188	Adaptive P Gain1	Adaptv Regulator	<a href="#">160</a>
189	Adaptive I Gain1	Adaptv Regulator	<a href="#">160</a>
190	Adaptive P Gain2	Adaptv Regulator	<a href="#">160</a>
191	Adaptive I Gain2	Adaptv Regulator	<a href="#">160</a>
192	Adaptive P Gain3	Adaptv Regulator	<a href="#">160</a>
193	Adaptive I Gain3	Adaptv Regulator	<a href="#">160</a>
199	Arm Current Pct	Current Meters	<a href="#">128</a>
200	Arm Current	Current Meters	<a href="#">128</a>
201	Drive Type Sel	Motor Data	<a href="#">131</a>
203	OverVolt Flt Cfg	Alarms	<a href="#">185</a>
209	Save HIM Ref	HIM Ref Config	<a href="#">177</a>
210	Man Ref Preload	HIM Ref Config	<a href="#">177</a>
211	Param Access Lvl	Drive Memory	<a href="#">177</a>
213	SCR Diag Test En	Test Generator	<a href="#">146</a>
214	SCR Diag Status	Test Generator	<a href="#">147</a>
215	OpenSCR WarnLvl	Test Generator	<a href="#">147</a>
216	OpenSCR Flt Cfg	Test Generator	<a href="#">147</a>
217	OpenSCR Threshld	Test Generator	<a href="#">147</a>
218	OpenSCR Trip Lvl	Test Generator	<a href="#">147</a>
232	Inertia Comp Out	Current Meters	<a href="#">129</a>
233	Output Voltage	Drive Data	<a href="#">129</a>
234	Fld Current Pct	Current Meters	<a href="#">129</a>
235	Elapsed Lifetime	Drive Data	<a href="#">129</a>
236	Spd Reg Out Pct	Speed Regulator	<a href="#">127</a>
238	SpdOut FiltGain	Speed Regulator	<a href="#">152</a>
239	SpdOut FiltBW	Speed Regulator	<a href="#">152</a>
241	Spd Trq Mode Sel	Control Config	<a href="#">155</a>
242	Speed Reg En	Speed Regulator	<a href="#">152</a>
245	Speed Ramp En	Ramp Rates	<a href="#">156</a>
249	MOP Ref Config	Reference Config	<a href="#">177</a>
258	Reset Defaults	Drive Memory	<a href="#">177</a>
259	Anlg In1 Tune	Analog Inputs	<a href="#">196</a>
260	Anlg In2 Tune	Analog Inputs	<a href="#">196</a>
261	Anlg In3 Tune	Analog Inputs	<a href="#">196</a>
263	Clear Fault Que	Faults	<a href="#">184</a>
266	Jog Speed	Discrete Speeds	<a href="#">148</a>
267	TB Manual Ref	Discrete Speeds	<a href="#">149</a>
280	Nom Mtr Fld Amps	Motor Data	<a href="#">132</a>
295	Anlg In1 Target	Analog Inputs	<a href="#">196</a>
296	Anlg In2 Target	Analog Inputs	<a href="#">196</a>

No.	Parameter Name	Group	Page
297	Anlg In3 Target	Analog Inputs	<a href="#">196</a>
300	Drive Type	Drive Data	<a href="#">129</a>
302	Language	Drive Memory	<a href="#">177</a>
331	Software Version	Configuration	<a href="#">130</a>
332	Drive Checksum	Drive Data	<a href="#">130</a>
333	MtrOvrld Factor	Motor Data	<a href="#">132</a>
334	MtrOvrld Speed	Motor Data	<a href="#">132</a>
342	Torque Reduction	Torq Attributes	<a href="#">137</a>
344	Zero Ramp Output	Ramp Rates	<a href="#">156</a>
345	Zero Ramp Input	Ramp Rates	<a href="#">156</a>
346	Torque Positive	Diagnostics	<a href="#">178</a>
347	Torque Negative	Diagnostics	<a href="#">178</a>
348	Lock Speed Integ	Speed Regulator	<a href="#">152</a>
349	CurrLimit Active	Diagnostics	<a href="#">178</a>
351	Field Current	Current Meters	<a href="#">129</a>
353	Zero Torque	Torq Attributes	<a href="#">137</a>
354	Aux Inp Flt Cfg	Alarms	<a href="#">185</a>
365	OverTemp Flt Cfg	Alarms	<a href="#">185</a>
372	Spd Limit Active	Diagnostics	<a href="#">178</a>
373	Freeze Ramp	Ramp Rates	<a href="#">156</a>
374	Drv Fld Brdg Cur	Motor Data	<a href="#">132</a>
376	MtrOvrld Type	Motor Data	<a href="#">132</a>
378	Trim Ramp Pct	Speed Reference	<a href="#">149</a>
379	Trim Speed Pct	Speed Reference	<a href="#">149</a>
381	Drive Status 1	Diagnostics	<a href="#">179</a>
382	Drive Status 2	Diagnostics	<a href="#">180</a>
384	Spd Ref Out Pct	Speed Meters	<a href="#">127</a>
385	Speed Ref Out	Speed Meters	<a href="#">127</a>
388	Flying Start En	Speed Regulator	<a href="#">152</a>
393	Speed Threshold	Diagnostics	<a href="#">180</a>
394	At Speed	Diagnostics	<a href="#">180</a>
395	At Zero Speed	Diagnostics	<a href="#">180</a>
396	MOP Inc Active	Diagnostics	<a href="#">180</a>
397	MOP Dec Active	Diagnostics	<a href="#">181</a>
400	Spd Select 0	Diagnostics	<a href="#">181</a>
401	Spd Select 1	Diagnostics	<a href="#">181</a>
402	Spd Select 2	Diagnostics	<a href="#">181</a>
403	Ramp Select 0	Diagnostics	<a href="#">181</a>
404	Ramp Select 1	Diagnostics	<a href="#">181</a>
414	Fdbk Device Type	Speed Feedback	<a href="#">138</a>
409	SSC Threshold	Alarms	<a href="#">186</a>
410	Ext FC Curr Hyst	Field Config	<a href="#">133</a>
411	FC Lim Ramp	Torq Attributes	<a href="#">137</a>
412	FC Lim Ramp Time	Torq Attributes	<a href="#">137</a>
418	Real FF PID	PID Control	<a href="#">163</a>
420	Encoder Speed	Speed Meters	<a href="#">127</a>
421	PD Output PID	PD Control	<a href="#">162</a>
422	Fdbk Option ID	Speed Feedback	<a href="#">138</a>
423	Reslvr Type Sel	Speed Feedback	<a href="#">139</a>
424	Reslvr Spd Ratio	Speed Feedback	<a href="#">139</a>

No.	Parameter Name	Group	Page
425	Resolver Config	Speed Feedback	<a href="#">140</a>
426	Resolver Status	Speed Feedback	<a href="#">141</a>
427	Reslvr Position	Speed Feedback	<a href="#">141</a>
428	Resolver Speed	Speed Meters	<a href="#">127</a>
429	Resolver Pos Sel	Speed Feedback	<a href="#">141</a>
430	Resolver Spd Sel	Speed Feedback	<a href="#">141</a>
431	Reslvr Cable Bal	Speed Feedback	<a href="#">141</a>
432	Reslvr Error Cnt	Diagnostics	<a href="#">181</a>
433	Total Inertia	Speed Regulator	<a href="#">152</a>
434	Spd Reg BW	Speed Regulator	<a href="#">152</a>
435	Act Spd Reg BW	Speed Regulator	<a href="#">153</a>
436	Spd Reg Damping	Speed Regulator	<a href="#">153</a>
444	Spd Reg P Filter	Speed Regulator	<a href="#">153</a>
445	Spd Up Gain Pct	Speed Regulator	<a href="#">153</a>
446	Speed Up Base	Speed Regulator	<a href="#">153</a>
447	Speed Up Filter	Speed Regulator	<a href="#">153</a>
448	SpdReg BW Bypass	Speed Regulator	<a href="#">153</a>
452	CurrReg Autotune	Autotune	<a href="#">143</a>
453	Arm Resistance	Autotune	<a href="#">143</a>
454	Arm Inductance	Autotune	<a href="#">143</a>
455	Spd FB Loss Lvl	Speed Feedback	<a href="#">141</a>
456	Fld Weaken Ratio	Field Config	<a href="#">133</a>
457	Spd Fdbk Control	Speed Feedback	<a href="#">142</a>
458	SpdReg FB Bypass	Speed Feedback	<a href="#">142</a>
459	SpdReg Kp Bypass	Speed Regulator	<a href="#">153</a>
460	SpdReg Ki Bypass	Speed Regulator	<a href="#">154</a>
461	Spd Fdbk Invert	Speed Feedback	<a href="#">142</a>
462	Flux Divide	Field Config	<a href="#">133</a>
463	Flux Filter BW	Field Config	<a href="#">133</a>
464	SAR Volts Scale	Motor Data	<a href="#">133</a>
465	Drive Size	Drive Data	<a href="#">130</a>
466	AC Line Voltage	Drive Data	<a href="#">130</a>
467	Max Fld Flux Pct	Field Config	<a href="#">134</a>
468	Min Fld Curr Pct	Field Config	<a href="#">134</a>
469	Field Mode Sel	Field Config	<a href="#">134</a>
470	UnderVlt Flt Dly	Alarms	<a href="#">186</a>
473	FldLoss Flt Cfg	Alarms	<a href="#">186</a>
475	FldLoss Flt Dly	Alarms	<a href="#">186</a>
476	Field Curve Out	Current Meters	<a href="#">129</a>
478	Spd Loss Flt Cfg	Alarms	<a href="#">186</a>
479	MtrOvrld Flt Cfg	Alarms	<a href="#">186</a>
481	UnderVolt Thresh	Alarms	<a href="#">186</a>
484	Scale1 Input	Scale Blocks	<a href="#">175</a>
485	Scale1 Output	Scale Blocks	<a href="#">175</a>
486	Scale1 Mul	Scale Blocks	<a href="#">175</a>
487	Scale1 Div	Scale Blocks	<a href="#">175</a>
488	Scale1 In Max	Scale Blocks	<a href="#">175</a>
489	Scale1 In Min	Scale Blocks	<a href="#">175</a>
490	Scale1 In Off	Scale Blocks	<a href="#">176</a>
491	Scale1 Out Off	Scale Blocks	<a href="#">176</a>

No.	Parameter Name	Group	Page
492	Scale1 In Abs	Scale Blocks	<a href="#">176</a>
493	Arm Volt Kp	Field Config	<a href="#">134</a>
494	Arm Volt Ki	Field Config	<a href="#">134</a>
495	Arm Volt Kp Base	Field Config	<a href="#">135</a>
496	Arm Volt Ki Base	Field Config	<a href="#">135</a>
497	Field Reg Enable	Field Config	<a href="#">135</a>
498	Force Min Field	Field Config	<a href="#">135</a>
499	Field Economy En	Field Config	<a href="#">135</a>
500	Flux Ref Pct	Current Meters	<a href="#">129</a>
503	UserDefined0	User Defined	<a href="#">189</a>
504	UserDefined1	User Defined	<a href="#">189</a>
505	UserDefined2	User Defined	<a href="#">189</a>
506	UserDefined3	User Defined	<a href="#">189</a>
507	UserDefined4	User Defined	<a href="#">189</a>
508	UserDefined5	User Defined	<a href="#">189</a>
509	UserDefined6	User Defined	<a href="#">189</a>
510	UserDefined7	User Defined	<a href="#">189</a>
511	UserDefined8	User Defined	<a href="#">189</a>
512	UserDefined9	User Defined	<a href="#">189</a>
513	UserDefined10	User Defined	<a href="#">189</a>
514	UserDefined11	User Defined	<a href="#">189</a>
515	UserDefined12	User Defined	<a href="#">189</a>
516	UserDefined13	User Defined	<a href="#">189</a>
517	UserDefined14	User Defined	<a href="#">189</a>
518	UserDefined15	User Defined	<a href="#">189</a>
519	UsrDefBitWrdA	User Defined	<a href="#">189</a>
520	UsrDefBitWrdA0	User Defined	<a href="#">190</a>
521	UsrDefBitWrdA1	User Defined	<a href="#">190</a>
522	UsrDefBitWrdA2	User Defined	<a href="#">190</a>
523	UsrDefBitWrdA3	User Defined	<a href="#">190</a>
524	UsrDefBitWrdA4	User Defined	<a href="#">190</a>
525	UsrDefBitWrdA5	User Defined	<a href="#">190</a>
526	UsrDefBitWrdA6	User Defined	<a href="#">190</a>
527	UsrDefBitWrdA7	User Defined	<a href="#">190</a>
528	UsrDefBitWrdA8	User Defined	<a href="#">190</a>
529	UsrDefBitWrdA9	User Defined	<a href="#">190</a>
530	UsrDefBitWrdA10	User Defined	<a href="#">190</a>
531	UsrDefBitWrdA11	User Defined	<a href="#">190</a>
532	UsrDefBitWrdA12	User Defined	<a href="#">190</a>
533	UsrDefBitWrdA13	User Defined	<a href="#">190</a>
534	UsrDefBitWrdA14	User Defined	<a href="#">190</a>
535	UsrDefBitWrdA15	User Defined	<a href="#">190</a>
536	UsrDefBitWrdB	User Defined	<a href="#">190</a>
537	UsrDefBitWrdB0	User Defined	<a href="#">191</a>
538	UsrDefBitWrdB1	User Defined	<a href="#">191</a>
539	UsrDefBitWrdB2	User Defined	<a href="#">191</a>
540	UsrDefBitWrdB3	User Defined	<a href="#">191</a>
541	UsrDefBitWrdB4	User Defined	<a href="#">191</a>
542	UsrDefBitWrdB5	User Defined	<a href="#">191</a>
543	UsrDefBitWrdB6	User Defined	<a href="#">191</a>

No.	Parameter Name	Group	Page
544	UsrDefBitWrdB7	User Defined	<a href="#">191</a>
545	UsrDefBitWrdB8	User Defined	<a href="#">191</a>
546	UsrDefBitWrdB9	User Defined	<a href="#">191</a>
547	UsrDefBitWrdB10	User Defined	<a href="#">191</a>
548	UsrDefBitWrdB11	User Defined	<a href="#">191</a>
549	UsrDefBitWrdB12	User Defined	<a href="#">191</a>
550	UsrDefBitWrdB13	User Defined	<a href="#">191</a>
551	UsrDefBitWrdB14	User Defined	<a href="#">191</a>
552	UsrDefBitWrdB15	User Defined	<a href="#">191</a>
553	Scale2 Input	Scale Blocks	<a href="#">175</a>
554	Scale2 Output	Scale Blocks	<a href="#">175</a>
555	Scale2 Mul	Scale Blocks	<a href="#">175</a>
556	Scale2 Div	Scale Blocks	<a href="#">175</a>
557	Scale2 In Max	Scale Blocks	<a href="#">175</a>
558	Scale2 In Min	Scale Blocks	<a href="#">175</a>
559	Scale2 In Off	Scale Blocks	<a href="#">176</a>
560	Scale2 Out Off	Scale Blocks	<a href="#">176</a>
561	Scale2 In Abs	Scale Blocks	<a href="#">176</a>
562	Anlg Tach Gain	Speed Feedback	<a href="#">142</a>
563	Feedback Offset	Speed Feedback	<a href="#">142</a>
564	Dig In Status	Digital Inputs	<a href="#">202</a>
565	Dig In Term 1	Digital Inputs	<a href="#">202</a>
566	Dig In Term 2	Digital Inputs	<a href="#">202</a>
567	Dig In Term 3	Digital Inputs	<a href="#">202</a>
568	Dig In Term 4	Digital Inputs	<a href="#">202</a>
569	Dig In Term 5	Digital Inputs	<a href="#">202</a>
570	Dig In Term 6	Digital Inputs	<a href="#">202</a>
571	Dig In Term 7	Digital Inputs	<a href="#">202</a>
572	Dig In Term 8	Digital Inputs	<a href="#">202</a>
573	Dig In Term 9	Digital Inputs	<a href="#">202</a>
574	Dig In Term 10	Digital Inputs	<a href="#">202</a>
575	Dig In Term 11	Digital Inputs	<a href="#">202</a>
576	Dig In Term 12	Digital Inputs	<a href="#">202</a>
581	Dig Out Status	Digital Outputs	<a href="#">205</a>
584	OverCurrent Thr	Alarms	<a href="#">187</a>
585	Overspeed Val	Alarms	<a href="#">187</a>
587	I Reg Error	Autotune	<a href="#">143</a>
588	AC Line Freq	Drive Data	<a href="#">130</a>
589	DPI Baud Rate	Comm Control	<a href="#">191</a>
590	DPI Port Sel	Comm Control	<a href="#">191</a>
591	Logic Mask	Masks & Owners Security	<a href="#">191</a> <a href="#">193</a>
592	Start Mask	Masks & Owners	<a href="#">191</a>
593	Jog Mask	Masks & Owners	<a href="#">192</a>
594	Direction Mask	Masks & Owners	<a href="#">192</a>
595	Reference Mask	Masks & Owners	<a href="#">192</a>
596	Accel Mask	Masks & Owners	<a href="#">192</a>
597	Fault Clr Mask	Masks & Owners	<a href="#">192</a>
598	MOP Mask	Masks & Owners	<a href="#">192</a>
599	Local Mask	Masks & Owners	<a href="#">192</a>

No.	Parameter Name	Group	Page
600	Stop Owner	Masks & Owners	<a href="#">192</a>
601	Start Owner	Masks & Owners	<a href="#">192</a>
602	Jog Owner	Masks & Owners	<a href="#">192</a>
603	Direction Owner	Masks & Owners	<a href="#">192</a>
604	Reference Owner	Masks & Owners	<a href="#">192</a>
605	Accel Owner	Masks & Owners	<a href="#">192</a>
606	Fault Clr Owner	Masks & Owners	<a href="#">192</a>
607	MOP Owner	Masks & Owners	<a href="#">192</a>
608	Local Owner	Masks & Owners	<a href="#">192</a>
609	Decel Owner	Masks & Owners	<a href="#">192</a>
610	Data In A1	Datalinks	<a href="#">193</a>
611	Data In A2	Datalinks	<a href="#">193</a>
612	Data In B1	Datalinks	<a href="#">193</a>
613	Data In B2	Datalinks	<a href="#">193</a>
614	Data In C1	Datalinks	<a href="#">193</a>
615	Data In C2	Datalinks	<a href="#">193</a>
616	Data In D1	Datalinks	<a href="#">193</a>
617	Data In D2	Datalinks	<a href="#">193</a>
618	Data Out A1	Datalinks	<a href="#">193</a>
619	Data Out A2	Datalinks	<a href="#">193</a>
620	Data Out B1	Datalinks	<a href="#">193</a>
621	Data Out B2	Datalinks	<a href="#">193</a>
622	Data Out C1	Datalinks	<a href="#">193</a>
623	Data Out C2	Datalinks	<a href="#">193</a>
624	Data Out D1	Datalinks	<a href="#">193</a>
625	Data Out D2	Datalinks	<a href="#">193</a>
627	Spd 0 Trip Delay	Stop Modes	<a href="#">158</a>
629	Relay Out 2 Sel	Digital Outputs	<a href="#">205</a>
631	Decel Mask	Masks & Owners	<a href="#">193</a>
643	SpdReg AntiBckup	Speed Regulator	<a href="#">154</a>
651	Spd Fdbk State	Diagnostics	<a href="#">181</a>
652	Encoder Err Chk	Speed Feedback	<a href="#">142</a>
660	Accel Time 1	Ramp Rates	<a href="#">157</a>
662	Decel Time 1	Ramp Rates	<a href="#">157</a>
665	S Curve Accel 1	Ramp Rates	<a href="#">157</a>
666	S Curve Decel 1	Ramp Rates	<a href="#">157</a>
667	S Curve Accel 2	Ramp Rates	<a href="#">157</a>
668	S Curve Decel 2	Ramp Rates	<a href="#">157</a>
695	PI Steady Thr	PI Control	<a href="#">161</a>
696	Droop Percent	Load Limits	<a href="#">157</a>
697	Droop Filter	Load Limits	<a href="#">157</a>
698	Load Comp	Load Limits	<a href="#">157</a>
699	Enable Droop	Load Limits	<a href="#">158</a>
700	Droop Limit	Load Limits	<a href="#">158</a>
715	Torq Limit Type	Load Limits	<a href="#">158</a>
731	PID Steady Delay	PI Control	<a href="#">161</a>
734	PI Init Intgl Gn	PI Control	<a href="#">161</a>
750	TrqTpr Enable	Torq Attributes	<a href="#">137</a>
751	TrqTpr Lim0	Torq Attributes	<a href="#">137</a>
752	TrqTpr Lim1	Torq Attributes	<a href="#">137</a>

No.	Parameter Name	Group	Page
753	TrqTpr Lim2	Torq Attributes	<a href="#">137</a>
754	TrqTpr Lim3	Torq Attributes	<a href="#">137</a>
755	TrqTpr Lim4	Torq Attributes	<a href="#">137</a>
756	TrqTpr Spd	Torq Attributes	<a href="#">138</a>
757	PID Clamp	PID Control	<a href="#">163</a>
758	Feed Fwd PID	PID Control	<a href="#">163</a>
759	PID Error	PID Control	<a href="#">163</a>
760	PID Setpoint 0	PID Control	<a href="#">163</a>
761	PID Setpoint 1	PID Control	<a href="#">163</a>
762	PID Setpoint Sel	PID Control	<a href="#">163</a>
763	PID Feedback	PID Control	<a href="#">164</a>
764	PI Integral Gain	PI Control	<a href="#">161</a>
765	PI Prop Gain PID	PI Control	<a href="#">161</a>
766	PD Deriv Gain 1	PD Control	<a href="#">162</a>
767	PD Deriv Filter	PD Control	<a href="#">162</a>
768	PD Prop Gain 1	PD Control	<a href="#">163</a>
769	Enable PI	PI Control	<a href="#">161</a>
770	Enable PD	PD Control	<a href="#">163</a>
771	PI Output	PI Control	<a href="#">161</a>
772	PID Output Sign	PID Control	<a href="#">164</a>
773	PID Output Scale	PID Control	<a href="#">164</a>
774	PID Output	PID Control	<a href="#">164</a>
776	PI Central v1	PI Control	<a href="#">161</a>
777	PI Central v2	PI Control	<a href="#">161</a>
778	PI Central v3	PI Control	<a href="#">161</a>
779	PI Central v sel	PI Control	<a href="#">162</a>
780	PI Central vs0	PI Control	<a href="#">162</a>
781	PI Central vs1	PI Control	<a href="#">162</a>
782	PID Target	PID Control	<a href="#">164</a>
783	PI integr freeze	PI Control	<a href="#">162</a>
784	PI Upper Limit	PI Control	<a href="#">162</a>
785	PI Lower Limit	PI Control	<a href="#">162</a>
786	PID Source	PID Control	<a href="#">165</a>
787	PID Source Gain	PID Control	<a href="#">165</a>
788	PD Prop Gain 2	PD Control	<a href="#">163</a>
789	PD Deriv Gain 2	PD Control	<a href="#">163</a>
790	PD Prop Gain 3	PD Control	<a href="#">163</a>
791	PD Deriv Gain 3	PD Control	<a href="#">163</a>
792	Anlg In 1 Filter	Analog Inputs	<a href="#">196</a>
793	PI Init Prop Gn	PI Control	<a href="#">162</a>
794	Diameter Calc	Init Diam Calc	<a href="#">165</a>
795	DncrPosSpd	Init Diam Calc	<a href="#">165</a>
796	Max Deviation	Init Diam Calc	<a href="#">165</a>
797	Gear Box Ratio	Init Diam Calc	<a href="#">165</a>
798	Dancer Constant	Init Diam Calc	<a href="#">166</a>
799	Minimum Diameter	Init Diam Calc Diameter Calc	<a href="#">166</a>
800	Diameter Calc St	Init Diam Calc	<a href="#">166</a>
801	Anlg In2 Filter	Analog Inputs	<a href="#">196</a>
802	Anlg In3 Filter	Analog Inputs	<a href="#">196</a>

No.	Parameter Name	Group	Page
914	Spd FB Filt Gain	Speed Feedback	<a href="#">143</a>
915	Spd FB Filt BW	Speed Feedback	<a href="#">143</a>
916	Fld Const 40 Pct	Field Config	<a href="#">135</a>
917	Fld Const 70 Pct	Field Config	<a href="#">135</a>
918	Fld Const 90 Pct	Field Config	<a href="#">135</a>
919	Set Fld Curve	Field Config	<a href="#">135</a>
920	Reset Fld Curve	Field Config	<a href="#">136</a>
921	Out Volt Level	Field Config	<a href="#">136</a>
923	Act Spd Filter	Speed Feedback	<a href="#">143</a>
924	Actual Speed	Speed Meters	<a href="#">127</a>
926	Torq Cur Filter	Torq Attributes	<a href="#">138</a>
928	Filt TorqCur Pct	Current Meters	<a href="#">129</a>
1006	Droop Out	Speed Meters	<a href="#">127</a>
1007	Droop Out Pct	Speed Meters	<a href="#">127</a>
1008	Spd Reg Fdbk	Speed Meters	<a href="#">127</a>
1009	Spd Reg Fdbk Pct	Speed Meters	<a href="#">127</a>
1010	Spd Reg Err	Speed Meters	<a href="#">128</a>
1011	Spd Reg Err Pct	Speed Meters	<a href="#">128</a>
1012	Inertia C Filter	Autotune	<a href="#">143</a>
1013	Torque Const	Autotune	<a href="#">144</a>
1014	Inertia	Autotune	<a href="#">144</a>
1015	Friction	Autotune	<a href="#">144</a>
1016	SpdFuncSelect	Speed Regulator	<a href="#">154</a>
1017	Speed Ratio	Speed References	<a href="#">149</a>
1018	Speed Draw Out	Speed Meters	<a href="#">128</a>
1019	Spd Draw Out Pct	Speed Meters	<a href="#">128</a>
1021	Encoder Out Sel	Speed Feedback	<a href="#">143</a>
1022	Encoder Counts	Speed Feedback	<a href="#">143</a>
1027	Spd Reg Autotune	Autotune	<a href="#">144</a>
1029	Speed Tune Dir	Autotune	<a href="#">144</a>
1030	Spd Tune Inertia	Autotune	<a href="#">144</a>
1031	SpdTune Friction	Autotune	<a href="#">144</a>
1032	Speed Tune Kp	Autotune	<a href="#">144</a>
1033	Speed Tune Ki	Autotune	<a href="#">144</a>
1034	SpdReg Kp Pct	Autotune	<a href="#">144</a>
1035	SpdReg Ki Pct	Autotune	<a href="#">144</a>
1042	Anlg In1 Cmp	Analog Inputs	<a href="#">196</a>
1043	Anlg In1 Cmp Err	Analog Inputs	<a href="#">196</a>
1044	Anlg In1 Cmp Dly	Analog Inputs	<a href="#">196</a>
1045	Anlg In1 Cmp Eq	Analog Inputs	<a href="#">197</a>
1046	PID Accel Time	PID Control	<a href="#">165</a>
1047	PID Decel Time	PID Control	<a href="#">165</a>
1048	Autotune Cur Lim	Auto Tune	<a href="#">145</a>
1052	Output Power	Drive Data	<a href="#">130</a>
1100	Torq Prove Cfg	Torque Prove	<a href="#">173</a>
1101	Torq Prove Setup	Torque Prove	<a href="#">173</a>
1103	Torq Prove Sts	Torque Prove	<a href="#">174</a>
1104	Torq Limit Slew	Torque Prove	<a href="#">174</a>
1105	Speed Dev Band	Torque Prove	<a href="#">174</a>

No.	Parameter Name	Group	Page
1106	Spd Band Intgrtr	Torque Prove	<a href="#">174</a>
1107	Brk Release Time	Torque Prove	<a href="#">174</a>
1108	Brk Set Time	Torque Prove	<a href="#">174</a>
1109	Brk Alarm Travel	Torque Prove	<a href="#">174</a>
1110	Brk Slip Count	Torque Prove	<a href="#">174</a>
1111	Float Tolerance	Torque Prove	<a href="#">174</a>
1112	MicroPsnScalePct	Torque Prove	<a href="#">174</a>
1113	ZeroSpdFloatTime	Torque Prove	<a href="#">175</a>
1114	Brake Test Torq	Torque Prove	<a href="#">175</a>
1153	Max Diameter	Diameter Calc	<a href="#">166</a>
1154	Roll Diameter	Diameter Calc	<a href="#">166</a>
1155	Line Spd Thresh	Diameter Calc	<a href="#">166</a>
1156	Line Spd Gain	Diameter Calc	<a href="#">166</a>
1157	Diameter Reset	Diameter Calc	<a href="#">166</a>
1158	Diam Threshold	Diameter Calc	<a href="#">166</a>
1159	Diameter Reached	Diameter Calc	<a href="#">166</a>
1160	Line Speed Pct	Diameter Calc	<a href="#">166</a>
1161	Diam Calc Dis	Diameter Calc	<a href="#">166</a>
1162	Diameter Filter	Diameter Calc	<a href="#">167</a>
1163	Base Omega	Diameter Calc	<a href="#">167</a>
1164	Diam Preset 0	Diameter Calc	<a href="#">167</a>
1165	Diam Preset 1	Diameter Calc	<a href="#">167</a>
1166	Diam Preset 2	Diameter Calc	<a href="#">167</a>
1167	Diam Preset 3	Diameter Calc	<a href="#">167</a>
1168	Diam Preset Sel	Diameter Calc	<a href="#">167</a>
1171	Variable J Comp	Winder Functions	<a href="#">168</a>
1172	Constant J Comp	Winder Functions	<a href="#">168</a>
1173	Materl Width Pct	Winder Functions	<a href="#">168</a>
1174	Static Friction	Winder Functions	<a href="#">168</a>
1175	Dynamic Friction	Winder Functions	<a href="#">168</a>
1176	Taper Enable	Winder Functions	<a href="#">169</a>
1177	Initial Diameter	Winder Functions	<a href="#">169</a>
1178	Final Diameter	Winder Functions	<a href="#">169</a>
1179	Tension Reduct	Winder Functions	<a href="#">169</a>
1180	Tension Ref	Winder Functions	<a href="#">169</a>
1181	Tension Scale	Winder Functions	<a href="#">169</a>
1182	Time AccDec Min	Winder Functions	<a href="#">169</a>
1183	Int Acc Calc En	Winder Functions	<a href="#">169</a>
1184	Line Accel Pct	Winder Functions	<a href="#">169</a>



No.	Parameter Name	Group	Page
1185	Line Decel Pct	Winder Functions	<a href="#">169</a>
1186	Line FastStp Pct	Winder Functions	<a href="#">169</a>
1187	Winder Type	Diameter Calc	<a href="#">167</a>
1188	Accel Status	Winder Functions	<a href="#">169</a>
1189	Decel Status	Winder Functions	<a href="#">169</a>
1190	Fast Stop Status	Diagnostics	<a href="#">169</a>
1191	InertiaCompCnst	Winder Functions	<a href="#">170</a>
1192	InertiaCompVar	Winder Functions	<a href="#">170</a>
1193	Torq Current Pct	Winder Functions	<a href="#">170</a>
1194	Act Ten Ref Pct	Winder Functions	<a href="#">170</a>
1195	Speed Match	Winder Functions	<a href="#">170</a>
1196	Spd Match Acc	Winder Functions	<a href="#">170</a>
1197	Spd Match Dec	Winder Functions	<a href="#">170</a>
1198	Offs Accel Time	Winder Functions	<a href="#">170</a>
1199	W Offset	Winder Functions	<a href="#">170</a>
1200	Spd Match Gain	Winder Functions	<a href="#">170</a>
1201	Winder Side	Winder Functions	<a href="#">170</a>
1202	W Gain	Winder Functions	<a href="#">170</a>
1203	Spd Match Compl	Winder Functions	<a href="#">170</a>
1204	Line Spd Source	Diameter Calc	<a href="#">168</a>
1205	Diam Inc Dec En	Diameter Calc	<a href="#">168</a>
1206	Diam Init Filter	Diameter Calc	<a href="#">168</a>
1207	Diam Stdy Delay	Diameter Calc	<a href="#">168</a>
1208	Close Loop Comp	Winder Functions	<a href="#">170</a>
1209	Torque Winder En	Winder Functions	<a href="#">170</a>
1210	W Target	Winder Functions	<a href="#">171</a>
1212	Acc Dec Filter	Winder Functions	<a href="#">171</a>
1213	Actual Comp	Winder Functions	<a href="#">171</a>
1214	Closed Loop En	Winder Functions	<a href="#">171</a>
1215	Speed Demand En	Winder Functions	<a href="#">171</a>
1216	Spd Match Torque	Winder Functions	<a href="#">171</a>

No.	Parameter Name	Group	Page
1217	W Reference	Winder Functions	<a href="#">171</a>
1218	Scale3 Input	Scale Blocks	<a href="#">175</a>
1219	Scale3 Output	Scale Blocks	<a href="#">175</a>
1220	Scale3 Mul	Scale Blocks	<a href="#">175</a>
1221	Scale3 Div	Scale Blocks	<a href="#">175</a>
1222	Scale3 In Max	Scale Blocks	<a href="#">175</a>
1223	Scale3 In Min	Scale Blocks	<a href="#">175</a>
1224	Scale3 In Off	Scale Blocks	<a href="#">176</a>
1225	Scale3 Out Off	Scale Blocks	<a href="#">176</a>
1226	Scale3 In Abs	Scale Blocks	<a href="#">176</a>
1227	Scale4 Input	Scale Blocks	<a href="#">175</a>
1228	Scale4 Output	Scale Blocks	<a href="#">175</a>
1229	Scale4 Mul	Scale Blocks	<a href="#">175</a>
1230	Scale4 Div	Scale Blocks	<a href="#">175</a>
1231	Scale4 In Max	Scale Blocks	<a href="#">175</a>
1232	Scale4 In Min	Scale Blocks	<a href="#">175</a>
1233	Scale4 In Off	Scale Blocks	<a href="#">176</a>
1234	Scale4 Out Off	Scale Blocks	<a href="#">176</a>
1235	Scale4 In Abs	Scale Blocks	<a href="#">176</a>
1236	Scale5 Output	Scale Blocks	<a href="#">175</a>
1237	Scale5 Input	Scale Blocks	<a href="#">175</a>
1238	Scale5 Mul	Scale Blocks	<a href="#">175</a>
1239	Scale5 Div	Scale Blocks	<a href="#">175</a>
1240	Scale5 In Max	Scale Blocks	<a href="#">175</a>
1241	Scale5 In Min	Scale Blocks	<a href="#">175</a>
1242	Scale5 In Off	Scale Blocks	<a href="#">176</a>
1243	Scale5 Out Off	Scale Blocks	<a href="#">176</a>
1244	Scale5 In Abs	Scale Blocks	<a href="#">176</a>
1245	Scale6 Output	Scale Blocks	<a href="#">175</a>
1246	Scale6 Input	Scale Blocks	<a href="#">175</a>
1247	Scale6 Mul	Scale Blocks	<a href="#">175</a>
1248	Scale6 Div	Scale Blocks	<a href="#">175</a>
1249	Scale6 In Max	Scale Blocks	<a href="#">175</a>
1250	Scale6 In Min	Scale Blocks	<a href="#">175</a>
1251	Scale6 In Off	Scale Blocks	<a href="#">176</a>
1252	Scale6 Out Off	Scale Blocks	<a href="#">176</a>
1253	Scale6 In Abs	Scale Blocks	<a href="#">176</a>
1254	PID Error Gain	PID Control	<a href="#">165</a>
1255	Jog TW Speed	Winder Functions	<a href="#">171</a>
1256	Jog TW Enable	Winder Functions	<a href="#">171</a>
1258	Enable PI PD	PID Control	<a href="#">165</a>
1262	Closing Speed	Stop Modes	<a href="#">158</a>
1263	Opening Delay	Stop Modes	<a href="#">158</a>
1265	Ramp In Zero En	Stop Modes	<a href="#">158</a>
1266	Actuator Delay	Stop Modes	<a href="#">158</a>
1267	Inversion Out 1	Digital Outputs	<a href="#">205</a>
1268	Inversion Out 2	Digital Outputs	<a href="#">205</a>
1269	Inversion Out 3	Digital Outputs	<a href="#">205</a>

No.	Parameter Name	Group	Page
1270	Inversion Out 4	Digital Outputs	<a href="#">205</a>
1271	Inversion Out 5	Digital Outputs	<a href="#">205</a>
1272	Inversion Out 6	Digital Outputs	<a href="#">205</a>
1273	Inversion Out 7	Digital Outputs	<a href="#">205</a>
1274	Inversion Out 8	Digital Outputs	<a href="#">205</a>
1275	Inversion Relay2	Digital Outputs	<a href="#">205</a>
1276	Inversion In 1	Digital Inputs	<a href="#">202</a>
1277	Inversion In 2	Digital Inputs	<a href="#">202</a>
1278	Inversion In 3	Digital Inputs	<a href="#">202</a>
1279	Inversion In 4	Digital Inputs	<a href="#">202</a>
1280	Inversion In 5	Digital Inputs	<a href="#">202</a>
1281	Inversion In 6	Digital Inputs	<a href="#">202</a>
1282	Inversion In 7	Digital Inputs	<a href="#">202</a>
1283	Inversion In 8	Digital Inputs	<a href="#">202</a>
1284	Ref Spd Source	Winder Functions	<a href="#">172</a>
1285	Ref Speed Gain	Winder Functions	<a href="#">172</a>
1286	Ref Line Speed	Winder Functions	<a href="#">172</a>
1287	Static F Zero	Winder Functions	<a href="#">172</a>
1290	MtrOvrld Status	Diagnostics	<a href="#">181</a>
1319	Data In Val Sel	Datalinks	<a href="#">193</a>
1320	Data In SelData	Datalinks	<a href="#">193</a>
1321	DPI Fdbk Select	Comm Control	<a href="#">191</a>
1322	Direction Mode	Reference Config	<a href="#">177</a>
1323	DPI P1 Select	DPI Inputs	<a href="#">206</a>
1324	DPI P2 Select	DPI Inputs	<a href="#">206</a>
1325	DPI P3 Select	DPI Inputs	<a href="#">206</a>
1326	DPI P4 Select	DPI Inputs	<a href="#">206</a>
1327	DPI P5 Select	DPI Inputs	<a href="#">206</a>
1328	Drive Logic Rslt	Diagnostics	<a href="#">182</a>
1329	Speed Ref Source	Diagnostics	<a href="#">182</a>
1330	Spd Ref Sel Sts	Diagnostics	<a href="#">183</a>
1343	DPI Port Value	Comm Control	<a href="#">191</a>
1344	Start At Powerup	Restart Modes	<a href="#">159</a>
1345	Powerup Delay	Restart Modes	<a href="#">159</a>
1347	Fault Clear	Faults	<a href="#">184</a>
1348	Fault Clr Mode	Faults	<a href="#">184</a>
1349	Status1 at Fault	Faults	<a href="#">184</a>
1350	Status2 at Fault	Faults	<a href="#">184</a>
1351	Fault 1 Code	Faults	<a href="#">184</a>
1352	Fault 2 Code	Faults	<a href="#">184</a>
1353	Fault 3 Code	Faults	<a href="#">184</a>
1354	Fault 4 Code	Faults	<a href="#">184</a>
1355	Fault 5 Code	Faults	<a href="#">184</a>
1356	Fault 6 Code	Faults	<a href="#">184</a>
1357	Fault 7 Code	Faults	<a href="#">184</a>
1358	Fault 8 Code	Faults	<a href="#">184</a>
1359	Fault 9 Code	Faults	<a href="#">184</a>

No.	Parameter Name	Group	Page
1360	Fault 10 Code	Faults	<a href="#">184</a>
1361	Fault 1 Time	Faults	<a href="#">185</a>
1362	Fault 2 Time	Faults	<a href="#">185</a>
1363	Fault 3 Time	Faults	<a href="#">185</a>
1364	Fault 4 Time	Faults	<a href="#">185</a>
1365	Fault 5 Time	Faults	<a href="#">185</a>
1366	Fault 6 Time	Faults	<a href="#">185</a>
1367	Fault 7 Time	Faults	<a href="#">185</a>
1368	Fault 8 Time	Faults	<a href="#">185</a>
1369	Fault 9 Time	Faults	<a href="#">185</a>
1370	Fault 10 Time	Faults	<a href="#">185</a>
1371	Fault Arm Amps	Faults	<a href="#">185</a>
1372	Fault Speed	Diagnostics	<a href="#">185</a>
1373	Fault Field Amps	Diagnostics	<a href="#">185</a>
1374	Fault Voltage	Diagnostics	<a href="#">185</a>
1375	MOP Select	Reference Config	<a href="#">177</a>
1376	Logic Mask Act	Security	<a href="#">193</a>
1377	Write Mask Act	Security	<a href="#">194</a>
1378	Write Mask Cfg	Security	<a href="#">194</a>
1379	Port Mask Act	Security	<a href="#">194</a>
1380	Drive Alarm 1	Alarms	<a href="#">187</a>
1381	TestPoint Sel	Diagnostics	<a href="#">183</a>
1382	TestPoint Data	Diagnostics	<a href="#">183</a>
1384	TaskLoad 1 ms	Diagnostics	<a href="#">183</a>
1385	TaskLoad 2 ms	Diagnostics	<a href="#">183</a>
1386	TaskLoad 8 ms	Diagnostics	<a href="#">183</a>
1387	Inversion In 9	Digital Inputs	<a href="#">202</a>
1388	Inversion In 10	Digital Inputs	<a href="#">202</a>
1389	Inversion In 11	Digital Inputs	<a href="#">202</a>
1390	Inversion In 12	Digital Inputs	<a href="#">202</a>
1391	ContactControl	Digital Inputs	<a href="#">202</a>
1392	Relay Out 1 Sel	Digital Outputs	<a href="#">206</a>
1393	Inversion Relay1	Digital Outputs	<a href="#">206</a>
1394	Drive Alarm 2	Alarms	<a href="#">188</a>
1402	Last Stop Source	Diagnostics	<a href="#">183</a>
1403	Start Inhibits	Diagnostics	<a href="#">184</a>
1404	Analog In1 Value	Analog Inputs	<a href="#">197</a>
1405	Analog In2 Value	Analog Inputs	<a href="#">197</a>
1406	Analog In3 Value	Analog Inputs	<a href="#">197</a>
1407	Field Econ Delay	Field Config	<a href="#">136</a>
1408	Tachometer Speed	Speed Meters	<a href="#">128</a>
1409	Jog Off Delay	Discrete Speeds	<a href="#">149</a>
1410	Jog Ramp Time	Ramp Rates	<a href="#">157</a>

## Troubleshooting

Topic	Page
Faults and Alarms	219
Drive Status	220
Manually Clearing Faults	221
Fault Descriptions	222
How to Clear an Alarm	228
Alarm Descriptions	228
Common Drive Symptoms and Corrective Actions	231
Testpoint Codes and Functions	233

This chapter provides information to guide you in troubleshooting the PowerFlex® DC drive. Included is a listing and description of drive faults (with possible solutions, when applicable) and alarms.

### Faults and Alarms

A fault is a condition that always stops the drive and prevents it from starting until the fault condition is corrected. There are two fault types.

Type	Description
1	<p>User Configurable</p> <p>This type of fault allows you to configure a parameter to determine how the drive responds to the error condition.</p> <ul style="list-style-type: none"> <li>• When the parameter is configured for a fault, the following events occur.               <ol style="list-style-type: none"> <li>a. The drive stops</li> <li>b. The error condition is displayed on the HIM or signaled via a programmed digital output</li> <li>c. The drive is not allowed to start until the fault condition is corrected</li> </ol> </li> <li>• When the parameter is configured for an alarm, the following events occur.               <ol style="list-style-type: none"> <li>a. The error condition is displayed on the HIM or signaled via a programmed digital output</li> <li>b. The drive continues to run and/or be allowed to start.</li> </ol> </li> <li>• When the parameter is configured for ignore or disable, the drive does not recognize the error condition. In this case, the error condition does not display on the HIM or is not signaled via a programmed digital output.</li> </ul>
2	<p>Non-Configurable</p> <p>This type of fault is always enabled and causes the drive to stop running to protect the drive and/or motor from damage. In some cases, drive or motor repair can be required. The cause of the fault must be corrected before the fault can be cleared (via a fault reset by using the HIM or programmed digital input). The fault will be reset on power-up after repair.</p>

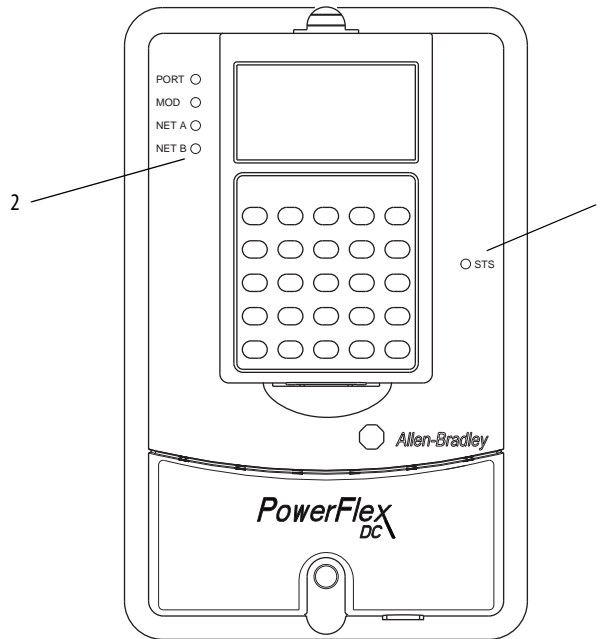
An alarm indicates a drive error condition that does not stop the drive, but can prevent it from starting. There are two types of alarms.

Type	Description
1	<p>User Configurable</p> <p>This type of alarm indicates a drive error condition but does not stop the drive from starting or running. However, if this type of alarm is left uncorrected, a fault condition can eventually occur.</p>
2	<p>Non-Configurable</p> <p>This type of alarm is always enabled and prevents the drive from starting until the alarm condition is corrected.</p>

## Drive Status

The condition or state of your drive is constantly monitored. Any changes are indicated through the status indicators and/or the HIM (if present).

**Figure 65 - Drive Status Indicators**



#	Name	Color	State	Description
1	STS (Status)	Green	Flashing	Drive ready, but not running and no faults are present.
			Steady	Drive running, no faults are present.
		Yellow	Flashing, Drive Stopped	A condition exists that is preventing the drive from starting. Check parameter <a href="#">1403</a> [Start Inhibits] and <a href="#">1380</a> [Drive Alarm 1].
			Flashing, Drive Running	An intermittent type 1 alarm condition is occurring. Check parameter <a href="#">1380</a> [Drive Alarm 1]. See Fault Descriptions on page <a href="#">222</a> and/or Alarm Descriptions on page <a href="#">228</a> .
			Steady, Drive Running	A continuous type 1 alarm condition exists. Check parameter <a href="#">1380</a> [Drive Alarm 1]. See Fault Descriptions on page <a href="#">222</a> and/or Alarm Descriptions on page <a href="#">228</a> .
		Red	Flashing	A fault has occurred. Check [Fault x Code] or view the Fault Queue on the HIM. See Fault Descriptions on page <a href="#">222</a> .
Steady	A non-resettable, non-configurable fault has occurred. Check [Fault x Code] or view the Fault Queue on the HIM. See Fault Descriptions on page <a href="#">222</a> .			
2	PORT	See the Communication Adapter User Manual.		Status of DPI port internal communication (if present).
	MOD			Status of communication module (when installed).
	NET A			Status of network (if connected).
	NET B			Status of secondary network (if connected).





## Fault Descriptions

Table 42 - Fault Types, Descriptions, and Actions

Fault Name	Number	Type <sup>(1)</sup>	Description/Possible Cause	Action
AC Undervoltage	4	2	There is an undervoltage on the power circuit (can only occur while the drive is active, i.e., running or jogging). Possible causes include:	
			<ul style="list-style-type: none"> <li>Par 481 [UnderVolt Thresh] is set incorrectly (possibly set to 400V when the drive is rated for 230V input power).</li> </ul>	Set Par 481 [UnderVolt Thresh] correctly and then reset the drive via Par 1347 [Fault Clear].
			<ul style="list-style-type: none"> <li>The incoming voltage to the power terminals (U/V/W) of the drive is too low due to:               <ul style="list-style-type: none"> <li>The AC input voltage is too low or one phase is missing.</li> <li>There are poor cable connections (for example terminals on contactor, choke, filter, is not properly connected).</li> </ul> </li> </ul>	<ul style="list-style-type: none"> <li>Verify AC input power level.</li> <li>Check all connections.</li> </ul>
			<ul style="list-style-type: none"> <li>The line fuses have tripped.</li> <li>The AC input voltage dips or there is a high disturbance in the supply voltage.</li> </ul>	<ol style="list-style-type: none"> <li>Remove power from the drive.</li> <li>Eliminate AC input voltage dips and/or disturbances.</li> <li>Replace any blown fuses.</li> </ol>
			<ul style="list-style-type: none"> <li>A fuse or fuses on the overvoltage clipping board has blown (frame D drives only).</li> </ul>	Check the fuses on the overvoltage clipping board and replace as necessary.
Note: This fault also occurs if the control board is separately powered and started without AC input voltage.				
Arm Overvoltage	5	1	There is an overvoltage on the armature circuit (125% of Par 175). Possible causes include:	
			<ul style="list-style-type: none"> <li>Par 175 [Rated Motor Volt] is set too low.</li> </ul>	Set Par 175 [Rated Motor Volt] correctly.
			<ul style="list-style-type: none"> <li>The drive is not configured to use field weakening, but the motor can only reach the set speed when the drive is in field weakening mode.</li> </ul>	Check the value of Par 469 [Field Mode Sel] and set accordingly.
Note: Configure with Par 203 [OverVolt Flt Cfg].				
Auxiliary Input	2	1	An auxiliary input interlock is open or a voltage (15...30V) or reference signal is missing for the digital input set to 14 "Aux Fault". Note: Configure with Par 354 [Aux Inp Flt Cfg].	Check remote wiring.
Drive Overload	64	2	The rated drive current (Par 465 [Drive Size]) was exceeded by 150% for 1 minute.	Reduce the drive current limits.
Dsp Error	132	2	A non-resettable software error exists on the control board.	Cycle power to the drive. If the problem persists, replace the control board.
EEPROM Error	100	2	One of the following has occurred: <ul style="list-style-type: none"> <li>Parameter values could not be saved.</li> <li>The control board was replaced and DIP switch S15 is set incorrectly for the drive size.</li> <li>You have upgraded from one major firmware revision to another (for example, v2.xxx to v3.xxx).</li> </ul> Note: When this fault occurs, all parameters are reset to the default value.	<ol style="list-style-type: none"> <li>If the control board is new, verify that DIP switch S15 is set correctly. See DIP Switch S15 Settings on page 79.</li> <li>Reset the fault.</li> <li>If this fault occurs again, cycle power to the drive.</li> <li>If the problem persists, replace the control board.</li> </ol>
Encoder Error	92	2	An error was detected with the Encoder signal while it was configured for use by the drive.	<ol style="list-style-type: none"> <li>Verify the encoder wiring.</li> <li>Verify the encoder configuration in Par 652 [Encoder Err Chk] and the setting of DIP switches S20 and S21 (See DIP Switch and Jumper Settings on page 77).</li> <li>Verify the encoder power supply.</li> </ol>
Fld Current Loss	6	1	The field current is too low (less than 50% of Par 468). Possible causes include:	
			<ul style="list-style-type: none"> <li>The field current regulator is not enabled.</li> </ul>	Enable the field current regulator via Par 497 [Field Reg Enable].
			<ul style="list-style-type: none"> <li>The conductors in the field circuit have been interrupted.</li> </ul>	Check the motor field wiring. Measure the resistance of the motor and verify that it matches motor nameplate data.
			<ul style="list-style-type: none"> <li>The field fuses are currently open.</li> </ul>	Check the field fuses and replace as necessary.
Note: Configure with Par 473 [FldLoss Flt Cfg].				
Fwd End Limit	95	2	An end limit for the forward direction has been reached. When the end limit is reached, the assigned contacts open and a drive current-limit stop occurs.	This fault is always enabled when assigned to a digital input (see Pars 133...144). If digital limits (hardware signals) are in use, verify that the digital inputs are connected to normally closed contacts.
Fwd Over Travel	97	2	A forward direction over travel signal has occurred, causing the drive to coast to a stop.	This fault is always enabled when assigned to a digital input (see Pars 133...144).
Hardware Fault	130	2	A non-resettable hardware error has occurred.	Cycle power to the drive. If the problem persists, replace the control board.

Fault Name	Number	Type <sup>(1)</sup>	Description/Possible Cause	Action
Heatsink OvrTemp	8	2	The heatsink temperature is too high Possible causes include:	
			<ul style="list-style-type: none"> <li>The surrounding air temperature is too high.</li> <li>The drive cooling fans have failed (drives &gt; 110 A).</li> </ul>	Lower the surrounding air temperature.  Check the fan fuses and fans. <ul style="list-style-type: none"> <li>If the fan fuses have failed, replace the fuses. (The fans are protected by the fuses in the power supply circuit and are contained on the switching power supply circuit board in frame A and B drives only. See Control Power Circuit Protection Fuses on page 259.)</li> <li>If the fans have failed, replace the fans.</li> </ul>
			<ul style="list-style-type: none"> <li>The heatsink is dirty.</li> </ul>	Clean the heatsink.
Interrupt Error	131	2	A non-resettable software error has occurred in the main application.	Report this error to Rockwell Automation Technical Support.
Inverting Fault	37	2	A digital input (Pars 133...144) configured as 64 "Invert Flt" has been removed.	Check the status of the inverting fault device that is connected to the digital input.
Main Contactor	10	2	One of the following has occurred: <ul style="list-style-type: none"> <li>The Main and/or Dynamic Brake (DB) contactor failed to open or close in the proper amount of time (960 ms).</li> <li>A digital input and/or relay output 1 is incorrectly wired and/or configured.</li> <li>Wiring to a digital input configured for contactor has opened.</li> </ul>	<ul style="list-style-type: none"> <li>Check all contactor wiring and drive jumpers. Repair or replace the contactor or contactors if the problem persists.</li> <li>Check the digital input and/or relay output 1 (terminals 35 and 36) wiring and configuration using Pars 1391 [ContactorControl], 1392 [Relay Out 1 Sel] and [Digital Inx Sel]. See Contactors on page 31 for more information.</li> </ul>
Motor Overload	7	1	The selected motor overload current level (set in Par 179 [Nom Mtr Arm Amps]) has been exceeded. The limits are based on the value of Par 376 [MtrOvrld Type]. 0 "StandardDuty" is 150% for 60 sec. or 200% for 3 sec. 1 "HeavyDuty" is 200% for 1 minute (250% for 30 sec). Note: Configurable with Par 479 [MtrOvrld Flt Cfg].	Reduce the motor load, current limits, and/or ramp times.
Motor Over Temp	16	1	The motor has exceeded its temperature rating (as signaled by the thermistor that is connected to the drive terminals 78 and 79). Possible causes include:	
			<ul style="list-style-type: none"> <li>The motor does not have a thermistor and there is no resistor between terminals 78 and 79 on the drive.</li> </ul>	See Thermistors and Thermal Switches on page 64 for configuration information.
			<ul style="list-style-type: none"> <li>The cable between the thermistor connection on the motor and terminals 78 and 79 on the drive has been broken.</li> </ul>	Check and repair any damage to or loss of connection of the thermistor cables between the motor and drive.
			<ul style="list-style-type: none"> <li>Possible causes for motor overheating can also include one of the conditions that are listed here:                             <ul style="list-style-type: none"> <li>The load cycle is too extreme.</li> <li>The surrounding air temperature at the site of the motor is too high.</li> <li>The external fan motor has failed.</li> <li>The motor does not have an external fan and the load is too large at low speeds.</li> <li>The cooling effect of the internal fan on the motor shaft is too low for the load cycle.</li> </ul> </li> </ul>	Reduce the load. Reduce the surrounding air temperature.  Replace the motor fan. Reduce the load cycle or fit the motor with an external fan.  Reduce the load cycle or fit the motor with an external fan.
			Note: Configure with Par 365 [OverTemp Flt Cfg].	
No Fault	0	–	When present in the fault queue in the drive only, this fault indicates that there are currently no faults in the drive.	Informational only.
		2	When displayed on the HIM, this fault can indicate one of the following issues: <ul style="list-style-type: none"> <li>The SA-SB terminal on a frame B or C drive is incorrectly configured.</li> <li>There is a possible problem with the control power.</li> </ul>	For frame B or C drives only, verify that terminal SA-SB is properly configured for the control circuit input power input voltage used. See Control Circuit Input Power on page 67.
Open SCR	89	1	An open SCR fault condition has been detected. This fault can only occur when Par 213 [SCR Diag Test En], bit 0 "OpenSCR Tst" is set (=1) and Par 216 [OpenSCR Flt Cfg] is set to "Fault" (2). The SCR (or SCR pair) that caused the fault are shown in Par 214 [SCR Diag Status].	<ul style="list-style-type: none"> <li>Verify that the correct values are set in Pars 217 [Open SCR Threshld] and 218 [OpenSCR Trip Lvl].</li> <li>Replace the failed SCR devices.</li> </ul>

Fault Name	Number	Type <sup>(1)</sup>	Description/Possible Cause	Action
Overcurrent	13	1	An overcurrent has occurred in the motor circuit. Possible causes include:	
			<ul style="list-style-type: none"> <li>There is a short-circuit or ground fault at the output of the drive.</li> </ul>	Verify that the armature circuit wiring is correct.
			<ul style="list-style-type: none"> <li>The current regulator was not properly fine-tuned.</li> <li>The value of Par 584 [OverCurrent Thr] is too low.</li> </ul>	See Tune the Current Regulator on page 102. Increase the value of Par 584 [OverCurrent Thr] accordingly.
Overspeed	25	2	The encoder or tachometer feedback indicated a speed that is more than the value of Par 585 [Overspeed Val]. Note: Configurable with Par 585 [Overspeed Val].	Remove the excessive load or overhauling conditions or increase the value of Par 585 [Overspeed Val].
Params Defaulted	48	2	User parameters have been reset to their default values.	Informational only.
Port 1...5 Adapter	71...75	2	The communication card has a fault.	Check the DPI device event queue and fault information for the device.
Port 1...5 DPI Loss	81...85	2	The DPI port stopped communicating.	<ol style="list-style-type: none"> <li>Check the HIM connection.</li> <li>If adapter was not intentionally disconnected, check the wiring to the port. Replace the wiring, port expander, adapters, control board, or complete drive as required.</li> <li>If an adapter was intentionally disconnected and the bit for that adapter in Par 591 [Logic Mask] is set to "1", this fault occurs. To disable this fault, set the appropriate bit in [Logic Mask] for the adapter to "0."</li> </ol>
Power Failure	3	2	Possible causes include:	
			<b>IMPORTANT</b> Remove power from the drive before removing the I/O terminal blocks and/or fuses.	
			<p>There is a fault in the 24V control board supply - the voltage is below the permitted value. In most cases, the cause of this fault is a problem with the external I/O wiring.</p>	<ul style="list-style-type: none"> <li>Pull the plug-in I/O terminal blocks out of the control circuit board and reset the drive via 1347 [Fault Clear]. If there are no other faults, check the I/O wiring for a short-circuit including the cable shielding.</li> <li>Check fuses F1 and F2 on the switching power supply circuit board (frame A size drives only have one fuse - F1). Replace as necessary.*</li> <li>Check varistor fuses F1, F2, and F3 on the pulse transformer or Transient Noise Filter circuit boards for Frame C size drives. Replace as necessary.*</li> <li>If this fault occurs again, an internal fault can be present. Contact your Rockwell Automation sales office.</li> </ul> <p>*Note: See Control Power Circuit Protection Fuses on page 259 for fuse size information.</p>
<p>The incoming voltage to the control power terminals (U2, V2) is too low due to:</p> <ul style="list-style-type: none"> <li>The AC input voltage is too low</li> <li>There are poor cable connections.</li> <li>The fuse or fuses on the switching power supply circuit board have blown.</li> </ul>	<ul style="list-style-type: none"> <li>Verify AC input power level.</li> <li>Check all connections.</li> <li>Check and replace the fuse or fuses if necessary.</li> </ul>			
Resolver Error	93	2	An error was detected with the resolver signal while it was configured for use by the drive.	<ol style="list-style-type: none"> <li>Verify the resolver wiring.</li> <li>Verify the resolver configuration in Pars 423 [Reslvr Type Sel], 424 [Reslvr Spd Ratio], and 425 [Resolver Config].</li> <li>Verify the resolver power supply.</li> </ol>
Rev End Limit	96	2	An end limit for the reverse direction has been reached. When the end limit is reached, the contacts open and a drive current-limit stop occurs.	This fault is always enabled when assigned to a digital input (see Pars 133...144). If digital limits (hardware signals) are in use, verify that the digital inputs are connected to normally closed contacts.
Rev Over Travel	98	2	A reverse direction over travel signal has occurred, causing the drive to coast to a stop.	This fault is always enabled when assigned to a digital input (see Pars 133...144).
Shorted SCR	90	2	A shorted SCR fault condition has been detected. This fault can only occur when Par 213 [SCR Diag Test En], bit 1 "OpenSCR Tst" is set (= 1). The SCR (or SCR pair) that caused the fault are shown in Par 214 [SCR Diag Status].	Replace failed SCR device or devices.

Fault Name	Number	Type <sup>(1)</sup>	Description/Possible Cause	Action
Spd Fdbk Loss	91	1	The speed feedback device is indicating a value that is less than 5% of Par 162 [Max Feedback Spd]. However, the measured armature voltage is greater than the value of Par 455 [Spd FB Loss Lvl].	
			Possible causes include:	
			• The conductors of the feedback signal have been interrupted.	Current from one or more of the feedback device wires is not reaching the drive. Check the feedback device wiring.
			• One or several encoder/resolver channels are missing (conductor interruption, no power supply).	Check the encoder/resolver connections and power supply.
			• The motor voltage is incorrect.	1. Verify that Par 175 [Rated Motor Volt] is set correctly 2. Tune the motor.
			• The ramp rate is too fast for the connected load.	1. Reduce the load. 2. Reduce the ramp rate.
• Field Weakening is set incorrectly.	Verify that the value of Par 456 [Fld Weaken Ratio] is set properly.			
			The encoder or resolver configuration is incorrect.	1. For encoder feedback, verify the setting of DIP switch S20 (see page 78) and Par 652 [Encoder Err Chk]. 2. Verify that the connected encoder provides the input and output voltage as determined by DIP switch S21 (see page 78). 3. For resolver feedback, verify that Par 426 [Resolver Status] is not indicating any errors.
Note: This fault condition can be configured to produce an alarm with Par 478 [Spd Loss Flt Cfg].				
SSC Error	20	1	Indicated that a valid fiber packet has not been received within the time period defined in Par 409 [SSC Threshold].	<ul style="list-style-type: none"> <li>Verify that all fiber-optic connections are correct and properly secured.</li> <li>Check all fiber-optic cables for damage. If any of the cables are cracked or damaged, replace the cables.</li> <li>If this fault persists, replace the Fiber-optic Interface circuit board.</li> </ul>
STune Aborted	62	2	The speed regulator auto tuning procedure was stopped manually.	Informational only.
STune CurLimit	59	2	One of the following has occurred:	
			<ul style="list-style-type: none"> <li>The value of Par 1048 [Autotune Cur Lim] for auto tuning the speed regulator is set too high.</li> <li>Par 107 [Speed Zero Level] and/or 108 [Speed Zero Delay] is set too high.</li> </ul>	Decrease the value of Par 1048 [Autotune Cur Lim] and repeat the auto tune procedure.  Set Pars 107 and 108 to their default values when performing the Speed Loop Autotuning function.
STune FrictionLo	60	2	The friction value that is attained during the auto tuning procedure is zero or lower than the control precision limit.	Decrease the value of Par 1048 [Autotune Cur Lim] and repeat the auto tune procedure.
STune LoadHi	58	2	One of the following has occurred:	
			<ul style="list-style-type: none"> <li>The loading torque value is too high at zero speed to complete the speed regulator auto tuning procedure.</li> <li>Par 107 [Speed Zero Level] and/or 108 [Speed Zero Delay] is set too high.</li> </ul>	Decrease the load torque, where applicable, and repeat the auto tune procedure.  Set Pars 107 and 108 to their default values when performing the Speed Loop Autotuning function.
STune Overspeed	56	2	The measured motor speed is too high during the speed regulator auto tuning procedure.	Decrease the value of Par 1048 [Autotune Cur Lim] and repeat the auto tune procedure.
STune Stalled	57	2	The drive stalled during the speed regulator auto tuning procedure.	Increase the value of Par 1048 [Autotune Cur Lim] and repeat the auto tune procedure.
STune Timeout	61	2	The speed regulator auto tuning procedure did not complete within the available time or the current regulator auto tuning procedure did not complete within 15 minutes.	Verify the value of Par 1048 [Autotune Cur Lim]. If the value of Par 1048 is set too low, the test cannot finish. The autotune procedure can only finish when the motor has enough time to reach a maximum speed of 33% of the lowest of one of these parameters: <ul style="list-style-type: none"> <li>Par 45 [Max Ref Speed]</li> <li>Par 3 [Max Speed Fwd]</li> <li>Par 4 [Max Speed Rev]</li> </ul> Set the value of these parameters appropriately and repeat the auto tuning procedure.
Sustained Curr	70	2	One of the following has occurred: <ul style="list-style-type: none"> <li>The motor CEMF is too high or the line voltage is too low</li> <li>A current bridge change command has not completed within 1 second</li> </ul>	<ul style="list-style-type: none"> <li>Check the line voltage and frequency.</li> <li>Check the motor brushes and connections.</li> <li>Check the main and DB contactor connections if present.</li> <li>Verify that there are no overhauling loads present.</li> </ul>

Fault Name	Number	Type <sup>(1)</sup>	Description/Possible Cause	Action
TorqPrv Spd Band	94	2	The difference between the commanded speed and the encoder/resolver speed has exceeded the level set in Par <a href="#">1105</a> [Speed Dev Band] for a time period greater than that value specified in Par <a href="#">1106</a> [Spd Band Intgrtr]. This fault is only enabled when Par <a href="#">1100</a> [Torq Prove Cfg], bit 0 "TP Enable" is set and causes the drive to coast to a stop. Possible causes include:	
			• Speed loop tuning is not correct.	Increase Par <a href="#">434</a> [Spd Reg BW] or Par <a href="#">433</a> [Total Inertia]. If these values are set too high, the speed regulator becomes unstable.
			• The drive is operating under a current limit.	Raise the current limit set in Par <a href="#">7</a> [Current Limit]. If this value is set too high, a motor overload can occur.
			• Drive acceleration/deceleration rates are too fast.	Reduce the acceleration/deceleration rates.
			• The brake is not releasing.	Check brake wiring and operation.
			• The motor field is not reaching the rated value.	Check that the motor field is wired and configured correctly.
Travel Lim Cflct	99	2	Travel limits are in conflict. Both the forward and reverse travel limits indicate that they are simultaneously active, causing a drive current-limit stop.	<ul style="list-style-type: none"> <li>If digital limits (hardware signals) are in use, verify that the following forward and reverse digital input pairs are not both off simultaneously: fwd/rev decel travel limit digital inputs and fwd/rev end stop travel limit digital inputs (see Pars <a href="#">133</a> . . . <a href="#">144</a>). The travel limit digital inputs are meant to be connected to normally closed switch contacts, so the digital input status reads an off (0 = False) bit status when the machine is on limit and the switch contact opens. A possible cause for this condition is loss of common power to both the forward and reverse travel limit switches.</li> <li>If software travel limits are in use, check the state of the fwd/rev travel limit bits in Par <a href="#">1101</a> [Torq Prov Setup]. These bits are on (1) when the machine is on limit. Bit 2 "Decel Fwd" and bit 4 "Decel Rev" <u>must not</u> be on simultaneously. Similarly, Bit 3 "End Stop Fwd" and bit 5 "End Stop Rev" <u>must not</u> be on simultaneously.</li> </ul>

(1) See [page 219](#) for a description of fault types.

**Table 43 - Fault Cross Reference by Number**

No. <sup>(1)</sup>	Fault	No. <sup>(1)</sup>	Fault
<a href="#">2</a>	Auxiliary Input	<a href="#">81...85</a>	Port 1 DPI Loss
<a href="#">3</a>	Power Failure		Port 2 DPI Loss
<a href="#">4</a>	AC Undervoltage		Port 3 DPI Loss
<a href="#">5</a>	Arm Overvoltage		Port 4 DPI Loss
<a href="#">6</a>	Fld Current Loss		Port 5 DPI Loss
<a href="#">7</a>	Motor Overload	<a href="#">89</a>	Open SCR
<a href="#">8</a>	Heatsink OvrTemp	<a href="#">90</a>	Shorted SCR
<a href="#">10</a>	Main Contactor	<a href="#">91</a>	Speed Fdbk Loss
<a href="#">13</a>	Overcurrent	<a href="#">92</a>	Encoder Error
<a href="#">16</a>	Motor Over Temp	<a href="#">93</a>	Resolver Error
<a href="#">20</a>	SSC Error	<a href="#">94</a>	TorqPrv Spd Band
<a href="#">25</a>	Overspeed	<a href="#">95</a>	Fwd End Limit
<a href="#">37</a>	Inverting Fault	<a href="#">96</a>	Rev End Limit
<a href="#">48</a>	Params Defaulted	<a href="#">97</a>	Fwd Over Travel
<a href="#">56</a>	STune Overspeed	<a href="#">98</a>	Rev Over Travel
<a href="#">57</a>	STune Stalled	<a href="#">99</a>	Travel Lim Cflct
<a href="#">58</a>	STune LoadHi	<a href="#">100</a>	EEPROM Error
<a href="#">59</a>	STune CurLimit	<a href="#">130</a>	Hardware Fault
<a href="#">60</a>	STune FrictionLo	<a href="#">131</a>	Interrupt Error
<a href="#">61</a>	STune Timeout	<a href="#">132</a>	Dsp Error
<a href="#">62</a>	STune Aborted		
<a href="#">64</a>	Drive Overload		
<a href="#">70</a>	Sustained Curr		
<a href="#">71...75</a>	Port 1 Adaptor		
	Port 2 Adaptor		
	Port 3 Adaptor		
	Port 4 Adaptor		
	Port 5 Adaptor		

(1)Faults that are not listed are reserved for future use.

## How to Clear an Alarm

Alarms are automatically cleared when the condition that caused the alarm is no longer present.

## Alarm Descriptions

The status of the alarms can be viewed in [1380](#) [Drive Alarm 1].

**Table 44 - Alarm Descriptions and Actions**

Alarm	Type	Description																																																																
Arm Overvoltage	1	There is a possible overvoltage on the armature circuit or Par <a href="#">175</a> [Rated Motor Volt] is set too low for the application. See the "Arm Overvoltage" fault description on <a href="#">page 222</a> for more information.																																																																
Auxiliary Input	1	An auxiliary input interlock is open or a voltage (15...30V) or reference signal is missing for the digital input set to 14 "Aux Fault". See the "Auxiliary Input" fault description on <a href="#">page 222</a> for more information.																																																																
BipolarCflct	2	Par <a href="#">1322</a> [Direction Mode] is set to "Bipolar" or "Reverse Dis" and one or more of these digital input functions is configured: "Fwd/Reverse," "Run Forward," "Run Reverse," "Jog Forward," "Jog Reverse," "Rev Dec Limit," or "Rev End Limit."																																																																
BrakeSlipped	1	The encoder movement has exceeded the level in Par <a href="#">1110</a> [Brk Slip Count] after the brake was set and the brake slip maneuver is controlling the drive (drive is active). Cycle power to the drive to reset.																																																																
	2	The encoder movement has exceeded the level in Par <a href="#">1110</a> [Brk Slip Count] after the brake was set and the brake slip maneuver is finished (drive is stopped). Cycle power to the drive to reset.																																																																
CntactrCflct	2	<p>Contact input functions are in conflict:</p> <ul style="list-style-type: none"> <li>When Par <a href="#">1391</a> [ContactorControl] is set to "None", both relay outputs (Pars <a href="#">1392</a> [Relay Out 1 Sel] and <a href="#">629</a> [Relay Out 2 Sel] and all digital inputs ([Digital Inx Sel]) cannot be set to "Contactor" or "ContactorDB".</li> <li>With [ContactorControl] set to "AC Cntr" or "DC Cntr", one relay output and one digital input must be set to "Contactor". No relay or digital output can be defined as "ContactorDB".</li> <li>With [ContactorControl] set to "AC Cntr+DB" or "DC Cntr+DB", both relay outputs and one digital input must be set to "Contactor", "ContactorDB" and "Contactor", respectively.</li> </ul> <p>Any relay output can be configured as contactor or DB control and any digital input as contactor status. Therefore, to avoid possible conflicts, take care to program the parameter selections so that they match the relay output and/or digital input terminal block wiring correctly.</p>																																																																
DigInCflctA	2	Digital input functions are in conflict. Combinations that are marked with a "⚡" causes an alarm.																																																																
		<table border="1"> <thead> <tr> <th></th> <th>Acc2/Dec2</th> <th>Accel 2</th> <th>Decel 2</th> <th>Jog 1/2</th> <th>Jog Fwd</th> <th>Jog Rev</th> <th>Fwd/Rev</th> </tr> </thead> <tbody> <tr> <td>Acc2/Dec2</td> <td></td> <td>⚡</td> <td>⚡</td> <td></td> <td></td> <td></td> <td></td> </tr> <tr> <td>Accel 2</td> <td>⚡</td> <td></td> <td></td> <td></td> <td></td> <td></td> <td></td> </tr> <tr> <td>Decel 2</td> <td>⚡</td> <td></td> <td></td> <td></td> <td></td> <td></td> <td></td> </tr> <tr> <td>Jog 1/2</td> <td></td> <td></td> <td></td> <td></td> <td>⚡</td> <td>⚡</td> <td></td> </tr> <tr> <td>Jog Fwd</td> <td></td> <td></td> <td></td> <td>⚡</td> <td></td> <td></td> <td>⚡</td> </tr> <tr> <td>Jog Rev</td> <td></td> <td></td> <td></td> <td>⚡</td> <td></td> <td></td> <td>⚡</td> </tr> <tr> <td>Fwd/Rev</td> <td></td> <td></td> <td></td> <td></td> <td>⚡</td> <td>⚡</td> <td></td> </tr> </tbody> </table>		Acc2/Dec2	Accel 2	Decel 2	Jog 1/2	Jog Fwd	Jog Rev	Fwd/Rev	Acc2/Dec2		⚡	⚡					Accel 2	⚡							Decel 2	⚡							Jog 1/2					⚡	⚡		Jog Fwd				⚡			⚡	Jog Rev				⚡			⚡	Fwd/Rev					⚡	⚡	
			Acc2/Dec2	Accel 2	Decel 2	Jog 1/2	Jog Fwd	Jog Rev	Fwd/Rev																																																									
		Acc2/Dec2		⚡	⚡																																																													
		Accel 2	⚡																																																															
		Decel 2	⚡																																																															
		Jog 1/2					⚡	⚡																																																										
		Jog Fwd				⚡			⚡																																																									
Jog Rev				⚡			⚡																																																											
Fwd/Rev					⚡	⚡																																																												



Alarm	Type	Description																																																																																																				
DigInCflctB	2	<p>One of these digital input conflicts exists:</p> <ul style="list-style-type: none"> <li>A digital Start input has been configured without a Stop input</li> <li>None of the digital inputs are configured for "Enable"</li> <li>Other digital input functions are in conflict. Combinations that conflict are marked with a "⚡" and causes an alarm.</li> </ul> <table border="1"> <thead> <tr> <th></th> <th>Start</th> <th>Stop-CF</th> <th>Run</th> <th>Run Fwd</th> <th>Run Rev</th> <th>Jog 1/2</th> <th>Jog Fwd</th> <th>Jog Rev</th> <th>Fwd/Rev</th> </tr> </thead> <tbody> <tr> <td>Start</td> <td></td> <td></td> <td>⚡</td> <td>⚡</td> <td>⚡</td> <td></td> <td>⚡</td> <td>⚡</td> <td></td> </tr> <tr> <td>Stop-CF</td> <td></td> <td></td> <td></td> <td></td> <td></td> <td></td> <td></td> <td></td> <td></td> </tr> <tr> <td>Run</td> <td>⚡</td> <td></td> <td></td> <td>⚡</td> <td>⚡</td> <td></td> <td>⚡</td> <td>⚡</td> <td></td> </tr> <tr> <td>Run Fwd</td> <td>⚡</td> <td></td> <td>⚡</td> <td></td> <td></td> <td>⚡</td> <td></td> <td></td> <td>⚡</td> </tr> <tr> <td>Run Rev</td> <td>⚡</td> <td></td> <td>⚡</td> <td></td> <td></td> <td>⚡</td> <td></td> <td></td> <td>⚡</td> </tr> <tr> <td>Jog 1/2</td> <td></td> <td></td> <td></td> <td>⚡</td> <td>⚡</td> <td></td> <td></td> <td></td> <td></td> </tr> <tr> <td>Jog Fwd</td> <td>⚡</td> <td></td> <td>⚡</td> <td></td> <td></td> <td></td> <td></td> <td></td> <td></td> </tr> <tr> <td>Jog Rev</td> <td>⚡</td> <td></td> <td>⚡</td> <td></td> <td></td> <td></td> <td></td> <td></td> <td></td> </tr> <tr> <td>Fwd/Rev</td> <td></td> <td></td> <td></td> <td>⚡</td> <td>⚡</td> <td></td> <td></td> <td></td> <td></td> </tr> </tbody> </table>		Start	Stop-CF	Run	Run Fwd	Run Rev	Jog 1/2	Jog Fwd	Jog Rev	Fwd/Rev	Start			⚡	⚡	⚡		⚡	⚡		Stop-CF										Run	⚡			⚡	⚡		⚡	⚡		Run Fwd	⚡		⚡			⚡			⚡	Run Rev	⚡		⚡			⚡			⚡	Jog 1/2				⚡	⚡					Jog Fwd	⚡		⚡							Jog Rev	⚡		⚡							Fwd/Rev				⚡	⚡				
	Start	Stop-CF	Run	Run Fwd	Run Rev	Jog 1/2	Jog Fwd	Jog Rev	Fwd/Rev																																																																																													
Start			⚡	⚡	⚡		⚡	⚡																																																																																														
Stop-CF																																																																																																						
Run	⚡			⚡	⚡		⚡	⚡																																																																																														
Run Fwd	⚡		⚡			⚡			⚡																																																																																													
Run Rev	⚡		⚡			⚡			⚡																																																																																													
Jog 1/2				⚡	⚡																																																																																																	
Jog Fwd	⚡		⚡																																																																																																			
Jog Rev	⚡		⚡																																																																																																			
Fwd/Rev				⚡	⚡																																																																																																	
DigInCflctC	2	<p>Multiple physical input has been configured to the same input function. Multiple configurations are not allowed for the following input functions.</p> <p>Forward/Reverse      Run Reverse      Run Forward</p> <p>Jog Forward          Jog Reverse      Speed Select 1</p> <p>Speed Select 2      Speed Select 3      Acc2 / Dec2</p> <p>Accel 2              Decel 2              Run</p>																																																																																																				
FB Cfg Cflct	2	<p>One of the following has occurred:</p> <ul style="list-style-type: none"> <li>Par 414 [Fdbk Device Type] does not equal 3 "Armature" and Par 478 [Spd Loss Flt Cfg] is set to "Alarm" while Par 458 [SpdReg FB Bypass] is set to "Disabled".</li> <li>Par 414 [Fdbk Device Type] is set to 4 "Resolver" and Pars 429 [Resolver Pos Sel], 430 [Resolver Spd Sel], 786 [PID Source], 1204 [Line Spd Source], or 1284 [Ref Spd Source] are selecting a resolver signal.</li> <li>Par 414 [Fdbk Device Type] is set to 1 "Encoder" and Pars 786, 1021, 1204, or 1284 are selecting an encoder signal.</li> </ul>																																																																																																				
FldCfg Cflct	2	<p>The selected operating mode of the field controller is in conflict with another setting in the drive or a permanent magnet motor is incorrectly configured. This alarm displays under the following conditions:</p> <ul style="list-style-type: none"> <li>Par 469 [Field Mode Sel] = "Field Weaken" or "External" and Par 414 [Fdbk Device Type] = "Armature"</li> <li>Par 469 [Field Mode Sel] = "Field Weaken" or "External" and Par 478 [Spd Loss Flt Cfg] = "Alarm"</li> <li>Par 469 [Field Mode Sel] = "Field Weaken" or "Base Speed" and Par 497 [Field Reg En] = "Disabled"</li> <li>Par 469 [Field Mode Sel] = "Base Speed" and Par 498 [Force Min Field] = "Enabled"</li> <li>Par 469 [Field Mode Sel] = "Base Speed" and Par 133...144 [Digital Inx Sel] = "Force Min Fld"</li> </ul>																																																																																																				
Fld Current Loss	1	The field current is too low. See the "Fld Current Loss" fault description on page 222 for more information.																																																																																																				
Motor Overload	1	The selected motor overload current level has been exceeded. See the "Motor Overload" fault description on page 223 for more information.																																																																																																				
Motor Over Temp	1	The motor has exceeded its temperature rating (as signaled by the thermistor that is connected to the drive terminals 78 and 79). See the "Motor Over Temp" fault description on page 223 for more information.																																																																																																				
Ref Cflct	2	<p>1. Multiple drive reference inputs, listed here, are set to the same value:</p> <ul style="list-style-type: none"> <li>Pars 70, 75 and 80 [Anlg Inx Sel]</li> <li>Pars 1323...1327 [DPI Px Select]</li> <li>Par 1021 [Encoder Out Sel]</li> <li>Par 430 [Resolver Spd Sel]</li> </ul> <p>See Figure 87 on page 326 or Speed Reference Selection on page 365 for a graphical representation of the possible reference selections for the drive.</p> <p>2. Both Pars 429 [Resolver Pos Sel] and 430 [Resolver Spd Sel] are non-zero.</p> <p>3. Multiple of the following parameters contains the same value: 786 [PID Source], 1204 [Line Spd Source], and 1284 [Ref Spd Source].</p>																																																																																																				
Open SCR	1	An open SCR condition has been detected (Par 213 [SCR Diag Test En], bit 0 "Open SCR" set (=1) and Par 216 [OpenSCR Flt Cfg] set to "Alarm"). See the Open SCR fault description on page 89 for more information.																																																																																																				

Alarm	Type	Description
Spd Fdbk Err	1	With Par <a href="#">478</a> [Spd Loss Flt Cfg] set to 1 "Alarm" an error condition that is associated with the selected speed feedback device (analog tachometer, encoder, or resolver) was detected.
Spd Fdbk Loss	1	Par <a href="#">478</a> [Spd Loss Flt Cfg] set to 1 "Alarm." The speed feedback device is indicating a value that is less than 5% of Par <a href="#">162</a> [Max Feedback Spd]. However, the measured armature voltage is greater than the value of Par <a href="#">455</a> [Spd FB Loss Lvl]. See the "Spd Fdbk Loss" fault description on page <a href="#">225</a> for more information.
Start At PowerUp	1	Par <a href="#">1344</a> [Start At Powerup] is enabled. The drive can start at any time after drive power-up and the time that is specified in Par <a href="#">1345</a> [Powerup Delay] has elapsed.
Torq Prov Cflct	2	<p>Par <a href="#">1100</a> [Torq Prove Cfg] is enabled (bit 0 = 1) and any of the following conditions/conflicts have been occurred:</p> <ul style="list-style-type: none"> <li>You are operating a non-regenerative drive - negative current is required for the TorqProve feature</li> <li>Par <a href="#">1322</a> [Direction Mode] set to 1 "Rev Disable"</li> <li>Par <a href="#">414</a> [Fdbk Device Type] is set to 3 "Armature Voltage"</li> <li>Par <a href="#">414</a> [Fdbk Device Type] is set to 2 "DC Tach" and Par <a href="#">1100</a> [Torq Prove Cfg] bit 1 "Encoderless" = 0</li> <li>Par <a href="#">458</a> [SpdReg FB Bypass] = 1 "Enabled"</li> <li>Par <a href="#">457</a> [Spd Fdbk Control] = 0 "Disabled"</li> <li>A digital input is configured as "Lift Stop" and Par <a href="#">1100</a> [Torq Prove Cfg] bit 0 "TP Enable" = 0</li> <li>Par <a href="#">166</a> [Alpha Test] is set to 1 "On"</li> <li>Par <a href="#">58</a> [TstGen Output] is not set to 0 "NotConnected"</li> <li>Par <a href="#">467</a> [Max Fld Curr Pct] is not set to 100%</li> <li>Par <a href="#">498</a> [Force Min Field] is set to 0 "Enabled"</li> <li>Par <a href="#">245</a> [Speed Ramp En] is set to 0 "Disabled"</li> <li>Par <a href="#">241</a> [Spd Trq Mode Sel] is not set to 1 "Speed Regulator"</li> <li>There is no relay output that is defined as 31 "TP Brake Cmd"</li> </ul> <p>The following conditions are annunciated on the HIM status line as "TP Encls Cfg" and set Par <a href="#">1394</a> [Drive Alarm 2], bit 2 "TP Encls Cfg" = 1:</p> <ul style="list-style-type: none"> <li>Par <a href="#">414</a> [Fdbk Device Type] is set to 1 "Encoder" or 4 "Resolver" and Par <a href="#">1100</a> [Torq Prove Cfg] bit 1 "Encoderless" = 0</li> <li>Par <a href="#">1100</a> [Torq Prove Cfg], bit 5 "BrkSlipEncls" = 0 or bit 6 "BrkSlipStart" = 1 and bit 1 "Encoderless" = 0</li> </ul>
TP Encls Config	2	The drive has been configured to enable Encoderless TorqProve, but an application conflict exists. You must read and understand the "Attention" on page <a href="#">307</a> relating to the use of TorqProve with no encoder before you can continue.

## Common Drive Symptoms and Corrective Actions

The following tables contain descriptions of common drive symptoms and the possible solutions to correct the problem.

If the drive is experiencing this problem	See page
Drive does not start	<a href="#">231</a>
Drive starts but motor does not turn and no armature current	<a href="#">232</a>
The motor does not reach commanded speed	<a href="#">232</a>
The motor is turning in the wrong direction	<a href="#">232</a>
The motor reaches maximum speed immediately	<a href="#">233</a>

### Drive does not start

Drive Symptom	Action
An external "Start" command was issued, but the drive does not start.	<ul style="list-style-type: none"> <li>Verify that no faults or alarms are displayed. If a fault or alarm is displayed, follow the corrective action provided (see Fault Descriptions on page <a href="#">222</a> or Alarm Descriptions on page <a href="#">228</a>).</li> <li>The external wiring to the programmed Start terminal block connection is missing.</li> <li>Verify that +24V DC is present at terminal block connection.</li> <li>Verify that 24V Supply Common is connected between terminals 18 and 16.</li> <li>Verify that the configuration for Pars 133...144 [Digital Inx Sel] matches the switch wiring.</li> </ul>
The drive is not in a "Ready" state, is not "Enabled" or a "Stop" is asserted.	Check the Enable and Stop inputs. Verify that the wiring is correct (see on page <a href="#">85</a> ).
External AC input or DC output contactor, if used, has not closed.	<p>If using an AC Input contactor:</p> <ul style="list-style-type: none"> <li>Verify that the drive is "Ready", then verify that the required coil voltage is present at terminals 35 and 36 (Relay Output 1). If the coil voltage is present at terminals 35 or 36, then verify that proper voltage is at the AC Input contactor coil.</li> <li>Inspect the contactor for mechanical problems.</li> <li>Verify that Par 1391 [ContactorControl] is set properly.</li> <li>Verify that the contactor and/or auxiliary contact is properly wired to a digital input on the drive and that the appropriate digital input selection parameter (133...144 [Digital Inx Sel]) is set to 31 "Contactor".</li> <li>Verify that parameter 1392 [Relay Out 1 Sel] is set to 25 "Contactor".</li> </ul> <p>If using an external DC Output contactor:</p> <ul style="list-style-type: none"> <li>Verify that the drive is "Ready", then verify that the required coil voltage is present at terminals 35 and 36 (Relay Output 1). If the coil voltage is present at terminals 35 or 36, then verify that the proper voltage is at the DC Output contactor coil.</li> <li>Inspect the contactor for mechanical problems.</li> <li>Verify that parameter 1391 [ContactorControl] is set properly.</li> <li>Verify that the contactor and/or auxiliary contact is properly wired to a digital input on the drive and that the appropriate digital input selection parameter (133...144 [Digital Inx Sel]) is set to 31 "Contactor".</li> <li>Verify that parameter 1392 [Relay Out 1 Sel] is set to 25 "Contactor".</li> </ul>
The external DB resistor contactor, if used, has not closed.	<ul style="list-style-type: none"> <li>Verify that the drive is "Ready", then verify that the required coil voltage is present at terminals 75 and 76 (Relay Output 2). If the coil voltage is present at terminals 75 or 76, then verify that proper voltage is at the DB contactor coil.</li> <li>Inspect contactor for mechanical problems.</li> <li>Verify that parameter 1391 [ContactorControl] is set properly.</li> <li>Verify that the auxiliary contacts for the AC Input or DC Output contactor and DB contactor are properly wired in series to a digital input on the drive.</li> <li>Verify that the appropriate digital input selection parameter (133...144 [Digital Inx Sel]) is set to 31 "Contactor".</li> <li>Verify that parameter 629 [Relay Out 2 Sel] is set to 24 "ContactorDB".</li> </ul>
The drive starts from the HIM but does not start from the terminal block.	Check masks for Terminal Block control (see parameters 591 [Logic Mask] and 592 [Start Mask]).

### Drive starts but motor does not turn and no armature current

Drive Symptom	Action
The drive starts but there is no armature current and the motor does not respond to a speed signal.	<ul style="list-style-type: none"> <li>Verify the wiring to the analog input or inputs that are selected for speed reference (see on page 85).</li> <li>Verify the settings of switch S9 and Par 71 [Anlg In1 Config]; or S10 and Par 76 [Anlg In2 Config]; or S11 and Par 81 [Anlg In3 Config] (see DIP Switch and Jumper Settings on page 77).</li> <li>Verify the speed selection digital input or inputs and the respective input terminal voltage, if used.</li> <li>Verify the analog input voltage that is displayed in parameters 1404 [Analog In1 Value], 1405 [Analog In2 Value] or 1406 [Analog In3 Value].</li> </ul>
The drive starts and armature current is present but the motor does not turn.	<ul style="list-style-type: none"> <li>The Load may be too great for the motor and drive.                             <ul style="list-style-type: none"> <li>Remove the load from the motor and test for motor rotation. If the motor rotates, use an in-line current meter or DC clamp on meter to measure the armature current. The measured armature current must match the armature current feedback value that is displayed in parameters 200 [Arm Current] and 199 [Arm Current Pct]. Increase the value of parameter 7 [Current Limit], 8 [Current Lim Pos], or 9 [Current Lim Neg].</li> </ul> </li> <li>Verify that the measured motor field current, using an in-line current meter or DC clamp on meter, equals the feedback value that is displayed in parameter 351 [Field Current].</li> <li>Verify that the motor nameplate value equals the value that is displayed in parameter 280 [Nom Mtr Fld Amps].</li> <li>Measure the DC voltage that is supplied to the motor field. Verify that the value of parameter 374 [Drv Fld Brdg Cur] equals the setting of DIP Switch S14.</li> <li>If the motor does not rotate with the load removed, check the motor.                             <ul style="list-style-type: none"> <li>Verify that parameter 353 [Zero Torque] is not enabled.</li> </ul> </li> </ul>

### The motor does not reach commanded speed

Drive Symptom	Action
The drive starts and the motor turns but does reach the commanded speed.	<p>The load may be too great for the motor and drive.</p> <ul style="list-style-type: none"> <li>Remove the load from the motor and test for the correct commanded speed. If the motor reaches the commanded speed, use an in-line current meter or DC clamp on meter to measure the armature current. The measured armature current must match the armature current feedback value that is displayed in parameters 200 [Arm Current] and 199 [Arm Current Pct]. Increase the value of parameter 7 [Current Limit], 8 [Current Lim Pos] or 9 [Current Lim Neg].</li> <li>Verify that the measured motor field current, using an in-line current meter or DC clamp on meter, equals the feedback value that is displayed in parameter 351 [Field Current].</li> </ul> <p>If the motor does not achieve commanded speed, continue with following tests:</p> <ul style="list-style-type: none"> <li>Check the speed parameter limits: parameters 2 [Maximum Speed], 3 [Max Speed Fwd], 4 [Max Speed Rev] and 122 [Spd Feedback].</li> <li>Check the analog voltage input and speed reference values: parameters 1404 [Analog In1 Value], 1405 [Analog In2 Value], 44 [Speed Ref A], 48 [Speed Ref B]</li> <li>Check the setting of switch S9 and parameter 71 [Anlg In1 Config], S10 and 76 [Anlg In2 Config] or S11 and 81 [Anlg In3 Config].</li> <li>Tune the analog inputs using parameters 259...261 [Anlg Inx Tune] with the potentiometer set at max.</li> <li>The encoder pulse per revolution (PPR) parameter (169 [Encoder PPR]) value is too high.</li> <li>The DC Tach Scaling is incorrect or the jumpers are not properly set. Check parameter 562 [Anlg Tach Gain] and check the setting of the DC Analog Tachometer DIP Switch S4 (see Figure 56 on page 79).</li> </ul>

### The motor is turning in the wrong direction

Drive Symptom	Action
The motor is rotating in the wrong direction.	<p>When a speed feedback device is not installed, the motor is incorrectly wired.</p> <ul style="list-style-type: none"> <li>Change the armature or field connections to the drive.</li> </ul>
	<p>When a speed feedback device is not installed, the polarity of the analog speed reference signal is incorrect for the required direction.</p>
	<p>The two encoder connections must be reversed (A with A-Not or B with B-Not) when these two conditions are true.</p> <ul style="list-style-type: none"> <li>The motor is turning in the wrong direction</li> <li>The speed feedback is correct</li> </ul>
	<p>When an analog tachometer is installed and the following two conditions are true, the tachometer leads must be reversed.</p> <ul style="list-style-type: none"> <li>The motor is turning in the wrong direction</li> <li>The speed feedback is correct</li> </ul>

### The motor reaches maximum speed immediately

Drive Symptom	Action
The motor accelerates to maximum speed and cannot be controlled.	<p>Check the analog input voltage and speed reference values:</p> <ul style="list-style-type: none"> <li>Parameters 1404 [Analog In1 Value], 1405 [Analog In2 Value], 44 [Speed Ref A] and 48 [Speed Ref B]</li> <li>Check the setting of switch S9 and parameter 71 [Anlg In1 Config], S10 and 76 [Anlg In2 Config] or S11 and 81 [Anlg In3 Config].</li> </ul> <p>The feedback device, encoder, resolver, or DC analog tachometer is not connected/configured, incorrectly connected or has failed.</p> <ul style="list-style-type: none"> <li>Change parameter 414 [Fdbk Device Type] to 3 "Armature" to test the encoder or DC analog tachometer feedback.</li> </ul>

### The motor speed cannot be controlled and the drive does not stop

Drive Symptom	Action
The drive armature voltage feedback terminals are connected to the motor, but exhibits these conditions simultaneously: <ul style="list-style-type: none"> <li>Starts but the motor speed cannot be controlled</li> <li>Does not stop when a stop command is issued</li> </ul>	<p>The polarity of the armature voltage feedback connections may be incorrect:</p> <ol style="list-style-type: none"> <li>By using a voltmeter, measure the drive armature output voltage at terminals C and D, with the positive lead connected to terminal C.</li> <li>Check the polarity of the armature voltage feedback parameter 233. The value of parameter 233 must be the same as the polarity of the armature output voltage at terminals C and D.</li> <li>If the polarity of parameter 233 does not match the value that the voltmeter measured, swap the leads at terminals A1 and A2 on the armature voltage feedback terminal block.</li> </ol>

## Testpoint Codes and Functions

Select a testpoint with Par [1381](#) [TestPoint Sel]. Values can be viewed with Par [1382](#) [TestPoint Data].

No. <sup>(1)</sup>	Description	Values		
		Minimum	Maximum	Default
566	Rx count			
567	Tx count			
568	BusLoss count			
569	Port 1 Timeout			
570	Port 2 Timeout			
571	Port 3 Timeout			
572	Port 4 Timeout			
573	Port 5 Timeout	0	65535	0
574	Port 6 Timeout			
575	Internal gain of P188 (x100)			
576	Internal gain of P189 (x100)			
577	Internal gain of P190 (x100)			
578	Internal gain of P191 (x100)			
579	Internal gain of P192 (x100)			
580	Internal gain of P193 (x100)			
581	Max DSP execution time (20 MHz counts)	0	833 (41.65 μs)	464 (23.2 μs)
582	Number of incorrect packets received from the Fiber-optic Interface circuit board fiber-optic connections	0	65535	0
583	Value returned by the Fiber-optic Interface circuit board when power is applied. A value other than 23041 indicates that the board is configured but is not present or has not been properly installed			
584	Minimum firing angle reached during drive lifetime			
585	Min firing angle reached since last power cycle			

(1) Enter in Par 1382 [TestPoint Sel].

**Notes:**

---

## Supplemental Drive Information

<b>Topic</b>	<b>Page</b>
Certifications and Specifications	236
IP20 NEMA / UL Type Open Watts Loss	236
Communication Configurations	240
Drive Power Circuit Protection	243
Control Power Circuit Protection Fuses	259
AC Input Line Reactors and AC Input Contactors	264
Isolation Transformers	267
Dynamic Brake Resistor Kits and DC Output Contactors	269
DC Contactor Crimp Lug Kit Specifications	271
Alternate EMC Filters	273
Terminal Adapter Kits for Frame D Drives	279

This appendix provides drive specification, communication configuration, circuit protection and supplemental system components information.

## Certifications and Specifications

Please see the PowerFlex® Digital DC Drive Technical Data, publication [20P-TD001](#), for certification and specification information.

### IP20 NEMA / UL Type Open Watts Loss

The watts loss data that is shown in [Table 45](#) is based on the rated current of the drive.

**Table 45 - Frame A Drives Watts Loss and Fan Capacity**

Drive Current Rating Code <sup>(1)</sup>		Total Watts Loss	Total Value for Fan (none or 1)				
At 230VAC	At 460VAC		AC Input Voltage	Rated Current (A)	Max. Air Flow Noise Level		
7P0	4P1	131	(no fan)				
9P0	6P0						
012	010						
020	014						
–	019						
029	027	186	(Internal power supply)				
038	035	254				80 m <sup>3</sup> /h 37 dB(A)	
055	045						
–	052						
073	073	408				160 m <sup>3</sup> /h 45 dB(A)	
093	086	476					
110	–	553					
–	100						
–	129						

(1) See the Standard Drive Catalog Number Explanation on page 13, positions 8...10, for the Hp, armature amp, and field amp ratings that correspond to each drive current rating code listed in this table.



**Table 46 - Frame B Drives Watts Loss and Fan Capacity**

Drive			Total Value for All Fans (2)						
Current Rating Code <sup>(1)</sup>	AC Input Voltage	Total Watts Loss	AC Input Voltage	Rated Current	Max Air Flow Noise Level				
146	230	781	(Internal power supply)		340 m <sup>3</sup> /h 48 dB(A)				
180		939							
218		1038							
265		1693							
360									
434		720 m <sup>3</sup> /h 53 dB(A)							
167	460	781			(Internal power supply)		340 m <sup>3</sup> /h 48 dB(A)		
207		939							
250		1038							
330		1248							
412		1693							
067	575	400					(Internal power supply)		720 m <sup>3</sup> /h 53 dB(A)
101		553							
135		700							
270		1038							
405		1693							
									340 m <sup>3</sup> /h 48 dB(A)
									720 m <sup>3</sup> /h 53 dB(A)

(1) See the Standard Drive Catalog Number Explanation on page 13, positions 8...10, for the Hp, armature amp, and field amp ratings that correspond to each drive current rating code listed in this table.

**Table 47 - Frame C Drives Watts Loss and Fan Capacity**

Drive			Total Value for All Fans (3) <sup>(2)</sup>		
Current Rating Code <sup>(1)</sup>	AC Input Voltage	Total Watts Loss	AC Input Voltage	Rated Current (A)	Max Air Flow Noise Level
521	230	2143	230	0.75	1050 m <sup>3</sup> /h 62.5 dB(A)
700		2700			
495	460	2143			
667		2590			
540	575	2300			
675		2620			
452	690	1700			
565		2300			

(1) See the Standard Drive Catalog Number Explanation on page 13, positions 8...10, for the Hp, armature amp, and field amp ratings that correspond to each drive current rating code listed in this table.

(2) Fans on frames C drives require an external 230 V AC, 50/60 Hz power supply, which is connected to terminals U3 and V3.

**Table 48 - Frame D Drives Watts Loss and Series A Fan Capacity**

Drive			Total Values for Fan <sup>(2)</sup>		
Current Rating Code <sup>(1)</sup>	AC Input Voltage	Total Watts Loss	AC Input Voltage	Rated Current (A)	Max Air Flow Noise Level
875	230	2694	230	2.4A@50Hz and 3.3A@60Hz	2400 m <sup>3</sup> /h 80 dB(A)
1K0		3284			
830	480	3200			
996R		3568			
1K1		4189			
1K3		5229			
1K4		5117			
810	575	3122			
1K0		3819			
1K2		4679			
1K3		4879			
1K6		5720			
678	690	3174			
791		3582			
904		4028			
1K0		4064			
1K1		4509			
1K2		5368			
1K4		5543			
1K5		5886			

- (1) See the Standard Drive Catalog Number Explanation on page 13, positions 8...10, for the Hp, armature amp, and field amp ratings that correspond to each drive current rating code listed in this table.
- (2) Fans on frames D drives require an external 230 V AC, 50/60 Hz power supply, which is connected to terminals U3 and V3.

**Table 49 - Frame D Drives Watts Loss and Series B Fan Capacity**

Drive			Total Values for Fan <sup>(2)</sup>		
Current Rating Code <sup>(1)</sup>	AC Input Voltage	Total Watts Loss	AC Input Voltage	Rated Current (A)	Max. Air Flow Noise Level
875	230	2694	Three-phase 400V AC 50 Hz Or 460V AC 60 Hz	1.15 A @ 50 Hz and 1.4 A @ 60 Hz	2,400 m <sup>3</sup> /h @ 400VAC 50 Hz 2,800 m <sup>3</sup> /h @ 460VAC 60 Hz 83 dB(A) @ 400VAC 50 Hz 2,000 m <sup>3</sup> /h 86 dB(A) @ 460VAC 60 Hz 2,000 m <sup>3</sup> /h
1K0		3284			
830	480	3200			
996		3568			
1K1		4189			
1K3		5229			
1K4		5117			
810	575	3122			
1K0		3819			
1K2		4679			
1K3		4879			
1K6		5720			
678	690	3174			
791		3582			
904		4028			
1K0		4064			
1K1		4509			
1K2		5368			
1K4		5543			
1K5		5886			

(1) See the Standard Drive Catalog Number Explanation on page 13, positions 8...10, for the Hp, armature amp, and field amp ratings that correspond to each drive current rating code listed in this table.

(2) Fans on frames D drives require an external three-phase 400/460V AC, 50/60 Hz power supply, which is connected to terminals U3, V3, and W3.

**Table 50 - Frame D Drives Watts Loss and Series C Fan Capacity**

Drive			Total Values for Fan <sup>(2)</sup>		
Current Rating Code <sup>(1)</sup>	AC Input Voltage	Total Watts Loss	AC Input Voltage	Rated Current (A)	Max. Air Flow Noise Level
875	230	2694	Three-phase 400V AC 50 Hz Or 460V AC 60 Hz	1.25 A @ 50 Hz and 1.55 A @ 60 Hz	2,900 m <sup>3</sup> /h @ 400VAC 50 Hz 3,400 m <sup>3</sup> /h @460VAC 60 Hz 84 dB(A) @ 400VAC 50 Hz 90 dB(A) @ 460VAC 60 Hz
1K0		3284			
830	480	3200			
996		3568			
1K1		4189			
1K3		5229			
1K4		5117			
810		575			
1K0	3819				
1K2	4679				
1K3	4879				
1K6	5720				
678	690				
791		3582			
904		4028			
1K0		4064			
1K1		4509			
1K2		5368			
1K4		5543			
1K5		5886			

- (1) See the Standard Drive Catalog Number Explanation on page 13, positions 8...10, for the Hp, armature amp, and field amp ratings that correspond to each drive current rating code listed in this table.
- (2) Fans on frames D drives require an external three-phase 400/460V AC, 50/60 Hz power supply, which is connected to terminals U3, V3, and W3.

## Communication Configurations

## Typical Programmable-Controller Configurations

**IMPORTANT** If block transfers are programmed to write information continuously to the drive, care must be taken to format the block transfer properly. If attribute 10 is selected for the block transfer, values are written only to RAM and are not saved in the drive. This method is the preferred attribute for continuous transfers. If attribute 9 is selected, each program scan completes a write to the drives non-volatile memory (EEPROM). Because the EEPROM has a fixed number of allowed writes, continuous block transfers can quickly damage the EEPROM. Do Not assign attribute 9 to continuous block transfers. See the appropriate User Manual for your communication adapter for additional details.

## Logic Command/Status Words

See parameter [1328](#) [Drive Logic Rslt] for more information.

**Figure 66 - Logic Command Word**

Logic Bits														Command	Description		
1	1	1	1	1	1	9	8	7	6	5	4	3	2			1	0
5	4	3	2	1	0												
														x	Stop <sup>(1)</sup>	0 = Not Stop 1 = Stop	
															x	Start <sup>(1)(2)</sup>	0 = Not Start 1 = Start
															x	Jog	0 = Not Jog 1 = Jog
															x	Clear Faults	0 = Not Clear Faults 1 = Clear Faults
											x	x				Direction	00 = No Command 01 = Forward Command 10 = Reverse Command 11 = Hold Present Direction
											x					Local Control	0 = No Local Control 1 = Local Control
											x					MOP Increment	0 = Not Increment 1 = Increment
											x	x				Accel Rate	00 = No Command 01 = Use Accel Time 1 10 = Use Accel Time 2 11 = Use Present Time
															x	Decel Rate	00 = No Command 01 = Use Decel Time 1 10 = Use Decel Time 2 11 = Use Present Time
															x	Reference Select <sup>(3)</sup>	000 = No Command 001 = Ref. 1 (Spd Ref A) 010 = Ref. 2 (Spd Ref B) 011 = Ref. 3 (Preset Spd 3) 100 = Ref. 4 (Preset Spd 4) 101 = Ref. 5 (Preset Spd 5) 110 = Ref. 6 (Preset Spd 6) 111 = Ref. 7 (Preset Spd 7)
															x	MOP Decrement	0 = Not Decrement 1 = Decrement

- (1) A "0 = Not Stop" condition (logic 0) must first be present before a "1 = Start" condition starts the drive. The Start command acts as a momentary Start command. A "1" starts the drive, but returning to "0" **does not** stop the drive.
- (2) This Start does not function when a digital input (parameters 133...144) is programmed for 2-Wire Control (option 5 "Run", 6 "Run Forward" or 7 "Run Reverse").
- (3) This Reference Select does not function when a digital input (parameters 133...144) is programmed for "Speed Sel 1, 2 or 3" (option 17, 18 or 19). Note that Reference Selection is "Exclusive Ownership". See [Reference Owner] on page [192](#).

**Figure 67 - Logic Status Word**

Logic Bits																Status	Description	
15	14	13	12	11	10	9	8	7	6	5	4	3	2	1	0			
															x	Ready	0 = Not Ready 1 = Ready	
															x	Active	0 = Not Active 1 = Active	
															x	Command Direction	0 = Reverse 1 = Forward	
															x	Actual Direction	0 = Reverse 1 = Forward	
															x	Accel	0 = Not Accelerating 1 = Accelerating	
															x	Decel	0 = Not Decelerating 1 = Decelerating	
															x	Alarm	0 = No Alarm 1 = Alarm	
															x	Fault	0 = No Fault 1 = Fault	
															x	At Speed	0 = Not At Reference 1 = At Reference	
																	Local Control <sup>(1)</sup>	000 = Port 0 (TB) 001 = Port 1 010 = Port 2 011 = Port 3 100 = Port 4 101 = Port 5 110 = Reserved 111 = No Local
x	x	x	x														Reference Source	0000 = Spd Ref A Auto 0001 = Spd Ref B Auto 0010 = Preset Spd 2 Auto 0011 = Preset Spd 3 Auto 0100 = Preset Spd 4 Auto 0101 = Preset Spd 5 Auto 0110 = Preset Spd 6 Auto 0111 = Preset Spd 7 Auto 1000 = Term Blk Manual 1001 = DPI 1 Manual 1010 = DPI 2 Manual 1011 = DPI 3 Manual 1100 = DPI 4 Manual 1101 = DPI 5 Manual 1110 = Reserved 1111 = Jog Ref

(1) See Masks & Owners on page 191 for further information.

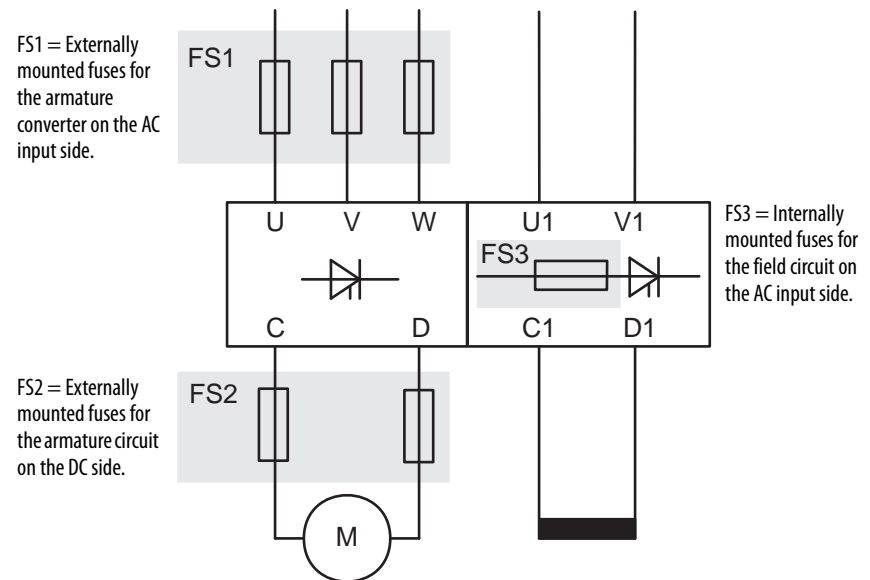
## Drive Power Circuit Protection

The tables on the following pages provide the fuses that are required for protecting the armature and field circuits of the drive. Externally mounted fuses (as indicated in [Figure 68](#)) must be sourced separately when installing the drive. Internally mounted fuses (as indicated in [Figure 68](#) and [Figure 71](#) on page [251](#)) are provided with the drive.

See page [251](#) for frames C and D fuse information.

### Frame A and B Fuse Information

**Figure 68 - Frame A and B Fuse Table Designations**



*Frame A and B AC Input Line Fuses*

AC input line fuses are externally mounted for frame A and B drives and must be sourced separately. See Fuse Code FS1 in [Figure 68](#) on page [243](#).

**Table 51 - 230V AC Input Drives**

Frame	Drive Current Rating Code	DC Amps	AC Line Amps	Bussmann		Mersen	
				Ferrule FWP Type	North American FWP Type	Ferrule A70QS Type	North American A70P / A70QS Type
A	7P0	7	5.7	FWP-10A14F	FWP-10B	A70QS10-14F	A70P10-4
	9P0	9	7.4	FWP-15A14F	FWP-15B	A70QS16-14F	A70P15-4
	012	12	9.8	FWP-20A14F	FWP-20B	A70QS20-14F	A70P20-4
	020	20	16	FWP-25A14F	FWP-25B	A70QS25-14F	A70P25-4
	029	29	24	FWP-40A22F	FWP-40B	A70QS40-22F	A70QS40-4
	038	38	31	FWP-63A22F	FWP-60B	A70QS63-22F	A70QS60-4
	055	55	45	FWP-80A22F	FWP-80B	A70QS80-22F	A70QS80-4
	073	73	60	–	FWP-100A	–	A70QS100-4K
	093	93	76	–	FWP-150A	–	A70QS150-4K
	110	110	90	–	FWP-175A	–	A70QS175-4K
B	146	146	119	–	FWP-250A	–	A70QS250-4
	180	180	147	–	FWP-300A	–	A70QS300-4
	218	218	178	–	FWP-350A	–	A70QS350-4
	265	265	217	–	FWP-400A	–	A70QS400-4
	360	360	294	–	FWP-600A	–	A70QS600-4K
	434	434	355	–	FWP-600A	–	A70QS600-4



**Table 52 - 460V AC Input Drives**

Frame	Drive Current Rating Code	DC Amps	AC Line Amps	Bussmann		Mersen	
				Ferrule FWP Type	North American FWP Type	Ferrule A70QS Type	North American A70P / A70QS Type
A	4P1	4.1	3.3	FWP-10A14F	FWP-10B	A70QS10-14F	A70P10-4
	6P0	6	4.9	FWP-10A14F	FWP-10B	A70QS10-14F	A70P10-4
	010	10	8.2	FWP-20A14F	FWP-20B	A70QS20-14F	A70P25-4
	014	14	11.4	FWP-25A14F	FWP-25B	A70QS25-14F	A70P25-4
	019	19	15.5	FWP-25A14F	FWP-25B	A70QS25-14F	A70P25-4
	027	27	22.1	FWP-40A22F	FWP-40B	A70QS40-22F	A70QS40-4
	035	35	28.6	FWP-63A22F	FWP-60B	A70QS63-22F	A70QS60-4
	045	45	36.8	FWP-80A22F	FWP-80B	A70QS80-22F	A70QS80-4
	052	52	42.5	FWP-80A22F	FWP-80B	A70QS80-22F	A70QS80-4
	073	73	59.6	–	FWP-100A	–	A70QS100-4K
	086	86	70.3	–	FWP-150A	–	A70QS150-4K
	100	100	81.7	–	FWP-175A	–	A70QS175-4K
	129	129	105.4	–	FWP-175A	–	A70QS175-4K
B	167	167	136.4	–	FWP-300A	–	A70QS300-4
	207	207	169.1	–	FWP-350A	–	A70QS350-4
	250	250	204.3	–	FWP-400A	–	A70QS400-4
	330	330	269.6	–	FWP-600A	–	A70QS600-4K
	412	412	336.6	–	FWP-600A	–	A70QS600-4

**Table 53 - 575V AC Input Drives**

Frame	Drive Current Rating Code	DC Amps	AC Line Amps	Bussmann	Mersen
				North American FWP Type	North American A70QS Type
B	067	67.5	55.1	FWP-100A	A70QS100-4
	101	101.3	82.7	FWP-175A	A70QS175-4K
	135	135	110.3	FWP-225A	A70QS225-4
	270	270	220.6	FWP-450A	A70QS450-4
	405	405	330.9	FWP-600A	A70QS600-4K

Frame A and B Armature DC Output Fuses

Armature DC output fuses are externally mounted for frame A and B drives and must be sourced separately. These fuses are required on four quadrant drives only, but highly recommended on two quadrant drives. See Fuse Code FS2 in [Figure 68](#) on page [243](#).

**Table 54 - 230V AC Input Drives**

Frame	Drive Current Rating Code	DC Amps	AC Line Amps	Bussmann		Mersen	
				Ferrule FWP Type	North American FWP Type	Ferrule A70QS Type	North American A70P / A70QS Type
A	7P0	7	5.7	FWP-15A14F	FWP-15B	A70QS16-14F	A70P15-4
	9P0	9	7.4	FWP-20A14F	FWP-20B	A70QS20-14F	A70P20-4
	012	12	9.8	FWP-25A14F	FWP-25B	A70QS25-14F	A70P25-4
	020	20	16	FWP-40A14F	FWP-40B	A70QS40-14F	A70QS40-4
	029	29	24	FWP-63A22F	FWP-60B	A70QS63-22F	A70QS60-4
	038	38	31	FWP-80A22F	FWP-80B	A70QS80-22F	A70QS80-4
	055	55	45	–	FWP-125A	–	A70QS125-4K
	073	73	60	–	FWP-150A	–	A70QS150-4K
	093	93	76	–	FWP-200A	–	A70QS200-4K
	110	110	90	–	FWP-225A	–	A70QS250-4
B	146	146	119	–	FWP-300A	–	A70QS300-4
	180	180	147	–	FWP-350A	–	A70QS350-4
	218	218	178	–	FWP-450A	–	A70QS450-4
	265	265	217	–	FWP-600A	–	A70QS600-4K
	360	360	294	–	FWP-700A	–	A70QS700-4
	434	434	355	–	FWP-900A	–	A70P900-4

**Table 55 - 460V AC Input Drives**

Frame	Drive Current Rating Code	DC Amps	AC Line Amps	Bussmann		Mersen	
				Ferrule FWP Type	North American FWP Type	Ferrule A70QS Type	North American A70P / A70QS Type
A	4P1	4.1	3.3	FWP-10A14F	FWP-10B	A70QS10-14F	A70P10-4
	6P0	6	4.9	FWP-15A14F	FWP-15B	A70QS16-14F	A70P15-4
	010	10	8.2	FWP-20A14F	FWP-20B	A70QS20-14F	A70P20-4
	014	14	11.4	FWP-30A14F	FWP-30B	A70QS32-14F	A70P30-4
	019	19	15.5	FWP-40A14F	FWP-40B	A70QS40-14F	A70QS40-4
	027	27	22.1	FWP-63A22F	FWP-60B	A70QS63-22F	A70QS60-4
	035	35	28.6	FWP-80A22F	FWP-70B	A70QS80-22F	A70QS70-4
	045	45	36.8	FWP-100A22F	FWP-90B	–	A70QS90-4
	052	52	42.5	FWP-100A22F	FWP-100B	–	A70QS100-4
	073	73	59.6	–	FWP-150A	–	A70QS150-4K
	086	86	70.3	–	FWP-175A	–	A70QS175-4K
	100	100	81.7	–	FWP-200A	–	A70QS200-4K
	129	129	105.4	–	FWP-250A	–	A70QS250-4
B	167	167	136.4	–	FWP-350A	–	A70QS350-4
	207	207	169.1	–	FWP-400A	–	A70QS400-4
	250	250	204.3	–	FWP-500A	–	A70QS500-4K
	330	330	269.6	–	FWP-700A	–	A70QS700-4
	412	412	336.6	–	FWP-800A	–	A70QS800-4

**Table 56 - 575V AC Input Drives**

Frame	Drive Current Rating Code	DC Amps	AC Line Amps	Bussmann	Mersen
				North American FWP Type	North American A70P / A70QS Type
B	067	67.5	55.1	FWP-125A	A70QS125-4K
	101	101.3	82.7	FWP-200A	A70QS200-4K
	135	135	110.3	FWP-250A	A70QS250-4
	270	270	220.6	FWP-600A	A70QS600-4K
	405	405	330.9	FWP-800A	A70QS800-4

Frame A and B Field Circuit Fuses

Field circuit fuses are internally mounted and provided with the drive. See Fuse Code FS3 in [Figure 68](#) on page 243. Also, see [Figure 69](#) on page 250 and [Figure 69](#) on page 250 for fuse locations.

**Table 57 - 230V AC Input Drives**

Frame	Drive Current Rating Code	Field Amps	Type	Quantity	Bussmann	Mersen	SIBA
A	7P0	10	6 x 32 mm	2	FWH-016A6F	E085449	70 125 40.16
	9P0						
	012						
	020						
	029						
	038						
	055						
	073	14					
	093						
	110						
B	146	20	10 x 38 mm	2	FWC-25A10F	A60Q25-2	60 033 05.25
	180						
	218						
	265						
	360						
	434						

**Table 58 - 460V AC Input Drives**

Frame	Drive Current Rating Code	Field Amps	Type	Quantity	Bussmann	Mersen	SIBA	
A	4P1	10	6 x 32 mm	2	FWH-016A6F	E085449	70 125 40.16	
	6P0							
	010							
	014							
	019							
	027							
	035							
	045							
	052							
	073							
	B	086	14	10 x 38 mm	2	FWC-25A10F	A60Q25-2	60 033 05.25
		100						
		129						
167								
207								
B	250	20	10 x 38 mm	2	FWC-25A10F	A60Q25-2	60 033 05.25	
	330							
	412							

**Table 59 - 575V AC Input Drives**

Frame	Drive Current Rating Code	Field Amps	Quantity	Type	Bussmann	Mersen	SIBA
B	067	20	2	10 x 38 mm	FWC-25A10F	A60Q25-2	60 033 05.25
	101						
	135						
	270						
	405						

Figure 69 - Frame A Field Circuit Fuses Location

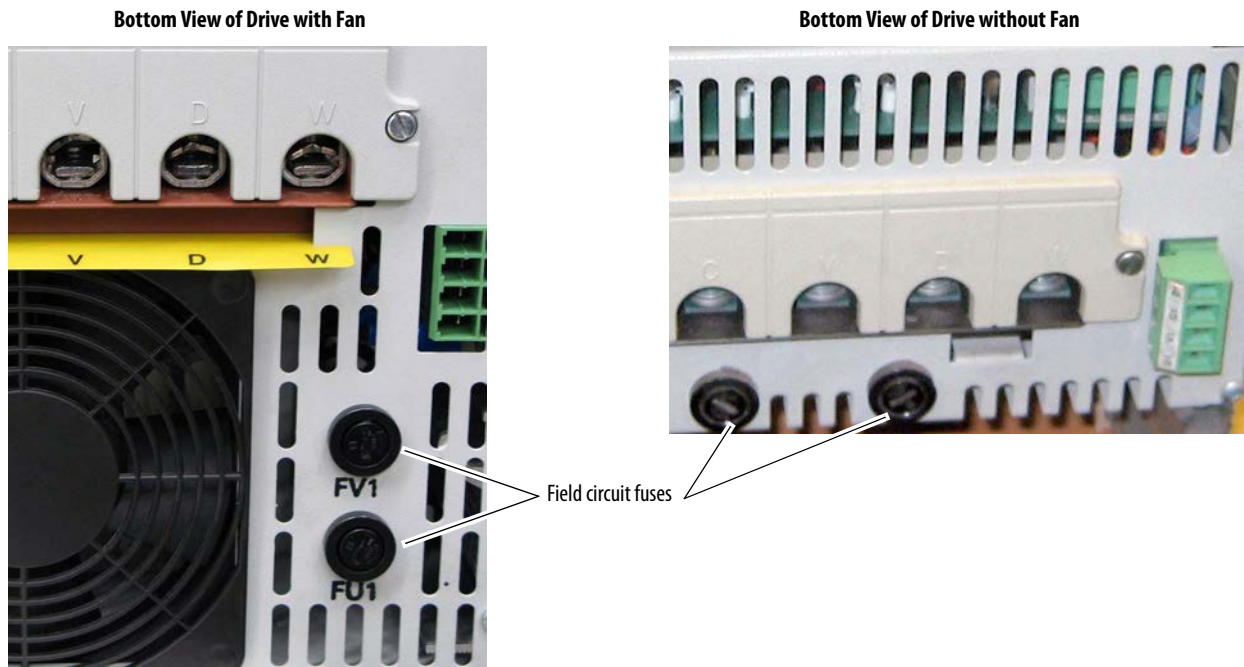
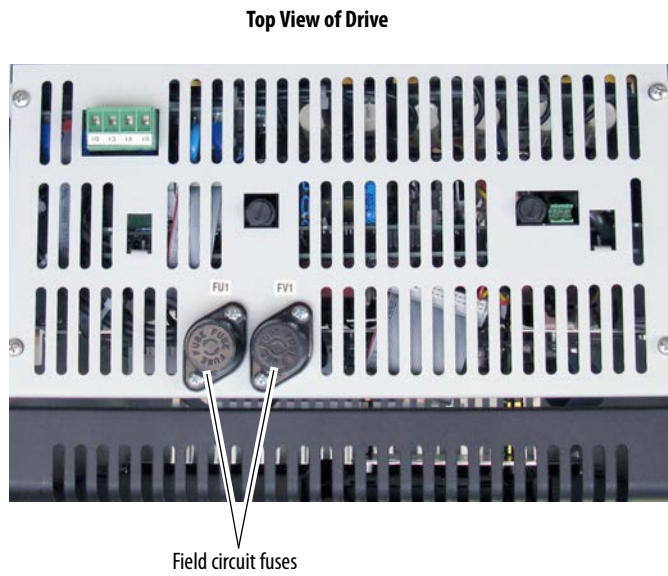


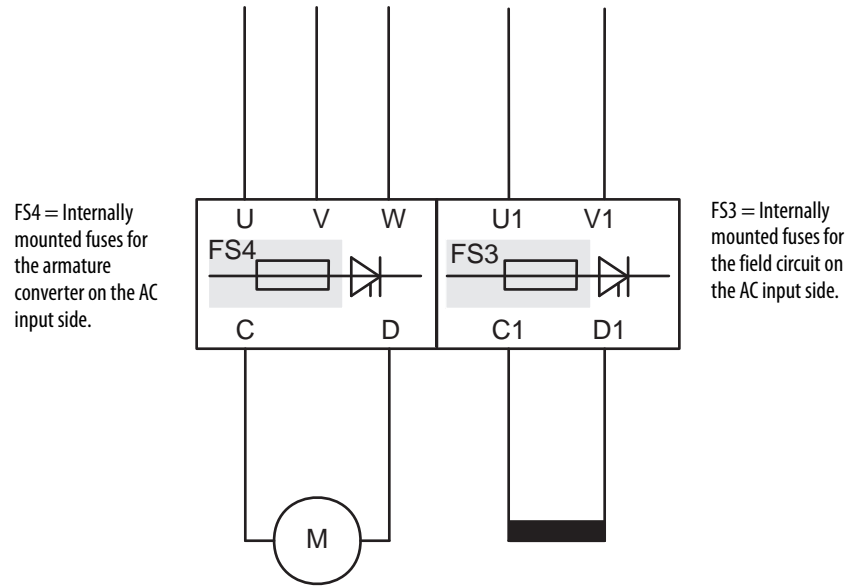
Figure 70 - Frame B Field Circuit Fuses Location



## Frame C and D Fuse Information

All fuses for armature and field circuit protection are internally mounted and provided with frame C and D drives.

**Figure 71 - Frame C and D Fuse Table Designations**



### Frame C and D Field Circuit Fuses

Field circuit fuses for frames C and D drives are internally mounted (labeled FU1 and FV1) and provided with the drive. See Fuse Code FS3 in [Figure 71](#). Also, see [Figure 72](#) on page 253 and [Figure 73](#) on page 253 for locations.

**Table 60 - 230V AC Input Drives**

Frame	Drive Current Rating Code	Field Amps	Type	Qty	Bussmann	Mersen	SIBA
C	521	20	10 x 38 mm	2	FWC-25A10F	A60Q25-2	6003305.25
D	875 1K0	40	22 x 58 mm		FWP-50A22F	A70QS50-22F	5014006.50

**Table 61 - 460V AC Input Drives**

Frame	Drive Current Rating Code	Field Amps	Type	Qty	Bussmann	Mersen	SIBA
C	495	20	10 x 38 mm	2	FWC-25A10F	A60Q25-2	6003305.25
	667					A60Q25-8	
D	830	40	22 x 58 mm	2	FWP-50A22F	A70Q550-22F	5014006.50
	996						
	1K1	70			FWP-100A22F	A70QS100-22F	5014006.100
	1K3						
	1K4						

**Table 62 - 575V AC Input Drives**

Frame	Drive Current Rating Code	Field Amps	Type	Qty	Bussmann	Mersen	SIBA
C	540	20	10 x 38 mm	2	FWC-25A10F	A60Q25-2	6003305.25
	675					A60Q25-8	
D	810	40	22 x 58 mm	2	FWP-50A22F	A70Q550-22F	5014006.50
	1K0						
	1K2						
	1K3						
	1K6	70			FWP-100A22F	A70QS100-22F	5014006.100

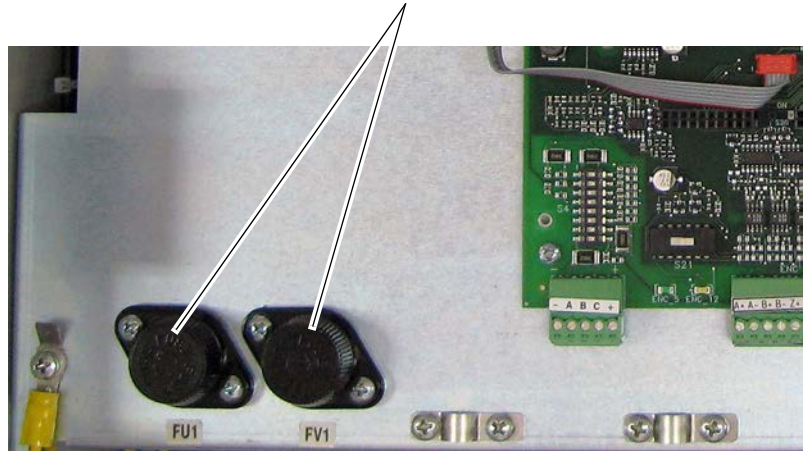
**Table 63 - 690V AC Input Drives**

Frame	Drive Current Rating Code	Field Amps	Type	Qty	Bussmann	Mersen	SIBA
C	452	20	10 x 38 mm	2	FWC-25A10F	A60Q25-2	6003305.25
	565					A60Q25-8	
D	678	40	22 x 58 mm	2	FWP-50A22F	A70Q550-22F	5014006.50
	791						
	904						
	1K0						
	1K1	70			FWP-100A22F	A70QS100-22F	5014006.100
	1K2						
	1K4						
1K5							



**Figure 72 - Frame C Field Circuit Fuse Location**

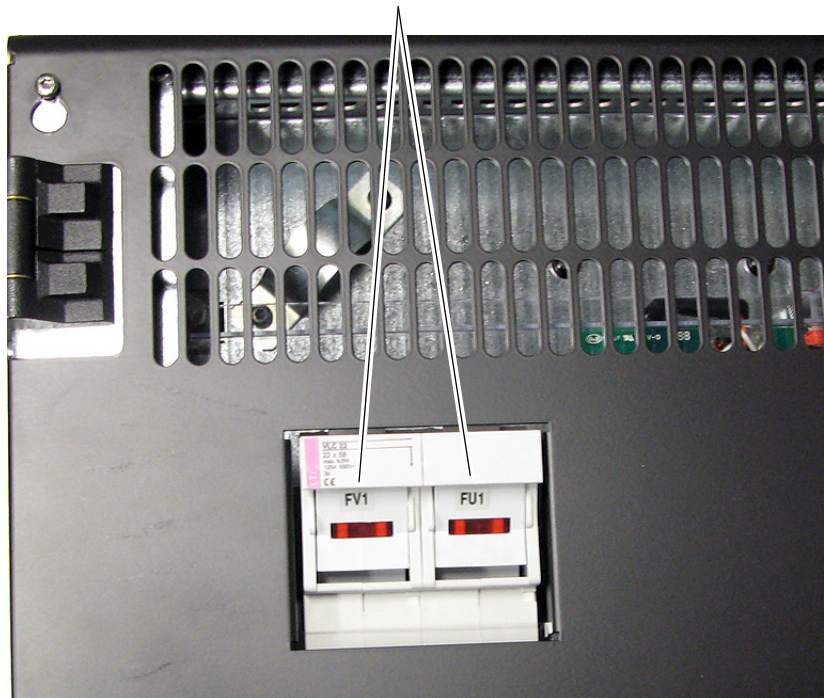
Field circuit fuses are on the control board EMI shield next to the control board.



Drive shown with front covers removed.

**Figure 73 - Frame D Field Circuit Fuse Location**

Top, left side of drive control panel.



*Fuses for Regenerative Frame C and D Drives*

Leg fuses are internally mounted and provided with frames C and D drives. See Fuse Code FS4 in [Figure 71](#) on page 251. Also, see [Figure 74](#) on page 256 and [Figure 75](#) on page 256 for fuse locations.

**Table 64 - Leg Fuses - 230V AC Input Frame C Drives**

Frame	Drive Current Rating Code	DC Amps	AC Line Amps	Qty	Bussmann	Mersen	SIBA
					Square Body - Flush End Contact		
C	521	521	426	6	170M5464 + switch 170H0069	6,9 URD 32 TTF 800 + switch MS 3-V1-5 BS	20 671 32.800 + switch 28 001 04
	700	700	571	6	170M5464 + switch 170H0069	6,9 URD 32 TTF 800 + switch MS 3V 1-5 BS	20 671 32.800 + switch 28 001 04

**Table 65 - Leg Fuses - 230V AC Input Frame D Drives**

Frame	Drive Current Rating Code	DC Amps	AC Line Amps	Qty	Bussmann	Mersen	SIBA
					Square Body - DIN 43653 Stud-Mount		
D	875	875	715	6	170M6263 + switch 170H0069	Y300263 + switch MS 3V 1-5 UR	20 635 32.900 + switch 28 001 04
	1K0	1050	858	6	170M6264 + switch 170H0069	Z300264 + switch MS 3V 1-5 UR	20 635 32.1000 + switch 28 001 04

**Table 66 - Leg Fuses - 460V AC Input Frame C Drives**

Frame	Drive Current Rating Code	DC Amps	AC Line Amps	Qty	Bussmann	Mersen	SIBA
					Square Body - Flush End Contact		
C	495	495	404.4	6	170M5462 + switch 170H0069	6,9 URD 32 TTF 630 + switch MS 3-V1-5 BS	20 671 32.630 + switch 28 001 04
	667	667	544.9	6	170M5464 + switch 170H0069	6,9 URD 32 TTF 800 + switch MS 3-V1-5 BS	20 671 32.800 + switch 28 001 04

**Table 67 - Leg Fuses - 460V AC Input Frame D Drives**

Frame	Drive Current Rating Code	DC Amps	AC Line Amps	Qty	Bussmann	Mersen	SIBA
					Square Body - DIN 43653 Stud-Mount		
D	830	830	678.1	6	170M6262 + switch 170H0069	X300262 + switch MS 3V 1-5 UR	20 635 32.800 + switch 28 001 04
	996	996	813.7	6	170M6264 + switch 170H0069	Z300264 + switch MS 3V 1-5 UR	20 635 32.1000 + switch 28 001 04
	1K1	1162	949.4	6	170M6265 + switch 170H0069	A300262 + switch MS 3V 1-5 UR	20 635 32.1100 + switch 28 001 04
	1K3	1328	1085.0	6	170M6266 + switch 170H0069	B300266 + switch MS 3V 1-5 UR	20 635 32.1250 + switch 28 001 04
	1K4	1494	1220.6	6	170M6267 + switch 170H0069	C300267 + switch MS 3V 1-5 UR	20 635 32.1400 + switch 28 001 04

**Table 68 - Leg Fuses - 575V AC Input Frame C Drives**

Frame	Drive Current Rating Code	DC Amps	AC Line Amps	Qty	Bussmann	Mersen	SIBA
					Square Body - Flush End Contact		
C	540	540	441	6	—	11 URD 72 TTF 0800 + switch MS 3V 1-5 BS	20 771 32.800 + switch 28 001 04
	675	675	551	6	—	11 URD 72 TTF 0800 + switch MS 3V 1-5 BS	20 771 32.800 + switch 28 001 04

**Table 69 - Leg Fuses - 575V AC Input Frame D Drives**

Frame	Drive Current Rating Code	DC Amps	AC Line Amps	Qty	Bussmann	Mersen	SIBA
					Square Body - DIN 43653 Stud-Mount		
D	810	810	661	6	170M6246 + switch 170H0069	J300572 + switch MS 3V 1-5 UR	20 735 32.800 + switch 28 001 04
	1K0	1080	881	6	170M6248 + switch 170H0069	L300574 + switch MS 3V 1-5 UR	20 735 32.1000 + switch 28 001 04
	1K2	1215	991	12	170M6244 + switch 170H0069	G300570 + switch MS 3V 1-5 UR	20 735 32.630 + switch 28 001 04
	1K3	1350	1102	12	170M6245 + switch 170H0069	H300571 + switch MS 3V 1-5 UR	20 735 32.700 + switch 28 001 04
	1K6	1688	1377	12	170M6246 + switch 170H0069	J300572 + switch MS 3V 1-5 UR	20 735 32.800 + switch 28 001 04

**Table 70 - Leg Fuses - 690V AC Input Frame C Drives**

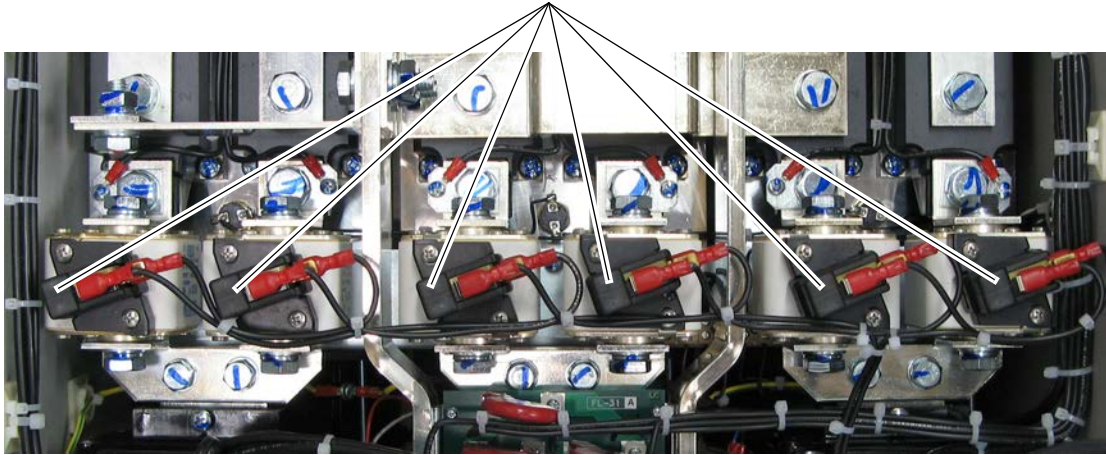
Frame	Drive Current Rating Code	DC Amps	AC Line Amps	Qty	Bussmann	Mersen	SIBA
					Square Body - Flush End Contact		
C	452	452	369	6	170M5394 + switch 170H0069	12,5 URD 72 TTF 0500 + switch MS 3V 1-5 BS	20 771 32.500 + switch 28 001 04
	565	565	461	6	—	12,5 URD 72 TTF 0630 + switch MS 3V 1-5 BS	20 771 32.630 + switch 28 001 04

**Table 71 - Leg Fuses - 690V AC Input Frame D Drives**

Frame	Drive Current Rating Code	DC Amps	AC Line Amps	Qty	Bussmann	Mersen	SIBA
					Square Body - DIN 43653 Stud-Mount		
D	678	678	553	6	170M6244 + switch 170H0069	G300570 + switch MS 3V 1-5 UR	20 735 32.630 + switch 28 001 04
	791	791	645	6	170M6246 + switch 170H0069	J300572 + switch MS 3V 1-5 UR	20 735 32.800 + switch 28 001 04
	904	904	738	6	170M6247 + switch 170H0069	K300573 + switch MS 3V 1-5 UR	20 735 32.900 + switch 28 001 04
	1K0	1017	830	6	170M6248 + switch 170H0069	L300574 + switch MS 3V 1-5 UR	20 735 32.1000 + switch 28 001 04
	1K1	1130	922	12	170M6244 + switch 170H0069	G300570 + switch MS 3V 1-5 UR	20 735 32.630 + switch 28 001 04
	1K2	1243	1014	12	170M6244 + switch 170H0069	G300570 + switch MS 3V 1-5 UR	20 735 32.630 + switch 28 001 04
	1K4	1413	1153	12	170M6245 + switch 170H0069	H300571 + switch MS 3V 1-5 UR	20 735 32.700 + switch 28 001 04
	1K5	1582	1291	12	170M6246 + switch 170H0069	J300572 + switch MS 3V 1-5 UR	20 735 32.800 + switch 28 001 04

**Figure 74 - Frame C Regenerative Drive - Leg Fuse Location**

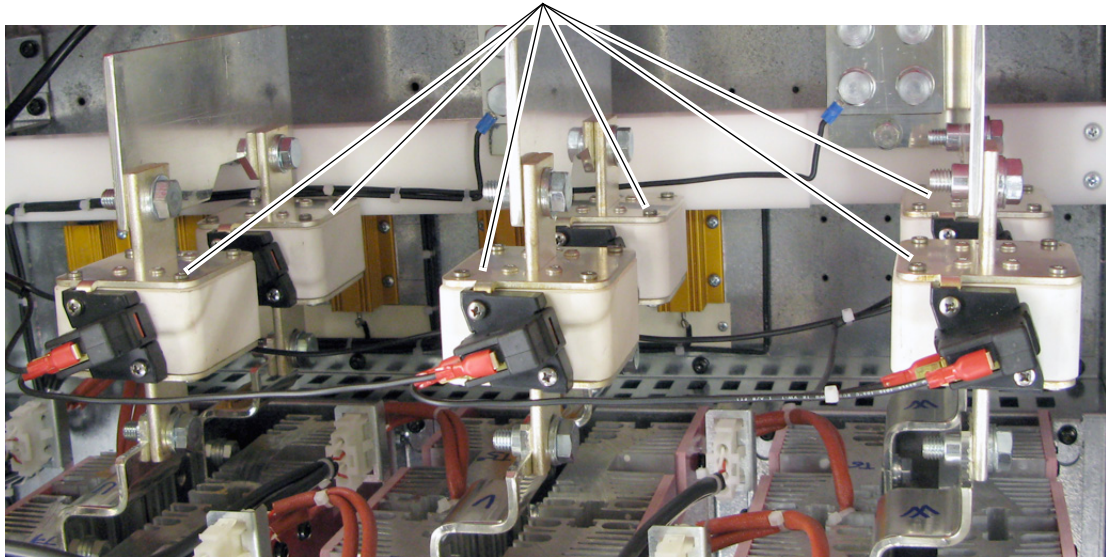
Leg fuses and switches are installed on the bus bars behind the control board EMI shield.



Drive shown with front covers removed and control board EMI shield lowered.

**Figure 75 - Frame D Regenerative Drive - Leg Fuse Location**

Leg fuses and switches are installed on the bus bars behind the control panel, which holds the circuit boards.



*Fuses for Non-Regenerative Frame C and D Drives*

AC input line and/or leg fuses are internally mounted and provided with frames C and D drives. See Fuse Code FS4 in [Figure 71](#) on page 251. Also, see [Figure 76](#) on page 258 for fuse locations.

**Table 72 - AC Input Line Fuses - 230V AC Input Frame C Drives**

Frame	Drive Current Rating Code	DC Amps	AC Line Amps	Qty	Bussmann	Mersen	SIBA
					Square Body - Flush End Contact		
C	521	521	426	3	170M5466 + switch 170H0069	6,9 URD 32 TTF 1000 + switch MS 3-V1-5 BS	20 671 32.1000 + switch 28 001 04
	700	700	571	3	170M5466 + switch 170H0069	6,9 URD 32 TTF 1000 + switch MS 3V 1-5 BS	20 671 32.1000 + switch 28 001 04

**Table 73 - Leg Fuses - 230V AC Input Frame D Drives**

Frame	Drive Current Rating Code	DC Amps	AC Line Amps	Qty	Bussmann	Mersen	SIBA
					Square Body - DIN 43653 Stud-Mount		
D	875	875	715	6	170M6263 + switch 170H0069	Y300263 + switch MS 3V 1-5 UR	20 635 32.900 + switch 28 001 04
	1K0	1050	858	6	170M6264 + switch 170H0069	Z300264 + switch MS 3V 1-5 UR	20 635 32.1000 + switch 28 001 04

**Table 74 - AC Input Line Fuses - 460V AC Input Frame C Drives**

Frame	Drive Current Rating Code	DC Amps	AC Line Amps	Qty	Bussmann	Mersen	SIBA
					Square Body - Flush End Contact		
C	495	495	404.4	3	170M5464 + switch 170H0069	6,9 URD 32 TTF 800 + switch MS 3-V1-5 BS	20 671 32.800 + switch 28 001 04
	667	667	544.9	3	170M5466 + switch 170H0069	6,9 URD 32 TTF 1000 + switch MS 3-V1-5 BS	20 671 32.1000 + switch 28 001 04

**Table 75 - Leg Fuses - 460V AC Input Frame D Drives**

Frame	Drive Current Rating Code	DC Amps	AC Line Amps	Qty	Bussmann	Mersen	SIBA
					Square Body - DIN 43653 Stud-Mount		
D	830	830	678.1	6	170M6262 + switch 170H0069	X300262 + switch MS 3V 1-5 UR	20 635 32.800 + switch 28 001 04
	996	996	813.7	6	170M6264 + switch 170H0069	Z300264 + switch MS 3V 1-5 UR	20 635 32.1000 + switch 28 001 04
	1K1	1162	949.4	6	170M6265 + switch 170H0069	A300262 + switch MS 3V 1-5 UR	20 635 32.1100 + switch 28 001 04
	1K3	1328	1085.0	6	170M6266 + switch 170H0069	B300266 + switch MS 3V 1-5 UR	20 635 32.1250 + switch 28 001 04
	1K4	1494	1220.6	6	170M6267 + switch 170H0069	C300267 + switch MS 3V 1-5 UR	20 635 32.1400 + switch 28 001 04

**Table 76 - AC Input Line Fuses - 575V AC Input Frame C Drives**

Frame	Drive Current Rating Code	DC Amps	AC Line Amps	Qty	Bussmann	Mersen	SIBA
					Square Body - Flush End Contact		
C	540	540	441	3	170M5466 + switch 170H0069	6,9 URD 32 TTF 1000 + switch MS 3V 1-5 BS	20 671 32.1000 + switch 28 001 04
	675	675	551	3	170M5466 + switch 170H0069	6,9 URD 32 TTF 1000 + switch MS 3V 1-5 BS	20 671 32.1000 + switch 28 001 04



**Table 77 - Leg Fuses - 575V AC Input Frame D Drives**

Frame	Drive Current Rating Code	DC Amps	AC Line Amps	Qty	Bussmann	Mersen	SIBA
					Square Body - DIN 43653 Stud-Mount		
D	810	810	661	6	170M6262 + switch 170H0069	X300262 + switch MS 3V 1-5 UR	20 635 32.800 + switch 28 001 04
	1K0	1080	881	6	170M6264 + switch 170H0069	Z300264 + switch MS 3V 1-5 UR	20 635 32.1000 + switch 28 001 04
	1K2	1215	991	6	170M6265 + switch 170H0069	A300262 + switch MS 3V 1-5 UR	20 635 32.1100 + switch 28 001 04
	1K3	1350	1102	6	170M6266 + switch 170H0069	B300266 + switch MS 3V 1-5 UR	20 635 32.1250 + switch 28 001 04
	1K6	1688	1377	12	170M6262 + switch 170H0069	X300262 + switch MS 3V 1-5 UR	20 635 32.800 + switch 28 001 04

**Table 78 - AC Input Line Fuses - 690V AC Input Frame C Drives**

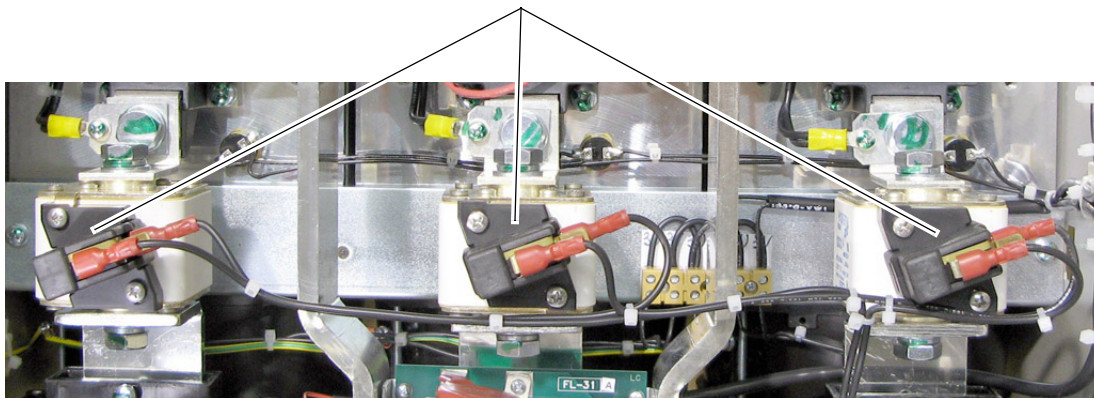
Frame	Drive Current Rating Code	DC Amps	AC Line Amps	Qty	Bussmann	Mersen	SIBA
					Square Body - Flush End Contact		
C	452	452	369	6	170M5463 + switch 170H0069	6,9 URD 32 TTF 0700 + switch MS 3V 1-5 BS	20 671 32.700 + switch 28 001 04
	565	565	461	6	170M5465 + switch 170H0069	6,9 URD 32 TTF 0900 + switch MS 3V 1-5 BS	20 671 32.900 + switch 28 001 04

**Table 79 - Leg Fuses - 690V AC Input Frame D Drives**

Frame	Drive Current Rating Code	DC Amps	AC Line Amps	Qty	Bussmann	Mersen	SIBA
					Square Body - DIN 43653 Stud-Mount		
D	678	678	553	6	170M6260 + switch 170H0069	V300260 + switch MS 3V 1-5 UR	20 635 32.630 + switch 28 001 04
	791	791	645	6	170M6262 + switch 170H0069	X300262 + switch MS 3V 1-5 UR	20 635 32.800 + switch 28 001 04
	904	904	738	6	170M6263 + switch 170H0069	Y300263 + switch MS 3V 1-5 UR	20 635 32.900 + switch 28 001 04
	1K0	1017	830	6	170M6264 + switch 170H0069	Z300264 + switch MS 3V 1-5 UR	20 635 32.1000 + switch 28 001 04
	1K1	1130	922	6	170M6265 + switch 170H0069	A300262 + switch MS 3V 1-5 UR	20 635 32.1100 + switch 28 001 04
	1K2	1243	1014	6	170M6266 + switch 170H0069	B300266 + switch MS 3V 1-5 UR	20 635 32.1250 + switch 28 001 04
	1K4	1413	1153	6	170M6267 + switch 170H0069	C300267 + switch MS 3V 1-5 UR	20 635 32.1400 + switch 28 001 04
	1K5	1582	1291	12	170M6262 + switch 170H0069	X300262 + switch MS 3V 1-5 UR	20 635 32.800 + switch 28 001 04

**Figure 76 - Frame C Non-Regenerative Drive - AC Input Line Fuse Location**

AC Input fuses and switches are installed on the bus bars behind the control board EMI shield.



Drive shown with front covers removed and control board EMI shield lowered.

## Control Power Circuit Protection Fuses

## Switching Power Supply Circuit Board Fuses

The following fuses are used to protect the switching power supply circuit.

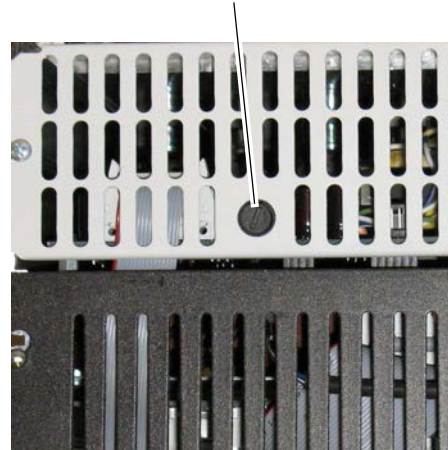
**IMPORTANT** Verify the circuit board revision before you order and install fuses.

Frame	Circuit Board ID / Revision	Designation	Fuse (5 x 20 mm)
A	SW1-31 / H and below	F1	1 A, 250V, slow
	SW1-31 / I and above	F1	2.5 A, 250V, slow
B	SW2-32 / H and below	F1	3.15 A, 250V fast
		F2	2.5 A, 250V slow
	SW2-32 / I and above	F1	2.5 A, 250V slow
		F2	
C	SW3-32 / H and below	F1	3.15 A, 250V fast
		F2	2.5 A, 250V slow
	SW3-32 / I and above	F1	2.5 A, 250V slow
		F2	
D	SW1-31 / I and above	F1	2.5 A, 250V, slow

**Figure 77 - Frame A Switching Power Supply Circuit Board Fuse Location**

Top View of Drive

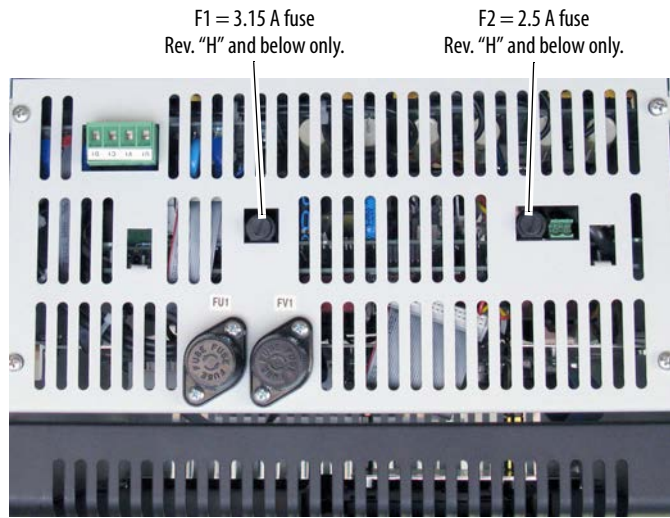
switching power supply circuit board fuse holder.



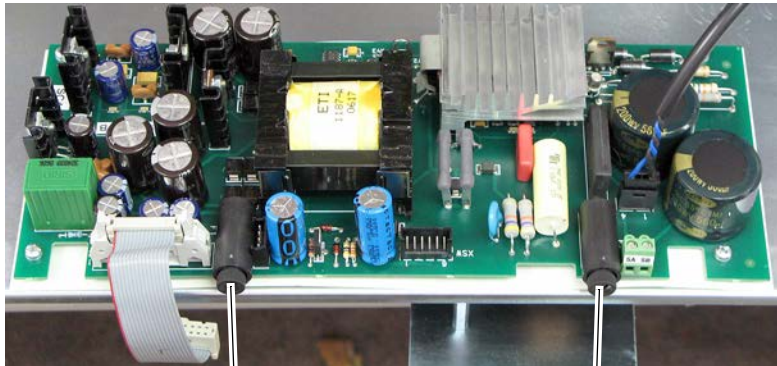
**Figure 78 - Frame B Switching Power Supply Circuit Board Fuse Location**

Top View of Drive

switching power supply circuit board fuse holders.



**Figure 79 - Frame C Switching Power Supply Circuit Board Fuse Location**



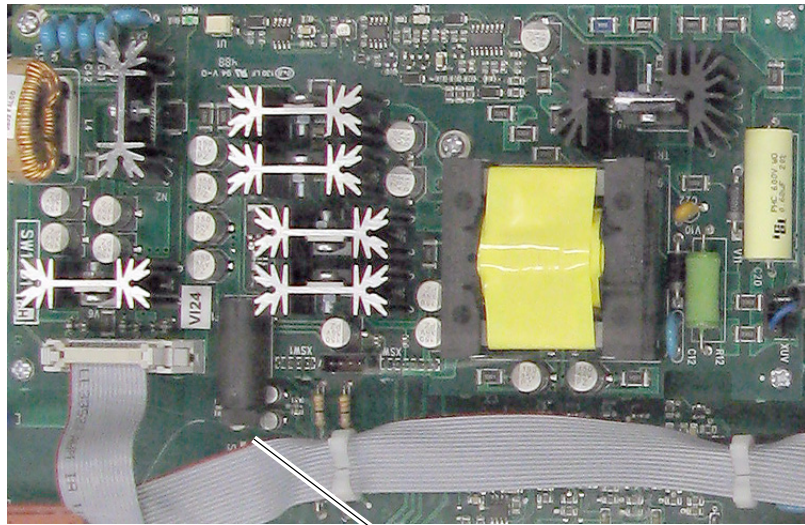
F1 = 3.15 A fuse  
Rev. "H" and below only.

F2 = 2.5 A fuse  
Rev. "H" and below only.

The switching power supply circuit board is on the back of the control board EMI shield.



**Figure 80 - Frame D Switching Power Supply Circuit Board Fuse Location**



switching power supply fuse holder

The switching power supply circuit board is on the control panel.

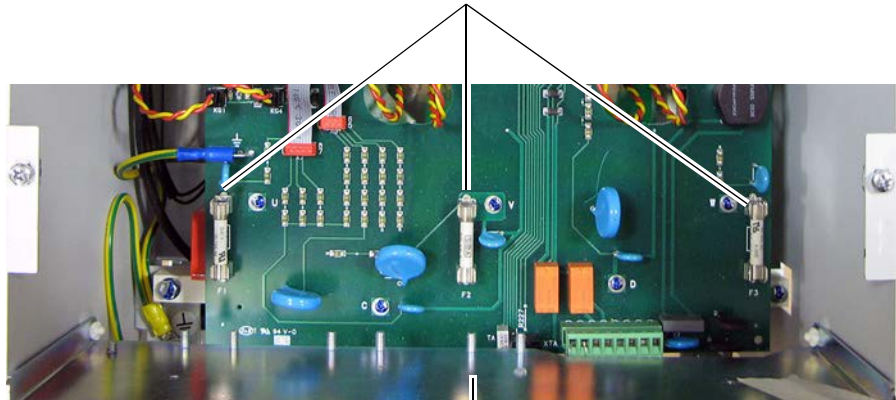
**Frame B Pulse Transformer Circuit Board Fuses**

The following fuses are used to protect the MOVs on the pulse transformer circuit board on frame B drives only.

Circuit Board ID / Revision	Designation	Fuse (6 x 32 mm)
FIR2-xx / M and earlier	F1/F2/F3	16 A, 500V fast

**Figure 81 - Frame B Pulse Transformer Circuit Board Fuse Location**

Pulse transformer board fuse locations  
(shown with control board EMI shield lowered).



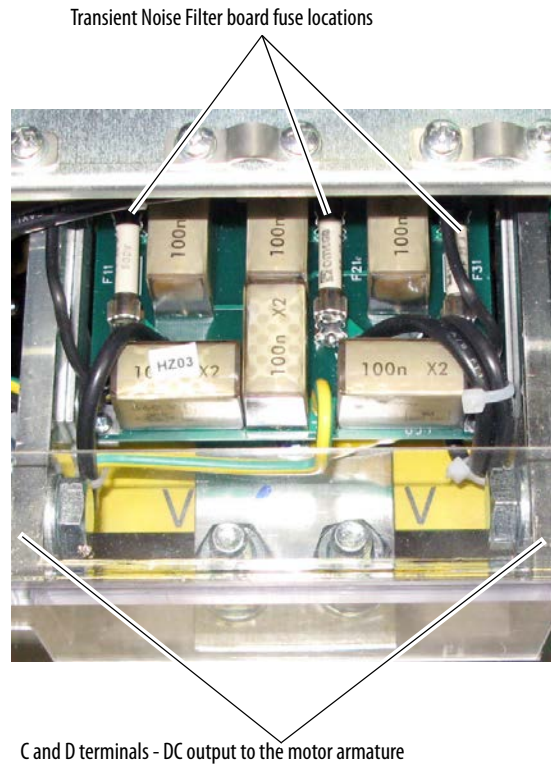
Control board EMI shield

### Frame C Transient Noise Filter Circuit Board Fuses

The following fuses are used to protect the MOVs on the Transient Noise Filter circuit board for frame C drives only.

Board ID / Revision	Designation	Fuse (6 x 32 mm)
FL-31 / All	F11/F21/F31	25 A, 500V fast

**Figure 82 - Frame C Transient Noise Filter Circuit Board Fuse Locations**



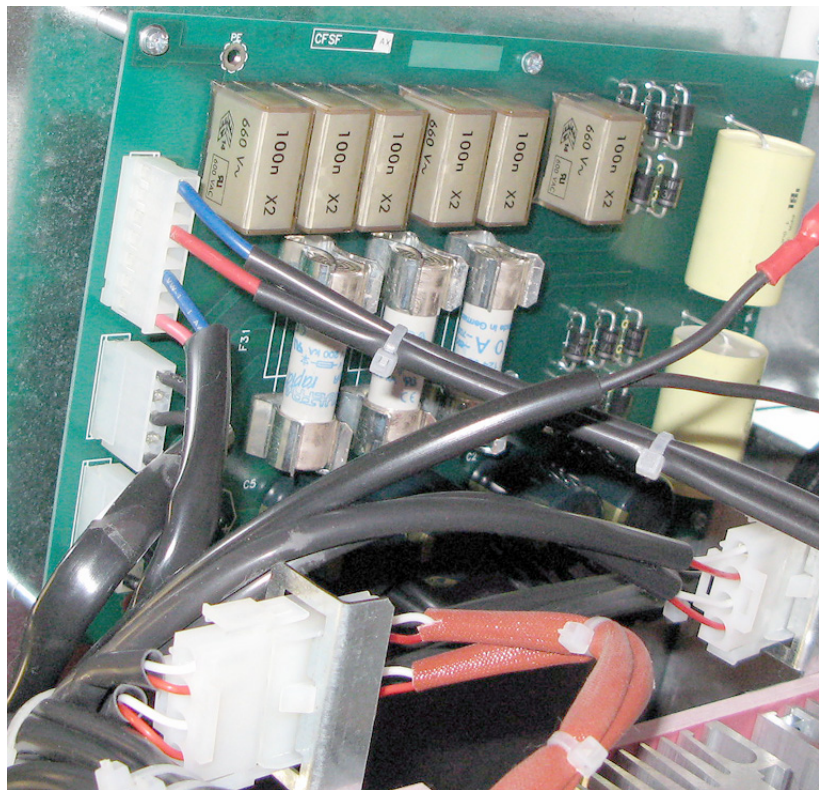
## Frame D Overvoltage Clipping Circuit Board Fuses

The following fuses are used to protect the resistors and capacitors on the overvoltage clipping circuit board for frame D drives only. The overvoltage clipping circuit board is on the left side wall inside the drive enclosure, behind the control panel.

Circuit Board ID / Revision	Designation	Fuse (14 x 51 mm)
CFSFxxx / All	F11/F21/F31	10 A, 690V fast

**Figure 83 - Frame D Overvoltage Clipping Circuit Board Fuse Locations**

Overvoltage clipping board fuse locations (shown with control panel open).



## AC Input Line Reactors and AC Input Contactors

If a DC contactor is used, an AC input contactor is not needed.

Table 80 - 230V AC Input Drives

Frame	Drive Current Rating Code	DC Amps	AC Line Amps	Hp	IP00 (Open Style) Line Reactor Cat No.	Line Reactor kW (HP)	AC Input Contactor Cat. No.
A	7P0	7	5.7	1.5	1321-3R8-A	0.75 (1)	100-C12D10
	9P0	9	7.4	2	1321-3R12-A	1.49 (2)	100-C12D10
	012	12	9.8	3	1321-3R18-A	0.75...3.7 (1...5)	100-C12D10
	020	20	16	5	1321-3R18-A	0.75...3.7 (1...5)	100-C23D10
	029	29	24	7.5	1321-3R55-A	5.5...11 (7.5...15)	100-C30D10
	038	38	31	10	1321-3R55-A	5.5...11 (7.5...15)	100-C37D10
	055	55	45	15	1321-3R55-A	5.5...11 (7.5...15)	100-C60D10
	073	73	60	20	1321-3R80-A	15 (20)	100-C60D10
	093	93	76	25	1321-3R100-A	18.5...22 (25...30)	100-C85D10
	110	110	90	30	1321-3R100-A	18.5...22 (25...30)	100-D110D11
B	146	146	119	40	1321-3R160-A	30...37 (40...50)	100-D140D11
	180	180	147	50	1321-3R160-A	30...37 (40...50)	100-D180D11
	218	218	178	60	1321-3RB250-A	45...56 (60...75)	100-D180D11
	265	265	217	75	1321-3RB250-A	45...56 (60...75)	100-D250ED11
	360	360	294	100	1321-3RB320-A	75 (100)	100-D300ED11
	434	434	355	125	1321-3RB400-A	93 (125)	100-D420ED11
C	521	521	426	150	1321-3R500-A	112 (150)	100-D630ED11
	700	700	572	200	1321-3R600-A	149 (200)	100-D630ED11
D	875	875	715	250	1321-3R750-A	186 (250)	100-D860ED11
	1K0	1050	858	300	1321-3R850-A	224 (300)	100-D860ED11

**Table 81 - 460V AC Input Drives**

Frame	Drive Current Rating Code	DC Amps	AC Line Amps	Hp	IP00 (Open Style) Line Reactor Cat No.	Line Reactor kW (HP)	AC Input Contactor Cat. No.
A	4P1	4.1	3.3	2	1321-3R4-A	0.55 (0.75)	100-C12D10
	6P0	6	4.9	3	1321-3R8-A	0.75 (1)	100-C12D10
	010	10	8.2	5	1321-3R18-B	1.5...7.5 (2...10)	100-C12D10
	014	14	11.4	7.5	1321-3R18-B	1.5...7.5 (2...10)	100-C12D10
	019	19	15.5	10	1321-3R18-B	1.5...7.5 (2...10)	100-C23D10
	027	27	22.1	15	1321-3R55-B	11...22 (15...30)	100-C23D10
	035	35	28.6	20	1321-3R55-B	11...22 (15...30)	100-C30D10
	045	45	36.8	25	1321-3R55-B	11...22 (15...30)	100-C37D10
	052	52	42.5	30	1321-3R55-B	11...22 (15...30)	100-C43D10
	073	73	59.6	40	1321-3R80-B	30 (40)	100-C60D10
	086	86	70.3	50	1321-3R100-B	37...45 (50...60)	100-C85D10
	100	100	81.7	60	1321-3R100-B	37...45 (50...60)	100-C85D10
	129	129	105.4	75	1321-3R160-B	56...75 (75...100)	100-D110D11
B	167	167	136.4	100	1321-3R160-B	56...75 (75...100)	100-D140D11
	207	207	169.1	125	1321-3RB250-B	93...112 (125...150)	100-D180D11
	250	250	204.3	150	1321-3RB250-B	93...112 (125...150)	100-D210ED11
	330	330	269.6	200	1321-3RB320-B	149 (200)	100-D300ED11
	412	412	336.6	250	1321-3RB400-B	186.4 (250)	100-D420ED11
C	495	495	404.4	300	1321-3R500-B	223.7 (300)	100-D420ED11
	667	667	544.9	400	1321-3R600-B	298.3 (400)	100-D630ED11
D	830	830	678.1	500	1321-3R750-B	372.8 (500)	100-D860ED11
	996	996	813.7	600	1321-3R850-B	447.4 (600)	100-D860ED11
	1K1	1162	949.4	700	1321-3R1000-B	552 (700)	100-G860KD22
	1K3	1328	1085.0	800	2 x1321-3R600-B	596.6 (800)	100-G860KD22
	1K4	1494	1220.6	900	2 x1321-3R600-B	671.1 (900)	100-G1200KD12

**Table 82 - 575V AC Input Drives**

Frame	Drive Current Rating Code	DC Amps	AC Line Amps	Hp	IP00 (Open Style) Line Reactor Cat No.	Line Reactor kW (HP)	AC Input Contactor Cat. No.
B	067	67.5	55.1	50	1321-3R55-B	37 (50)	100-C60D10
	101	101.25	82.7	75	1321-3R100-B	56 (75)	100-C85D10
	135	135	110.3	100	1321-3R130-B	75 (100)	100-D110D11
	270	270	220.6	200	1321-3RB250-B	149 (200)	100-D250ED11
	405	405	330.9	300	1321-3RB320-B	224 (300)	100-D420ED11
C	540	540	441.2	400	1321-3RB500-B	298 (400)	100-D630ED11
	675	675	551.5	500	1321-3R600-B	373 (500)	100-D630ED11

**Table 82 - 575V AC Input Drives (continued)**

Frame	Drive Current Rating Code	DC Amps	AC Line Amps	Hp	IP00 (Open Style) Line Reactor Cat No.	Line Reactor kW (HP)	AC Input Contactor Cat. No.
D	810	810	661.8	600	1321-3R750-B	447 (600)	100-D860ED11
	1K0	1080	882.4	800	1321-3R1000-B	597 (800)	100-G700KD22
	1K2	1215	992.7	900	1321-3R1000-B	671 (900)	100-G860KD22
	1K3	1350	1103.0	1000	2 X 1321-3R600-B	746 (1000)	100-G1000KD12
	1K6	1687.5	1378.7	1250	2 X 1321-3R750-B	–	(1)

(1) No AC Input Contactor available for this drive rating - must be sourced locally.

**Table 83 - 690V AC Input Drives**

Frame	Drive Current Rating Code	DC Amps	AC Line Amps	Hp	IP00 (Open Style) Line Reactor Cat No.	Line Reactor kW (HP)	AC Input Contactor Cat. No.
C	452	452	369	400	1321-3RB500-C	–	100-D420ED11
	565	565	462	500	1321-3RB600-C	–	100-D630ED11
D	678	678	554	600	1321-3R750-C	–	100-D630ED11
	791	791	646	700	1321-3R750-C	–	100-D860ED11
	904	904	739	800	1321-3R1000-C	–	100-D860ED11
	1K0	1017	831	900	1321-3R1000-C	–	100-D860ED11
	1K1	1130	923	1000	2 X 1321-3R600-C	–	100-G700KD22
	1K2	1243	1016	1100	2 X 1321-3R600-C	–	100-G860KD22
	1K4	1412.5	1154	1250	2 X 1321-3R750-C	–	100-G1200KD12
	1K5	1582	1292	1400	2 X 1321-3R750-C	–	100-G1200KD12

**Isolation Transformers**

This table contains the recommended isolation transformers

**Table 84 - Recommended Isolation Transformers**

Three Phase Primary Voltage			Three Phase Secondary Voltage		
kVA	kW (Hp)	Voltage	230V AC Catalog Number	460V AC Catalog Number	575V AC Catalog Number
5	1.2 - 2.2 (1.5 - 3)	230	1321-3TW005-AA	1321-3TW005-AB	N/A
		460	1321-3TW005-BA	1321-3TW005-BB	N/A
		575	1321-3TW005-CA	1321-3TW005-CB	N/A
7.5	3.7 (5)	230	1321-3TW007-AA	1321-3TW007-AB	N/A
		460	1321-3TW007-BA	1321-3TW007-BB	N/A
		575	1321-3TW007-CA	1321-3TW007-CB	N/A
11	5.5 (7.5)	230	1321-3TW011-AA	1321-3TW011-AB	N/A
		460	1321-3TW011-BA	1321-3TW011-BB	N/A
		575	1321-3TW011-CA	1321-3TW011-CB	N/A
14	7.5 (10)	230	1321-3TW014-AA	1321-3TW014-AB	N/A
		460	1321-3TW014-BA	1321-3TW014-BB	N/A
		575	1321-3TW014-CA	1321-3TW014-CB	N/A
20	11 (15)	230	1321-3TW020-AA	1321-3TW020-AB	N/A
		460	1321-3TW020-BA	1321-3TW020-BB	N/A
		575	1321-3TW020-CA	1321-3TW020-CB	N/A
27	15 (20)	230	1321-3TW027-AA	1321-3TW027-AB	N/A
		460	1321-3TW027-BA	1321-3TW027-BB	N/A
		575	1321-3TW027-CA	1321-3TW027-CB	N/A
34	18.5 (25)	230	1321-3TW034-AA	1321-3TW034-AB	N/A
		460	1321-3TW034-BA	1321-3TW034-BB	N/A
		575	1321-3TW034-CA	1321-3TW034-CB	N/A
40	22 (30)	230	1321-3TW040-AA	1321-3TW040-AB	N/A
		460	1321-3TW040-BA	1321-3TW040-BB	N/A
		575	1321-3TW040-CA	1321-3TW040-CB	N/A
51	30 (40)	230	1321-3TW051-AA	1321-3TW051-AB	N/A
		460	1321-3TW051-BA	1321-3TW051-BB	N/A
		575	1321-3TW051-CA	1321-3TW051-CB	N/A
63	37 (50)	230	1321-3TH063-AA	1321-3TH063-AB	1321-3TH063-AC
		460	1321-3TH063-BA	1321-3TH063-BB	1321-3TH063-BC
		575	1321-3TH063-CA	1321-3TH063-CB	1321-3TH063-CC
75	45 (60)	230	1321-3TH075-AA	1321-3TH075-AB	1321-3TH075-AC
		460	1321-3TH075-BA	1321-3TH075-BB	1321-3TH075-BC
		575	1321-3TH075-CA	1321-3TH075-CB	1321-3TH075-CC
93	56 (75)	230	1321-3TH093-AA	1321-3TH093-AB	1321-3TH093-AC
		460	1321-3TH093-BA	1321-3TH093-BB	1321-3TH093-BC
		575	1321-3TH093-CA	1321-3TH093-CB	1321-3TH093-CC

**Table 84 - Recommended Isolation Transformers (continued)**

Three Phase Primary Voltage			Three Phase Secondary Voltage		
kVA	kW (Hp)	Voltage	230V AC Catalog Number	460V AC Catalog Number	575V AC Catalog Number
118	75 (100)	230	1321-3TH118-AA	1321-3TH118-AB	1321-3TH118-AC
		460	1321-3TH118-BA	1321-3TH118-BB	1321-3TH118-BC
		575	1321-3TH118-CA	1321-3TH118-CB	1321-3TH118-CC
145	93 (125)	230	1321-3TH145-AA	1321-3TH145-AB	1321-3TH145-AC
		460	1321-3TH145-BA	1321-3TH145-BB	1321-3TH145-BC
		575	1321-3TH145-CA	1321-3TH145-CB	1321-3TH145-CC
175	112 (150)	230	1321-3TH175-AA	1321-3TH175-AB	1321-3TH175-AC
		460	1321-3TH175-BA	1321-3TH175-BB	1321-3TH175-BC
		575	1321-3TH175-CA	1321-3TH175-CB	1321-3TH175-CC
220	145 (200)	230	1321-3TH220-AA	1321-3TH220-AB	1321-3TH220-AC
		460	1321-3TH220-BA	1321-3TH220-BB	1321-3TH220-BC
		575	1321-3TH220-CA	1321-3TH220-CB	1321-3TH220-CC
275	187 (250)	230	1321-3TH275-AA	1321-3TH275-AB	1321-3TH275-AC
		460	1321-3TH275-BA	1321-3TH275-BB	1321-3TH275-BC
		575	1321-3TH275-CA	1321-3TH275-CB	1321-3TH275-CC
330	224 (300)	230	1321-3TH330-AA	1321-3TH330-AB	1321-3TH330-AC
		460	1321-3TH330-BA	1321-3TH330-BB	1321-3TH330-BC
		575	1321-3TH330-CA	1321-3TH330-CB	1321-3TH330-CC
440	298 (400)	230	N/A	1321-3TH440-AB	1321-3TH440-AC
		460	N/A	1321-3TH440-BB	1321-3TH440-BC
		575	N/A	1321-3TH440-CB	1321-3TH440-CC
550	373 (500)	230	N/A	1321-3TH550-AB	1321-3TH550-AC
		460	N/A	1321-3TH550-BB	1321-3TH550-BC
		575	N/A	1321-3TH550-CB	1321-3TH550-CC
660	448 (600)	230	N/A	1321-3TH660-AB	1321-3TH660-AC
		460	N/A	1321-3TH660-BB	1321-3TH660-BC
		575	N/A	1321-3TH660-CB	1321-3TH660-CC
770	522 (700)	230	N/A	1321-3TH770-AB	1321-3TH770-AC
		460	N/A	1321-3TH770-BB	1321-3TH770-BC
		575	N/A	1321-3TH770-CB	1321-3TH770-CC
880	597 (800)	230	N/A	1321-3TH880-AB	1321-3TH880-AC
		460	N/A	1321-3TH880-BB	1321-3TH880-BC
		575	N/A	1321-3TH880-CB	1321-3TH880-CC



## Dynamic Brake Resistor Kits and DC Output Contactors

See [Table 87](#) and [Table 88](#) on page [272](#) for recommended alternate DC Output Contactors for 575V and 690V AC input drives, respectively.

**Table 85 - 230V AC Input Drives**

Frame	Drive Current Rating Code	DC Amps	AC Line Amps	Hp	Dynamic Brake Resistor Kit Cat. No.	Armature Voltage (Volts)	Total DB Resistance (ohms)	DC Loop Contactor Cat. No. <sup>(2)</sup>		DC Contactor Crimp Lugs Cat. No. <sup>(3)</sup>
								Drive without Dynamic Brake	Drive with Dynamic Brake	
A	7P0	7	5.7	1.5	1370-DBL62	240	20	1370-NC56	1370-DC56	1370-LG40
	9P0	9	7.4	2	1370-DBL63	240	20	1370-NC56	1370-DC56	1370-LG40
	012	12	9.8	3	1370-DBL64	240	15	1370-NC56	1370-DC56	1370-LG40
	020	20	16	5	1370-DBL65	240	8.6	1370-NC56	1370-DC56	1370-LG40
	029	29	24	7.5	1370-DBL66	240	6	1370-NC56	1370-DC56	1370-LG40
	038	38	31	10	1370-DBL67	240	5	1370-NC56	1370-DC56	1370-LG40
	055	55	45	15	1370-DBL68	240	3.5	1370-NC56	1370-DC56	1370-LG56
	073	73	60	20	1370-DBL69	240	2.6	1370-NC110	1370-DC110	1370-LG92
	093	93	76	25	1370-DBL70	240	2	1370-NC110	1370-DC110	1370-LG92
	110	110	90	30	1370-DBL71	240	2	1370-NC110	1370-DC110	1370-LG110
B	146	146	119	40	1370-DBL72	240	1.4	1370-NC180	1370-DC180	1370-LG160
	180	180	147	50	1370-DBL73	240	1.0	1370-NC180	1370-DC180	1370-LG180
	218	218	178	60	1370-DBL74	240	1.0	1370-NC280	1370-DC280	1370-LG228
	265	265	217	75	1370-DBL75	240	0.67	1370-NC280	1370-DC280	1370-LG268
	360	360	294	100	1370-DBL76	240	0.47	ABB_EHDB360C2P-1L2S	ABB_EHDB360C-1L22SS	<sup>(4)</sup>
	434	434	355	125	CUTLER-HAMMER_G3AP50 (Qty 4 - two in series, two in parallel)	240	0.4	ABB_EHDB520C2P-1L2S	ABB_EHDB520C-1L22SS	<sup>(4)</sup>
C	521	521	426	150	HUBBELL_Y139W32 2GB	240	0.322			<sup>(4)</sup>
	700	700	572	200	<sup>(1)</sup>	240	0.25	ABB_EHDB800C2P-1L2S	ABB_EHDB800C-1L22SS	<sup>(4)</sup>
D	875	875	715	250	<sup>(1)</sup>	240	0.2	ABB_EHDB960C2P-1L2S	ABB_EHDB960C-1L22SS	<sup>(4)</sup>
	1K0	1050	858	300	<sup>(1)</sup>	240	0.2	SIEMENS-MFG_14-193-101-58-2 (Qty 2)	SIEMENS-MFG_14-193-101-58-2 (Qty 1)	<sup>(4)</sup>

(1) No Dynamic Brake Resistor kit available for this drive rating - must be sourced locally.

(2) Coil voltage = 115V AC, 50/60Hz.

(3) See DC Contactor Crimp Lug Kit Specifications on page [271](#) for more information.

(4) Wire and Lug size dependent on enclosure dimensions and local codes.

**Table 86 - 460V AC Input Drives**

Frame	Drive Current Rating Code	DC Amps	AC Line Amps	Hp	Dynamic Brake Resistor Kit Cat. No.	Armature Voltage (Volts)	Total DB Resistance (ohms)	DC Loop Contactor Cat. No. <sup>(2)</sup>		DC Contactor Crimp Lugs Cat. No. <sup>(5)</sup>
								Drive without Dynamic Brake	Drive with Dynamic Brake	
A	4P1	4.1	3.3	2	1370-DBH63	500	81	1370-NC56	1370-DC56	1370-LG40
	6P0	6	4.9	3	1370-DBH64	500	62	1370-NC56	1370-DC56	1370-LG40
	010	10	8.2	5	1370-DBH65	500	45	1370-NC56	1370-DC56	1370-LG40
	014	14	11.4	7.5	1370-DBH66	500	27	1370-NC56	1370-DC56	1370-LG40
	019	19	15.5	10	1370-DBH67	500	20	1370-NC56	1370-DC56	1370-LG40
	027	27	22.1	15	1370-DBH68	500	12	1370-NC56	1370-DC56	1370-LG40
	035	35	28.6	20	1370-DBH69	500	10	1370-NC56	1370-DC56	1370-LG40
	045	45	36.8	25	1370-DBH70	500	9	1370-NC56	1370-DC56	1370-LG52
	052	52	42.5	30	1370-DBH71	500	7	1370-NC56	1370-DC56	1370-LG52
	073	73	59.6	40	1370-DBH72	500	5.2	1370-NC110	1370-DC110	1370-LG92
	086	86	70.3	50	1370-DBH73	500	4	1370-NC110	1370-DC110	1370-LG92
	100	100	81.7	60	1370-DBH74	500	4	1370-NC110	1370-DC110	1370-LG110
	129	129	105.4	75	1370-DBH75	500	3	1370-NC180	1370-DC180	1370-LG140
B	167	167	136.4	100	1370-DBH76	500	2.1	1370-NC180	1370-DC180	1370-LG180
	207	207	169.1	125	1370-DBH77	500	2.1	1370-NC280	1370-DC280	1370-LG228
	250	250	204.3	150	1370-DBH78	500	1.5	1370-NC280	1370-DC280	1370-LG268
	330	330	269.6	200	1370-DBH79	500	1.05	ABB_EHDB360C2P-1L2S	ABB_EHDB360C-1L22SS	(4)
	412	412	336.6	250	HUBBELL_Y95W808GB	500	1	ABB_EHDB520C2P-1L2S	ABB_EHDB520C-1L22SS	(5)
C	495	495	404.4	300	HUBBELL_Y101W595GB	500	0.8	ABB_EHDB520C2P-1L2S	ABB_EHDB520C-1L22SS	(5)
	667	667	544.9	400	HUBBELL_Y109W542GB	500	0.625	ABB_EHDB800C2P-1L2S	ABB_EHDB800C-1L22SS	(5)
D	800	830	678.1	500	(1)	500	0.463	ABB_EHDB960C2P-1L2S	ABB_EHDB960C-1L22SS	(5)
	960	996	813.7	600	(2)	500	0.322	SIEMENS-MFG_14-193-101-58-2 (Qty 2)	SIEMENS-MFG_14-193-101-58-2 (Qty 1)	(5)
	1K1	1162	949.4	700	(2)	500	0.322	SIEMENS-MFG_14-193-101-58-2 (Qty 2)	SIEMENS-MFG_14-193-101-58-2 (Qty 1)	(5)
	1K3	1328	1085.0	800	(2)	500	0.255	CUTLER-HAMMER_6702ED636-2 (Qty 2)	CUTLER-HAMMER_6702ED636-2 (Qty 1)	(5)
	1K4	1494	1220.6	900	(2)	500	0.255	CUTLER-HAMMER_6702ED636-2 (Qty 2)	CUTLER-HAMMER_6702ED636-2 (Qty 1)	(5)

(1) No Dynamic Brake Resistor Kit available for this drive rating - must be sourced locally.

(2) Coil voltage = 115V AC, 50/60Hz.

(3) See DC Contactor Crimp Lug Kit Specifications on page 271 for more information.

(4) Wire and Lug size dependent on enclosure dimensions and local codes.

## DC Contactor Crimp Lug Kit Specifications

Use the information that is provided in this table to assist you in ordering the correct Lug kit for your application.

Rated Motor Armature Current <sup>(1)</sup> A DC	DC Contactor Rating A DC	Armature Conductor Size <sup>(2)</sup> AWG	DB Conductor Size <sup>(3)</sup> AWG	Armature Conductor Crimp Lug Hole Size	DB Conductor Crimp Lug Hole Size	Lug Kit Catalog Number
4.1...35	56	8	8	#10	#10	1370-LG40
45...52	56	6	8	#10	#10	1370-LG52
55	56	4	8	#10	#10	1370-LG56
60...86	110	2	6	0.25 in.	0.25 in.	1370-LG92
100...110	110	1/0	4	0.25 in.	0.25 in.	1370-LG110
129	180	2/0	2	0.3125 in.	0.3125 in.	1370-LG140
146	180	3/0	2	0.3125 in.	0.3125 in.	1370-LG160
147...167	180	4/0	2	0.3125 in.	0.3125 in.	1370-LG180
207...218	280	300MCM	1/0	0.5 in.	0.375 in.	1370-LG228
250...265	280	400MCM	2/0	0.5 in.	0.375 in.	1370-LG268
266...280	280	500MCM	3/0	0.5 in.	0.375 in.	1370-LG280

- (1) The Rated Motor Armature Current is taken directly from the motor nameplate or motor data. The current listed in this column is the maximum current that is allowed for the Armature Conductor Size (column 3) and the DC Contactor Rating (column 2).
- (2) The armature conductors are sized by multiplying the Rated Motor Armature Current by 1.25 as provided for in NEC 420-22 (1987). The DC lug ratings are determined from NEC Table 310-16 (1987) for copper conductors, insulation temperature that is rated at 75° C (167° F) at an ambient temperature of 30° C (86° F). If conditions are other than shown in NEC Table 310-16, then refer to application codes.
- (3) The dynamic braking (DB) conductors are sized as in footnote 2, but at half ampacity due to the short time duration of current flow in these conductors, and has been sized to satisfy NEMA Standard ICS 3-302.62 - Dynamic Braking. If the load inertia is larger than the motor inertia, calculations must be made to determine correct conductor sizing and DB resistor wattage per NEMA Standard ICS 3-302.62.

## Alternate Dynamic Brake Resistor Kits and DC Output Contactors

The following alternate dynamic brake resistor kits and/or DC output contactors can be used with the corresponding PowerFlex DC drives but must be sourced separately from the drive.

**Table 87 - 575V AC Input Drives**

Frame	Drive Current Rating Code	DC Amps	AC Line Amps	Hp	Armature Voltage (Volts)	DB Resistor Size (ohms)	DC Loop Contactor Cat. No. <sup>(1)</sup>		DC Contactor Crimp Lugs Cat. No. <sup>(2)</sup>
							Drive w/No Dynamic Brake	Drive w Dynamic Brake	
B	067	67.5	55.1	50	600	5.93	ABB_EHDB220C2P-1L2S	ABB_EHDB220C-1L22SS	(3)
	101	101	83	75	600	3.95	ABB_EHDB220C2P-1L2S	ABB_EHDB220C-1L22SS	
	135	135	110	100	600	2.96	ABB_EHDB220C2P-1L2S	ABB_EHDB220C-1L22SS	
	270	270	221	200	600	1.48	ABB_EHDB360C2P-1L2S	ABB_EHDB360C-1L22SS	
	405	405	331	300	600	0.988	ABB_EHDB520C2P-1L2S	ABB_EHDB520C-1L22SS	
C	540	540	441	400	600	0.741	ABB_EHDB650C2P-1L2S	ABB_EHDB650C-1L22SS	
	675	675	551	500	600	0.593	ABB_EHDB800C2P-1L2S	ABB_EHDB800C-1L22SS	
D	810	810	662	600	600	0.494	ABB_EHDB960C2P-1L2S	ABB_EHDB960C-1L22SS	
	1K0	1080	882	800	600	0.370	SIEMENS-MFG_14-193-101-58-2 (Qty 2)	SIEMENS-MFG_14-193-101-58-2 (Qty 1)	
	1K2	1215	993	900	600	0.329	SIEMENS-MFG_14-193-101-58-2 (Qty 2)	SIEMENS-MFG_14-193-101-58-2 (Qty 1)	
	1K3	1350	1103	1000	600	0.296	CUTLER-HAMMER_6702ED636-2 (Qty 2)	CUTLER-HAMMER_6702ED636-2 (Qty 1)	
	1K6	1688	1379	1250	600	0.237	CUTLER-HAMMER_6702ED636-2 (Qty 2)	CUTLER-HAMMER_6702ED636-2 (Qty 1)	

- (1) Coil voltage = 115V AC, 50/60Hz.
- (2) See DC Contactor Crimp Lug Kit Specifications on page 279 for more information.
- (3) Wire and Lug size dependent on enclosure dimensions and local codes.

**Table 88 - 690V AC Input Drives**

Frame	Drive Current Rating Code	DC Amps	AC Line Amps	Hp	Armature Voltage (Volts)	DB Resistor Size (ohms)	DC Loop Contactor Cat. No. <sup>(1)</sup>		DC Contactor Crimp Lugs Cat. No. <sup>(2)</sup>
							Drive w/No Dynamic Brake	Drive w Dynamic Brake	
C	452	452	369	400	700	1.03	SIEMENS-MFG_14-193-101-58-2 (Qty 2)	SIEMENS-MFG_14-193-101-58-2 (Qty 1)	(3)
	565	565	462	500	700	0.826	SIEMENS-MFG_14-193-101-58-2 (Qty 2)	SIEMENS-MFG_14-193-101-58-2 (Qty 1)	
D	678	678	554	600	700	0.688	SIEMENS-MFG_14-193-101-58-2 (Qty 2)	SIEMENS-MFG_14-193-101-58-2 (Qty 1)	
	791	791	646	700	700	0.590	SIEMENS-MFG_14-193-101-58-2 (Qty 2)	SIEMENS-MFG_14-193-101-58-2 (Qty 1)	
	904	904	739	800	700	0.516	SIEMENS-MFG_14-193-101-58-2 (Qty 2)	SIEMENS-MFG_14-193-101-58-2 (Qty 1)	
	1K0	1017	831	900	700	0.459	SIEMENS-MFG_14-193-101-58-2 (Qty 2)	SIEMENS-MFG_14-193-101-58-2 (Qty 1)	
	1K1	1130	923	1000	700	0.413	SIEMENS-MFG_14-193-101-58-2 (Qty 2)	SIEMENS-MFG_14-193-101-58-2 (Qty 1)	
	1K2	1243	1016	1100	700	0.375	SIEMENS-MFG_14-193-101-58-2 (Qty 2)	SIEMENS-MFG_14-193-101-58-2 (Qty 1)	
	1K4	1413	1154	1250	700	0.330	CUTLER-HAMMER_6702ED636-2 (Qty 2)	CUTLER-HAMMER_6702ED636-2 (Qty 1)	
	1K5	1582	1292	1400	700	0.295	CUTLER-HAMMER_6702ED636-2 (Qty 2)	CUTLER-HAMMER_6702ED636-2 (Qty 1)	

- (1) Coil voltage = 115V AC, 50/60Hz.
- (2) See DC Contactor Crimp Lug Kit Specifications on page 271 for more information.
- (3) Wire and Lug size dependent on enclosure dimensions and local codes.

## Alternate EMC Filters

The following recommended filters can be used in place of the Rasmi filters that are listed in the table in the Installation Requirements Related to EN 61800-3 and the EMC Directive section on page [41](#).

**IMPORTANT** Only the Rasmi RF 3xxx-MHU, Rasmi RF-3xxx-SIEI, and EPCOS B84143B Type S081 filters have been certified for use with the PowerFlex DC drive. All other filters must be verified in the application.

**Table 89 - Rasmi and Rasmi Alternative Filters**

Frame	Drive Current Rating Code	Voltage Class	Rasmi Filters	Rasmi Alternative Type Filters	
			Part Number	Part Number	Part Number
A	7P0	230V AC	EMI-FFP-480-9, Code 8270 (was RF 3009-SIEI)	RF 3007-FTF, Code 7670 (Rasmi / EuroTek)	RF 3010-MHU
	9P0		EMI-FFP-480-9, Code 8270 (was RF 3009-SIEI)	RF 3016-FTF, Code 7671 (Rasmi / EuroTek)	RF 3010-MHU
	012		EMI-FFP-480-24, Code 8271 (was RF 3024-SIEI)	RF 3016-FTF, Code 7671 (Rasmi / EuroTek)	RF 3016-MHU
	020		EMI-FFP-480-24, Code 8271 (was RF 3024-SIEI)	RF 3030-FTF, Code 8082 (Rasmi / EuroTek)	RF 3025-MHU
	029		EMI-FFP-480-30, Code 8272 (was RF 3030-SIEI)	RF 3030-FTF, Code 8082 (Rasmi / EuroTek)	RF 3040-MHU
	038		EMI-FFP-480-40, Code 8273 (was RF 3040-SIEI)	RF 3042-FTF, Code 7672 (Rasmi / EuroTek)	RF 3040-MHU
	055		RF 3055-FLP, Code 8078 (Rasmi / EuroTek)	RF 3055-FTF, Code 7673 (Rasmi / EuroTek)	RF 3070-MHU
	073		RF 3100-FLP, Code 8075 (Rasmi / EuroTek)	RF 3075-FTF, Code 7674 (Rasmi / EuroTek)	RF 3100-MHU
	093		RF 3100-FLP, Code 8075 (Rasmi / EuroTek)	RF 3100-FTF, Code 7675 (Rasmi / EuroTek)	RF 3100-MHU
	110		RF 3150-FLP, Code 8076 (Rasmi / EuroTek)	RF 3130-FTF, Code 7676 (Rasmi / EuroTek)	RF 3130-MHU
B	146	RF 3150-FLP, Code 8076 (Rasmi / EuroTek)	RF 3180-FTF, Code 7677 (Rasmi / EuroTek)	RF 3180-MHU	
	180	RF 3180-FLP, Code 8077 (Rasmi / EuroTek)	RF 3180-FTF, Code 7677 (Rasmi / EuroTek)	RF 3180-MHU	
	218	RF 3250-MHU	–	–	
	265	RF 3320-MHU	–	–	
	360	RF 3400-MHU	–	–	
	434	RF 3600-MHU	–	–	
C	521	RF 3600-MHU	–	–	
	700	RF 3800-MHU	–	–	
D	875	RF 31k0-MHU	–	–	
	1K0	RF 31k6-MHU	–	–	

**Table 89 - Rasmi and Rasmi Alternative Filters (continued)**

Frame	Drive Current Rating Code	Voltage Class	Rasmi Filters	Rasmi Alternative Type Filters	
			Part Number	Part Number	Part Number
A	4P1	460V AC	EMI-FFP-480-9, Code 8270 (was RF 3009-SIEI)	RF 3007-FTF, Code 7670 (Rasmi / EuroTek)	RF 3010-MHU
	6P0		EMI-FFP-480-9, Code 8270 (was RF 3009-SIEI)	RF 3007-FTF, Code 7670 (Rasmi / EuroTek)	RF 3010-MHU
	010		EMI-FFP-480-24, Code 8271 (was RF 3024-SIEI)	RF 3016-FTF, Code 7671 (Rasmi / EuroTek)	RF 3010-MHU
	014		EMI-FFP-480-24, Code 8271 (was RF 3024-SIEI)	RF 3016-FTF, Code 7671 (Rasmi / EuroTek)	RF 3016-MHU
	019		EMI-FFP-480-24, Code 8271 (was RF 3024-SIEI)	RF 3030-FTF, Code 8082 (Rasmi / EuroTek)	RF 3025-MHU
	027		EMI-FFP-480-30, Code 8272 (was RF 3030-SIEI)	RF 3030-FTF, Code 8082 (Rasmi / EuroTek)	RF 3040-MHU
	035		EMI-FFP-480-40, Code 8273 (was RF 3040-SIEI)	RF 3042-FTF, Code 7672 (Rasmi / EuroTek)	RF 3040-MHU
	045		RF 3045-FLP, Code 8073 (Rasmi / EuroTek)	RF 3055-FTF, Code 7673 (Rasmi / EuroTek)	RF 3050-MHU
	052		RF 3055-FLP, Code 8078 (Rasmi / EuroTek)	RF 3055-FTF, Code 7673 (Rasmi / EuroTek)	RF 3070-MHU
	073		RF 3100-FLP, Code 8075 (Rasmi / EuroTek)	RF 3075-FTF, Code 7674 (Rasmi / EuroTek)	RF 3100-MHU
	086		RF 3100-FLP, Code 8075 (Rasmi / EuroTek)	RF 3100-FTF, Code 7675 (Rasmi / EuroTek)	RF 3100-MHU
	100		RF 3100-FLP, Code 8075 (Rasmi / EuroTek)	RF 3100-FTF, Code 7675 (Rasmi / EuroTek)	RF 3100-MHU
	129		RF 3150-FLP, Code 8076 (Rasmi / EuroTek)	RF 3130-FTF, Code 7676 (Rasmi / EuroTek)	RF 3130-MHU
	B		167	RF 3180-FLP, Code 8077 (Rasmi / EuroTek)	RF 3180-FTF, Code 7677 (Rasmi / EuroTek)
207		RF 3250-MHU	–	–	
250		RF 3250-MHU	–	–	
330		RF 3400-MHU	–	–	
412		RF 3600-MHU	–	–	
C	495	RF 3600-MHU	–	–	
	667	RF 3800-MHU	–	–	
D	830	RF 31k0-MHU	–	–	
	996	RF 31k6-MHU	–	–	
	1K1	RF 31k6-MHU	–	–	
	1K3	RF 31k6-MHU	–	–	
	1K4	RF 31k6-MHU	–	–	

**Table 90 - Schaffner and Schaffner Alternative Filters**

Frame	Drive Current Rating Code	Voltage Class	Schaffner Filters	Schaffner Alternative Type Filters	
			Part Number	Part Number	Part Number
A	7P0	230V	FN 258-7-29	FN 3258-7-44	FN 3270H-10-44
	9P0		FN 258-16-29	FN 3258-16-44	FN 3270H-10-44
	012		FN 258-16-29	FN 3258-16-44	FN 3270H-20-44
	020		FN 258-30-33	FN 3258-30-33	FN 3270H-20-44
	029		FN 258-30-33	FN 3258-30-33	FN 3270H-35-33
	038		FN 258-42-33	FN 3258-42-33	FN 3270H-50-34
	055		FN 258-55-34	FN 3258-55-34	FN 3270H-65-34
	073		FN 258-75-34	FN 3258-75-34	FN 3270H-80-35
	093		FN 258-100-35	FN 3258-100-35	FN 3270H-100-35
	110		FN 258-130-35	FN 3258-130-35	FN 3270H-150-99
B	146	FN 258-180-40	FN 3258-180-40	FN 3270H-150-99	
	180	FN 258-180-40	FN 3258-180-40	FN 3270H-200-99	
	218	FN 258-250-40	FN 3359-250-28	FN 3270H-250-99	
	265	FN 258-250-40	FN 3359-320-99	FN 3270H-320-99	
	360	–	FN 3359-400-99	FN 3270H-400-99	
	434	–	FN 3359-400-99	FN 3270H-600-99	
C	521	–	FN 3359-600-99	FN 3270H-600-99	
	700	–	FN 3359-800-99	FN 3270H-800-99	
D	875	FN 3359-1000-99	–	FN 3270H-1000-99	
	1K0	FN 3359-1000-99	–	FN 3270H-1000-99	

**Table 90 - Schaffner and Schaffner Alternative Filters (continued)**

Frame	Drive Current Rating Code	Voltage Class	Schaffner Filters	Schaffner Alternative Type Filters	
			Part Number	Part Number	Part Number
A	4P1	460	FN 258HV-7-29	–	FN 3270H-10-44
	6P0		FN 258HV-7-29	–	FN 3270H-10-44
	010		FN 258HV-16-29	–	FN 3270H-10-44
	014		FN 258HV-16-29	–	FN 3270H-20-44
	019		FN 258HV-30-33	–	FN 3270H-20-44
	027		FN 258HV-30-33	–	FN 3270H-35-33
	035		FN 258HV-42-33	–	FN 3270H-35-33
	045		FN 258HV-55-34	–	FN 3270H-50-34
	052		FN 258HV-55-34	–	FN 3270H-65-34
	073		FN 258HV-75-34	–	FN 3270H-80-35
	086		FN 258HV-100-35	–	FN 3270H-100-35
	100		FN 258HV-100-35	–	FN 3270H-100-35
	129		FN 258HV-130-35	–	FN 3270H-150-99
	B		167	FN 3359HV-180-28	–
207		FN 3359HV-250-28	–	FN 3270H-250-99	
250		FN 3359HV-320-99	–	FN 3270H-250-99	
330		FN 3359HV-320-99	–	FN 3270H-320-99	
412		FN 3359HV-400-99	–	FN 3270H-400-99	
C	495	FN 3359HV-600-99	–	FN 3270H-600-99	
	667	FN 3359HV-800-99	–	FN 3270H-800-99	
D	830	FN 3359HV-800-99	–	FN 3270H-1000-99	
	996	FN 3359HV-1000-99	–	FN 3270H-1000-99	
	1K1	FN 3359HV-1600-99	–	–	
	1K3	FN 3359HV-1600-99	–	–	
	1K4	FN 3359HV-1600-99	–	–	
B	067	575	FN 258HV-75-34	–	–
	101		FN 258HV-100-35	–	–
	135		FN 258HV-130-35	FN 3359HV-150-28	–
	270		FN 3359HV-320-99	–	–
	405		FN 3359HV-400-99	–	–
C	540	FN 3359HV-600-99	–	–	
	675	FN 3359HV-800-99	–	–	
D	810	FN 3359HV-800-99	–	–	
	1K0	FN 3359HV-1000-99	–	–	
	1K2	FN 3359HV-1600-99	–	–	
	1K3	FN 3359HV-1600-99	–	–	
	1K6	FN 3359HV-1600-99	–	–	



**Table 90 - Schaffner and Schaffner Alternative Filters (continued)**

Frame	Drive Current Rating Code	Voltage Class	Schaffner Filters	Schaffner Alternative Type Filters	
			Part Number	Part Number	Part Number
C	452	690	FN3359HV-600-99	–	–
	565		FN3359HV-600-99	–	–
D	678		FN3359HV-800-99	–	–
	791		FN3359HV-800-99	–	–
	904		FN3359HV-1000-99	–	–
	1K0		FN3359HV-1600-99	–	–
	1K1		FN3359HV-1600-99	–	–
	1K2		FN3359HV-1600-99	–	–
	1K4		FN3359HV-1600-99	–	–
	1K5		FN3359HV-1600-99	–	–

**Table 91 - EPCOS and EPCOS Alternative Filters**

Frame	Drive Current Rating Code	Voltage Class	EPCOS Filters	EPCOS Alternative Type Filters	
			Part Number	Part Number	Part Number
D	875	230	B84143B1000S080	B84143B1000S020	–
	1K0		B84143B1600S080	B84143B1600S020	–
D	830	460	B84143B1000S081	B84143B1000S020	B84143B1000S021
	996		B84143B1600S081	B84143B1600S020	B84143B1600S021
	1K1		B84143B1600S081	B84143B1600S020	B84143B1600S021
	1K3		B84143B1600S081	B84143B1600S020	B84143B1600S021
	1K4		B84143B1600S081	B84143B1600S020	B84143B1600S021
B	135	575	B84143B0180S081	B84143B0150S021	–
	270		B84143B0320S081	B84143B0320S021	–
	405		B84143B0600S081	B84143B0600S021	–
C	540	690	B84143B0600S081	B84143B0600S021	–
	675		B84143B1000S081	B84143B1000S021	–
D	810		B84143B1000S081	B84143B1000S021	–
	1K0		B84143B1600S081	B84143B1600S021	–
	1K2		B84143B1600S081	B84143B1600S021	–
	1K3		B84143B1600S081	B84143B1600S021	–
	1K6		B84143B2500S021	–	–
C	452		B84143B0600S081	B84143B0600S021	–
	565		B84143B0600S081	B84143B0600S021	–
D	678		B84143B1000S081	B84143B1000S021	–
	791		B84143B1000S081	B84143B1000S021	–
	904		B84143B1000S081	B84143B1000S021	–
	1K0		B84143B1600S081	B84143B1600S021	–
	1K1		B84143B1600S081	B84143B1600S021	–
	1K2		B84143B1600S081	B84143B1600S021	–
	1K4		B84143B1600S081	B84143B1600S021	–
	1K5		B84143B1600S081	B84143B1600S021	–

## Terminal Adapter Kits for Frame D Drives

The following frame D drives require the listed terminal adapter kits to meet UL installation requirements.

Voltage Class	Drive Current Rating Code	U, V, W Terminal Adapter Kit Number	C, D Terminal Adapter Kit Number
230	1K0	SK-20P-S726172	–
460	1K1	SK-20P-S726171	–
	1K3		–
	1K4		–
575	1K0	SK-20P-S726172	–
	1K2	SK-20P-S726171	–
	1K3		–
	1K6		SK-20P-S726173
690	1K0	SK-20P-S726172	–
	1K1	SK-20P-S726171	–
	1K2		–
	1K4		–
	1K5		–

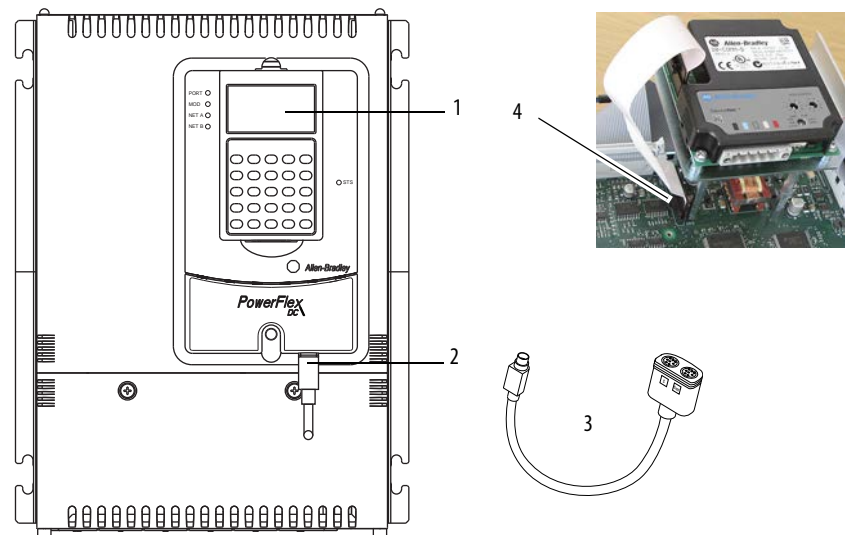
**Notes:**

## HIM Overview

Topic	Page
External and Internal Connections	281
LCD Display Elements	282
ALT Functions	282
Menu Structure	284
Viewing and Editing Parameters	286
Removing/Installing the HIM	287

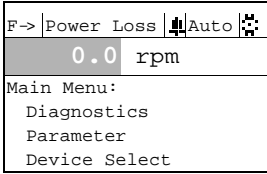
### External and Internal Connections

The PowerFlex® DC drive provides a number of cable connection points for the HIM (frame A shown).



No.	Connector	Description
1	DPI Port 1	HIM connection when installed in cover.
2	DPI Port 2	DPI cable connection for handheld and remote options.
3	DPI Port 3 or 2	Splitter cable that is connected to DPI Port 2 provides additional port.
4	DPI Port 5	Cable connection for communication adapter (shown with front cover removed).

## LCD Display Elements









Display	Description
	Direction   Drive Status   Alarm   Auto/Man   Information Commanded or Output Speed or Current Programming / Monitoring / Troubleshooting

The top line of the HIM display can be configured with parameter 1321 [DPI Fdbk Select].

## ALT Functions

To use an ALT function, press the ALT key, release it, then press the programming key that is associated with the function printed on the HIM above the key:

**Table 92 - ALT Key Functions**

Press the ALT Key and then ...	Performs this function ...
	S.M.A.R.T.  Displays the S.M.A.R.T. list screen. See Using the S.M.A.R.T. List Screen on page 283 for more information.
View 	Lets you select how parameters are viewed or provides detailed information about a parameter or component.
Lang 	Displays the language selection screen.
Auto / Man 	Switches between Auto and Manual Modes.
Remove 	Allows HIM removal without causing a fault if the HIM is not the last controlling device and does not have Manual control of the drive.
Exp 	Allows value to be entered as an exponent (Not available on the PowerFlex DC drive).
Param # 	Allows entry of a parameter number for viewing/editing.

## Using the S.M.A.R.T. List Screen

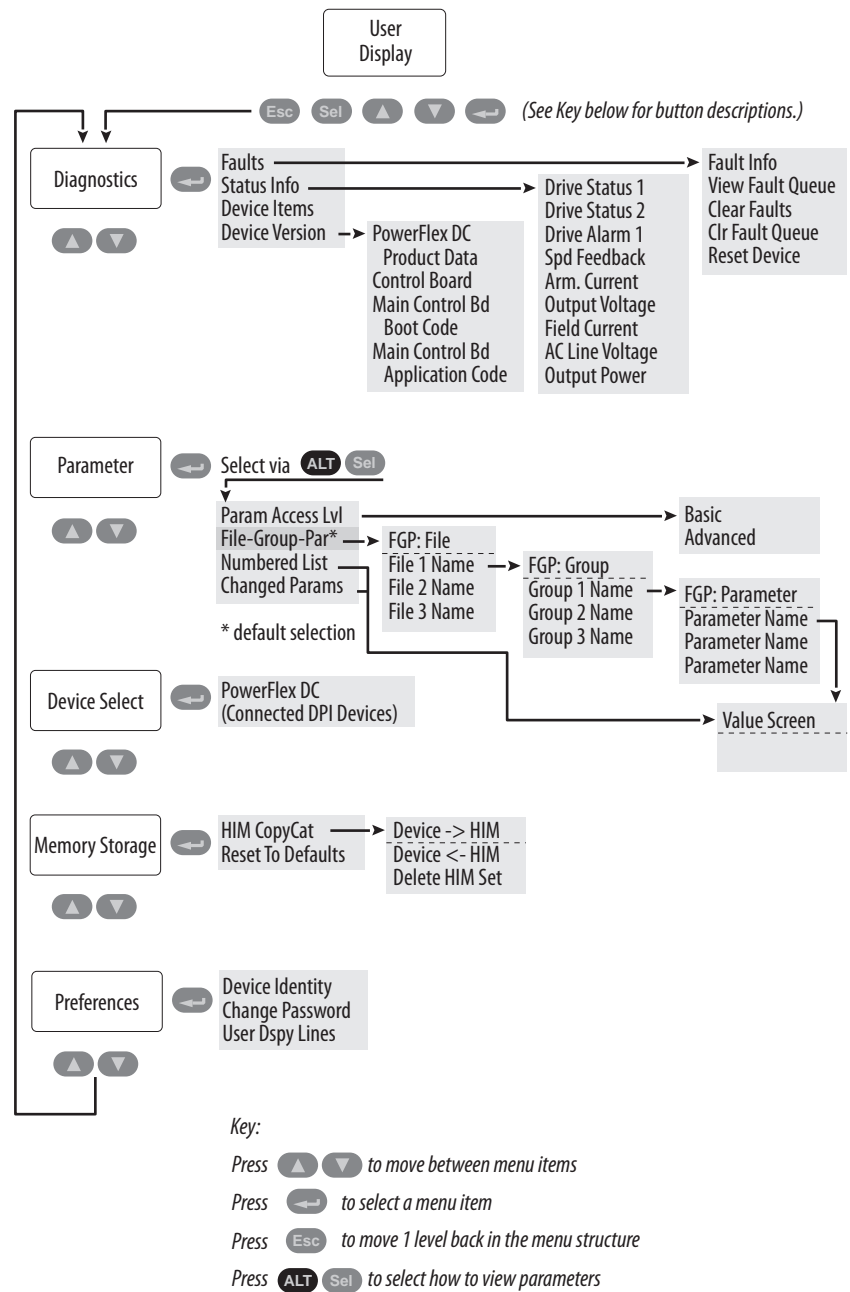
The LCD HIM provides the S.M.A.R.T. list screen, which contains some of the most commonly changed parameters, including the following:

Parameter Name / Number	Description
[Max Ref Speed] (45)	The base motor speed from the motor nameplate.
[Rated Motor Volt] (175)	The maximum armature voltage of the drive output.
[Nom Mtr Arm Amps] (179)	Corresponds to 100% of the current limit.
[Nom Mtr Fld Amps] (280)	Rated motor nameplate field current.
[Anlg In1 Sel] (70)	Selects the parameter to which a value is written from analog input 1 (default = "Speed Ref A")
[Maximum Speed] (2)	Defines the maximum speed of the drive.
[Current Limit] (7)	Symmetrical current limit for both current directions for four quadrant drives, expressed as a percentage of the value in parameter 179 [Nom Mtr Arm Amps].
[Accel Time 1] (660)	Sets the rate of acceleration for Ramp 0.
[Fdbk Device Type] (414)	The source of speed feedback.

Some important Start Up parameters are not included in this screen. See Drive Start Up on page [23](#) for detailed instructions.

# Menu Structure

Figure 84 - HIM Menu Structure



### Diagnostics Menu

When a fault trips the drive, use this menu to access detailed data about the drive.

Option	Description
Faults	View fault queue or fault information, clear faults, or reset drive.
Status Info	View parameters that display status information about the drive.
Device Items	View statistics that are associated with DPI communication.
Device Version	View the firmware version and hardware series of components.



### Parameter Menu

Use this menu to view and edit parameters for the drive. When you enter the the Parameter menu, by default the File–Group–Parameter view is displayed. To access other views for the Parameter menu, with "Parameter" highlighted in the Main menu, press Alt then Sel (View), select the desired view in the list and press Enter. The following selections are available:

Option	Description
Param Access Lvl	Displays parameter 211 [Param Access Level]. The PowerFlex DC drive is initially set to the Basic Parameter view. To view all parameters, set parameter 211 [Param Access Lvl] to option 1 "Advanced".
File-Group-Par	Displays all parameters in a File - Group - Parameter (FGP) structure. The FGP structure simplifies programming by grouping parameters that are used for similar functions.
Numbered List	Displays all parameters in numerical order.
Changed Params	Displays the most recently changed parameter. You can scroll through the list of all changed parameters to the least recently changed. The new and default values are listed for each parameter.

See Viewing and Editing Parameters on page [286](#) for more information.

### Device Select Menu

Use this menu to access parameters in connected peripheral devices.

### Memory Storage Menu

Drive data can be saved to, or recalled from, 'HIM sets.' HIM sets are files that are stored in permanent nonvolatile HIM memory.



**ATTENTION:** It is recommended that you stop the drive before performing a download to the drive by using the HIM CopyCat function or DriveExecutive™.

Option	Description
<u>HIM CopyCat</u>	
Device -> HIM	Save data to a HIM set.
Device <- HIM	Load data from a HIM set to active drive memory.
Delete HIM Set	Delete a HIM set.
Reset To Defaults	Restore the drive to its factory default settings.







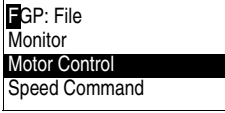
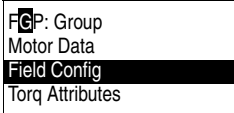
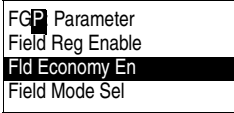









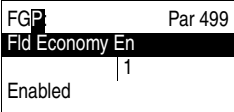
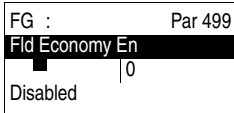
### Preferences Menu

The HIM and drive have features that you can customize.

Option	Description
Drive Identity	Add text to identify the drive.
User Dspy Lines	Select the display, parameter, scale, and text for the User Display. The User Display is two lines of user-defined data that appears when the HIM is not being used for programming.

## Viewing and Editing Parameters

### LCD HIM



Step	Example Displays
<p>1. In the Main Menu, press  or  to scroll to 'Parameter'.</p> <p>2. Press . 'FGP File' appears on the top line and the first three files appear below it.</p> <p>3. To scroll through the files, press  or .</p> <p>4. To select a file, press . The groups in the file are displayed under it.</p> <p>5. Repeat steps 3 and 4 to select a group and then a parameter. The parameter value screen appears.</p>	  
<p>6. To edit the parameter, press .</p> <p>7. Press the  or  change the value.</p> <p>If desired, press  to move from digit to digit, letter to letter, or bit to bit. The digit or bit that you can change is highlighted.</p> <p>8. To save the value, press . If you want to cancel a change, press .</p> <p>9. To scroll through the parameters in the group, press  or .</p> <p>Or press  to return to the group list.</p>	 

#### Numeric Keypad Shortcut

On a HIM with a numeric keypad, press the ALT key and the +/- key to access the parameter by typing its number.

**Removing/Installing the HIM** The HIM can be removed or installed while the drive is powered.

**IMPORTANT** HIM removal is only permissible in Auto mode. If the HIM is removed while in Manual mode or the HIM is the only remaining control device, a fault occurs.

Step	Example Displays
<p>To remove the HIM, follow these steps.</p> <ol style="list-style-type: none"> <li>1. Press <b>ALT</b> and then  (Remove). The 'Remove HIM' confirmation screen appears.</li> <li>2. To confirm that you want to remove the HIM, press .</li> <li>3. Remove the HIM from the cradle on the drive.</li> </ol> <p>To install the HIM, insert it into the cradle on the drive or connect the DPI cable.</p>	<div style="border: 1px solid black; padding: 5px;"> <p>Remove Op Intrfc: Press Enter to Disconnect Op Intrfc? (Port 1 Control)</p> </div>

**Notes:**

## Application Notes

Topic	Page	Topic	Page
Alpha Test Mode	289	Reference Control	325
Analog Input Configuration	292	Resolver Cable Balance Tuning Test	328
Current / Speed Curve	294	Resolver Type Selection	329
Drive Reference and Feedback Scaling	296	Scale Blocks	330
Droop Compensation	302	SCR Diagnostic Tests	331
Field-weakening Mode Configuration (v1.006)	302	S-curve Configuration	333
Lifting/Torque Proving	306	Speed Regulation Functions	335
Manually Tuning the Speed Regulator for Firmware Revision 6.001 and Later	317	Speed / Torque Mode Selection	342
Multiple Motor Applications	319	Start At Powerup	348
Parameter 21 [Min Firing Angle] Configuration	320	Fine-Tuning the Regulators	349
PID Function	321		

### Alpha Test Mode

The Alpha Test is a diagnostic function that allows you to activate the Armature or Field power module in an open loop mode. By commanding an SCR firing angle, a voltage is produced at the output of the selected power module. The SCR firing angle is specified in parameter 167 [Arm Test Angle] or Par 168 [Fld Test Angle]. A load greater than 500 mA is required for proper SCR operation - typically, an incandescent bulb or inductive load (never a motor) is used.

The Alpha Test is started as soon as parameter 166 [Alpha Test] is set to one of the following values:

- 1 “Arm Fwd” (armature forward)
- 2 “Arm Rev” (armature reverse)
- 3 “Fld Fwd” (field forward).

The HIM displays “ArmAlphaTest” or “FldAlphaTest” while active. Start and Jog commands have no affect and a motor contactor is not closed when the test mode is initiated.

The Alpha Test ends when Par 166 [Alpha Test] is set to 0 “Off”. Otherwise, only a digital input Enable or a Fault stops the test - a HIM Stop has no affect. A change to the Alpha Test Mode (set in Par 166 [Alpha Test]) resets both test angles to their minimum firing value (180 deg).

Overcurrent and Overvoltage fault protections are active during these tests. Also, the Autotune function is disabled while Alpha test is enabled.

## Alpha Test Setup and Operation



**ATTENTION:** Only qualified electrical personnel familiar with the construction and operation of this equipment and the hazards that are involved should perform this test. Failure to observe this precaution could result in equipment damage and/or bodily injury.



**ATTENTION:** The Alpha test is open loop. Therefore, disconnect the motor armature and field leads and replace them with dummy loads. Failure to observe this precaution could result in machine damage and/or bodily injury.



**ATTENTION:** Uncontrolled machine operation could result with a motor connected during these tests and may cause personal injury and/or equipment damage. Verify that the drive is not connected to a motor armature circuit before enabling these test modes.



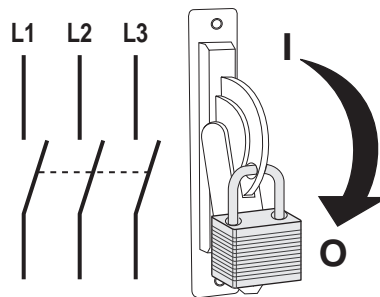
**WARNING:** Remove power before you make or break cable connections. When you remove or insert a cable connector with power applied, an electrical arc may occur. An electrical arc may cause these system events, which can cause personal injury or property damage.

- An erroneous signal to system field devices, which can cause unintended machine motion
- An explosion in a hazardous environment

Electrical arcing causes excessive wear to contacts on both the module and its mating connector. Worn contacts can create electrical resistance.

**IMPORTANT** The Alpha Test requires that you attach the leads of an isolated oscilloscope to the armature or field terminals of the drive.

1. Remove and lock-out all incoming power to the drive.

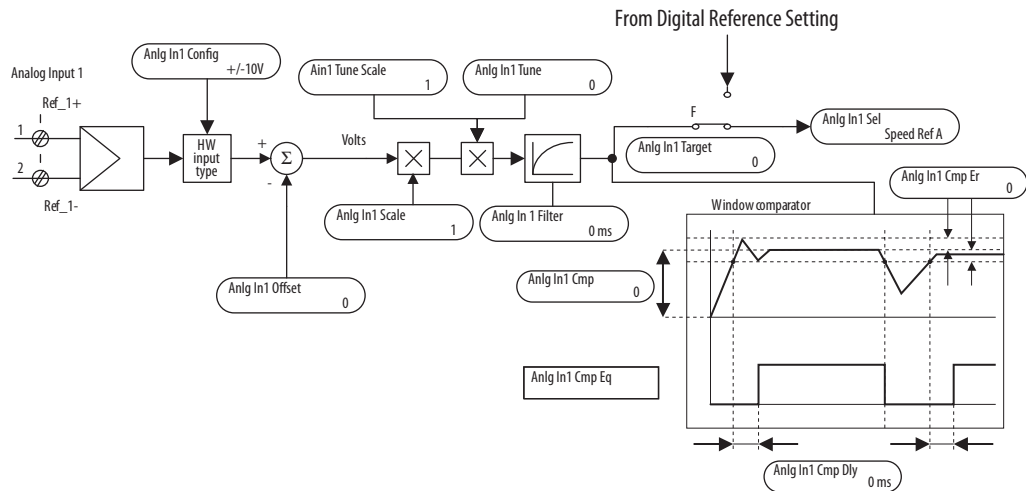


2. Disconnect the motor armature leads and mechanically lock the rotor.

3. Attach the isolated oscilloscope leads to the appropriate drive terminals (based on test to be performed).
  4. Reapply power to the drive.
  5. Verify the no faults or alarms present. If an alarm or fault code displays, see Chapter 4 - Troubleshooting on page [219](#).
  6. Open the Enable input on the drive.
  7. Set Par 166 [Alpha Test] to the desired value (1 = "Arm Fwd", 2 = "Arm Rev" or 3 = "Fld Fwd").
  8. Close the Enable input.
  9. Slowly decrease the appropriate angle parameter (Par 167 [Arm Test Angle] or Par 168 [Fld Test Angle]) until a steady pattern of voltage pulses display on the oscilloscope. The resulting patterns indicate the status of the thyristors.
    - Six pulses per AC line cycle indicate that all thyristors in the selected bridge are operating properly.
    - Fewer than six pulses per AC line cycle indicates that one or more thyristors for the selected bridge are not operating.
- Conduction (or output voltage) does not typically begin until the angle is below approximately 120°.
10. Open the Enable input and set Par 166 [Alpha Test] to 0 "Off".
  11. Remove power from the drive.
  12. Remove the oscilloscope from the leads of the drive and unlock the rotor.
  13. If necessary, replace the defective firing board in the drive.
  14. Reconnect the motor armature and field leads to the drive.
  15. Reapply power to the motor and drive.

## Analog Input Configuration

The analog inputs default to  $\pm 10V$ . To configure the analog inputs for 0-10V, set parameters [Anlg Inx Config] to 1, "0-10V". To configure the analog inputs for a current signal, set parameters [Anlg Inx Config] to 2, "0 - 20mA" or 3, "4 to 20mA". In addition, switches S9, S10, and S11 must be properly configured (see Control Circuit Board Jumper and DIP Switch Settings on page 78 for more information).



See the Analog Inputs/Outputs Mapping block diagram on page 364 for more information.

### Example 1:

The speed reference value of a drive is defined with an external voltage of 5V. With this value, the drive reaches the maximum allowable speed set in Par 45 [Max Ref Speed]. Enter a scaling factor of 2 in [Anlg Inx Scale] to scale the input voltage from 5V to 10V.

### Example 2:

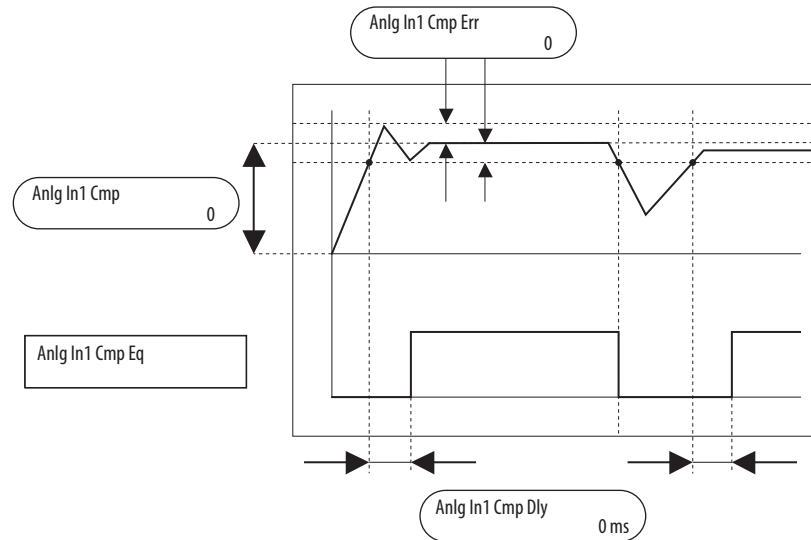
An external analog reference reaches a maximum value of 9.8V. Enter a scaling factor of 1.020 in [Anlg Inx Scale] to scale the maximum voltage from 9.8V to 10V.

The same result could be obtained via parameter [Anlgx Tune Scale], by entering the values of the appropriate parameters via the HIM. The maximum possible analog-input value (in this case 9.8V) must be present at the terminal with a positive polarity at the time of configuration.



## Analog-input Signal Comparison

This feature provides an indication via the HIM or a digital output when the signal of analog input 1 has reached a limit above or below a set reference point.



Calculations that are used to determine Pars1042 [Anlg In1 Cmp] and 1043 [Anlg In1 Cmp Err]:

- $[Anlg\ In1\ Cmp] = (\text{comparison value}) \times 10000 / (\text{max. reference value})$
- $[Anlg\ In1\ Cmp\ Err] = (\text{tolerance value}) \times 10000 / (\text{max. reference value})$

### Example 1:

An application requires an indication via a digital output that the motor speed is within 100 rpms of 700 rpm.

- Par 45 [Max Ref Speed] = 1500 rpm (maximum reference value)
- For Analog Input 1, 10V or 20 mA sets the maximum value of Par 44 [Speed Ref A] = Par 45 [Max Ref Speed]

Configure the following:

- Set Par 70 [Anlg In1 Sel] = "Speed Ref A"
- Set [Digital Outx Sel] = "Input1 Cmp" (Par 1045 [Anlg In1 Cmp Eq])
- Set Par 1042 [Anlg In1 Cmp] = 4667 (700 x 10000 / 1500)
- Set Par 1043 [Anlg In1 Cmp Err] = 666 (100 x 10000 / 1500)

- Par 1045 [Anlg In1 Cmp Eq] = “1” (high) when the signal on Analog Input 1 is within the range that is specified in Par 1043 [Anlg In1 Cmp Err]. Par 1045 [Anlg In1 Cmp Eq] = “0” (low) when the signal on Analog Input 1 is outside the range that is specified in Par 1043 [Anlg In1 Cmp Err].

*Example 2:*

An application requires an indication via a digital output that the output current is within  $\pm 2\%$  of 50% of the maximum current limit.

- Par 7 [Current Limit] = 100% (maximum reference value)
- For Analog Input 1, 10V or 20 mA sets the maximum value = Par 7 [Current Limit]

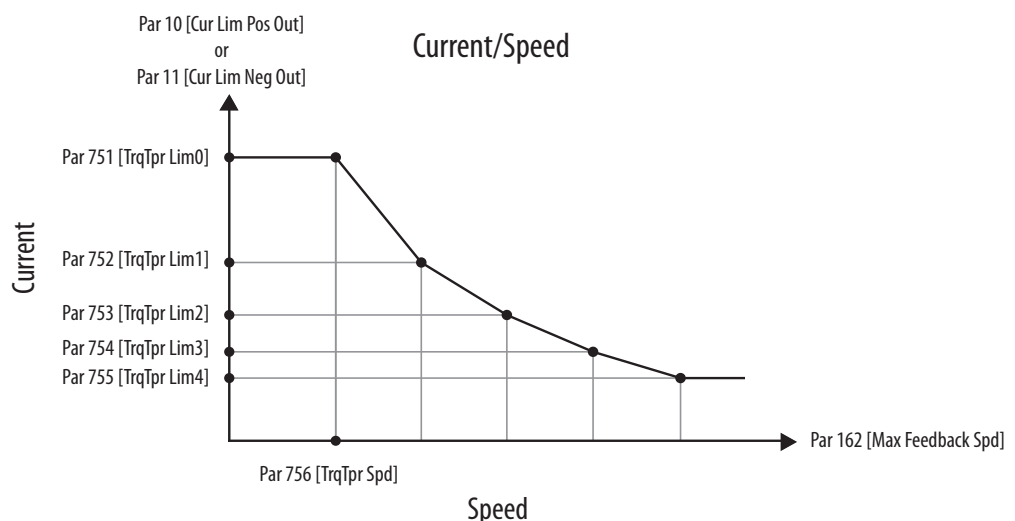
Configure the following:

- Set Par 70 [Anlg In1 Sel] = “Pos Cur Lim”
- Set [Digital Outx Sel] = “Input1 Cmp” (Par 1045 [Anlg In1 Cmp Eq])
- Set Par 1042 [Anlg In1 Cmp] = 5000 (50 x 10000 / 100)
- Set Par 1043 [Anlg In1 Cmp Err] = 200 (2 x 10000 / 100)

## Current / Speed Curve

The current/speed curve function lets you control these attributes:

- Establish a current limit lower than the standard current limits of the drive (specified in parameters 8 [Current Lim Pos] and 9 [Current Lim Neg]).
- Reduce the output current (torque) of the drive through a defined curve as the speed increases based on a threshold speed, effectively reducing torque. The curve is composed of five equally divided set points.



Configure these parameters to enable and control the current / speed curve.

- Enable the current/speed curve function by setting parameter 750 [TrqTpr Enable] to 1 “Enabled”.
- Set the current limit (for both directions of rotation in four quadrant drives) in parameter 751 [TrqTpr Lim0]. The value that is specified in this parameter overrides the value of parameters 8 [Current Lim Pos] and 9 [Current Lim Neg].
- Set the threshold speed at which current (torque) reduction begins in parameter 756 [TrqTpr Spd].
- Set the first reduced current limit in parameter 752 [TrqTpr Lim1]. The value that is defined in this parameter must be set according to these constraints:
  - Less than the value of parameter 751 [TrqTpr Lim0]
  - Greater than the values in parameters 753 [TrqTpr Lim2], 754 [TrqTpr Lim3], and 755 [TrqTpr Lim4].
- Set the second, third, and final reduced current limits in parameters 753 [TrqTpr Lim2], 754 [TrqTpr Lim3] and 755 [TrqTpr Lim4], respectively. The value of each subsequent parameter must be less than the previous parameter value. The drive maintains the value that is specified in parameter 755 [TrqTpr Lim4] up to the value set in parameter 162 [Max Feedback Spd].

## Drive Reference and Feedback Scaling

With firmware revision 3.001, external reference and feedback speed values are each normalized to 25,000 counts. For firmware revision 2.005 and lower, external reference and feedback speed values are scaled to “rpm x 4” counts.

The value of parameter 45 [Max Ref Speed] (rpm) determines the correlation (scaling) between the following attributes:

- DPI speed reference counts and rpm
- Analog-input reference values (10V = Par 45 rpm).

All speed reference values are based on the value of [Max Ref Speed]. The value of [Max Ref Speed] represents the maximum speed that the motor can attain (also known as “gear-in speed”). If field weakening is used, [Max Ref Speed] is set to the field weakened speed. Otherwise, the motor base speed is typically used.

The value of parameter 162 [Max Feedback Spd] (rpm) determines the correlation (scaling) between DPI speed feedback counts and rpm and the DC tachometer values (if configured). All speed feedback values are based on [Max Feedback Spd]. Typically, [Max Feedback Spd] is set to the same value as parameter 45 [Max Ref Speed], but is not required (because each is separately scaled to 25000 counts). See Valid Speed Feedback Values on page 300 for limitations for parameter 162 [Max Feedback Spd] and 169 [Encoder PPR].

### Armature Voltage Feedback

When armature voltage feedback is configured, Par 162 [Max Feedback Spd] must be set to the motor base speed (rpm) value that is associated with Par 175 [Rated Motor Volt].

### DC Analog Tachometer Feedback

DC analog tachometer feedback is configured with these settings:

- Set parameter 414 [Fdbk Device Type] to 2 “DC Tach”
- Position DIP switch S4 on the control board to the maximum input voltage for the tachometer (see [Table 28](#) on page 79 for details)
- Set parameter 162 [Max Feedback Spd] to the same rpm value as indicated by the maximum input voltage that is set with DIP switch S4

To maximize the feedback speed resolution, use Par 562 [Anlg Tach Gain] to scale the voltage indicated by DIP switch S4 to Par 162 [Max Feedback Spd]. Use this equation to determine the correct analog-tachometer gain setting:

$$\text{Par 562 [Anlg Tach Gain]} = (\text{Tachometer Maximum DC Input Voltage}) \times (1000 \text{ rpm/ volts Tach Voltage}) / \text{Par 45 [Max Ref Speed]}$$

## Encoder Feedback

Encoder feedback is configured with parameter 169 [Encoder PPR]. No scaling or switch settings are needed, but the same limitations as the DC analog tachometer apply. See Valid Speed Feedback Values on page 300 for more information on setting parameters 162 [Max Speed Feedback] and 169 [Encoder PPR].

### *Speed Regulator Feedback Bypass*

Speed Regulator feedback bypass provides an automatic switch to armature voltage feedback when a speed feedback-signal loss occurs (“Speed Fdbk Loss” (F91)). Speed Regulator feedback bypass is configured with these settings:

- Set parameter 458 [SpdReg FB Bypass] to 1 “Enabled”
- Connect the drive armature-voltage feedback terminals A1 and A2 to the motor terminals A1 and A2, respectively

The drive armature-voltage feedback terminals must be connected to the motor terminals to use Speed Regulator feedback bypass when these conditions are present:

- A DC contactor is installed with the drive
- Field weakening is enabled (Par 469 [Field Mode Sel] = 1 “Field Weaken”)

## Drive Reference and Feedback Scaling Examples

The examples that are listed here are based on the following data:

- 500V motor, with base speed = 1750 rpm
- Weakened spd = 2500 rpm
- Weakened ratio = 70% ( $1750/2500 = 0.7$ )
- 50V / 1000 rpm tachometer
- 240 ppr encoder
- 7500 fpm application (field weakened or gear-in speed)

Examples 2, 3, and 4 indicate how the value of Par 162 [Max Speed Feedback] is derived from the required analog tachometer scaling that DIP switch S4 determines.

*Example 1: Armature Voltage Feedback (Overvoltage Fixed at 20%)*

Because armature voltage feedback is being used the maximum reference and feedback speeds must be equal and set to the rated speed of the motor. In this case, field weakening is not permitted.

- Par 175 [Rated Motor Volt] = 500V (default)
- Par 45 [Max Ref Speed] = 1750 rpm (default)
- Par 162 [Max Feedback Spd] = 1750 rpm (default)
- The reference and feedback resolution = 0.21 fpm/count (5250 fpm/25000 counts)

*Example 2: DC Tachometer with No Feedback Bypass*

When a DC tachometer is used, the maximum feedback speed must be scaled to the maximum voltage of the tachometer. A loss of feedback resolution results when Par 562 [Anlg Tach Gain] is left at the default value (1.0000). The loss in resolution occurs because the drive is only using 1750 rpm out of the maximum 3600 rpm.

- Par 175 [Rated Motor Volt] = 500V (default)
- Par 45 [Max Ref Speed] = 1750 rpm (default)
- Par 562 [Anlg Tach Gain] = 1.0000 (default)
- Par 585 [Overspeed Val] = 1925 rpm (default)
- Set DIP switch S4 = 180V  
This value is set to the next highest DIP switch setting available based on the result of the following calculation:

$$\frac{\text{Tachometer} \times \text{Max Motor Speed} \times \text{Overspeed Percentage}}{(50\text{V}/1000 \text{ rpm}) \times (1750 \text{ rpm}) \times (1.1)} = \text{Scaled Tach Input Volts} = 96.25\text{V}$$

- Set Par 162 [Max Feedback Spd] = 3600 rpm  
This value is based on (180V/50V) = 3.6 (1000)
- The reference resolution = (5250 fpm/25000 counts) = 0.21 fpm/count
- The feedback resolution = 0.62 fpm/count

*Example 3: DC Tachometer with Feedback Bypass*

This example is similar to example 2 except that it compensates for the loss in feedback resolution by setting parameter 562 [Anlg Tach Gain].

- Par 175 [Rated Motor Volt] = 500V (default)
- Par 45 [Max Ref Speed] = 1750 rpm (default)
- Set Par 562 [Anlg Tach Gain] = 2.057 (3600/1750)
- Par 585 [Overspeed Val] = 1925 rpm (default)
- Set DIP switch S4 = 180V  
This value is set to the next highest DIP switch setting available based on the result of the following calculation:

$$\frac{\text{Tachometer} \times \text{Max Motor Speed} \times \text{Overspeed Percentage}}{(50\text{V}/1000 \text{ rpm}) \times (1750 \text{ rpm}) \times (1.1)} = \text{Scaled Tach Input Volts} = 96.25\text{V}$$

- Par 162 [Max Feedback Spd] = 1750 rpm (default)  
This value is based on: (180V/50V/2.057) = 1.750 (1000)
- The reference and feedback resolution = (5250 fpm/25000 counts) = 0.21 fpm/count

*Example 4: DC Tachometer with Field Weakening*

This example is similar to example 3 except that a field weakening speed of 2500 rpm is configured rather than a base speed of 1750 rpm.

- Par 175 [Rated Motor Volt] = 500V (default)
- Set Par 45 [Max Ref Speed] = 2500 rpm
- Set Par 562 [Anlg Tach Gain] = 1.44
- Set Par 585 [Overspeed Val] = 2750 rpm
- Set DIP switch S4 = 180V  
This value is set to the next highest DIP switch setting available based on the result of the following calculation:

$$\frac{\text{Tachometer} \times \text{Max Motor Speed} \times \text{Overspeed Percentage}}{(50\text{V}/1000 \text{ rpm}) \times (2500 \text{ rpm}) \times (1.1)} = \text{Scaled Tach Input Volts} = 137.5\text{V}$$

- Set Par 162 [Max Feedback Spd] = 2500 rpm  
This value is based on: (180V/50V/1.44) = 2.5 (1000)
- The reference and feedback resolution = (7500 fpm/25000 counts) = 0.3 fpm/count

### *Example 5: Encoder with Field Weakening*

This example is similar to example 4 except that an encoder is configured so there is no feedback scaling required.

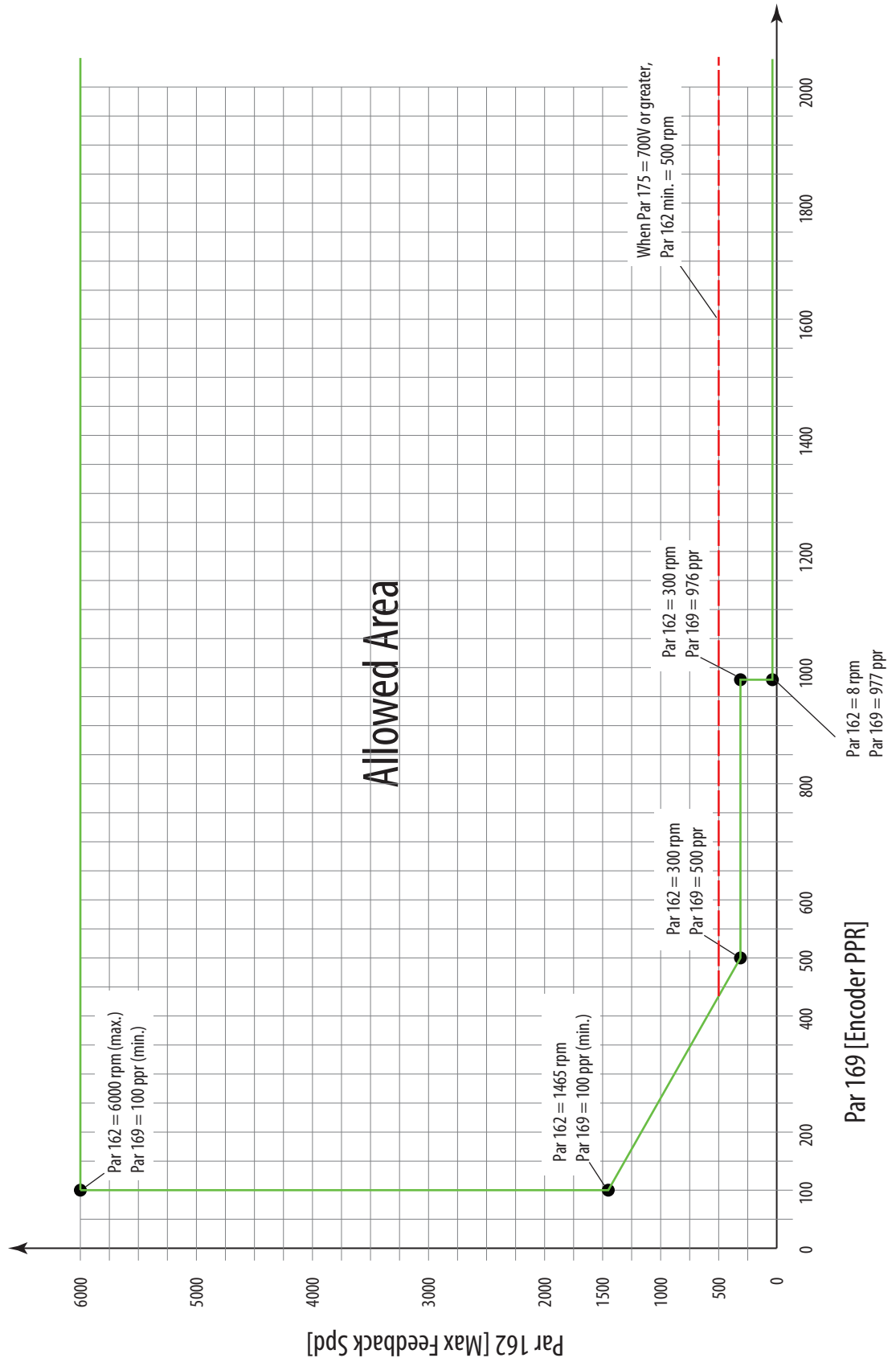
- Par 175 [Rated Motor Volt] = 500V (default)
- Set Par 45 [Max Ref Speed] = 2500 rpm
- Set Par 162 [Max Feedback Spd] = 2500 rpm
- Set Par 169 [Encoder PPR] = 240 ppr
- Set Par 585 [Overspeed Val] = 2750 rpm
- The reference and feedback resolution =  $(7500 \text{ fpm}/25000 \text{ counts}) = 0.3 \text{ fpm/count}$

### **Valid Speed Feedback Values**

Regardless of the type of speed feedback device that is used, the value of parameters 162 [Max Feedback Spd] and 169 [Encoder PPR] must be in the 'Allowed Area' that is shown in [Figure 85](#) on page [301](#) based on the value of Par 175 [Rated Motor Volt].



**Figure 85 - Speed Feedback Settings**



## Droop Compensation

The Droop function is used when the current must be balanced between two drives. A typical situation that requires the use of the Droop function is when two motors are mechanically coupled and must run at the same speed. If Droop is not used, a difference in the drives speed regulators can result in these issues:

- One of the motors runs at a higher speed and is overloaded.
- One of the motors runs at a lower speed and acts, essentially, as a brake.

The Droop function lets you overcome this difference by adding a load compensation component to the speed reference, which is proportional to the actual load differences of the drives.

For example:

Master Drive		Slave Drive	
[Anlg In1 Sel]	= "Speed Ref A"	[Anlg In1 Sel]	= "Speed Ref A"
[Anlg Out1 Sel]	= "Torque Ref" (Par 14)	[Anlg In2 Sel]	= "Load Comp" (Par 698)
		[Enable Droop]	= "Enabled"
		[Droop Percent]	= 5%
		[Droop Filter]	= 100 ms
		[Droop Limit]	= 1000

See the block diagram for Droop Compensation - Inertia / Loss Compensation on page [370](#) for more information.

## Field-weakening Mode Configuration (v1.006)

---

**IMPORTANT** This configuration applies only to firmware revision 1.006. For instructions on how to configure a drive with firmware revision 2.001 for use with an AC or DC contactor, with or without a dynamic brake, see Contactors on page [31](#).

---

The following configuration is required when operating the drive in field weakening mode with a DC contactor and/or inverting fault device that is installed in the armature circuit.



**ATTENTION:** The following information is merely a guide for proper installation. Rockwell Automation, Inc. cannot assume responsibility for the compliance or the noncompliance to any code, national, local or otherwise for the proper installation of this drive or associated equipment. A hazard of personal injury and/or equipment damage exists if codes are ignored during installation.

---

Complete the appropriate installation and programming requirements that are contained on pages [303...305](#) when your PowerFlex® DC drive uses this configuration:

- Field weakening mode is enabled (Par 469 [Field Mode Sel] set to 1 - "Field Weaken")
- A DC contactor and/or an inverting fault device is installed in the armature circuit



**ATTENTION:** If a dynamic brake resistor is used with one of these configurations, dynamic braking stop time is extended when the digital input configured as 35 - "Fld Weak En" is asserted. If one of these configurations is used in an inappropriate application, equipment damage and/or personal injury may result. Do not use one of these configurations without considering applicable local, national, and international codes, standards, regulations, or industry guidelines.

### Using a DC Contactor Only (Firmware v1.006 Only)

1. Set parameter 1391 [ContactorControl] to "Contactor" (default value).
2. Set one [Relay Out x Sel] parameter and one [Digital Inx Sel] parameter to "Contactor" (default value for parameters 1392 [Relay Out 1 Sel] and 140 [Digital In8 Sel]).
3. Connect the DC contactor auxiliary (status) contact to a second digital input.
4. Set the corresponding second [Digital Inx Sel] parameter (133...144) to "Fld Weak En".
5. Set the corresponding [Inversion In x] parameter (1276...1283 or 1387...1390) for the second digital input to "Enabled".

### Using a DC Contactor and a Dynamic Brake (Firmware v1.006 Only)

1. Set parameter 1391 [ContactorControl] to "Contactor+DB".
2. Set one relay output parameter (1392 [Relay Out 1 Sel] or 629 [Relay Out 2 Sel]) to "Contactor" and the other relay output parameter to "ContactorDB".
3. Set one [Digital Inx Sel] parameter to "Contactor" (default value for parameter 140 [Digital In8 Sel]).
4. Connect the DC contactor auxiliary (status) contact to a second digital input.
5. Set the corresponding second [Digital Inx Sel] parameter (133...144) to "Fld Weak En".
6. Set the corresponding [Inversion In x] parameter (1276...1283 or 1387...1390) for the second digital input to "Enabled".

### Using an Inverting Fault Device Only (Firmware v1.006 Only)

1. Connect the inverting-fault device contact to two separate digital inputs. When two inverting fault devices are used, the device contacts must be wired in series.
2. Set one corresponding [Digital Inx Sel] parameter (133...144) to 35 - "Fld Weak En".
3. Set the other corresponding [Digital Inx Sel] parameter (133...144) to 14 - "Aux Fault".
4. Set both of the corresponding [Inversion In x] parameters (1276...1283 or 1387...1390) to 1 - "Enabled".

### Using a DC Contactor and an Inverting Fault Device (Firmware v1.006 Only)

#### *DC Contactor Configuration*

1. Set parameter 1391[ContactorControl] to "Contactor" (default value).
2. Set one [Relay Out x Sel] parameter and one [Digital Inx Sel] parameter to "Contactor" (default value for parameters 1392 [Relay Out 1 Sel] and 140 [Digital In8 Sel]).
3. Connect the DC contactor auxiliary (status) contact to a digital input.
4. Set the corresponding [Digital Inx Sel] parameter (133...144) to 35 - "Fld Weak En".
5. Set the corresponding [Inversion In x] parameter (1276...1283 or 1387...1390) to 1 - "Enabled".

#### *Inverting-fault Device Configuration*

1. Connect the inverting-fault device contact to a digital input.
2. Set the corresponding [Digital Inx Sel] parameter (133...144) to 14 - "Aux Fault".
3. Set the corresponding [Inversion In x] parameter (1276...1283 or 1387...1390) to 1 - "Enabled".

## Using a DC Contactor, a Dynamic Brake and an Inverting Fault Device (Firmware v1.006 Only)

### *DC Contactor and Dynamic Brake Configuration*

1. Set parameter 1391 [ContactorControl] to "Contactor+DB".
2. Set one [Relay Out x Sel] parameter (1392 [Relay Out 1 Sel] or 629 [Relay Out 2 Sel]) to "Contactor" and the other relay output to "ContactorDB".
3. Set one [Digital Inx Sel] parameter to "Contactor" (default value for parameter 140 [Digital In8 Sel]).
4. Connect the DC contactor auxiliary (status) contact to a second digital input.
5. Set the corresponding second [Digital Inx Sel] parameter (133...144) to "Fld Weak En".
6. Set the corresponding [Inversion In x] parameter (1276...1283 or 1387...1390) for the second digital input to "Enabled".

### *Inverting-fault Device Configuration*

1. Connect the inverting-fault device contact to a digital input.
2. Set the corresponding [Digital Inx Sel] parameter (133...144) to 14 - "Aux Fault".
3. Set the corresponding [Inversion In x] parameter (1276...1283 or 1387...1390) to 1 - "Enabled".

## Lifting/Torque Proving

TorqProve™ technology for PowerFlex DC drives is intended for applications where proper coordination between motor control and a mechanical brake is required. Before the mechanical brake is released, the drive checks motor armature continuity and verify proper motor control (torque proving). The drive also verifies that the mechanical brake has control of the load before drive control (brake proving) is released. After the drive sets the brake, motor movement is monitored to verify that the brake can hold the load.



**ATTENTION:** Loss of control in suspended load applications can cause personal injury and/or equipment damage. The drive or mechanical brake must always control the load. Parameters 1100 . . . 1114 are designed for lifting/torque proving applications. It is the responsibility of the engineer and/or end user to configure drive parameters, test any lifting functionality and meet safety requirements in accordance with all applicable codes and standards.

---

TorqProve can be operated with an encoder or encoderless. See “Attention” on page [307](#) before the use of TorqProve with no encoder.

TorqProve functionality with an encoder includes:

- Torque Proving (includes last torque measurement)
- Brake Proving
- Brake Slip (feature slowly lowers load if brake slips/fails)
- Float Capability (ability to hold full torque at zero speed)
- Micro-Positioning
- Fast Stop
- Speed Deviation Fault and Encoder Loss Fault.

Encoderless TorqProve functionality includes:

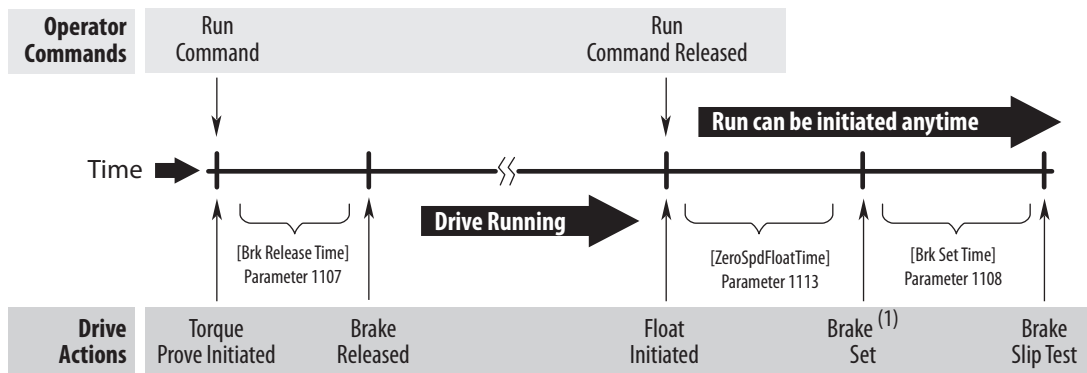
- Torque Proving
- Micro-Positioning
- Fast Stop
- Speed Deviation Fault.

---

**IMPORTANT** Brake Slip detection and Float capability (ability to hold load at zero speed) are not available in encoderless TorqProve.

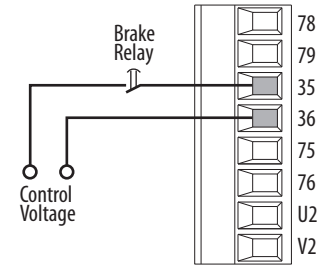
---

**Figure 86 - Torque Proving Flow Diagram**



All times between Drive Actions are programmable and can be made very small (i.e. Brake Release Time can be 0.1 seconds)

(1) For torque proving to function properly, a mechanical brake must be wired to a relay output.



**ATTENTION:** You must read this information before you use the TorqProve feature without an encoder.

Encoderless TorqProve must be limited to lifting applications where personal safety is not a concern. Encoders offer additional control and protection and must be used where personal safety is a concern. Encoderless TorqProve cannot hold a load at zero speed without a mechanical brake and does not offer additional protection if the brake slips/fails. Loss of control in suspended load applications can cause personal injury and/or equipment damage.

It is your responsibility to configure drive parameters, test any lifting functionality, and meet safety requirements in accordance with all applicable codes and standards. If encoderless TorqProve is desired, you must certify the safety of the application. To acknowledge that you have read this information and properly certified the encoderless application, parameter 414 [Fdbk Device Type] must be changed to "DC Tach" (2). If parameter 414 is set to "DC Tach," you can set bit 1 of parameter 1100 [Torq Prove Cfg] to "1" without causing a Type 2 alarm when lifting/torque proving is enabled (Par 1100, bit 0 = 1).

## Tuning The Motor For Torque Prove Applications

It is possible to use Autotune to tune the motor (see Tune the Current Regulator on page [102](#) and Tune the Speed Regulator on page [109](#)). However, it is recommended that the motor is disconnected from the hoist/crane equipment during the routine.



**ATTENTION:** Unexpected brake release can cause personal injury and/or equipment damage. To guard against an unexpected brake release, verify the digital output that is used for brake connections and/or programming. **The PowerFlex DC drive does not control the mechanical brake until TorqProve is enabled.** If the brake is connected to a digital output, it could be released. **If necessary, disconnect the digital output until wiring/programming can be completed and verified.**

---

## Crane Setup with Encoder/Resolver Feedback

These setup instructions assume the following.

- The drive and motor size have been carefully selected
- The drive parameters are at the factory defaults
- Programming is done with DriveTools™ SP or Connected Components Workbench® software
- Crane control is done via Run Forward / Run Reverse inputs
- The mechanical brake control is wired to Relay Output 2
- If a resolver is used, the drive must have a Resolver Feedback module installed
- The encoder/resolver is mounted on the back of the motor (not behind the gearbox)
- The encoder, if used, meets this specification: Quadrature differential (A, A-, B, B-), Line driver output, Minimum 1000 PPR 5V or 12V signals (12V preferred)



**ATTENTION:** Loss of control in suspended load applications can cause personal injury and/or equipment damage. The drive or mechanical brake must always control the load. Parameters 1100...1114 are designed for lifting/torque proving applications. It is the responsibility of the engineer and/or end user to configure drive parameters, test any lifting functionality and meet safety requirements in accordance with all applicable codes and standards.

---



## Set Up the Drive

Adjust parameter settings and enter nameplate data.

Parameter	Setting
<b>Braking Details</b>	
245 [Speed Ramp En]	1 "Enabled"
629 [Relay Out 2]	31 "TP Brake Cmd"
<b>Motor Nameplate Data</b>	
175 [Rated Motor Volt]	Motor nameplate voltage
179 [Nom Mtr Arm Amps]	Motor nameplate current
162 [Max Feedback Spd]	Motor nameplate speed
280 [Nom Mtr Fld Amps]	Motor nameplate field current
374 [Drv Fld Brdg Cur]	Drive Field Supply Rating (matches S14)
<b>Motor Control</b>	
241 [Spd Trq Mode Sel]	1 "Speed Reg"
<b>Maximum Speed</b>	
45 [Max Ref Speed]	Motor nameplate speed
<b>Drive Duty Rating</b>	
376 [MtrOvrd Type]	1 "Heavy Duty"
<b>Overload Speed</b>	
334 [MtrOvrd Speed]	0% (so no current derating is applied)
<b>Protection</b>	
479 [MtrOvrd Flt Cfg]	2 "Fault"
7 [Current limit]	200% (of P179 Nom Mtr Arm Amps)

## Motor Tuning Routines

Run the following three tests in the order listed. See Chapter 2 "Drive Start Up" starting on page [93](#) for details. If these tests have already been performed, proceed to Torque Prove Setup on page [311](#).

### Current Tune

This routine measures motor characteristics with the brake set (brake closed).

### Verify Motor Rotation and Speed Feedback Polarity

This test checks for correct motor armature and speed feedback device connections.

### Speed Tune

This routine gives better results if the connected equipment allows free motor rotation. This routine requires the mechanical brake to open and the motor to run.

If a "TorqPrv Spd Band" fault (F94) occurs during any of the motor tuning routines, see page [226](#) for a list of possible errors and actions.

*Speed Reference Setup*

1. Set the minimum speed.

Parameter	Setting
1 [Minimum Speed]	0.00

2. Set the maximum speed limits.

Parameter	Setting
2 [Maximum Speed]	Speed limit that is used during normal operation

3. Set the digital input functions.

Parameter	Setting
133 [Digital In1 Sel]	"Stop/CF" (2)
134 [Digital In2 Sel]	"Run Forward" (6)
135 [Digital In3 Sel]	"Run Reverse" (7)
136 [Digital In4 Sel]	"Enable" (1)
137 [Digital In5 Sel]	"Flt MicroPsn" (65)
138 [Digital In6 Sel]	"Not Used" (0)

4. Set the speed reference.

Set the DPI Speed Reference to the nominal operating speed.

Parameter	Setting
70 [Anlg In1 Sel]	"Off" (0)
323 [DPI P1 Select]	"Speed Ref A" (1)

5. Verify the speed reference in parameter 1329 [Speed Ref Source] = 1323.

6. Set the speed loop tuning.

Parameter	Setting
434 [Speed Reg BW]	20 R/S Defines the reactivity of the speed regulator. This value is used to calculate Kp and Ki gains.
433 [Total Inertia]	1.5 Secs This value can be increased or decreased depending on Speed regulator response.

*Torque Prove Setup*

Carefully perform the following steps in the order presented.

1. Enter the Torque Prove parameter settings.

Parameter	Setting
629 [Relay Out 2 Sel]	"TP Brake Cmd" (31)
1100 [Torq Prove Cfg]	Bit 0 "TP Enable" = 1

Once Torque Prove is activated, the drive is in alarm state.

2. Select the source of speed feedback.

Parameter	Setting
414 [Fdbk Device Type]	"Encoder" (1) - Verify that P169 [Encoder PPR] is set correctly.

3. Set the time to decrease motor torque during the Brake Slip test.

Drive Parameter	Setting
1104 [Torq Limit Slew]	10.000 Secs (Default)

4. Set the speed deviation.

Parameter	Setting
1105 [Speed Dev Band]	52.50 RPM (Default)

Increase this setting if the drive faults on F94 "TorqPrv Spd Band."

5. Set the speed deviation level.

Parameter	Setting
1106 [SpdBand Intgrtr]	60 ms (Default)

Increase this setting if the drive faults on F94 "TorqPrv Spd Band."

6. Set the brake release time.

Parameter	Setting
1107 [Brk Release Time]	100 ms (Default)

Increase or decrease this setting depending on the time that is required to open the brake.

7. Set the brake set time.

Parameter	Setting
1108 [Brk Set Time]	100 ms (Default)

Increase or decrease this setting depending on the time that is required to close the brake.

8. Set the allowable brake slip.

Parameter	Setting
1109 [Brk Alarm Travel]	1.00 (Default)

Sets the number of motor revolutions the motor is allowed to lower the load when a brake slip has been detected.

9. Set the brake slip definition.

Parameter	Setting
1110 [Brk Slip Count]	0.25 (Default)

Sets the number of encoder or resolver revolutions to define a brake slippage condition.

10. Set the brake float tolerance.

Parameter	Setting
1111 [Float Tolerance]	52.50 RPM

Sets the level at which the float timer starts counting.

11. Set the brake float time.

Parameter	Setting
1113 [ZeroSpdFloatTime]	5.000 Secs (Default)

Sets the time to maintain zero speed with brake open when the run command has been released.

The drive is now configured and Torque Prove for the mechanical brake control is activated. The load can now be applied.

*Optimize the Speed Loop Tuning*

You can now use DriveObserver to optimize the speed loop tuning. Use a 30 second time scaling on the X-axis. Use DriveObserver to configure the following traces.

Parameter	Setting
1008 [Spd Reg Fdbk]	Scaled to minimum and maximum speed limits
113 [Ramp Out]	Scaled to minimum and maximum speed limits
200 [Arm Current]	Scaled to current limit value
41 [Current Reg In]	Default scaling

Run the crane up and down under full load. Adjust acceleration and deceleration rates if necessary.

### *Troubleshooting Crane Setup with Encoder/Resolver Feedback*

The following faults commonly occur during drive commissioning.

#### F4 “AC Undervoltage”

- If the mains supply is still present, reduce the undervoltage level at P481 [UnderVolt Thresh].

#### F5 “Arm Overvoltage”

- Verify the parameter settings as stated in Set Up the Drive on page [309](#).

#### F94 “TrqProve Spd Band” (Speed deviation fault)

- This fault is only active when TorqProve is enabled.
- The speed loop tuning is incorrect. Increase P434 [Spd Reg BW] or P433 [Total Inertia]. If these values are too high, the regulator becomes unstable.
- P1008 [Spd Reg Fdbk] should follow P113 [Ramp Out] as closely as possible.
- The drive is going into current limit. The drive is undersized or acceleration / deceleration is set too fast.
- The brake is not opening. Check for faulty brake operation.

For more fault information, see Chapter 4 Troubleshooting on page [219](#).

## **Crane Setup - Encoderless**

These setup instructions assume the following.

- The drive and motor size have been carefully selected
- The drive parameters are at the factory defaults
- Programming is done with DriveTools SP or Connected Components Workbench® software
- Crane control is done via Run Forward / Run Reverse inputs
- The mechanical brake control is wired to Relay Output 2



**ATTENTION:** Loss of control in suspended load applications can cause personal injury and/or equipment damage. The drive or mechanical brake must always control the load. Parameters 1100...1114 are designed for lifting/torque proving applications. It is the responsibility of the engineer and/or end user to configure drive parameters, test any lifting functionality and meet safety requirements in accordance with all applicable codes and standards.

### Set Up the Drive

Adjust the parameter settings and enter nameplate data.

Parameter	Setting
<b>Braking Details</b>	
245 [Speed Ramp En]	1 "Enabled"
629 [Relay Out 2]	31 "TP Brake Cmd"
<b>Motor Nameplate Data</b>	
175 [Rated Motor Volt]	Motor nameplate voltage
179 [Nom Mtr Arm Amps]	Motor nameplate current
162 [Max Feedback Spd]	Motor nameplate speed
280 [Nom Mtr Fld Amps]	Motor nameplate field current
374 [Drv Fld Brdg Cur]	Drive Field Supply Rating (matches S14)
<b>Motor Control</b>	
241 [Spd Trq Mode Sel]	1 "Speed Reg"
<b>Maximum Speed</b>	
45 [Max Ref Speed]	Motor nameplate speed
<b>Drive Duty Rating</b>	
376 [MtrOvrd Type]	1 "Heavy Duty"
<b>Overload Speed</b>	
334 [MtrOvrd Speed]	0%
<b>Protection</b>	
479 [MtrOvrd Flt Cfg]	2 "Fault"
7 [Current limit]	200% (of P179 Nom Mtr Arm Amps)

### Motor Tuning Routines

Run the following three tests in the order listed. See Chapter 2 "Drive Start Up" starting on page 93 for details. If these tests have already been performed, proceed to Torque Prove Setup.

#### Current Tune

This routine measures motor characteristics with the brake set (brake closed).

#### Verify Motor Rotation and Speed Feedback Polarity

This test checks for correct motor armature and speed feedback device connections.

#### Speed Tune

This routine gives better results if the connected equipment allows free motor rotation. This routine requires the mechanical brake to open and the motor to run.

If a "TorqPrv Spd Band" fault (F94) occurs during any of the motor tuning routines, see page 226 for a list of possible errors and actions.

*Speed Reference Setup*

1. Set the minimum speed.

Parameter	Setting
1 [Minimum Speed]	0.00

2. Set the maximum speed limits.

Parameter	Setting
2 [Maximum Speed]	Speed limit that is used during normal operation

3. Set the digital input functions.

Parameter	Setting
133 [Digital In1 Sel]	"Stop/CF" (2)
134 [Digital In2 Sel]	"Run Forward" (6)
135 [Digital In3 Sel]	"Run Reverse" (7)
136 [Digital In4 Sel]	"Enable" (1)
137 [Digital In5 Sel]	"Flt MicroPsn" (65)
138 [Digital In6 Sel]	"Not Used" (0)

4. Set the speed reference.

Set the DPI Speed Reference to the nominal operating speed.

Parameter	Setting
70 [Anlg In1 Sel]	"Off" (0)
323 [DPI P1 Select]	"Speed Ref A" (1)

5. Verify the speed reference in parameter 1329 [Speed Ref Source] = 1323.

6. Set the speed loop tuning.

Parameter	Setting
434 [Speed Reg BW]	20 R/S Defines the reactivity of the speed regulator. This value is used to calculate Kp and Ki gains.
433 [Total Inertia]	1.5 Secs This value can be increased or decreased depending on Speed regulator response.

*Torque Prove Setup*

Carefully perform the following steps in the order presented.

1. Enter the Torque Prove parameter settings.

Parameter	Setting
629 [Relay Out 2 Sel]	"TP Brake Cmd" (31)
1100 [Torq Prove Cfg]	Bit 0 "TP Enable" = 1 Bit 1 "Encoderless" = 1 Bit 5 "BrkSlipEncls" = 1

2. Select the source of speed feedback.

Parameter	Setting
414 [Fdbk Device Type]	"DC Tach" (2)

3. Set the speed deviation.

Parameter	Setting
1105 [Speed Dev Band]	200 RPM

This setting can be lowered once the system has been tuned. The lower this value, the faster the protection.

4. Set speed deviation level.

Parameter	Setting
1106 [SpdBand Intgrtr]	200 ms

This setting can be lowered once the system has been tuned. The lower this value, the faster the protection.

5. Set brake float tolerance.

Parameter	Setting
1111 [Float Tolerance]	25 RPM

Determines the level where the mechanical brake sets in encoderless mode.

The drive is now configured and Torque Prove for the mechanical brake control is activated. The load can now be applied.

*Optimize the Speed Loop Tuning*

You can now use DriveObserver to optimize the speed loop tuning. Use a 30 second time scaling on the X-axis. Use DriveObserver to configure these traces:

Parameter	Setting
1008 [Spd Reg Fdbk]	Scaled to minimum and maximum speed limits
113 [Ramp Out]	Scaled to minimum and maximum speed limits
200 [Arm Current]	Scaled to current limit value
41 [Current Reg In]	Default scaling

Run the crane up and down under full load. Adjust acceleration and deceleration rates if necessary.



*Troubleshooting Crane Setup - Encoderless*

The following faults commonly occur during drive commissioning.

## F4 “AC Undervoltage”

- If the mains supply is still present, reduce the undervoltage level at P481 [UnderVolt Thresh].

## F5 “Arm Overvoltage”

- Verify the parameter settings as stated in Set Up the Drive on page [314](#).

## F94 “TrqProve Spd Band” (Speed deviation fault)

- This fault is active only when TorqProve is enabled.
- The speed loop tuning is not correct. Increase P434 [Spd Reg BW] or P43 [Total Inertia]. If these values are too high, the regulator becomes unstable.
- P1008 [Spd Reg Fdbk] should follow P113 [Ramp Out] as closely as possible.
- The drive is going into current limit. The drive is undersized or acceleration / deceleration is set too fast.
- The brake is not opening. Check for faulty brake operation.

For more fault information, see Chapter 4 Troubleshooting on page [219](#).

## Manually Tuning the Speed Regulator for Firmware Revision 6.001 and Later

The calculation of Speed Loop gains was simplified in firmware revision 6.001 and later so that they are similar to other PowerFlex Architecture class drives. The value of parameter 434 [Spd Reg BW] now automatically determines the Speed Regulator gains (Kp and Ki). The Speed Regulator gains can still be entered manually by setting P434 [Spd Reg BW] to 0. There is also a separate bandwidth parameter for bypass mode, P448 [Spd Reg BW Bypass]. This parameter affects P459 [Spd Reg Kp Bypass] and P460 [Spd Reg Ki Bypass]. Follow these steps when converting to revision 6.001 and later from an earlier firmware revision:

1. Before installing PowerFlex DC firmware revision 6.001 or later, save the current drive-configuration data by using the HIM CopyCat function, or DriveExecutive™ or Connected Components Workbench software.
2. Record the following parameter values:

Parameter	Value
87 [SpdReg Kp Pct]	
88 [SpdReg Ki Pct]	
1013 [Torque Const]	
1030 [Spd Tune Inertia]	
1031 [Spd Tune Friction]	

3. Download the PowerFlex DC firmware revision 6.001 or later. A F100 “EEPROM Error” fault occurs and all parameters are reset to the factory default values.
4. Download the saved HIM CopyCat or DriveExecutive configuration data to the drive. An error message/messages appears due to the change in major revision number.
5. Acknowledge the error/fault messages by selecting OK (DriveTools™ SP or Connected Components Workbench® software) or pressing the Esc key (HIM).
6. Verify that P1013 [Torque Const] equals the value that you recorded in the table in [step 2](#).
7. See the table in [step 2](#) to enter values for these parameters:
  - Enter the value that is recorded in table 2 for Par 1030 [Spd Tune Inertia] into Par 1014 [Inertia]
  - Enter the value that is recorded in table 2 for Par 1031 [Spd Tune Friction] into Par 1015 [Friction]
8. Verify that P1034 [Spd Reg Kp Pct] equals the value that is recorded in the table in [step 2](#) for P87 [Spd Reg Kp Pct]. If the values are not equal, P434 [Spd Reg BW] can be adjusted to make P1034 [Spd Reg Kp Pct] the same as the original value for P87 [Spd Reg Kp Pct].
9. Set P434 [Spd Reg BW] = 0 and adjust P88 [Spd Reg Ki Pct] until P1035 is equal to the expected value.
10. Verify that P1035 [Spd Reg Ki Pct] equals the value that is recorded in the table in [step 2](#) for P88 [Spd Reg Ki Pct].

If completed properly, the Speed Regulator performance is now the same as it was in the previous firmware revision. If desired, the Speed Regulator autotune (see page [109](#)) can be executed to have the drive automatically determine the Speed-regulator gain values.

A summary of the basic relationships between Speed Regulator gains, bandwidth, and tuning for firmware revision 6.001 and later is shown here.

Damping (Par 436)	$z$
Inertia (P433)	$J$
Bandwidth (Par 434)	$BW = Kp / J$
Proportional Gain (Par 87)	$Kp = BW * J$
Integral Gain (Par 88)	$Ki = (BW * Kp) / (4 * z^2)$
Load Time Constant	$Tc = Kp / Ki = (4 * z^2) / BW = 1 / Wld$

## Multiple Motor Applications

The PowerFlex DC drive can be used in multiple motor applications. The motors can be configured for parallel or series connections.

---

**IMPORTANT** The PowerFlex DC drive is not designed for use with resistive or magnetic loads.

---

### Considerations for Multiple Motors Connected in Parallel

Follow this guidance when using PowerFlex DC drives in multiple motor applications where the motors are connected in parallel:

- The horsepower, armature voltage, armature current, and rated speed ratings of all motors that are used in the application must match.
- Parameter 179 [Nom Mtr Arm Amps] must be equal to the sum of all motor armature current ratings.
- Install armature circuit overloads on each motor that is used in the application. The drive monitors the total current output for overload. However, the drive cannot detect an individual motor overload condition for motors connected in parallel.
- The motor fields must be connected in parallel from the drive output source.
- It is highly recommended that you install a field loss relay on each motor field.
- Motor over speed protection is required.

### Considerations for Multiple Motors Connected in Series

Follow this guidance when using PowerFlex DC drives in multiple motor applications where the motors are connected in series:

- The horsepower, armature voltage, armature current, and rated speed ratings of all motors that are used in the application must match.
- The sum of the nameplate armature voltage ratings for all motors cannot exceed the maximum rated drive output voltage.
- The sum of the nameplate armature voltage ratings for all motors must be equal to the armature voltage set in parameter 175 [Rated Motor Volt].
- The motor fields must be connected in parallel from the drive output source.
- It is highly recommended that you install a field loss relay on each motor field.
- Monitor the individual motor voltages for balance.
- Motor over speed protection is required.

The current and speed loop Autotune functions cannot be used with multiple motors. Complete the Manually Tuning the Speed Regulator for Firmware Revision 6.001 and Later procedures on page [317](#).

## Parameter 21 [Min Firing Angle] Configuration

Parameter 21 [Min Firing Angle] allows for the adjustment of the “Alpha” firing angle limit from the default of 25° to as low as 5°. The firing angle is the angle (point) in the sine-wave where the SCR turns on. The earlier in the sine-wave that the SCR turns on, the more power is delivered to the motor. When the regulator demands more current to increase the motor speed, or to maintain the speed under an increased load, the regulator decreases the firing angle to deliver more power to the motor. When the motor is spinning, it acts as a generator and it develops a voltage that is opposite to the applied voltage from the power module CEMF (Counter Electromotive Force). To regulate the same current as speed is increased, the regulator reduces the firing angle, which applies more voltage to the motor. And the motor speed, low line voltage (either from the source or in the form of a soft line) necessitates a reduction in the firing angle to deliver proper regulator control of the motor. If the firing angle reaches the minimum limit, then the drive regulator is no longer effective when it “requests” more power to be delivered to the motor from the power module. The drive does not deliver the required power to the motor and the drive is unable to meet the needs of the application. The actual firing angle can be dynamically monitored in parameter 165 [Firing Angle]. If there is a concern whether firing angle limit is limiting the drive performance, it is recommended that you trend parameter 165 [Firing Angle] over a long enough period that represents the typical drive loading in the future. If the minimum firing angle is reached while monitoring, it is recommended that you reduced the angle in 5° increments. Confirm the adjustment with loading profiles that are typical between adjustments.

Do not reduce the firing angle limit too aggressively. Only reduce the firing angle to a value necessary to run the motor at full speed and operate with low line (-10%) and overload conditions that are required of the drive.

For regenerative drives, inverting fault protection must be provided in the form of a circuit breaker or fuses. Once an SCR turns on and starts to conduct current, it stays on (latches) until the incoming AC line reverse biases the SCR. If the AC line drops too low relative to the motor terminal voltage during regeneration, SCRs normally commutated off, remain on, and cause an inverting fault. The inverting fault protection is necessary to control the maximum current through the motor and power bridge during the fault.

## PID Function

The PID function is used to increase or reduce the reference signal output to the speed or current regulator of the drive. The PID function can be used for nip-roll, winder/unwinder, roll doctor/salvage machine, pump, and extruder pressure control and extruder temperature-control applications. (See the complete “PID Control” block diagram on page [378](#).)

These examples are included for configuring the following applications:

- Speed winder with a load cell and tension control
  - ❑ Line speed signal (see Configure a Line Speed Signal on page [321](#))
  - ❑ Closed loop dancer / load cell feedback (see Configure the Feedback Signal in the Follower Drive/Drives on page [323](#))
  - ❑ Tension set point (see Configure the Tension Set Point Signal in the Follower Drive/Drives on page [324](#))
- Torque winder with a load cell and tension control
  - ❑ Line speed signal (see Configure a Line Speed Signal on page [321](#))
  - ❑ Closed loop dancer / load cell feedback (see Configure the Feedback Signal in the Follower Drive/Drives on page [323](#))
  - ❑ Tension set point (see Configure the Tension Set Point Signal in the Follower Drive/Drives on page [324](#))

### Configure a Line Speed Signal

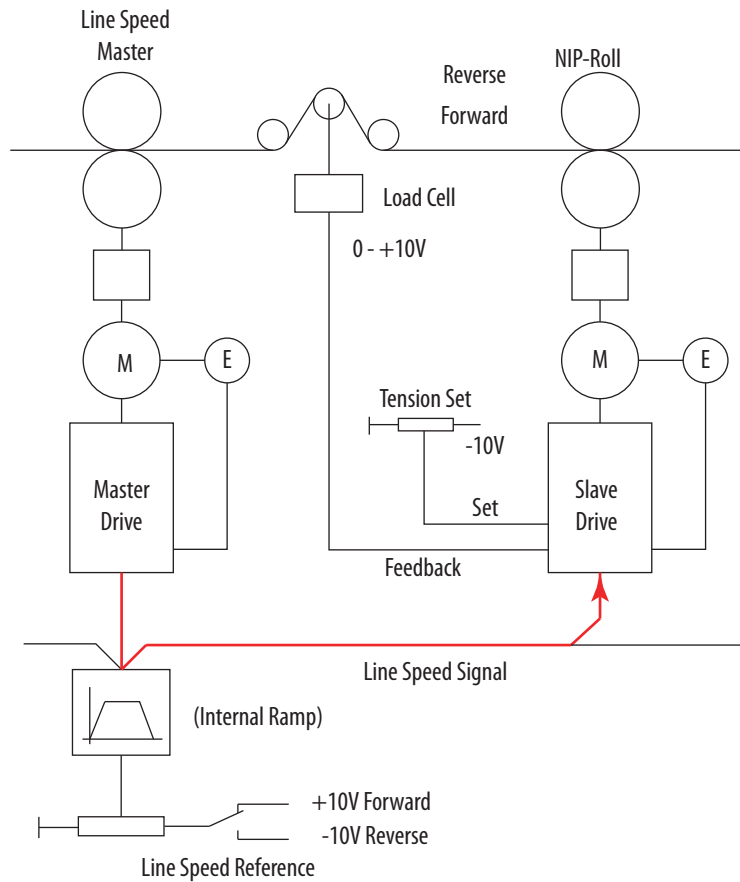
The line speed signal is the main reference for the speed or current regulator in the follower drive/drives.

In the Master drive:

- Configure an analog output for the main speed reference (1 “Spd Ref Out”)

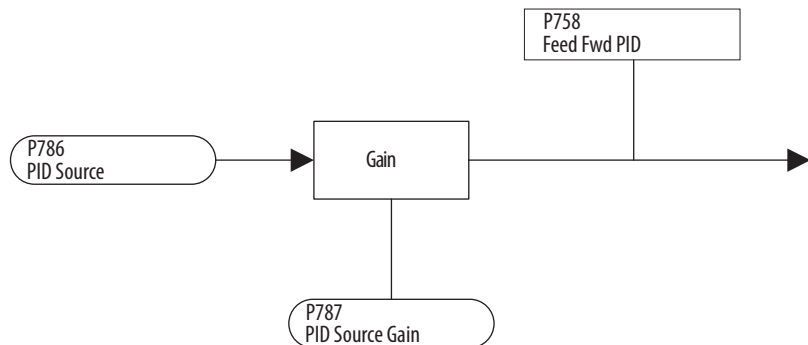
In the Follower drive:

- Set Par 80 [Anlg In3 Sel] to 12 “UserDefined0”
- Set Par 786 [PID Source] to 19 “UsrDefined0” (Par 503).



In addition you can configure the following:

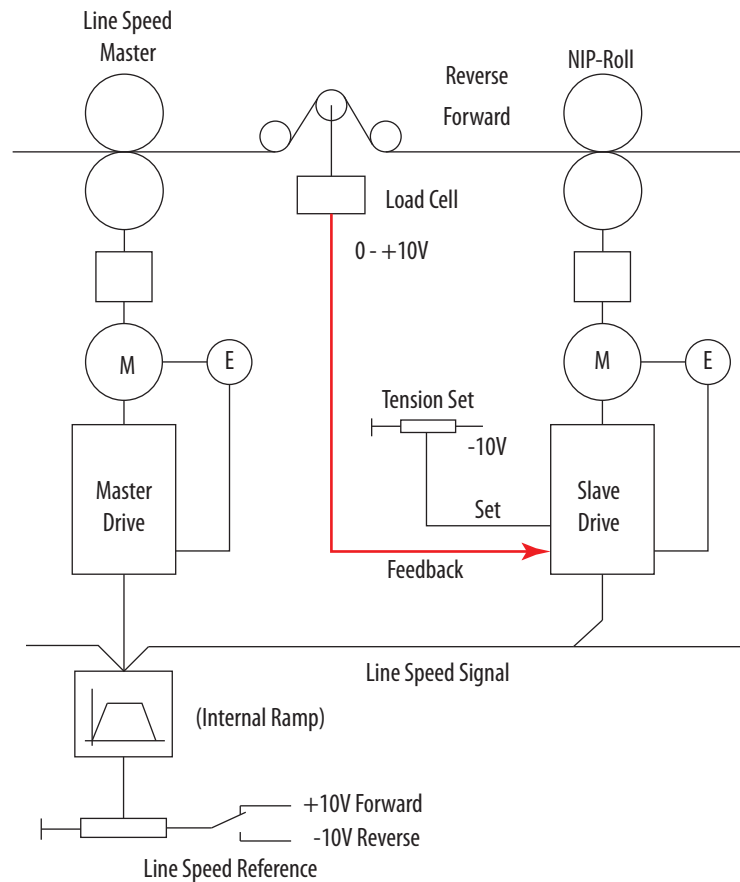
- Enter the gain for the feed-forward signal in Par 787 [PID Source Gain]
- Monitor the feed-forward signal after the gain is applied in Par 758 [Feed Fwd PID]



## Configure the Feedback Signal in the Follower Drive/Drives

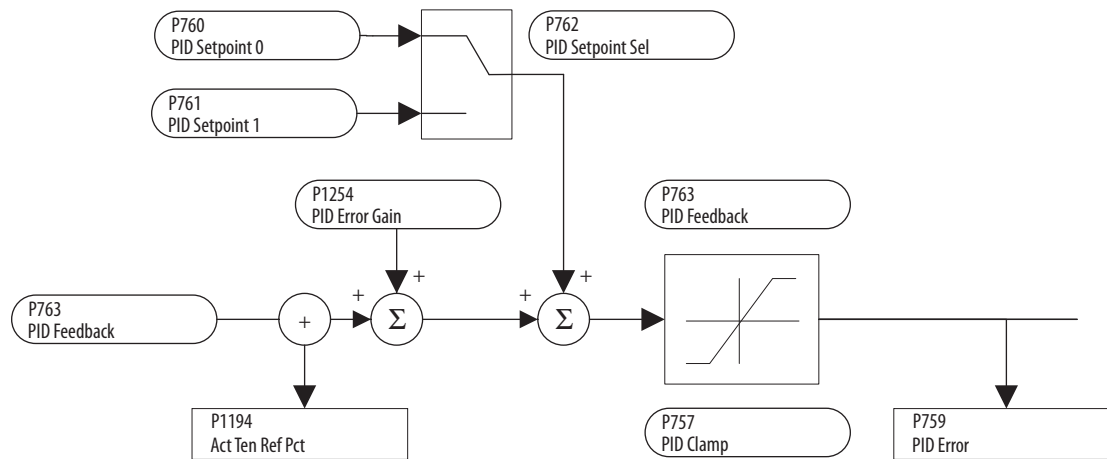
The feedback signal originates from a load cell or a closed loop dancer and is input to the drive via an analog input.

- Set Par 70 [Anlg In1 Sel] to 19 “PID Feedback”.



In addition you can configure the following:

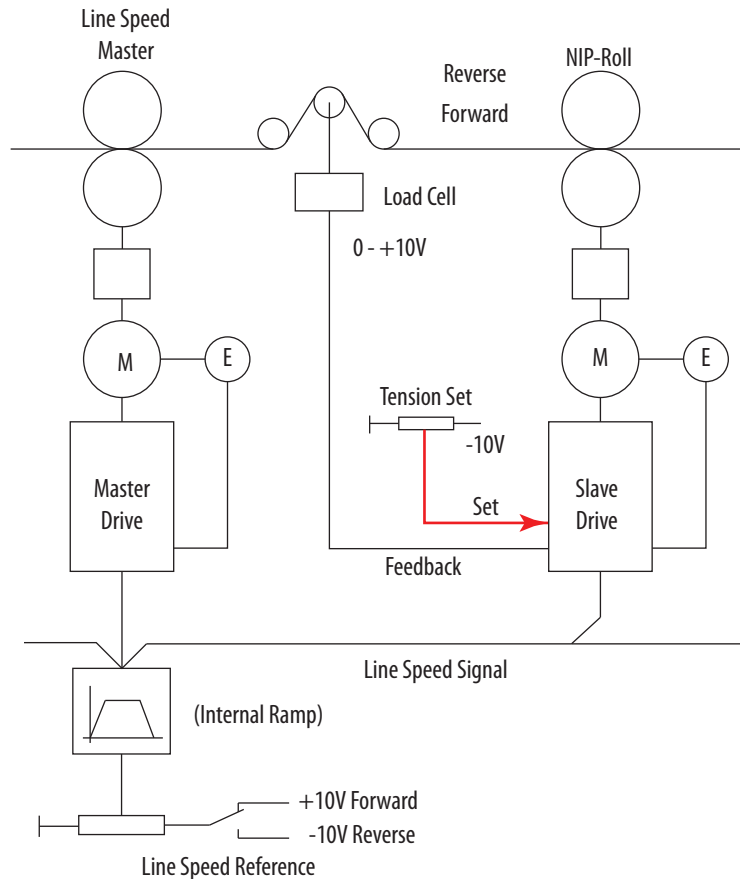
- Par 763 [PID Feedback] contains the raw feedback counts from the analog input signal that is received from the transducer position (dancer) or tension (load cell)
- Monitor the tension set point for a torque winder application in Par 1194 [Act Ten Ref Pct]
- Configure the PID feedback gain in Par 1254 [PID Error Gain]
- Limit the PID correction error using Par 757 [PID Clamp]
- Monitor the actual error input to the PI and PD blocks in Par 759 [PID Error]



### Configure the Tension Set Point Signal in the Follower Drive/Drives

Configure the initial tension for the application in the Follower drive/drives:

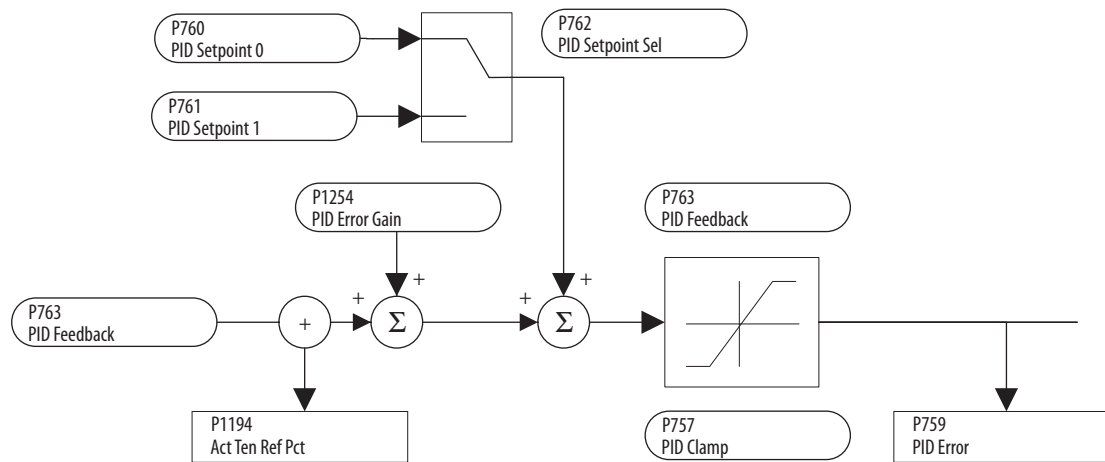
- Set Par 75 [Anlg In2 Sel] to 17 “PID Setpt 0”





In addition, configure the following in the Follower drive/drives:

- Verify that Par 762 [PID Setpoint Sel] is set to 0 “Setpoint 0”



## Reference Control

The drive speed command can be obtained from any of these sources:

- Digital inputs that are configured as speed selects
- A digital input that is configured for “Auto/Manual”
- Reference Select bits of a command word (see Communication Configurations on page [240](#) for more information)

The actual source-parameter number is displayed in parameter 1329 [Speed Ref Source] with any modifications indicated in parameter 1330 [Spd Ref Sel Sts].

### “Auto” Speed Sources

Analog input 1 is the default auto source for a command reference when these selections are configured:

- Parameter 70 [Anlg In1 Sel] (analog input 1) is set to “Speed Ref A”
- All speed select digital inputs are open or not programmed

If any of the speed-select digital inputs are closed, the drive uses other parameters as the auto-speed command source.

### “Manual” Speed Sources

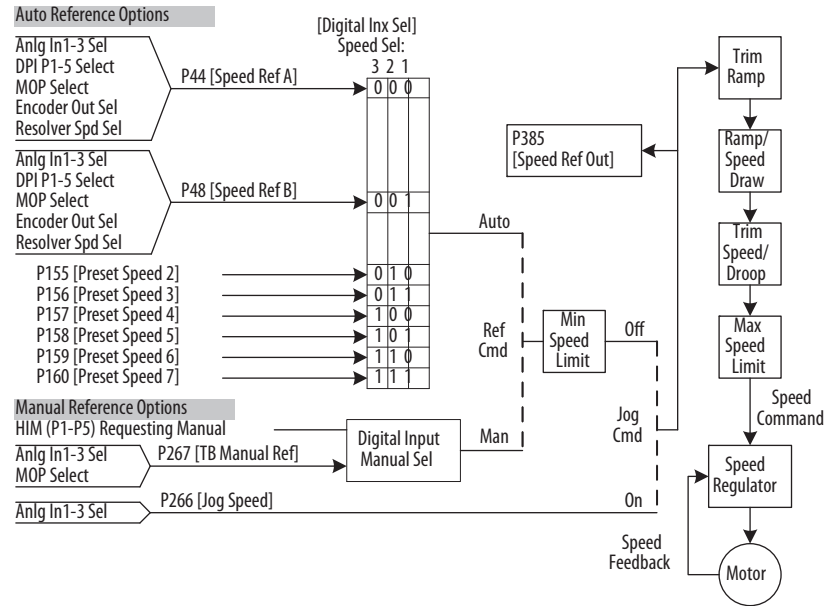
The manual source for the speed command to the drive is one of these options:

- A HIM request for manual control (see ALT Functions on page [282](#))
- Control terminal block (analog input or MOP) if a digital input is programmed to “Auto/Manual”

## Speed Source Changes

The selection of the active speed reference can be made through the digital inputs, DPI command, Jog button, or Auto/Manual HIM operation.

**Figure 87 - Speed-reference Selection Chart**



## Torque Reference Source

The torque reference can only be supplied by an analog input, the HIM, or a network reference. You cannot switch between available sources while the drive is running. Digital inputs that are programmed as “Speed Sel 1, 2, 3” and the HIM Auto/Manual function (see [Figure 87](#) on page 326) do not affect the active torque reference. The HIM, however, cannot acquire Manual Reference control while it is configured to supply the torque reference.

## Auto/Manual Examples

*PLC = Auto, HIM = Manual*

A PLC controls a process when the drive is in Auto mode, but requires manual control from the HIM during set-up. The PLC issues the speed reference through a communication module that is installed in the drive (Port 5). Therefore, parameter 1327 [DPI P5 Select] is set to “Speed Ref A” with the drive running from the Auto source.

### Acquire Manual Control

- Press ALT then Auto/Man on the HIM. When the HIM acquires manual control, the drive speed command comes from the HIM speed control keys.

### **Release to Auto Control**

- Press ALT then Auto/Man on the HIM again. When the HIM releases manual control, the drive speed-command returns to the PLC.

*PLC = Auto, Terminal Block = Manual*

A PLC controls a process when the drive is in Auto mode, but requires manual control from an analog potentiometer that is wired to the drive terminal block. The PLC issues the auto speed reference through a communication module that is installed in the drive (Port 5). Therefore, parameter 1327 [DPI P5 Select] is set to “Speed Ref A” with the drive running from the Auto source. Because analog input 2 issues the manual speed reference, parameter 75 [Anlg in2 Sel] is set to “TB Man Ref”. The value of analog input 2 can be viewed in parameter 267 [TB Manual Ref]. To switch between Auto and Manual, parameter 136 [Digital In4 Sel] is set to “Auto/ Manual”.

### **Acquire Manual Control**

- Close the digital input. With the input closed, the speed command comes from the pot.

### **Release to Auto Control**

- Open the digital input. With the input open, the speed command returns to the PLC.

### *Auto/Manual Notes*

1. Manual control is exclusive. If a HIM or terminal block takes manual control, no other device can take manual control until the Him or terminal block releases control.
2. If a HIM has manual control and power is removed from the drive, the drive returns to Auto mode when power is reapplied.

## Resolver Cable Balance Tuning Test

At drive power-up, the resolver feedback module automatically performs cable length compensation and resonance tuning for the attached resolver and cable. The status of the cable length compensation and resonance are identified in parameter 426 [Resolver Status], bit 3 “CableCompSts” and 10 “HardwareSts,” respectively. The cable balance-tuning test can be performed to attempt the enhancement of the resolver performance. This optional test takes approximately 10 seconds to complete successfully.



**ATTENTION:** The motor rotates during this tuning procedure. Hazard of personal injury exists due to motor shaft rotation and/or machinery motion.

### Performing the Cable Balance Tuning Test



**WARNING:** Remove power before you remove or make cable connections. When you remove or insert a cable connector with power applied, an electrical arc may occur. An electrical arc may cause these system events, which can cause personal injury or property damage.

- An erroneous signal to system field devices, which can cause unintended machine motion
- An explosion in a hazardous environment

Electrical arcing causes excessive wear to contacts on both the module and its mating connector. Worn contacts can create electrical resistance.

1. Remove and lock-out all incoming power to the drive.
2. Verify that the resolver feedback module has been correctly installed and wired in the drive according to the PowerFlex DC Drive Resolver Feedback Module Installation Instructions, publication [20P-IN071](#).
3. Apply power to the drive.
4. Verify that Par 422 [Fdbk Option ID] displays the appropriate module ID for the resolver feedback-module board that is installed in the drive.
5. Verify that the following parameters have been properly configured:
  - Parameter 423 [Reslvr Type Sel] (see page [139](#))
  - Parameter 424 [Reslvr Spd Ratio] (see page [139](#))
  - Parameter 425 [Resolver Config] (see page [140](#))
6. Set Par 414 [Fdbk Device Type] to 3 “Armature” (armature voltage feedback).
7. Run the drive at 50% of base speed (or at least 750 rpm when 10-bit resolution that is selected. Higher resolutions and x2, x5 resolvers have lower minimum speeds).
8. Verify that Par 426 [Resolver Status], bit 2 “ReslvrMinSpd” is not set.
9. Set Par 431 [Reslvr CableBal] to 1 “On” (this parameter automatically resets to zero after tuning is completed).

10. Monitor Par 426 [Resolver Status], bits 0 “CableBalSts” and 1 “CableBalTest”. The initial test typically takes approximately 10 seconds to complete successfully (subsequent tests more quickly). However, if the cable balance algorithm is unable to adapt to the cable, the test could be active for up to 60 seconds.
  - For bit 0 “CableBalSts”: 1 = the cable is not balanced or the test is active, and 0 = the cable is balanced (tuned).
  - For bit 1 “CableBalTest”: 0 = the cable balance (tuning) test is completed, and 1 = the cable cannot be balanced or the motor was not at minimum speed during the test.
11. Stop the drive. If the cable balance test fails, verify that the resolver is properly configured and connected to the drive. Repeat the test after addressing any issues.
12. Reconfigure Par 414 [Fdbk Device Type] to 4 “Resolver”.

## Resolver Type Selection

The following table provides a description and related attributes for the resolver types compatible with the PowerFlex DC drive and resolver feedback module. Where possible, specific compatible resolver models have been identified. Additional options are available for this parameter when a resolver with attributes that match is used (identified by the option “Resolver xx”).

**Table 93 - Resolver Type Attributes**

Par 423 [Reslvr Type Sel] Option	Resolver Catalog Numbers (Manufacturer) <sup>(1)</sup>	Par 424 [Reslvr Spd Ratio]	Carrier Frequency	Input Voltage	Transformer Ratio	Feedback Amp Gain	Power Amp Voltage
1 “2014x1/AMCI”	800123-R, -1R, -2R (Rel) TS-2014N181E32 (Tam) TS-2087N1E9 (Tam) TS-2087N11E9 (Tam) R11X-C10/7 (Adv)	x1	2381	26	0.4538	0.5	45
2 “T2014x2/2087”	800123-S, -1S, -2S (Rel) TS-2014N182E32 (Tam) TS-2087N12E9 (Tam) TS-2087N2E9 (Tam)	x2	2381	26	0.4538	0.5	45
3 “T2014x5/2087”	800123-T, 1T, 2T (Rel) TS-2014N185E32 (Tam) TS-2087N5E9 (Tam)	x5	2381	26	0.4538	0.5	45
4 “Resolver 04”	–	x2	4000	8	0.25	0.92	14
5 “Resolver 05”	–	x2	9300	22	0.5	0.5	45
6 “Resolver 06”	–	x1	4000	5	0.5	0.92	14
7 “Resolver 07”	–	x1	7000	4.25	0.4706	0.92	14
8 “Resolver 08”	–	x1	2500	12	0.5	0.5	45
9 “Resolver 09”	–	x2	4000	8	0.25	0.92	14
10 “Resolver 10”	–	x2	9300	15.5	0.5013	0.5	45
11 “Resolver 11”	–	x2	2500	7	1.7	0.5	45
12 “Resolver 12”	–	x2	9300	22	0.5	0.5	45
13 “Resolver 13”	–	x1	2000	6.36	0.5	0.92	14
14 “Resolver 14”	–	x1	6500	8	0.5	0.5	14
15 “Resolver 15”	–	x1	6500	8	0.5	0.5	14

(1) Abbreviations in this column indicate the following resolver manufacturers: Adv = Advanced Micro Controls, Inc. (AMCI), Rel = Reliance (-x = foot mounted, -1x = foot mounted, double shaft, -2x = flange-mounted), Tam = Tamagawa.

## Scale Blocks

The six individually configurable Scale Blocks let you link or rescale dissimilar parameter types (for example, integer vs. real) by using these functions:

- Multiply
- Divide
- Maximum and minimum limits
- input and output offsets
- absolute value

See Scale Block 1 block diagram for an example.

---

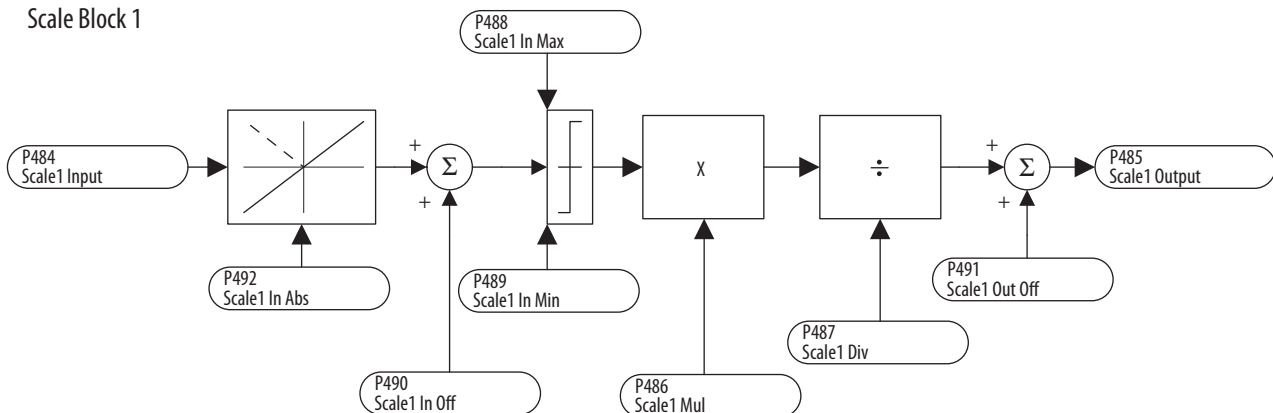
**IMPORTANT** The Scale Blocks functions are executed sequentially in the background, which can cause a delay in processing data between the input and output values. The amount of delay is dependent on the application.

---

The following rules apply to Scale Blocks:

- All input [Scale $x$  Input] and output [Scale $x$  Output] values are specified as a parameter number (not parameter values).
- Both Sink (read/write) and Source (read only) parameters can be used as input values ([Scale $x$  Input]).
- Only Sink (read/write) parameters can be used as the output value ([Scale $x$  Output]).
- Configuration parameters (parameters that can be changed only while the drive is stopped) can be used as the output value ([Scale $x$  Output]). However, any value that is written to a configuration parameter does not take effect in the drive until it is stopped.
- The output value is truncated to a whole number when different parameter types are used. For example, a real input value of 54.97% becomes an integer output value of 54 rpm.
- Dividing by zero does not cause an error, but results in an output value of zero.
- Turning off (setting = "0") the input parameter or changing the output parameter number does not reset or change the original output value. In other words, the output parameter remains at the last value written.

Scale Block 1



## Link Parameters Via the Scale Block Parameters

You can enter most parameter values directly. However, certain parameters can be “linked” by using the Scale Block parameters so the value of one parameter becomes the value of another.

For example, the value of an analog input 1, parameter 70 [Anlg In1 Sel], can be linked to parameter 660 [Accel Time 1]. Follow these steps to link parameters.

1. Set parameter 70 [Anlg In1 Sel] to 12 “UserDefined0”.
2. Set parameter 484 [Scale1 Input] to “503” (the parameter number of [UserDefined0]).
3. Set parameter 485 [Scale1 Output] to “660” (the parameter number of [Accel Time 1]).

Rather than entering an acceleration time via the HIM, this link allows the value to change by varying the analog signal, providing additional flexibility for certain applications. Test this functionality for the desired response before applying to an application.

## SCR Diagnostic Tests

Two SCR diagnostic functions are available; (1) Open SCR, and (2) Shorted SCR. Each test is run to identify which SCR or SCR pair has failed, including multiple SCR failures. However, if the drive cannot determine the specific shorted SCR or SCR pair, a shorted SCR (b15) is indicated in Par 214 [SCR Diag Status] and bits 0...11 remain off (0). Each diagnostic function can be enabled/disabled independently (default is disabled) via parameter 213 [SCR Diag Test En] and each operate after the drive is started. Typically, enable the SCR diagnostic functions when a problem is suspected.

When enabled, the Shorted SCR test pulses each SCR/pair immediately after a Start command (and the contactor is closed). The test results in a short delay before controlling the motor. If a shorted SCR is detected, a non-configurable fault is generated.

The Open SCR test monitors voltage and/or current and uses these adjustable parameters to determine when and if to initiate a fault or alarm:

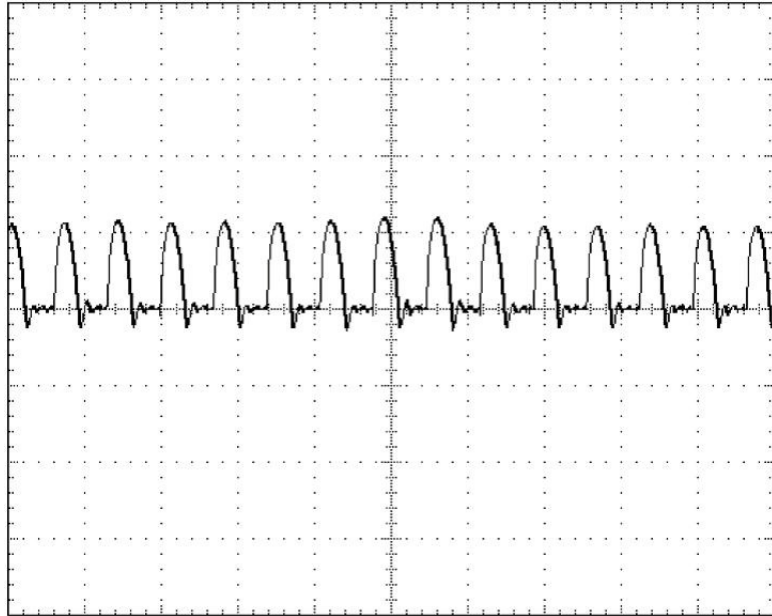
- 215 [OpenSCR WarnLvl]
- 217 [OpenSCR Threshold]
- 218 [OpenSCR Trip Lvl]

You can configure parameter 216 [OpenSCR Flt Cfg] to indicate a fault or an alarm that is based on the Open SCR test results.

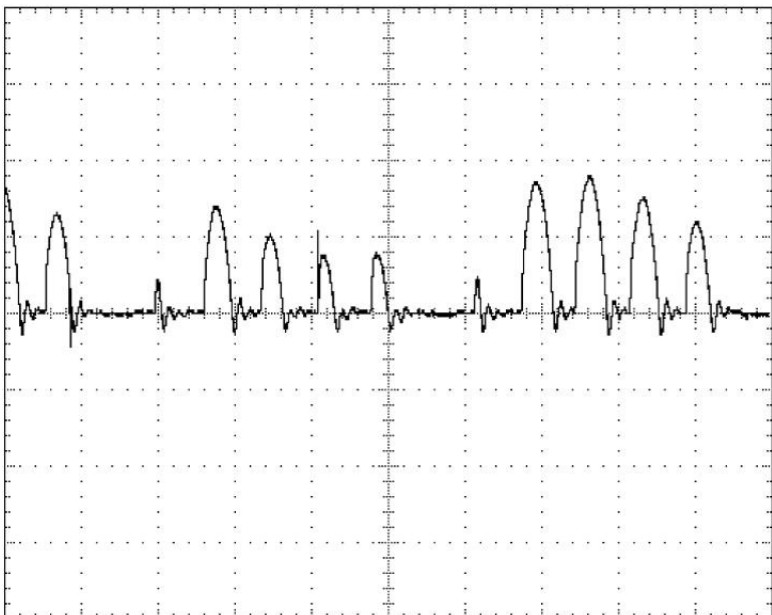
Parameter 214 [SCR Diag Status] shows which SCR(s) were detected as failed (open or shorted).

## Open SCR Test

Under normal drive operation, the load that each SCR carries is relatively equal, as shown in this image.



If one or more SCRs fail to turn on, a unique pattern of insufficient or missing current-pulses results, as shown in this image.



Open SCR diagnostics detects SCRs that are not conducting by analyzing the level of current produced by each SCR pair firing. If an SCR(s) consistently fails to produce current at a level approximately equal to other SCRs that fired, the drive concludes that an open SCR has occurred.



The Open SCR diagnostic test calculates the percentage deviation of current feedback for each pair of SCRs from the average current feedback. The percent deviation must exceed the value set for Par 216 [OpenSCR Threshold] before the test proceeds to the next part of the diagnostic. In the next part, deviations from the average current are accumulated over time to eliminate transient effects from the calculation. When the deviations reach the value of Par 218 [OpenSCR Trip Lvl], an open SCR condition is annunciated based on Par 216 [OpenSCR Flt Cfg]. The open SCR(s) are indicated in Par 214 [SCR Diag Status].

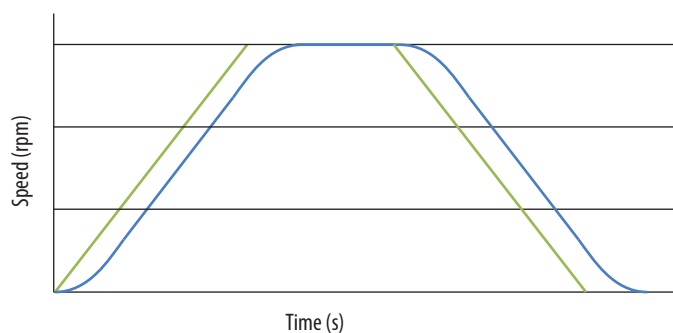
You can configure the drive to indicate a warning that SCR operation is imbalanced before a fault is generated. This warning is only indicated in Par 214 [SCR Diag Status], bit 13 “OpenSCR Warn”. To configure the drive to indicate a warning before a fault, set Par 215 [OpenSCR Warn Lvl] less than Par 218 [OpenSCR Trip Lvl]. To avoid nuisance open SCR events, such as an unbalanced AC supply line, use these parameters to increase the tolerance to the conditions that can trigger the event.

## Shorted SCR Test

Once enabled, the shorted SCR test executes each time that the drive is started. This test introduces a delay of a few seconds before controlling the motor. If a shorted SCR is detected, a non-configurable fault (F89 [Shorted SCR]) is generated and also indicated in Par 214 [SCR Diag Status].

## S-curve Configuration

To enable S-shaped ramp (S-curve) operation in the drive, set Par 18 [Ramp Type Select] to 1 “S shaped.” When S-curve operation is enabled, it allows for a smoother change in speed than a linear ramp.



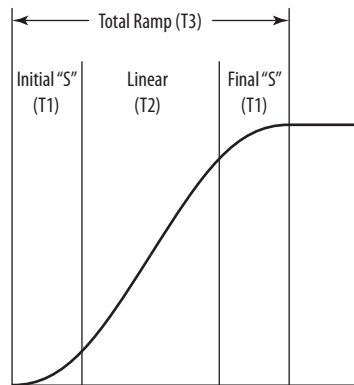
When S-curve is added to the ramp, the total length of time to perform a speed change increases. When accelerating, the S-curve does not exceed the maximum acceleration set by parameters 24 and 660 [Accel Time x]. Likewise, when decelerating, the S-curve does not exceed the maximum deceleration set by parameters 32 and 662 [Decel Time x]. When the S-curve times are much smaller (<20%) than the linear acceleration times, the speed profile is similar to a linear ramp (slightly delayed). As S-curve times are increased, more of the speed profile is spent in the “s” (non-linear) and less in the linear acceleration section. When s-curve and linear ramp times are equal, there is no longer any

linear portion of the ramp (although maximum acceleration is reached at the mid-point of the total ramp). When S-curve time is larger than the linear ramp time, again there is no linear portion, and maximum acceleration is never reached. The same is true for deceleration ramps.

The total ramp time is independent of the change in the speed reference. So, it takes the same amount of time to make a 10 rpm change as it will for a 1000 rpm change. Do not “ramp” the reference externally to the drive while S-curve is enabled in the drive (it makes the ramp time longer).

When the S-shaped ramp  $\leq$  Linear ramp, the S-shaped ramp speed profile is divided into three sections:

- Initial (positive) “S” (jerk)
- Linear (constant acceleration)
- Final (negative) “S” (jerk)



Approximately half of the value of parameter 19 [S Curve Time] is added to the initial “S” and half of the value is added to the final “S.”

When the S-shaped ramp  $>$  Linear ramp, the linear portion becomes zero.

To calculate the total ramp time when S-curve is enabled, the amount of time in each section of the profile must be determined. T1 = initial S and final S, and T2 = linear.

The total ramp time  $T3 = T1 + T2 + T1$  (each ramp has two equal “S” portions and one linear portion). In the following equations, Ta = linear ramp time (Pars 24, 32, 660, and 662), Ts = S-curve time (Par 19).

For S-shaped ramp  $\leq$  Linear ramp

- $T1 = (Ts * Ts) / (2 * Ta)$
- $T2 = Ta - T1$

For S-shaped ramp  $>$  Linear ramp

- $T1 = Ts / \sqrt{2}$
- $T2 = 0$

## S-curve Acceleration Ramp Example:

Acceleration-ramp parameter configuration:

- Par 18 [Ramp Type Select] = 1 “S shaped”
- Par 660 [Accel Time 1] = 5 s (Ta)
- Par 19 [S Curve Time] = 3.5 s (Ts)

In this case, S-shaped ramp  $\leq$  Lramp, so T1 and T2 are calculated as:

$$T1 = (3.5 * 3.5) / (2 * 5)$$

$$T1 = 12.25 / 10$$

$$\mathbf{T1 = 1.23 s}$$

$$T2 = 5 - 1.23$$

$$\mathbf{T2 = 3.78 s}$$

The resulting total ramp time is calculated as:

$$T3 = 1.23 + 3.78 + 1.23$$

$$\mathbf{T3 = 6.24 s}$$

Therefore, the total acceleration-ramp time with S-curve enabled in this example increased the total ramp time without S-curve by 1.24 seconds.

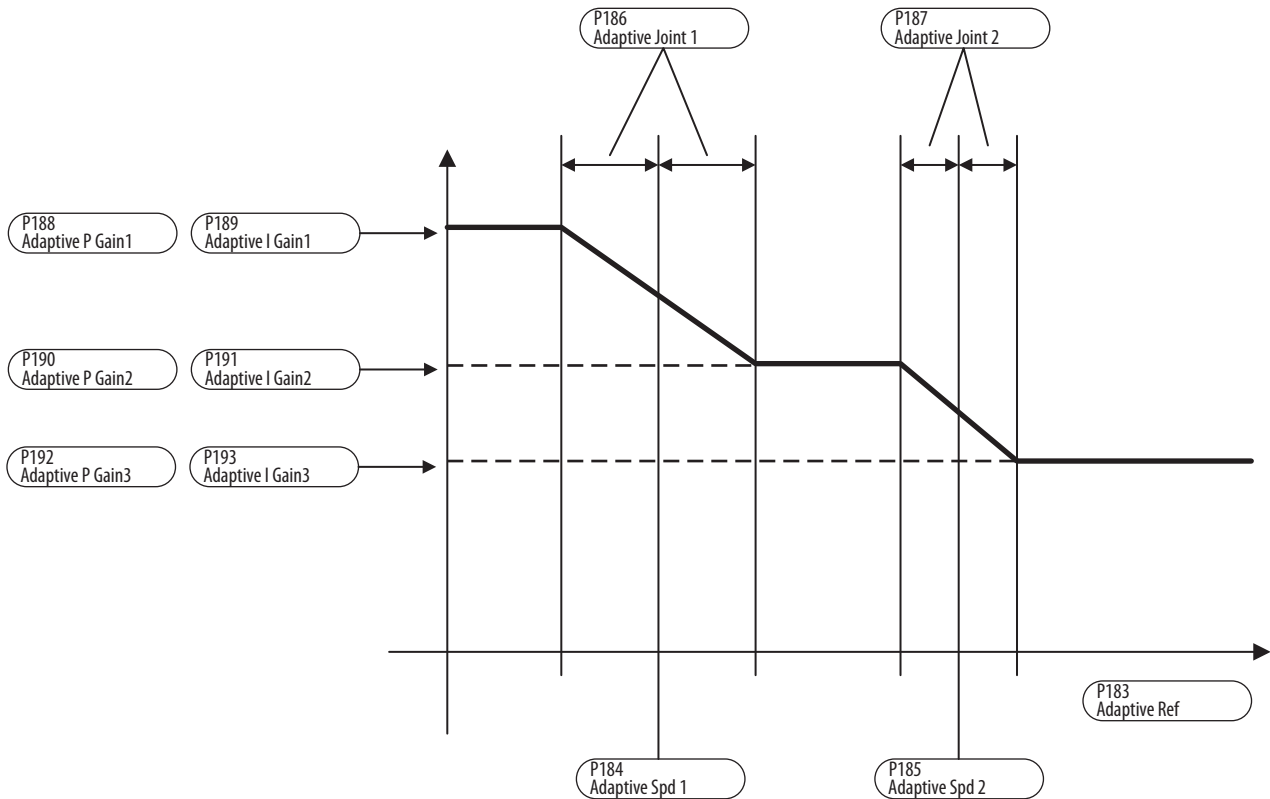
## Speed Regulation Functions

The PowerFlex DC drive provides a flexible speed regulator circuit that can be adapted to the requirements of various applications. The drive is set to PI regulation by default.

### Adaptive Speed Regulator

The adaptive speed regulator function enables different gains of the speed regulator depending on the speed reference or another variable (adaptive reference). This feature allows optimum adaptation of the speed regulator to the specific application.

In v6.001 and later, the internal value of these gains is shown in Testpoints 575...580 (see Testpoint Codes and Functions on page [233](#)). The internal value represents the equivalent firmware version 5.007 and earlier speed regulator gains.



The adaptive speed regulator is enabled when parameter 181 [Adaptive Spd En] = “1 Enabled”. Normally the gain depends on the speed of the drive. It can, however, follow a variable reference that is defined in parameter 183 [Adaptive Ref]. The type of regulation that is used is selected in parameter 182 [Adaptive Reg Typ]; 0 = “Speed”, or 1 = “Adaptive Ref”.

Parameters 184 [Adaptive Spd 1] and 185 [Adaptive Spd 2] are used to define the three ranges that can have different gains. A parameter set can be defined for each of these ranges, with each set containing an individually definable P and I component. The three sets of parameters are: 188 [Adaptive P Gain1] and 189 [Adaptive I Gain1], 190 [Adaptive P Gain2] and 191 [Adaptive I Gain2], and 192 [Adaptive P Gain3] and 193 [Adaptive I Gain3]. When the adaptive speed regulator is enabled, the first set of parameters is active until the speed specified in Par 184 [Adaptive Spd 1] or Par 183 [Adap Ref] is reached.

Parameters 186 [Adaptive Joint 1] and 187 [Adaptive Joint 2] provide a smooth transition between the different parameter sets. The fields must be defined so that [Adaptive Joint 1] and [Adaptive Joint 2] do not overlap.

When the adaptive speed regulator is enabled, parameters 87 [Spd Reg Kp] and [Spd Reg Ki] parameters have no effect on the speed regulator. They do, however, retain their value and are active when the adaptive speed regulator is disabled.

### *Configuring the Adaptive Speed Regulator*

- Set Par 181 [Adaptive Spd En] = “1 Enabled”
- If the gain must be changed based on units other than the drive speed reference, set Par 182 [Adaptive Reg Typ] = 1 “Adaptive Ref”. The adaptive reference is provided to the drive as an analog value via an analog input. For this reason, Par 183 [Adaptive Ref] must be assigned to an analog input. The other possibility is to enter the value of Par 183 [Adaptive Ref] via the HIM. In this case, the analog input is not necessary.
- Enter the appropriate values in Par 184 [Adaptive Spd 1] and Par 185 [Adaptive Spd 2] to define the three speed ranges. Values are expressed as a percentage of Par 45 [Max Ref Speed] and the maximum value of Par 183 [Adaptive Ref].
- When Par 182 [Adaptive Reg Typ] = 0 “Speed”, tuning is completed via Fine-Tuning the Regulators on page [349](#). In this case the following points must be considered:
  - The value that is entered in Par 61 [TstGen Offset] must meet these constraints:
    - Set to the low end of the speed range to be tuned
    - Set outside the range of the values in parameters [Adaptive Joint  $x$ ]
  - Enter the step value in Par 60 [TstGen Amplitude], so that the speed remains inside the range to be tuned.
  - The optimization is conducted separately for each range and the parameters of the regulator are set for each range with Pars [Adaptive P Gain $x$ ] and [Adaptive I Gain $x$ ].
  - After the optimization of the different phases, review the entire speed range. By changing the value of [Adaptive Joint  $x$ ], it is possible to reduce the instabilities present in the transients during the changes from one range to the other. Increasing the values transients are slighter.
- When Par 182 [Adaptive Reg Typ] = 1 “Adaptive Ref”, tuning is application-specific.
- When the speed zero logic (see page [340](#)) is disabled (factory default setting) and the drive is disabled, the gains of the speed regulator are active. These gains are set via Pars 188 [Adaptive P Gain1] and 189 [Adaptive I Gain1]. When the speed zero logic is enabled, the values set when the motor is stopped are valid.

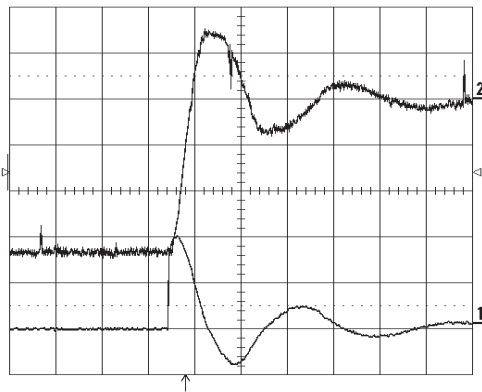
## Speed Up Function

The Speed-up function is used to avoid oscillations in the presence of loads with a high moment of inertia. To enable the Speed-up function, set Par 1016 [SpdFuncSelect] to 0 "Speed Up." When this function is enabled, a D (derivative) value is added to the speed feedback circuit, which allows you to increase the integral gain of the speed regulator. It is also useful in the case of cyclical non-constant loads on the motor (for example, cams). The feedback that is applied to the speed regulator is made of two components:

- the motor speed
- the output signal from the Speed Up function

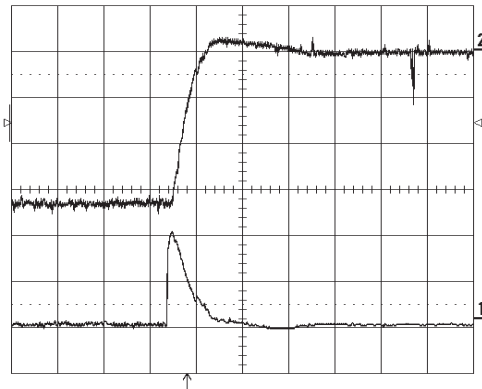
**Figure 88 - Speed-Up function inactive**

Oscillation during a speed change due to a high moment of inertia.  
Top: Par 122 [Spd Feedback]  
Bottom: Par 199 [Arm Current Pct]



**Figure 89 - Speed-up function active**

The same drive with Speed-up function active.  
Top: Par 122 [Spd Feedback]  
Bottom: Par 199 [Arm Current Pct]



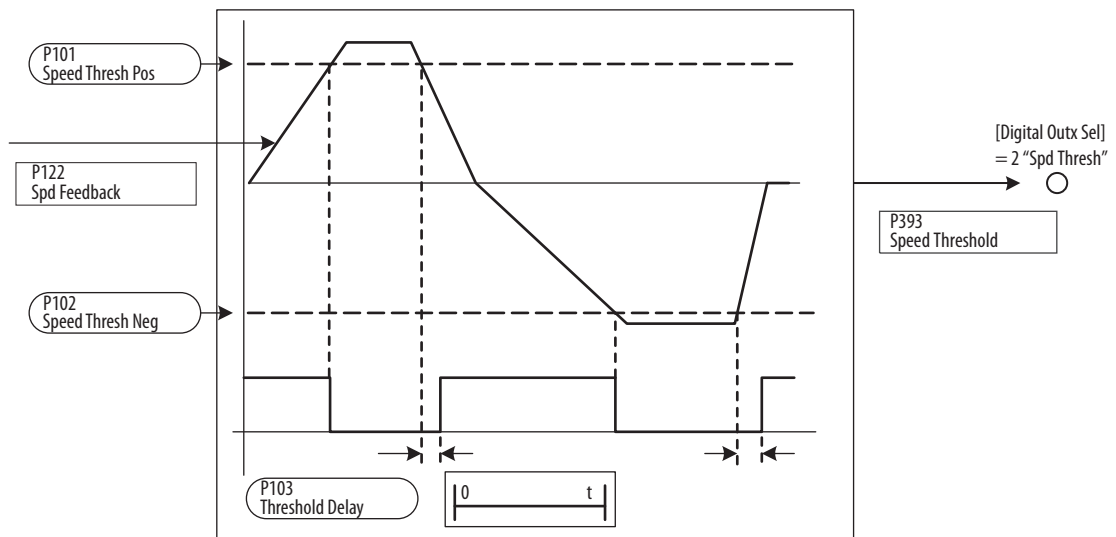
Parameters that are used in the example:

- Par 445 [Spd Up Gain Pct] = 50%
- Par 446 [Speed Up Base] = 14 rpm/ms
- Par 447 [Speed Up Filter] = 20 ms

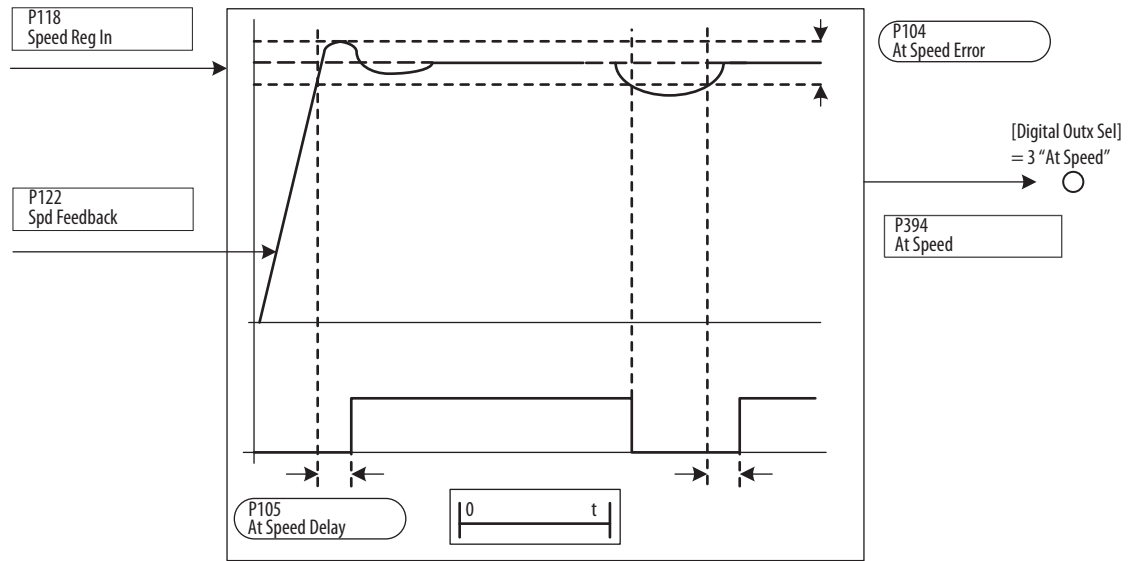
## Speed Threshold Indicators

There are two speed threshold functions available that can be programmed via a digital output to provide indication of when the drive has exceeded certain set points.

Par 393 [Speed Threshold] displays whether the speed of the drive is above or below a set speed for clockwise and counter-clockwise rotation. Set the threshold speed for clockwise rotation in Par 101 [Speed Thresh Pos] and set the threshold speed for counter-clockwise rotation in Par 102 [Speed Thresh Neg]. You can specify a delay time in Par 103 [Threshold Delay] that must elapse before indication that the speed has fallen below the threshold values. Par 393 [Speed Threshold] can be assigned to a digital output. The assigned digital output changes state only at the clockwise (positive) speed threshold.



The value of Par 394 [At Speed] identifies if the drive speed is equal or not equal to the set speed reference (in Par 118 [Speed Reg In]) before the speed regulator and ramp reference (if enabled) are applied. The speed above and below the speed reference at which indication occurs is set in Par 104 [At Speed Error]. Use Par 105 [At Speed Delay] to specify a delay time before indication that the speed reference is within the range set in Par 104 [At Speed Error] occurs. Par 394 [At Speed] can be assigned to a digital output.



## Speed Zero Function

The Speed Zero Logic determines the behavior of the drive when the motor is at zero speed. See the Speed Adaptive and Speed Zero Logic block diagram on page [373](#).

### Configuring the Speed Zero Logic

It is possible to avoid drive creep when the motor is at zero speed by disabling the Integral section of the Speed regulator. By default, the output of the Integral portion of the Speed regulator is disabled (Par 123 [Spd Zero I En] = 0 “Disabled”).

---

**IMPORTANT** If the speed regulator is disabled, the motor cannot receive a load when it is stopped. Therefore this function is not suitable for all applications!

---

Disable the output of the P gain of the Speed regulator by setting Par 126 [Spd Zero P Gain] to one of the following settings:

- If the speed reference is above the value set in Par 106 [Ref Zero Level]: Set Par 124 [Spd Ref Zero En] = 1 “Enabled”
- If the speed reference and/or the reaction are above the value set in Par 106 [Ref Zero Level], set Par 124 [Spd Ref Zero En] = 0 “Disabled”

Par 124 [Spd Ref Zero En] is active only when Par 125 [Spd Zero P En] = 1 “Enabled”.



Set the P gain for zero speed:

- If the P gain corresponds to the value set in Par 126 [Spd Zero P Gain], then set Par 125 [Spd Zero P En] = 1 “Enabled”
- If the P gain corresponds to the normal P gain, then set Par 125 [Spd Zero P En] = 0 “Disabled”

The P gain at zero speed is set via Par 126 [Spd Zero P Gain] when Par 125 [Spd Zero P En] = 1 “Enabled”.

The value of Par 106 [Ref Zero Level] determines the threshold for the recognition of zero speed.

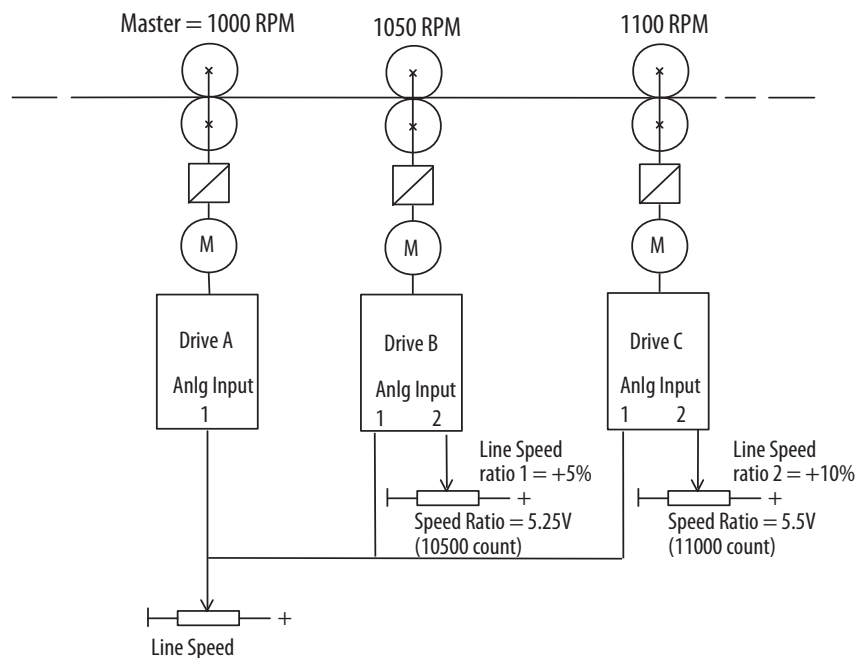
## Speed Draw Function

The Speed Draw function can be used to apply a configurable speed ratio (set in Par 1017 [Speed Ratio]) to the main speed reference of the drive. This function is useful in a multi-drive system where a proportional speed increase between the motors is required. The range of parameter 1017 [Speed Ratio] can be set in one of these ways:

- 0...32767, if written in digital form
- 0...20000 (0V to +10V), if assigned to an analog input

The resulting speed value can be viewed in Par 1018 [Speed Draw Out] via an analog output.

**Figure 90 - Speed Draw Example**



### *Speed Draw Example Configuration*

**Drive A:**

- Set parameter 70 [Anlg In1 Sel] to 1 “Speed Ref A”

**Drive B:**

- Set parameter 70 [Anlg In1 Sel] to 1 “Speed Ref A”
- Set parameter 75 [Anlg In2 Sel] to 22 “Speed Ratio”
- Set parameter 1017 [Speed Ratio] to 10500

**Drive C:**

- Set parameter 70 [Anlg In1 Sel] to 1 “Speed Ref A”
- Set parameter 75 [Anlg In2 Sel] to 22 “Speed Ratio”
- Set parameter 1017 [Speed Ratio] to 11000

## **Speed / Torque Mode Selection**

Parameter 241 [Spd Trq Mode Sel] is used to choose whether the drive operates as a speed regulator, a torque regulator, or a combination of the two. Each mode is discussed in more detail in this section. See the “Torque Mode Selection” block diagram on page [369](#) for more information.

This function is only available for firmware revision 3.001 and later.

### **Zero Torque Mode**

Zero torque current is allowed when Par 241 [Spd Trq Mode Sel] is set to 0 “Zero Trq Ref”. Operation in zero torque mode allows the motor to be fully fluxed and ready to rotate when a speed command or torque command is given. This mode can be used for a cyclical application where throughput is a high priority. The control logic can select zero torque during the “rest” portion of a machine cycle instead of stopping the drive. When the cycle start occurs, instead of issuing a start to the drive, a speed regulation mode can be selected. The drive then immediately accelerates the motor without the need for “flux up” time.

---

**IMPORTANT** Zero Torque may excessively heat the motor if operated in this mode for extended periods of time. No load or flux current is still present when the drive is operating in zero torque mode. A motor with an extended speed range or separate cooling methods (blower) may be required.

---

## Speed Regulation Mode

When Par 241 [Spd Trq Mode Sel] is set to 1 “Speed Reg” (default), the drive and motor are operated in speed mode. The torque command changes as necessary to maintain the desired speed. Operating as a speed regulator is the most common and simplest mode to configure. Examples of speed regulated applications are blowers, conveyors, feeders, pumps, saws, and tools.

In a speed regulated application, the speed regulator output generates the torque reference. Under steady state conditions, the speed feedback is steady while the torque reference is a constantly adjusting signal. This constant adjustment is required to maintain the desired speed. In a transient state, the torque reference changes dramatically to compensate for a speed change. A short duration change in speed is the result of increasing or decreasing the load rapidly.

Inertia compensation is summed with the output of the speed regulator.

## Torque Regulation Mode

Par 241 [Spd Trq Mode Sel] is set to 2 “Torque Reg” for torque mode. In torque regulation mode, the drive controls the desired motor torque. The motor speed is the result of torque command and load present at the motor shaft. The reference signal is equal to the value of Par 39 [Torque Ref]. A torque regulated application can be described as any process that requires some tension control. An example is a winder or unwinder with material being “drawn” or pulled with a specific tension required.

If the material that is being wound or unwound breaks, the load decreases dramatically and the motor can potentially go into an overspeed condition.

## Speed Limited Adjustable Torque (SLAT) Min Mode and SLAT Max Mode

SLAT Min Mode (Par 241 [Spd Trq Mode Sel] set to 3) and SLAT Max Mode (Par 241 [Spd Trq Mode Sel] set to 4) are for applications that require a smooth transition from a torque mode to a speed mode of operation. Examples include: web handlers, center winders, and center unwinders, where the drive is normally following a torque reference but a break or slippage could occur. Direction of the applied torque and direction of the material movement determine whether SLAT Min or SLAT Max mode is used.

### SLAT Min Mode

In SLAT Min mode, a speed reference that forces the speed regulator into saturation (the speed reference is slightly above the speed feedback) is typically configured. In this case, the drive follows the torque reference until there is a breakage or slippage in the application.

When the drive is following a torque reference (torque mode) in SLAT Min mode, one of two conditions forces the drive into following the speed reference (speed mode):

1. The output of the speed regulator becomes less than the torque reference.
2. The speed error becomes negative (the speed feedback becomes greater than the speed reference). A negative speed error indicates forced speed mode.

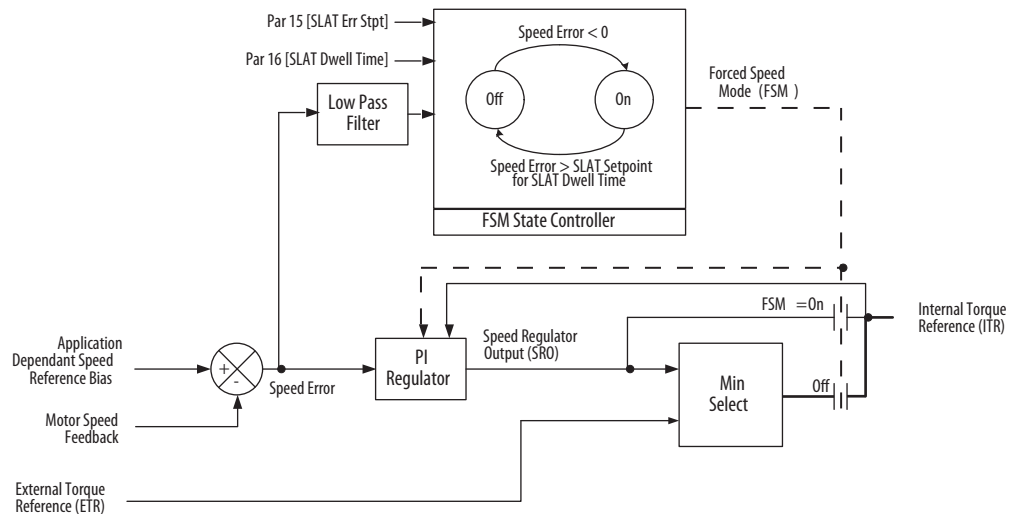
Parameter 15 [SLAT Err Stpt] and parameter 16 [SLAT Dwell Time] let you set some hysteresis for turning off the forced speed mode. They are set to “0” as default so that there is no hysteresis. In SLAT Min mode, Par 15 [SLAT Err Stpt] sets how much less the speed feedback is than the speed reference before turning off the forced speed mode. Par 16 [SLAT Dwell Time] sets how long the speed error must exceed the SLAT error set point before turning off the forced speed mode.

When the drive switches from torque mode to forced speed mode, the speed-regulator integral part is pre-loaded with the Internal Torque Reference (ITR) or Par 14 [Selected TorqRef] to create a smooth transition.

In order for the drive to switch from speed to torque mode, forced speed mode (if active) must first be turned off. Forced speed mode turns off when the speed error is greater than the SLAT error setpoint for the SLAT dwell time. With default parameter settings, forced speed mode turns off when the speed error becomes positive.

When Forced Speed Mode is off, the drive switches back to torque mode when the speed regulator output becomes greater than the torque reference.

**Figure 91 - SLAT Min Mode Block Diagram**



### SLAT Max Mode

In SLAT Max mode, a speed reference that forces the speed regulator into saturation (the speed reference is slightly below the speed feedback) is typically configured. In this case, the drive follows the torque reference until there was a breakage or slippage in the application.

In SLAT Max mode, the drive switches from torque mode to speed mode when either one of the two following conditions occur:

1. The output of the speed regulator becomes more than the torque reference (speed mode).
2. The speed error becomes positive (speed mode). In other words, the speed feedback becomes less than the speed reference.

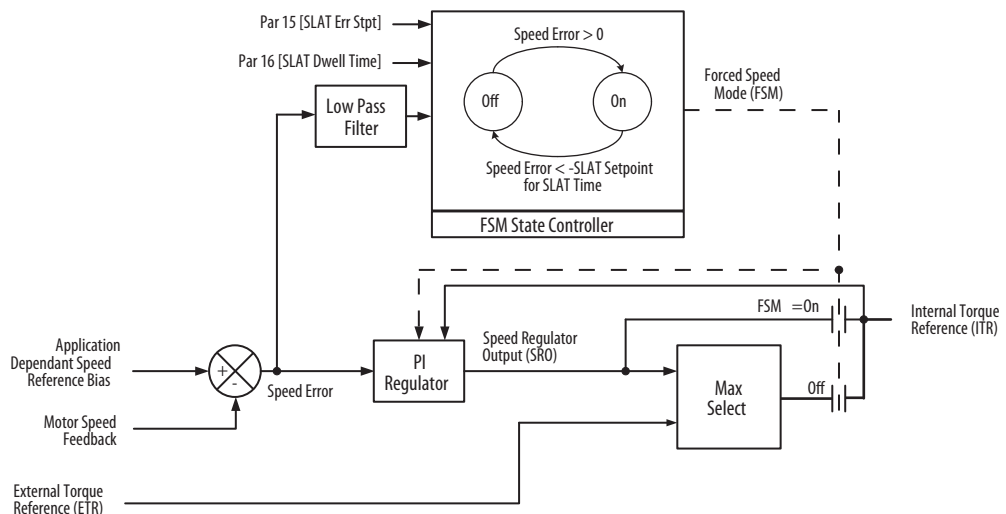
Parameter 15 [SLAT Err Stpt] and parameter 16 [SLAT Dwell Time] let you set some hysteresis for turning off the forced speed mode. They are set to “0” as default so that there is no hysteresis. In SLAT Max mode, Par 15 [SLAT Err Stpt] sets how much more the speed feedback is than the speed reference before turning off the forced speed mode. Par 16 [SLAT Dwell Time] sets how long the speed error must exceed the SLAT error set point before turning off the forced speed mode.

When the drive switches from torque mode to forced speed mode, the speed-regulator integral part is pre-loaded with the Internal Torque Reference (ITR) or Par 14 [Selected TorqRef] to create a smooth transition.

In order for the drive to switch from speed mode to torque mode, forced speed mode (if active) must first be turned off. Forced speed mode turns off when the speed error is less than the SLAT error setpoint for the SLAT Dwell Time. With default parameter settings, forced speed mode turns off when the speed error becomes negative.

When Forced Speed Mode is off, the drive switches back to torque mode when the speed regulator output becomes less than the torque reference.

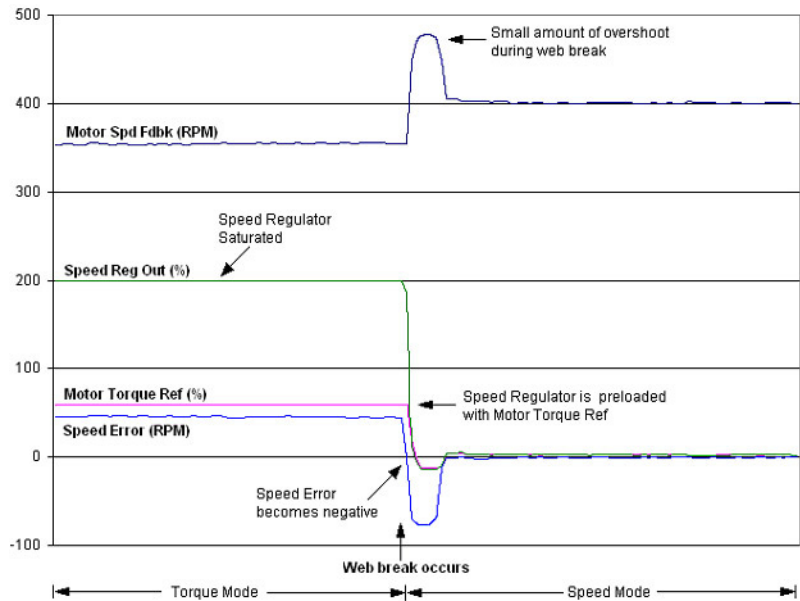
**Figure 92 - SLAT Max Mode Block Diagram**



*Example:*

The application is a paper winder. The drive is set for SLAT Min mode, so that the drive normally runs in torque mode and follows Par 39 [Torque Ref]. [Torque Ref] comes from an external controller and is approximately 60% of motor torque during the snapshot. The speed reference, also from an external controller, is set just above the speed feedback so the speed regulator is saturated while in torque mode. Figure 93 captures what occurs in the drive during a break in the web.

**Figure 93 - SLAT Min Mode Trace Example**



## Sum Mode

Sum mode is selected when Par 241 [Spd Trq Mode Sel] is set to 5 “Sum”. In this mode, the reference is derived from the sum of the speed regulator output (Par 236 [Spd Reg Out Pct]) and the torque reference (Par 39 [Torque Ref]). This mode can be used for applications that have precise speed changes with critical time constraints.

### Torque Mode Selection Status Bits

Bits 7 “Forced Spd”, 8 “Speed Mode”, and 9 “Torque Mode” of parameter 382 [Drive Status 2] display the status of the speed/torque mode for the drive.

Par 241 [Spd Trq Mode Sel]	Par 382 [Drive Status 2]		
	Bit 7 “Forced Spd”	Bit 8 “Speed Mode”	Bit 9 “Torque Mode” <sup>(1)</sup>
0 “Zero Trq Ref”	0	0	1
1 “Speed Reg”	0	1	0
2 “Torque Reg”	0	0	1
3 “SLAT Min”		(1)	$\overline{(b7 + b8)}$
4 “SLAT Max”		(2)	$\overline{(b7 + b8)}$
5 “Sum”	0	1	1

(1)  $b9 = \text{not}(b7 + b8)$ , if  $b7=1$  &  $b8=0$ , then  $b9=0$ .

#### (1) 3 “SLAT Min”

Bit 7 “Forced Spd”	0	Not in Forced Speed Mode (FSM)
	0 -> 1	Speed error < 0 (i.e., Feedback > Reference), preload the speed regulator integrator with the value of Par 14 [Selected Torque Ref]
	1	Forced Speed Mode (FSM), speed error < 0
	1 -> 0	Error (i.e., Reference - Feedback) > Par 15 [SLAT Err Stpt] for more than the value of Par 16 [SLAT Dwell Time]
Bit 8 “Speed Mode”	0	Par 236 [Spd Reg Pct Out] > Par 39 [Torque Ref]
	1	Par 236 [Spd Reg Pct Out] < Par 39 [Torque Ref]

#### (2) 4 “SLAT Max”

Bit 7 “Forced Spd”	0	Not in Forced Speed Mode (FSM)
	0 -> 1	Speed error > 0 (i.e., Feedback < Reference), preload the speed regulator integrator with the value of Par 14 [Selected Torque Ref]
	1	Forced Speed Mode (FSM), speed error > 0
	1 -> 0	Error (i.e., Reference - Feedback) < -Par 15 [SLAT Err Stpt] for more than the value of Par 16 [SLAT Dwell Time]
Bit 8 “Speed Mode”	0	Par 236 [Spd Reg Pct Out] < Par 39 [Torque Ref]
	1	Par 236 [Spd Reg Pct Out] > Par 39 [Torque Ref]

When Par 241 [Spd Trq Mode Sel] is changed to 1 “Speed Reg”, the speed regulator integrator is preloaded with the value of Par 14 [Selected Torque Ref]. When Par 241 [Spd Trq Mode] is changed to 5 “Sum”, the speed regulator is preloaded with the value of Par 14 [Selected Torque Ref]...39 [Torque Ref].

## Start At Powerup

The “Start At Powerup” function lets you resume running at commanded speed automatically after these conditions are met:

- Drive input power is restored
- A run command is issued
- All start permissive conditions are met (see [Figure 94](#) - Start Permissives Flow Diagram)

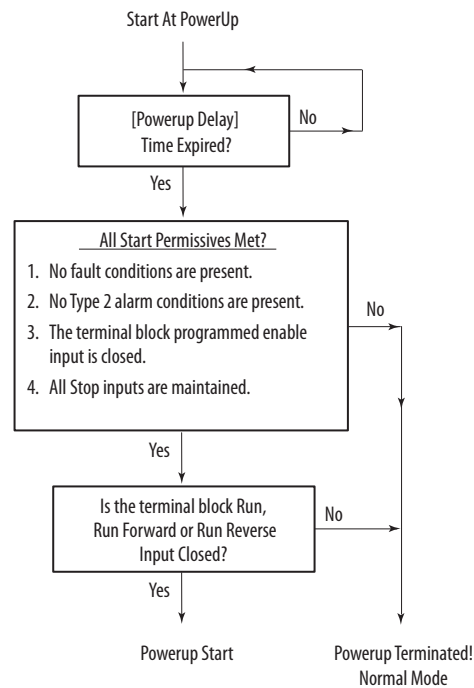
To enable this feature, parameter 1344 [Start At Powerup] must be set to 1 “Enable”.



**ATTENTION:** Equipment damage and/or personal injury may result if this parameter is used in an inappropriate application. Do not use this function without considering applicable local, national, and international codes, standards, regulations, or industry guidelines.

In addition, A delay time of up to 10800 seconds (3 hours) can be programmed in parameter 1345 [Powerup Delay]. An automatic drive restart is not possible before the delay time has expired. If a “Start”, “Run” or “Stop” command is asserted before the time in this parameter expires, the “Start At Powerup” function is aborted.

**Figure 94 - Start Permissives Flow Diagram**



Until the time that is specified in parameter 1345 [Powerup Delay] elapses, these indications occur:

- An alarm indicator “” is displayed on the HIM
- Bit 12 “PwrUp Start” of parameter 1380 [Drive Alarm 1] is set to “1”



## Fine-Tuning the Regulators

The PowerFlex DC drive control regulators have predefined values that are meant to provide consistent drive performance without performing any further configuration. One exception is the armature current regulator, which must always be tuned. When the armature current regulator has been tuned to meet the requirements of the application, the fine-tuning procedures for the other regulators are not necessary. However, the fine-tuning procedures can be used to optimize the output and control features of the drive.

The drive contains the following regulation circuits:

- Armature current regulator - The armature current auto-tuning procedure is run via Par 452 [CurrReg Autotune]. See Chapter 2 - Drive Start Up - Tune the Current Regulator on page [102](#).
- A manual procedure to adjust the armature inductance when the autotune steps yielded a value outside the recommended setting. See Manually Adjusting the Current Regulator Tune Settings on page [350](#).
- Field current regulator:
  - A fine-tuning procedure is available. See Fine-Tuning the Field Current Regulator on page [352](#).
- Speed regulator - The speed auto-tuning procedure is run via Par 1027 [Spd Reg Autotune]. See Chapter 2 - Drive Start Up - Tune the Speed Regulator on page [109](#). A fine-tuning procedure is available. See Fine-Tuning the Speed Regulator on page [354](#).
- Armature voltage regulator - A fine-tuning procedure is available. See Fine-Tuning the Voltage Regulator in the Field Converter on page [356](#).

To obtain a step function, the internal “Test generator” can be used. The goal of the fine-tuning procedures is to obtain an optimal step response. For example, it is recommended that you directly measure the step response for the field current regulator.

The field current can be directed to an analog output on the Terminal Block (with a 2 ms sample rate).

### *Using the Test Generator*

The “Test Generator” function creates signals with a rectangular wave form based on a specific frequency and amplitude. The frequency and amplitude can be added to a configurable offset value, if needed. Par 58 [TstGen Output] determines which regulator input signal (reference) is used; torque current, field, ramp, or speed.

## Manually Adjusting the Current Regulator Tune Settings

While the drive is operating, the value of Par 587 [I Reg Error] is updated in response to changes in the current output to the motor. By manually applying current steps to the motor, this parameter can be used as an indication whether the current regulator in the drive is correctly tuned. Ideally, the value of Par 587 [I Reg Error] should be as near to zero as possible. However, values between -40 and 40 are acceptable during normal operation (because the drive is responding to changing current demands). Manually tuning the Current Regulator attempts to have Par 587 [I Reg Error] reach its lowest value in response to applied steps in current to the motor.

Adjustments to Par 587 [I Reg Error] are made by changing Par 454 [Arm Inductance] and by stepping the current to the motor. Par 587 [I Reg Error] values are valid only when the drive is operating under at least a 30% current load. The manual-tuning procedure progresses through larger current steps up to 100%. Par 454 [Arm Inductance] and Par 453 [Arm Resistance] are the current-regulator tuning parameters and typically do not match the motor data-sheet values.

### *Manual Current-loop Tuning*

When attempting to tune the current loop manually, the current reference is stepped to values that can cause the motor to rotate even while the field is disabled (residual flux). If possible, the motor armature shaft should be locked to prevent rotation or decrease the maximum amplitude of current applied per step to minimize armature movement. Not locking the armature is optional only when an external speed-measurement device, such as an encoder or tachometer, is used. Armature rotation interferes with obtaining acceptable tuning values. Be sure to record all original parameter values that are changed as part of configuration for this test.

1. Disable the field regulator by setting Par 497 [Field Reg Enable] to 0 “Disabled”.

For firmware revision 3.001 and later, make these parameter configurations:

- Par 469 [Field Mode Sel] to 2 “External”
  - Par 414 [Fdbk Device Type] to 1 “Encoder” (a Type 2 alarm is generated if Par 414 is set to 3 “Armature”)
2. Verify that Par 351 [Field Current] is set to zero (0 or < 0.05 A).
  3. For firmware revision 2.xxx and earlier, disable the speed regulator by setting Par 242 [Speed Reg En] to 0 “Disabled”. For firmware revision 3.xxx and later, set Par 241 [Spd Trq Mode Sel] = 2 “Torque Reg.
  4. Set/verify that Parameters 7 [Current Limit], 8 [Current Lim Pos] and 9 [Current Lim Neg] are at 100%.
  5. Set Par 453 [Arm Resistance], calculated as:
 
$$(\text{Par 175 [Rated Motor Volt]} / \text{Par 179 [Nom Mtr Arm Amps]}) \times 0.04$$

6. Set Par 454 [Arm Inductance] to the minimum value (based on drive size).
7. Set Par 39 [Torque Ref] to 30% (a percentage relative to Par 179 [Nom Mtr Arm Amps]).
8. Start the drive and observe the value of Par 587 [I Reg Err] for a few seconds; it should settle to a specific value. Verify that the motor shaft does not rotate (a small amount of movement, less than a revolution, is OK).
9. Stop the drive.

If a Speed Feedback Loss fault (F91) occurs, increase the value of Par 455 [Spd FB Loss Lvl] to its maximum value.

- a. If Par 587 [I Reg Err] is positive, increase the value of Par 454 [Arm Inductance]. The value of parameter 587 determines the magnitude of change. Generally, make large increases (for example, double) when Par 587 is large (greater than 40) and smaller increases as Par 587 gets closer to zero.
  - b. If Par 587 [I Reg Err] is negative, decrease the value of Par 454 [Arm Inductance]. Again, proportional to the magnitude of Par 587.
10. Repeat step 8 until Par 587 [I Reg Err] is as close to zero as possible. Values less than 20 are acceptable as close to zero. However, with some motors, the minimum value of Par 587 can only be 60 (especially at smaller current steps). With higher current steps, values can be less than 10 or less than 5.
  11. Repeat steps 8 and 9 with Par 39 [Torque Ref] set to 60% and then again at 100%. If motor rotation occurs, try lowering the current step value. The higher the current step, the better the tuning results are. If motor rotation still occurs enter the highest current step value that does not cause rotation but provides enough time for Par 587 to reach a stable value. Typically, a stable [I Reg Err] value can be obtained in less than 2 seconds.
  12. The current loop should be tuned with the final values of Pars 453 [Arm Resistance] and 454 [Arm Inductance] and a small value in Par 587 [I Reg Err].
  13. Restore these parameters to their original values:
    - 497 [Field Reg Enable]
    - 469 [Field Mode Sel]
    - 414 [Fdbk Device Type]
    - 242 [Speed Reg En]
    - 7 [Current Limit]
    - 8 [Current Lim Pos]
    - 9 [Current Lim Neg]
    - 455 [Spd FB Loss Lvl]
  14. Unlock the motor armature (if necessary).

15. Verify that the motor is attached to any normal application inertia (not process material).
16. Perform a speed regulator autotune by setting Par 1027 [Spd Reg Autotune] = 1 and pressing the Start button.
17. When autotuning completes, speed regulator tuning values should be automatically updated.

If the drive is configured as an armature voltage regulator (Par 414 = 3 “Armature”), the calculated gains (Par 87 and 88) may need to be adjusted. These adjustments are necessary because this type of regulator (voltage) is less responsive than a true speed regulator (that uses encoder or tachometer feedback).

## Fine-Tuning the Field Current Regulator

---

**IMPORTANT** In most cases motors with a direct current and an independent excitation work with a constant field (Par 469 [Field Mode Sel] = 0 “Base Speed”). In this case, it is not necessary to optimize the field current or armature voltage regulators.

---

This procedure is used for drives that use constant torque and power (mixed armature and field regulation). In these cases, it is necessary to configure the field converter according to this method.

---

**IMPORTANT** Do not issue a “Start” command to the drive during the field current-regulator fine-tuning procedure.

---

Follow these steps to fine-tune and optimize the field current regulator:

1. Configure the following parameters:
  - Set Par 467 [Max Fld Flux Pct] = 100% of the field rated current of the connected motor
  - Set Par 468 [Min Fld Curr Pct] = 0
  - Set Par 91 [Fld Reg Kp] = 0.00
  - Set Par 92 [Fld Reg Ki] = 0.00
2. Measure the field current by using an analog output by setting:
  - Par 66 [Anlg Out1 Sel] = 18 “Fld Current”
  - Par 67 [Anlg Out2 Sel] = 24 “Field Ref”
3. Configure the following parameters:
  - Set Par 497 [Field Reg Enable] = 1 “Enabled” (default)
  - Set Par 469 [Field Mode Sel] = 1 “Field Weaken”
  - Set Par 498 [Force Min Field] = 1 “Enabled”
4. Configure the following Test Generator parameters:
  - Set Par 58 [TstGen Output] = 3 “Field Ref”
  - Set Par 60 [TstGen Amplitude] = 70% of the field rated current of the motor (this setting allows the system overshoot).

5. Increase the value of the Par 91 [Fld Reg Kp] until the overshoot of the field current (displayed in Par 234 [Fld Current Pct]) is lower than 4%.
6. Increase the value of Par 92 [Fld Reg Ki] until the overshoot is higher than 4%. Then, decrease the value of this parameter until it becomes slightly lower than 4%.

---

**IMPORTANT** Because of the relatively high field time constant, the rising speed of the field current is limited. The rising time with optimal tuning conditions could be up to 100 milliseconds.

---

7. Set Par 58 [TstGen Output] = 0 “NotConnected”.
8. Set Par 498 [Force Min Field] = 0 “Disabled”.
9. Set Par 468 [Min Fld Curr Pct] to the desired value.
10. Configure the analog outputs according to your application needs.

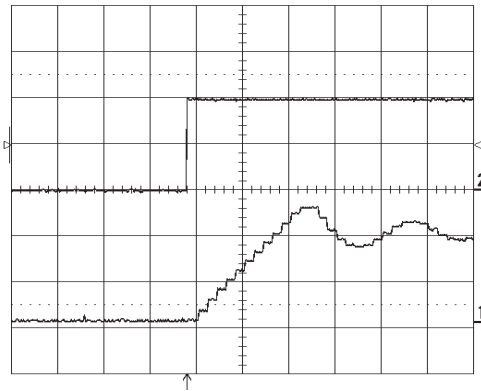
### Field Current Regulator Tuning Examples

**Figure 95 - Increase in the field current with oscillation**

Non-optimal response of the regulator.

Top: Par 500 [Flux Ref Pct]

Bottom: Par 234 [Fld Current Pct]

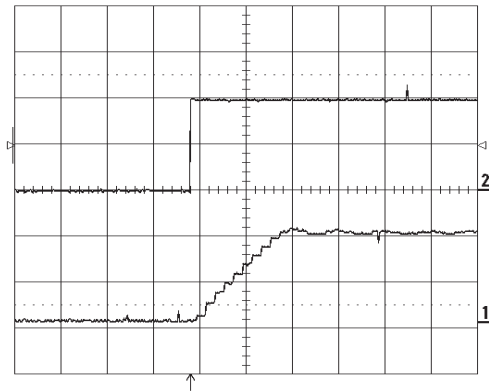


**Figure 97 - Increase in the field current without oscillation**

This graph, as compared to the graph in [Figure 95](#), shows an increase in [Fld Reg Kp] from 2% to 10% with [Fld Reg Ki] = 5%.

Top: Par 500 [Flux Ref Pct]

Bottom: Par 234 [Fld Current Pct]

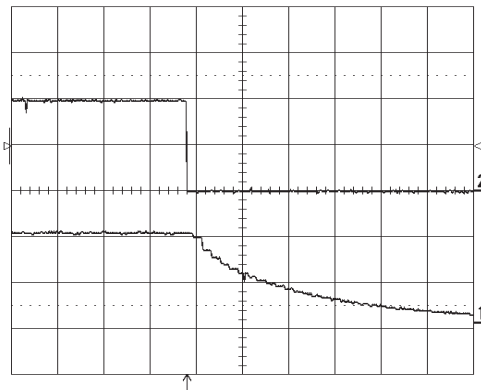


**Figure 96 - Too high of a time constant on the field**

The reduction of the field current depends on the field time constant. Therefore, the regulator has no influence on the flux current.

Top: Par 500 [Flux Ref Pct]

Bottom: Par 234 [Fld Current Pct]



## Fine-Tuning the Speed Regulator

Follow these steps to fine-tune and optimize the speed regulator:

1. Configure the following Test Generator parameters:
  - Set Par 58 [TstGen Output] = 4 “Ramp Ref”
  - Set Par 59 [TstGen Frequency] = 0.2 Hz
  - Set Par 60 [TstGen Amplitude] = 10%
  - Set Par 61 [TstGen Offset] = 20%
2. Measure the results on analog outputs 1 and 2 by setting:
  - Par 66 [Anlg Out1 Sel] = 8 “Spd Reg Out”
  - Par 67 [Anlg Out2 Sel] = 13 “Motor Curr”.
3. Set Par 660 [Accel Time 1] = 0 sec.
4. Set Par 662 [Decel Time 1] = 0 sec.
5. Set Par 87 [Spd Reg Kp] = 0.00
6. 88 [Spd Reg Ki] = 0.00
7. Start the drive.
8. Increase the value of Par 87 [Spd Reg Kp] until the overshoot is lower than 4% with the shortest possible acceleration or deceleration time.
9. Increase the value of Par 88 [Spd Reg Ki] until the overshoot is higher than 4%. Then, decrease the value of this parameter until its value becomes slightly lower than 4%.
10. Stop the drive.
11. Set Par 58 [TstGen Output] = 0 “NotConnected”.

---

**IMPORTANT** When the “Bypass” function is enabled (Par 458 [SpdReg FB Bypass] = 1 “Enabled”), the drive is switched to armature feedback automatically when a “Speed fbk loss” fault occurs due to an encoder or tachometer feedback loss. In this case, you must repeat steps 1...9 of the “Fine-Tuning the Speed Regulator” procedure when the fault has been cleared. After an automatic switch to armature feedback, the speed regulator works with Pars 459 [SpdReg Kp Bypass] and 460 [SpdReg Ki Bypass] and the D (derivative) part of the speed regulator is automatically excluded.

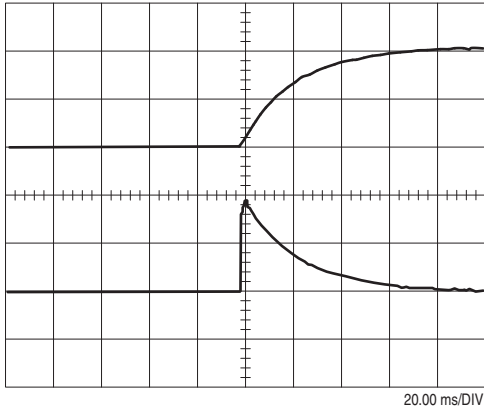
---

When it is necessary to have different gains for the speed regulator above the speed range, you can utilize the adaptive speed regulator. For further information about this function, see the Adaptive Speed Regulator block diagram page [335](#).

*[Spd Reg Kp] and [Spd Reg Ki] curves*

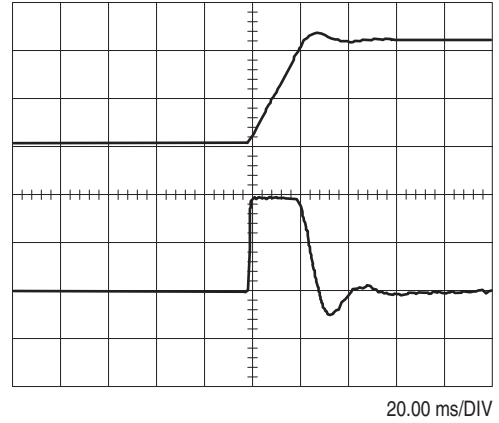
**Figure 98 - [Spd Reg Kp] too low**

Top: Par 122 [Spd Feedback]  
Bottom: Par 199 [Arm Current Pct]



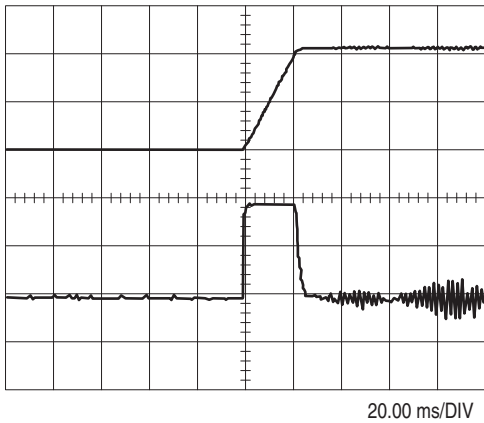
**Figure 100 - [Spd Reg Ki] too high**

Top: Par 122 [Spd Feedback]  
Bottom: Par 199 [Arm Current Pct]



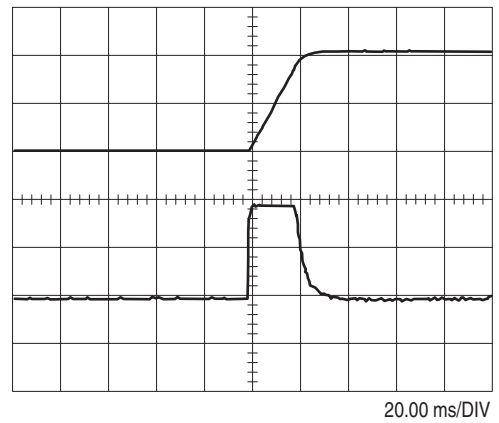
**Figure 99 - [Spd Reg Kp] too high**

Top: Par 122 [Spd Feedback]  
Bottom: Par 199 [Arm Current Pct]



**Figure 101 - [Spd Reg Ki] correct**

Top: Par 122 [Spd Feedback]  
Bottom: Par 199 [Arm Current Pct]



---

## Fine-Tuning the Voltage Regulator in the Field Converter

---

**IMPORTANT** In most cases, DC motors with independent excitation, work with a constant field (Par 469 [Field Mode Sel] = 0 “Base Speed”). In this case, it is not necessary to optimize the regulator of the field current and the regulator of the armature voltage.

---

When field weakening occurs, the voltage regulator keeps the armature voltage at a constant level. The critical point for this regulator is at the beginning of field weakening. Tune the regulator so that the armature voltage undergoes small changes.

---

**IMPORTANT** Before the optimization of the voltage regulator, the speed and field current regulators must have already been tuned. See [Tune the Current Regulator on page 102](#) and [Fine-Tuning the Field Current Regulator on page 352](#).

---

1. Configure the following Test Generator parameters:
  - Set Par 58 [TstGen Output] = 4 “Ramp Ref”
  - Set Par 59 [TstGen Frequency] = 0.2 Hz
  - Set Par 60 [TstGen Amplitude] = 10%
  - Set Par 61 [TstGen Offset] = to the switching point from the armature to the field regulation. For example: If Par 162 [Max Feedback Spd] = 2000 rpm, field weakening starts at 1500 rpm. Therefore, set Par 61 [TstGen Offset] = 75%.
2. Measure the field current and the armature voltage by using analog outputs 1 and 2, by setting:
  - Par 66 [Anlg Out1 Sel] = 18 “Fld Current”
  - Par 67 [Anlg Out2 Sel] = 14 “Motor Volts”
3. Start the drive.
4. Check the armature voltage via analog output 2. After a possible short oscillation, the voltage should remain constant. See the [Field Voltage Regulator Tuning Examples](#) on page 357. You can change the Proportional and Integral gains of the Field Voltage regulator via Pars 493 [Arm Volt Kp] and 494 [Arm Volt Ki].
5. Stop the drive.
6. Set Par 58 [TstGen Output] = 0 “NotConnected”.



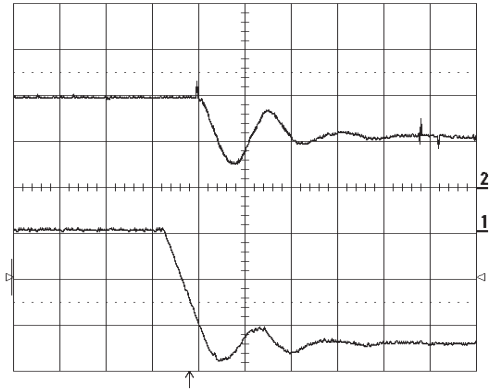
### Field Voltage Regulator Tuning Examples

**Figure 102 - Field voltage oscillation**

Oscillation after a speed change where [Arm Volt Kp] = 10% and [Arm Volt Ki] = 80%.

Top: Par 234 [Fld Current Pct]

Bottom: Par 233 [Output Voltage]



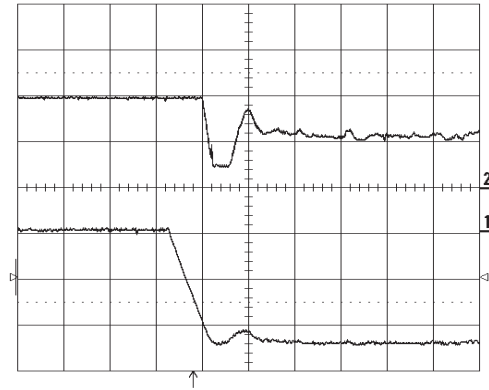
**Figure 104 - Optimal field regulation**

After a short transient, the field current and armature voltage are constant.

[Arm Volt Kp] = 40%, [Arm Volt Ki] = 5%.

Top: Par 234 [Fld Current Pct]

Bottom: Par 233 [Output Voltage]

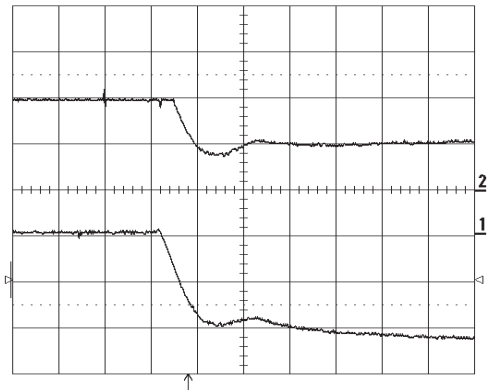


**Figure 103 - Too small of a gain**

The armature voltage increases where [Arm Volt Kp] = 3% and [Arm Volt Ki] = 5%.

Top: Par 234 [Fld Current Pct]

Bottom: Par 233 [Output Voltage]



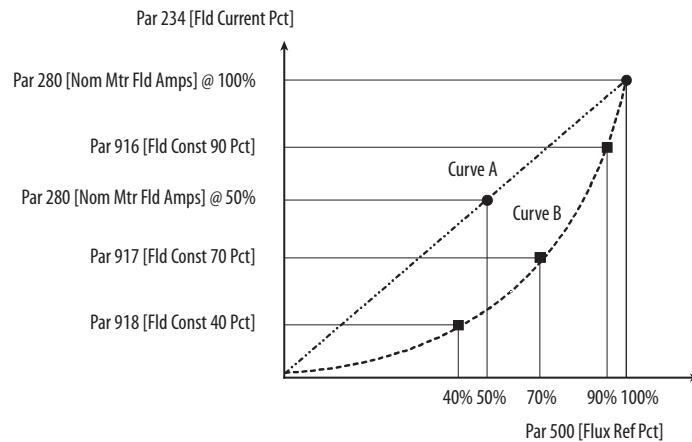
## Tuning the Field Current Curve

The function of the field current curve is to control the actual motor flux and then motor torque if the field goes into an overvoltage condition. [Figure 105](#) illustrates the relationship between flux and flux current when the field current curve is defined versus not defined.

Complete these procedures in the order that is listed when tuning the field current curve:

- Field current regulator. See Fine-Tuning the Field Current Regulator on page [352](#).
- Field current curve tuning (Flux / if curve)
- Voltage regulator in the field converter. See Fine-Tuning the Voltage Regulator in the Field Converter on page [356](#).

**Figure 105 - Curve Conversion Flux/Current**



Examples:

- Curve A - If the default settings of the drive are retained, the flux current to flux reference remains linear when the value of Par 500 [Flux Ref Pct] changes. For example:
  - If  $\text{Par 467 [Max Fld Flux Pct]} / \text{Par 500 [Flux Ref Pct]} = 100\%$ , then  $\text{Par 234 [Fld Current Pct]} / \text{Par 500 [Flux Ref Pct]} = \text{Par 280 [Nom Mtr Fld Amps]}$
  - If  $\text{Par 467 [Max Fld Flux Pct]} / \text{Par 500 [Flux Ref Pct]} = 50\%$ , then  $\text{Par 234 [Fld Current Pct]} / \text{Par 500 [Flux Ref Pct]} = 50\%$  of Par 280 [Nom Mtr Fld Amps]

- Curve B - After the field current curve fine-tuning procedure is completed, the flux current to flux reference curve will be correct for the motor. See the Current-regulator block diagram on [page 374](#).

#### *Field-current Curve Tuning Procedure:*

1. Reset the field current curve by setting Par 920 [Reset Fld Curve] to “1”.
2. Configure the following parameters:
  - Enter the percentage (100%) of the maximum motor nameplate rated armature voltage in Par 921 [Out Volt Level]
  - Set Par 469 [Field Mode Sel] = 0 “Base Speed”
  - Set Par 467 [Max Fld Flux Pct] = 100%
3. Start the drive.
4. Increase the motor speed until the value (electromotive force) displayed in Par 233 [Output Voltage] corresponds to the value previously set in Par 175 [Rated Motor Volt].
5. Decrease the value of Par 467 [Max Fld Flux Pct] until the value displayed in Par 233 [Output Voltage] is equal to 90% of Par 175 [Rated Motor Volt]. When you have reached this value, read the value that is displayed in Par 234 [Fld Current Pct] and enter the value into Par 918 [Fld Const 90 Pct].
6. Decrease the value of Par 467 [Max Fld Flux Pct] until the value displayed in Par 233 [Output Voltage] is equal to 70% of Par 175 [Rated Motor Volt]. When you have reached this value, read the value that is displayed in Par 234 [Fld Current Pct] and enter the value into Par 917 [Fld Const 70 Pct].
7. Decrease the value of Par 467 [Max Fld Flux Pct] until the value displayed in Par 233 [Output Voltage] is equal to 40% of Par 175 [Rated Motor Volt]. When you have reached this value, read the value that is displayed in Par 234 [Fld Current Pct] and enter the value into Par 916 [Fld Const 40 Pct].
8. Stop the drive.
9. Set the desired method of field control in Par 469 [Field Mode Sel] (0 “Base Speed” or 1 “Field Weaken”)
10. Reset the value of 467 [Max Fld Flux Pct] to 100%.

If you change the value of Par 175 [Rated Motor Volt] or par 280 [Nom Mtr Fld Amps], the field current curve must be retuned.

**Notes:**

## Control Block Diagrams

Topic	Page
PowerFlex DC Drive Overview	362
Digital Inputs/Outputs (Standard and Expansion) Mapping	363
Analog Inputs/Outputs Mapping	364
Speed Reference Selection	365
Speed Reference Generation	366
Ramp Reference Block	367
Speed Regulator	368
Torque Mode Selection	369
Droop Compensation - Inertia / Loss Compensation	370
Speed Feedback	371
Speed Regulator PI Block	372
Speed Adaptive and Speed Zero Logic	373
Current Regulator	374
Field Current Regulator	375
Motor Parameters	376
Speed Threshold / Speed Control	377
PID Control	378
Scale Blocks	379
User Defined Variables	380
Taper Current Limits	381
Unit Scaling	382
Test Generator	383
Speed Select Settings	383
Fault / Alarm Mapping	384

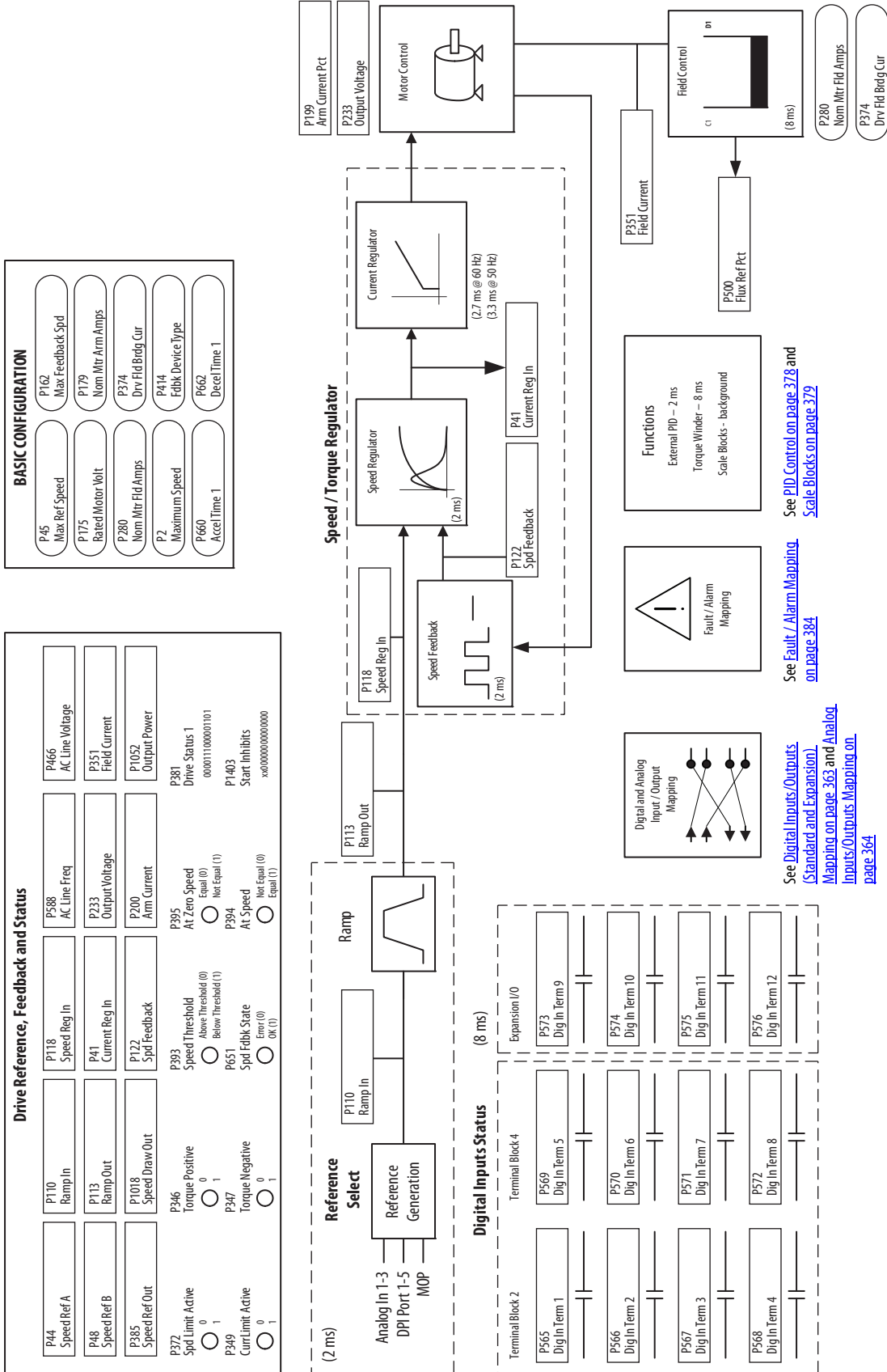
### Diagram Conventions

Examples:



PXXX     = Parameter Number  
 ParName     = Parameter Name

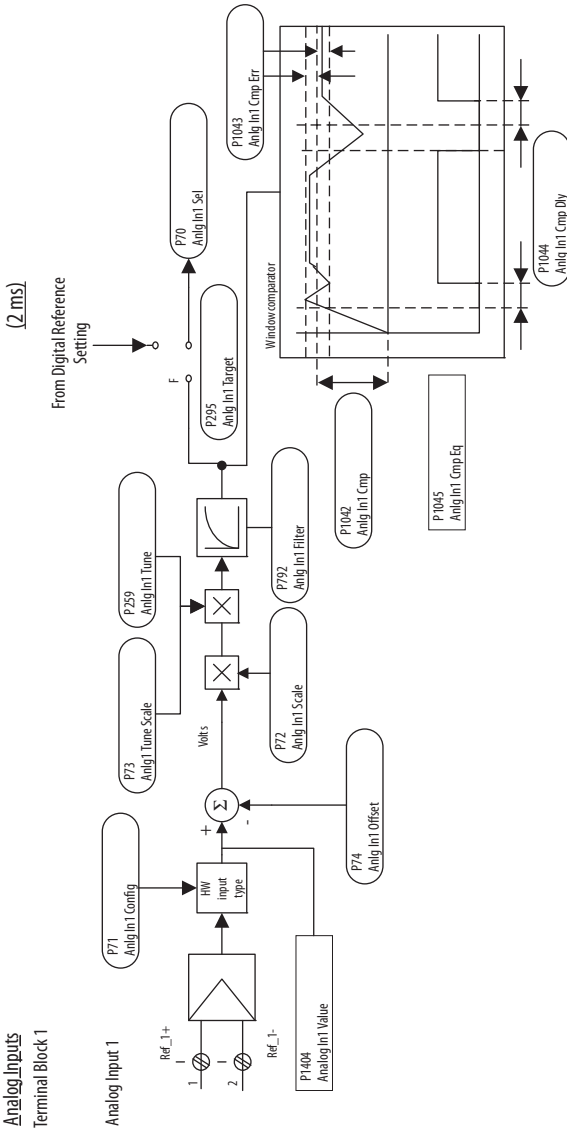
# PowerFlex DC Drive Overview



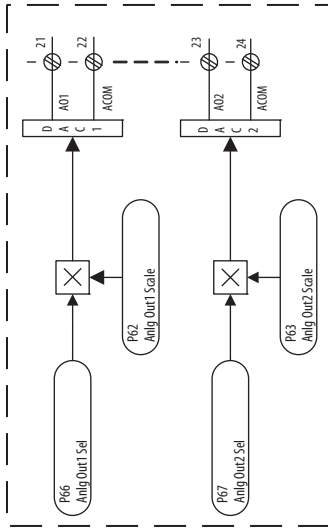


# Analog Inputs / Outputs

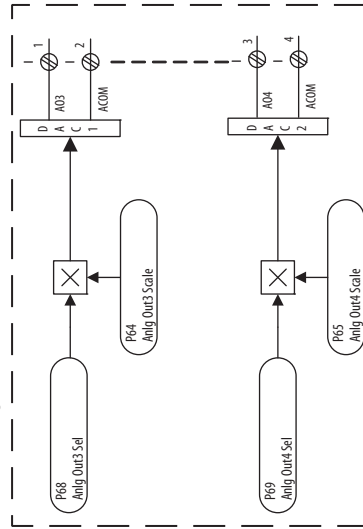
Analog Inputs  
Terminal Block 1



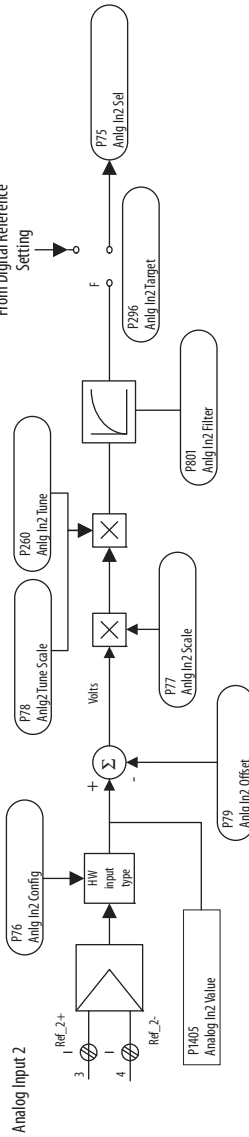
Analog Outputs  
Terminal Block 3



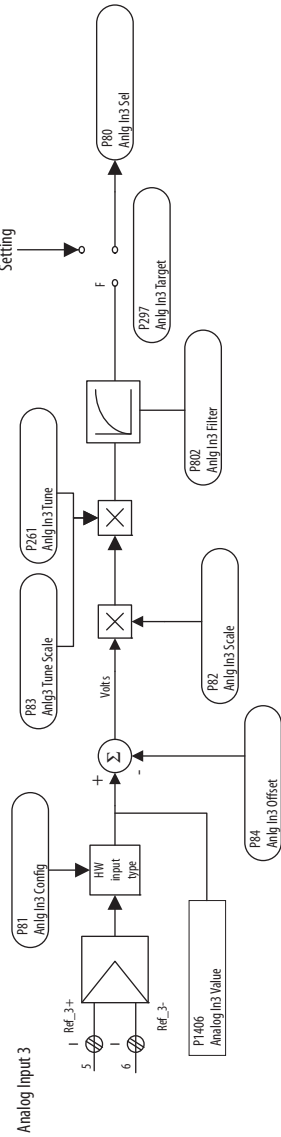
Expansion Analog Outputs (Optional)



Analog Input 2



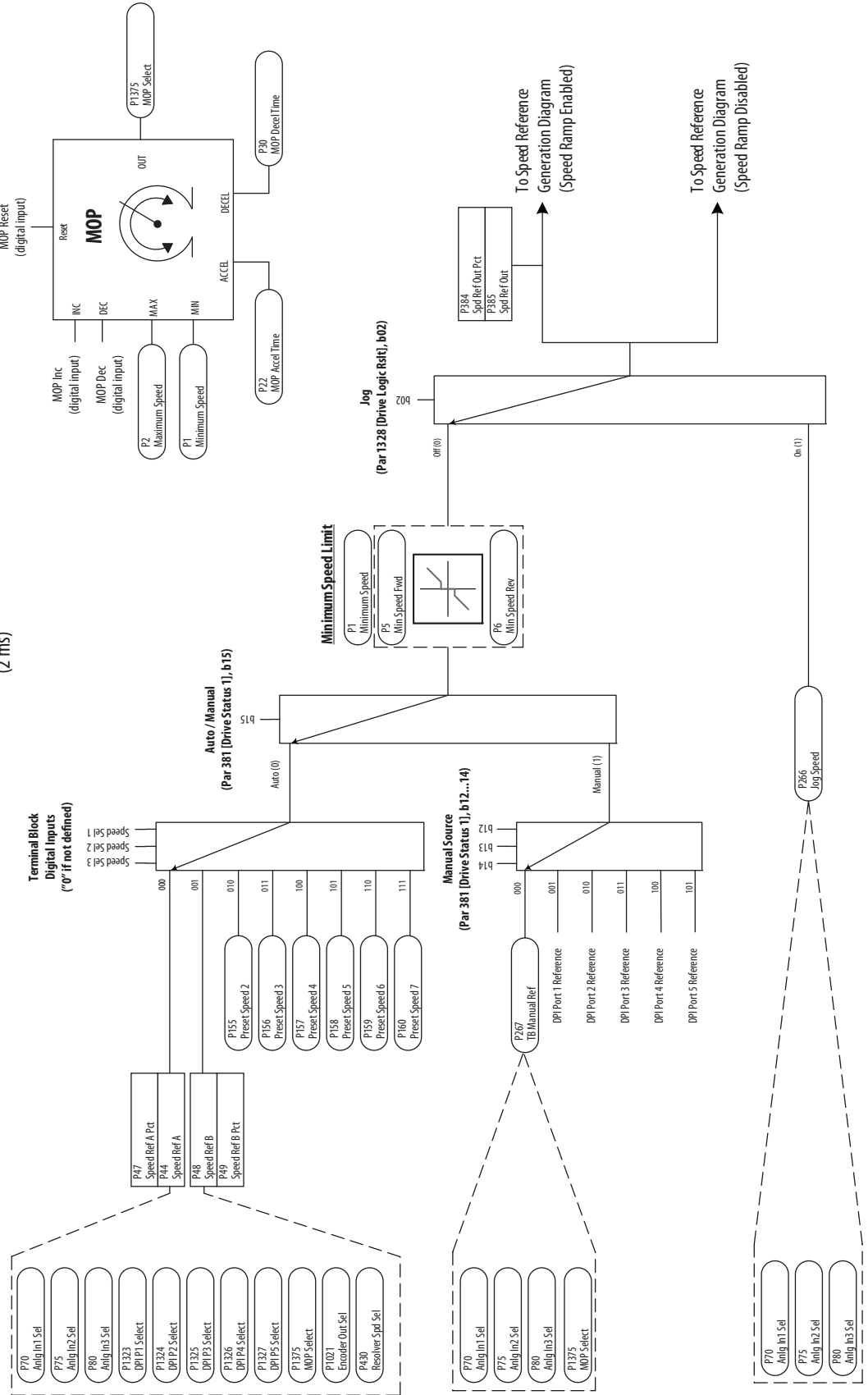
Analog Input 3





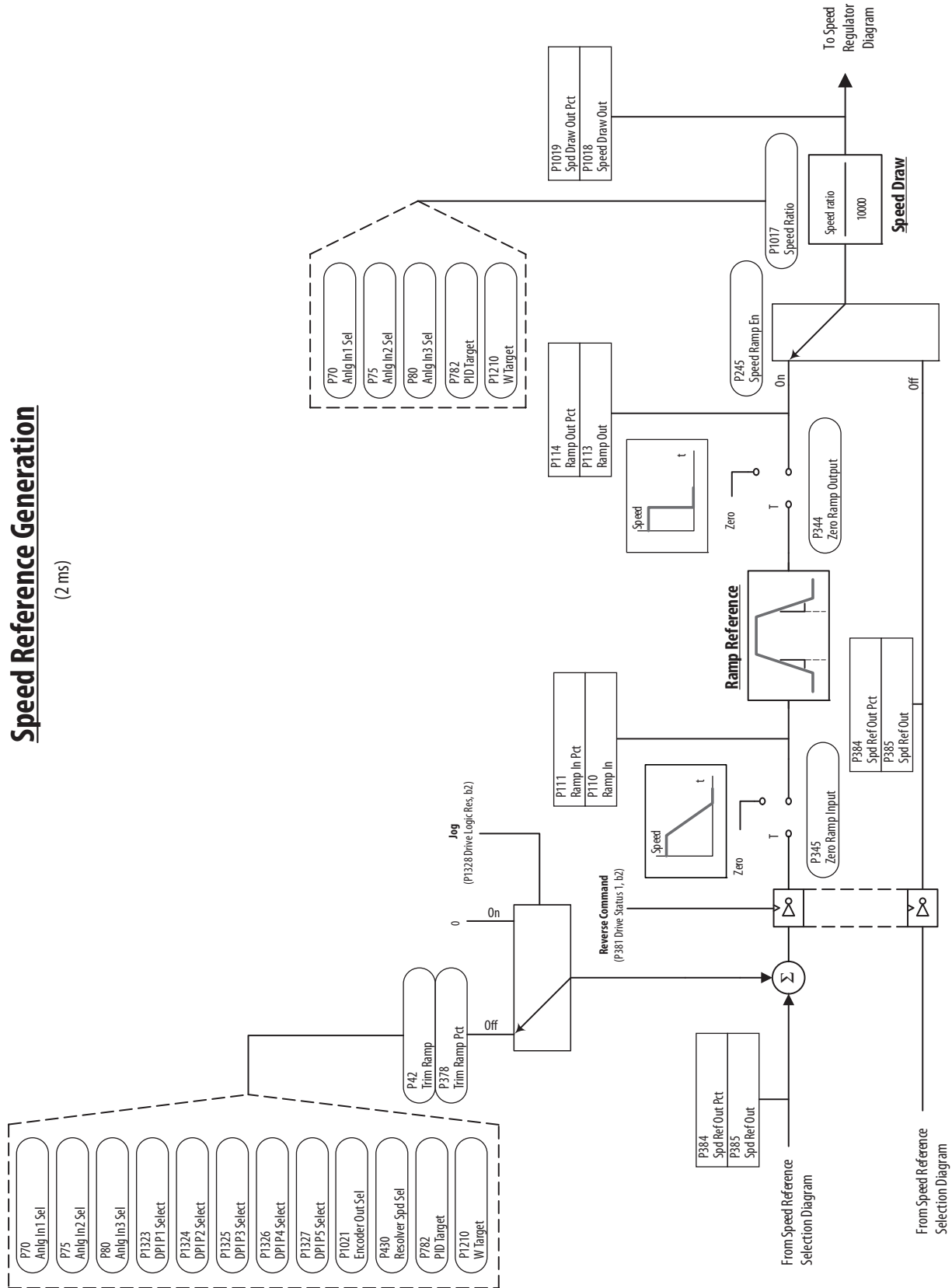
# Speed Reference Selection

(2 ms)



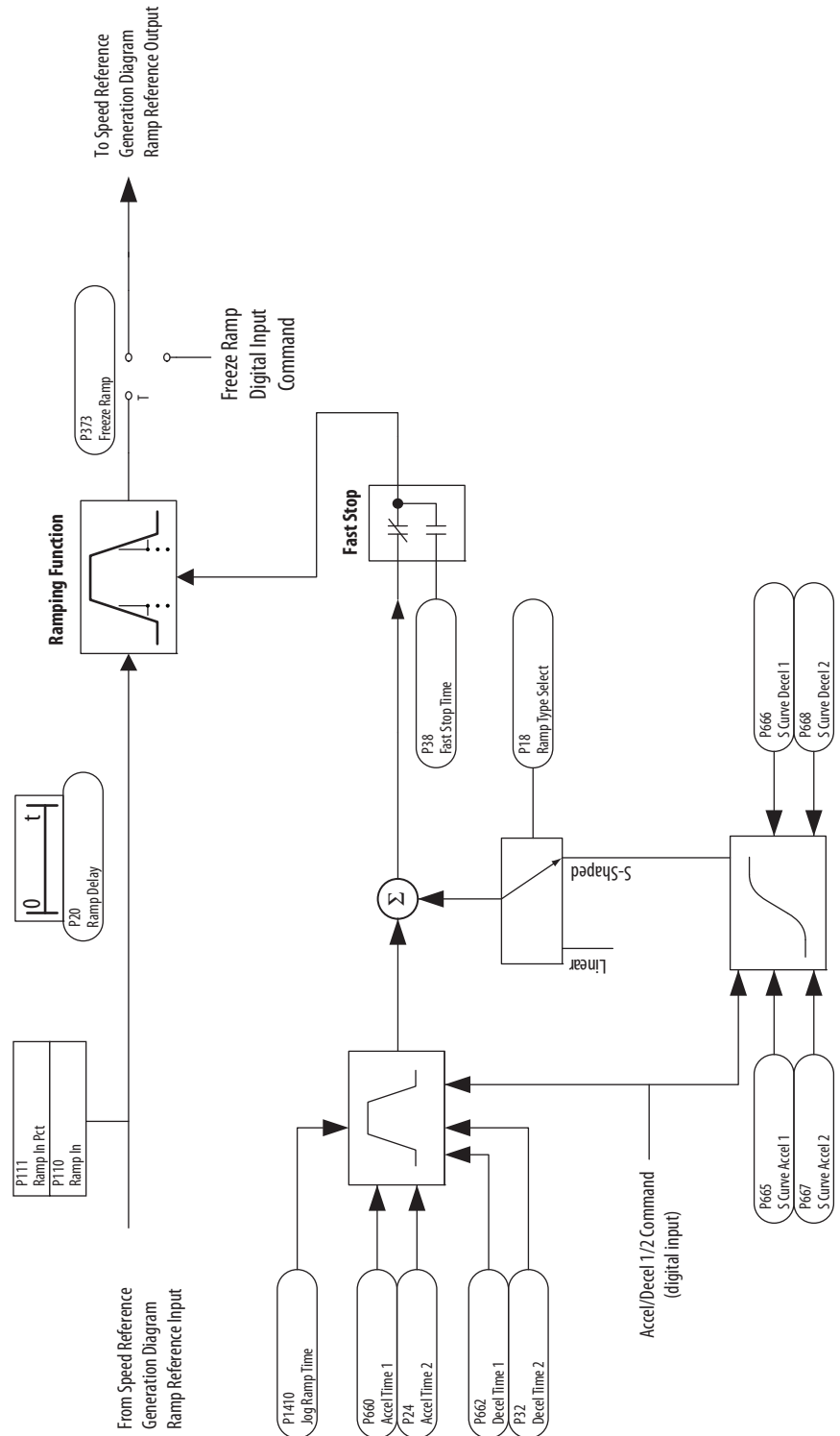
# Speed Reference Generation

(2. ms)



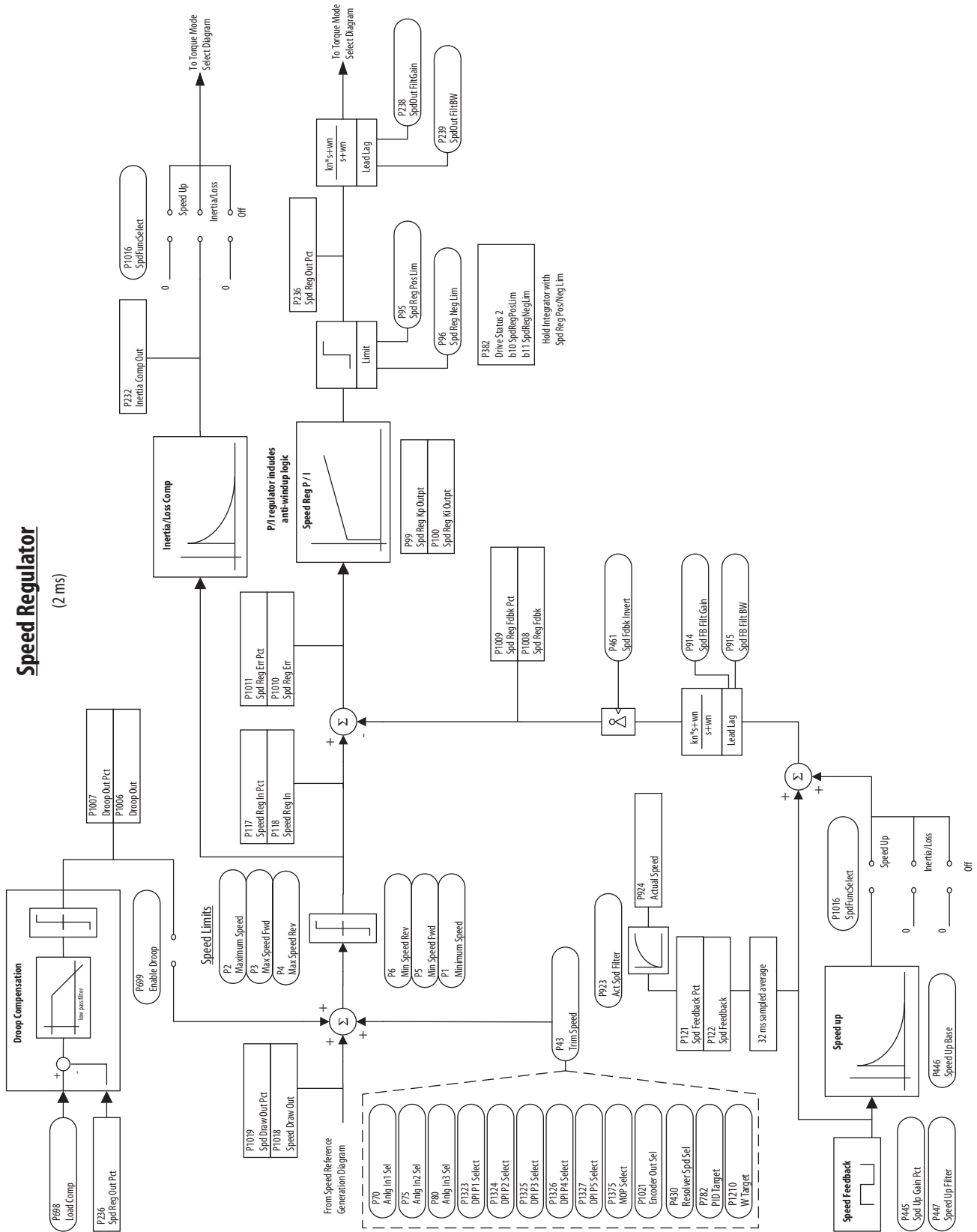
# Ramp Reference Block

(2 ms)



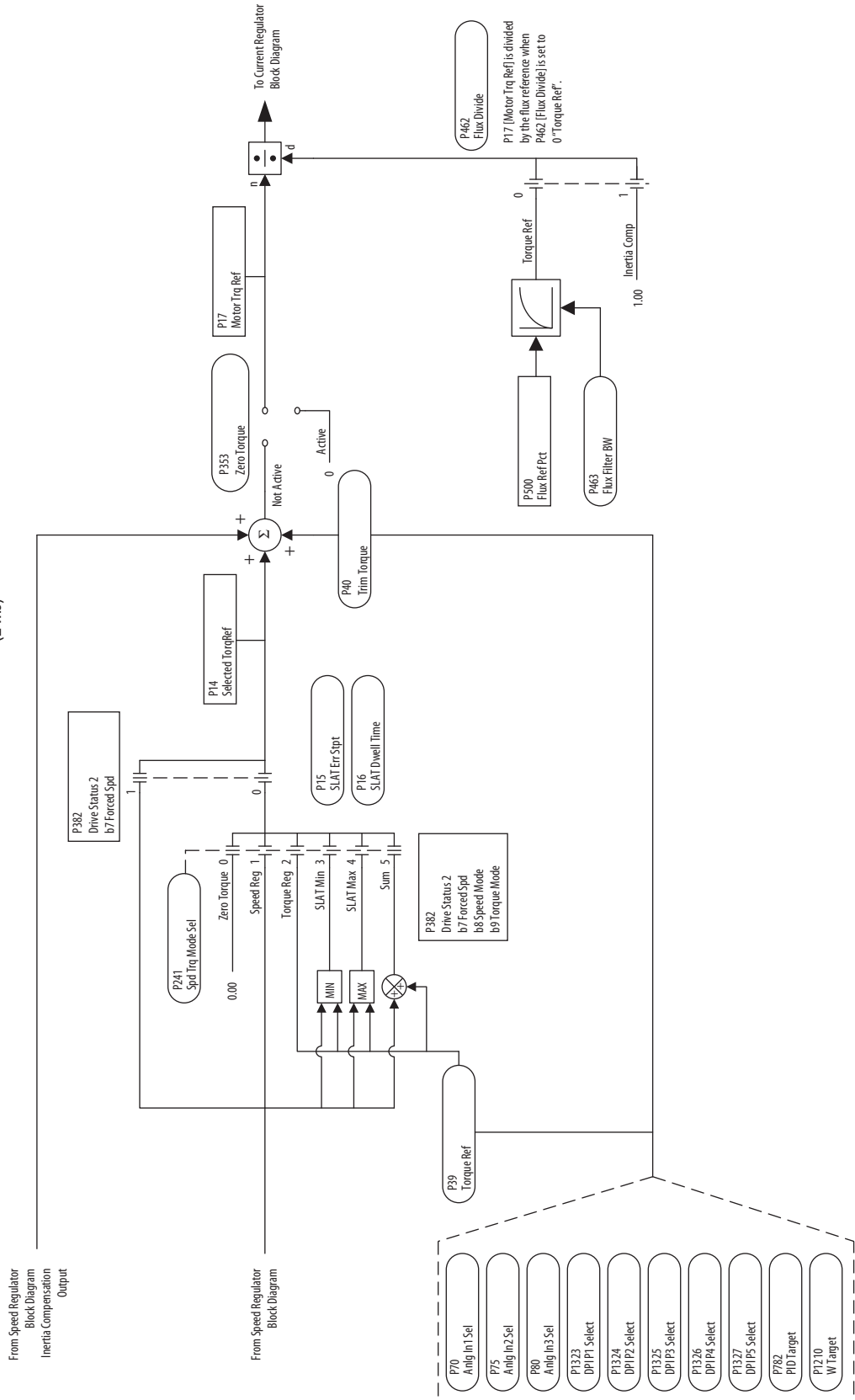
# Speed Regulator

(2 ms)



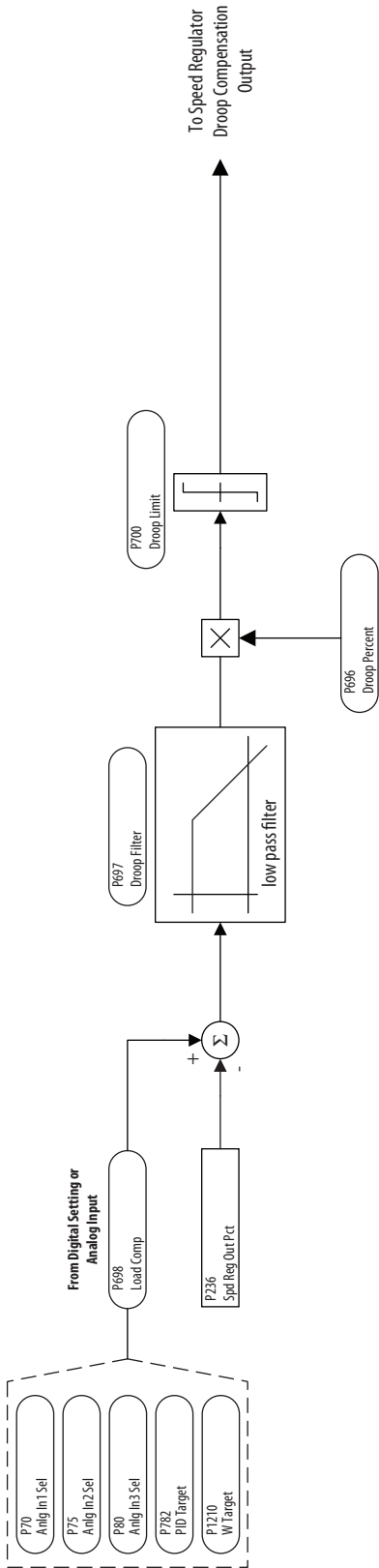
## Torque Mode Selection

(2 ms)



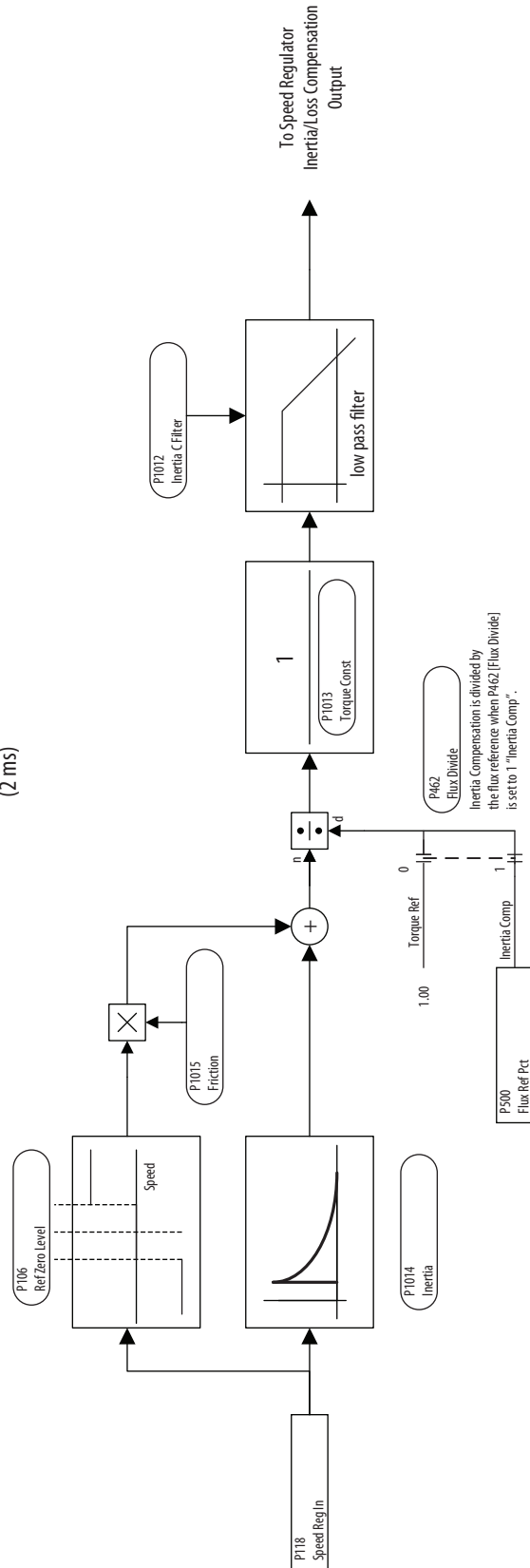
### Drop Compensation

(2 ms)



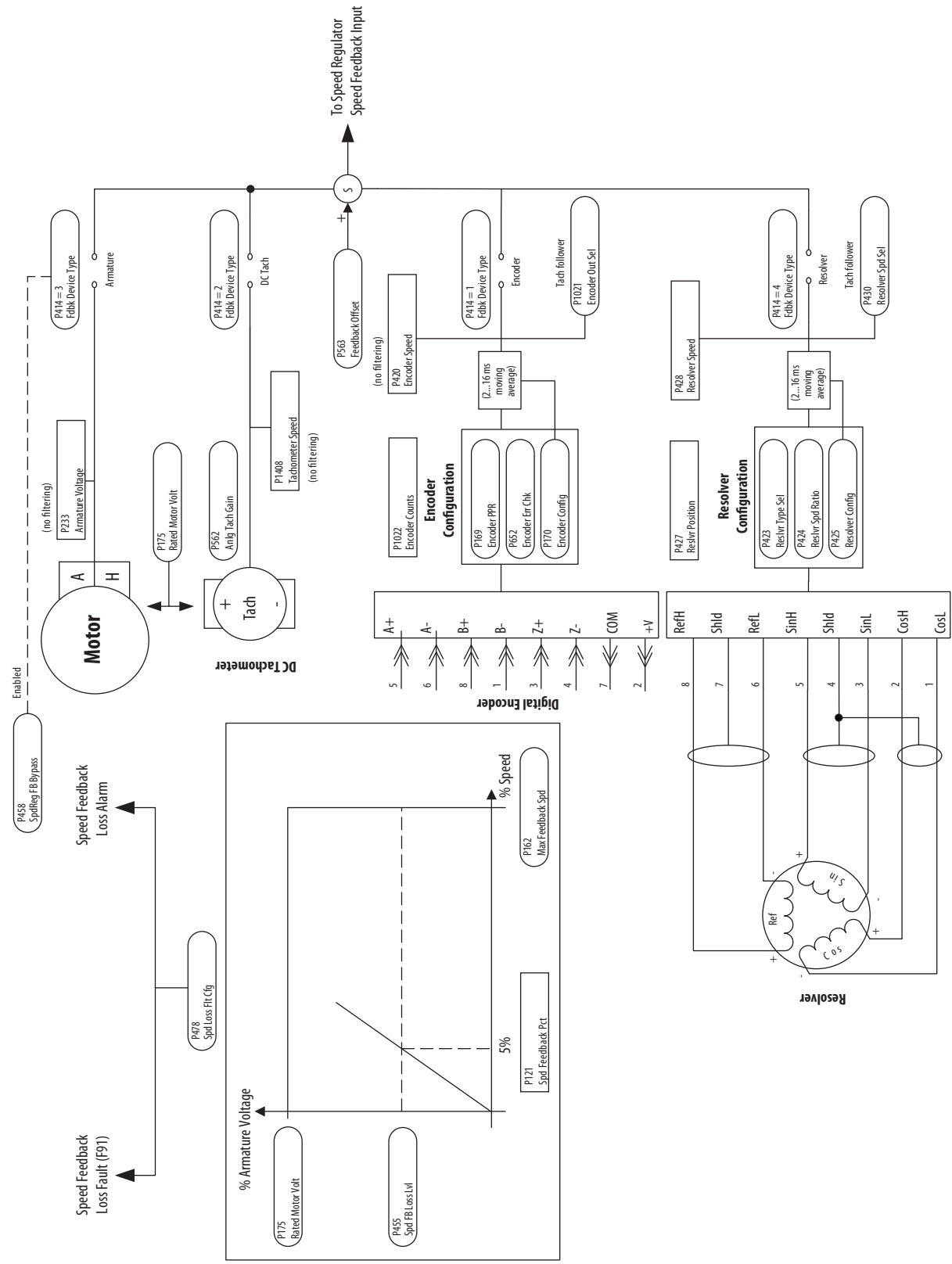
### Inertia/Loss Compensation

(2 ms)



# Speed Feedback

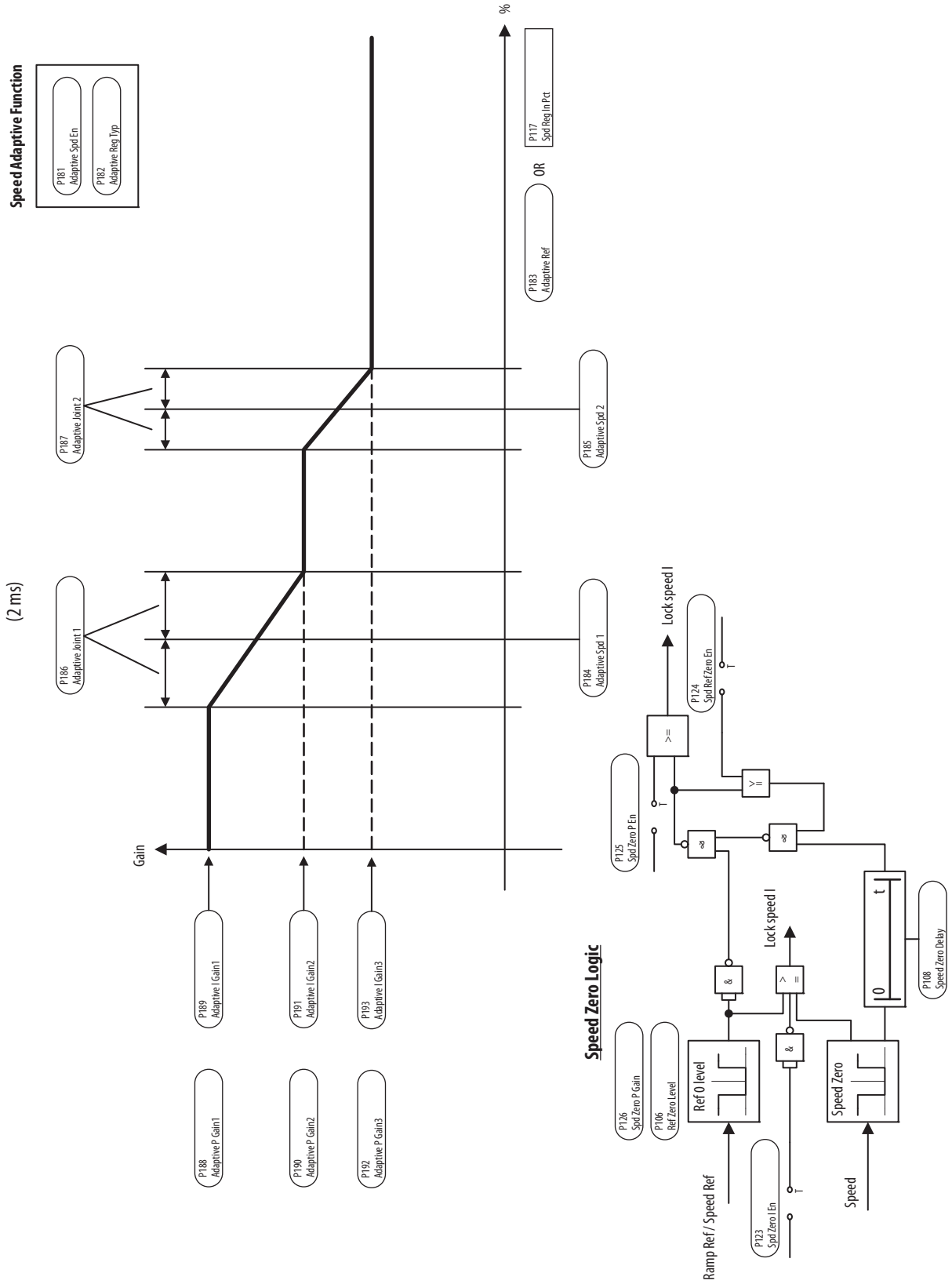
(2 ms)





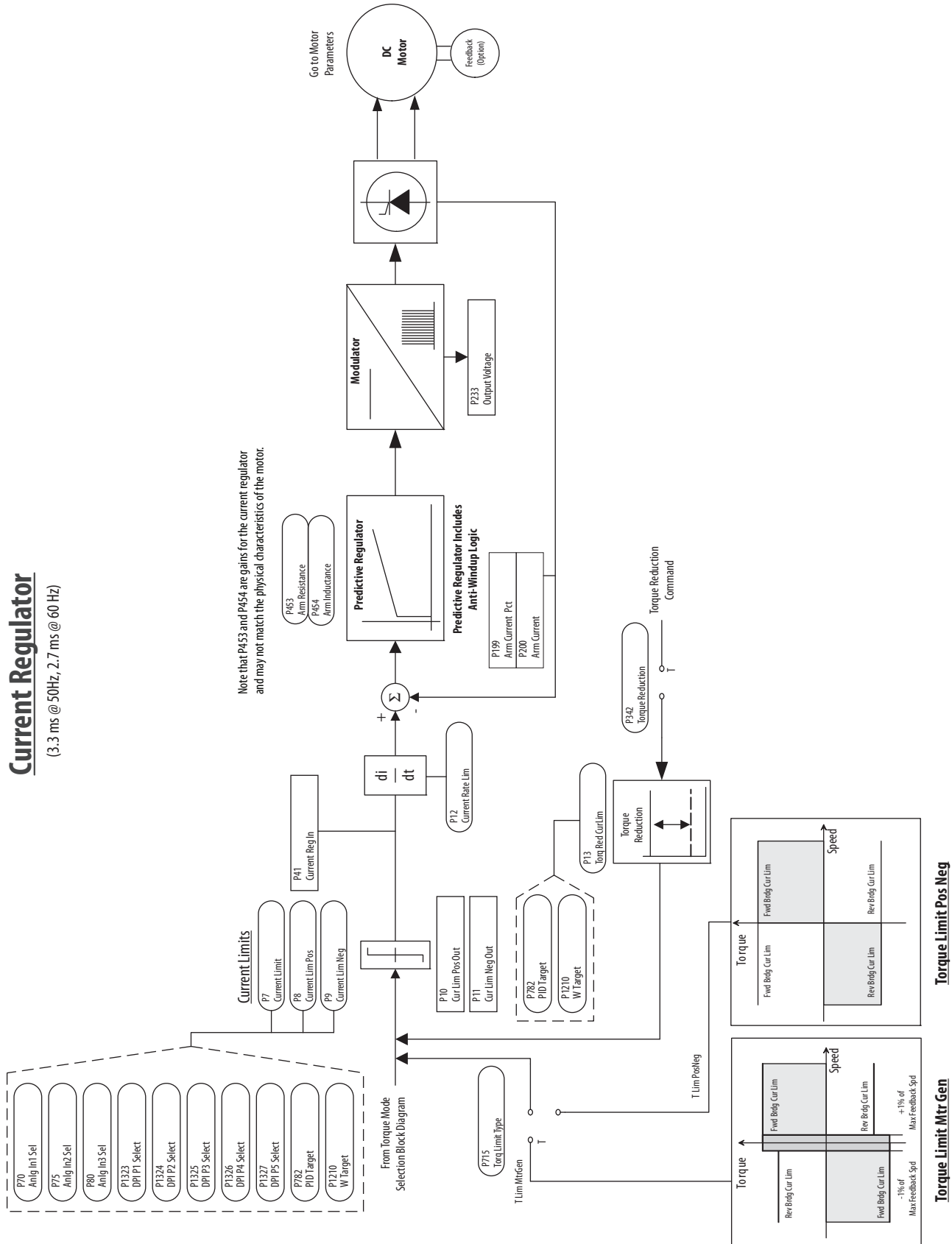


# Speed Adaptive and Speed Zero Logic



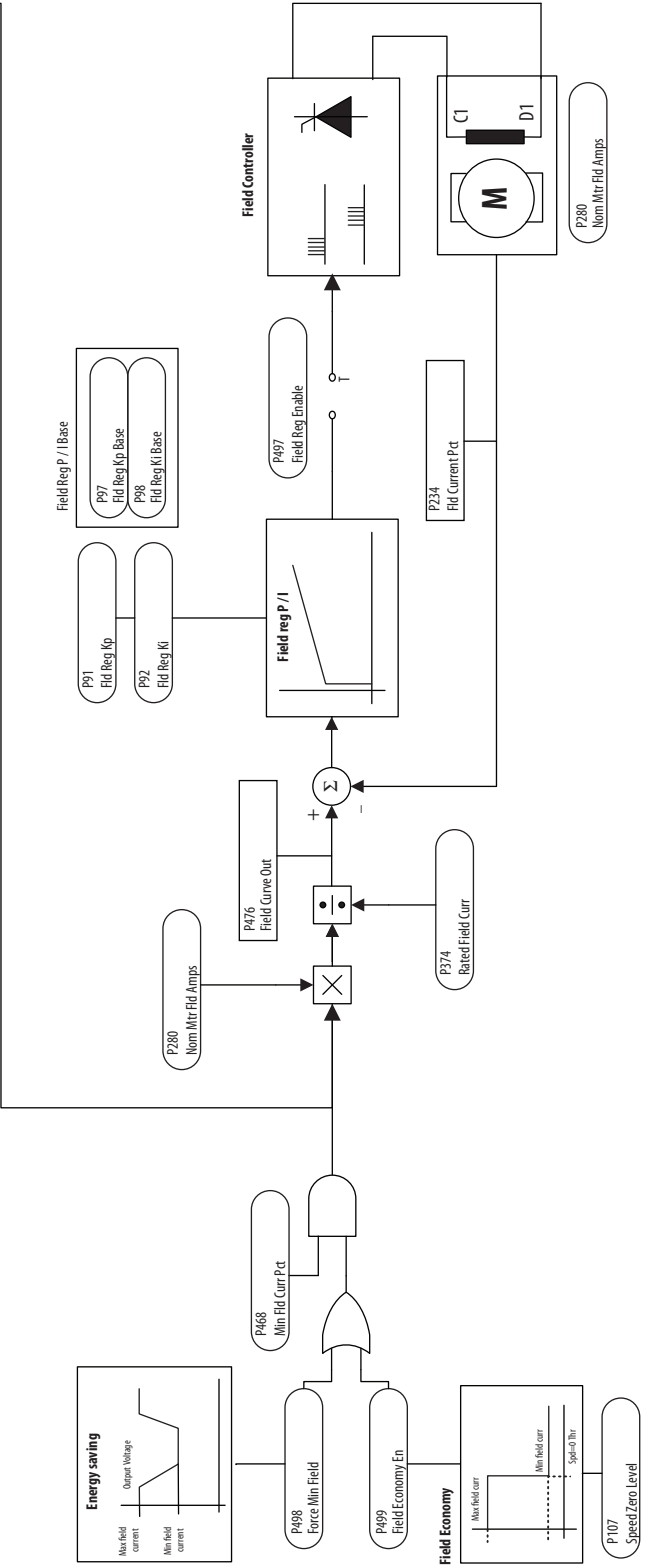
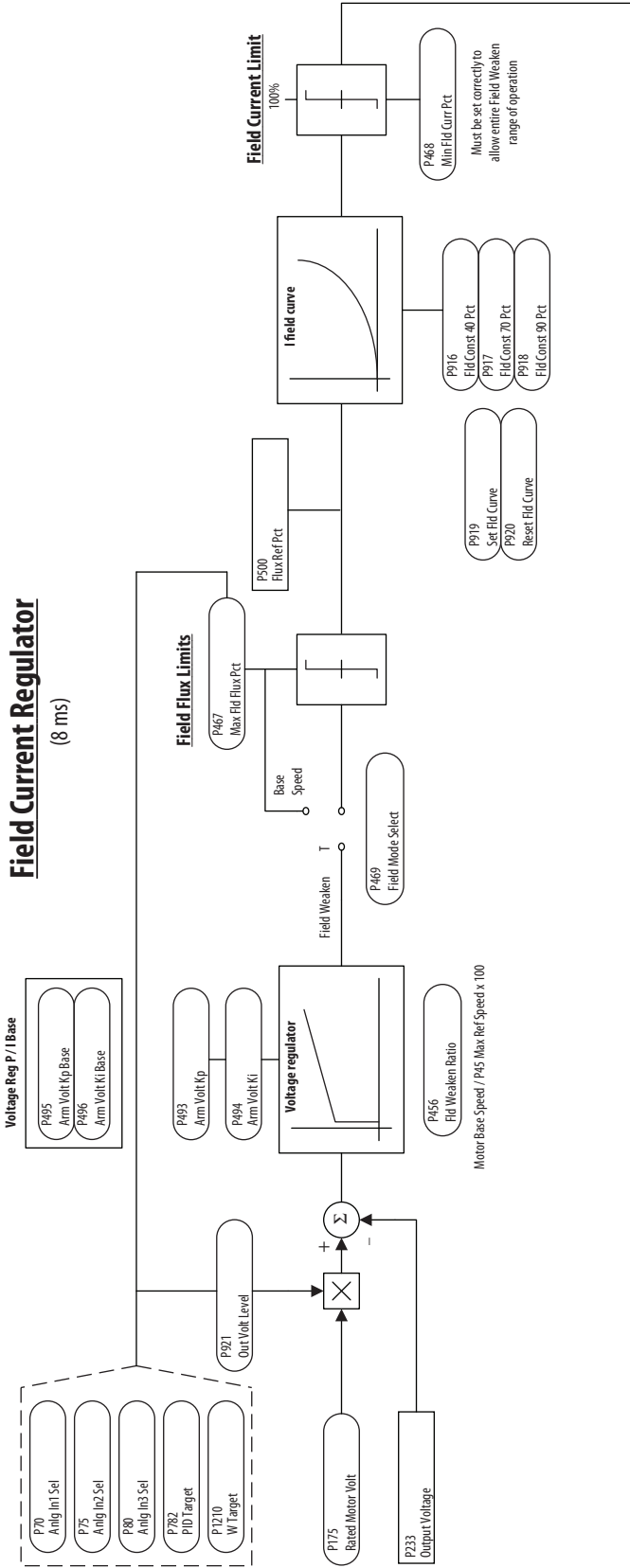
# Current Regulator

(3.3 ms @ 50Hz, 2.7 ms @ 60 Hz)

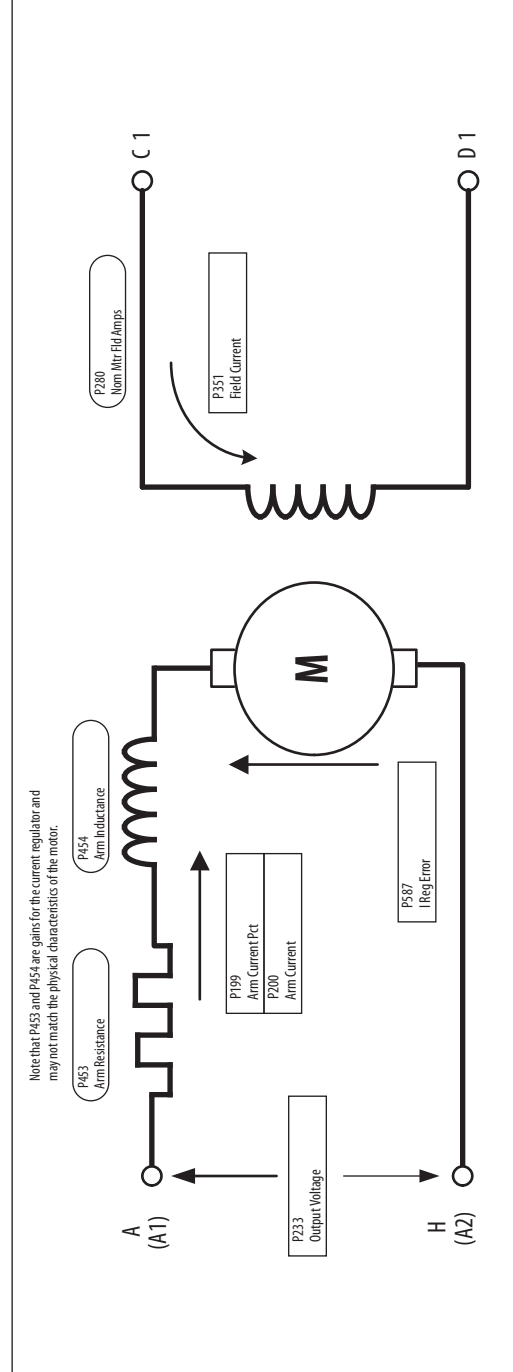
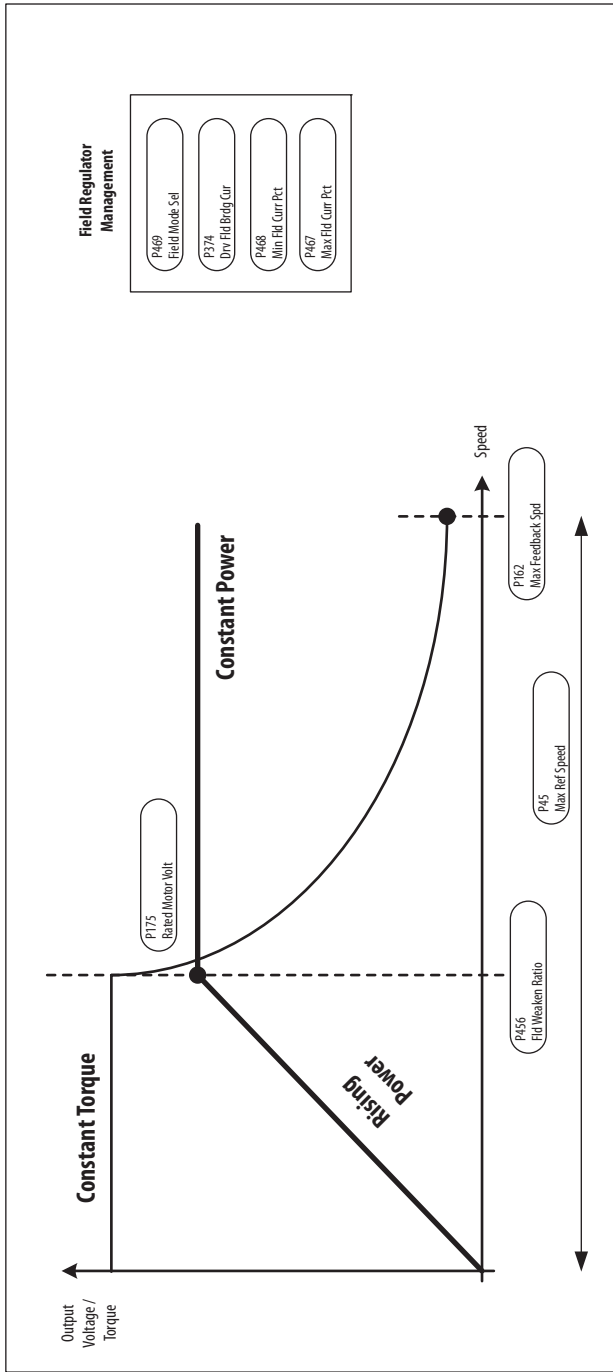


# Field Current Regulator

(8 ms)

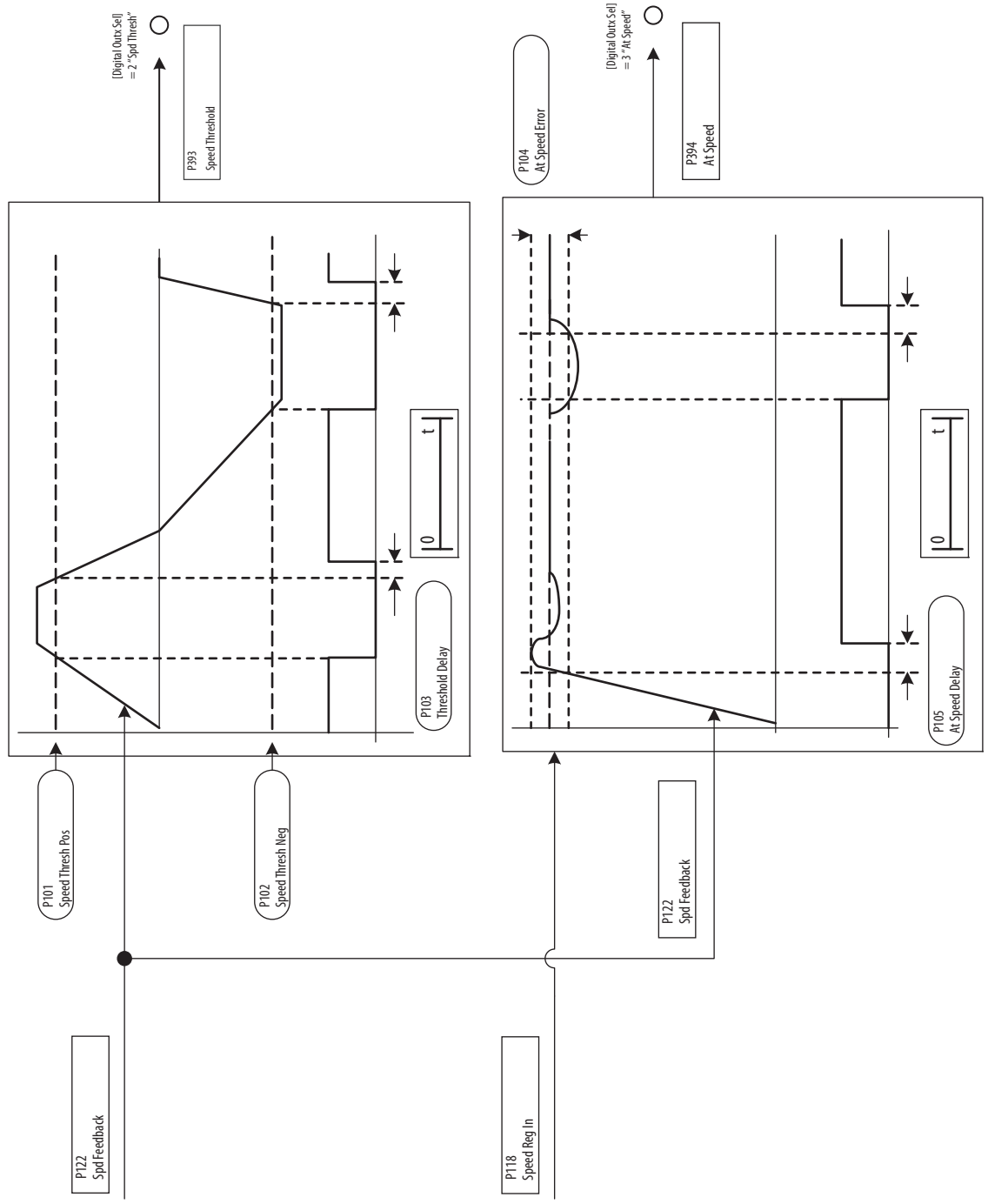


# Motor Parameters



# Speed Threshold / Speed Control

(2 ms)

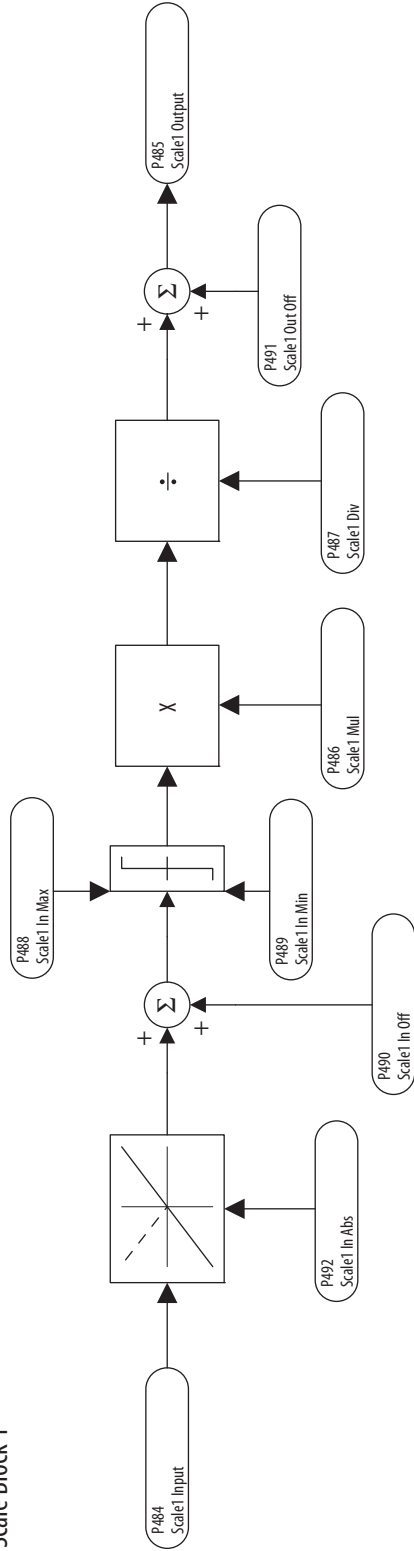




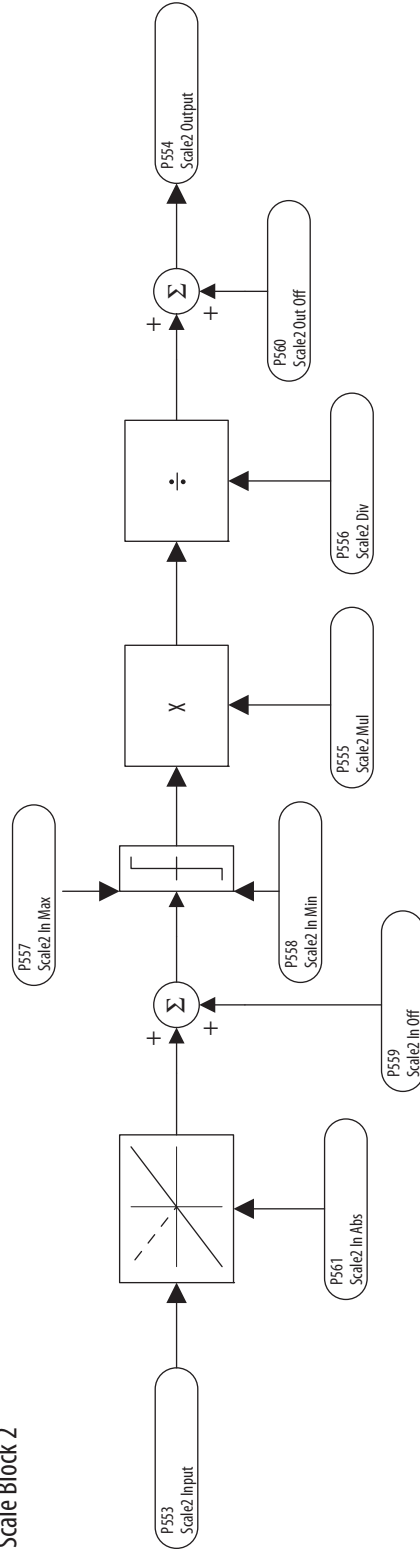
# Scale Blocks

(background)

Scale Block 1

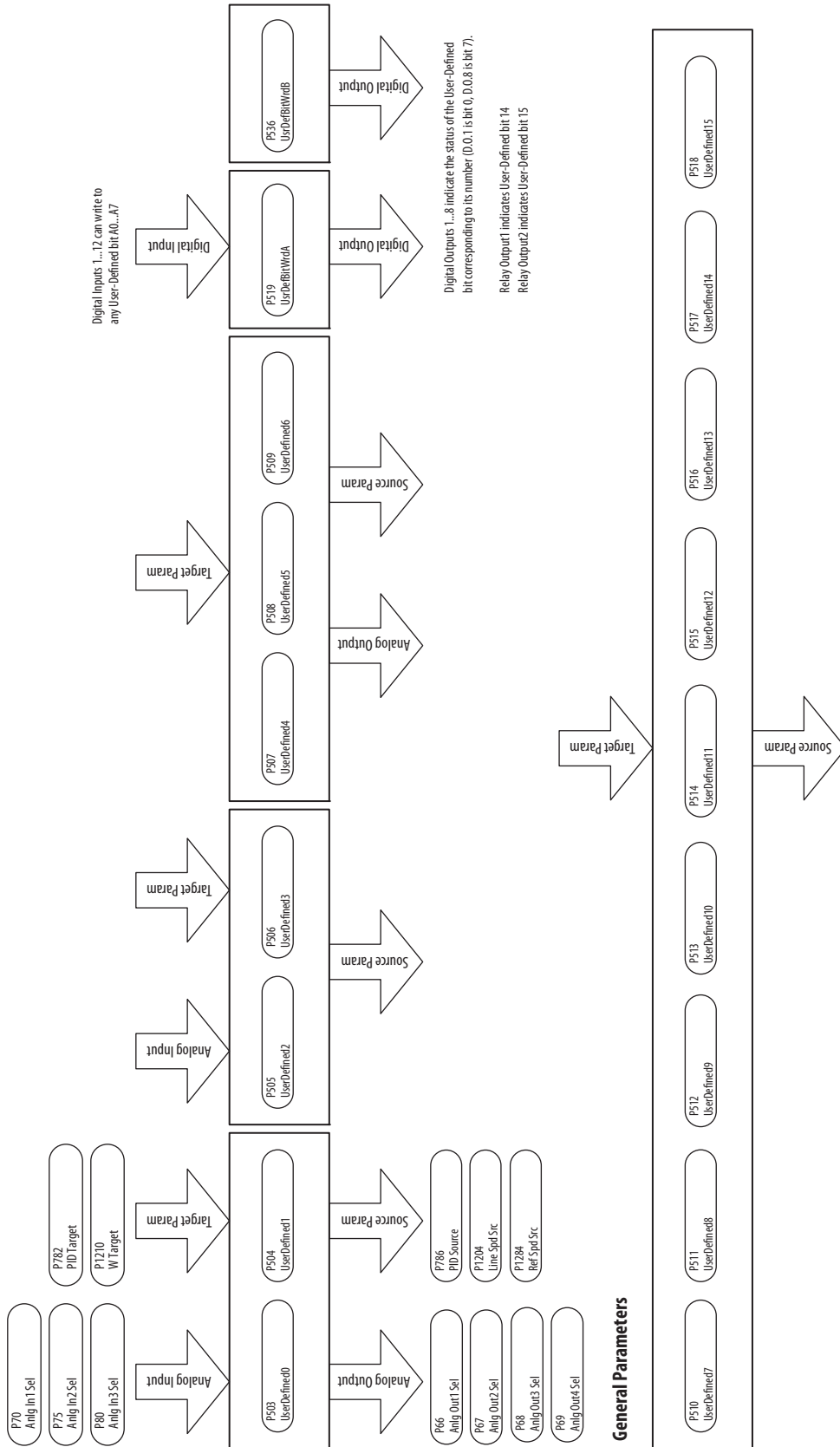


Scale Block 2



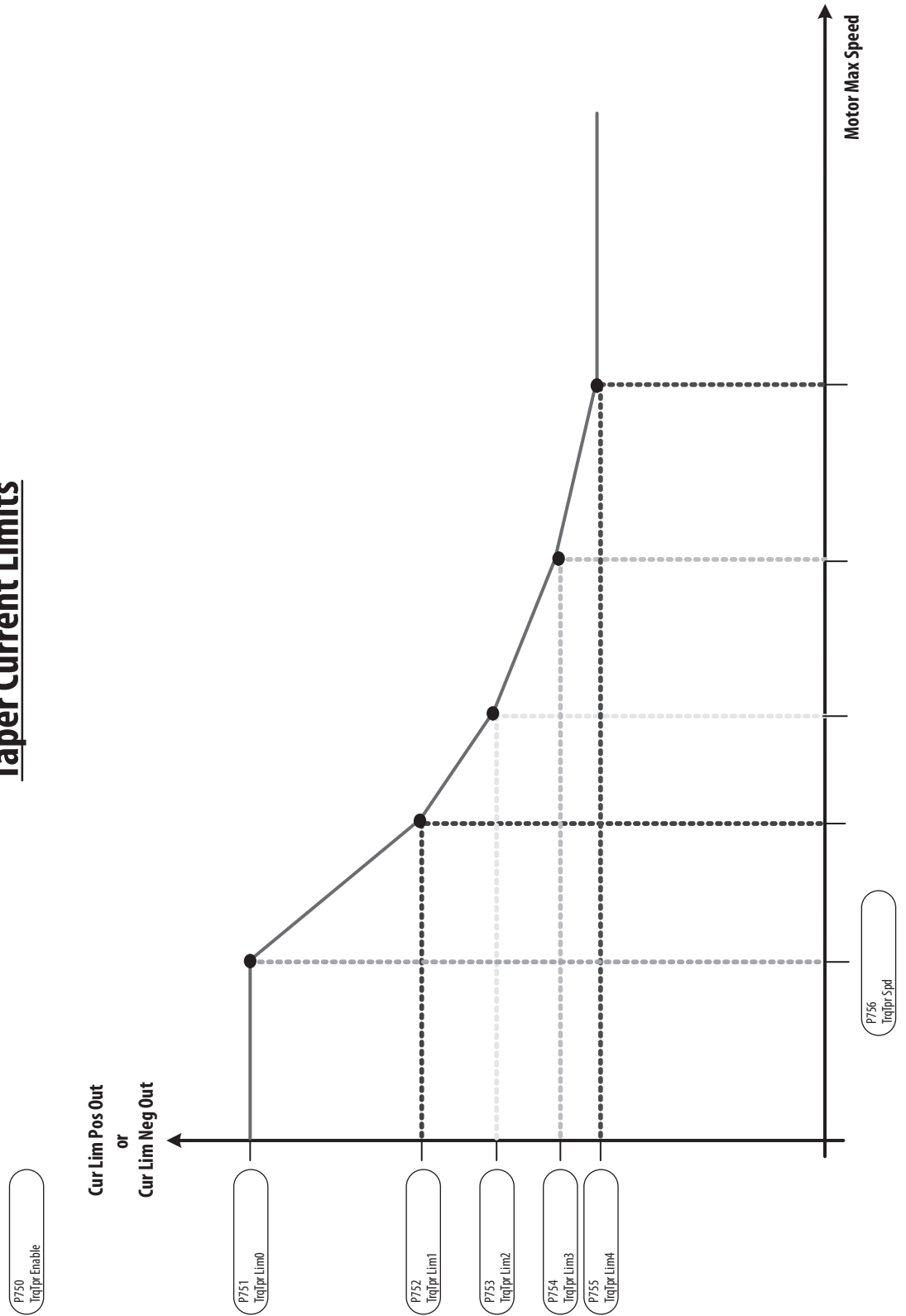
Note: Up to six scale blocks are available. Scale blocks 3-6 follow the same flow as scale blocks 1 and 2, shown here.

## User-Defined Parameters

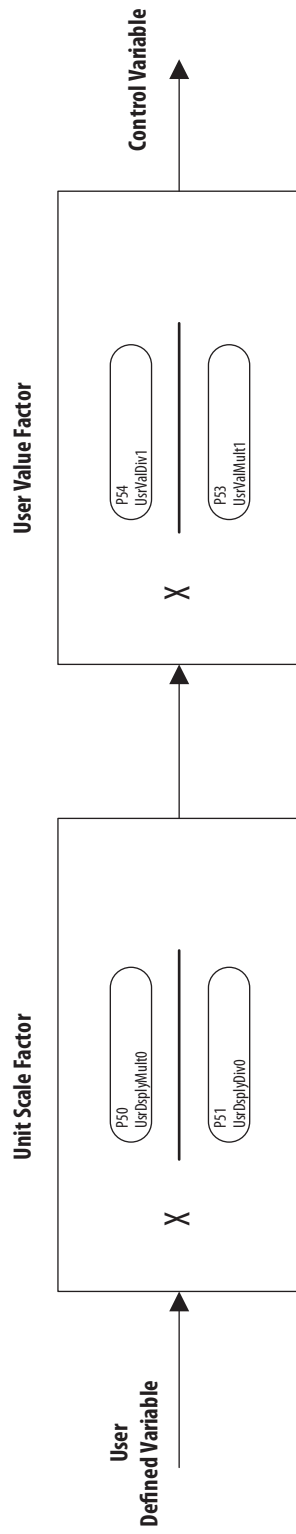




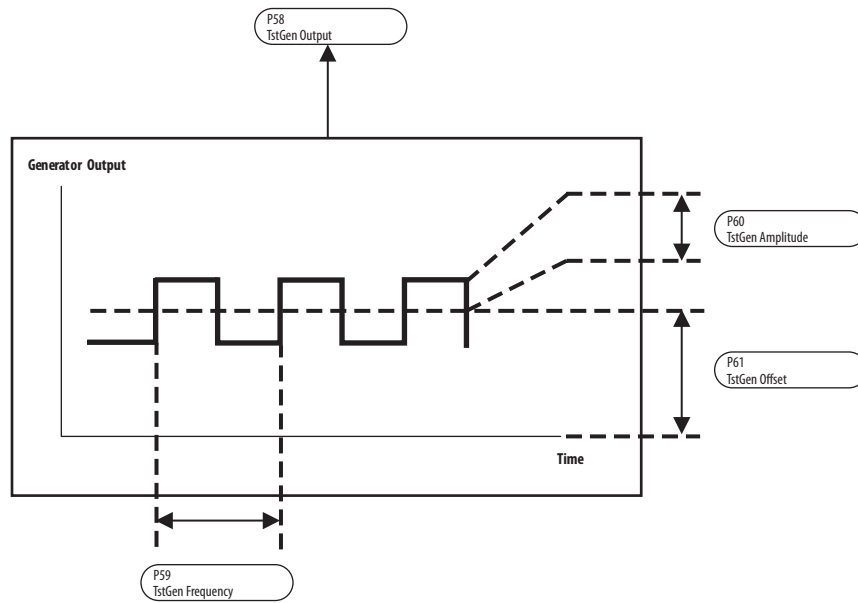
## Taper Current Limits



# Unit Scaling



## Test Generator



## Speed Select Settings

P402 Spd Select 2	P401 Spd Select 1	P400 Spd Select 0	Reference
0	0	0	P44 Speed Ref A
0	0	1	P48 Speed Ref B
0	1	0	P155 Preset Speed 2
0	1	1	P156 Preset Speed 3
1	0	0	P157 Preset Speed 4
1	0	1	P158 Preset Speed 5
1	1	0	P159 Preset Speed 6
1	1	1	P160 Preset Speed 7

## Fault/Alarm Mapping

### "Arm Overvoltage" (F5)

P203  
OverVolt Flt Cfg

- 0 = "Ignore"
- 1 = "Alarm"
- 2 = "Fault"

### "Fld Current Loss" (F6)

P473  
FldLoss Flt Cfg

- 0 = "Ignore"
- 1 = "Alarm"
- 2 = "Fault"

### "Auxiliary Input" (F2)

P354  
Aux Inp Flt Cfg

- 1 = "Alarm"
- 2 = "Fault"
- 3 = "Fast Stop"
- 4 = "Normal Stop"
- 5 = "CurrLim Stop"

### "Speed Fdbk Loss" (F91)

P478  
Spd Loss Flt Cfg

- 1 = "Alarm"
- 2 = "Fault"

### "Motor Over Temp" (F16)

P365  
OverTemp Flt Cfg

- 0 = "Ignore"
- 1 = "Alarm"
- 2 = "Fault"
- 3 = "Fast Stop"
- 4 = "Normal Stop"
- 5 = "CurrLim Stop"

### "Motor Overload" (F7)

P479  
MtrOvrld Flt Cfg

- 0 = "Ignore"
- 1 = "Alarm"
- 2 = "Fault"

## Installing a Communication Adapter

### Communication Adapter Kits

The following Communication Adapter kits are available for use with the PowerFlex® DC drive:

Comm Option	Catalog Number
BACnet® MS/TP RS-485 Communication Adapter	20-COMM-B
ControlNet™ Communication Adapter (Coax)	20-COMM-C
DeviceNet™ Communication Adapter	20-COMM-D
EtherNet/IP™ Communication Adapter	20-COMM-E
HVAC Communication Adapter	20-COMM-H
PROFIBUS™ DP Communication Adapter	20-COMM-P
ControlNet™ Communication Adapter (Fiber)	20-COMM-Q
Remote I/O Communication Adapter <sup>(1)</sup>	20-COMM-R
RS-485 DF1 Communication Adapter	20-COMM-S
External Comms Power Supply	20-XCOMM-PS1
DPI External Communication Kit	20-XCOMMDC-BASE
External DPI I/O Option Board <sup>(2)</sup>	20-XCOMMIO-OPT1
Compact I/O to DPI/SCANport Module	1769-SM1
Serial Null Modem Adapter	1203-SNM
Smart Self-powered Serial Converter (RS-232) includes 1203-SFC and 1202-C10 Cables	1203-SSS
Universal Serial Bus™ (USB) Converter includes 2m USB, 20-HIM-H10 & 22-HIM-H10 Cables	1203-USB

(1) This item has Silver Series status. For information, refer to <http://www.ab.com/silver>.

(2) For use only with External DPI Communication Kits 20-XCOMM-DC-BASE.

### What The Communication Adapter Kit Includes

- Communication Adapter module w/captive screws
- Internal Interface cable
- Communication Adapter User Manual
- Additional components, based on the option selected

### Tools That You Need

- Phillips screwdriver

## Safety Precautions



**ATTENTION:** Allow only qualified personnel familiar with drives, power products and associated machinery to plan or implement the installation, start-up, configuration and subsequent maintenance of the system. Failure to comply may result in personal injury and/or equipment damage.



**ATTENTION:** To avoid an electric shock hazard, verify that all power to the drive has been removed before performing the following.



**ATTENTION:** This drive contains **ESD** (Electrostatic Discharge) sensitive parts and assemblies. Static control precautions are required when installing, testing, servicing or repairing this assembly. Component damage may result if ESD control procedures are not followed. If you are not familiar with static control procedures, reference A-B publication 8000-4.5.2, "Guarding Against Electrostatic Damage" or any other applicable ESD protection handbook.

## Installing the Communication Adapter Module in the Drive

Follow these steps to install a communication adapter module:

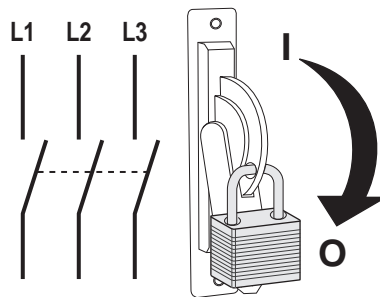


**WARNING:** Remove power before making or breaking cable connections. When you remove or insert a cable connector with power applied, an electrical arc may occur. An electrical arc can cause personal injury or property damage by:

- sending an erroneous signal to your system's field devices, causing unintended machine motion
- causing an explosion in a hazardous environment

Electrical arcing causes excessive wear to contacts on both the module and its mating connector. Worn contacts may create electrical resistance.

1. Remove and lock-out all incoming power to the drive.

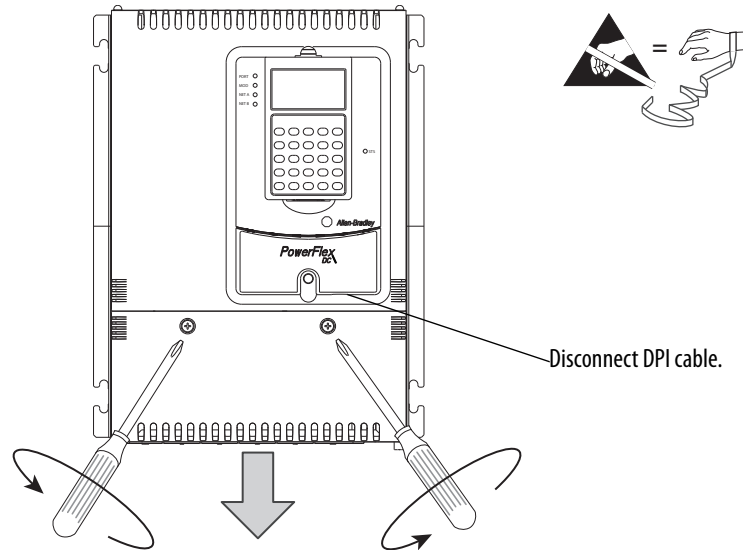


2. Disconnect the DPI cable from the HIM on the drive.

### 3. Remove the cover(s) from the drive:

#### Frame A

- a. Remove the screws that secure the bottom cover to the drive, then slide the cover down and off the drive chassis.

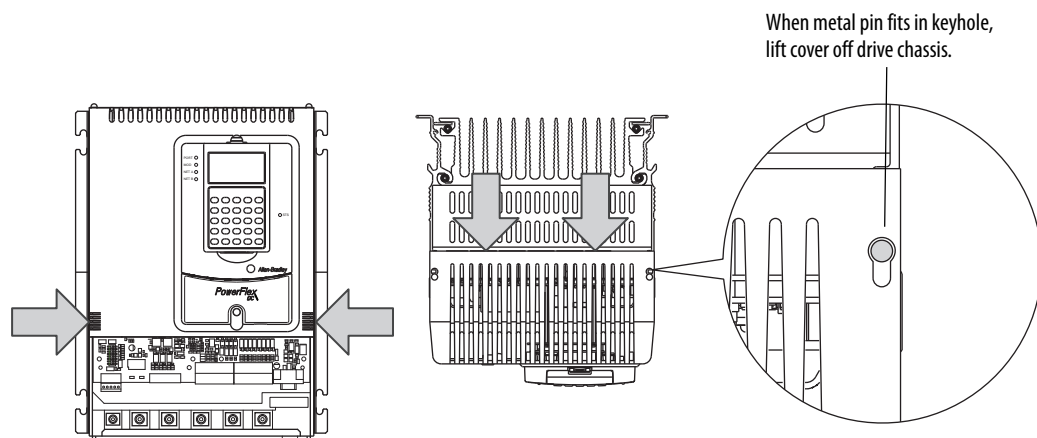


- b. Press in on the sides at the bottom edge of the top cover and at the same time pull the cover toward you to pull it partially off the drive chassis. Next, at the top of the drive, pull the cover forward, away from the drive, until the pins fit in the keyhole in the top of the cover, then carefully lift the cover off of the drive chassis.

---

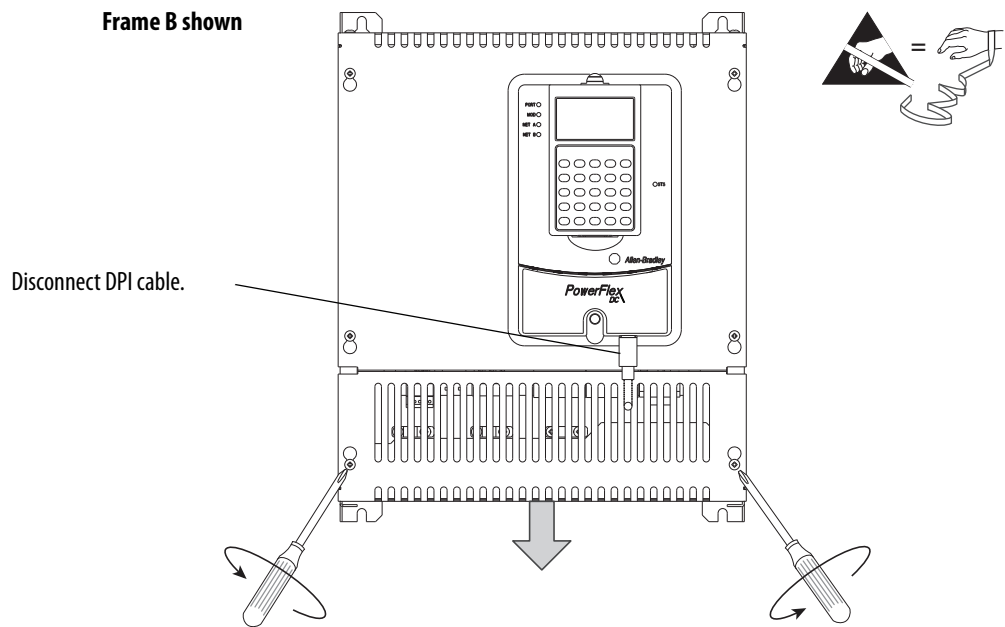
**IMPORTANT** The HIM assembly is connected to the control board by a cable and therefore will not pull free from the drive until disconnected. See step 4 page [389](#) for instructions.

---



## Frames B and C

- a. Loosen, but do not remove, the screws that secure the bottom cover to the drive, then slide the cover down and off the drive chassis.

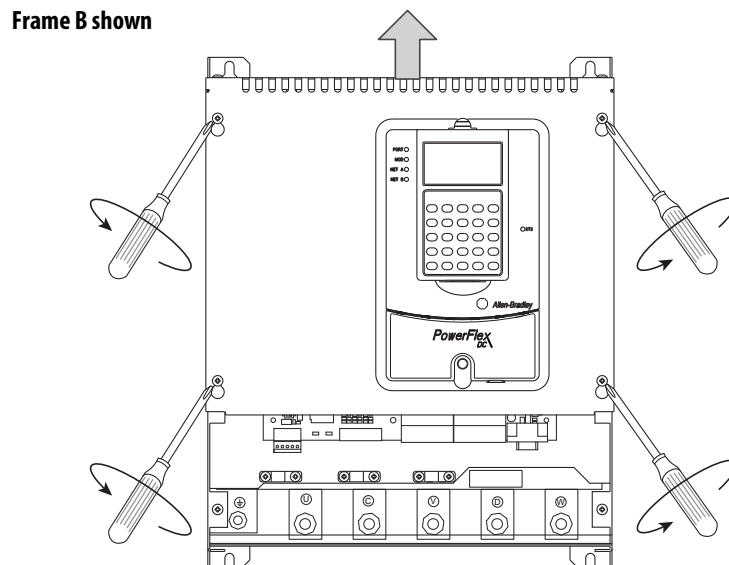


- b. Loosen, but do not remove, the screws that secure the top cover to the drive, then slide the cover up and off the drive chassis.

---

**IMPORTANT** The HIM assembly is connected via a cable to the control board and therefore will not pull free from the drive until disconnected. See step 4 on page [389](#) for instructions.

---





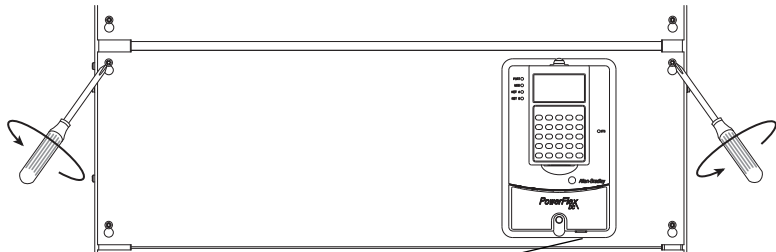
### Frame D

- a. Loosen, but do not remove, the Hexalobular head screws that secure the cover, containing the HIM cradle, to the drive frame. Then, slide the cover up until the screw heads line up with the key holes and lift the cover off the chassis.

---

**IMPORTANT** The HIM assembly is connected to the control board by a cable and therefore will not pull free from the drive until disconnected. See step 4 below for instructions.

---



Disconnect DPI cable.

4. Disconnect the HIM Communication cable from the connector on the upper right corner of the control board and set the cover aside.

**All Frames (Frame A shown)**



Pull tabs out to disconnect cable.

- Secure and ground the Communication Adapter to the EMI Shield on the drive using the four captive screws.

---

**IMPORTANT** All screws must be tightened, because the adapter is grounded through a screw to the EMI shield. Recommended tightening torque is 0.9 N•m (8 lb•in).

---

- Connect the Internal Interface cable to the DPI connectors on the control board and the communication Adapter board.



- Refer to the Adapter's User Manual for network connection, commissioning, and configuration information.
- Install the HIM Communication cable in reverse order of removal.
- Install the drive covers in reverse order of removal.

## Optional Analog and Digital I/O Expansion Circuit Board

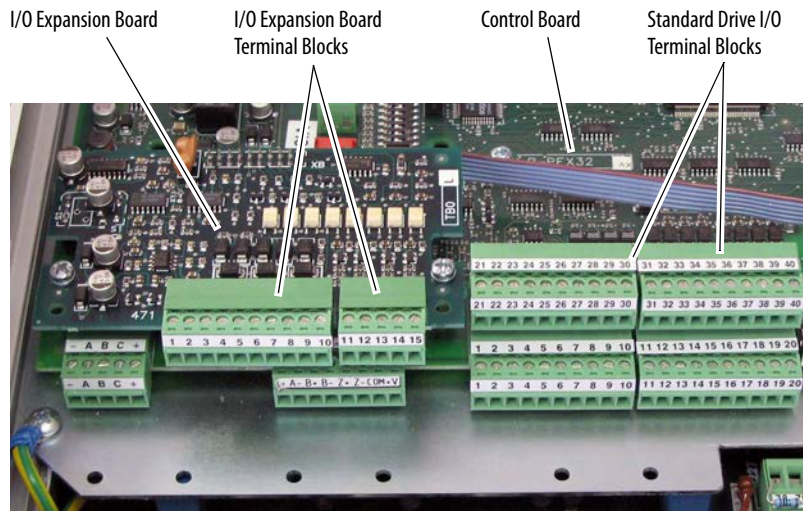
### What This Option Board Provides

The optional I/O expansion circuit board<sup>(1)</sup> is mounted on the control circuit board of the drive and provides these additional I/O signals:

- Four Digital Inputs
- Four Digital Outputs
- Two Analog Outputs

This circuit board is catalog number 20P-S5V62.

**Figure 106 - I/O Expansion Board Mounting Location**



### I/O Expansion Board Wiring

**Table 94 - Recommended Signal Wire Size**

Wire Type and Size			Tightening Torque N•m (lb•in)
Flexible (mm <sup>2</sup> )	multi-core (mm <sup>2</sup> )	AWG	
0.14...1.5	0.14...1.5	28...16	0.4 (3.5)

(1) The Analog and Digital I/O Expansion circuit board is not factory installed.

A 75 x 2.5 x 0.4 mm (3.0 x 0.1 x 0.02 in.) flathead screwdriver is recommended for connecting wire to the terminal block inputs. Strip the ends of the cables to a length of 6.5 mm (0.26 in.).

**IMPORTANT** To improve the noise immunity it is recommended that you connect the common of the outputs (terminals 2, 4, 5 and 15 of the I/O Expansion board) with the ground (terminal 10 or 20) on the standard I/O terminal blocks on the control board. If this is not possible, these terminals must be grounded by means of a 0.1 mf/250V capacitor.

Table 95 - I/O Expansion Board Terminal Block 1 Designations

No.	Signal	Description	Factory Default	Config. Parameter
1	Analog Output 3 (+)	±10V, 5 mA maximum	18 "Fld Current"	68 [Anlg Out3 Sel]
2	Analog Output 3 (-)			
3	Analog Output 4 (+)	±10V, 5 mA maximum	14 "Motor Volts"	69 [Anlg Out4 Sel]
4	Analog Output 4 (-)			
5	Digital Output Common	-	-	-
6	Digital Output 5 (+)	Max volt. +30V, max cur. 50 mA	26 "Alarm"	149 [Digital Out5 Sel]
7	Digital Output 6 (+)			
8	Digital Output 7 (+)			
9	Digital Output 8 (+)			
10	+24VDC	Drive supplied power for Digital Outputs. Max volt. +30V, max. cur. 80 mA.	-	-

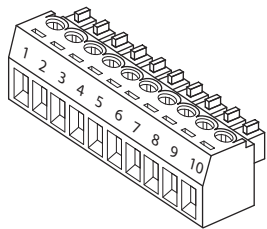


Table 96 - I/O Expansion Board Terminal Block 2 Designations

No.	Signal	Description	Factory Default	Config. Parameter
11	Digital Input 9	Max volt. +30V, max cur. 15V/3.2 mA, 24V/5 mA, and 30V/6.4 mA.	-	-
12	Digital Input 10			
13	Digital Input 11			
14	Digital Input 12	-	-	
15	Digital Input Common	-	-	

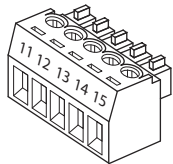
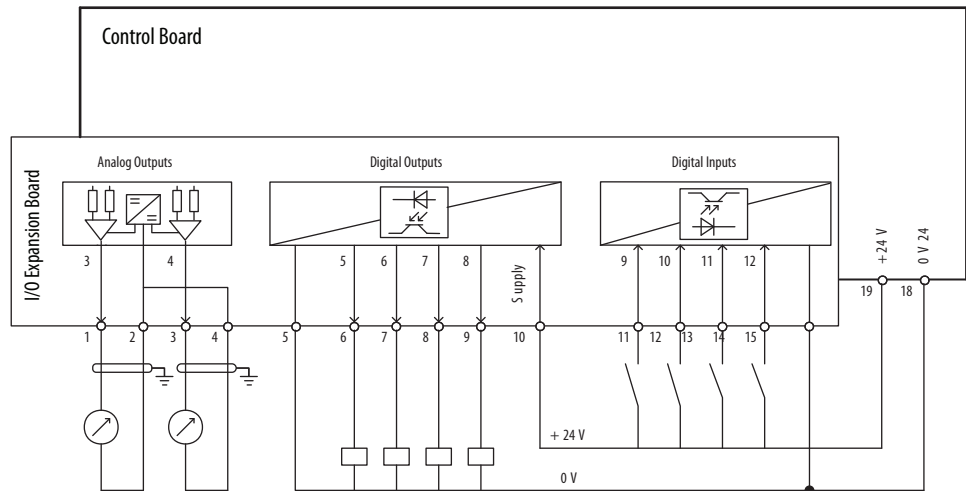


Figure 107 - I/O Expansion Board Wiring Diagram



## Optional 115V AC to 24V DC I/O Converter Circuit Board

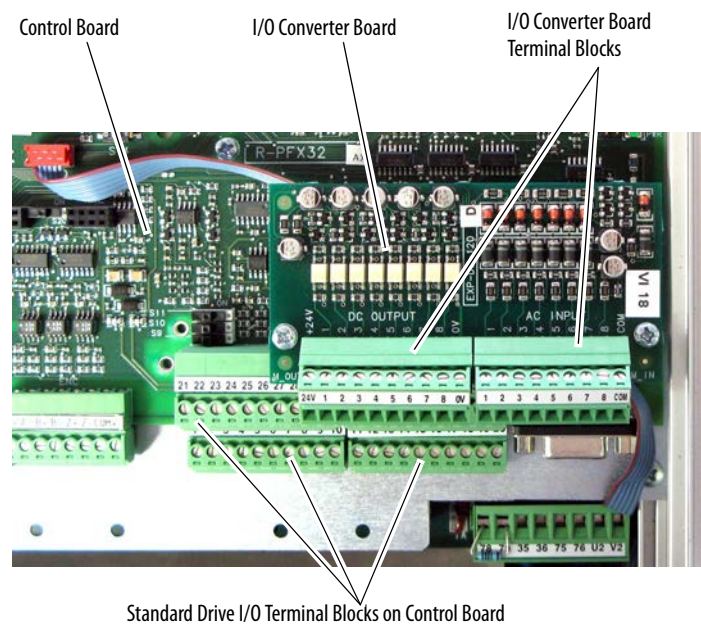
### What This Option Board Provides

The 115V AC to 24V DC I/O converter circuit board<sup>(1)</sup> allows you to convert 115V AC digital input signals to 24V DC digital input signals to provide an interface with the standard digital I/O terminal blocks on the PowerFlex® DC drive control circuit board. The circuit board contains the following I/O:

- Eight opto isolated 115V AC digital inputs
- Eight interface outputs for the digital inputs on control board of the drive<sup>(2)</sup>
- Two input terminals for the 24V DC power supply voltage

This circuit board is catalog number 20P-S520L.

**Figure 108 - 115V AC to 24V DC I/O Converter Circuit Board Mounting Location**



- (1) The 115V AC to 24V DC I/O Converter circuit board is not factory installed.
- (2) If more than eight 115V AC digital input signals require conversion to 24V DC (i.e., the optional PowerFlex DC drive I/O Expansion circuit board is used - see [Appendix F](#)), a second Converter board is required and must be sourced and wired independently from the 115V AC to 24V DC I/O Converter board mounted on the control board and be mounted in an appropriate enclosure external to the PowerFlex DC drive enclosure.

## I/O Converter Board Wiring

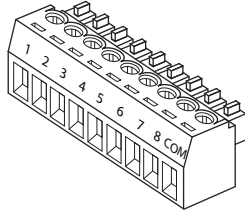
**Table 97 - Recommended Signal Wire Size**

Wire Type and Size			Tightening Torque N•m (lb•in)
Flexible (mm <sup>2</sup> )	multi-core (mm <sup>2</sup> )	AWG	
0.14...1.5	0.14...1.5	28...16	0.4 (3.5)

A 75 x 2.5 x 0.4 mm (3.0 x 0.1 x 0.02 in.) flathead screwdriver is recommended for connecting wire to the terminal block inputs. Strip the ends of the cables to a length of 6.5 mm (0.26 in.).

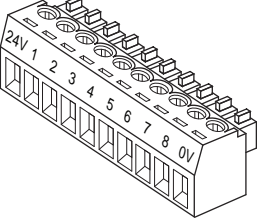
**Table 98 - I/O Converter Board M\_IN Terminal Block Designations**

No.	Signal	Description
1	Digital Input 1	Rated input voltage: 115V AC ±10% 50...60Hz. ON input voltage: 115V AC ±10% OFF input voltage: 0 - 70V AC ON input current: 4...5.5 mA
2	Digital Input 2	
3	Digital Input 3	
4	Digital Input 4	
5	Digital Input 5	
6	Digital Input 6	
7	Digital Input 7	
8	Digital Input 8	
Com	Digital Input Common	

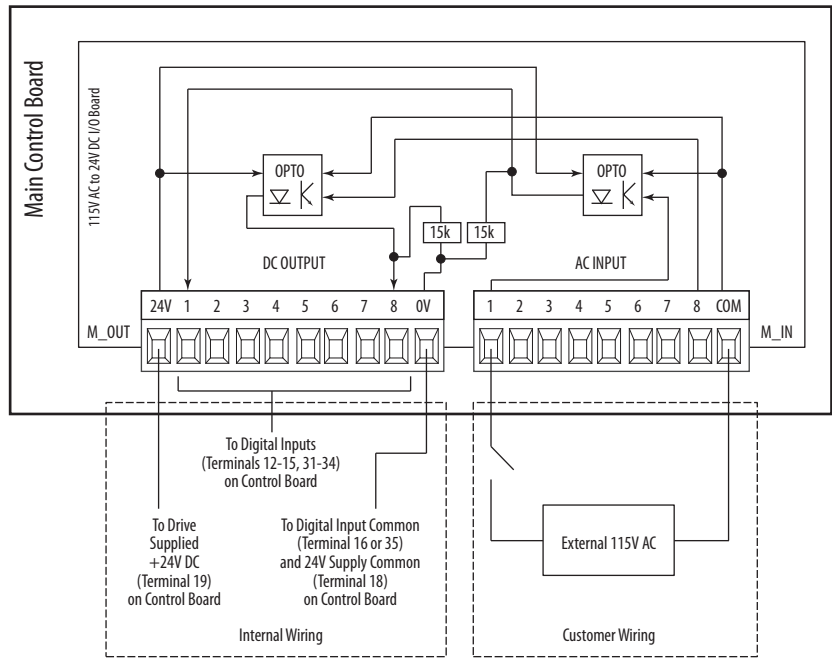


**Table 99 - I/O Converter Board M\_OUT Terminal Block Designations**

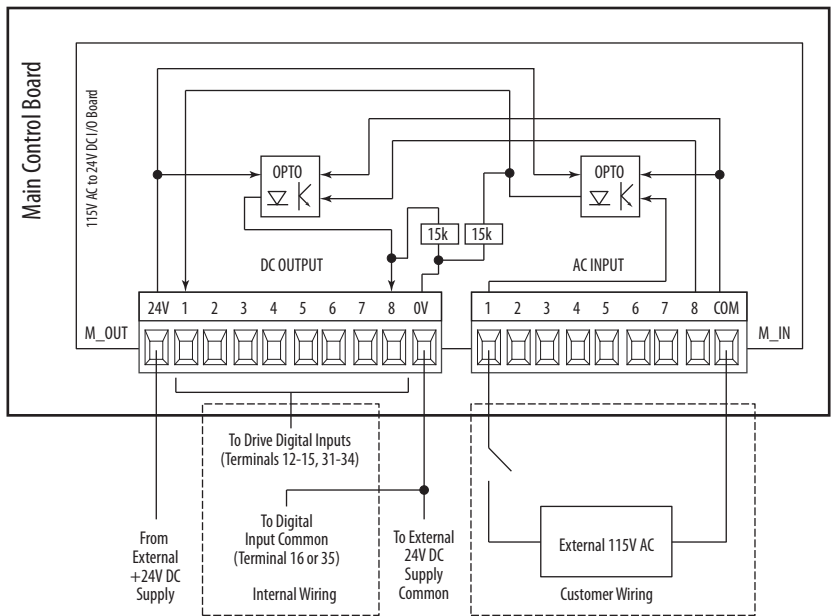
No.	Signal	Description
24V	+24V DC Supply	24V DC ±10%, 40 mA power supply. Max. load 120 mA. Supply power can be provided by the +24V DC supply on the control board I/O (terminal 19 - see <a href="#">Figure 109</a> on page 395) or an external source (see <a href="#">Figure 110</a> on page 395).
1	Digital Output 1	Output type: Open collector, PNP type with 15 kΩ pull-down Output current: 10 mA max. Delay time hw OFF to ON: 5 ms (typ.) Delay time hw ON to OFF: 50 ms (typ.)
2	Digital Output 2	
3	Digital Output 3	
4	Digital Output 4	
5	Digital Output 5	
6	Digital Output 6	
7	Digital Output 7	
8	Digital Output 8	
0V	24V Common	Common for the power supply. <ul style="list-style-type: none"> <li>If an internal supply is used, this terminal must be wired to the digital input common (terminal 16 or 35) on the control board I/O. See <a href="#">Figure 109</a> on page 395.</li> <li>If an external supply is used, this terminal must be wired to the external 24V DC supply common and the digital input common (terminal 16 or 35) on the control board I/O. See <a href="#">Figure 110</a> on page 395.</li> </ul>



**Figure 109 - I/O Converter Board with Internal Supply Wiring Diagram**



**Figure 110 - I/O Converter Board with External Supply Wiring Diagram**



**Notes:**



## PowerFlex DC Standalone Regulator Installation

This appendix contains installation information specific to the PowerFlex® DC Standalone Regulator (SAR). The PowerFlex DC SAR and Gate Amplifier are currently sold through Rockwell Automation Drive Systems only. Consult the factory for availability.

### Installation and Wiring Instructions

Complete the following for SAR installation and configuration:

1. Read and complete all installation and configuration instructions for the SAR and Gate Amplifier contained in the PowerFlex DC Standalone Regulator and Gate Amplifier User Manual, publication number 23P-UM001.
2. Read and complete all additional power, control and I/O wiring, grounding, and configuration instructions in Chapter 1 Installation and Wiring of this manual pertaining to the frame A PowerFlex DC drive.

---

**IMPORTANT** Do not change (undo) any of the installation or configuration settings made to the SAR (as instructed in the PowerFlex DC Standalone Regulator and Gate Amplifier User Manual) when completing the instructions from Chapter 1 of this manual.

---

3. Continue with the instructions in Chapter 2 Drive Start Up of this manual.

## Notes:

## Numerics

### 115V AC to 24V DC I/O converter board

catalog number 393

### 2-wire control

non-reversing 86

reversing 86

### 3-wire control 86, 87

## A

### AC input contactor

configure 31

recommended 264

### AC input line reactor

recommended 264

### AC input voltage 45

### AC Line Freq (Par. No. 588) 130

### AC Line Voltage (Par. No. 466) 130

### AC Undervoltage fault 222

### Acc Dec Filter (Par. No. 1212) 171

### Accel Mask (Par. No. 596) 192

### Accel Owner (Par. No. 605) 192

### Accel Status (Par. No. 1188) 169

### Accel Time 1 (Par. No. 660) 157

### Accel Time 2 (Par. No. 24) 156

### access

S.M.A.R.T. screen 282

### Act Spd Filter (Par. No. 923) 143

### Act Spd Reg BW (Par. No. 435) 153

### Act Ten Ref Pct (Par. No. 1194) 170

### Actual Comp (Par. No. 1213) 171

### Actual Speed (Par. No. 924) 127

### Actuator Delay (Par. No. 1266) 158

### Adaptive I Gain1 (Par. No. 189) 160

### Adaptive I Gain2 (Par. No. 191) 160

### Adaptive I Gain3 (Par. No. 193) 160

### Adaptive Joint 1 (Par. No. 186) 159

### Adaptive Joint 2 (Par. No. 187) 160

### Adaptive P Gain1 (Par. No. 188) 160

### Adaptive P Gain2 (Par. No. 190) 160

### Adaptive P Gain3 (Par. No. 192) 160

### Adaptive Ref (Par. No. 183) 159

### Adaptive Reg Typ (Par. No. 182) 159

### Adaptive Spd 1 (Par. No. 184) 159

### Adaptive Spd 2 (Par. No. 185) 159

### Adaptive Spd En (Par. No. 181) 159

### adaptive speed regulator

function 335

### Adaptv Regulator group 159 ... 160

### adjust

current regulator 350

### advanced parameter view 121

## alarm

Arm Voltage 228

Auxiliary Input 228

BipolarCfct 228

BrakeSlipped 228

CntactrCfct 228

DigInCfctA 228

DigInCfctB 229

DigInCfctC 229

FB Cfg Cfct 229

Fld Current Loss 229

FldCfg Cfct 229

Motor Over Temp 229

Motor Overload 229

Open SCR 229

Ref Cfct 229

Spd Fdbk Err 230

Spd Fdbk Loss 230

Start At PowerUp 230

Torq Prov Cfct 230

visual notification 221

### alarm type

non-configurable 219

user configurable 219

### Alarms group 185 ... 188

### Alpha Test (Par. No. 166) 146

### ALT key

functions 282

### analog and digital I/O expansion board

catalog number 391

### Analog In1 Value (Par. No. 1404) 197

### Analog In2 Value (Par. No. 1405) 197

### Analog In3 Value (Par. No. 1406) 197

### analog input

configure 292

wiring 85

### analog inputs

signal comparison 293

wiring 85

### Analog Inputs group 195 ... 197

### analog output

wiring 85

### Analog Outputs group 197 ... 198

### analog tachometer

DIP switch 79

ground 34

terminal block 90

### Anlg In1 Cmp (Par. No. 1042) 196

### Anlg In1 Cmp Dly (Par. No. 1044) 196

### Anlg In1 Cmp Eq (Par. No. 1045) 197

### Anlg In1 Cmp Err (Par. No. 1043) 196

### Anlg In1 Config (Par. No. 71) 195

### Anlg In1 Filter (Par. No. 792) 196

### Anlg In1 Offset (Par. No. 74) 196

### Anlg In1 Scale (Par. No. 72) 195

### Anlg In1 Sel (Par. No. 70) 195

### Anlg In1 Target (Par. No. 295) 196

### Anlg In1 Tune (Par. No. 259) 196

### Anlg In2 Config (Par. No. 76) 195

**Anlg In2 Filter (Par. No. 801)** 196  
**Anlg In2 Offset (Par. No. 79)** 196  
**Anlg In2 Scale (Par. No. 77)** 195  
**Anlg In2 Sel (Par. No. 75)** 195  
**Anlg In2 Target (Par. No. 296)** 196  
**Anlg In2 Tune (Par. No. 260)** 196  
**Anlg In3 Config (Par. No. 81)** 195  
**Anlg In3 Filter (Par. No. 802)** 196  
**Anlg In3 Offset (Par. No. 84)** 196  
**Anlg In3 Scale (Par. No. 82)** 195  
**Anlg In3 Sel (Par. No. 80)** 195  
**Anlg In3 Target (Par. No. 297)** 196  
**Anlg In3 Tune (Par. No. 261)** 196  
**Anlg Out1 Scale (Par. No. 62)** 197  
**Anlg Out1 Sel (Par. No. 66)** 198  
**Anlg Out2 Scale (Par. No. 63)** 197  
**Anlg Out2 Sel (Par. No. 67)** 198  
**Anlg Out3 Scale (Par. No. 64)** 197  
**Anlg Out3 Sel (Par. No. 68)** 198  
**Anlg Out4 Scale (Par. No. 65)** 197  
**Anlg Out4 Sel (Par. No. 69)** 198  
**Anlg Tach Gain (Par. No. 562)** 142  
**Anlg1 Tune Scale (Par. No. 73)** 195  
**Anlg2 Tune Scale (Par. No. 78)** 195  
**Anlg3 Tune Scale (Par. No. 83)** 195  
**Applications file** 161 . . . 176  
**Arm Current (Par. No. 200)** 128  
**Arm Current Pct (Par. No. 199)** 128  
**Arm Inductance (Par. No. 454)** 143  
**Arm Resistance (Par. No. 453)** 143  
**Arm Test Angle (Par. No. 167)** 146  
**Arm Volt Ki (Par. No. 494)** 134  
**Arm Volt Ki Base (Par. No. 496)** 135  
**Arm Volt Kp (Par. No. 493)** 134  
**Arm Volt Kp Base (Par. No. 495)** 135  
**Armature Overvoltage fault** 222  
**armature terminals**  
     wire size 51  
**Armature Voltage alarm** 228  
**armature voltage feedback**  
     terminal block, frame A 55  
     terminal block, frame B 55  
     terminal block, frame C 56  
     terminal block, frame D 56  
     terminals 54  
     wire size 54  
**At Speed (Par. No. 394)** 180  
**At Speed Delay (Par. No. 105)** 150  
**At Speed Error (Par. No. 104)** 150  
**At Zero Speed (Par. No. 395)** 180  
**auto speed sources** 325  
**Auto/Manual examples** 326  
**Autotune Cur Lim (Par. No. 1048)** 145  
**Autotune group** 143 . . . 145  
**Aux Inp Flt Cfg (Par. No. 354)** 185  
**Auxiliary Input alarm** 228

**Auxiliary Input fault** 222

## B

**Base Omega (Par. No. 1163)** 167  
**basic parameter view** 119  
**Bipolar Conflict alarm** 228  
**bipolar input**  
     warning 82  
**bipolar signal**  
     analog output 85  
**bipolar speed reference**  
     analog input 85  
**block diagrams** 361  
**brake resistor** 269  
**Brake Test Torq (Par. No. 1114)** 175  
**BrakeSlipped alarm** 228  
**Brk Alarm Travel (Par. No. 1109)** 174  
**Brk Release Time (Par. No. 1107)** 174  
**Brk Set Time (Par. No. 1108)** 174  
**Brk Slip Count (Par. No. 1110)** 174

## C

**cable**  
     recommendations 44  
     spacing 44  
     spacing example 44  
     spacing notes 45  
**can't start drive** 231  
**catalog number**  
     115V AC to 24V DC I/O converter board 393  
     analog and digital I/O expansion board 391  
     Standalone Regulator 14  
     standard drive 13  
**CE Compliance**  
     General Considerations 40  
**CE Conformity** 40  
**change**  
     speed source 326  
**changed parameters**  
     view 285  
**circuit breaker**  
     control circuit 43  
**clear**  
     faults 221  
**Clear Fault Que (Par. No. 263)** 184  
**Close Loop Comp (Par. No. 1208)** 170  
**Closed Loop En (Par. No. 1214)** 171  
**Closing Speed (Par. No. 1262)** 158  
**Comm Control group** 191  
**common mode interference** 82  
**communication**  
     logic command word 241  
     logic status word 242  
     programmable controller 240  
**communication adapter**  
     install 385  
     kits 385

**Communications file** 191 . . . 194

**compare**

analog input signals 293

**compensation**

droop 302

**configure**

AC input contactor 31  
 analog input 292  
 DC output contactor 31  
 dynamic brake resistor 31  
 feedback signal 323  
 Klixon 64  
 line speed signal 321  
 minimum firing angle 320  
 programmable controller 240  
 PTC 64  
 start at powerup 348  
 tension set point signal 324  
 thermal switch 64  
 thermistor 64

**Connected Components Workbench** 95

**Connected Components Workbench software** 115

**Constant J Comp (Par. No. 1172)** 168

**contactor**

AC input 264  
 configure 31

**Contactor Conflict alarm** 228

**ContactorControl (Par. No. 1391)** 202

**contactors**

DC output 269

**control block diagrams** 361

**control circuit**

input power 67

**Control Config group** 155

**Copycat** 285

**corrective actions**

for drive problems 231

**cross reference**

parameter name 207  
 parameter number 213

**Cur Lim Neg Out (Par. No. 11)** 128

**Cur Lim Pos Out (Par. No. 10)** 128

**current configuration**

field 61

**Current Lim Neg (Par. No. 9)** 136

**Current Lim Pos (Par. No. 8)** 136

**Current Limit (Par. No. 7)** 136

**Current Meters group** 128 . . . 129

**Current Rate Lim (Par. No. 12)** 136

**Current Reg In (Par. No. 41)** 128

**current regulator**

adjust 350  
 tune settings 350

**current/speed curve**

function 294

**CurrLimit Active (Par. No. 349)** 178

**CurrReg Autotune (Par. No. 452)** 143

## D

**Dancer Constant (Par. No. 798)** 166  
**data**

save 285

**Data In A1 (Par. No. 610)** 193

**Data In A2 (Par. No. 611)** 193

**Data In B1 (Par. No. 612)** 193

**Data In B2 (Par. No. 613)** 193

**Data In C1 (Par. No. 614)** 193

**Data In C2 (Par. No. 615)** 193

**Data In D1 (Par. No. 616)** 193

**Data In D2 (Par. No. 617)** 193

**Data In SelData (Par. No. 1320)** 193

**Data In Val Sel (Par. No. 1319)** 193

**data nameplate** 12

**Data Out A1 (Par. No. 618)** 193

**Data Out A2 (Par. No. 619)** 193

**Data Out B1 (Par. No. 621)** 193

**Data Out B2 (Par. No. 621)** 193

**Data Out C1 (Par. No. 622)** 193

**Data Out C2 (Par. No. 623)** 193

**Data Out D1 (Par. No. 624)** 193

**Data Out D2 (Par. No. 625)** 193

**DataLinks group** 193

**DC contactor crimp lugs**

kits 271

**DC output contactor** 269

configure 31

recommended 269

**DC output voltage** 46

**Decel Mask (Par. No. 631)** 193

**Decel Owner (Par. No. 609)** 192

**Decel Status (Par. No. 1189)** 169

**Decel Time 1 (Par. No. 662)** 157

**Decel Time 2 (Par. No. 32)** 156

**defaults**

reset 285

**definitions**

digital input option selections 200  
 digital output option selections 204  
 relay output option selections 204

**diagnostic data**

viewing 284

**Diagnostics group** 178 . . . 184

**diagrams**

control block 361  
 power wiring 46

**Diam Calc Dis (Par. No. 1161)** 166

**Diam Inc Dec En (Par. No. 1205)** 168

**Diam Init Filter (Par. No. 1206)** 168

**Diam Preset 0 (Par. No. 1164)** 167

**Diam Preset 1 (Par. No. 1165)** 167

**Diam Preset 2 (Par. No. 1166)** 167

**Diam Preset 3 (Par. No. 1167)** 167

**Diam Preset Sel (Par. No. 1168)** 167

**Diam Stdy Delay (Par. No. 1207)** 168

**Diam Threshold (Par. No. 1158)** 166

- Diameter Calc (Par. No. 794)** 165
- Diameter Calc group** 166 . . . 168
- Diameter Calc St (Par. No. 800)** 166
- Diameter Filter (Par. No. 1162)** 167
- Diameter Reached (Par. No. 1159)** 166
- Diameter Reset (Par. No. 1157)** 166
- Dig In Status (Par. No. 564)** 202
- Dig In Term 1 (Par. No. 565)** 202
- Dig In Term 10 (Par. No. 574)** 202
- Dig In Term 11 (Par. No. 575)** 202
- Dig In Term 12 (Par. No. 576)** 202
- Dig In Term 2 (Par. No. 566)** 202
- Dig In Term 3 (Par. No. 567)** 202
- Dig In Term 4 (Par. No. 568)** 202
- Dig In Term 5 (Par. No. 569)** 202
- Dig In Term 6 (Par. No. 570)** 202
- Dig In Term 7 (Par. No. 571)** 202
- Dig In Term 8 (Par. No. 572)** 202
- Dig In Term 9 (Par. No. 573)** 202
- Dig Out Status (Par. No. 581)** 205
- Digital In1 Sel (Par. No. 133)** 199
- Digital In10 Sel (Par. No. 142)** 199
- Digital In11 Sel (Par. No. 143)** 199
- Digital In12 Sel (Par. No. 144)** 199
- Digital In2 Sel (Par. No. 134)** 199
- Digital In3 Sel (Par. No. 135)** 199
- Digital In4 Sel (Par. No. 136)** 199
- Digital In5 Sel (Par. No. 137)** 199
- Digital In6 Sel (Par. No. 138)** 199
- Digital In7 Sel (Par. No. 139)** 199
- Digital In8 Sel (Par. No. 140)** 199
- Digital In9 Sel (Par. No. 141)** 199
- Digital Input Conflict A alarm** 228
- Digital Input Conflict B alarm** 229
- Digital Input Conflict C alarm** 229
- Digital Inputs group** 199 . . . 202
- Digital Out1 Sel (Par. No. 145)** 203
- Digital Out2 Sel (Par. No. 146)** 203
- Digital Out3 Sel (Par. No. 147)** 203
- Digital Out4 Sel (Par. No. 148)** 203
- Digital Out5 Sel (Par. No. 149)** 203
- Digital Out6 Sel (Par. No. 150)** 203
- Digital Out7 Sel (Par. No. 151)** 203
- Digital Out8 Sel (Par. No. 152)** 203
- digital outputs**
  - option definitions 204
- Digital Outputs group** 203 . . . 206
- dimensions**
  - frame A 20
  - frame B 21
  - frame C 22
  - frame D 23, 24
- DIP switch**
  - S0 77, 78
  - S1 77, 78
  - S10 77, 78
  - S11 77, 78
  - S12 77, 78
  - S14 61, 77, 78
  - S15 77, 78, 79
  - S18 77, 78
  - S2 77, 78
  - S20 77, 78
  - S21 77, 78
  - S3 77, 78
  - S4 77, 78, 79
  - S9 77, 78
- Direction Mask (Par. No. 594)** 192
- Direction Mode (Par. No. 1322)** 177
- Direction Owner (Par. No. 603)** 192
- Discrete Speeds group** 148 . . . 149
- DncrPosSpd (Par. No. 795)** 165
- DPI Baud Rate (Par. No. 589)** 191
- DPI Fdbk Select (Par. No. 1321)** 191
- DPI Inputs group** 206
  - DPI P1 Select (Par. No. 1323)** 206
  - DPI P2 Select (Par. No. 1324)** 206
  - DPI P3 Select (Par. No. 1325)** 206
  - DPI P4 Select (Par. No. 1326)** 206
  - DPI P5 Select (Par. No. 1327)** 206
- DPI Port Sel (Par. No. 590)** 191
- DPI Port Value (Par. No. 1343)** 191
- drive**
  - clearance 19
  - data nameplate 12
  - enclosure 19
  - firmware version 12
  - frame size 12
  - mount 19
  - mounting 19, 20
  - power wiring 45
  - problems 231
  - series number 12
  - start-up 93
  - status 220
  - storage 11
  - temperature 19
  - weights 20
- Drive Alarm 1 (Par. No. 1380)** 187
- Drive Alarm 2 (Par. No. 1394)** 188
- Drive Checksum (Par. No. 332)** 130
- Drive Data group** 129 . . . 130
- Drive Logic Rslt (Par. No. 1328)** 182
- Drive Memory group** 177
- Drive Overload fault** 222
- drive problems**
  - drive starts, motor does not turn 232
  - drive will not start 231
  - motor does not reach commanded speed 232
  - motor reaches maximum speed immediately 233
  - motor turning wrong direction 232

**Drive Size (Par. No. 465)** 130  
**drive starts, motor does not turn** 232  
**Drive Status 1 (Par. No. 381)** 179  
**Drive Status 2 (Par. No. 382)** 180  
**Drive Type (Par. No. 300)** 129  
**Drive Type Sel (Par. No. 201)** 131  
**drive will not start** 231  
**DriveTools SP** 95  
**DriveTools SP software** 115  
**droop compensation** 302  
**Droop Filter (Par. No. 697)** 157  
**Droop Limit (Par. No. 700)** 158  
**Droop Out (Par. No. 1006)** 127  
**Droop Out Pct (Par. No. 1007)** 127  
**Droop Percent (Par. No. 696)** 157  
**Drv Fld Brdg Cur (Par. No. 374)** 132  
**Dsp Error fault** 222  
**dynamic brake resistor**  
     configure 31  
     recommended 269  
     using 32  
**Dynamic Control file** 155 . . . 160  
**Dynamic Friction (Par. No. 1175)** 168

## E

**edit**  
     parameters 286  
**EEPROM Error fault** 222  
**Elapsed Lifetime (Par. No. 235)** 129  
**electrostatic discharge**  
     precaution 18  
**EMC Directive**  
     Installation Requirements 41  
**EMC Filters**  
     Alternates 273  
     Alternates, EPCOS 278  
     Alternates, Rasmi 273  
     Alternates, Schaffner 275  
**EN 61800-3**  
     Installation Requirements 41  
**Enable Droop (Par. No. 699)** 158  
**enable input**  
     wiring 86  
**Enable PD (Par. No. 770)** 163  
**Enable PI (Par. No. 769)** 161  
**Enable PI PD (Par. No. 1258)** 165  
**enclosure**  
     rating 19  
**encoder**  
     ground 34  
     terminal block 88  
     wiring 89  
**Encoder Config (Par. No. 170)** 138  
**Encoder Counts (Par. No. 1022)** 143  
**Encoder Err Chk (Par. No. 652)** 142  
**Encoder Error fault** 222  
**Encoder Out Sel (Par. No. 1021)** 143

**Encoder PPR (Par. No. 169)** 138  
**Encoder Speed (Par. No. 420)** 127  
**Ext FC Curr Hyst (Par. No. 410)** 133

## F

**factory defaults**  
     reset 285  
**Fast Stop Status (Par. No. 1190)** 169  
**Fast Stop Time (Par. No. 38)** 158  
**Fault 1 Code (Par. No. 1351)** 184  
**Fault 1 Time (Par. No. 1361)** 185  
**Fault 10 Code (Par. No. 1360)** 184  
**Fault 10 Time (Par. No. 1370)** 185  
**Fault 2 Code (Par. No. 1352)** 184  
**Fault 2 Time (Par. No. 1362)** 185  
**Fault 3 Code (Par. No. 1353)** 184  
**Fault 3 Time (Par. No. 1363)** 185  
**Fault 4 Code (Par. No. 1354)** 184  
**Fault 4 Time (Par. No. 1364)** 185  
**Fault 5 Code (Par. No. 1355)** 184  
**Fault 5 Time (Par. No. 1365)** 185  
**Fault 6 Code (Par. No. 1356)** 184  
**Fault 6 Time (Par. No. 1366)** 185  
**Fault 7 Code (Par. No. 1357)** 184  
**Fault 7 Time (Par. No. 1367)** 185  
**Fault 8 Code (Par. No. 1358)** 184  
**Fault 8 Time (Par. No. 1368)** 185  
**Fault 9 Code (Par. No. 1359)** 184  
**Fault 9 Time (Par. No. 1369)** 185  
**Fault Arm Amps (Par. No. 1371)** 185  
**Fault Clear (Par. No. 1347)** 184  
**Fault Clr Mask (Par. No. 597)** 192  
**Fault Clr Mode (Par. No. 1348)** 184  
**Fault Clr Owner (Par. No. 606)** 192  
**Fault Field Amps (Par. No. 1373)** 185  
**fault queue** 284  
**Fault Speed (Par. No. 1372)** 185  
**fault type**  
     non-configurable 219  
     user configurable 219  
**Fault Voltage (Par. No. 1374)** 185  
**FaultCode (Par. No. 57)** 129

**faults**

- AC Undervoltage 222
- Arm Overvoltage 222
- Auxiliary Input 222
- clear 221
- Drive Overload 222
- Dsp Error 222
- EEPROM Error 222
- Encoder Error 222
- Fld Current Loss 222
- Fwd End Limit 222
- Fwd Over Travel 222
- Hardware Fault 222
- Heatsink OvrTemp 223
- Interrupt Error 223
- Inverting Fault 223
- Main Contactor 223
- Motor Over Temp 223
- Motor Overload 223
- No Fault 223
- Open SCR 223
- Overcurrent 224
- Overspeed 224
- Params Defaulted 224
- Port 1 Adapter 224
- Port 1 DPI Loss 224
- Port 2 Adapter 224
- Port 2 DPI Loss 224
- Port 3 Adapter 224
- Port 3 DPI Loss 224
- Port 4 Adapter 224
- Port 4 DPI Loss 224
- Port 5 Adapter 224
- Port 5 DPI Loss 224
- Power Failure 224
- Resolver Error 224
- Rev End Limit 224
- Rev Over Travel 224
- Shorted SCR 224
- Spd Fdbk Loss 225
- SSC Error 225
- STune Aborted 225
- STune CurLimit 225
- STune FrictionLo 225
- STune LoadHi 225
- STune Overspeed 225
- STune Stalled 225
- STune Timeout 225
- Sustained Curr 225
- visual notification 221
- Faults group** 184 . . . 185
- Fdbk Device Type (Par. No. 414)** 138
- Fdbk Option ID (Par. No. 422)** 138
- Feed Fwd PID (Par. No. 758)** 163
- Feedback Configuration Conflict alarm** 229
- Feedback Offset (Par. No. 563)** 142
- feedback signal**
  - configure 323

**field**

- current configuration 61
- DC output voltage 46
- input terminals 57
- output terminals 57
- terminal block, frame A 58
- terminal block, frame B 59
- terminal block, frame C 59, 60
- terminal block, frame D 60
- wire size 57
- Field Config group** 133 . . . 136
- Field Configuration Conflict alarm** 229
- field converter**
  - tune voltage regulator 356
- Field Current (Par. No. 351)** 129
- field current curve**
  - tune 358
- Field Current Loss alarm** 229
- Field Current Loss fault** 222
- field current regulator**
  - tune 352
- Field Curve Out (Par. No. 476)** 129
- Field Econ Delay (Par. No. 1407)** 136
- Field Economy En (Par. No. 499)** 135
- Field Mode Sel (Par. No. 469)** 134
- Field Reg Enable (Par. No. 497)** 135
- File-Group-Parameter list** 285
- Filt TorqCur Pct (Par. No. 928)** 129
- Final Diameter (Par. No. 1178)** 169
- fine tune**
  - regulators 349
- Firing Angle (Par. No. 165)** 129
- firmware version** 12
- Fld Const 40 Pct (Par. No. 916)** 135
- Fld Const 70 Pct (Par. No. 917)** 135
- Fld Const 90 Pct (Par. No. 918)** 135
- Fld Current Pct (Par. No. 234)** 129
- Fld Reg Ki (Par. No. 92)** 133
- Fld Reg Ki Base (Par. No. 98)** 133
- Fld Reg Kp (Par. No. 91)** 133
- Fld Reg Kp Base (Par. No. 97)** 133
- Fld Test Angle (Par. No. 168)** 146
- Fld Weaken Ratio (Par. No. 456)** 133
- FldLoss Flt Cfg (Par. No. 473)** 186
- FldLoss Flt Dly (Par. No. 475)** 186
- Float Tolerance (Par. No. 1111)** 174
- Flux Divide (Par. No. 462)** 133
- Flux Filter BW (Par. No. 463)** 133
- Flux Ref Pct (Par. No. 500)** 129
- Flying Start En (Par. No. 388)** 152
- Force Min Field (Par. No. 498)** 135
- frame A**
  - armature converter terminals 51
  - dimensions 20
  - PE ground terminal 51
  - weights 20



**frame B**

- armature converter terminals 52
- dimensions 21
- PE ground terminal 52
- weights 21

**frame C**

- armature converter terminals 52
- dimensions 22
- PE ground terminal 52
- weights 22

**frame D**

- armature converter terminals 53
- dimensions 23, 24
- PE ground terminal 53
- terminal adapter kits 279
- weights 25

**frame size 12****Freeze Ramp (Par. No. 373)** 156**Friction (Par. No. 1015)** 144**functions**

- adaptive speed regulator 335
- ALT key 282
- current/speed curve 294
- droop 302
- PID 324
- speed draw 341
- speed regulation 335
- speed threshold indicators 339
- speed up 338
- speed zero 340

**fuses**

- control power circuit 43
- frame A 243
- frame B 243
- frame C 251
- frame D 251
- input power circuit 43, 243
- overvoltage clipping circuit board, frame D 263
- pulse transformer circuit board, frame B 261
- switching power supply circuit board 259
- transient noise filter circuit board, frame C 262

**Fwd End Limit fault** 222**Fwd Over Travel fault** 222**G****Gear Box Ratio (Par. No. 797)** 165**ground**

- encoder 34
- PE 34
- power feeder 34
- requirements 33
- safety 34
- tachometer 34
- typical scheme 33

**H****Hardware Fault** 222**Heatsink Over Temperature fault** 223**HIM**

- ALT key 282
- connection 281
- display 282
- DPI Port 1 281
- DPI Port 2 281
- DPI Port 3 281
- DPI Port 5 281
- edit parameters 286
- indicators 221
- install 287
- menu structure 284
- menus 284
- remove 287
- status indicator 220
- view parameters 286

**HIM menus**

- Device Select 285
- Diagnostics 284
- Memory Storage 285
- Parameter 285
- Preferences 285

**I****I Reg Error (Par. No. 587)** 143**I/O converter circuit board**

- catalog number 393
- install 393
- terminal block 394
- wire size 394
- wiring diagrams 395

**I/O expansion circuit board**

- catalog number 391
- install 391
- terminal block 392
- wire 391
- wire size 391
- wiring diagram 392

**Inertia (Par. No. 1014)** 144**Inertia C Filter (Par. No. 1012)** 143**Inertia Comp Out (Par. No. 232)** 129**InertiaCompCnst (Par. No. 1191)** 170**InertiaCompVar (Par. No. 1192)** 170**Init Diam Calc group** 165 ... 166**Initial Diameter (Par. No. 1177)** 169**input**

- contactor 264
- line reactor 264
- potentiometer 85
- voltage 45

**input current**

- control circuit 43

**input power**

- circuit protection 243
- control circuit 67
- fuses 251

**input voltage**

- AC 45

**Input/Output file** 195 ... 206

**install**

- communication adapter 385
- HIM 287
- I/O converter circuit board 393
- I/O expansion circuit board 391

**Int Acc Calc En (Par. No. 1183)** 169**interference**

- common mode 82

**Interrupt Error fault** 223**Inversion In 1 (Par. No. 1276)** 202**Inversion In 10 (Par. No. 1388)** 202**Inversion In 11 (Par. No. 1389)** 202**Inversion In 12 (Par. No. 1390)** 202**Inversion In 2 (Par. No. 1277)** 202**Inversion In 3 (Par. No. 1278)** 202**Inversion In 4 (Par. No. 1279)** 202**Inversion In 5 (Par. No. 1280)** 202**Inversion In 6 (Par. No. 1281)** 202**Inversion In 7 (Par. No. 1282)** 202**Inversion In 8 (Par. No. 1283)** 202**Inversion In 9 (Par. No. 1387)** 202**Inversion Out 1 (Par. No. 1267)** 205**Inversion Out 2 (Par. No. 1268)** 205**Inversion Out 3 (Par. No. 1269)** 205**Inversion Out 4 (Par. No. 1270)** 205**Inversion Out 5 (Par. No. 1271)** 205**Inversion Out 6 (Par. No. 1272)** 205**Inversion Out 7 (Par. No. 1273)** 205**Inversion Out 8 (Par. No. 1274)** 205**Inversion Relay1 (Par. No. 1393)** 206**Inversion Relay2 (Par. No. 1275)** 205**Inverting Fault** 223**isolation transformer**

- configuration 30
- recommended 267
- using 30

**J****Jog Mask (Par. No. 593)** 192**Jog Off Delay (Par. No. 1409)** 149**Jog Owner (Par. No. 602)** 192**Jog Ramp Time (Par. No. 1410)** 157**Jog Speed (Par. No. 266)** 148**Jog TW Enable (Par. No. 1256)** 171**Jog TW Speed (Par. No. 1255)** 171**joystick**

- wiring 85

**jumper**

- SA-SB 67

**K****kits**

- communication adapter 385

**Klixon**

- configure 64

**L****Language (Par. No. 302)** 177**Last Stop Source (Par. No. 1402)** 183**LED status**

- green, flashing 220
- green, steady 220
- red, flashing 220
- red, steady 220
- yellow, flashing 220
- yellow, steady 220

**LEDs** 220

- MOD 220
- NET A 220
- NET B 220
- PORT 220
- STS 220

**lift**

- drives 26

**Limits group** 148**Line Accel Pct (Par. No. 1184)** 169**Line Decel Pct (Par. No. 1185)** 169**Line FastStp Pct (Par. No. 1186)** 169**line reactor**

- configuration 30
- recommended 264
- using 30

**Line Spd Gain (Par. No. 1156)** 166**Line Spd Source (Par. No. 1204)** 168**Line Spd Thresh (Par. No. 1155)** 166**Line Speed Pct (Par. No. 1160)** 166**line speed signal**

- PID 321

**link**

- parameters 331

**Load Comp (Par. No. 698)** 157**Load Limits group** 157 . . . 158**Local Mask (Par. No. 599)** 192**Local Owner (Par. No. 608)** 192**Lock Speed Integ (Par. No. 348)** 152**logic command word** 241**Logic Mask (Par. No. 591)** 191, 193**Logic Mask Act (Par. No. 1376)** 193**logic status word** 242**Low Voltage Directive**

- Installation Requirements 41

**Low Voltage Directive and Electromagnetic  
Compatibility Directive** 40**M****Main Contactor fault** 223**Man Ref Preload (Par. No. 210)** 177**manual speed sources** 325**Masks & Owners group** 191 . . . 193**Materl Width Pct (Par. No. 1173)** 168**Max Deviation (Par. No. 796)** 165**Max Diameter (Par. No. 1153)** 166**Max Feedback Spd (Par. No. 162)** 131

**Max Fld Curr Pct (Par. No. 467)** 134  
**Max Ref Speed (Par. No. 45)** 131  
**Max Speed Fwd (Par. No. 3)** 148  
**Max Speed Rev (Par. No. 4)** 148  
**Maximum Speed (Par. No. 2)** 148  
**menu**  
     HIM 284  
**MicroPsnScalePct (Par. No. 1112)** 174  
**Min Firing Angle (Par. No. 21)** 131  
**Min Fld Curr Pct (Par. No. 468)** 134  
**Min Speed Fwd (Par. No. 5)** 148  
**Min Speed Rev (Par. No. 6)** 148  
**Minimum Diameter (Par. No. 799)** 166  
**minimum firing angle**  
     configure 320  
**Minimum Speed (Par. No. 1)** 148  
**MOD LED** 220  
**Monitor file** 126 ... 130  
**MOP Accel Time (Par. No. 22)** 156  
**MOP Dec Active (Par. No. 397)** 181  
**MOP Decel Time (Par. No. 30)** 156  
**MOP Inc Active (Par. No. 396)** 180  
**MOP Mask (Par. No. 598)** 192  
**MOP Owner (Par. No. 607)** 192  
**MOP Ref Config (Par. No. 249)** 177  
**MOP Select (Par. No. 1375)** 177  
**Motor Control file** 131 ... 147  
**Motor Data group** 131 ... 133  
**motor not reaching commanded speed** 232  
**motor not turning** 232  
**Motor Over Temperature alarm** 229  
**Motor Over Temperature fault** 223  
**Motor Overload alarm** 229  
**Motor Overload fault** 223  
**motor reaches maximum speed**  
     immediately 233  
**Motor Trq Ref (Par. No. 17)** 128  
**motor turning wrong direction** 232  
**mount**  
     drive 19  
     lift 26  
**mounting**  
     dimensions 20  
     weights 20  
**MtrOvrld Factor (Par. No. 333)** 132  
**MtrOvrld Flt Cfg (Par. No. 479)** 186  
**MtrOvrld Speed (Par. No. 334)** 132  
**MtrOvrld Status (Par. No. 1290)** 181  
**MtrOvrld Type (Par. No. 376)** 132

## N

**NET A LED** 220  
**NET B LED** 220  
**Nom Mtr Arm Amps (Par. No. 179)** 131  
**Nom Mtr Fld Amps (Par. No. 280)** 132

**numbered parameter list** 285

## O

**Offs Accel Time (Par. No. 1198)** 170  
**Open SCR alarm** 229  
**Open SCR fault** 223  
**Opening Delay (Par. No. 1263)** 158  
**OpenSCR Flt Cfg (Par. No. 216)** 147  
**OpenSCR Threshld (Par. No. 217)** 147  
**OpenSCR Trip Lvl (Par. No. 218)** 147  
**OpenSCR WarnLvl (Par. No. 215)** 147  
**Out Volt Level (Par. No. 921)** 136  
**Output Power (Par. No. 1052)** 130  
**Output Voltage (Par. No. 233)** 129  
**Overcurrent fault** 224  
**OverCurrent Thr (Par. No. 584)** 187  
**Overspeed fault** 224  
**Overspeed Val (Par. No. 585)** 187  
**OverTemp Flt Cfg (Par. No. 365)** 185  
**OverVolt Flt Cfg (Par. No. 203)** 185  
**overvoltage clipping circuit board, frame D**  
     fuses 263

## P

**Param Access Lvl (Par. No. 211)** 177  
**parameter access level**  
     change 285  
**parameter files**  
     Applications 161 ... 176  
     Communications 191 ... 194  
     Dynamic Control 155 ... 160  
     Input/Output 195 ... 206  
     Monitor 126 ... 130  
     Motor Control 131 ... 147  
     Speed Command 148 ... 154  
     Utility 177 ... 191

- parameter groups**
  - Adaptv Regulator 159 ... 160
  - Alarms 185 ... 188
  - Analog Inputs 195 ... 197
  - Analog Outputs 197 ... 198
  - Autotune 143 ... 145
  - Comm Control 191
  - Control Config 155
  - Current Meters 128 ... 129
  - DataLinks 193
  - Diagnostics 178 ... 184
  - Diameter Calc 166 ... 168
  - Digital Inputs 199 ... 202
  - Digital Outputs 203 ... 206
  - Discrete Speeds 148 ... 149
  - DPI Inputs 206
  - Drive Data 129 ... 130
  - Drive Memory 177
  - Faults 184 ... 185
  - Field Config 133 ... 136
  - Init Diam Calc 165 ... 166
  - Limits 148
  - Load Limits 157 ... 158
  - Masks & Owners 191 ... 193
  - Motor Data 131 ... 133
  - PD Control 162 ... 163
  - PI Control 161 ... 162
  - PID Control 163 ... 165
  - Ramp Rates 155 ... 157
  - Reference Config 177
  - Restart Modes 159
  - Scale Blocks 175 ... 176
  - Security 193 ... 194
  - Speed Feedback 138 ... 143
  - Speed Meters 126 ... 128
  - Speed References 149
  - Speed Regulator 149 ... 154
  - Stop Modes 158
  - Test Generator 145 ... 147
  - Torq Attributes 136 ... 138
  - Torque Prove 173 ... 175
  - User Defined 188 ... 191
  - Winder Functions 168 ... 172
- parameter views**
  - advanced 121
  - basic 119
- parameters**
  - edit 286
  - organization 118
  - view 286
- PD Control group** 162 ... 163
- PD Deriv Filter (Par. No. 767)** 162
- PD Deriv Gain 1 (Par. No. 766)** 162
- PD Deriv Gain 2 (Par. No. 789)** 163
- PD Deriv Gain 3 (Par. No. 791)** 163
- PD Output PID (Par. No. 421)** 162
- PD Prop Gain 1 (Par. No. 768)** 163
- PD Prop Gain 2 (Par. No. 788)** 163
- PD Prop Gain 3 (Par. No. 790)** 163
- PE ground**
  - wire size 51
- peripheral devices**
  - view 285
- PI Central v sel (Par. No. 779)** 162
- PI Central v1 (Par. No. 776)** 161
- PI Central v2 (Par. No. 777)** 161
- PI Central v3 (Par. No. 778)** 161
- PI Central vs0 (Par. No. 780)** 162
- PI Central vs1 (Par. No. 781)** 162
- PI Control group** 161 ... 162
- PI Init Intgl Gn (Par. No. 734)** 161
- PI Init Prop Gn (Par. No. 793)** 162
- PI integr freeze (Par. No. 783)** 162
- PI Integral Gain (Par. No. 764)** 161
- PI Lower Limit (Par. No. 785)** 162
- PI Output (Par. No. 771)** 161
- PI Prop Gain PID (Par. No. 765)** 161
- PI Steady Thrsh (Par. No. 695)** 161
- PI Upper Limit (Par. No. 784)** 162
- PID**
  - feedback signal 323
  - function 321, 323, 324
  - line speed signal 321
- PID Accel Time (Par. No. 1046)** 165
- PID Clamp (Par. No. 757)** 163
- PID Control group** 163 ... 165
- PID Decel Time (Par. No. 1047)** 165
- PID Error (Par. No. 759)** 163
- PID Error Gain (Par. No. 1254)** 165
- PID Feedback (Par. No. 763)** 164
- PID Output (Par. No. 774)** 164
- PID Output Scale (Par. No. 773)** 164
- PID Output Sign (Par. No. 772)** 164
- PID Setpoint 0 (Par. No. 760)** 163
- PID Setpoint 1 (Par. No. 761)** 163
- PID Setpoint Sel (Par. No. 762)** 163
- PID Source (Par. No. 786)** 165
- PID Source Gain (Par. No. 787)** 165
- PID Steady Delay (Par. No. 731)** 161
- PID Target (Par. No. 782)** 164
- Pollution Degree Ratings** 42
- Port 1 Adapter fault** 224
- Port 1 DPI Loss fault** 224
- Port 2 Adapter fault** 224
- Port 2 DPI Loss fault** 224
- Port 3 Adapter fault** 224
- Port 3 DPI Loss fault** 224
- Port 4 Adapter fault** 224
- Port 4 DPI Loss fault** 224
- Port 5 Adapter fault** 224
- Port 5 DPI Loss fault** 224
- PORT LED** 220
- Port Mask Act (Par. No. 1379)** 194
- potentiometer**
  - wiring 85
- power circuit**
  - fuses 43
  - protection 43
- Power Failure fault** 224

- power feeder**
    - ground 34
  - power terminals**
    - armature converter 51
  - power wiring** 45
    - AC input contactor 47
    - armature output terminals 51
    - armature voltage feedback terminals 54
    - contact terminals 64
    - DC output contactor 48
    - diagrams 46
    - dynamic brake 49
    - field input terminals 57
    - field output terminals 57
    - motor thermistor terminals 64
    - normally open contact terminals 64
    - PE (earth ground) terminal 51
  - Powerup Delay (Par. No. 1345)** 159
  - preferences**
    - HIM 285
  - Preset Speed 1 (Par. No. 154)** 148
  - Preset Speed 2 (Par. No. 155)** 148
  - Preset Speed 3 (Par. No. 156)** 148
  - Preset Speed 4 (Par. No. 157)** 148
  - Preset Speed 5 (Par. No. 158)** 148
  - Preset Speed 6 (Par. No. 159)** 148
  - Preset Speed 7 (Par. No. 160)** 148
  - programmable controller**
    - communication 240
    - configure 240
  - PTC**
    - configure 64
  - pulse transformer circuit board, frame B**
    - fuses 261
- R**
- Ramp Delay (Par. No. 20)** 156
  - Ramp In (Par. No. 110)** 126
  - Ramp In Pct (Par. No. 111)** 126
  - Ramp In Zero En (Par. No. 1265)** 158
  - Ramp Out (Par. No. 113)** 126
  - Ramp Out Pct (Par. No. 114)** 126
  - Ramp Rates group** 155 ... 157
  - Ramp Select 0 (Par. No. 403)** 181
  - Ramp Select 1 (Par. No. 404)** 181
  - Ramp Type Select (Par. No. 18)** 155
  - Rated Motor Volt (Par. No. 175)** 131
  - Real FF PID (Par. No. 418)** 163
  - Ref Line Spd (Par. No. 1286)** 172
  - Ref Spd Source (Par. No. 1284)** 172
  - Ref Speed Gain (Par. No. 1285)** 172
  - Ref Zero Level (Par. No. 106)** 150
  - Reference Config group** 177
  - Reference Conflict alarm** 229
  - Reference Mask (Par. No. 595)** 192
  - Reference Owner (Par. No. 604)** 192
  - regulators**
    - fine tune 349
  - Relay Out 1 Sel (Par. No. 1392)** 206
  - Relay Out 2 Sel (Par. No. 629)** 205
  - relay outputs**
    - option definitions 204
    - terminals 64
  - remove**
    - HIM 287
  - Reset Defaults (Par. No. 258)** 177
  - Reset Fld Curve (Par. No. 920)** 136
  - Reset to Defaults** 285
  - Reslvr Cable Bal (Par. No. 431)** 141
  - Reslvr Error Cnt (Par. No. 432)** 181
  - Reslvr Position (Par. No. 427)** 141
  - Reslvr Spd Ratio (Par. No. 424)** 139
  - Reslvr Type Sel (Par. No. 423)** 139
  - Resolver Config (Par. No. 425)** 140
  - Resolver Error fault** 224
  - Resolver Pos Sel (Par. No. 429)** 141
  - Resolver Spd Sel (Par. No. 430)** 141
  - Resolver Speed (Par. No. 428)** 127
  - Resolver Status (Par. No. 426)** 141
  - Restart Modes group** 159
  - Rev End Limit fault** 224
  - Rev Over Travel fault** 224
  - Roll Diameter (Par. No. 1154)** 166
- S**
- S Curve Accel 1 (Par. No. 665)** 157
  - S Curve Accel 2 (Par. No. 667)** 157
  - S Curve Decel 1 (Par. No. 666)** 157
  - S Curve Decel 2 (Par. No. 668)** 157
  - S Curve Time (Par. No. 19)** 155
  - S.M.A.R.T. list screen**
    - access 282
    - use 283
  - safety**
    - ground 34
  - SAR Volts Scale (Par. No. 464)** 133
  - SA-SB jumper** 67
  - save**
    - data 285
  - Save HIM Ref (Par. No. 209)** 177
  - scale blocks**
    - link parameters 331
  - Scale Blocks group** 175 ... 176
  - Scale1 Div (Par. No. 487)** 175
  - Scale1 In Abs (Par. No. 492)** 176
  - Scale1 In Max (Par. No. 488)** 175
  - Scale1 In Min (Par. No. 489)** 175
  - Scale1 In Off (Par. No. 490)** 176
  - Scale1 Input (Par. No. 484)** 175
  - Scale1 Mul (Par. No. 486)** 175
  - Scale1 Out Off (Par. No. 491)** 176
  - Scale1 Output (Par. No. 485)** 175
  - Scale2 Div (Par. No. 556)** 175
  - Scale2 In Abs (Par. No. 561)** 176

- Scale2 In Max (Par. No. 557) 175
- Scale2 In Min (Par. No. 558) 175
- Scale2 In Off (Par. No. 559) 176
- Scale2 Input (Par. No. 553) 175
- Scale2 Mul (Par. No. 555) 175
- Scale2 Out Off (Par. No. 560) 176
- Scale2 Output (Par. No. 554) 175
- Scale3 Div (Par. No. 1221) 175
- Scale3 In Abs (Par. No. 1226) 176
- Scale3 In Max (Par. No. 1222) 175
- Scale3 In Min (Par. No. 1223) 175
- Scale3 In Off (Par. No. 1224) 176
- Scale3 Input (Par. No. 1218) 175
- Scale3 Mul (Par. No. 1220) 175
- Scale3 Out Off (Par. No. 1225) 176
- Scale3 Output (Par. No. 1219) 175
- Scale4 Div (Par. No. 1230) 175
- Scale4 In Abs (Par. No. 1235) 176
- Scale4 In Max (Par. No. 1231) 175
- Scale4 In Min (Par. No. 1232) 175
- Scale4 In Off (Par. No. 1233) 176
- Scale4 Input (Par. No. 1227) 175
- Scale4 Mul (Par. No. 1229) 175
- Scale4 Out Off (Par. No. 1234) 176
- Scale4 Output (Par. No. 1228) 175
- Scale5 Div (Par. No. 1239) 175
- Scale5 In Abs (Par. No. 1244) 176
- Scale5 In Max (Par. No. 1240) 175
- Scale5 In Min (Par. No. 1241) 175
- Scale5 In Off (Par. No. 1242) 176
- Scale5 Input (Par. No. 1236) 175
- Scale5 Mul (Par. No. 1238) 175
- Scale5 Out Off (Par. No. 1243) 176
- Scale5 Output (Par. No. 1237) 175
- Scale6 Div (Par. No. 1248) 175
- Scale6 In Abs (Par. No. 1253) 176
- Scale6 In Max (Par. No. 1249) 175
- Scale6 In Min (Par. No. 1250) 175
- Scale6 In Off (Par. No. 1251) 176
- Scale6 Input (Par. No. 1245) 175
- Scale6 Mul (Par. No. 1247) 175
- Scale6 Out Off (Par. No. 1252) 176
- Scale6 Output (Par. No. 1246) 175
- SCR Diag Status (Par. No. 214) 147
- SCR Diag Test En (Par. No. 213) 146
- Secondary, Ungrounded 35
- Security group 193 . . . 194
- Selected TorqRef (Par. No. 14) 128
- series number 12
- set
  - DIP switch S14 61
  - DIP switch S15 79
  - DIP switch S4 79
- Set Fld Curve (Par. No. 919) 135
- set preferences
  - HIM 285
  - Shorted SCR fault 224
  - SLAT Dwell Time (Par. No. 16) 155
  - SLAT Err Stpt (Par. No. 15) 155
  - Software Version (Par. No. 331) 130
  - sourcing digital output
    - wiring 87
  - Spd 0 Trip Delay (Par. No. 627) 158
  - Spd Band Intgrtr (Par. No. 1106) 174
  - Spd Draw Out Pct (Par. No. 1019) 128
  - Spd FB Filt BW (Par. No. 915) 143
  - Spd FB Filt Gain (Par. No. 914) 143
  - Spd FB Loss Lvl (Par. No. 455) 141
  - Spd Fdbk Control (Par. No. 457) 142
  - Spd Fdbk Invert (Par. No. 461) 142
  - Spd Fdbk Loss fault 225
  - Spd Fdbk State (Par. No. 651) 181
  - Spd Limit Active (Par. No. 372) 178
  - Spd Loss Flt Cfg (Par. No. 478) 186
  - Spd Match Acc (Par. No. 1196) 170
  - Spd Match Compl (Par. No. 1203) 170
  - Spd Match Dec (Par. No. 1197) 170
  - Spd Match Gain (Par. No. 1200) 170
  - Spd Match Torque (Par. No. 1216) 171
  - Spd Ref Sel Sts (Par. No. 1330) 183
  - Spd Ref Zero En (Par. No. 124) 151
  - Spd Reg Autotune (Par. No. 1027) 144
  - Spd Reg BW (Par. No. 434) 152
  - Spd Reg Damping (Par. No. 436) 153
  - Spd Reg Ki (Par. No. 88) 149
  - Spd Reg Ki Base (Par. No. 94) 143
  - Spd Reg Ki Outpt (Par. No. 100) 150
  - Spd Reg Kp (Par. No. 87) 149
  - Spd Reg Kp Base (Par. No. 93) 143
  - Spd Reg Kp Outpt (Par. No. 99) 149
  - Spd Reg Neg Lim (Par. No. 96) 149
  - Spd Reg Out Pct (Par. No. 236) 129
  - Spd Reg P Filter (Par. No. 444) 153
  - Spd Reg Pos Lim (Par. No. 95) 149
  - Spd Select 0 (Par. No. 400) 181
  - Spd Select 1 (Par. No. 401) 181
  - Spd Select 2 (Par. No. 402) 181
  - Spd Trq Mode Sel (Par. No. 241) 155
  - Spd Tune Inertia (Par. No. 1030) 144
  - Spd Up Gain Pct (Par. No. 445) 153
  - Spd Zero I En (Par. No. 123) 151
  - Spd Zero P En (Par. No. 125) 151
  - Spd Zero P Gain (Par. No. 126) 152
  - SpdFuncSelect (Par. No. 1016) 154
  - SpdOut FiltBW (Par. No. 239) 152
  - SpdOut FiltGain (Par. No. 238) 152
  - SpdReg AntiBckup (Par. No. 643) 154
  - SpdReg BW Bypass (Par. No. 448) 153
  - SpdReg FB Bypass (Par. No. 458) 142
  - SpdReg Ki Bypass (Par. No. 460) 154
  - SpdReg Ki Pct (Par. No. 1035) 144

- SpdReg Kp Bypass (Par. No. 459)** 153
- SpdReg Kp Pct (Par. No. 1034)** 144
- SpdReg NegLmOut (Par. No. 90)** 128
- SpdReg PosLmOut (Par. No. 89)** 128
- SpdTune Friction (Par. No. 1031)** 144
- specifications**
  - DC contactor crimp lug kits 271
- Speed Command file** 148 . . . 154
- Speed Demand En (Par. No. 1215)** 171
- Speed Dev Band (Par. No. 1105)** 174
- speed draw**
  - function 341
- Speed Draw Out (Par. No. 1018)** 128
- Speed Feedback (Par. No. 122)** 127
- Speed Feedback Error alarm** 230
- Speed Feedback group** 138 . . . 143
- Speed Feedback Loss alarm** 230
- Speed Feedback Pct (Par. No. 121)** 127
- Speed Match (Par. No. 1195)** 170
- Speed Meters group** 126 . . . 128
- speed pot** 85
- Speed Ramp En (Par. No. 245)** 156
- Speed Ratio (Par. No. 1017)** 149
- Speed Ref A (Par. No. 44)** 126
- Speed Ref A Pct (Par. No. 47)** 126
- Speed Ref B (Par. No. 48)** 126
- Speed Ref B Pct (Par. No. 49)** 126
- Speed Ref Out (Par. No. 385)** 127
- Speed Ref Out Pct (Par. No. 384)** 127
- Speed Ref Source (Par. No. 1329)** 182
- speed reference sources**
  - auto 325
  - manual 325
- Speed References group** 149
- Speed Reg En (Par. No. 242)** 152
- Speed Reg In (Par. No. 118)** 127
- Speed Reg In Pct (Par. No. 117)** 126
- speed regulation**
  - function 335, 338, 339, 340, 341
- speed regulator**
  - tune 354
- Speed Regulator group** 149 . . . 154
- speed source**
  - change 326
- Speed Thresh Neg (Par. No. 102)** 150
- Speed Thresh Pos (Par. No. 101)** 150
- Speed Threshold (Par. No. 393)** 180
- speed threshold indicators**
  - function 339
- Speed Tune Aborted fault** 225
- Speed Tune Current Limit fault** 225
- Speed Tune Dir (Par. No. 1029)** 144
- Speed Tune Friction Low fault** 225
- Speed Tune Ki (Par. No. 1033)** 144
- Speed Tune Kp (Par. No. 1032)** 144
- Speed Tune Load High fault** 225
- speed up**
  - function 338
- Speed Up Base (Par. No. 446)** 153
- Speed Up Filter (Par. No. 447)** 153
- speed zero**
  - function 340
- Speed Zero Delay (Par. No. 108)** 151
- Speed Zero Level (Par. No. 107)** 151
- SSC Error fault** 225
- SSC Threshold (Par. No. 409)** 186
- Standalone Regulator**
  - catalog number 14
- standard drive**
  - catalog number 13
- standard I/O**
  - terminal blocks 83
  - wire size 83
  - wiring examples 85
- Start At Power Up alarm** 230
- start at powerup**
  - configure 348
- Start At Powerup (Par. No. 1344)** 159
- Start Inhibits (Par. No. 1403)** 184
- Start Mask (Par. No. 592)** 191
- Start Owner (Par. No. 601)** 192
- start up**
  - drive 93
- Static F Zero (Par. No. 1287)** 172
- Static Friction (Par. No. 1174)** 168
- status indicator**
  - HIM 220
- status indicators** 220
- Status1 at Fault (Par. No. 1349)** 184
- Status2 at Fault (Par. No. 1350)** 184
- Stop Modes group** 158
- Stop Owner (Par. No. 600)** 192
- storage (drive)**
  - altitude 11
  - humidity 11
  - temperature 11
- STS LED**
  - green, flashing 220
  - green, steady 220
  - red, flashing 220
  - red, steady 220
  - yellow, flashing 220
  - yellow, steady 220
- STune Overspeed fault** 225
- STune Stalled fault** 225
- STune Timeout fault** 225
- Sustained Curr fault** 225
- switching power supply circuit board**
  - fuses 259

## T

**tachometer**

- DIP switch 79
- ground 34
- terminal block 90

**Tachometer Speed (Par. No. 1408)** 128**Taper Enable (Par. No. 1176)** 169**TaskLoad 1 ms (Par. No. 1384)** 183**TaskLoad 2 ms (Par. No. 1385)** 183**TaskLoad 8 ms (Par. No. 1386)** 183**TB Manual Ref (Par. No. 267)** 149**temperature**

- drive 19

**Tension Reduct (Par. No. 1179)** 169**Tension Ref (Par. No. 1180)** 169**Tension Scale (Par. No. 1181)** 169**tension set point signal**

- configure 324

**terminal adapter kits**

- frame D 279

**terminal blocks**

- analog tachometer 90
- armature converter, frame A 51
- armature converter, frame B 52
- armature converter, frame C 52
- armature converter, frame D 53
- armature voltage feedback, frame A 55
- armature voltage feedback, frame B 55
- armature voltage feedback, frame C 56
- armature voltage feedback, frame D 56
- control circuit power 67
- encoder 88
- field, frame A 58
- field, frame B 59
- field, frame C 59, 60
- field, frame D 60
- I/O converter circuit board 394
- I/O expansion circuit board 392
- motor thermistor 64
- relay output 64
- SA-SB 70
- standard I/O 83

**test generator**

- use 349

**Test Generator group** 145 . . . 147**TestPoint Data (Par. No. 1382)** 183**TestPoint Sel (Par. No. 1381)** 183**testpoints** 233**thermal switch**

- configure 64

**thermistor**

- configure 64

**Threshold Delay (Par. No. 103)** 150**Time AccDec Min (Par. No. 1182)** 169**Torq Attributes group** 136 . . . 138**Torq Cur Filter (Par. No. 926)** 138**Torq Current Pct (Par. No. 1193)** 170**Torq Limit Slew (Par. No. 1104)** 174**Torq Limit Type (Par. No. 715)** 158**Torq Prov Cflct alarm** 230**Torq Prove Cfg (Par. No. 1100)** 173**Torq Prove Setup (Par. No. 1101)** 173**Torq Prove Sts (Par. No. 1103)** 174**Torq Red CurLim (Par. No. 13)** 157**Torque Const (Par. No. 1013)** 144**Torque Negative (Par. No. 347)** 178**Torque Positive (Par. No. 346)** 178**Torque Prove group** 173 . . . 175**Torque Reduction (Par. No. 342)** 137**Torque Ref (Par. No. 39)** 136**torque reference source** 326**Torque Winder En (Par. No. 1209)** 170**Total Inertia (Par. No. 433)** 152**TP Ends Config alarm**

- alarms

- TP Ends Config 230

**transient noise filter circuit board, frame C**

- fuses 262

**Trim Ramp (Par. No. 42)** 149**Trim Ramp Pct (Par. No. 378)** 149**Trim Speed (Par. No. 43)** 149**Trim Speed Pct (Par. No. 379)** 149**Trim Torque (Par. No. 40)** 137**Troubleshooting**

- Crane Setup Encoderless 317
- Crane Setup with Encoder 313

**troubleshooting** 219**TrqTpr Enable (Par. No. 750)** 137**TrqTpr Lim0 (Par. No. 751)** 137**TrqTpr Lim1 (Par. No. 752)** 137**TrqTpr Lim2 (Par. No. 753)** 137**TrqTpr Lim3 (Par. No. 754)** 137**TrqTpr Lim4 (Par. No. 755)** 137**TrqTpr Spd (Par. No. 756)** 138**TstGen Amplitude (Par. No. 60)** 145**TstGen Frequency (Par. No. 59)** 145**TstGen Offset (Par. No. 61)** 145**TstGen Output (Par. No. 58)** 145**tune**

- current regulator 350
- field current curve 358
- field current regulator 352
- speed regulator 354
- voltage regulator 356

## U

**UnderVlt Flt Dly (Par. No. 470)** 186**UnderVolt Thresh (Par. No. 481)** 186**Ungrounded Secondary** 35**unipolar speed reference**

- analog input 85

**User Defined group** 188 . . . 191**user sets** 285**UserDefined0 (Par. No. 503)** 189**UserDefined1 (Par. No. 504)** 189**UserDefined10 (Par. No. 513)** 189



**UserDefined11 (Par. No. 514)** 189  
**UserDefined12 (Par. No. 515)** 189  
**UserDefined13 (Par. No. 516)** 189  
**UserDefined14 (Par. No. 517)** 189  
**UserDefined15 (Par. No. 518)** 189  
**UserDefined2 (Par. No. 505)** 189  
**UserDefined3 (Par. No. 506)** 189  
**UserDefined4 (Par. No. 507)** 189  
**UserDefined5 (Par. No. 508)** 189  
**UserDefined6 (Par. No. 509)** 189  
**UserDefined7 (Par. No. 510)** 189  
**UserDefined8 (Par. No. 511)** 189  
**UserDefined9 (Par. No. 512)** 189  
**UsrDefBitWrdA (Par. No. 519)** 189  
**UsrDefBitWrdA0 (Par. No. 520)** 190  
**UsrDefBitWrdA1 (Par. No. 521)** 190  
**UsrDefBitWrdA10 (Par. No. 530)** 190  
**UsrDefBitWrdA11 (Par. No. 531)** 190  
**UsrDefBitWrdA12 (Par. No. 532)** 190  
**UsrDefBitWrdA13 (Par. No. 533)** 190  
**UsrDefBitWrdA14 (Par. No. 534)** 190  
**UsrDefBitWrdA15 (Par. No. 535)** 190  
**UsrDefBitWrdA2 (Par. No. 522)** 190  
**UsrDefBitWrdA3 (Par. No. 523)** 190  
**UsrDefBitWrdA4 (Par. No. 524)** 190  
**UsrDefBitWrdA5 (Par. No. 525)** 190  
**UsrDefBitWrdA6 (Par. No. 526)** 190  
**UsrDefBitWrdA7 (Par. No. 527)** 190  
**UsrDefBitWrdA8 (Par. No. 528)** 190  
**UsrDefBitWrdA9 (Par. No. 529)** 190  
**UsrDefBitWrdB (Par. No. 536)** 190  
**UsrDefBitWrdB0 (Par. No. 537)** 191  
**UsrDefBitWrdB1 (Par. No. 538)** 191  
**UsrDefBitWrdB10 (Par. No. 547)** 191  
**UsrDefBitWrdB11 (Par. No. 548)** 191  
**UsrDefBitWrdB12 (Par. No. 549)** 191  
**UsrDefBitWrdB13 (Par. No. 550)** 191  
**UsrDefBitWrdB14 (Par. No. 551)** 191  
**UsrDefBitWrdB15 (Par. No. 552)** 191  
**UsrDefBitWrdB2 (Par. No. 539)** 191  
**UsrDefBitWrdB3 (Par. No. 540)** 191  
**UsrDefBitWrdB4 (Par. No. 541)** 191  
**UsrDefBitWrdB5 (Par. No. 542)** 191  
**UsrDefBitWrdB6 (Par. No. 543)** 191  
**UsrDefBitWrdB7 (Par. No. 544)** 191  
**UsrDefBitWrdB8 (Par. No. 545)** 191  
**UsrDefBitWrdB9 (Par. No. 546)** 191  
**UsrDsplyDiv0 (Par. No. 51)** 188  
**UsrDsplyMult0 (Par. No. 50)** 188  
**UsrValDiv1 (Par. No. 54)** 188  
**UsrValMult1 (Par. No. 53)** 188  
**Utility file** 177 . . . 191

## V

**Variable J Comp (Par. No. 1171)** 168

### view

changed parameters 285  
 parameters 286  
 peripheral device parameters 285

### voltage regulator

tune 356

## W

**W Gain (Par. No. 1202)** 170

**W Offset (Par. No. 1199)** 170

**W Reference (Par. No. 1217)** 171

**W Target (Par. No. 1210)** 171

### warning

bipolar input 82

### watts loss

data 236

### weights

frame A 20

frame B 21

frame C 22

frame D 25

**Winder Functions group** 168 . . . 172

**Winder Side (Par. No. 1201)** 170

**Winder Type (Par. No. 1187)** 167

### wire size

armature terminals 51

armature voltage feedback 54

field 57

I/O converter circuit board 394

I/O expansion circuit board 391

PE ground 51

standard I/O 83

### wiring

2-wire control non-reversing 86

2-wire control reversing 86

3-wire control 86, 87

bipolar signal 85

bipolar speed reference 85

enable input 86

encoder 89

I/O expansion circuit board 392

joystick 85

potentiometer 85

power 45

sourcing digital output 87

unipolar speed reference 85

### wiring diagrams

I/O converter circuit board 395

### wiring examples

standard I/O 85

**Write Mask Act (Par. No. 1377)** 194

**Write Mask Cfg (Par. No. 1378)** 194

## Z

**Zero Ramp Input (Par. No. 345)** 156

**Zero Ramp Output (Par. No. 344)** 156

**Zero Torque (Par. No. 353)** 137

**ZeroSpdFloatTime (Par. No. 1113)** 175

**Notes:**



## Rockwell Automation Support

Use the following resources to access support information.

<b>Technical Support Center</b>	Knowledgebase Articles, How-to Videos, FAQs, Chat, User Forums, and Product Notification Updates.	<a href="https://rockwellautomation.custhelp.com/">https://rockwellautomation.custhelp.com/</a>
<b>Local Technical Support Phone Numbers</b>	Locate the phone number for your country.	<a href="http://www.rockwellautomation.com/global/support/get-support-now.page">http://www.rockwellautomation.com/global/support/get-support-now.page</a>
<b>Direct Dial Codes</b>	Find the Direct Dial Code for your product. Use the code to route your call directly to a technical support engineer.	<a href="http://www.rockwellautomation.com/global/support/direct-dial.page">http://www.rockwellautomation.com/global/support/direct-dial.page</a>
<b>Literature Library</b>	Installation Instructions, Manuals, Brochures, and Technical Data.	<a href="http://www.rockwellautomation.com/global/literature-library/overview.page">http://www.rockwellautomation.com/global/literature-library/overview.page</a>
<b>Product Compatibility and Download Center (PCDC)</b>	Get help determining how products interact, check features and capabilities, and find associated firmware.	<a href="http://www.rockwellautomation.com/global/support/pcdc.page">http://www.rockwellautomation.com/global/support/pcdc.page</a>

## Documentation Feedback

Your comments will help us serve your documentation needs better. If you have any suggestions on how to improve this document, complete the How Are We Doing? form at [http://literature.rockwellautomation.com/idc/groups/literature/documents/du/ra-du002\\_-en-e.pdf](http://literature.rockwellautomation.com/idc/groups/literature/documents/du/ra-du002_-en-e.pdf).

Rockwell Automation maintains current product environmental information on its website at <http://www.rockwellautomation.com/rockwellautomation/about-us/sustainability-ethics/product-environmental-compliance.page>.

Allen-Bradley, Connected Components Workbench, DriveExecutive, DriveTools, PowerFlex, and Rockwell Automation are trademarks of Rockwell Automation, Inc.

Trademarks not belonging to Rockwell Automation are property of their respective companies.

Rockwell Otomasyon Ticaret A.Ş., Kar Plaza İş Merkezi E Blok Kat:6 34752 İçerenköy, İstanbul, Tel: +90 (216) 5698400

**[www.rockwellautomation.com](http://www.rockwellautomation.com)**

### Power, Control and Information Solutions Headquarters

Americas: Rockwell Automation, 1201 South Second Street, Milwaukee, WI 53204-2496 USA, Tel: (1) 414.382.2000, Fax: (1) 414.382.4444

Europe/Middle East/Africa: Rockwell Automation NV, Pegasus Park, De Kleetlaan 12a, 1831 Diegem, Belgium, Tel: (32) 2 663 0600, Fax: (32) 2 663 0640

Asia Pacific: Rockwell Automation, Level 14, Core F, Cyberport 3, 100 Cyberport Road, Hong Kong, Tel: (852) 2887 4788, Fax: (852) 2508 1846

Publication 20P-UM001M-EN-P - November 2017

Supersedes Publication 20P-UM001L-EN-P - July 2015

Copyright © 2017 Rockwell Automation, Inc. All rights reserved. Printed in the U.S.A.