

PowerFlex 20-HIM-A6 and 20-HIM-C6S HIM (Human Interface Module)

FRN 1.xxx - 2.xxx



Important User Information

Solid-state equipment has operational characteristics differing from those of electromechanical equipment. Safety Guidelines for the Application, Installation and Maintenance of Solid State Controls (publication [SGI-1.1](#) available from your local Rockwell Automation sales office or online at <http://www.rockwellautomation.com/literature/>) describes some important differences between solid-state equipment and hard-wired electromechanical devices. Because of this difference, and also because of the wide variety of uses for solid-state equipment, all persons responsible for applying this equipment must satisfy themselves that each intended application of this equipment is acceptable.

In no event will Rockwell Automation, Inc. be responsible or liable for indirect or consequential damages resulting from the use or application of this equipment.

The examples and diagrams in this manual are included solely for illustrative purposes. Because of the many variables and requirements associated with any particular installation, Rockwell Automation, Inc. cannot assume responsibility or liability for actual use based on the examples and diagrams.

No patent liability is assumed by Rockwell Automation, Inc. with respect to use of information, circuits, equipment, or software described in this manual.

Reproduction of the contents of this manual, in whole or in part, without written permission of Rockwell Automation, Inc., is prohibited.

Throughout this manual, when necessary, we use notes to make you aware of safety considerations.



WARNING: Identifies information about practices or circumstances that can cause an explosion in a hazardous environment, which may lead to personal injury or death, property damage, or economic loss.



ATTENTION: Identifies information about practices or circumstances that can lead to personal injury or death, property damage, or economic loss. Attentions help you identify a hazard, avoid a hazard, and recognize the consequence.



SHOCK HAZARD: Labels may be on or inside the equipment, for example, a drive or motor, to alert people that dangerous voltage may be present.



BURN HAZARD: Labels may be on or inside the equipment, for example, a drive or motor, to alert people that surfaces may reach dangerous temperatures.

IMPORTANT

Identifies information that is critical for successful application and understanding of the product.

Allen-Bradley, Rockwell Software, Rockwell Automation, TechConnect, and PowerFlex are trademarks of Rockwell Automation, Inc.

Trademarks not belonging to Rockwell Automation are property of their respective companies.

This manual contains new and updated information.

**New and Updated
Information**

This table contains the changes made to this revision.

| Topic | Page |
|---|-------------------|
| Revised steps in various procedures to add clarity. | Throughout manual |

Notes:

| | | |
|---------------------------|---|----|
| Preface | Conventions Used in This Manual | 9 |
| | Rockwell Automation Support | 9 |
| | Local Product Support | 9 |
| | Technical Product Assistance | 9 |
| | Additional Resources | 10 |
| | Chapter 1 | |
| Getting Started | HIM Types | 11 |
| | Features | 11 |
| | Compatible Products | 12 |
| | Safety Precautions | 12 |
| | Chapter 2 | |
| Installing the HIM | Installing the 20-HIM-A6 HIM | 14 |
| | In the Drive HIM Bezel | 14 |
| | Using Drive Port 2 Connection for Hand-Held Operation | 16 |
| | In a Remote-Mount HIM Bezel (20-HIM-B1) | 17 |
| | Installing the 20-HIM-C6S HIM | 18 |
| | Removing the HIM | 20 |
| | Chapter 3 | |
| HIM Components | HIM Keypad | 21 |
| | Soft Keys | 21 |
| | Navigation and Number Keys | 22 |
| | Single-function Keys | 23 |
| | LCD Display Elements | 24 |
| | Status Bar | 24 |
| | Data Area | 24 |
| | Soft Key Labels | 25 |
| | Main Screens | 26 |
| | Status Screen | 26 |
| | Process Screen | 27 |
| | Control Screen | 28 |
| | Folder Screens | 29 |
| | Fault Display Screen | 30 |

Using the HIM

Chapter 4

Initial HIM Operation on New Drive Powerup..... 31

Selecting Display Contrast 32

Setting the Date/Time for PowerFlex 750-Series Drives 33

Creating a User-Defined Drive/Peripheral Name 35

Customizing the Process Screen 36

 Selecting Multi-Line or Single-Line View 36

 Changing Displayed Items, Adding a Scale Factor,
 or Customizing Text 37

Resetting the Drive/Peripherals 38

Setting Factory Defaults 38

 Setting PowerFlex 750-Series Drives/Peripherals
 to Factory Defaults..... 38

 Setting PowerFlex 7-Class Drives/Peripherals
 to Factory Defaults..... 39

Setting Display Flashing for Fault Indication 40

Setting Display Flashing for Alarm Indication 41

Viewing/Editing Drive or Peripheral Parameters..... 42

 Selecting File-Group-Parameter or Linear List View 42

 Direct Parameter Access Method 42

 Alternate Linear List Access Method..... 43

Viewing/Clearing Drive Faults or Alarms 44

Viewing Peripheral Diagnostic Items..... 45

Viewing/Clearing Peripheral Events 46

Checking Drive and Peripheral Firmware Revisions 47

Using the CopyCat Function 48

 Creating CopyCat Files 48

 Renaming CopyCat Files..... 49

 Deleting CopyCat Files 51

Changing PowerFlex 750-Series Drive Parameter Associations 52

 Using Individual Screen Entry Method..... 52

 Using Direct Numeric Entry Method 54

Linking Parameters in PowerFlex 700/700S Drives 55

 Establishing a Link 55

 Deleting an Established Link 56

Using a Password..... 57

 Setting/Changing the Password..... 57

 Changing Password-protected Drive/Peripheral Parameters..... 58

 Disabling Password Protection..... 59

Initiating PowerFlex 750-Series Drive Port Verification 60

 Conflict Types 60

 Resolving ‘Changed’ or ‘Requires Configuration’ Conflicts..... 61

 Resolving ‘Not Functioning’, ‘Not Supported’,
 or ‘Invalid Duplicate’ Conflicts..... 61

Changing Language for the Display Text 62

Updating the HIM Firmware or Language 63

| | | |
|---------------------------|--------------------------------------|----|
| Specifications | Appendix A | |
| | Communications..... | 65 |
| | Electrical..... | 65 |
| | Mechanical..... | 65 |
| | Environmental..... | 65 |
| | Regulatory Compliance..... | 66 |
| HIM Parameters | Appendix B | |
| | Parameter List..... | 67 |
| History of Changes | Appendix C | |
| | 20HIM-UM001C-EN-P, January 2012..... | 69 |
| | 20HIM-UM001B-EN-P, October 2010..... | 70 |
| | 20HIM-UM001A-EN-P, January 2009..... | 70 |
| | Index | |

Notes:

This manual provides information about the enhanced PowerFlex 20-HIM-A6 and 20-HIM-C6S Human Interface Modules, and using them with PowerFlex 750-Series drives and PowerFlex® 7-Class drives.

Conventions Used in This Manual

The following conventions are used throughout this manual:

- Parameter names are shown in the format **Parameter xx - [*]**. The xx represents the parameter number. The * represents the parameter name—for example **Parameter 01 - [Port Number]**.
- The HIM or drive firmware revision number (FRN) is displayed as FRN *X.xxx*, where 'X' is the major revision number and 'xxx' is the minor revision number.

Rockwell Automation Support

Rockwell Automation offers support services worldwide, with over 75 sales and support offices, over 500 authorized distributors, and over 250 authorized systems integrators located through the United States alone. In addition, Rockwell Automation representatives are in every major country in the world.

Local Product Support

Contact your local Rockwell Automation representative for the following:

- Sales and order support
- Product technical training
- Warranty support
- Support service agreements

Technical Product Assistance

For technical assistance, please review the information in [Chapter 4](#), Using the HIM, first. If you still have problems, then access the Allen-Bradley Technical Support website at <http://www.ab.com/support/abdrives> or contact Rockwell Automation.

Additional Resources

These documents contain additional information concerning related products from Rockwell Automation.

| Resource | Description |
|--|--|
| PowerFlex 750-Series AC Drive Installation Instructions, publication 750-IN001 | Information on installing and programming PowerFlex 750-Series AC drives |
| PowerFlex 750-Series AC Drives Programming Manual, publication 750-PM001 | |
| PowerFlex 750-Series AC Drives Technical Data, publication 750-TD001 | |
| PowerFlex 70 User Manual, publication 20A-UM001 | Information on installing and programming PowerFlex 70 standard control and enhanced control drives. |
| PowerFlex 70/700 Reference Manual, publication PFLEX-RM001 | |
| PowerFlex 70 Enhanced Control and 700 Vector Control Reference Manual, publication PFLEX-RM004 | |
| PowerFlex 700 Series A User Manual, publication 20B-UM001 | Information on installing and programming PowerFlex 700 standard control and vector control Series A drives, and PowerFlex 700 vector control Series B drives. |
| PowerFlex 700 Series B User Manual, publication 20B-UM002 | |
| PowerFlex 70/700 Reference Manual, publication PFLEX-RM001 | |
| PowerFlex 70 Enhanced Control and 700 Vector Control Reference Manual, publication PFLEX-RM004 | |
| PowerFlex 700H Installation Instructions, publication PFLEX-IN006 | Information on installing and programming PowerFlex 700H drives. |
| PowerFlex 700H Programming Manual, publication 20C-PM001 | |
| PowerFlex 700S with Phase I Control Installation Manual (Frames 1...6), publication 20D-IN024 | Information on installing and programming PowerFlex 700S drives. |
| PowerFlex 700S with Phase I Control Installation Manual (Frames 9 and 10), publication PFLEX-IN006 | |
| PowerFlex 700S with Phase I Control User Manual (All Frame Sizes), publication 20D-UM001 | |
| PowerFlex 700S with Phase I Control Reference Manual, publication PFLEX-RM002 | |
| PowerFlex 700S with Phase II Control Installation Manual (Frames 1...6), publication 20D-IN024 | |
| PowerFlex 700S with Phase II Control Installation Manual (Frames 9...14), publication PFLEX-IN006 | |
| PowerFlex 700S with Phase II Control Programming Manual (All Frame Sizes), publication 20D-PM001 | |
| PowerFlex 700S with Phase II Control Reference Manual, publication PFLEX-RM003 | |
| PowerFlex 700L User Manual, publication 20L-UM001 | Information on installing and programming PowerFlex 700L Liquid-Cooled AC drives. |
| PowerFlex Digital DC Drive User Manual, publication 20P-UM001 | Information on installing and programming PowerFlex Digital DC drives. |

You can view or download publications at <http://literature.rockwellautomation.com>. To order paper copies of technical documentation, contact your local Allen-Bradley distributor or Rockwell Automation sales representative.

To find your local Rockwell Automation distributor or sales representative, visit <http://www.rockwellautomation.com/locations>.

For information such as firmware updates or answers to drive-related questions, go to the Drives Service & Support website at <http://www.ab.com/support/abdrives> and click the Downloads or Knowledgebase link.

Getting Started

The PowerFlex 20-HIM-A6 and 20-HIM-C6S HIMs provide a communication interface to configure and monitor PowerFlex 753 and PowerFlex 755 AC drives and their connected peripherals. These HIMs are also backward compatible with all PowerFlex 7-Class drives, but with limited functionality.

| Topic | Page |
|-------------------------------------|------|
| HIM Types | 11 |
| Features | 11 |
| Compatible Products | 12 |
| Safety Precautions | 12 |

HIM Types

At the time of publication, the following enhanced PowerFlex 7-Class HIMs are available.

| HIM Catalog Number | Description |
|---------------------------|----------------------------------|
| 20-HIM-A6 ⁽¹⁾ | NEMA Type 1 HIM |
| 20-HIM-C6S ⁽¹⁾ | Remote-Mount NEMA Type 4X/12 HIM |

(1) Supports English, Portuguese, French, Italian, German, Spanish, and Dutch languages. The HIM firmware can be updated in the field to support other available languages. **Important:** The language selected for download at the Rockwell Automation Web Updates website at <http://www.ab.com/support/abdrives/webupdate> will replace all other supported languages—except English, which will always remain as the default language.

Features

The enhanced PowerFlex 20-HIM-A6 and 20-HIM-C6S HIMs provide the following benefits over the more basic PowerFlex 7-Class HIMs (catalog numbers 20-HIM-A3, 20-HIM-A5, 20-HIM-C3S, and 20-HIM-C5S):

- Full-numeric keypad with fully-integrated navigation capability to more easily configure and monitor the drive and its connected peripherals.
- Better keypad touch response and improved tactile feel to provide more gratifying, error-free data entry.
- More intuitive access and new menu structures that increase HIM operating efficiency.
- Simplified custom name assignments for drive/peripherals (for example, Pump 1) to reduce required key presses.

- Support for English, and customary European and Asian languages.
- Dynamic soft keys that change functions/names based on screen or data entry mode to reduce keypad keys and simplify HIM operation.
- Customizable drive monitoring items that can be displayed as a list on the process screen or as individual screens.
- New flashing LCD screen to provide enhanced visibility when faults or alarms are detected.

Compatible Products

At the time of publication, the 20-HIM-A6 and 20-HIM-C6S HIMs are compatible with the following products:

- PowerFlex 753 drives
- PowerFlex 755 drives
- PowerFlex 70 drives with standard or enhanced control
- PowerFlex 700 drives with standard or vector control
- PowerFlex 700H drives
- PowerFlex 700S drives with Phase I or Phase II control
- PowerFlex 700L drives with 700 vector control or 700S control
- PowerFlex 700AFE (Active Front End)
- PowerFlex Digital DC drives
- PowerFlex 7000 drives
- SMC™ Flex smart motor controllers
- SMC-50 smart motor controllers

Safety Precautions

Please read the following safety precautions carefully.



ATTENTION: Risk of injury or death exists from machine motion when using the HIM to Start/Stop/Jog or configure the drive.



ATTENTION: Risk of injury or equipment damage exists. Only personnel familiar with drive and power products and the associated machinery should plan or implement the installation, startup, configuration, and subsequent maintenance of the product using the HIM. Failure to comply may result in injury and/or equipment damage.

Installing the HIM

This chapter provides instructions for installing and removing the HIM.

| Topic | Page |
|---|------|
| Installing the 20-HIM-A6 HIM | 14 |
| Installing the 20-HIM-C6S HIM | 18 |
| Removing the HIM | 20 |

There are two types of enhanced PowerFlex 7-Class HIM:

- NEMA Type 1 (catalog number 20-HIM-A6)
- Remote-mount NEMA Type 4X/12 (catalog number 20-HIM-C6S), which also includes a 1202-C30 interface cable for connection to the drive

20-HIM-A6 HIM



20-HIM-C6S HIM



Installing the 20-HIM-A6 HIM

The 20-HIM-A6 (NEMA Type 1) HIM is normally installed in the HIM bezel (drive Port 1) on the front of the drive. For temporary hand-held operation, the HIM can be plugged into drive Port 2 (near the bottom of the drive control pod for PowerFlex 750-Series drives, or on the bottom of the drive for PowerFlex 7-Class drives) using a 1 m/3.28 ft. long 20-HIM-H10 cable. For applications requiring the HIM to be located remotely, the HIM can be installed in a remote-mount HIM bezel (catalog number 20-HIM-B1) in a suitable location. The 20-HIM-B1 remote-mount HIM bezel includes a 3 m/9.8 ft. long 1202-C30 cable.

In the Drive HIM Bezel

PowerFlex 750-Series IP20, NEMA/UL Open Type Drives

Place the HIM into the drive HIM bezel by inserting it straight back into the top of the bezel and then sliding it down into the base of the bezel onto the mating connector.

TIP The HIM can be installed in the drive HIM bezel with the drive powered or unpowered.

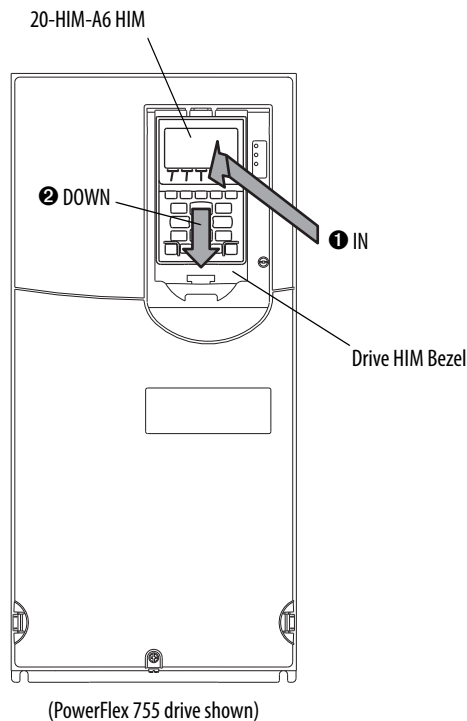

PowerFlex 750-Series IP54, NEMA/UL Type 12 Drives

1. Unfasten and remove the cover as shown below using the following recommended tools:
 - Screwdriver: 6.4 mm (0.25 in.) flat or T20 Hexalobular
 - Hex socket: 7 mm

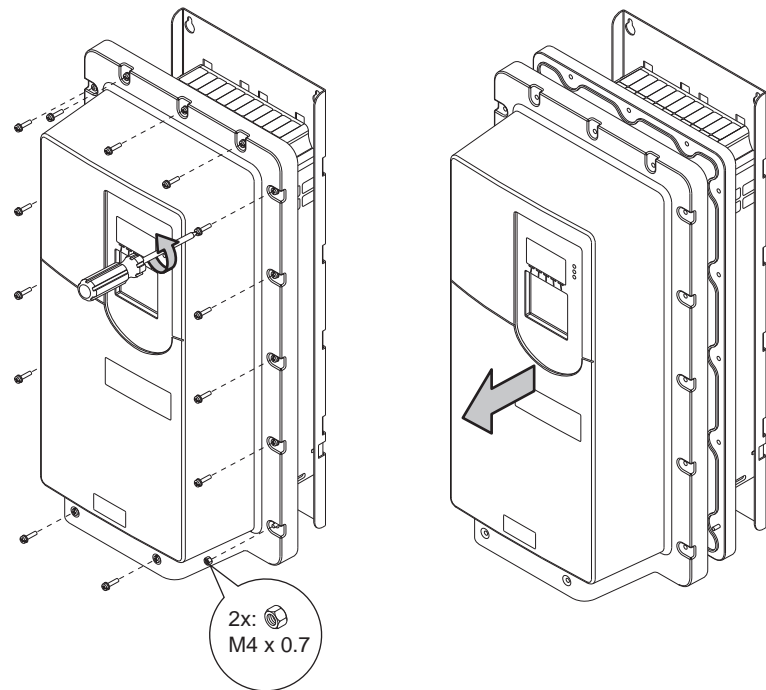

2. Place the HIM into the drive HIM bezel by inserting it straight back into the top of the bezel and then sliding it down into the base of the bezel onto the mating connector as shown on [page 14](#).
3. Replace the cover and the fasteners.
4. Tighten all screws and nuts to the recommended torque of 0.68 N•m (6.0 lb•in).

Using Drive Port 2 Connection for Hand-Held Operation

PowerFlex 750-Series Drive

Attach a 20-HIM-H10 cable to the bottom of the HIM. Then plug the other end of the cable into Port 2 near the bottom of the drive control pod.

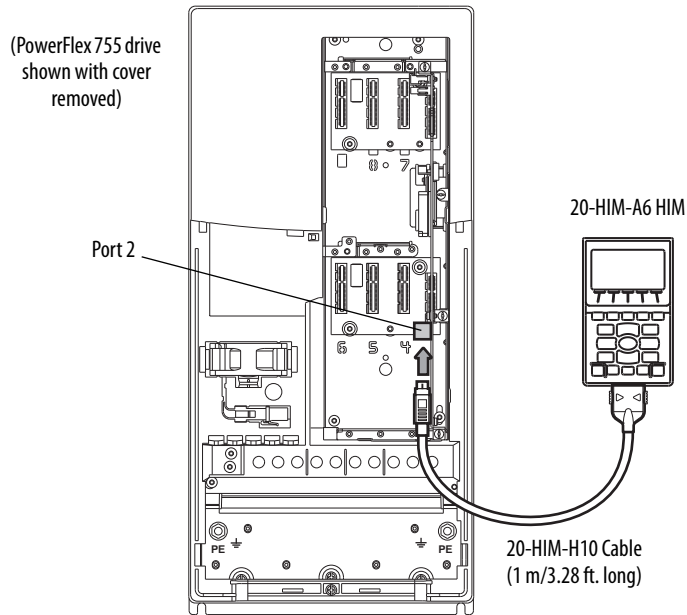

PowerFlex 7-Class Drive

Attach a 20-HIM-H10 cable to the bottom of the HIM. Then plug the other end of the cable into Port 2 on the bottom of the drive.

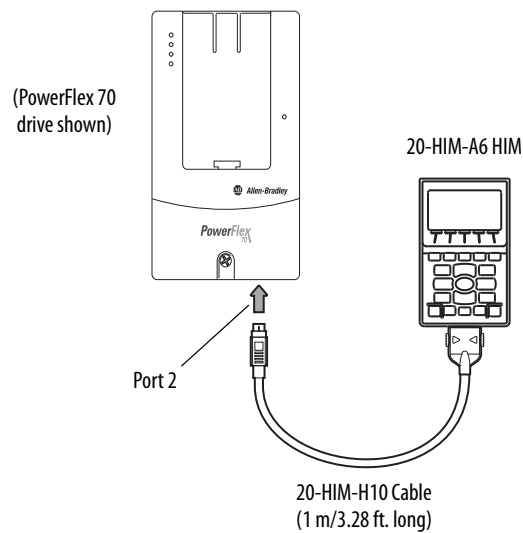

In a Remote-Mount HIM Bezel (20-HIM-B1)

1. If the remote-mount HIM bezel is not mounted, see the HIM Bezel Installation Instructions, publication 20HIM-IN002, for mounting details.
2. Route the 3 m/9.8 ft. long 1202-C30 bezel cable (included with the 20-HIM-B1 remote-mount HIM bezel) to the drive.
3. Connect the bezel cable to the DPI Port 2 on the drive as shown on [page 16](#) for a PowerFlex 750-Series drive or a PowerFlex 7-Class drive.
4. Install the HIM into the remote-mount HIM bezel.

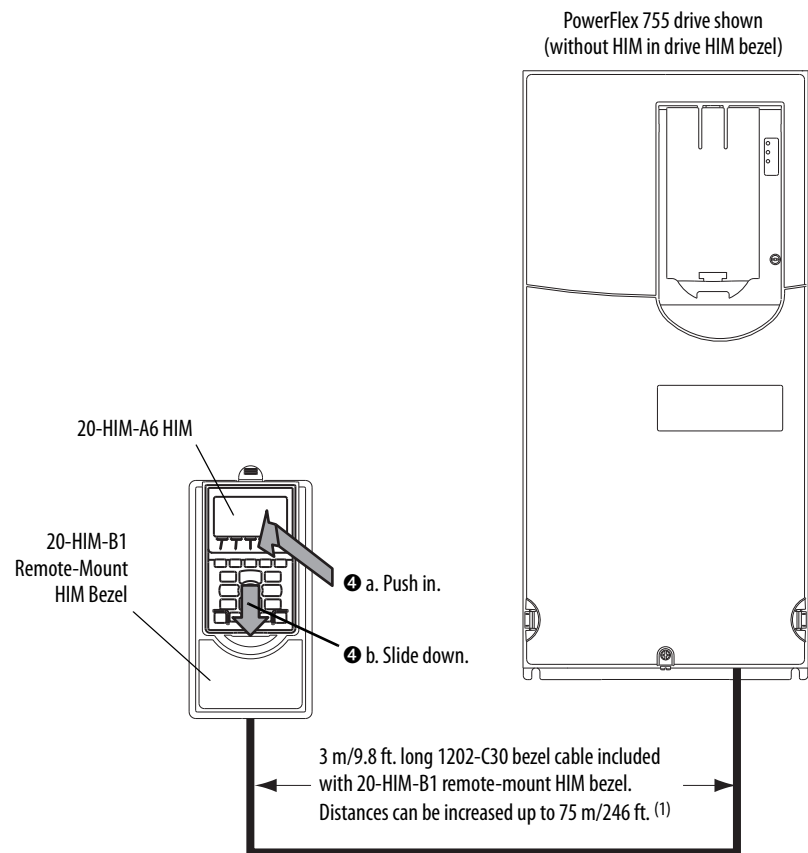

(1) To increase this distance, use one of the following cables:

- 1202-H03 Extension cable (0.3 m/0.98 ft. long)
- 1202-H13 Extension cable (1.0 m/3.28 ft. long)
- 1202-H30 Extension cable (3.0 m/9.8 ft. long)
- 1202-CBL-KIT-100M cable

Note that a cable distance greater than 30 m/98.4 ft. is not CE compliant.

Installing the 20-HIM-C6S HIM

The 20-HIM-C6S (NEMA Type 4X/12) HIM is designed for remote installation and includes a 3 m/9.8 ft. long 1202-C30 cable. See [Figure 1](#) for overall HIM dimensions. Choose an appropriate location to mount the 20-HIM-C6S HIM. The distance between the HIM and drive can be increased up to 75 m/246 ft. by using a 1202-Hxx extension cable or 1202-CBL-KIT-100M cable kit. However, a cable distance greater than 30 m/98.4 ft. is not CE compliant.

Figure 1 - 20-HIM-C6S HIM Dimensions

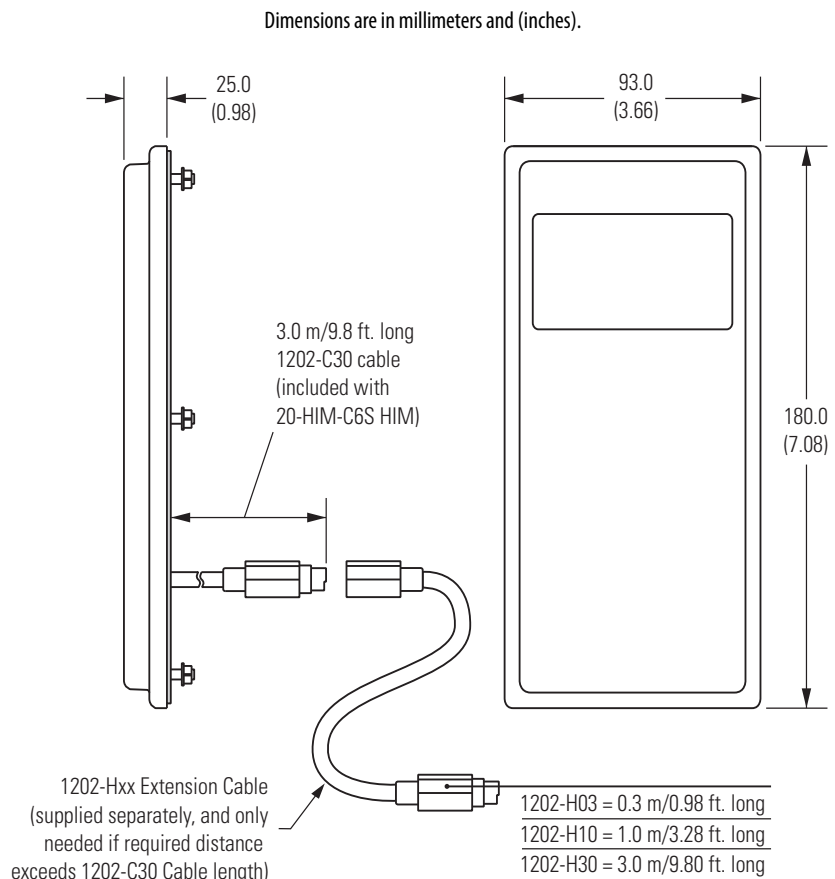

1. Drill the required hole pattern in the panel. See [Figure 2](#) for dimensions.

TIP A conversion template (part number 336745-C01), provided with the 20-HIM-C6S HIM, includes a drilling pattern and mounting instructions to assist with HIM installation.

Figure 2 - Hole Pattern to Mount the 20-HIM-C6S HIM

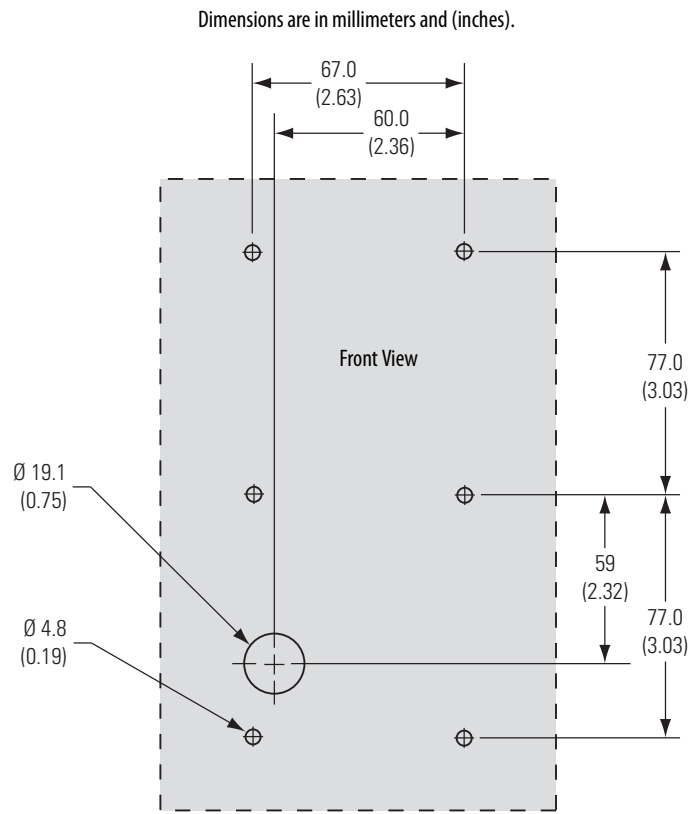

2. Peel the protective film from the gasketed surface on the back of the HIM.

IMPORTANT Adhesive coated gasket is designed for one-time only installation.

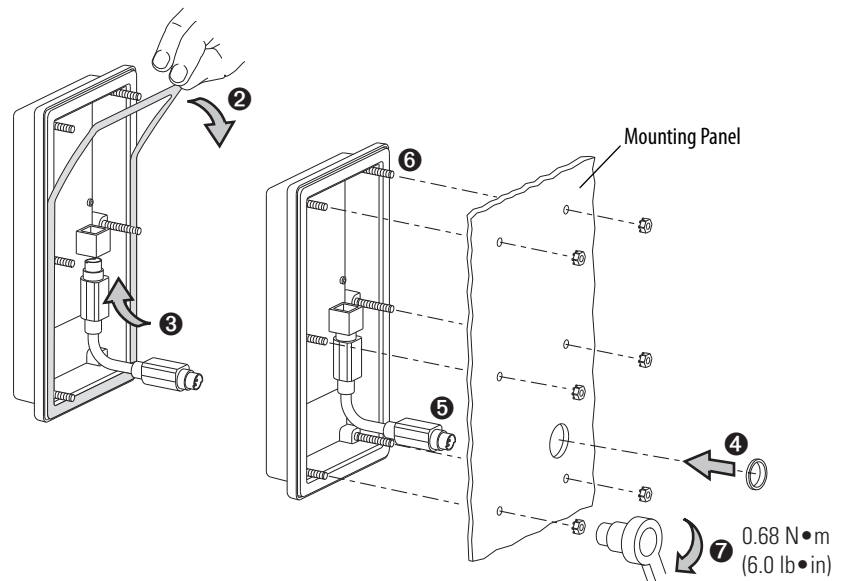

3. Insert the supplied 3 m/9.8 ft. long 1202-C30 HIM cable into the mating socket on the back of the HIM.
4. Install the supplied O-ring into the cable routing hole on the panel to protect the cable.
5. Route the HIM cable through the cable routing hole on the panel.
6. Align the six threaded studs of the HIM with the panel clearance holes, and place the HIM against the panel.
7. Tighten the nuts onto the six threaded studs of the HIM extending behind the panel.
Recommended torque is 0.68 N•m (6.0 lb•in).
8. Route the HIM cable to the drive.
9. Connect the HIM cable to the DPI Port 2 on the drive as shown on [page 16](#) for a PowerFlex 750-Series drive or a PowerFlex 7-Class drive.

Removing the HIM



ATTENTION: Risk of injury or equipment damage exists. If the HIM cable or remote-mount HIM bezel cable is disconnected from DPI Port 2 on the drive, the drive may fault. Determine how the drive will respond before disconnecting the cable.

IMPORTANT The Host drive can remain powered when removing the HIM. However, a fault will occur if the HIM is not the last controlling device and does not have Manual control of the Host drive. To avoid a fault in this case, access the HIM Control screen (shown on [page 28](#)), press the  key, and then remove the HIM from the Host drive.

Remove the HIM from the drive HIM bezel or the remote-mount HIM bezel in reverse order of how it was installed.

HIM Components

This chapter describes the components of the HIM.

| Topic | Page |
|--------------------------------------|------|
| HIM Keypad | 21 |
| LCD Display Elements | 24 |
| Main Screens | 26 |

HIM Keypad

The keypad consists of *soft keys*, navigation and number keys, and single-function keys, which are described in their respective subsections that follow.

Soft Keys

The *soft keys* on the HIM are located at the top of the keypad and highlighted below. Depending on the screen being displayed or the data entry mode being used, a *soft key* name and its function changes. When a dynamic *soft key* (up to a maximum of five keys) is active, its present function and corresponding Soft Key Label ([Figure 3](#)) is shown at the bottom of the HIM screen. For a list of possible *soft keys*, their names, and corresponding functions, see [Soft Key Labels on page 25](#).

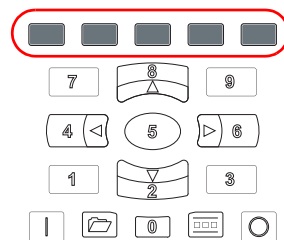

Navigation and Number Keys

The five blue multi-function keys (2, 4, 5, 6, and 8) shown below are used to do the following:

- Enter their respective numeric value
- Scroll menus/screens
- Perform corresponding functions displayed in the Data Area (see [page 24](#))

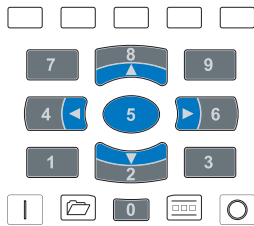





| Multi-function Key | Name | Function |
|--------------------|---------------|---|
| | 2/Down Arrow | <ul style="list-style-type: none"> • Enters the numeric value '2'. • Scrolls down to select an item. |
| | 4/Left Arrow | <ul style="list-style-type: none"> • Enters the numeric value '4'. • Scrolls left to select an item. |
| | 5/Enter | <ul style="list-style-type: none"> • Enters the numeric value '5'. • Displays the next level of a selected menu item. • Enters new values. • Performs intended actions. |
| | 6/Right Arrow | <ul style="list-style-type: none"> • Enters the numeric value '6'. • Scrolls right to select an item. |
| | 8/Up Arrow | <ul style="list-style-type: none"> • Enters the numeric value '8'. • Scrolls up to select an item. |

The five gray number keys (0, 1, 3, 7, and 9) are used only to enter their respective numeric value.

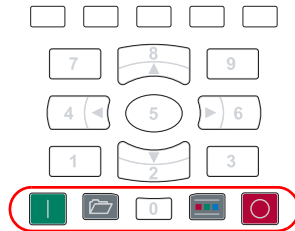
Single-function Keys

There are four single-function keys, which are highlighted below and listed in the table below. Each single-function key always performs only its dedicated function.



| Single-function Key | Name | Function |
|---|----------|--|
|  | Start | Starts the drive. |
|  (1) | Folders | Accesses folders for parameters, diagnostics, memory functions, preferences, and other tasks. |
|  (1) | Controls | Accesses jog, direction, auto/manual, and other control functions. |
|  | Stop | <ul style="list-style-type: none"> Stops the drive or clears a fault. This key is always active. This key is controlled by drive parameter 307 [Start Stop Mode]. |

(1) During drive Start Up these keys are temporarily inactive.

LCD Display Elements

The basic HIM screen is divided into three display zones, which are shown in [Figure 3](#) and described in their respective subsections that follow.

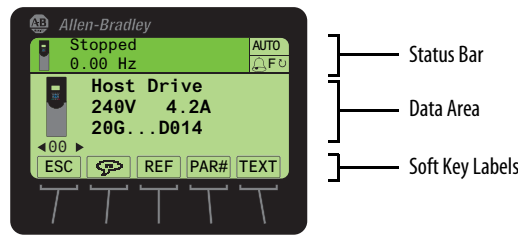

Figure 3 - HIM Display Zones

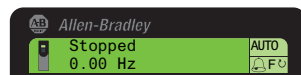

Status Bar

The Status Bar provides operating status information for the host drive.





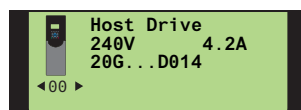

| Status Bar Element | | Meaning |
|---|------------------------|--|
|  | Host Icon | A small image of the connected host drive. |
| Stopped | Status Text | Indicates present host drive operating status. Text flashes when a fault is present. |
| 0.00 Hz | Feedback | Indicates drive output feedback (for example, Hz, RPM, amps, etc.) |
| AUTO / MAN | Mode Indication | Indicates Auto or Manual HIM status. |
|  | Alarm Indication | Bell icon indicates that an alarm is present. |
| F0 or R0 (not shown) | Rotation Indication | Indicates Forward or Reverse direction of host drive operation. |
| DLX (not shown) | DeviceLogix Indication | Indicates when the host drive DeviceLogix feature is enabled. |

Data Area

The Data Area displays the data or function presently being acted upon.



| Data Area Element | | Meaning |
|---|---------------------|---|
|  | Host or Device Icon | Image of the host drive or image of the device connected to the port selected. |
|  | Port Selection | Indicates selected port. Use the  or  navigation keys to select a port. |
| Host Drive | User-Definable Text | Top line of text in the Data Area can be edited by the user. |

Soft Key Labels

The Soft Key Labels identify the present function of a corresponding Soft Key on the Key Pad. Different screens may show different Soft Key Labels.

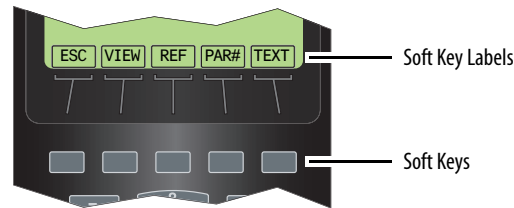

| Soft Key Label | Name | Function |
|---|---------------|---|
| . | Decimal Point | Adds decimal point to the right-most position of a numeric value. |
| ← | Backspace | Deletes the character to the left of the cursor. |
| + / - | Sign | Changes the sign of a parameter value. |
| # | Number | Selects the Direct Numeric Entry Method to change PowerFlex 750-Series drive parameter associations. |
|  | Language | Directly accesses the Select Language To Use screen. |
| ▲ | Scroll Up | <ul style="list-style-type: none"> Scrolls up through display lines. Increases a value. |
| ▼ | Scroll Down | <ul style="list-style-type: none"> Scrolls down through display lines. Decreases a value. |
| ◀ | Scroll Left | Scrolls left through display lines. |
| ▶ | Scroll Right | Scrolls right through display lines. |
| ACK | Acknowledge | Acknowledges the fault or alarm on the pop-up screen, stops the backlight from flashing, and keeps the pop-up screen active. |
| ALL | All | <ul style="list-style-type: none"> Clears all faults, alarms or events when a pop-up box appears from a queue screen. Restores all Host or Port device parameters to factory defaults. |
| CLR | Clear | <ul style="list-style-type: none"> Deletes an entire text string. Displays the Select Action pop-up box used to clear the selected fault, alarm or event, or the entire fault, alarm or event queue. |
| DEL | Delete | Deletes a highlighted character. |
| EDIT | Edit | <ul style="list-style-type: none"> Accesses a displayed parameter to edit. Accesses the Edit Process Display screen. |
| END | End | <ul style="list-style-type: none"> Displays the end (least recent) fault, alarm or event in a queue Scrolls to the end line of data on the Device Version information screen. |
| ENTER | Enter | <ul style="list-style-type: none"> Displays the next level of a selected menu item. Enters new values. Performs the intended action. |
| ESC | Escape | <ul style="list-style-type: none"> Cancels port verification conflict pop-up box during procedure to resolve a conflict. Cancels the existing screen and returns to the previous screen. Cancels an entry. Cancels pop-up Fault Display screen. Displays the time zone groups list screen (only when the Date/Time Set Edit Mode screen is shown). |
| EXP | Exponent | Allows data entry using scientific notation for 32-bit REAL (floating point) values. |
| FIX | Fix | Fixes 'Changed' or 'Requires Configuration' port verification conflicts upon power up. |
| INFO | Information | <ul style="list-style-type: none"> Shows additional information about a selected port verification conflict upon power up. Shows additional information about Set Default actions. |
| INS | Insert | Inserts a space to the left of a highlighted character. |
| LINK | Link | Displays a Link Edit pop-up box to link parameters (only PowerFlex 7-Class drives). |
| LOWER | Lower | Displays the lower 16 bits (bits 0 . . . 15) of a 32-bit Bit-type parameter. |

| Soft Key Label | Name | Function |
|----------------|------------------|---|
| MOST | Most | Restores most Host or Port device parameters to factory defaults. |
| PAR# | Parameter Number | Navigates directly to a parameter. |
| PGDN | Page Down | Scrolls down to the next page of data lines on the Device Version information screen. |
| PGUP | Page Up | Scrolls up to the previous page of data lines on the Device Version information screen. |
| REF | Reference | Enters the speed reference for the Host Drive. |
| RESET | Reset | Resets the Process screen's displayed monitoring items to the factory default monitoring items listed on page 36 . |
| TEXT | Text | Edits user-definable text for the device selected. |
| TOP | Top | <ul style="list-style-type: none"> Displays the top (most recent) fault, alarm or event in a queue. Scrolls to the top line of data on the Device Version information screen. |
| UPPER | Upper | Displays the upper 16 bits (bits 16 . . . 31) of a 32-bit Bit-type parameter. |
| VIEW | View | <ul style="list-style-type: none"> Toggles between select screens and views. Displays the time stamp screen from a fault, alarm or event queue screen. |
| ZONES | Zones | Displays the Select Time Zone screen. |

Main Screens

The HIM main screens include the Status screen, Process screen, Control screen, Folder screens, and Fault Display screens, which are described in their respective subsections that follow.

Status Screen

On power up, the Status screen ([Figure 4](#)) is shown by default. Depending on the type of host drive, the Status screen displays the following information.

| Displayed Information | Host PowerFlex Drive | |
|--------------------------------------|----------------------|----------------|
| | 750-Series | 7-Class |
| Selected device icon and port number | ✓ | ✓ |
| Device name ⁽¹⁾ | ✓ | ✓ |
| Rating text (volts, amps) | ✓ | ✓ |
| Drive catalog text | ✓ | not applicable |
| Firmware version and hardware series | ⁽²⁾ | ✓ |

- (1) The displayed default device name is dependent on the host drive. The device name can be changed, for example, to Host Drive as shown in the screens below. See [Creating a User-Defined Drive/Peripheral Name on page 35](#) for details.
- (2) The firmware version and hardware series for a PowerFlex 750-Series drive can be shown using HIM menu screens. For details, see [Checking Drive and Peripheral Firmware Revisions on page 47](#).

Figure 4 - Example Status Screens

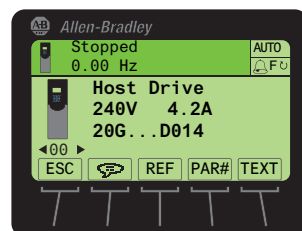

For PowerFlex 750-Series Drive

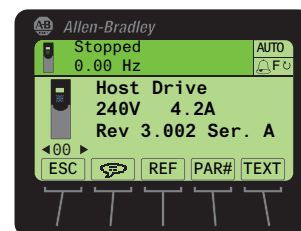



For PowerFlex 7-Class Drive

Status Screen Soft Keys

| Label | Name | Function |
|---|------------------|--|
| ESC | Escape | Toggles between the Status and Process Display screens. |
|  | Language Icon | Directly accesses the Select Language To Use screen. |
| REF | Reference | Enters the speed reference for the Host Drive. |
| PAR# | Parameter Number | Directly accesses a parameter for the device on selected port. (This soft key is not available if the device has no parameters.) |
| TEXT | Text | Edits user-definable text for the device on selected port. |

Status Screen Navigation/Number Keys

| Key | Name | Function | Screen Element |
|---|---------------|--------------------------------------|---|
|  | 4/Left Arrow | Selects the device on previous port. |  |
|  | 6/Right Arrow | Selects the device on next port. | |

If you would rather see the Process screen (shown below) as the initial power-up screen, change the HIM **Parameter 03 - [Initial Screen]** value to '1' (Process Scrn). By default, when the HIM keys are not used for the time period set in **Parameter 07 - [User Dspy Time]**, the screen being displayed at that time will revert back to the initial screen. You can disable this feature by setting **Parameter 06 - [User Dspy Enable]** to '1' (Disable).

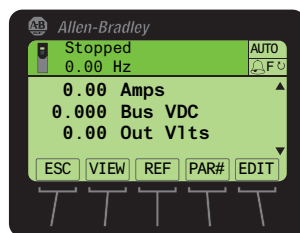

Process Screen

To display the Process screen, press the ESC *soft key* on the Status screen ([Figure 4](#)). The Process screen shows various drive monitoring parameters. Multi-line and Single-line views can be selected by pressing the VIEW *soft key*. The displayed default monitoring parameters can be changed. See [Customizing the Process Screen on page 36](#) for details.

*Process Screen Soft Keys*

| Label | Name | Function |
|-------|------------------|---|
| ESC | Escape | Toggles between the Process Display and Status screens. |
| VIEW | View | Toggles between the multi-line and single-line views. |
| REF | Reference | Enters the speed reference for the Host Drive. |
| PAR# | Parameter Number | Directly accesses a parameter for the selected port device. |
| EDIT | Edit | Directly accesses the Edit Process Display screen. |

Process Screen Navigation/Number Keys

| Key | Name | Function | Screen Element |
|---|--------------|---|----------------|
|  | 8/Up Arrow | Scrolls up through the display lines. | ▲ |
|  | 2/Down Arrow | Scrolls down through the display lines. | ▼ |

Control Screen

The Control screen (shown below) is used to directly control the drive. It displays vertical bar graphs of the drive’s speed Reference and Feedback values, and a Key Function Map that corresponds to the navigation/number keys for drive control. Press the  (Controls) key to display the Control screen.



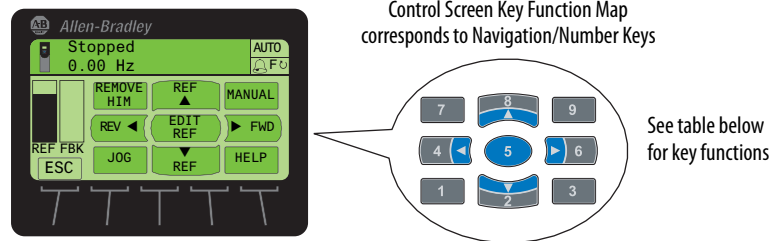





IMPORTANT To navigate from the Control screen to another HIM menu screen, you must always press the ESC *soft key* to deactivate the Control screen and display the previous screen.



Control Screen Soft Key

| Label | Name | Function |
|-------|--------|---|
| ESC | Escape | Deactivates the Control Screen and reverts back to the previous screen. |

Control Screen Navigation/Number Keys

| Label | Key | Function |
|------------|---|--|
| JOG |  | Jogs the host drive. |
| ▼ REF |  | Decreases the speed reference for the host drive. |
| HELP |  | Displays Rockwell Automation Drives Technical Support direct phone number, website address, and email address. |
| REV ◀ |  | Sets the direction to reverse for the host drive. |
| EDIT REF |  | Allows direct data entry of the speed reference for the host drive. |
| ▶ FWD |  | Sets the direction to forward for the host drive. |
| REMOVE HIM |  | Allows HIM removal without causing a fault if the HIM is not the last controlling device. (The REMOVE HIM label is not available when the HIM has manual control of the host drive. In this case, a fault will occur if the HIM is removed.) |
| REF ▲ |  | Increases the speed reference for the host drive. |
| MANUAL |  | Switches between Auto and Manual modes. |

Folder Screens

The drive and each connected peripheral has its own set of Folder screens:

| Folder Screen | Description |
|---------------------------|---|
| PORTS | Displays a list of host drive ports to which peripherals are connected. The host drive is always Port 00. An icon appears for the device occupying the selected port. |
| DEV PARAM | Displays a list of available methods to access the device's parameters. |
| HOST PARAM ⁽¹⁾ | Displays a list of available methods to access the host drive parameters. |
| DIAGNOSTIC | Displays a list of available diagnostic information items for the device. |
| MEMORY | Displays a list of available memory storage items for the device. |
| PROPERTIES | Displays a list of available user-defined convenience functions for the device. |
| START UP | Displays a list of available host drive start-up routines. This folder is not applicable for peripheral devices and is not shown. |

(1) The HOST PARAM folder screen is only available for PowerFlex 750-Series peripherals that support use of Host Drive parameters (for example, the 20-750-DNET DeviceNet network communication option module).

To display the last-viewed Folder screen, press the  (Folders) key. The Folder screen Data Area displays:

- Selected device and port number
- Host drive and peripheral folders



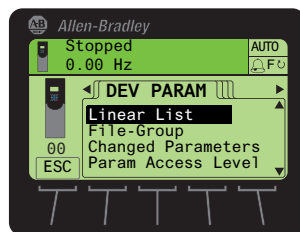

Figure 5 - Example Folder Screen (Device Parameters)



Folder Screen Soft Key

| Label | Name | Function |
|-------|--------|---|
| ESC | Escape | Reverts back to the Status or Process Display screen. |

Folder Screen Navigation/Number Keys

| Key | Name | Function | Screen Element |
|---|---------------|--|----------------|
|  | 2/Down Arrow | Scrolls down through the folder items. | ▼ |
|  | 4/Left Arrow | Scrolls to the previous folder. | ◀ |
|  | 5/Enter | Displays the next level screen for a selected folder item. | Not applicable |
|  | 6/Right Arrow | Scrolls to the next folder. | ▶ |
|  | 8/Up Arrow | Scrolls up through the folder items. | ▲ |

Fault Display Screen

The pop-up Fault Display screen automatically appears when a fault condition is detected for the host drive or any connected peripheral. The pop-up Fault Display screen flashes to alert that a fault condition exists. The Fault Display screen (example shown below) provides the following information:

- Fault Code number
- Fault description
- Elapsed time (in hh:mm:ss format) from fault detection

The flash mode for the Fault Display screen can be changed. For details, see [Setting Display Flashing for Fault Indication on page 40](#).

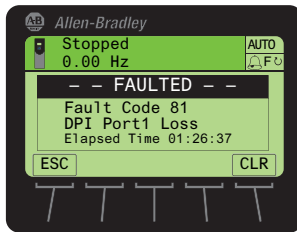

Fault Display Screen Soft Keys

| Label | Name | Function |
|-------|--------|--|
| ESC | Escape | Reverts back to the previous screen without clearing the fault. |
| CLR | Clear | Removes the pop-up Fault Display screen from the display and clears the fault. |

Fault Display Screen Single Function Key

| Key | Name | Function |
|---|------|---|
|  | Stop | Removes the pop-up Fault Display screen from the display, clears the fault, and sends a STOP command to the Host drive. |

Using the HIM

This chapter provides information about using the HIM.

| Topic | Page |
|--|------|
| Initial HIM Operation on New Drive Powerup | 31 |
| Selecting Display Contrast | 32 |
| Setting the Date/Time for PowerFlex 750-Series Drives | 33 |
| Creating a User-Defined Drive/Peripheral Name | 35 |
| Customizing the Process Screen | 36 |
| Resetting the Drive/Peripherals | 38 |
| Setting Factory Defaults | 38 |
| Setting Display Flashing for Fault Indication | 40 |
| Setting Display Flashing for Alarm Indication | 41 |
| Viewing/Editing Drive or Peripheral Parameters | 42 |
| Viewing/Clearing Drive Faults or Alarms | 44 |
| Viewing Peripheral Diagnostic Items | 45 |
| Viewing/Clearing Peripheral Events | 46 |
| Checking Drive and Peripheral Firmware Revisions | 47 |
| Using the CopyCat Function | 48 |
| Changing PowerFlex 750-Series Drive Parameter Associations | 52 |
| Linking Parameters in PowerFlex 700/700S Drives | 55 |
| Using a Password | 57 |
| Initiating PowerFlex 750-Series Drive Port Verification | 60 |
| Changing Language for the Display Text | 62 |
| Updating the HIM Firmware or Language | 63 |

For a list of parameters, see [Appendix B](#), HIM Parameters.

Initial HIM Operation on New Drive Powerup

When powering up a new drive for the first time, the HIM runs through an initial operating routine that does the following:

- Prompts you to select a language.
- Initiates a drive start-up routine.
- Initiates a port verification check (only for PowerFlex 750-Series drives). If a port conflict is detected, see [page 60](#) for information to resolve it.

Selecting Display Contrast

The contrast of the HIM display can be adjusted for optimal viewing. Follow these steps to change the contrast.





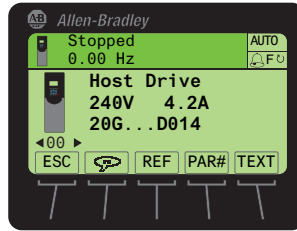



1. Access the Status screen, which is displayed on HIM power up.

Figure 6 - Status Screen



2. Use the  or  key to scroll to the port to which the HIM is connected.









| Port | Location |
|------|--|
| 01 | HIM cradle on the front of the drive. |
| 02 | DPI port near the bottom of the drive control pod (PowerFlex 750-Series drives) or at the bottom of the drive (PowerFlex 7-Class drives). |
| 03 | Splitter cable port when the cable is plugged into the DPI port near the bottom of the drive control pod (PowerFlex 750-Series drives) or at the bottom of the drive (PowerFlex 7-Class drives). |

3. Press the  key to display its last-viewed folder.
4. Use the  or  key to scroll to the PROPERTIES folder.
5. Use the  or  key to select **Adjust Contrast**.
6. Press the  (Enter) key to display the Set LCD Contrast edit pop-up box.
7. Use the  or  *soft key* to adjust contrast to the desired setting.
8. Press the ESC *soft key* to set the contrast and exit the screen.

Setting the Date/Time for PowerFlex 750-Series Drives

IMPORTANT The information in this section does not apply to PowerFlex 7-Class drives.

The PowerFlex 750-Series drive has a real-time clock which supports its time stamp feature for faults and alarms. This clock must be accurately set to provide meaningful time stamp data. Follow these steps to set the date and time.

1. Access the Status screen (see [Figure 6](#)).
2. If Port 00 (host drive) is not shown above the ESC *soft key*, use the  or  key to scroll to Port 00.
3. Press the  key to display its last-viewed folder.
4. Use the  or  key to scroll to the PROPERTIES folder.
5. Use the  or  key to select **Set Date and Time**.
6. Press the  (Enter) key to display the Date/Time Set screen.

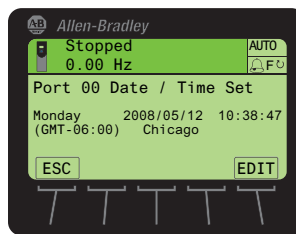





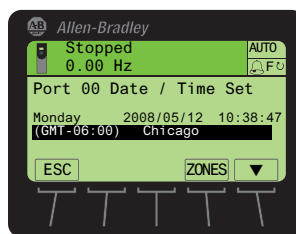

The top line shows the present date and time in this format:

yyyy/mm/dd hh:mm:ss

Note that the time is always displayed in a 24-hour format. For example, 6:00 pm is shown as 18:00:00.

7. Press the EDIT *soft key* to access the Date/Time Set Edit Mode screen, which highlights the present time zone line.







8. To select the time zone:
 - a. Press the ZONES *soft key* to display the Select Time Zone screen.
 - b. Use the  or  key to select your time zone region (for example, Americas).
 - c. Press the  (Enter) key to enter your selection.
 - d. Use the  or  key to select your specific time zone (for example, Chicago).

e. Press the  (Enter) key to enter your selected time zone.



9. To set the date:

- a. Press the  *soft key* to select the year in the top line.
- b. Use the numeric keys to enter the correct year.

TIP To delete an erroneous date (or time) entry, use the  *soft key*. Also, a partial or complete date (or time) value will not update until you press the  *soft key* to advance to another field or press the ESC *soft key* to return to the previous screen.

- c. Press the  *soft key* to select the month in the top line.
- d. Use the numeric keys to enter the correct month.
- e. Press the  *soft key* to select the day in the top line.
- f. Use the numeric keys to enter the correct day.

10. To set the time:



- a. Press the  *soft key* to select the hour in the top line.
- b. Use the numeric keys to enter the correct hour.
- c. Press the  *soft key* to select the minutes in the top line.
- d. Use the numeric keys to enter the correct minute.
- e. Press the  *soft key* to select the seconds in the top line.
- f. Use the numeric keys to enter the correct seconds.

11. Press the ESC *soft key* to return to the previous screen.



Creating a User-Defined Drive/Peripheral Name



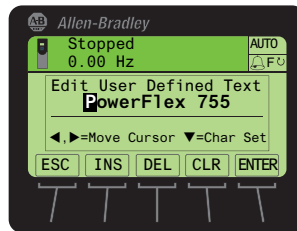

The host drive and each of its connected peripherals has a default name. You can change any of these default names, but each new user-defined name cannot exceed 16 characters in length. Follow these steps to change a default name.

IMPORTANT Text editing is not supported when using Asian language characters. Only characters in the ISO 8859-1 Latin 1 Character Set, which is supported by U.S. and European personal computers, are available. If a software tool is used for text editing Asian characters, the HIM will replace all unsupported characters with a [] (narrow rectangle) mark.

1. Access the Status screen (see [Figure 6](#)).
2. Use the  or  key to scroll to the Port of the device whose name you want to change (for example, Port 00 for the host drive).
3. Press the TEXT *soft key* to display the Edit User Defined Text pop-up box.



4. Use the  or  key to move the cursor to the desired character position in the displayed name.
5. Press the  key to access the last-viewed character set.
6. Press the appropriate numeric key to access the desired character set.

| Numeric Key | Function |
|---|--|
|  | Selects the numeric character set. |
|  | Selects the symbols character set. |
|  | Selects the upper case letter character set. |
|  | Selects the lower case letter character set. |

Also, use the appropriate *soft keys* to help create the new name.

| Soft Key | Function |
|----------|---|
| DEL | Deletes a highlighted character. |
| INS | Inserts a space to the left of a highlighted character. |
| CLR | Deletes an entire text string. |

7. With the desired character selected in that character position, press the  key to select and enter the character.
8. Repeat steps 4 through 7 for each character position.
9. When the desired name is displayed on the edit pop-up box, press the ENTER *soft key* to enter and save the new name.

Customizing the Process Screen

The Process screen can be displayed as a multi-line or single-line view screen, and can be customized to show different drive monitoring items, apply a scale factor, or change text for the displayed drive parameter. These modifications are described in their respective subsections that follow.

Selecting Multi-Line or Single-Line View

By default, the Process screen shows a multi-line view of these drive monitoring items.

| Drive Monitoring Item | | Host PowerFlex Drive | |
|-----------------------|----------------|----------------------|----------------|
| Screen Text | Description | 750-Series | 7-Class |
| Amps | Output Amps | ✓ | ✓ |
| Bus DC | DC Bus Volts | ✓ | ✓ |
| Out Vlts | Output Volts | ✓ | not applicable |
| Out Pwr | Output Power | ✓ | |
| Elp kWhr | Elapsed kWhr | ✓ | |
| Trq Cur | Torque Current | ✓ | |

Figure 7 - Multi-Line View Process Screen

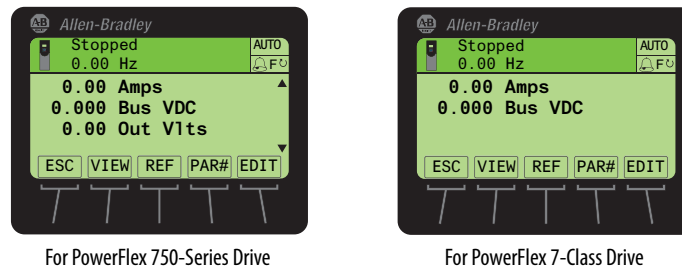

For PowerFlex 750-Series Drive

For PowerFlex 7-Class Drive

1. Press the ESC *soft key* until the Process screen appears.
2. For PowerFlex 750-Series drives only, use the or key to scroll to the hidden line items on the multi-line view screen.
3. To change the multi-line view Process screen to show each of the drive monitoring items in a larger single-line view, press the VIEW *soft key*.
4. Use the or key to scroll to each single-line view Process screen.

Figure 8 - Single-Line View Process Screen Examples

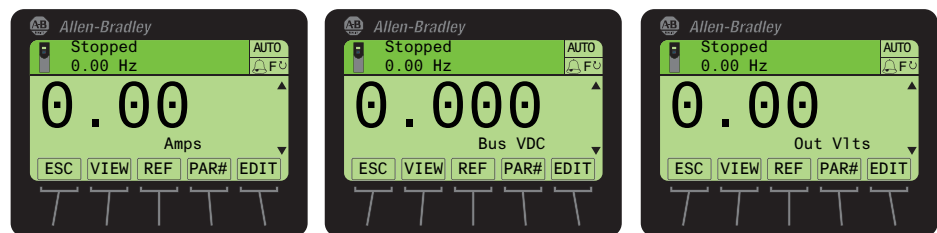



5. To return to the multi-line view Process screen, press the VIEW *soft key* again.

Changing Displayed Items, Adding a Scale Factor, or Customizing Text

You can further customize the Process screen by:

- Changing a displayed parameter to a different parameter.
- Applying a scale factor to the displayed parameter.
- Customizing text for the displayed parameter.

To do any or all of the above modifications, follow these steps.

1. With either the multi-line view Process screen (Figure 7) or the single-line view Process screen (Figure 8) displayed, use the  or  key to select the drive monitoring item you want to change.
2. Press the EDIT *soft key*.

For example, suppose you want to change the first drive monitoring item. In this case, the Process Display 1 Edit screen is shown.

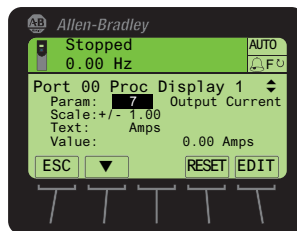

3. Use the  *soft key* to select what you want to change (parameter, scale, or text) for the drive monitoring item.
4. Press the EDIT *soft key* to display its respective edit pop-up box (see examples below).

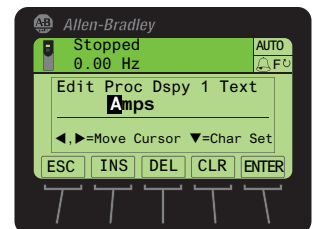
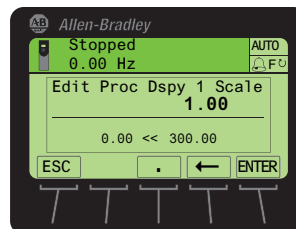
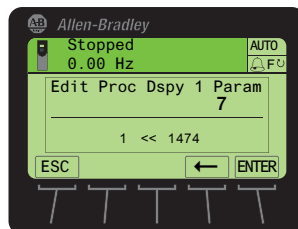









5. For parameter or scale editing, use the numeric keys and available *soft keys*, and press the ENTER *soft key* to enter and save the item.

For text editing, use the numeric keys, available *soft keys*, and the  key to enter each character. Then press the ENTER *soft key* to enter and save the complete text string.

Resetting the Drive/ Peripherals









The drive or any of its connected peripherals can be reset by removing and restoring power to the drive (power cycling). If this is not convenient or cannot be done because of application circumstances, the HIM can be used to reset the drive/peripherals. Follow these steps to reset the drive or any of its peripherals.

1. Access the Status screen (see [Figure 6](#)).
2. Use the  or  key to scroll to the Port of the device you want to reset (for example, Port 00 for the host drive).
3. Press the  key to display its last-viewed folder.
4. Use the  or  key to scroll to the DIAGNOSTIC folder.
5. Use the  or  key to select **Reset Device**.
6. Press the  (Enter) key to display a pop-up box asking if you want to reset the device.
7. Press the ENTER *soft key* to affirm and reset the device, or press the ESC *soft key* to cancel.

Setting Factory Defaults

The procedure to set a PowerFlex 750-Series drive and its connected peripherals to factory defaults is slightly different than the procedure used for a PowerFlex 7-Class drive and its peripherals. See the respective subsection for instructions.

Setting PowerFlex 750-Series Drives/Peripherals to Factory Defaults

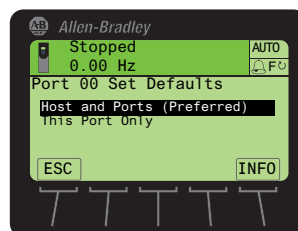

1. Access the Status screen (see [Figure 6](#)).
2. Use the  or  key to scroll to the Port of the device whose parameters you want to set to factory defaults (for example, Port 00 for the host drive or the respective port number for one of the drive's connected peripherals).
3. Press the  key to display its last-viewed folder.
4. Use the  or  key to scroll to the MEMORY folder.
5. Use the  or  key to select **Set Defaults**.
6. Press the  (Enter) key to display the Set Defaults pop-up box (see examples below).

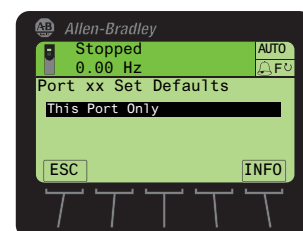

For Host Drive



For Connected Peripheral

7. Use the  or  key to select the appropriate action.
 - **Host and Ports (Preferred):** Selects the host device and all ports for a factory default action.
 - **This Port Only:** Selects only this port for a factory default action.

TIP For a description of a selected menu item, press the INFO *soft key*.

8. Press the  (Enter) key to display the warning pop-up box to reset defaults.

Figure 9 - 'Host and Ports (Preferred)' Pop-Up Box







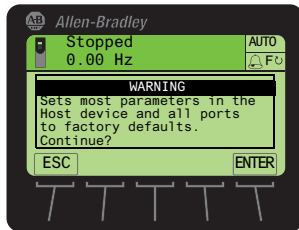
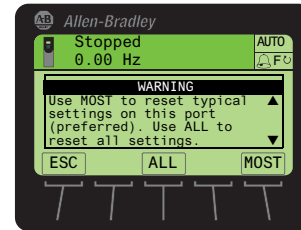



Press the ENTER *soft key* to affirm and set most parameters for the host drive and port devices to factory defaults. In this case, see the host drive and port device documentation for the settings that will **not** be restored—or press the ESC *soft key* to cancel.

Figure 10 - 'This Port Only' Pop-Up Box



Press the MOST *soft key* to set **most** settings for the selected port device to factory defaults. In this case, see the host drive documentation for the settings that will **not** be restored. Press the ALL *soft key* to set **all** settings for the selected port device to factory defaults—or press the ESC *soft key* to cancel.

Setting PowerFlex 7-Class Drives/Peripherals to Factory Defaults

1. Access the Status screen (see [Figure 6](#)).
2. Use the  or  key to scroll to the Port of the device whose parameters you want to set to factory defaults (for example, Port 00 for the host drive or the respective port number for one of the drive's connected peripherals).
3. Press the  key to display its last-viewed folder.
4. Use the  or  key to scroll to the MEMORY folder.
5. Use the  or  key to select **Set Defaults**.
6. Press the  (Enter) key to display the Set Defaults pop-up box.

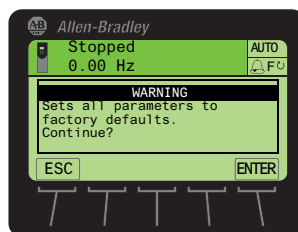

7. Press the ENTER *soft key* to affirm and set all device parameter values to factory defaults—or press the ESC *soft key* to cancel.

Setting Display Flashing for Fault Indication

Whenever a fault for the host drive or any of its connected peripherals is detected, a pop-up Fault Display screen (see [page 30](#)) appears. By default, only the Status Bar flashes to alert the operator. However, you can change the flash mode for the Fault Display screen to one of the following modes:

- Flash Bklite; selects the entire LCD screen to flash.
- Flash Status (default); selects only the Status Bar (item 1, [Figure 3](#)) to flash.
- Flash None; selects no flashing for the Fault Display screen.

Follow these steps to change the flash mode for the Fault Display screen.

1. Access HIM **Parameter 04 - [Fault Dspy Type]** using either the Direct Parameter Access method ([page 42](#)) or Alternate Linear List method ([page 43](#)).
2. Press the EDIT *soft key* to display the Edit Fault Dspy Type pop-up box.

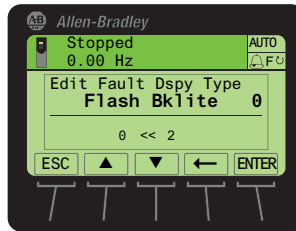

3. Use the ▲ and ▼ *soft keys* to select the desired flash mode. To delete an erroneous entry, use the ← *soft key*.
4. Press the ENTER *soft key* to enter your selection and return to the parameter screen.

Setting Display Flashing for Alarm Indication

Whenever an alarm for the Host Drive is detected, an alarm bell icon appears in the Status Bar. By default, only the Status Bar flashes to alert the operator. However, you can change the flash mode for alarm indication to one of the following modes:

- Flash Bklite; selects the entire LCD screen to flash.
- Flash Status (default); selects only the Status Bar (item 1, [Figure 3](#)) to flash.
- Flash None; selects no flashing for alarm indication.

Follow these steps to change the flash mode for alarm indication.

1. Access HIM **Parameter 05 - [Alarm Dspy Type]** using either the Direct Parameter Access method ([page 42](#)) or Alternate Linear List method ([page 43](#)).
2. Press the EDIT *soft key* to display the Edit Alarm Dspy Type pop-up box.

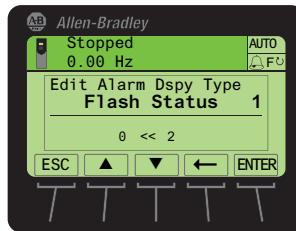

3. Use the ▲ and ▼ *soft keys* to select the desired flash mode.
To delete an incorrect entry, use the ← *soft key*.
4. Press the ENTER *soft key* to enter your selection and return to the parameter screen.









Viewing/Editing Drive or Peripheral Parameters

The PowerFlex 20-HIM-A6 or 20-HIM-C6S HIM can show host drive parameters in a File-Group-Parameter view or by Linear List. To access drive or peripheral parameters for viewing or editing, use either the direct parameter access method or the alternate linear list access method. See the respective subsections that follow for instructions.



Selecting File-Group-Parameter or Linear List View

TIP Not all peripheral devices support viewing parameters in a File-Group-Parameter view.



Follow these steps to change viewing between File-Group-Parameter and Linear List.



1. Access the Status screen (see [Figure 6](#)).
2. Use the  or  key to scroll to the Port of the device whose parameters you want to access (for example, Port 00 for the host drive).
3. Press the  key to display its last-viewed folder.
4. Use the  or  key to scroll to the DEV PARAM or HOST PARAM folder.
5. Use the  or  key to select **Linear List** or **File-Group**.
6. Press the  (Enter) key to display the last-viewed or first parameter in the Linear List, or the last-viewed or first parameter in the first Group.

Direct Parameter Access Method

1. Access the Status screen (see [Figure 6](#)).
2. Use the  or  key to scroll to the Port of the device whose parameters you want to access (for example, Port 00 for the host drive).
3. Press the PAR# *soft key* to display the Jump to Param # entry pop-up box.

TIP Some devices have two sets of parameters (Device and Host parameters). In this case, a pop-up box will appear enabling you to first choose the parameter set in which the parameter that you want to access resides.

4. Use the numeric keys to enter the desired parameter number, or use the  or  *soft key* to scroll to the desired parameter number.

TIP Pressing and holding the  or  *soft key* for 1 second or longer provides continuous scrolling until you release the key.

5. Press the ENTER *soft key* to display the parameter.

- Press the EDIT *soft key* (for editable parameters only) to display the Edit Parameter pop-up box.

Figure 11 - Example Edit Parameter Pop-Up Box

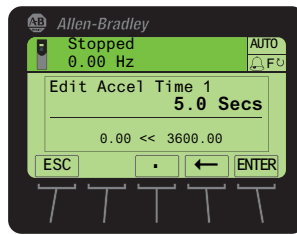











- Use the numeric keys, decimal *soft key*, and ← *soft key* to edit the parameter.

TIP When the decimal *soft key* is pressed while editing a numeric value, this key temporarily changes to an EXP *soft key* to allow exponential entry.

- Press the ENTER *soft key* to enter the new parameter value and return to the parameter screen.

Alternate Linear List Access Method









- Access the Status screen (see [Figure 6](#)).
- Use the  or  key to scroll to the Port of the device whose parameters you want to access (for example, Port 00 for the host drive).
- Press the  key to display its last-viewed folder.
- Use the  or  key to scroll to the PARAMETER folder.
- Use the  or  key to select **Linear List**.
- Press the  (Enter) key to display either the device's last-viewed parameter or the first parameter in the linear list.
- Use the  or  key to scroll to the desired parameter.
- Press the EDIT *soft key* (for editable parameters only) to display the Edit Parameter pop-up box ([Figure 11](#)).
- Use the numeric keys, decimal *soft key*, and ← *soft key* to edit the parameter.

TIP When the decimal *soft key* is pressed while editing a numeric value, this key temporarily changes to an EXP *soft key* to allow exponential entry.

- Press the ENTER *soft key* to enter the new parameter value and return to the parameter screen.



Viewing/Clearing Drive Faults or Alarms

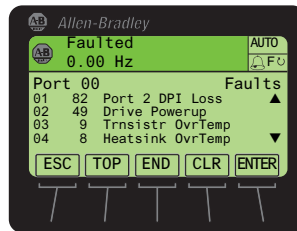

Follow these steps to view/clear drive faults or alarms.

1. Access the Status screen (see [Figure 6](#)).
2. If Port 00 (host drive) is not shown above the ESC *soft key*, use the  or  key to scroll to Port 00.
3. Press the  key to display its last-viewed folder.
4. Use the  or  key to scroll to the DIAGNOSTIC folder.
5. Use the  or  key to select **Faults** or **Alarms**.
6. Press the  (Enter) key to display the numbered fault/alarm queue.







Faults/alarms are listed from the most recent to occur (line 01) to the least recent. The fault/alarm number and name are shown at the right.

7. Use the  or  key or the following *soft keys* to navigate within the fault/alarm queue.









| Soft Key | Function |
|----------|--|
| ENTER | Displays the Time Stamp pop-up box for the fault/alarm. Note that the real-time clock in a PowerFlex 750-Series drive must be accurately set to provide meaningful time stamp data. For details, see Setting the Date/Time for PowerFlex 750-Series Drives on page 33 . Use the  or  key to scroll to all parameters related to the displayed fault/alarm (if supported by device). |
| TOP | Displays the first (most recent) fault/alarm in the queue. |
| END | Displays the last (least recent) fault/alarm in the queue. |

8. To clear faults/alarms, press the CLR *soft key*.

In the Select Action pop-up box, select the appropriate action using the  or  key and press the  (Enter) key to clear the active fault/alarm or clear the fault/alarm queue. To cancel the pop-up box, press the ESC *soft key* or select **Cancel** from the list and press the  (Enter) key.

Viewing Peripheral Diagnostic Items

If you encounter unexpected communication problems, diagnostic items for the drive's connected peripherals—including the HIM—can help you or Rockwell Automation personnel troubleshoot the problem. Follow these steps to view peripheral diagnostic items.

1. Access the Status screen (see [Figure 6](#)).
2. Use the  or  key to scroll to the Port of the device whose diagnostic items you want to view (for example, Port 02 for the connected HIM).
3. Press the  key to display its last-viewed folder.
4. Use the  or  key to scroll to the DIAGNOSTIC folder.
5. Use the  or  key to select **Diagnostic Items**.
6. Press the  (Enter) key to display either the device's last-viewed diagnostic item or the first diagnostic item in the list.









[Table 1](#) shows all possible Diagnostic Items for the HIM. To view the HIM Diagnostic Items, use the procedure described above.

Table 1 - 20-HIM-A6 and 20-HIM-C6S HIM Diagnostic Items

| No. | Name | Description |
|-----|------------------|--|
| 1 | LCD Contrast | The present value of the HIM LCD contrast level, and ability to set the contrast level from this screen. |
| 2 | Common Logic Cmd | The present value of the Common Logic Command being transmitted to the drive by the HIM. |
| 3 | Prod Logic Cmd | The present value of the Product Specific Logic Command being transmitted to the drive by the HIM. |
| 4 | Common Logic Sts | The present value of the Common Logic Status being received from the drive by the HIM. |
| 5 | Prod Logic Sts | The present value of the Product Specific Logic Status being received from the drive by the HIM. |
| 6 | Reference | The present value of the Product Specific Reference being transmitted to the drive by the HIM. |
| 7 | Feedback | The present value of the Product Specific Feedback being received from the drive by the HIM. |
| 8 | Boot Flash Count | The present value of the Boot Flash Counter. |
| 9 | App Flash Count | The present value of the App Flash Counter. |



Viewing/Clearing Peripheral Events

Events for the host drive's connected peripherals—including the HIM—are logged into their respective event queues. Many events in an event queue occur under normal operation. If you encounter unexpected problems, the events may help you or Allen-Bradley personnel troubleshoot the problem. Follow these steps to view or clear the events of a connected peripheral.

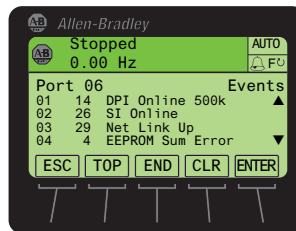
1. Access the Status screen (see [Figure 6](#)).
2. Use the  or  key to scroll to the Port of the device whose events you want to view (for example, Port 06 for a network communication option module).
3. Press the  key to display its last-viewed folder.
4. Use the  or  key to scroll to the DIAGNOSTIC folder.
5. Use the  or  key to select **Events**.
6. Press the  (Enter) key to display the device's numbered event queue.







Events are listed from the most recent to occur (line 01) to the least recent. The event number and name are shown at the right.

7. Use the  or  key or the following *soft keys* to navigate within the event queue.

| Soft Key | Function |
|----------|---|
| ENTER | Displays the Time Stamp pop-up box for the event. Note that the real-time clock in a PowerFlex 750-Series drive must be accurately set to provide meaningful time stamp data. For details, see Setting the Date/Time for PowerFlex 750-Series Drives on page 33 . |
| TOP | Displays the first (most recent) event in the queue. |
| END | Displays the last (least recent) event in the queue. |

8. To clear events, press the CLR *soft key*.

In the Select Action pop-up box, select the appropriate action using the  or  key and press the  (Enter) key to clear the event or clear event queue. To cancel the pop-up box, press the ESC *soft key* or select **Cancel** from the list and press the  (Enter) key.









The PowerFlex 20-HIM-A6 or 20-HIM-C6S HIM maintains an event queue that reports the history of its actions. [Table 2](#) shows all possible events for the HIM. To view the HIM events, use the procedure described above.

Table 2 - 20-HIM-A6 and 20-HIM-C6S HIM Events

| Code | Event | Description |
|-------|------------------|---|
| 1 | Reserved | — |
| 2 | Device Power Up | A normal power up. |
| 3 | Device Reset | The HIM was reset due to a manual reset command or program crash. |
| 4 | EEPROM CRC Error | The HIM EEPROM Data Storage Device is corrupt. |
| 5 | App Updated | The HIM application firmware has been updated. |
| 6 | Boot Updated | The HIM boot firmware has been updated. |
| 7 | Watchdog Timeout | A program crash has occurred. |
| 8 | DPI Bus Off | A DPI Bus Off fault was detected. |
| 9 | DPI Ping Timeout | A DPI Ping Timeout fault was detected. |
| 10 | DPI Port Invalid | A DPI Port ID fault was detected. |
| 11 | DPI Port Changed | A DPI Port Changed fault was detected. |
| 12 | DPI Host Reset | The host has sent a reset message. |
| 13 | DPI Baud 125K | The DPI data rate is detected at 125K bits/second. |
| 14 | DPI Baud 500K | The DPI data rate is detected at 500K bits/second. |
| 15 | DPI Host Invalid | The HIM will not connect to this type of host. |
| 16 | DPI Dup Port | Another DPI device is already connected to this port. |
| 17 | DPI Type 0 Logon | The DPI log on was completed successfully. |
| 18 | DPI Type 0 Time | A DPI Type 0 Command has timed out. |
| 19-23 | Reserved | — |
| 24 | DPI Msg Timeout | A message to a DPI device has timed out. |
| 25 | DPI Manual Reset | A reset command was sent through a fault object. |

Checking Drive and Peripheral Firmware Revisions

Follow these steps to check the firmware revision of the drive or its peripherals.

1. Access the Status screen (see [Figure 6](#)).
2. Use the  or  key to scroll to the Port of the device whose firmware version you want to view (for example, Port 00 for the host drive).
3. Press the  key to display its last-viewed folder.
4. Use the  or  key to scroll to the DIAGNOSTIC folder.
5. Use the  or  key to select **Device Version**.
6. Press the  (Enter) key to display device version information.

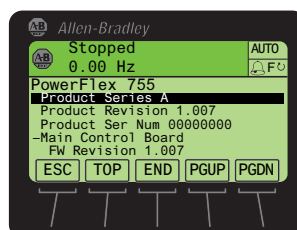

Using the CopyCat Function

PowerFlex 750-Series drives and PowerFlex 7-Class drives provide a CopyCat function that enables you to upload individual parameter sets for the host drive or any of its connected peripherals into the HIM. Furthermore, an Upload All Ports function enables you to conveniently upload multiple parameter sets for the host drive **and** all of its connected peripherals in one single file. In either case, this information can then be used as backup or can be transferred to another drive or peripheral device by downloading the file from the HIM's memory.

TIP The Upload All Ports and Download All Ports functions are only available for the host drive (Port 00) due to their unique functionality.

The CopyCat function also enables you to rename or delete individual or multiple parameter sets stored in the HIM.

The HIM can store up to 50 individual parameter sets or up to 5 multiple parameter sets. Due to the memory capacity of the HIM, these maximums will vary when storing combinations of individual and multiple parameter sets.







Generally, the upload or download transfer process manages all conflicts. However, the download will stop and a text message will appear if any of the following conditions exist:

- A device mismatch, such as firmware revision, device type, or device series is detected.
- The drive is password protected.
- The drive is running.

You then have the option to completely stop the download or continue after noting the discrepancy for the parameters that could not be downloaded. These parameters can then be manually adjusted.

IMPORTANT When using the HIM with a PowerFlex 753 drive with firmware revision 1.05 or earlier, or a PowerFlex 755 drive with firmware revision 1.10 or earlier, the CopyCat function cannot upload/download DeviceLogix values for DLX Out xx and DLX In xx parameters and DeviceLogix program routines. Drives with a later firmware revision support this function, but the HIM does **not** support screen formatting for the DeviceLogix program.



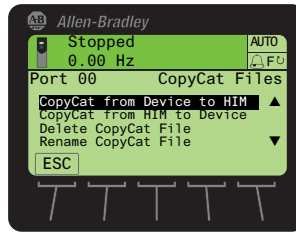

Creating CopyCat Files

1. Access the Status screen (see [Figure 6](#)).
2. Use the  or  key to scroll to the Port of the device whose parameter set you want to copy (for example, Port 00 for the host drive).
3. Press the  key to display its last-viewed folder.
4. Use the  or  key to scroll to the MEMORY folder.
5. Use the  or  key to select **HIM CopyCat**.

6. Press the  (Enter) key to display the CopyCat Files selection screen.



TIP Before any CopyCat files are created, only the 'CopyCat From Device to HIM' menu item is shown. When Port 00 for the Host Drive is selected in Step 2, the 'Upload All Ports' menu item also appears.







7. Use the  or  key to select the appropriate action and press the  (Enter) key to initiate that action.
8. With New File selected on the Select Upload File screen, press the  (Enter) key to create the file. A pop-up box will appear to confirm that the CopyCat file was successfully created. Press the ENTER *soft key* to complete the procedure.

TIP When a CopyCat file is created, its default file name corresponds to the device whose file is being copied. For example, a newly created CopyCat file for a PowerFlex 755 drive has a default file name of 'PowerFlex 755'.

When selecting an item row that is an existing CopyCat file—not a 'New File' row—to create a new CopyCat file, an Overwrite pop-up box will appear. Press the ENTER *soft key* to affirm and overwrite the existing CopyCat file—or press the ESC *soft key* to cancel.





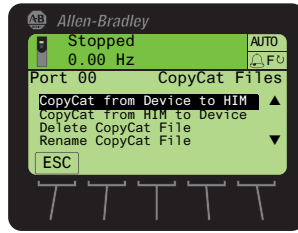

Renaming CopyCat Files

IMPORTANT Text editing is not supported when using Asian language characters. Only characters in the ISO 8859-1 Latin 1 Character Set, which is supported by U.S. and European personal computers, are available. If a software tool is used for text editing Asian characters, the HIM will replace all unsupported characters with a [] (narrow rectangle) mark.



1. Access the Status screen (see [Figure 6](#)).
2. Use the  or  key to scroll to the Port of the device whose CopyCat file you want to rename (for example, Port 00 for the host drive).
3. Press the  key to display its last-viewed folder.
4. Use the  or  key to scroll to the MEMORY folder.
5. Use the  or  key to select **HIM CopyCat**.



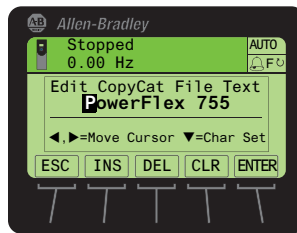

- Press the  (Enter) key to display the CopyCat Files selection screen.



- Use the  or  key to select **Rename CopyCat File**.
- Press the  (Enter) key to display the Select File To Rename pop-up box.
- Use the  or  key to select the file to be renamed.
- Press the  (Enter) key to display the Edit CopyCat File Text pop-up box.



- Use the  or  key to move the cursor to the desired character position in the displayed name.
- Press the  key to access the last-viewed character set.
- Press the appropriate numeric key to access the desired character set.









| Numeric Key | Function |
|---|--|
|  | Selects the numeric character set. |
|  | Selects the symbols character set. |
|  | Selects the upper case letter character set. |
|  | Selects the lower case letter character set. |

Also, use the appropriate *soft keys* to help create the new name.



| Soft Key | Function |
|----------|---|
| DEL | Deletes a highlighted character. |
| INS | Inserts a space to the left of a highlighted character. |
| CLR | Deletes an entire text string. |

- With the desired character selected in that character position, press the  key to select and enter the character.
- Repeat steps 11 through 14 for each character position.
- When the desired name is displayed on the edit pop-up box, press the ENTER *soft key* to enter and save the new name.

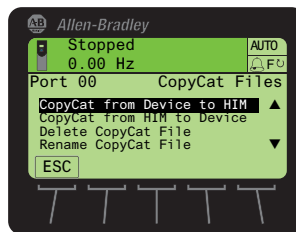

Deleting CopyCat Files

1. Access the Status screen (see [Figure 6](#)).
2. Use the  or  key to scroll to the Port of the device whose parameter set you want to delete (for example, Port 00 for the host drive).
3. Press the  key to display its last-viewed folder.
4. Use the  or  key to scroll to the MEMORY folder.
5. Use the  or  key to select **HIM CopyCat**.
6. Press the  (Enter) key to display the CopyCat Files selection screen.

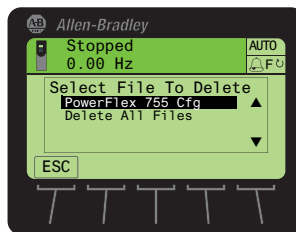

7. Use the  or  key to select **Delete CopyCat File**.
8. Press the  (Enter) key to display the Select File To Delete pop-up box.



9. Use the  or  key to select the file (or all files) to delete.
10. Press the  (Enter) key to display the confirmation pop-up box.
11. Press the ENTER *soft key* to affirm and delete the selected CopyCat file, or press the ESC *soft key* to cancel.

Another pop-up box will appear to confirm that the CopyCat file was successfully deleted.

12. Press the ENTER *soft key* to affirm and complete the procedure.

Changing PowerFlex 750-Series Drive Parameter Associations

PowerFlex 750-Series drives have special parameters (indirect selector parameters and reference parameters) which are always associated with other parameters. The values for these special parameters are actually pointers to other parameters in the drive or to *Host* parameters in connected peripherals. To change a parameter association, first access the indirect selector or reference parameter. Second, select the port number of the device whose parameter you want to target for association. Then, select the target parameter of that device. If the target parameter is a bit parameter, you must also select the appropriate bit you want to associate with the indirect selector or reference parameter.

Parameter associations can be changed using one of these methods:



- Individual Screen Entry Method—where individual pop-up screens are used to enter the required parameter association data.
- Direct Numeric Entry Method—where the required parameter association data is entered as a number string on a single pop-up screen.

The following example illustrates how to use each method to change a parameter association. Suppose you want the drive speed reference to come from the network controller via the embedded EtherNet/IP adapter on the Main Control Board in a PowerFlex 755 drive.

Using Individual Screen Entry Method

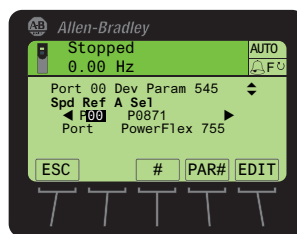
1. Access the indirect selector or reference parameter whose association you want to change (for this example, drive Parameter 545 - [Spd Ref A Sel] as shown below).





In this example, the Port field is shown selected. Use the  or  key to select the Port, Parameter, or Bit (if applicable) fields.

TIP Depending on the indirect selector or reference parameter selected, you may see more available ports in the list.

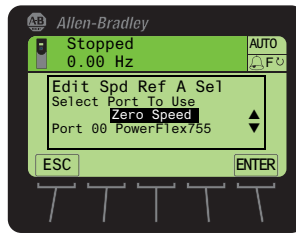
- Press the EDIT *soft key* to display the edit pop-up box for the selected field (in this case, the port number field).





- Use the  or  key to scroll to the port number of the device whose parameter you want to target for the association (for this example, Port 00, where the speed Reference parameters for the available drive ports are located).

TIP The 'Zero Speed' setting may be available to select for specific applications that require a safe-state speed Reference.

- Press the ENTER *soft key* to enter the selected port number.

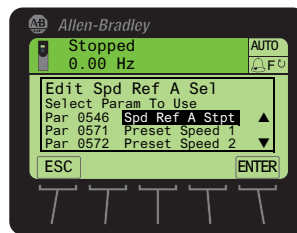
The target parameter selection pop-up box appears (see example screen below), showing a list of available target parameters that can be associated.



- Use the  or  key to scroll to the target parameter you want to associate.



For this example, we selected drive Parameter 877 - [Port 13 Reference]].

- Press the ENTER *soft key* to enter the selected target parameter.

If the target parameter:

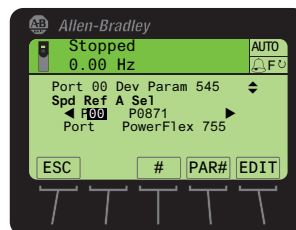
- Is not a bit parameter**, the parameter association is now changed and the indirect selector or reference parameter screen re-appears with the associated parameter information shown.



- Is a bit parameter**, a list of available bit numbers is displayed. Use the  or  key to scroll to the bit number of the target parameter you want to associate, and press the ENTER *soft key*. The parameter

association is now changed and the indirect selector or reference parameter screen re-appears with the associated parameter information shown.

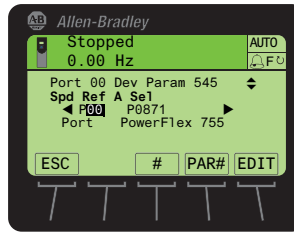

Using Direct Numeric Entry Method

1. Access the indirect selector or reference parameter whose association you want to change (for this example, drive Parameter 545 - [Spd Ref A Sel] as shown below).

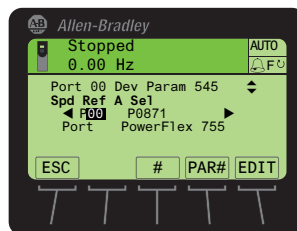

2. With any field (port, parameter, or bit) selected, press the # *soft key* to display the Direct Numeric Entry pop-up box.

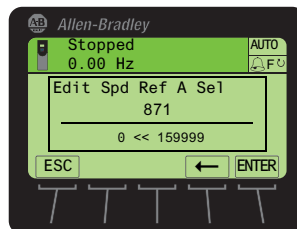

3. Use the numeric keys to enter a number string that represents the target parameter's device port number, parameter number and, only when the target parameter is a bit parameter, its bit number.

The number string format is PPpppp.bb, where:

PP = device port number

pppp = target parameter number

bb = bit number (only used when target parameter is a bit parameter)

4. Press the ENTER *soft key* to enter the number string and complete the parameter association.

The indirect selector or reference parameter screen re-appears with the associated parameter information.

Linking Parameters in PowerFlex 700/700S Drives

Most parameter values are entered directly by the user. However, specific parameters can be 'linked', so the value of one parameter becomes the value of another. For example, the value of an analog input can be linked to an acceleration time. Rather than entering an acceleration time directly (via the HIM), the link allows the value to change by varying the analog input signal. This can provide additional flexibility for advanced applications.

Each link has two components:

- Source parameter—sender of information
- Destination parameter—receiver of information

Most parameters can be a source of data for a link, except parameters that use an integer value representing an ENUM (text selection). These are not allowed, since the integer is not actual data (it represents a value). See the drive documentation for a list of parameters that can be destinations. All links must be established between equal data types (parameter value formatted in floating point can only source data to a destination parameter value that is also a floating point).

Establishing a Link

1. Access a valid destination parameter to be linked (for example, the Accel Time 1 parameter 140 for a PowerFlex 700 drive or parameter 32 for a PowerFlex 700S drive).
2. Press the LINK *soft key* to display the Link pop-up box for that parameter.

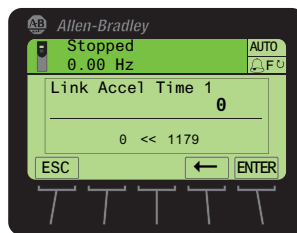

3. Enter the source parameter number (for example, the Analog In1 Value parameter 16 for a PowerFlex 700 drive or parameter 801 for a PowerFlex 700S drive) to which you want to link the destination parameter.
4. Press the ENTER *soft key*.

The destination parameter screen reappears with the respective source parameter value now mapped over the destination parameter range, and is shown in destination parameter units. In this example, the value for Analog Input 1 is 10.000 volts for a PowerFlex 700 drive, and is shown as 10.0 seconds.

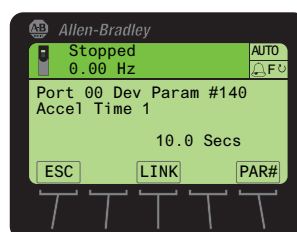

Deleting an Established Link









Follow these steps to delete an established link.

1. Access the screen for the destination parameter.
2. Press the LINK *soft key*.
3. In the Link pop-up box, enter a value of zero.
4. Press the ENTER *soft key* to delete the established link.

Using a Password

All parameter configuration settings for the drive and its connected peripherals can be protected from unauthorized access using a password.

Setting/Changing the Password

1. Access the Status screen (see [Figure 6](#)).
2. If Port 00 (host drive) is not shown above the ESC *soft key*, use the  or  key to scroll to Port 00.
3. Press the  key to display its last-viewed folder.
4. Use the  or  key to scroll to the PROPERTIES folder.
5. Use the  or  key to select **Change Password**.
6. Press the  (Enter) key to display the Enter New Password pop-up box.





7. Use the numeric keys to enter a desired password value.
Use the ← *soft key* to delete an erroneous entry.
For your convenience, write down your assigned password and store it in a safe place.

Password = _____

8. Press the ENTER *soft key* to enter the new password.
9. After the password verification screen appears, confirm the new password by re-entering its value.

Thereafter, the HIM immediately logs in to the drive, which is indicated by the **Log Out** menu line in the PROPERTIES folder. All drive/peripheral parameters are accessible to view or edit.

10. To initiate password protection, do the following:
 - a. Use the  or  key to select **Log Out** from the PROPERTIES folder menu.
 - b. Press the  (Enter) key to display the log out verification pop-up box.
 - c. Press the ENTER *soft key* to affirm and log out—or press the ESC *soft key* to cancel.

Changing Password-protected Drive/Peripheral Parameters









When the host drive is password protected, parameter settings for the drive and its connected peripherals can be viewed—but not changed until after the correct password value is entered.

When attempting to edit a parameter value while logged out, the HIM will prompt you for the password before allowing access.

Password protection also applies to:

- Drive start-up procedure
- Factory defaults
- User sets
- CopyCat function





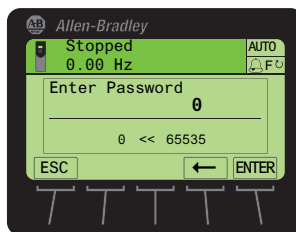



Follow these steps to edit password-protected parameters.

1. Access the Status screen (see [Figure 6](#)).
2. If Port 00 (host drive) is not shown above the ESC *soft key*, use the  or  key to scroll to Port 00.
3. Press the  key to display its last-viewed folder.
4. Use the  or  key to scroll to the PROPERTIES folder.
5. Use the  or  key to select **Log In**.
6. Press the  (Enter) key to display the Enter Password pop-up box.







7. Use the numeric keys to enter the existing password value.
Use the ← *soft key* to delete an erroneous entry.
8. Press the ENTER *soft key* to enter the existing password.
Thereafter, any parameter setting can be changed.

Disabling Password Protection

1. Access the Status screen (see [Figure 6](#)).
2. If Port 00 (host drive) is not shown above the ESC *soft key*, use the  or  key to scroll to Port 00.
3. Press the  key to display its last-viewed folder.
4. Use the  or  key to scroll to the PROPERTIES folder.
5. Use the  or  key to select **Log In**.
6. Press the  (Enter) key to display the Enter Password pop-up box.



7. Use the numeric keys to enter the existing password value.
Use the  *soft key* to delete an erroneous entry.
8. Press the ENTER *soft key* to enter the existing password.
9. Use the  or  key to select **Change Password**.
10. Press the  (Enter) key to display the Enter New Password pop-up box.

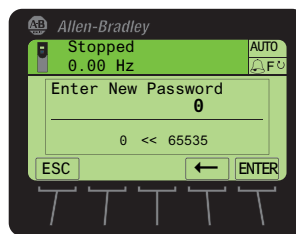

11. Use the numeric keys and the  *soft key* to enter '0', the default value to disable the password protection feature.
12. Press the ENTER *soft key* to enter the '0' (disable) default value.
13. After the password protection verification pop-up box appears, confirm the new password by re-entering '0'.
14. Press the ENTER soft key to disable password protection.

Initiating PowerFlex 750-Series Drive Port Verification

IMPORTANT The information in this section does not apply to PowerFlex 7-Class drives.

Upon powerup, the HIM verifies that the PowerFlex 750-Series drive has initiated Port Verification. The host drive then checks for port conflicts. If any conflicts are present, a Device Conflicts pop-up box appears listing all devices with conflicts.

Conflict Types

If the conflict can be resolved, a ‘!’ symbol precedes the port number. If the conflict cannot be resolved without removing or replacing the device, an ‘X’ symbol precedes the port number. There are five possible conflict types.

| Symbol | Conflict Type |
|--------|------------------------|
| ! | Changed |
| ! | Requires Configuration |
| X | Not Functioning |
| X | Not Supported |
| X | Invalid Duplicate |

In the Device Conflicts pop-up box, scroll up or down to highlight/select an individual device row and press the INFO *soft key*. Another pop-up box appears for the selected device showing the type of conflict and related information.

If information is available for the device that previously occupied that port, it will also be shown.

Use the FIX *soft key*—displayed only if all conflict types are ‘Changed’ or ‘Requires Configuration’—to resolve conflicts. After pressing the FIX *soft key*, a pop-up box will appear asking to confirm that the new device(s) should be accepted. Press the ENTER *soft key* to affirm and resolve the conflicts for all devices. Thereafter, the HIM will re-read the drive Port Verification information to ensure that no further conflicts exist.

IMPORTANT Please note the following important conflict resolution information:

- The Device Conflict pop-up window remains on the screen until all conflicts are resolved.
- All conflicts must be resolved to access a Folder screen or Control screen. Only the  (Stop) key and the assigned *soft keys* (INFO and FIX) will be functional until no conflicts exist.
- The host drive will not be able to run while any conflicts are present.

Resolving 'Changed' or 'Requires Configuration' Conflicts

When a 'Changed' or 'Requires Configuration' conflict exists on powerup, a '!' symbol precedes the port number in the Device Conflicts pop-up box.

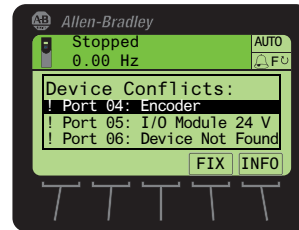

1. Select a port device (in this example, the Encoder card) and press either the INFO *soft key* to show additional information about the conflict, or press the FIX *soft key* to resolve all device conflicts.

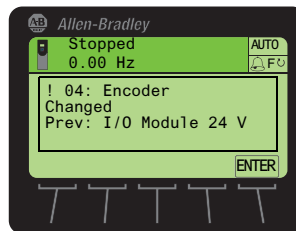

Example screen when the INFO *soft key* is pressed.

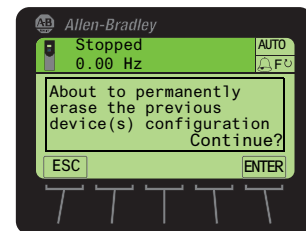

Example screen when the FIX *soft key* is pressed.

2. Press the ENTER *soft key* to affirm and re-display the Device Conflicts pop-up box.

Press the ENTER *soft key* to affirm and resolve all device conflicts, or press the ESC *soft key* to cancel.

Resolving 'Not Functioning', 'Not Supported', or 'Invalid Duplicate' Conflicts

When a 'Not Functioning', 'Not Supported', or 'Invalid Duplicate' conflict exists on powerup, an 'X' symbol precedes the port number in the Device Conflicts pop-up box.

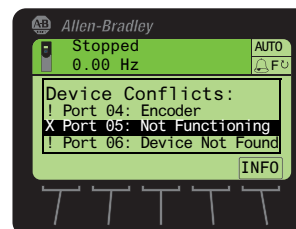

1. Select the port preceded with an 'X' (in this example, Port 05) and press the INFO *soft key* to show additional information about the conflict (see example below).

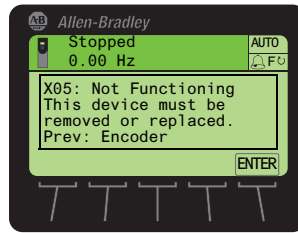

2. Follow the screen prompts to resolve the port conflict.





Or press the ENTER *soft key* to affirm and re-display the Device Conflicts pop-up box.

Changing Language for the Display Text

All HIM screen text can be displayed in one of the supported languages. The default language is English.

TIP If the drive is set to a language not supported by the HIM, a pop-up box appears asking you to select another language.

Follow these steps to select another supported language.

1. Access the Status screen (see [Figure 6](#)).
2. Press the  (Language) *soft key* to display the list of available languages.
3. Use the  or  key to select the desired language.
4. Press the  (Enter) key to enter the selected language.

All HIM screen text now appears in the selected language.

Updating the HIM Firmware or Language

The HIM firmware can be updated over the network or serially through a direct connection from the drive to the computer using a 1203-USB or 1203-SSS serial converter.

When updating firmware over the network, you can use the Allen-Bradley ControlFLASH software tool, the built-in update capability of DriveExplorer Lite or Full software, or the built-in update capability of DriveExecutive software.

When updating firmware through a direct serial connection from the drive to the computer, you can use the same Allen-Bradley software tools described above, or you can use HyperTerminal software set to the X-modem protocol.

To obtain a firmware or language update for the HIM, go to <http://www.ab.com/support/abdrives/webupdate>. This website contains all firmware update files, supported language files, and associated Release Notes that describe the following items:

- Firmware update enhancements and anomalies
- How to determine the existing firmware revision
- How to update the firmware using ControlFLASH, DriveExplorer, DriveExecutive, or HyperTerminal software

IMPORTANT When the HIM firmware is updated in the field to support another available language, the language selected for download will **replace** all other supported languages—except English, which always remains as the default language.

Notes:

Specifications

This appendix provides the specifications for the HIM.

| Topic | Page |
|---------------------------------------|------|
| Communications | 65 |
| Electrical | 65 |
| Mechanical | 65 |
| Environmental | 65 |
| Regulatory Compliance | 66 |

Communications

| | |
|------------|----------------------------------|
| Protocol | Drive Peripheral Interface (DPI) |
| Data Rates | 125 kbps or 500 kbps |

Electrical

| | |
|-------------|---|
| Consumption | 140 mA at 12V DC supplied by the Host Drive |
|-------------|---|

Mechanical

| Dimensions | 20-HIM-A6 | 20-HIM-C6S |
|------------|---------------------|---------------------|
| Height | 116.0 mm (4.57 in.) | 180.0 mm (7.08 in.) |
| Width | 70.0 mm (2.75 in.) | 93.0 mm (3.66 in.) |
| Depth | 16.0 mm (0.63 in.) | 25.0 mm (0.98 in.) |
| Weight | 91 g (3.2 oz.) | 173 g (5.7 oz.) |

Environmental

| | |
|-------------------|---|
| Temperature | |
| Operating | 0...50 °C (32...122 °F) |
| Storage | -40...85 °C (-40...185 °F) |
| Relative Humidity | 5...95% non-condensing |
| Atmosphere | Important: The HIM must not be installed in an area where the ambient atmosphere contains volatile or corrosive gas, vapors or dust. If the HIM is not going to be installed for a period of time, it must be stored in an area where it will not be exposed to a corrosive atmosphere. |
| Vibration | |
| Operating | 2.5 g @ 5 Hz...2 kHz |
| Non-Operating | 5 g @ 5 Hz...2 kHz |
| Shock | |
| Operating | 30 g peak acceleration, 11 (±1) ms pulse width |
| Non-Operating | 50 g peak acceleration, 11 (±1) ms pulse width |

Regulatory Compliance

| Certification | Specification |
|---------------|----------------------------|
| UL | UL508C |
| cUL | CAN / CSA C22.2 No. 14-M91 |
| CE | EN50178 and EN61800-3 |
| CTick | EN61800-3 |

NOTE: This is a product of category C2 according to IEC 61800-3. In a domestic environment this product may cause radio interference in which case supplementary mitigation measures may be required.

HIM Parameters

This appendix provides information about the HIM parameters.

Besides the HIM, the following configuration tools can also be used to monitor or change parameter values of the HIM, drive, and other connected peripherals:

- Connected Components Workbench software, version 1.02 or later
- DriveExplorer software, version 6.01 or later
- DriveExecutive software, version 5.01 or later

Parameter List

| Parameter | | | |
|-----------|--|-----------------|--|
| No. | Name and Description | Details | |
| 01 | [Port Number] Displays the port on the drive to which the HIM is connected. | Minimum: | 1 |
| | | Maximum: | 7 |
| | | Type: | Read Only |
| 02 | [DPI Data Rate] Displays the DPI data rate at which the HIM is communicating with the drive. | Values: | 0 = 125 kbps 1 = 500 kbps |
| | | Type: | Read Only |
| 03 | [Initial Screen] Selects the initial HIM screen to be displayed on power up. | Default: | 0 = Status Scrn |
| | | Value: | 0 = Status Scrn 1 = Process Scrn |
| | | Type: | Read/Write |
| | | Reset Required: | Yes |
| 04 | [Fault Dspy Type] Selects the type of display flash to be shown when a drive or peripheral fault is detected. | Default: | 1 = Flash Status |
| | | Values: | 0 = Flash Bklite 1 = Flash Status 2 = Flash None |
| | | Type: | Read/Write |
| | | Reset Required: | No |
| 05 | [Alarm Dspy Type] Selects the type of display flash to be shown when a drive alarm is detected. | Default: | 1 = Flash Status |
| | | Values: | 0 = Flash Bklite 1 = Flash Status 2 = Flash None |
| | | Type: | Read/Write |
| | | Reset Required: | No |
| 06 | [User Dspy Enable] Enables/disables the HIM's automatic user display time function, which is configured using Parameter 07 - [User Dspy Time] . | Default: | 1 = Enable |
| | | Values: | 0 = Disable 1 = Enable |
| | | Type: | Read/Write |
| | | Reset Required: | Yes |
| 07 | [User Dspy Time] Sets the amount of time that a screen will remain displayed as long as the HIM keys are not used. After this time elapses, the screen is automatically replaced by the initial screen, which is selected using Parameter 03 - [Initial Screen] . | Default: | 60 sec |
| | | Minimum: | 10 sec |
| | | Maximum: | 300 sec |
| | | Type: | Read/Write |
| | | Reset Required: | Yes |

Notes:

History of Changes

| Topic | Page |
|---|------|
| 20HIM-UM001C-EN-P, January 2012 | 69 |
| 20HIM-UM001B-EN-P, October 2010 | 70 |
| 20HIM-UM001A-EN-P, January 2009 | 70 |

This appendix summarizes the revisions to this manual. Reference this appendix if you need information to determine what changes have been made across multiple revisions. This may be especially useful if you are deciding to upgrade your hardware or software based on information added with previous revisions of this manual.

20HIM-UM001C-EN-P, January 2012

This table contains the changes, which were the result of HIM firmware revision 2.001.

| Topic |
|--|
| In Chapter 3: |
| <ul style="list-style-type: none"> Added the Status Bar element 'DLX' to indicate that the Host Drive DeviceLogix feature is enabled. Added new <i>soft key</i> labels 'ACK', 'PGDN', and 'PGUP' on the Device Version information screen to enhance navigation. |
| In Chapter 4: |
| <ul style="list-style-type: none"> Changed the Fault Display screen flash mode default from 'Flash Bklite' to 'Flash Status'. Added a TIP statement that holding the ▲ or ▼ soft key while using the Direct Parameter Access method to view/edit a parameter provides continuous scrolling until the key is released. Revised Example Device Version Information Screen to show the added soft key labels 'Top', 'End', 'PGUP', and 'PGDN'. |
| In Appendix B, changed the default for Parameter 04 - [Fault Dspy Type] from '0' (Flash Bklite) to '1' (Flash Status). |

20HIM-UM001B-EN-P, October 2010

Topic

In Chapter 2, added new subsection 'PowerFlex 750-Series IP54, NEMA/UL Type 12 Drives' with instructions to install the HIM.

In Chapter 3:

- In the 'Single Function Keys' subsection, added footnote to the single function keys Folders and Controls explaining that these keys are temporarily inactive during drive Start Up.
- In the 'Soft Key Labels' subsection, added new RESET soft key label to the table.
- In the 'Folder Screens' subsection, added new Param Access Level menu item to the DEV PARAM folder screen.

In Chapter 4:

- In the 'Setting the Date/Time for the Drive (only PowerFlex 750-Series Drives)' subsection, revised the Date/Time and Date/Time Set Edit Mode screens.
 - In the 'Changing Displayed Items, Adding a Scale Factor or Customizing Text' subsection, revised the Process Display 1 screen.
 - In the 'Direct Parameter Access' subsection, revised the Edit Parameter pop-up box, added a TIP to step 7.
 - In the 'Alternate Linear List' subsection, added a TIP to step 9.
 - In the 'Using the CopyCat Function' section, added an Important statement describing the limitations of the CopyCat feature with DeviceLogix functions in PowerFlex 750-Series drives.
 - In the 'Using Individual Screen Entry Method' subsection, revised Port Number Selection and Target Parameter Selection pop-up boxes.
-

20HIM-UM001A-EN-P, January 2009

Topic

This was the first release of this manual.

A

accessing parameters
 alternate linear list method 43
 direct parameter access method 42
adjusting display contrast 32
Alarm Dspy Type parameter 67
alarm/fault queues for the drive 44
attentions 12

C

**changing PowerFlex 750-Series drive
 parameter associations** 52
checking drive/peripheral firmware revisions
 47
clearing
 drive faults/alarms 44
 peripheral events 46
compatible products 12
contrast adjustment for display 32
CopyCat function 48
creating user-defined drive/peripheral name
 35
customizing the Process screen 36

D

**date/time setting for PowerFlex 750-Series
 drives** 33
diagnostic items for 20-HIM-A6/-C6S HIMs 45
dimensions 65
direct parameter access method 42
disabling password protection 59
display contrast adjustment 32
DPI Data Rate parameter 67
DPI data rates 65
drive fault/alarm queues 44
drive/peripheral firmware revisions - viewing
 47

E

events for 20-HIM-A6/-C6S HIMs 47

F

factory defaults 38
Fault Dspy Type parameter 67
fault/alarm queues for the drive 44
features 11
firmware
 revision 9
 update guidelines 63

H

HIM (Human Interface Module)
 adjusting display contrast 32
 changing PowerFlex 750-Series drive
 parameter associations 52
 checking drive/peripheral firmware revisions
 47
 compatible products 12
 CopyCat function 48
 creating user-defined drive/peripheral name
 35
 customizing the Process screen 36
 diagnostic items 45
 events 47
 features 11
 firmware or language updating 63
 installing
 20-HIM-A6 HIM 14
 20-HIM-C6S HIM 18
 keypad key descriptions 21
 LCD display elements/descriptions 24
 linking parameters in PowerFlex 700/700S
 drives 55
 main screens/descriptions 26
 parameter list for HIM 67
 port verification (only PowerFlex 750-Series
 drives) 60
 removing 20
 resetting the drive/peripherals 38
 selecting language for display text 62
 setting date/time for PowerFlex 750-Series
 drives 33
 setting display flashing for
 alarm indication 41
 fault indication 40
 setting factory defaults 38
 specifications 65
 updating HIM firmware or language 63
 using a password 57
 viewing peripheral diagnostic items 45
 viewing/clearing
 drive faults/alarms 44
 peripheral events 46
 viewing/editing drive and peripheral
 parameters 42

I

Initial Screen parameter 67
installing
 20-HIM-A6 HIM 14
 20-HIM-C6S HIM 18

K

keypad key descriptions 21

L

language
 selecting for display text 62
 updating 63

LCD display elements/descriptions 24
linear list access method to parameters 43
linking parameters in PowerFlex 700/700S drives 55

M

main screens/descriptions 26
manual
conventions 9
related documentation 10
website 10

P

parameters
convention 9
list of 67
password protection
changing parameters 58
disabling 59
setting 57
peripheral diagnostic items - viewing 45
Port Number parameter 67
PowerFlex 750-Series drive port verification
60
products compatible with HIM 12

R

regulatory compliance 66
related documentation 10
removing the HIM 20
resetting the drive/peripherals 38
restoring the drive/peripherals to factory defaults 38

S

safety precautions 12
screens (main)/descriptions 26
selecting a language 62
setting
display flashing for alarm indication 41
display flashing for fault indication 40
factory defaults 38
password 57
specifications 65

T

technical support 9
time/date setting for PowerFlex 750-Series drives 33

U

updating HIM firmware or language 63
User Dspy Enable parameter 67
User Dspy Time parameter 67
using the CopyCat function 48

V

verification of ports for PowerFlex 750-Series drives 60
viewing peripheral diagnostic items 45
viewing/clearing
drive faults/alarms 44
peripheral events 46
viewing/editing drive and peripheral parameters 42

W

website for related documentation 10

Rockwell Automation Support

Rockwell Automation provides technical information on the Web to assist you in using its products.

At <http://www.rockwellautomation.com/support/>, you can find technical manuals, a knowledge base of FAQs, technical and application notes, sample code and links to software service packs, and a MySupport feature that you can customize to make the best use of these tools.

For an additional level of technical phone support for installation, configuration, and troubleshooting, we offer TechConnect support programs. For more information, contact your local distributor or Rockwell Automation representative, or visit <http://www.rockwellautomation.com/support/>.

Installation Assistance

If you experience a problem within the first 24 hours of installation, review the information that is contained in this manual. You can contact Customer Support for initial help in getting your product up and running.

| | |
|---------------------------------|--|
| United States or Canada | 1.440.646.3434 |
| Outside United States or Canada | Use the Worldwide Locator at http://www.rockwellautomation.com/support/americas/phone_en.html , or contact your local Rockwell Automation representative. |

New Product Satisfaction Return

Rockwell Automation tests all of its products to ensure that they are fully operational when shipped from the manufacturing facility. However, if your product is not functioning and needs to be returned, follow these procedures.

| | |
|-----------------------|---|
| United States | Contact your distributor. You must provide a Customer Support case number (call the phone number above to obtain one) to your distributor to complete the return process. |
| Outside United States | Please contact your local Rockwell Automation representative for the return procedure. |

Documentation Feedback

Your comments will help us serve your documentation needs better. If you have any suggestions on how to improve this document, complete this form, publication [RA-DU002](#), available at <http://www.rockwellautomation.com/literature/>.

Rockwell Otomasyon Ticaret A.Ş., Kar Plaza İş Merkezi E Blok Kat:6 34752 İçerenköy, İstanbul, Tel: +90 (216) 5698400

www.rockwellautomation.com

Power, Control and Information Solutions Headquarters

Americas: Rockwell Automation, 1201 South Second Street, Milwaukee, WI 53204-2496 USA, Tel: (1) 414.382.2000, Fax: (1) 414.382.4444

Europe/Middle East/Africa: Rockwell Automation NV, Pegasus Park, De Kleetlaan 12a, 1831 Diegem, Belgium, Tel: (32) 2 663 0600, Fax: (32) 2 663 0640

Asia Pacific: Rockwell Automation, Level 14, Core F, Cyberport 3, 100 Cyberport Road, Hong Kong, Tel: (852) 2887 4788, Fax: (852) 2508 1846

Publication 20HIM-UM001D-EN-P - February 2013

Supersedes Publication 20HIM-UM001C-EN-P - January 2012

Copyright © 2013 Rockwell Automation, Inc. All rights reserved. Printed in the U.S.A.