

# Micro800 8-Point Input and 8-Point Output AC Modules

Catalog Numbers 2085-IA8, 2085-IM8, 2085-OA8

<http://www.rockwellautomation.com/literature/>

<p><b>FR</b> Cette publication est disponible en français sous forme électronique (fichier PDF). Pour la télécharger, rendez-vous sur la page Internet indiquée ci-dessus.</p>	<p><b>PT</b> Esta publicação está disponível em português como PDF. Vá ao endereço web que aparece acima para encontrar e fazer download da publicação.</p>
<p><b>IT</b> Questa pubblicazione è disponibile in italiano in formato PDF. Per scaricarla collegarsi al sito Web indicato sopra.</p>	<p><b>ZH</b> 本出版物备有中文PDF格式文件，可从上面的网址找到并下载本出版物。</p>
<p><b>DE</b> Diese Publikation ist als PDF auf Deutsch verfügbar. Gehen Sie auf die oben genannte Web-Adresse, um nach der Publikation zu suchen und sie herunterzuladen.</p>	<p><b>ZC</b> 此發佈為 PDF 檔是在您的語言中可用。請轉到上面找到並下載發佈的 web 位址。</p>
<p><b>ES</b> Esta publicación está disponible en español como PDF. Diríjase a la dirección web indicada arriba para buscar y descarga esta publicación.</p>	<p><b>KO</b> 본 간행물은 한글판 PDF 파일로 준비되어 있습니다. 위에 있는 웹사이트에 가셔서 간행물을 다운로드 하십시오.</p>

## Table of Contents

Topic	Page
Important User Information	2
Additional Resources	5
Overview	5
Module Description	6
Mount the Module	6
Wire the Modules	8
Specifications	9

## Important User Information

Solid state equipment has operational characteristics differing from those of electromechanical equipment. Safety Guidelines for the Application, Installation and Maintenance of Solid State Controls (Publication [SGI-1.1](#) available from your local Rockwell Automation sales office or online at <http://www.rockwellautomation.com/literature/>) describes some important differences between solid state equipment and hard-wired electromechanical devices. Because of this difference, and also because of the wide variety of uses for solid state equipment, all persons responsible for applying this equipment must satisfy themselves that each intended application of this equipment is acceptable.





In no event will Rockwell Automation, Inc. be responsible or liable for indirect or consequential damages resulting from the use or application of this equipment.

The examples and diagrams in this manual are included solely for illustrative purposes. Because of the many variables and requirements associated with any particular installation, Rockwell Automation, Inc. cannot assume responsibility or liability for actual use based on the examples and diagrams.

No patent liability is assumed by Rockwell Automation, Inc. with respect to use of information, circuits, equipment, or software described in this manual.

Reproduction of the contents of this manual, in whole or in part, without written permission of Rockwell Automation, Inc., is prohibited.

Throughout this manual, when necessary, we use notes to make you aware of safety considerations.

	Identifies information about practices or circumstances that can cause an explosion in a hazardous environment, which may lead to personal injury or death, property damage, or economic loss.
	Identifies information about practices or circumstances that can lead to personal injury or death, property damage, or economic loss. Attentions help you identify a hazard, avoid a hazard and recognize the consequences.
	Labels may be on or inside the equipment (for example, drive or motor) to alert people that dangerous voltage may be present.
	Labels may be on or inside the equipment (for example, drive or motor) to alert people that surfaces may reach dangerous temperatures.
<b>IMPORTANT</b>	Identifies information that is critical for successful application and understanding of the product.

## Environment and Enclosure

---



**ATTENTION:** This equipment is intended for use in a Pollution Degree 2 industrial environment, in overvoltage Category II applications (as defined in IEC 60664-1), at altitudes up to 2000 m (6562 ft) without derating. This equipment is considered Group 1, Class A industrial equipment according to IEC/CISPR 11. Without appropriate precautions, there may be difficulties with electromagnetic compatibility in residential and other environments due to conducted and radiated disturbances.

This equipment is supplied as open-type equipment. It must be mounted within an enclosure that is suitably designed for those specific environmental conditions that will be present and appropriately designed to prevent personal injury resulting from accessibility to live parts. The enclosure must have suitable flame-retardant properties to prevent or minimize the spread of flame, complying with a flame spread rating of 5VA or be approved for the application if nonmetallic. The interior of the enclosure must be accessible only by the use of a tool. Subsequent sections of this publication may contain additional information regarding specific enclosure type ratings that are required to comply with certain product safety certifications.

In addition to this publication, see the following:

- Industrial Automation Wiring and Grounding Guidelines, publication [1770-4.1](#), for additional installation requirements.
  - NEMA Standard 250 and IEC 60529, as applicable, for explanations of the degrees of protection provided by enclosures.
- 

## Preventing Electrostatic Discharge

---





**ATTENTION:** This equipment is sensitive to electrostatic discharge, which can cause internal damage and affect normal operation. Follow these guidelines when you handle this equipment:

- Touch a grounded object to discharge potential static.
  - Wear an approved grounding wriststrap.
  - Do not touch connectors or pins on component boards.
  - Do not touch circuit components inside the equipment.
  - Use a static-safe workstation, if available.
  - Store the equipment in appropriate static-safe packaging when not in use.
-

## North American Hazardous Location Approval

The following modules are North American Hazardous Location approved:  
2085-IA8, 2085-IM8, 2085-OA8

The following information applies when operating this equipment in hazardous locations:	Informations sur l'utilisation de cet équipement en environnements dangereux:
<p>Products marked "CL I, DIV 2, GP A, B, C, D" are suitable for use in Class I Division 2 Groups A, B, C, D, Hazardous Locations and nonhazardous locations only. Each product is supplied with markings on the rating nameplate indicating the hazardous location temperature code. When combining products within a system, the most adverse temperature code (lowest "T" number) may be used to help determine the overall temperature code of the system. Combinations of equipment in your system are subject to investigation by the local Authority Having Jurisdiction at the time of installation.</p>	<p>Les produits marqués "CL I, DIV 2, GP A, B, C, D" ne conviennent qu'à une utilisation en environnements de Classe I Division 2 Groupes A, B, C, D dangereux et non dangereux. Chaque produit est livré avec des marquages sur sa plaque d'identification qui indiquent le code de température pour les environnements dangereux. Lorsque plusieurs produits sont combinés dans un système, le code de température le plus défavorable (code de température le plus faible) peut être utilisé pour déterminer le code de température global du système. Les combinaisons d'équipements dans le système sont sujettes à inspection par les autorités locales qualifiées au moment de l'installation.</p>
<div style="display: flex; align-items: center;">  <div> <p><b>WARNING: EXPLOSION HAZARD</b></p> <ul style="list-style-type: none"> <li>Do not disconnect equipment unless power has been removed or the area is known to be nonhazardous.</li> <li>Do not disconnect connections to this equipment unless power has been removed or the area is known to be nonhazardous. Secure any external connections that mate to this equipment by using screws, sliding latches, threaded connectors, or other means provided with this product.</li> <li>Substitution of components may impair suitability for Class I, Division 2.</li> <li>If this product contains batteries, they must only be changed in an area known to be nonhazardous.</li> </ul> </div> </div>	<div style="display: flex; align-items: center;">  <div> <p><b>WARNING: RISQUE D'EXPLOSION</b></p> <ul style="list-style-type: none"> <li>Couper le courant ou s'assurer que l'environnement est classé non dangereux avant de débrancher l'équipement.</li> <li>Couper le courant ou s'assurer que l'environnement est classé non dangereux avant de débrancher les connecteurs. Fixer tous les connecteurs externes reliés à cet équipement à l'aide de vis, loquets coulissants, connecteurs filetés ou autres moyens fournis avec ce produit.</li> <li>La substitution de composants peut rendre cet équipement inadapté à une utilisation en environnement de Classe I, Division 2.</li> <li>S'assurer que l'environnement est classé non dangereux avant de changer les piles.</li> </ul> </div> </div>



**WARNING:** When you connect or disconnect the Removable Terminal Block (RTB) with field side power applied, an electrical arc can occur. This could cause an explosion in hazardous location installations. Be sure that power is removed or the area is nonhazardous before proceeding.

**WARNING:** When used in a Class I, Division 2, hazardous location, this equipment must be mounted in a suitable enclosure with proper wiring method that complies with the governing electrical codes.

**WARNING:** If you connect or disconnect wiring while the field-side power is on, an electrical arc can occur. This could cause an explosion in hazardous location installations. Be sure that power is removed or the area is nonhazardous before proceeding.

**WARNING:** If you insert or remove the module while backplane power is on, an electrical arc can occur. This could cause an explosion in hazardous location installations. Be sure that power is removed before proceeding.

**WARNING:** Do not unscrew the RTB hold down screws and remove the RTB while power is on. This could cause an explosion in hazardous location installations. Be sure that power is removed before proceeding.

## Additional Resources

Resource	Description
Micro830 and Micro850 Programmable Controller User Manual, publication <a href="#">2080-UM002</a>	A detailed description of how to install and use a Micro850 Programmable Controller.
Micro 800 Bus Terminator Installation Instructions, publication <a href="#">2085-IN002</a>	Information on installing the bus terminator module.
Industrial Automation Wiring and Grounding Guidelines, publication <a href="#">1770-4.1</a>	More information on proper wiring and grounding techniques.

If you would like a manual, you can:

- download a free electronic version from the Internet:  
<http://www.rockwellautomation.com/literature/>
- purchase a printed manual by contacting your local Allen-Bradley distributor or Rockwell Automation representative

## Overview

The Micro800™ expansion I/O is a modular I/O that complements and extends the capabilities of Micro850™ controllers. These expansion I/O modules interface with Micro850 controllers using an I/O expansion port.

### I/O Module Overview

2085-IA8 shown

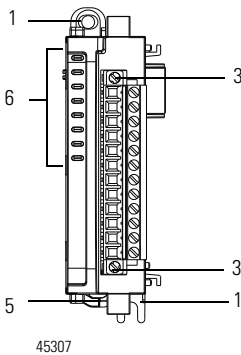

Front view

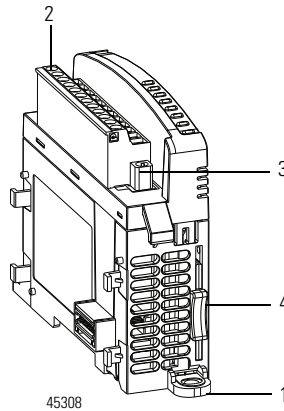

Right top view

### Module Description

	Description		Description
1	Mounting screw hole / mounting foot	4	Module interconnect latch
2	Removable Terminal Block (RTB)	5	DIN rail mounting latch
3	RTB hold down screws	6	I/O status LED



This equipment is sensitive to electrostatic discharge (ESD).  
Follow ESD prevention guidelines when handling this equipment.

### Mount the Module

For more information on proper grounding guidelines, see the Industrial Automation Wiring and Grounding Guidelines, publication [1770-4.1](#).

### Module Spacing

Maintain spacing from objects such as enclosure walls, wireways and adjacent equipment. Allow 50.8 mm (2 in.) of space on all sides for adequate ventilation, as shown.

### Mounting Dimensions and DIN Rail Mounting

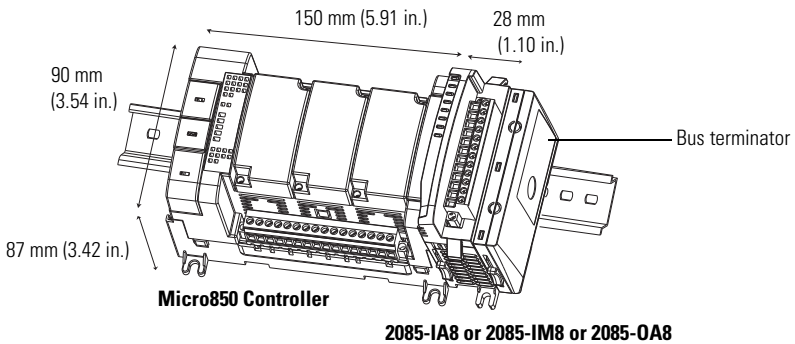

Mounting dimensions do not include mounting feet or DIN rail latches.

45312

## DIN Rail Mounting

The module can be mounted using the following DIN rails: 35 x 7.5 mm x 1 mm (EN 50 022 - 35 x 7.5).

**TIP** For environments with greater vibration and shock concerns, use the panel mounting method, instead of DIN rail mounting.



**ATTENTION:** This product is grounded through the DIN rail to chassis ground. Use zinc plated yellow-chromate steel DIN rail to assure proper grounding. The use of other DIN rail materials (for example, aluminum or plastic) that can corrode, oxidize, or are poor conductors, can result in improper or intermittent grounding. Secure DIN rail to mounting surface approximately every 200 mm (7.8 in.) and use end-anchors appropriately.

---

Before mounting the module on a DIN rail, use a flat-blade screwdriver in the DIN rail latch and pry it downwards until it is in the unlatched position.

1. Hook the top of the DIN rail mounting area of the module onto the DIN rail, and then press the bottom until the module snaps onto the DIN rail.
2. Push the DIN rail latch back into the latched position.  
Use DIN rail end anchors (Allen-Bradley part number 1492-EAJ35 or 1492-EAHJ35) for vibration or shock environments.

To remove your module from the DIN rail, pry the DIN rail latch downwards until it is in the unlatched position.

## Panel Mounting

The preferred mounting method is to use two M4 (#8) per module. Hole spacing tolerance:  $\pm 0.4$  mm (0.016 in.). For mounting dimensions, refer to Micro830 and Micro850 Programmable Controller User Manual, publication [2080-UM002](#).

Follow these steps to install your module using mounting screws.

1. Place the module next to the controller against the panel where you are mounting it. Make sure the controller and module are spaced properly.
2. Mark drilling holes through the mounting screw holes and mounting feet then remove the module.
3. Drill the holes at the markings, then replace the module and mount it.  
Leave the protective debris strip in place until you are finished wiring the module and any other devices.

## System Assembly

The Micro800 expansion I/O module is attached to the controller or another I/O module by means of interconnecting latches and hooks, as well as the bus connector. The Micro850 controller and expansion I/O modules must terminate with a 2085-ECR Bus Terminator module.

Be sure to lock the module interconnect latches and tighten the RTB hold down screws before applying power to the module.

For installation of the 2085-ECR module, refer to Micro800 Bus Terminator Module Installation Instructions, publication [2085-IN002](#).

---



**ATTENTION:** Failure to connect a bus terminator module to the last expansion I/O module will result in a controller hard fault.

---

## Field Wiring Connections

In solid-state control systems, grounding and wire routing helps limit the effects of noise due to electromagnetic interference (EMI).

---



**ATTENTION:** Do not wire more than 2 conductors on any single terminal.

---

## Wire the Modules

Included with your module is a single 12-pin Removable Terminal Block (RTB). Basic wiring of the module is shown below.



**Basic Wiring to the 2085-IA8, 2085-IM8, 2085-OA8 Modules**

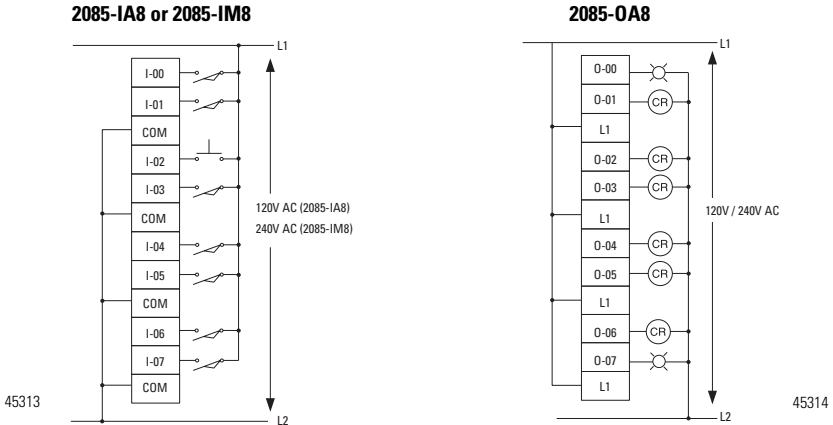

**Specifications**

**General Specifications**

Attribute	2085-IA8	2085-IM8	2085-OA8
Number of I/O	8		
Dimensions HxVxD	28 x 90 x 87 mm (1.10 x 3.54 x 3.42 in.)		
Shipping weight, approx.	140 g (4.93 oz)		
Bus current draw, max	5V DC, 150 mA		5V DC, 180 mA
Wire size	0.25... 2.5 mm <sup>2</sup> (22...14 AWG) solid or stranded copper wire rated at 75 °C (167 °F), or greater, 1.2 mm (3/64 in.) insulation max		
Insulation stripping length	10 mm (0.39 in.)pdf		
Wiring category <sup>(1)</sup>	2 – on signal ports		
Wire type	Copper		
Terminal screw torque, max	0.5...0.6 Nm (4.4...5.3 lb-in.) <sup>(2)</sup>		
Input/output circuit type	120V AC input	240V AC input	120V/240V AC output
Power supply	120V AC	240V AC	120V/240V AC
Power dissipation, total	2.36 W	2.34 W	5.19 W
Enclosure type rating	None (open-style)		

**General Specifications**

Attribute	2085-IA8	2085-IM8	2085-OA8
Status indicators	8 yellow indicators		
Isolation voltage	150V (continuous), Reinforced Insulation Type, channel to system Type tested at 1950V DC for 60 s	240V (continuous), Reinforced Insulation Type, channel to system Type tested at 3250V DC for 60 s	
North American temp code	T4		

(1) Use this Conductor Category information for planning conductor routing. Refer to Industrial Automation Wiring and Grounding Guidelines, publication [1770-4.1](#).

(2) RTB hold down screws should be tightened by hand. They should not be tightened using a power tool.

**Input Specifications – 2005-IA8 and 2085-IM8**

Attribute	2085-IA8	2085-IM8
Number of Inputs	8	
Voltage category	120V AC	240V AC
Operating voltage range	74...120V AC	159...240V AC
Off-state voltage, max	20V AC	40V AC
Off-state current, max	2.5 mA	
On-state current, min	5.0 mA @ 74V AC	4.0 mA @ 159V AC
On-state current, max	12.5 mA @ 120V AC	7.0 mA @ 240V AC
Input impedance, max	22.2 kΩ	
Inrush current, max	450 mA	
Input filter time Off to On On to Off	≤20 ms	
IEC type compliance	Type 3	

**Output Specifications - 2085-OA8**

Attribute	Value
Number of Outputs	8
Voltage category	120V/230V AC
Operating voltage range	120...240V AC
Output voltage, min	85V AC
Output voltage, max	240V AC
Off-state current, max	2.5 mA
On-state current, min	10 mA per output
On-state current, max	0.5 A per output
On-state current, per module, max	4 A

**Output Specifications - 2085-OA8**

Attribute	Value
Off-state voltage drop, max	1.5V AC @ 0.5 A 2.5V AC @10 mA
Fusing	Not protected. A suitable rating fuse is recommended to protect outputs.
Output signal delay Off to On On to Off	9.3 ms for 60 Hz, 11 ms for 50 Hz 9.3 ms for 60 Hz, 11 ms for 50 Hz
Surge current, max	5 A

**Environmental Specifications**

Attribute	Value
Temperature, operating	IEC 60068-2-1 (Test Ad, Operating Cold), IEC 60068-2-2 (Test Bd, Operating Dry Heat), IEC 60068-2-14 (Test Nb, Operating Thermal Shock): -20...65 °C (-4...149 °F)
Temperature, surrounding air, max	65 °C (149 °F)
Temperature, non-operating	IEC 60068-2-1 (Test Ab, Unpackaged Nonoperating Cold), IEC 60068-2-2 (Test Bb, Unpackaged Nonoperating Dry Heat), IEC 60068-2-14 (Test Na, Unpackaged Nonoperating Thermal Shock): -40...85 °C (-40...185 °F)
Relative humidity	IEC 60068-2-30 (Test Db, Unpackaged Damp Heat): 5...95% non-condensing
Vibration	IEC 60068-2-6 (Test Fc, Operating): 2 g @ 10...500 Hz
Shock, operating	IEC 60068-2-27 (Test Ea, Unpackaged Shock): 25 g
Shock, non-operating	IEC 60068-2-27 (Test Ea, Unpackaged Shock): 25 g – for DIN rail mount 35 g – for panel mount
Emissions	CISPR 11 Group 1, Class A
ESD immunity	IEC 61000-4-2: 6 kV contact discharges 8 kV air discharges
Radiated RF immunity	IEC 61000-4-3: 10V/m with 1 kHz sine-wave 80% AM from 80...2000 MHz 10V/m with 200 Hz 50% Pulse 100% AM at 900 MHz 10V/m with 200 Hz 50% Pulse 100% AM at 1890 MHz 10V/m with 1 kHz sine-wave 80% AM from 2000...2700 MHz
EFT/B immunity	IEC 61000-4-4: ±2 kV at 5 kHz on signal ports
Surge transient immunity	IEC 61000-4-5: ±1 kV line-line(DM) and ±2 kV line-earth(CM) on signal ports
Conducted RF immunity	IEC 61000-4-6: 10V rms with 1 kHz sine-wave 80% AM from 150 kHz...80 MHz

## Certifications

Certification (when product is marked) <sup>(1)</sup>	Value
c-UL-us	UL Listed Industrial Control Equipment, certified for US and Canada. See UL File E322657. UL Listed for Class I, Division 2 Group A,B,C,D Hazardous Locations, certified for U.S. and Canada. See UL File E334470
CE	European Union 2004/108/EC EMC Directive, compliant with: EN 61326-1; Meas./Control/Lab., Industrial Requirements EN 61000-6-2; Industrial Immunity EN 61000-6-4; Industrial Emissions EN 61131-2; Programmable Controllers (Clause 8, Zone A & B) European Union 2006/95/EC LVD, compliant with: EN 61131-2; Programmable Controllers (Clause 11)
C-Tick	Australian Radiocommunications Act, compliant with: AS/NZS CISPR 11; Industrial Emissions
KC	Korean Registration of Broadcasting and Communications Equipment, compliant with: Article 58-2 of Radio Waves Act, Clause 3

<sup>(1)</sup> See the Product Certification link at <http://www.rockwellautomation.com/products/certification/> for Declaration of Conformity, Certificates, and other certification details.

Allen-Bradley, Rockwell Automation, Micro800, Micro850 and TechConnect are trademarks of Rockwell Automation, Inc.

Trademarks not belonging to Rockwell Automation are property of their respective companies.

Rockwell Otomasyon Ticaret A.Ş., Kar Plaza İş Merkezi E Blok Kat:6 34752 İçerenköy, İstanbul, Tel: +90 (216) 5698400

[www.rockwellautomation.com](http://www.rockwellautomation.com)

### Power, Control and Information Solutions Headquarters

Americas: Rockwell Automation, 1201 South Second Street, Milwaukee, WI 53204-2496 USA, Tel: (1) 414.382.2000, Fax: (1) 414.382.4444  
Europe/Middle East/Africa: Rockwell Automation, Vorstaan/Boulevard du Souverain 36, 1170 Brussels, Belgium, Tel: (32) 2 663 0600, Fax: (32) 2 663 0640  
Asia Pacific: Rockwell Automation, Level 14, Core F, Cyberport 3, 100 Cyberport Road, Hong Kong, Tel: (852) 2887 4788, Fax: (852) 2508 1846

Publication 2085-IN005B-EN-P - September 2012

PN-101625

Copyright © 2012 Rockwell Automation, Inc. All rights reserved. Printed in Singapore.