

FLEX I/O 5V DC TTL Digital Input and Output Modules

Catalog numbers 1794-IG16, 1794-OG16

Table of Contents

Topic	Page
Important User Information	2
Environment and Enclosure	3
Preventing Electrostatic Discharge	3
North American Hazardous Location Approval	4
Install Your Digital Module	6
Configure Your Input Module	10
Configure Your Output Module	11
Specifications	12

Important User Information

Solid-state equipment has operational characteristics differing from those of electromechanical equipment. Safety Guidelines for the Application, Installation, and Maintenance of Solid-State Controls (Publication [SGI-1.1](#) available from your local Rockwell Automation Sales Office or online at <http://www.rockwellautomation.com/literature/>) describes some important differences between solid-state equipment and hard-wired electromechanical devices. Because of this difference, and also because of the wide variety of uses for solid-state equipment, all persons responsible for applying this equipment must satisfy themselves that each intended application of this equipment is acceptable.





In no event will Rockwell Automation, Inc. be responsible or liable for indirect or consequential damages resulting from the use or application of this equipment.

The examples and diagrams in this manual are included solely for illustrative purposes. Because of the many variables and requirements associated with any particular installation, Rockwell Automation, Inc. cannot assume responsibility or liability for actual use based on the examples and diagrams.

No patent liability is assumed by Rockwell Automation, Inc. with respect to use of information, circuits, equipment, or software described in this manual.

Reproduction of the contents of this manual, in whole or in part, without written permission of Rockwell Automation, Inc., is prohibited.

Throughout this manual, when necessary, we use notes to make you aware of safety considerations.

	WARNING: Identifies information about practices or circumstances that can cause an explosion in a hazardous environment, which may lead to personal injury or death, property damage, or economic loss.
	ATTENTION: Identifies information about practices or circumstances that can lead to personal injury or death, property damage, or economic loss. Attentions help you identify a hazard, avoid a hazard, and recognize the consequences.
	SHOCK HAZARD: Labels may be on or inside the equipment (for example, drive or motor) to alert people that dangerous voltage may be present.
	BURN HAZARD: Labels may be on or inside the equipment (for example, drive or motor) to alert people that surfaces may reach dangerous temperatures.
IMPORTANT	Identifies information that is critical for successful application and understanding of the product.

Environment and Enclosure



ATTENTION: This equipment is intended for use in a Pollution Degree 2 industrial environment, in overvoltage Category II applications (as defined in IEC publication 60664-1), at altitudes up to 2000 m (6562 ft) without derating.

This equipment is considered Group 1, Class A industrial equipment according to IEC/CISPR Publication 11. Without appropriate precautions, there may be potential difficulties ensuring electromagnetic compatibility in other environments due to conducted as well as radiated disturbance.

This equipment is supplied as open-type equipment. It must be mounted within an enclosure that is suitably designed for those specific environmental conditions that will be present and appropriately designed to prevent personal injury resulting from accessibility to live parts. The enclosure must have suitable flame-retardant properties to prevent or minimize the spread of flame, complying with a flame spread rating of 5VA, V2, V1, V0 (or equivalent) if non-metallic. The interior of the enclosure must be accessible only by the use of a tool. Subsequent sections of this publication may contain additional information regarding specific enclosure type ratings that are required to comply with certain product safety certifications.

In addition to this publication, see:

- Industrial Automation Wiring and Grounding Guidelines, Rockwell Automation publication [1770-4.1](#), for additional installation requirements.
- NEMA Standard 250 and IEC 60529, as applicable, for explanations of the degrees of protection provided by different types of enclosure.

Preventing Electrostatic Discharge





ATTENTION: This equipment is sensitive to electrostatic discharge, which can cause internal damage and affect normal operation. Follow these guidelines when you handle this equipment:

- Touch a grounded object to discharge potential static.
 - Wear an approved grounding wriststrap.
 - Do not touch connectors or pins on component boards.
 - Do not touch circuit components inside the equipment.
 - Use a static-safe workstation, if available.
 - Store the equipment in appropriate static-safe packaging when not in use.
-

4 FLEX I/O 5V DC TTL Digital Input and Output Modules

North American Hazardous Location Approval

The following modules are North American Hazardous Location approved: 1794-IG16, 1794-OG16.

The following information applies when operating this equipment in hazardous locations:	Informations sur l'utilisation de cet équipement en environnements dangereux:
<p>Products marked "CL I, DIV 2, GP A, B, C, D" are suitable for use in Class I Division 2 Groups A, B, C, D, Hazardous Locations and nonhazardous locations only. Each product is supplied with markings on the rating nameplate indicating the hazardous location temperature code. When combining products within a system, the most adverse temperature code (lowest "T" number) may be used to help determine the overall temperature code of the system. Combinations of equipment in your system are subject to investigation by the local Authority Having Jurisdiction at the time of installation.</p>	<p>Les produits marqués "CL I, DIV 2, GP A, B, C, D" ne conviennent qu'à une utilisation en environnements de Classe I Division 2 Groupes A, B, C, D dangereux et non dangereux. Chaque produit est livré avec des marquages sur sa plaque d'identification qui indiquent le code de température pour les environnements dangereux. Lorsque plusieurs produits sont combinés dans un système, le code de température le plus défavorable (code de température le plus faible) peut être utilisé pour déterminer le code de température global du système. Les combinaisons d'équipements dans le système sont sujettes à inspection par les autorités locales qualifiées au moment de l'installation.</p>
 <p>EXPLOSION HAZARD</p> <ul style="list-style-type: none">• Do not disconnect equipment unless power has been removed or the area is known to be nonhazardous.• Do not disconnect connections to this equipment unless power has been removed or the area is known to be nonhazardous. Secure any external connections that mate to this equipment by using screws, sliding latches, threaded connectors, or other means provided with this product.• Substitution of components may impair suitability for Class I, Division 2.• If this product contains batteries, they must only be changed in an area known to be nonhazardous.	 <p>RISQUE D'EXPLOSION</p> <ul style="list-style-type: none">• Couper le courant ou s'assurer que l'environnement est classé non dangereux avant de débrancher l'équipement.• Couper le courant ou s'assurer que l'environnement est classé non dangereux avant de débrancher les connecteurs. Fixer tous les connecteurs externes reliés à cet équipement à l'aide de vis, loquets coulissants, connecteurs filetés ou autres moyens fournis avec ce produit.• La substitution de composants peut rendre cet équipement inadapté à une utilisation en environnement de Classe I, Division 2.• S'assurer que l'environnement est classé non dangereux avant de changer les piles.



ATTENTION: FLEX™ I/O is grounded through the DIN rail to chassis ground. Use zinc plated yellow-chromate steel DIN rail to assure proper grounding. The use of other DIN rail materials (for example, aluminum or plastic) that can corrode, oxidize, or are poor conductors, can result in improper or intermittent grounding. Secure DIN rail to mounting surface approximately every 200 mm (7.8 in.) and use end-anchors appropriately.



WARNING: If you insert or remove the module while backplane power is on, an electrical arc can occur. This could cause an explosion in hazardous location installations. Be sure that power is removed or the area is nonhazardous before proceeding.



WARNING: Do not connect control circuit directly to line voltage. Line voltage must be supplied by a suitable, approved isolating transformer or power supply having short circuit capacity not exceeding 100 VA maximum or equivalent.



WARNING: If you connect or disconnect wiring while the field-side power is on, an electrical arc can occur. This could cause an explosion in hazardous location installations. Be sure that power is removed or the area is nonhazardous before proceeding.

Install Your Digital Module

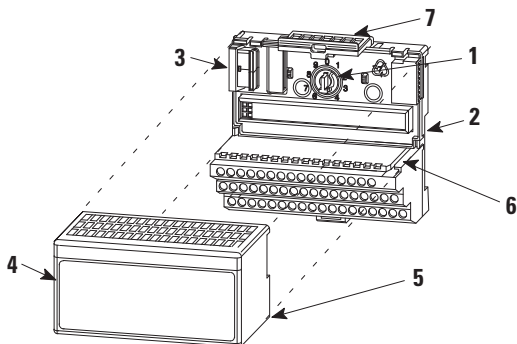

	Description		Description
1	Keyswitch	5	Alignment bar
2	Terminal base	6	Groove
3	Flexbus connector	7	Latching mechanism
4	Module		

The module mounts on a 1794 terminal base.



ATTENTION: Do not remove or replace a Terminal Base unit when power is applied. Interruption of the backplane can result in unintentional operation or machine motion.



ATTENTION: During mounting of all devices, be sure that all debris (metal chips, wire strands, etc.) is kept from falling into the module. Debris that falls into the module could cause damage on power up.

1. Rotate the keyswitch (1) on the terminal base (2) clockwise to position 1 as required for this type of module.

2. Make certain the flexbus connector (3) is pushed all the way to the left to connect with the neighboring terminal base/adaptor. **You cannot install the module unless the connector is fully extended.**
3. Make sure the pins on the bottom of the module are straight so they will align properly with the connector in the terminal base.
4. Position the module (4) with its alignment bar (5) aligned with the groove (6) on the terminal base.
5. Press firmly and evenly to seat the module in the terminal base unit. The module is seated when the latching mechanism (7) is locked into the module.

Connect Wiring for your Module

(using a 1794-TB3 or 1794-TB3S Terminal Base)

1. Connect individual input or output wiring to numbered terminals on the 0-15 row (A) as indicated in the Wiring Connections for 1794-IG16 and 1794-OG16 table.
2. Connect the associated input and output devices as indicated in the wiring diagrams.
3. Connect +V DC power to terminal 34 on the 34-51 row (C).
4. Connect DC common to terminal 16 on the 16-33 row (B).
5. If daisy chaining power to the next terminal base, connect a jumper from terminal 51 (+V DC) on this base unit to terminal 34 on the next base unit.
6. If continuing DC common to the next base unit, connect a jumper from terminal 33 (common) on this base unit to terminal 16 on the next base unit.

Wiring Connections for 1794-IG16 and 1794-OG16

Channel	Signal	Power Terminal	Common Terminal
0	A-0	C-35	B-17
1	A-1	C-36	B-18
2	A-2	C-37	B-19
3	A-3	C-38	B-20
4	A-4	C-39	B-21
5	A-5	C-40	B-22
6	A-6	C-41	B-23

8 FLEX I/O 5V DC TTL Digital Input and Output Modules

Wiring Connections for 1794-IG16 and 1794-OG16

Channel	Signal	Power Terminal	Common Terminal
7	A-7	C-42	B-24
8	A-8	C-43	B-25
9	A-9	C-44	B-26
10	A-10	C-45	B-27
11	A-11	C-46	B-28
12	A-12	C-47	B-29
13	A-13	C-48	B-30
14	A-14	C-49	B-31
15	A-15	C-50	B-32
+5V DC	C-34...C-51 are internally connected together		
Common	B-16...B-33 are internally connected together		

1794-TB3 and 1794-TB3S Wiring for 1794-IG16

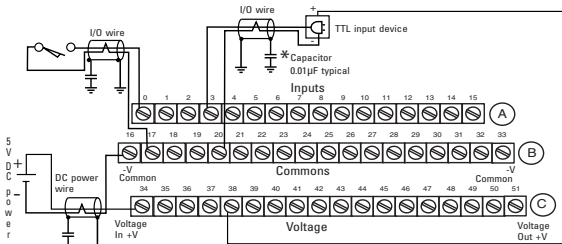

* Use Belden 8761, or equivalent, shielded wire.

Capacitors shown must be 0.01µF and rated for 2000 Volts (minimum).

I/O cable length must be less than 10 meters.

(1794-TB3 shown)

1794-TB3 and 1794-TB3S Wiring for 1794-OG16

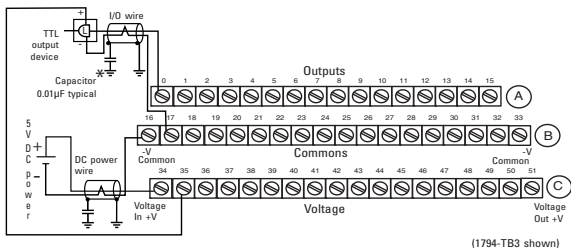

*Use Belden 8761, or equivalent, shielded wire.

Capacitors shown must be 0.01µF and rated for 2000 Volts (minimum).

I/O cable length must be less than 10 meters.

IMPORTANT To comply with the CE Low Voltage Directive (LVD), all connected I/O must be powered from a source compliant with the following: Safety Extra Low Voltage (SELV) or Protected Extra Low Voltage (PELV).

Ground Your Module

Use shielded communication cable (Belden #8761). The Belden cable has two signal wires (black and clear), one drain wire, and a foil shield. The drain wire and foil shield must be grounded at one end of the cable.

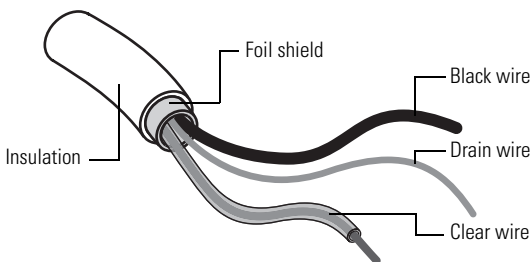

IMPORTANT Do not ground the drain wire and foil shield at both ends of the cable.

Configure Your Input Module

You configure your input module by setting bits in the configuration word (word 3).

Image Table Memory Map for the 1794-IG16 Module

Dec	15	14	13	12	11	10	9	8	7	6	5	4	3	2	1	0
Oct	17	16	15	14	13	12	11	10	7	6	5	4	3	2	1	0
Read	I15	I14	I13	I12	I11	I10	I9	I8	I7	I6	I5	I4	I3	I2	I1	I0
Write	Not used - set to 0										Input Filter FT1 12...15			Input Filter FT0 0...11		

Where I = Input status
 FT0 = Input filter time for inputs 0...11
 FT1 = Input filter time for inputs 12...15

Set the Input Filter Time for the 1794-IG16 Module

To set the input filter time, set the associated bits in the output image (complementary word) for the module.

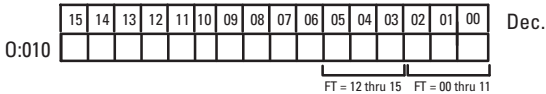

Input Filter Times

Bits			Description	Selected Filter Time
02	01	00	Filter Time for inputs 00...11	
05	04	03	Filter Time for inputs 12...15	
0	0	0	Filter Time 0 (Default)	0.25 ms
0	0	1	Filter Time 1	0.5 ms
0	1	0	Filter Time 2	1 ms
0	1	1	Filter Time 3	2 ms
1	0	1	Filter Time 4	4 ms
1	0	1	Filter Time 5	8 ms
1	1	0	Filter Time 6	16 ms
1	1	1	Filter Time 7	32 ms

Configure Your Output Module

You configure your output module by setting bits in word 1.

Image Table Memory Map for the 1794-OG16 Module

Dec	15	14	13	12	11	10	9	8	7	6	5	4	3	2	1	0
Oct	17	16	15	14	13	12	11	10	7	6	5	4	3	2	1	0
Read	Not used – set to 0															
Write	015	014	013	012	011	010	09	08	07	06	05	04	03	02	01	00
Where	0 = Output															

Specifications

Specifications – FLEX I/O 5V DC TTL Input Module 1794-IG16

Attribute	Value
Number of inputs	16, TTL
Recommended terminal base unit	1794-TB3, 1794-TB3S, 1794-TB3K, 1794-TB3SK, 1794-TBKD
On-state voltage, min	0.2V DC
On-state voltage, nom	0V DC
On-state voltage, max	0.8V DC
Off-state voltage, max	2...5.5V DC
Off-state current, max	4.1 mA
Input impedance	1.4 k Ω min 1.5 k Ω typical
Isolation voltage	50V (continuous), Basic Insulation Type, Type tested @ 707V DC for 60 s, between field side and system No isolation between individual channels
Input filter time ⁽¹⁾ Off to On On to Off	Refer to Input Filter Times table
FlexBus current	40 mA @ 5V DC
Power dissipation, max	1.4 W @ 5.5V DC
Thermal dissipation, max	4.78 BTU/hr @ 5.5V DC

⁽¹⁾ Input off-to-on filter time is the time from a valid input signal to recognition by the module. Input on-to-off filter time is time from the input signal dropping below the valid level to recognition by the module.

IMPORTANT TTL inputs are inverted
 (-0.2...0.8V DC=logic low voltage=1=on
 2.0...5.5V DC=logic high voltage=0=off).
 Use a NOT instruction in the ladder program to convert to traditional
 true=High logic.

Specifications – FLEX I/O 5V DC TTL Output Module 1794-0G16

Attribute	Value
Number of outputs	16, TTL
Recommended terminal base unit	1794-TB3, 1794-TB3S, 1794-TB3K, 1794-TB3SK
Output voltage, min	0V DC
Output voltage, nom	0V DC
Output voltage, max	0.4V DC
Output current rating	24 mA max per channel
On-state current	0.15 mA min per channel 24 mA max per channel
Off-state leakage, max	1 mA
Isolation voltage	50V (continuous), Basic Insulation Type Type tested at 707V DC for 60 s, between field side and system No isolation between individual channels
Output signal delay ⁽¹⁾ Off to On On to Off	0.5 ms 1.0 ms
FlexBus current	80 mA @ 5V DC
Power dissipation, max	0.8 W @ 5.5V DC
Thermal dissipation, max	3.41 BTU/hr @ 5.5V DC

⁽¹⁾ Delay time is the time from the receipt of an output on or off command to the output actually turning on or off.

IMPORTANT TTL outputs are inverted
(On=1=logic low voltage=0...0.4V DC;
Off=0=logic high voltage=4.5...5.5V DC).
Use a NOT instruction in the ladder program to convert to traditional
true=High logic.

General Specifications

Attribute	Value
Terminal base screw torque	Determined by installed terminal base
Dimensions, approx. (H x W x D)	94 x 94 x 69 mm (3.7 x 3.7 x 2.7 in.)
Indicators (field side)	16 yellow status indicators

General Specifications

Attribute	Value
External DC power supply voltage, nom	5V DC
External DC power voltage range	4.5...5.5V DC (includes 5% AC ripple)
External DC supply current range	210 mA @ 5V DC – 1794-IG16 100 mA @ 5V DC – 1794-OG16
North American temp code	T4A
Keyswitch position	1
Enclosure type rating	None (open-style)
Wire size	Determined by installed terminal base
Wiring category ⁽¹⁾	(1794-IG16) 3 - on signal ports 2 - on power ports (1794-OG16) 2 - on signal ports

⁽¹⁾ Use this conductor category information for planning conductor routing as described in Industrial Automation Wiring and Grounding Guidelines, publication [1770-4.1](#).

Environmental Specifications

Attribute	Value
Operating temperature	IEC 60068-2-1 (Test Ad, Operating Cold), IEC 60068-2-2 (Test Bd, Operating Dry Heat), IEC 60068-2-14 (Test Nb, Operating Thermal Shock): 0...55 °C (32...131 °F)
Storage temperature	IEC 60068-2-1 (Test Ab, Unpackaged Non-operating Cold), IEC 60068-2-2 (Test Bb, Unpackaged Non-operating Dry Heat), IEC 60068-2-14 (Test Na, Unpackaged Non-operating Thermal Shock): -40...85 °C (-40...185 °F)
Relative humidity	IEC 60068-2-30 (Test Db, Unpackaged Damp Heat): 5...95% non-condensing
Vibration	IEC60068-2-6 (Test Fc, Operating): 5 g @ 10...500 Hz
Shock, operating	IEC60068-2-27 (Test Ea, Unpackaged shock): 30 g
Shock, nonoperating	IEC60068-2-27 (Test Ea, Unpackaged shock): 50 g

Environmental Specifications

Attribute	Value
Emissions	CISPR 11: Group 1, Class A
ESD immunity	IEC 61000-4-2: 6 kV contact discharges 8 kV air discharges
Radiated RF immunity	IEC 61000-4-3: 10V/m with 1 kHz sine-wave 80% AM from 80...2000 MHz 10V/m with 200 Hz 50% Pulse 100% AM @ 900 MHz 10V/m with 200 Hz 50% Pulse 100% AM @ 1890 MHz 1V/m with 1 kHz sine-wave 80% AM from 2000...2700 MHz
EFT/B immunity	IEC 61000-4-4: ±2 kV @ 5 kHz on power ports ±2 kV @ 5 kHz on signal ports
Surge transient immunity	IEC 61000-4-5: ±1 kV line-line(DM) and ±2 kV line-earth(CM) on signal ports
Conducted RF immunity	IEC 61000-4-6: 10V rms with 1 kHz sine-wave 80% AM from 150 kHz...80 MHz

Certifications

Certifications (when product is marked) ⁽¹⁾	Value
c-UL-us	UL Listed Industrial Control Equipment, certified for US and Canada. See UL File E65584. UL Listed for Class I, Division 2 Group A,B,C,D Hazardous Locations, certified for U.S. and Canada. See UL File E194810.
CE	European Union 2004/108/EC EMC Directive, compliant with: EN 61326-1; Meas./Control/Lab., Industrial Requirements EN 61000-6-2; Industrial Immunity EN 61000-6-4; Industrial Emissions EN 61131-2; Programmable Controllers (Clause 8, Zone A & B)
KC	Korean Registration of Broadcasting and Communications Equipment, compliant with: Article 58-2 of Radio Waves Act, Clause 3
EAC	Russian Customs Union TR CU 020/2011 EMC Technical Regulation
RCM	Australian Radiocommunications Act, compliant with: AS/NZS CISPR 11; Industrial Emissions

⁽¹⁾ See the Product Certification link at www.ab.com for Declarations of Conformity, Certificates, and other certification details.

Rockwell Automation Support

Rockwell Automation provides technical information on the Web to assist you in using its products. At <http://www.rockwellautomation.com/support/>, you can find technical manuals, a knowledge base of FAQs, technical and application notes, sample code and links to software service packs, and a MySupport feature that you can customize to make the best use of these tools.

For an additional level of technical phone support for installation, configuration and troubleshooting, we offer TechConnect support programs. For more information, contact your local distributor or Rockwell Automation representative, or visit <http://www.rockwellautomation.com/support/>.

Installation Assistance

If you experience a problem within the first 24 hours of installation, please review the information that's contained in this manual. You can also contact a special Customer Support number for initial help in getting your product up and running.

United States or Canada	1.440.646.3434
Outside United States or Canada	Use the Worldwide Locator at http://www.rockwellautomation.com/support/americas/phone_en.html , or contact your local Rockwell Automation representative.

New Product Satisfaction Return

Rockwell Automation tests all of its products to ensure that they are fully operational when shipped from the manufacturing facility. However, if your product is not functioning and needs to be returned, follow these procedures.

United States	Contact your distributor. You must provide a Customer Support case number (call the phone number above to obtain one) to your distributor to complete the return process.
Outside United States	Please contact your local Rockwell Automation representative for the return procedure.

Documentation Feedback

Your comments will help us serve your documentation needs better. If you have any suggestions on how to improve this document, complete this form, publication [RA-DU002](#), available at <http://www.rockwellautomation.com/literature/>.

Allen-Bradley, Rockwell Automation, FLEX I/O, and TechConnect are trademarks of Rockwell Automation, Inc.

Trademarks not belonging to Rockwell Automation are property of their respective companies.

Rockwell Otomasyon Ticaret A.Ş., Kar Plaza İş Merkezi E Blok Kat:6 34752 İçerenköy, İstanbul, Tel: +90 (216) 5698400

www.rockwellautomation.com

Power, Control and Information Solutions Headquarters

Americas: Rockwell Automation, 1201 South Second Street, Milwaukee, WI 53204-2496 USA, Tel: (1) 414.382.2000, Fax: (1) 414.382.4444
Europe/Middle East/Africa: Rockwell Automation, Voorlaan/Boulevard du Souverain 36, 1170 Brussels, Belgium, Tel: (32) 2 663 0600, Fax: (32) 2 663 0640
Asia Pacific: Rockwell Automation, Level 14, Core F, Cyberport 3, 100 Cyberport Road, Hong Kong, Tel: (852) 2887 4788, Fax: (852) 2508 1846

Publication 1794-IN119B-EN-P - August 2015

Supersedes Publication 1794-IN119A-EN-P - June 2008

Copyright © 2015 Rockwell Automation, Inc. All rights reserved.