



Installation Instructions

FLEX I/O DC Power Supply Modules

Cat. No. 1794-PS13 and 1794-PS3

Important User Information

Solid state equipment has operational characteristics differing from those of electromechanical equipment. *Safety Guidelines for the Application, Installation and Maintenance of Solid State Controls* (Publication SGI-1.1 available from your local Rockwell Automation sales office or online at <http://www.ab.com/manuals/gi>) describes some important differences between solid state equipment and hard-wired electromechanical devices. Because of this difference, and also because of the wide variety of uses for solid state equipment, all persons responsible for applying this equipment must satisfy themselves that each intended application of this equipment is acceptable.

In no event will Rockwell Automation, Inc. be responsible or liable for indirect or consequential damages resulting from the use or application of this equipment.

The examples and diagrams in this manual are included solely for illustrative purposes. Because of the many variables and requirements associated with any particular installation, Rockwell Automation, Inc. cannot assume responsibility or liability for actual use based on the examples and diagrams.

No patent liability is assumed by Rockwell Automation, Inc. with respect to use of information, circuits, equipment, or software described in this manual.

Reproduction of the contents of this manual, in whole or in part, without written permission of Rockwell Automation, Inc. is prohibited.

Throughout this manual we use notes to make you aware of safety considerations.

WARNING  Identifies information about practices or circumstances that can cause an explosion in a hazardous environment, which may lead to personal injury or death, property damage, or economic loss.

IMPORTANT Identifies information that is critical for successful application and understanding of the product.

ATTENTION  Identifies information about practices or circumstances that can lead to personal injury or death, property damage, or economic loss. Attentions help you:

- identify a hazard
- avoid a hazard
- recognize the consequence

ATTENTION  **Environment and Enclosure**

This equipment is intended for use in a Pollution Degree 2 industrial environment, in overvoltage Category II applications (as defined in IEC publication 60664-1), at altitudes up to 2000 meters without derating.

This equipment is considered Group 1, Class A industrial equipment according to IEC/CISPR Publication 11. Without appropriate precautions, there may be potential difficulties ensuring electromagnetic compatibility in other environments due to conducted as well as radiated disturbance.

This equipment is supplied as "open type" equipment. It must be mounted within an enclosure that is suitably designed for those specific environmental conditions that will be present and appropriately designed to prevent personal injury resulting from accessibility to live parts. The interior of the enclosure must be accessible only by the use of a tool. Subsequent sections of this publication may contain additional information regarding specific enclosure type ratings that are required to comply with certain product safety certifications.

See NEMA Standards publication 250 and IEC publication 60529, as applicable, for explanations of the degrees of protection provided by different types of enclosure. Also, see the appropriate sections in this publication, as well as the Allen-Bradley publication 1770-4.1 ("Industrial Automation Wiring and Grounding Guidelines"), for additional installation requirements pertaining to this equipment.

ATTENTION  FLEX I/O is grounded through the DIN rail to chassis ground. Use zinc plated yellow-chromate steel DIN rail to assure proper grounding. The use of other DIN rail materials (e.g. aluminum, plastic, etc.) that can corrode, oxidize, or are poor conductors, can result in improper or intermittent grounding.

ATTENTION  **Preventing Electrostatic Discharge**



This equipment is sensitive to electrostatic discharge, which can cause internal damage and affect normal operation. Follow these guidelines when you handle this equipment:

- Touch a grounded object to discharge potential static.
- Wear an approved grounding wriststrap.
- Do not touch connectors or pins on component boards.
- Do not touch circuit components inside the equipment.
- If available, use a static-safe workstation.

WARNING  If you connect or disconnect wiring while the field-side power is on, an electrical arc can occur. This could cause an explosion in hazardous installations. Be sure that power is removed or the area is nonhazardous before proceeding.

North American Hazardous Location Approval

The following devices are North American Hazardous Location approved: 1794-PS13 and 1794-PS3.

The following information applies when operating this equipment in hazardous locations:	Informations sur l'utilisation de cet équipement en environnements dangereux :
<p>Products marked "CL 1, DIV 2, GP A, B, C, D" are suitable for use in Class I Division 2 Groups A, B, C, D, Hazardous Locations and nonhazardous locations only. Each product is supplied with markings on the rating nameplate indicating the hazardous location temperature code. When combining products within a system, the most adverse temperature code (lowest "T" number) may be used to help determine the overall temperature code of the system. Combinations of equipment in your system are subject to investigation by the local Authority Having Jurisdiction at the time of installation.</p>	<p>Les produits marqués "CL 1, DIV 2, GP A, B, C, D" ne conviennent qu'à une utilisation en environnements de Classe I Division 2 Groupes A, B, C, D dangereux et non dangereux. Chaque produit est livré avec des marquages sur sa plaque d'identification qui indiquent le code de température pour les environnements dangereux. Lorsque plusieurs produits sont combinés dans un système, le code de température le plus défavorable (code de température le plus faible) peut être utilisé pour déterminer le code de température global du système. Les combinaisons d'équipements dans le système sont sujettes à inspection par les autorités locales qualifiées au moment de l'installation.</p>
<p>WARNING  EXPLOSION HAZARD</p> <ul style="list-style-type: none"> • Do not disconnect equipment unless power has been removed or the area is known to be nonhazardous. • Do not disconnect connections to this equipment unless power has been removed or the area is known to be nonhazardous. Secure any external connections that mate to this equipment by using screws, sliding latches, threaded connectors, or other means provided with this product. • Substitution of components may impair suitability for Class I, Division 2. • If this product contains batteries, they must only be changed in an area known to be nonhazardous. 	<p>AVERTISSEMENT  RISQUE D'EXPLOSION</p> <ul style="list-style-type: none"> • Couper le courant ou s'assurer que l'environnement est classé non dangereux avant de débrancher l'équipement. • Couper le courant ou s'assurer que l'environnement est classé non dangereux avant de débrancher les connecteurs. Fixer tous les connecteurs externes reliés à cet équipement à l'aide de vis, loquets coulissants, connecteurs filetés ou autres moyens fournis avec ce produit. • La substitution de composants peut rendre cet équipement inadapté à une utilisation en environnement de Classe I, Division 2. • S'assurer que l'environnement est classé non dangereux avant de changer les piles.

Power Supply Modules, Cat. No. 1794-PS13 and -PS3

The 1794-PS13 power supply provides sufficient 24V dc power to operate 4 adapter modules. Do not attempt to operate an entire FLEX I/O system with the 1794-PS13 power supply.

The 1794-PS3 power supply provides sufficient 24V dc power to operate 10 adapter modules. You can use this 1794-PS3 power supply to operate an entire FLEX I/O system.

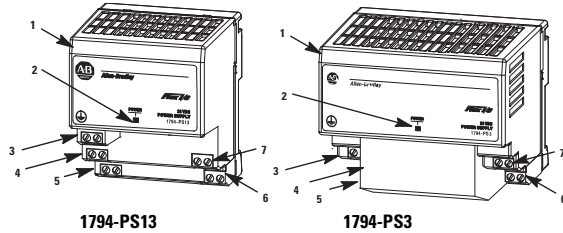

Component Identification

1	Power Supply Module
2	Indicator
3	120/230V ac ground
4	120/230V ac common L2/N connections
5	120/230V ac power L1 connections
6	+24V dc connections
7	24V dc common connections

Installing Your Power Supply Module

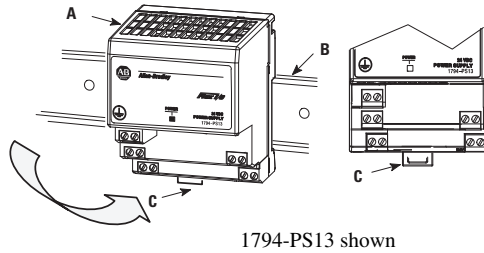

1794-PS13 shown

ATTENTION

During mounting of all devices, be sure that all debris (metal chips, wire strands, etc.) is kept from falling into the module. Debris that falls into the module could cause damage on power up.

- Hook the lip on the rear of the power supply module onto the top of the DIN rail, and rotate the power supply module onto the rail.
- Press the power supply module down onto the DIN rail until flush. Locking tab C will snap into position and lock the power supply module to the DIN rail.
- If the power supply module does not lock in place, use a screwdriver or similar device to move the locking tab down while pressing the power supply module flush onto the DIN rail, and release the locking tab to lock the power supply module in place. If necessary, push up on the locking tab to lock.

- Connect the power supply wiring as shown under “Wiring” later in this document.

Note: For panel/Wall mounting, refer to publication 1794-5.13, “Panel Mounting Kit, Cat. No. 1794-NM1.”

Connecting Wiring

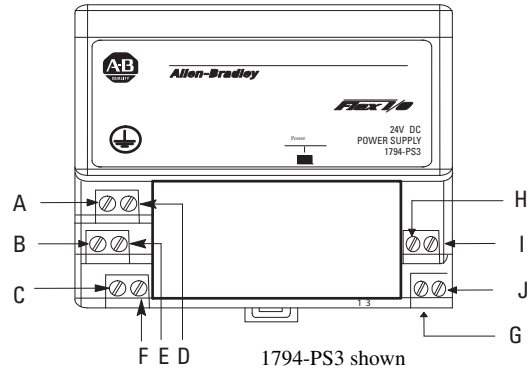

Terminals A, B and C are 120/230V ac supply terminals. Terminals D, E and F are available to daisychain this 120/230V ac power to other 1794-PS power supply modules. If applying 120/230V ac power to the power supply, you can also power the corresponding 120/230V ac modules in your FLEX I/O system.

IMPORTANT

When wiring this power supply, torque terminal screws to 7 pound-inches (0.8Nm).

- Connect the 120/230V ac power to the left side terminals on the connectors on the left side of the power supply module as follows:

Connect		To
ac ground	GND	A
120/230V ac common	L2/N	B
120/230V ac power	L1	C

- Connect terminal G (+24V dc) to the +24V dc terminal on the first adapter.
- Connect terminal H (+24V dc common) to the +24V dc common terminal on the first adapter.
- Connections I and J are used to pass +24V dc power (G) and -24V dc common (H) to the next adapter in the series (if required)
- Repeat steps 3 and 4 using terminals I and J for the second adapter.

ATTENTION

The total length of wire for terminals H, I, J and G must not exceed 3m (9.8ft). Exceeding the 3m (9.8ft) length can reduce noise immunity.

- Connections D, E and F are used to pass 120/230V ac power to adjacent 1794 power supplies, or to power any corresponding 120/230V ac modules in your FLEX I/O system.

ATTENTION

Input and output wiring must be in accordance with Class I, Division 2 wiring methods and in accordance with the authority having jurisdiction.

Example of Using a 1794-PS13 Power Supply to Power 4 Adapter Modules

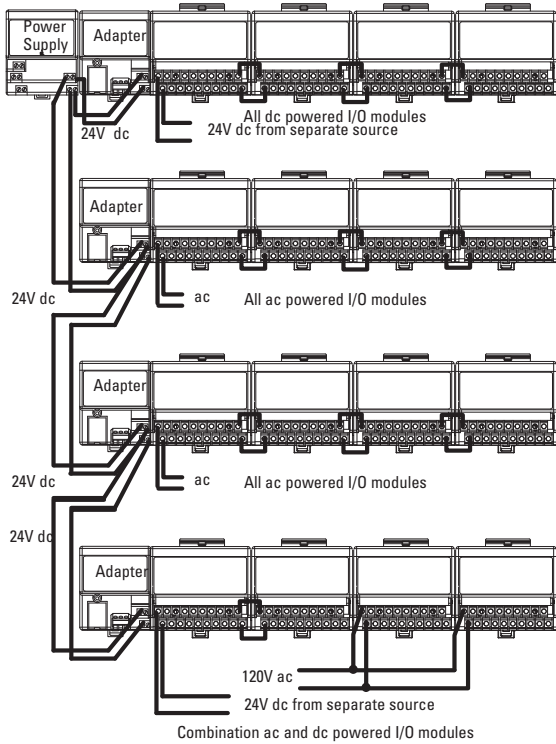

Diagnostic Indicator

The power supplies have 1 indicator.

1794-PS13

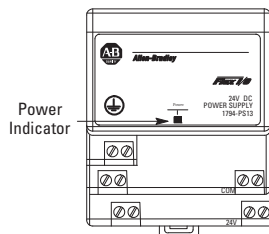

The power indicator is on (green) when voltage at the output is between 20.4V dc and 28V dc.

1794-PS3

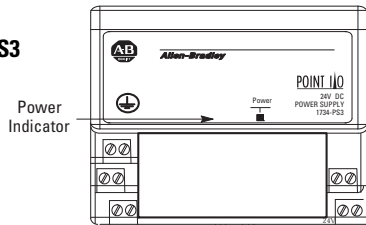

The power indicator is on (green) when voltage at the output is between 20.4V dc and 28V dc.

Indicator	Description
ON (green)	Output voltage is greater than 20.4V dc, but less than 28V dc
OFF	No power applied to power supply
	Output voltage exceeded 35V dc, and overvoltage protection shut the unit down
	Output current is above 1.4A (1794-PS13) or above 3.2A (1794-PS3)

Specifications

Specifications - Cat. No. 1794-PS13 and 1794-PS3

	1794-PS13	1794-PS3
Nominal Supply Voltage	120V ac, 47-63Hz; 0.6A max. 230V ac, 47-63Hz; 0.42A max.	120V ac, 47-63Hz; 1.7A max. 230V ac, 47-63Hz; 1.1A max.
Voltage Range	85-265V ac	
Input Current	0.7 maximum	
Inrush Current	40A typical, 1 ac cycle @ V_{in} 265V ac, 55°C	
Interruption	Output will stay within specification when input drops out for 1/2 cycle @ 47Hz, 85V ac with maximum load	
Output Specifications		
Nominal Output	+24V dc	
Voltage Range	20.4-27.6V dc (includes noise and 5% ac ripple)	
Output Current	1.3A maximum	3A maximum (horizontal mount), 2.8A all other mounting (See derating curve)
Output Power	31.2W	72W
Output Ripple	1200mV peak-to-peak maximum	
Minimum Load	0mA	50mA
Output Surge	Sufficient to drive 4 adapters	Sufficient to drive 10 adapters
Overvoltage Protection	Output internally limited to 35V dc. Cycle power to reenergize.	
Leakage Current	0.5mA rms maximum @ rated input and output	
Isolation Voltage	Tested at 2500V dc for 1s	
Overcurrent Protection	1.4A minimum	3.2A minimum
Thermal Dissipation	23.9 BTU/hr	41.0 BTU/hr
Power Dissipation	7W maximum	12W maximum
Dimensions	3.4H x 2.7W x 2.7D inches 87H x 69W x 69D mm	3.4H x 3.7W x 2.7D inches 87H x 94W x 69D mm

General Specifications

Environmental Conditions	
Operating Temperature	IEC 60068-2-1 (Test Ad, Operating Cold), IEC 60068-2-2 (Test Bd, Operating Dry Heat), IEC 60068-2-14 (Test Nb, Operating Thermal Shock): 0 to 55°C (32 to 131°F)
Storage Temperature	IEC 60068-2-1 (Test Ab, Un-packaged Non-operating Cold), IEC 60068-2-2 (Test Bb, Un-packaged Non-operating Dry Heat), IEC 60068-2-14 (Test Na, Un-packaged Non-operating Thermal Shock): -40 to 85°C (-40 to 185°F)
Relative Humidity	IEC 60068-2-30 (Test Db, Un-packaged Non-operating Damp Heat): 5 to 95% non-condensing
Vibration	IEC60068-2-6 (Test Fc, Operating): 5g @ 10-500Hz
Shock	IEC60068-2-27 (Test Ea, Unpackaged shock) Operating 30g Non-operating 50g
Emissions	CISPR 11: Group 1, Class A (with appropriate enclosure)
ESD Immunity	IEC 61000-4-2: 4kV contact discharges 8kV air discharges
Radiated RF Immunity	IEC 61000-4-3: 10V/m with 1kHz sine-wave 80%AM from 30MHz to 1000MHz
EFT/B Immunity	IEC 61000-4-4: ±2kV at 5kHz on power ports
Surge Transient Immunity	IEC 61000-4-5: ±1kV line-line(DM) and ±2kV line-earth(CM) on ac power ports
Conducted RF Immunity	IEC 61000-4-6: 10Vrms with 1kHz sine-wave 80%AM from 150kHz to 80MHz
Enclosure Type Rating	None (open-style)

Conductors Wire Size	22 to 12 AWG (0.34mm ² - 2.5mm ²) stranded copper wire rated at 75°C or higher 3/64 inch (1.2mm) insulation maximum
Category ¹	2
Terminal Screw Torque	7 pound-inches (0.8Nm)
Certifications (when product is marked) ²	<p>cULus UL Listed Industrial Control Equipment for Class I, Division 2, Groups A, B, C and D Hazardous locations</p> <p>cULus UL Listed Industrial Control Equipment, certified for US and Canada</p> <p>CE² European Union 89/336/EEC EMC Directive, compliant with: EN 61000-6-4; Industrial Emissions EN 50082-2; Industrial Immunity EN 61326; Meas./Control/Lab., Industrial Requirements EN 61000-6-2; Industrial Immunity European Union 73/23/EEC LVD Directive, compliant with: EN 61131-2; Programmable Controllers</p> <p>C-Tick² - Australian Radiocommunications Act compliant with: AS/NZS CISPR 11, Industrial Emissions</p>
<p>¹ You use this category information for planning conductor routing as described in Allen-Bradley publication 1770-4.1, Industrial Automation Wiring and Grounding Guidelines.</p> <p>² For the latest up-to-date information, see the Product Certification link at www.ab.com for Declarations of Conformity, Certificates and other certification details. For notification of any additional release notes, refer to www.ab.com/manuals/</p>	

Derating Curve for 1794-PS3 (for any mounting other than horizontal)

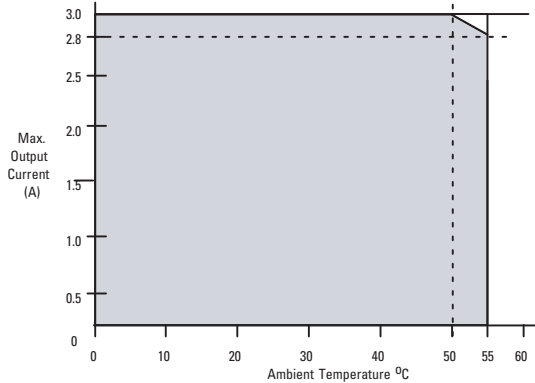

The area within the curve represents the safe operating range for the module under various conditions of user supplied 24V dc supply voltages and ambient temperatures.

- = Normal mounting safe operating range, (includes).
- = Other mounting positions (including inverted horizontal) safe operating range

Normal Mounting – Horizontal



Other Mounting (including Vertical, and Inverted Horizontal Mounting)

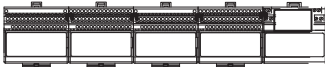

Mounting Dimensions

1794-PS13

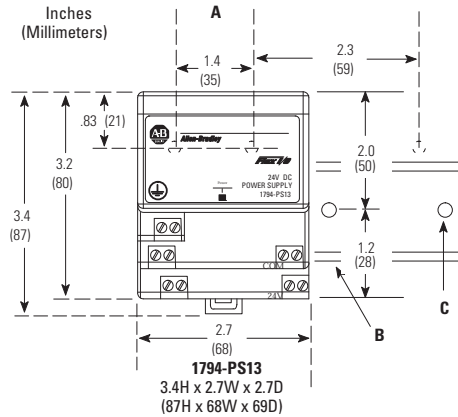

- A** = Mounting hole dimensions for optional mounting kit
- B** = DIN rail
- C** = Secure DIN rail approximately every 200mm

1794-PS3

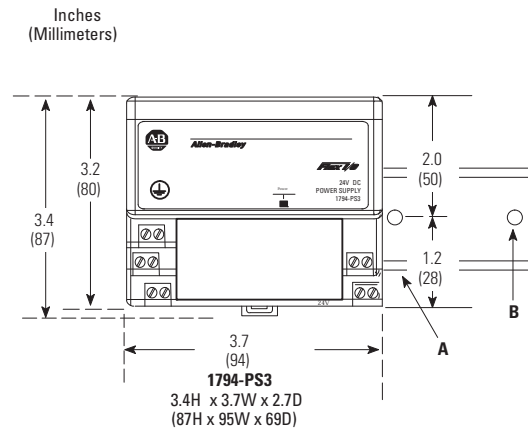

- A** = DIN rail
- B** = Secure DIN rail approximately every 200mm

Rockwell Otomasyon Ticaret A.Ş., Kar Plaza İş Merkezi E Blok Kat:6 34752 İçerenköy, İstanbul, Tel: +90 (216) 5698400

www.rockwellautomation.com

Power, Control and Information Solutions Headquarters

Americas: Rockwell Automation, 1201 South Second Street, Milwaukee, WI 53204-2496 USA, Tel: (1) 414.382.2000, Fax: (1) 414.382.4444

Europe/Middle East/Africa: Rockwell Automation, Vorstlaan/Boulevard du Souverain 36, 1170 Brussels, Belgium, Tel: (32) 2 663 0600, Fax: (32) 2 663 0640

Asia Pacific: Rockwell Automation, Level 14, Core F, Cyberport 3, 100 Cyberport Road, Hong Kong, Tel: (852) 2887 4788, Fax: (852) 2508 1846

Publication 1794-IN069D-EN-P - June 2004

Supersedes Publication 1794-IN069C-EN-P - August 2002, and 1794-5.71 - May 2000

PN 957782-90

Copyright © 2004 Rockwell Automation, Inc. All rights reserved. Printed in the U.S.A.