

# Stratix 2500 Lightly Managed Switches

Catalog Numbers 1783-LMS5, 1783-LMS8

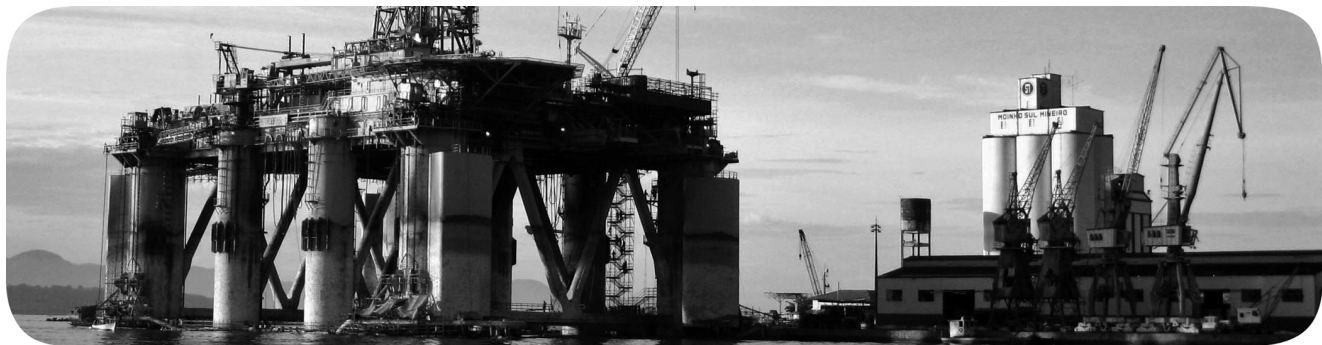

## Important User Information

Read this document and the documents listed in the additional resources section about installation, configuration, and operation of this equipment before you install, configure, operate, or maintain this product. Users are required to familiarize themselves with installation and wiring instructions in addition to requirements of all applicable codes, laws, and standards.

Activities including installation, adjustments, putting into service, use, assembly, disassembly, and maintenance are required to be carried out by suitably trained personnel in accordance with applicable code of practice.

If this equipment is used in a manner not specified by the manufacturer, the protection provided by the equipment may be impaired.

In no event will Rockwell Automation, Inc. be responsible or liable for indirect or consequential damages resulting from the use or application of this equipment.

The examples and diagrams in this manual are included solely for illustrative purposes. Because of the many variables and requirements associated with any particular installation, Rockwell Automation, Inc. cannot assume responsibility or liability for actual use based on the examples and diagrams.

No patent liability is assumed by Rockwell Automation, Inc. with respect to use of information, circuits, equipment, or software described in this manual.

Reproduction of the contents of this manual, in whole or in part, without written permission of Rockwell Automation, Inc., is prohibited

Throughout this manual, when necessary, we use notes to make you aware of safety considerations.



**WARNING:** Identifies information about practices or circumstances that can cause an explosion in a hazardous environment, which may lead to personal injury or death, property damage, or economic loss.



**ATTENTION:** Identifies information about practices or circumstances that can lead to personal injury or death, property damage, or economic loss. Attentions help you identify a hazard, avoid a hazard, and recognize the consequence.

---

**IMPORTANT** Identifies information that is critical for successful application and understanding of the product.

---

Labels may also be on or inside the equipment to provide specific precautions.



**SHOCK HAZARD:** Labels may be on or inside the equipment, for example, a drive or motor, to alert people that dangerous voltage may be present.



**BURN HAZARD:** Labels may be on or inside the equipment, for example, a drive or motor, to alert people that surfaces may reach dangerous temperatures.



**ARC FLASH HAZARD:** Labels may be on or inside the equipment, for example, a motor control center, to alert people to potential Arc Flash. Arc Flash will cause severe injury or death. Wear proper Personal Protective Equipment (PPE). Follow ALL Regulatory requirements for safe work practices and for Personal Protective Equipment (PPE).

---

	<b>Preface</b> .....	7
	Summary of Changes .....	7
	Access Product Release Notes .....	7
	Additional Resources .....	8
	 <b>Chapter 1</b>	
<b>About the Switches</b>	EtherNet/IP CIP Interface .....	10
	CIP Network Connections .....	10
	RSLinx Software and Network Who Support .....	11
	Electronic Data Sheet (EDS) Files .....	11
	Data Accessible with CIP .....	12
	Software Features .....	13
	Hardware Features .....	13
	 <b>Chapter 2</b>	
<b>Get Started</b>	Out-of-the-box Configuration .....	16
	Express Setup	
	Configuration .....	16
	Express Setup Button .....	17
	Express Setup Modes .....	17
	Express Setup Requirements .....	18
	Run Express Setup in Short Press Mode .....	19
	Run Express Setup in Medium Press Mode .....	21
	Run Express Setup in Long Press Mode .....	22
	Configure Network Settings in Device Manager .....	22
	Configure Network Settings in the Logix Designer Application ...	24
	Configuration in Device Manager .....	27
	Access Device Manager .....	28
	Configure Port Settings .....	30
	Configuration in the Studio 5000 Environment .....	33
	General Properties .....	34
	Connection Properties .....	36
	Switch Configuration .....	37
	Port Configuration .....	39
	User Administration in Device Manager .....	40
	Configuration Files .....	42
	Manage Configuration Files in Device Manager .....	42
	Manage Configuration Files in the Logix Designer Application	44
	Software Updates .....	46
	Apply a Software Update .....	46
	Apply a Backup Image .....	47
	Access Management in Device Manager .....	48

**Configure Switch Features**

**Chapter 3**

802.1X Authentication . . . . . 50

Alarms . . . . . 51

Dynamic Host Configuration Protocol (DHCP) . . . . . 54

    DHCP Persistence . . . . . 54

    Configure DHCP Persistence Via Device Manager . . . . . 55

    DHCP Snooping . . . . . 58

    Assign an IP Address to a Switch Port and Enable Snooping Via Device Manager . . . . . 58

    Bootstrap Protocol (BOOTP) . . . . . 59

    Configure DHCP Persistence Via Logix Designer . . . . . 60

EtherChannels . . . . . 64

    Configure EtherChannels in the Logix Designer Application . . . . . 67

Internet Group Management Protocol (IGMP) Snooping with Querier . . . . . 69

Port Mirroring . . . . . 71

Port Security . . . . . 72

    Configure Port Security in Device Manager . . . . . 73

    Configure Port Security in the Logix Designer Application . . . . . 75

Quality of Service (QoS) . . . . . 76

Simple Network Management Protocol (SNMP) . . . . . 77

Smartports . . . . . 87

    Avoid Smartport Mismatches . . . . . 88

    Assign Smartport Roles and VLANs in Device Manager . . . . . 88

    Assign Smartport Roles and VLANs in the Logix Designer Application . . . . . 89

Spanning Tree Protocol (STP) . . . . . 90

    Spanning Tree Modes . . . . . 91

    PortFast Features . . . . . 91

    Configure STP in Device Manager . . . . . 92

Storm Control . . . . . 96

Terminal Access Controller Access Control System Plus/Remote Authentication Dial-In User Service (TACACS+/RADIUS) . . . . . 97

Virtual Local Area Networks (VLANs) . . . . . 98

    Configure VLANs in Device Manager . . . . . 99

    Configure VLANs in the Logix Designer Application . . . . . 100

**Chapter 4**

**Monitor the Switch**

Dashboard . . . . . 104

    Front Panel . . . . . 104

    Switch Information . . . . . 105

    Switch Health . . . . . 106

    Port Utilization . . . . . 107

System Alarms . . . . . 109

Port Statistics . . . . . 110

Port Security Statistics . . . . . 111

	CIP Status .....	113
	DHCP Clients Status .....	115
	System Log Messages .....	115
	Configure the System Log Server.....	116
	View System Log Entries .....	117
	Ping Utility .....	117
	Switch Status .....	118
	Module Information .....	120
	Port Status.....	121
	Port Diagnostics .....	122
	<b>Chapter 5</b>	
<b>Troubleshoot the Switch</b>	Troubleshoot the Installation .....	126
	Status Indicators.....	126
	Power-on Self-test .....	126
	Bad or Damaged Cable.....	127
	Ethernet Cables .....	127
	Link Status.....	128
	Port Settings .....	128
	Troubleshoot IP Addresses.....	128
	Troubleshoot Device Manager .....	129
	Restart or Reset the Switch.....	129
	Restart or Reset the Switch from Device Manager .....	130
	Reset the Switch with the Express Setup Button.....	130
	Restart the Switch from the Logix Designer Application .....	131
	Troubleshoot a Firmware Update .....	131
	Troubleshoot with the Command-line Interface.....	132
	<b>Appendix A</b>	
<b>Status Indicators</b>	Port Status Indicators.....	134
	System Status Indicators .....	134
	<b>Appendix B</b>	
<b>Data Types</b>	1783-LMS5 Data Types .....	136
	1783-LMS8 Data Types .....	137
	<b>Appendix C</b>	
<b>Port Assignments for CIP Data</b>	1783-LMS5 Port Assignments .....	140
	1783-LMS8 Port Assignments .....	140
	<b>Appendix D</b>	
<b>Port Numbering</b>	1783-LMS5 Port Numbering .....	142
	1783-LMS8 Port Numbering .....	142

<b>Cables and Connectors</b>	<b>Appendix E</b>	
	10/100 Ports.....	144
	Connect to 10BASE-T- and 100BASE-TX-Compatible Devices .	144
	<b>Index</b> .....	147

This publication describes the features and tools to help you configure and monitor Stratix® 2500 lightly managed switches. In addition, this publication provides troubleshooting information to help you resolve basic switch and network issues.

This manual assumes that you understand the following:

- Local area network (LAN) switch fundamentals
- Concepts and terminology of the Ethernet protocol and local area networking

## **Summary of Changes**

This manual contains new and updated information.

<b>Topic</b>	<b>Page</b>
AAA Network Access Security	40
IEEE 802.1X Authentication	50
Dynamic Host Configuration Protocol (DHCP)	54, 115
Sticky MAC Port Security	73, 112
Terminal Access Controller Access Control System Plus/ Remote Authentication Dial-In User Service (TACACS+/ RADIUS)	97
Ping Utility	117

## **Access Product Release Notes**

Access product release notes from the Product Compatibility and Download Center at <http://www.rockwellautomation.com/rockwellautomation/support/pcdc.page>.

## Additional Resources

These documents contain additional information concerning related products from Rockwell Automation.

Resource	Description
Stratix Ethernet Device Specifications Technical Data, publication <a href="#">1783-TD001</a>	Provides specification information for the switches.
Stratix 2500 Managed Switches Installation Instructions, publication <a href="#">1783-IN011</a>	Provides installation instructions for the switches.
Ethernet Design Considerations Reference Manual, publication <a href="#">ENET-RM002</a>	Provides information about implementing a system based on the EtherNet/IP platform.
Device Manager web interface online help (provided with the switch)	Provides context-sensitive information about how to configure and use the switch, including system messages.
Industrial Automation Wiring and Grounding Guidelines, publication <a href="#">1770-4.1</a>	Provides general guidelines for installing a Rockwell Automation industrial system.
Product Certifications website, <a href="http://www.rockwellautomation.com/global/certification/overview.page">http://www.rockwellautomation.com/global/certification/overview.page</a>	Provides declarations of conformity, certificates, and other certification details.

You can view or download publications at <http://www.rockwellautomation.com/global/literature-library/overview.page>. To order paper copies of technical documentation, contact your local Allen-Bradley distributor or Rockwell Automation sales representative.



## About the Switches

Topic	Page
EtherNet/IP CIP Interface	10
Software Features	13
Hardware Features	13

Stratix® 2500 lightly managed switches provide a secure switching infrastructure for harsh environments. You can connect the switches to network devices such as servers, routers, and other switches. In industrial environments, you can connect Ethernet-enabled industrial communication devices, including programmable logic controllers (PLCs), human machine interfaces (HMIs), drives, sensors, and I/O.

The switches are available in 5- and 8-port versions. You can install the switches in two ways:

- As unmanaged switches that require no configuration, but still provide traffic prioritization and multicast optimization
- As lightly managed switches configurable in the Device Manager web interface or the Studio 5000 Logix Designer® application



## EtherNet/IP CIP Interface

Stratix 2500 switches contain an EtherNet/IP network interface. The EtherNet/IP network is an industrial automation network specification from the Open DeviceNet Vendor Association (ODVA). The network uses the Common Industrial Protocol (CIP) for its application layer and TCP/UDP/IP for its transport and network layers. This interface is accessible from any of the Ethernet ports by using the IP address of the switch.

### CIP Network Connections

CIP is an object-oriented, connection-based protocol that supports two basic types of messaging:

- Explicit
- Implicit (I/O)

A maximum of 128 connections is available. Both connection types must use the switch password before any switch parameters can be written. The password is the same one you enter during Express Setup.

**Table 1 - CIP Network Connections**

Connection	Description
Explicit Messaging	<p>Explicit Messaging connections provide generic, multi-purpose communication paths between two devices. These connections are often referred to as messaging connections. Explicit messages provide request/response-oriented network communication. Each request is typically directed at another data item. Explicit messages can be used to configure, monitor, and troubleshoot the switch.</p> <p>The Explicit Messaging interface is used by the Studio 5000 Logix Designer® application.</p>
Implicit messaging (I/O connections)	<p>I/O connections provide dedicated, special purpose communication paths between a producing application and one or more consuming applications. The application-specific I/O data that moves through these connections is typically a fixed, cyclical structure.</p> <p>The switch supports two I/O connection choices.</p> <ul style="list-style-type: none"> <li>• Input Only</li> <li>• Exclusive Owner</li> </ul> <p>Both connections are cyclic and adjustable from 300...5000 ms.</p> <p>The Input Only connection contains a data structure with status information on the switch in general and specific status on each of the ports. This connection is multicast. Multiple controllers can share the connection.</p> <p>The Exclusive Owner connection uses the same Input data structure as the Input Only connection, but adds an Output data structure. The Output data contains a bit for each port that lets you enable or disable each port separately. While the Input data on this connection can be shared via multicast by multiple controllers, only one controller can own the Output data. If a second controller attempts to open this connection, the connection is rejected.</p>

**IMPORTANT** Because the controller sends output data cyclically, the output data overrides attempts by other software tools or visualization stations to enable or disable a port.

## RSLinx Software and Network Who Support

The EtherNet/IP network interface supports the RSLinx® software RSWho feature. RSWho enables you to locate and identify your switch on the network by using the electronic data sheet (EDS) files.

To access the RSWho function, from the RSLinx software toolbar, choose Communications > RSWho.

---

**IMPORTANT** After using the RSWho feature, if you access the switch and view the Ethernet link counters, you see the counts for only the first port (Port Fe1/1).

---

## Electronic Data Sheet (EDS) Files

Electronic Data Sheet (EDS) files are text files that are used by network configuration tools, such as RSNetWorx™ for EtherNet/IP software. EDS files help you identify products and commission them on a network. EDS files contain details about the readable and configurable parameters of the device. They also provide information about the I/O connections the device supports and the content of the associated data structures.

If you are using the switch in a system without a Rockwell Automation Logix controller, you cannot use the add-on profile (AOP) supplied with Logix controllers. You must use information from the EDS files to configure the I/O connection.

EDS files for the Stratix switches are included with the following software packages:

- RSLinx software
- RSLogix 5000® software
- RSNetWorx for EtherNet/IP software

You can also obtain the EDS files in either of these two ways:

- By downloading it from <http://www.rockwellautomation.com/resources/eds/>.
- By using the RSLinx EDS Hardware Installation tool.

To upload the EDS files directly from the switch over the network, follow these steps.

1. From the Start menu, choose Programs > Rockwell Software > RSLinx > Tools > EDS Hardware Installation Tool.
2. To launch the EDS Wizard and add the selected hardware description and associated files, click Add.

## Data Accessible with CIP

The CIP interface enables you to access the information in [Table 2](#).

**Table 2 - Data Accessible with CIP**

Data Type	Details
Input data via I/O connection	<ul style="list-style-type: none"> <li>Link status per port: not connected, connected</li> <li>Unauthorized device per port: OK, not OK</li> <li>Unicast threshold that is exceeded per port: OK, exceeded</li> <li>Multicast threshold that is exceeded on each port: OK, exceeded</li> <li>Broadcast threshold that is exceeded on each port: OK, exceeded</li> <li>Port bandwidth utilization per port: value in %</li> <li>Alarm major: OK, tripped</li> <li>Multicast groups active: quantity</li> </ul>
Output data via I/O connection	Port disable per port: enabled, disabled
Other status data	<ul style="list-style-type: none"> <li>Module identification (vendor ID, device type, product code, product name, revision, serial number)</li> <li>Major/minor fault status, I/O connection, module identity match</li> <li>Active alarms</li> <li>Active faults</li> <li>Switch uptime since last restart</li> <li>Switch internal temperature in degrees Centigrade</li> <li>Power supply is present: yes, no</li> <li>Firmware release version</li> <li>CIP connection counters: open/close requests, open/close rejects, timeouts</li> <li>Port alarm status per port: OK, Link Fault, Not Forwarding, Not Operating, High Bit Error Rate</li> <li>Port fault status per port: Error Disable, Native VLAN Mismatch, MAC address Flap Condition, Security Violation</li> <li>Port diagnostic counters per port: Ethernet interface counters (10), Ethernet media counters (12)</li> <li>Link status</li> </ul>
Configuration data	<ul style="list-style-type: none"> <li>Major and minor revision of switch</li> <li>Electronic keying (Exact Match, Disable Keying)</li> <li>Connection (Input Data, Data)</li> <li>Data connection password</li> <li>Requested packet interval (RPI)</li> <li>Inhibit module</li> <li>Major fault on controller if connection fails while in Run mode</li> <li>Use unicast connections over EtherNet/IP</li> <li>Module fault display</li> <li>IP addressing method: Manual, DHCP</li> <li>IP address, subnet mask, primary and secondary DNS server address, default gateway (all if static)</li> <li>Host name</li> <li>Administration: contact name, geographic location</li> <li>Spanning Tree Mode (MST, RSTP)</li> <li>Port configuration per port: enable/disable, auto-negotiate, speed, duplex</li> <li>Smartports and VLANs: assign roles per port, VLAN ID and name</li> <li>Port security: enable, allowed MAC IDs per port, dynamic, static</li> </ul>
Smartport assignment per port	<ul style="list-style-type: none"> <li>Role</li> <li>VLAN</li> </ul>
Save and restore of switch configuration	Via File Obj

## Software Features

Switch software features can be configured in Device Manager, the Logix Designer application, or both:

- See [Configuration in Device Manager on page 27](#)
- See [Configuration in the Studio 5000 Environment on page 33](#)

Feature	Device Manager	Logix Designer
802.1X Authentication	•	—
Alarm Configuration	•	—
Alarm Monitoring	•	•
Dynamic Host Configuration Protocol (DHCP)	•	•
EtherChannels	•	•
Internet Group Management Protocol (IGMP Snooping with Querier)	•	—
Port Mirroring	•	—
Port Security	•	•
Quality of Service (QoS)	•	—
Simple Network Management Protocol (SNMP)	•	—
Smartports	•	•
Spanning Tree Protocol (STP)	•	—
Storm Control	•	—
Terminal Access Controller Access Control System Plus/Remote Authentication Dial-In User Service (TACACS+/RADIUS)	•	—
Virtual Local Area Networks (VLANs)	•	•

## Hardware Features

For technical specifications, see the Stratix Ethernet Device Specifications Technical Data, publication [1783-TD001](#).

Feature	Description
Power connector	You connect the power to the top panel of a switch. One connector provides DC power.
10/100 copper ports	<p>You can set the 10/100 copper ports to operate at 10 Mbps or 100 Mbps, full-duplex, or half-duplex. You can also set these ports for speed and duplex autonegotiation in compliance with IEEE 802.3-2002. The default setting is autonegotiate.</p> <p>When set for autonegotiation, the port senses the speed and duplex settings of the attached device. If the connected device also supports autonegotiation, the switch port negotiates the connection with the fastest line speed that both devices support. The port also negotiates full-duplex transmission if the attached device supports it. The port then configures itself accordingly. In all cases, the attached device must be within 100 m (328 ft) of the switch.</p>

**Notes:**

## Get Started

Topic	Page
Out-of-the-box Configuration	16
Express Setup Configuration	16
Configure Network Settings in Device Manager	22
Configure Network Settings in the Logix Designer Application	24
Configuration in Device Manager	27
Configuration in the Studio 5000 Environment	33
User Administration in Device Manager	40
Configuration Files	42
Software Updates	46
Access Management in Device Manager	48

You can install a Stratix® 2500 switch in your network in two ways:

- Use the out-of-the-box configuration. User-defined configuration is not required. See [Out-of-the-box Configuration on page 16](#).
- Use the Express Setup configuration. You can then configure and monitor the switch with software. See [Express Setup Configuration on page 16](#).

## Out-of-the-box Configuration

The out-of-the-box configuration for the switch provides these features:

- Configures Quality of Service (QoS) settings to prioritize EtherNet/IP, Precision Time Protocol (PTP), and industrial traffic. For more information about QoS, see [page 76](#).
- Enables Internet Group Management Protocol (IGMP) snooping with querier. For more information about IGMP with querier, see [page 69](#).

Management protocols (HTTPS and SNMP) are disabled with the out-of-the-box configuration. However, these protocols are enabled if you apply the Express Setup configuration to the switch.

You can install the switch in your network with no user-defined configuration.

## Express Setup Configuration

The Express Setup configuration for the switch provides the same features as the out-of-the-box configuration, as well as the following:

- Enables CIP
- Enables message logging (SYSLOG) and Simple Network Management Protocol (SNMP) notifications
- Enables Multiple Spanning Tree Protocol (MSTP), Bridge Protocol Data Unit (BPDU) Guard, BPDU Filter
- Encrypts administrator traffic during SNMP sessions and provides increased network security by enabling these protocols:
  - SNMPv3
  - HTTPS

The switch does not support Telnet and HTTP protocols.

Once you run Express Setup, you can complete configuration of the switch by using the Device Manager web interface or the Studio 5000 Logix Designer® application.



## Express Setup Button

Use the Express Setup button on the physical switch to perform Express Setup. The Express Setup button is recessed behind the front panel. To reach the button, use a small tool, such as a paper clip.



**WARNING:** When you press the Express Setup button while power is on, an electric arc can occur. This could cause an explosion in hazardous location installations.

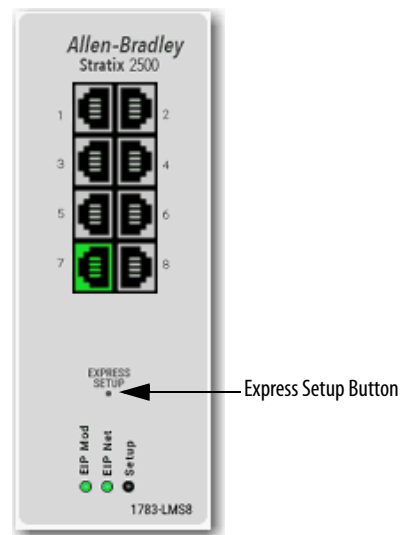

## Express Setup Modes

Express Setup has three modes:

---

**IMPORTANT** The Studio 5000 Logix Designer application supports only Medium-press mode.

---

- Short Press mode—Use a direct connection to enter the initial IP address of the switch. You can then configure additional network settings in Device Manager. To run Short Press mode, see [page 19](#).
- Medium Press mode—You can use a DHCP server to assign the switch an IP address. You can then configure additional network settings in Device Manager or the Logix Designer application. To run Medium Press mode, see [page 21](#).
- Long Press mode—Reset the switch to use factory default settings. To run Long Press mode, see [page 22](#).

Table 3 summarizes the function of each mode.

**Table 3 - Express Setup Modes**

Attribute	Short Press Mode	Medium Press Mode	Long Press Mode
Enable method	Press and hold the Express Setup button until the Setup status indicator flashes green during seconds 1...5, and then release.	Press and hold the Express Setup button until the Setup status indicator flashes red during seconds 6...10, and then release.	Press and hold the Express Setup button until the Setup status indicator flashes alternating green and red during seconds 16...20, and then release.
		Between seconds 11...15 and after 21 seconds, the Setup status indicator turns off. If you release the Express Setup button while the Setup status indicator is off, no Express Setup mode is enabled.	
Setup status indicator	Flashes green between seconds 1...5.	Flashes red between seconds 6...10.	Flashes green and red between seconds 16...20.
Function	<ul style="list-style-type: none"> <li>The Express Setup management interface is selected.</li> <li>The switch acts as a DHCP server on VLAN 1 with an address of 169.254.0.1.</li> <li>Once the DHCP session is successfully established, the switch assigns the computer an IP address of 169.254.0.2 on VLAN 1.</li> <li>The default login credentials are set to the following:                             <ul style="list-style-type: none"> <li>User name: [no user name/blank]</li> <li>Password: <b>switch</b></li> </ul> </li> <li>Express Setup parameters are completed in Device Manager.</li> </ul>	<ul style="list-style-type: none"> <li>A DHCP client request is sent out of all switch ports on VLAN 1.</li> <li>VLAN 1 is configured for the IP address that is returned by DHCP.</li> <li>The default login credentials are set to the following:                             <ul style="list-style-type: none"> <li>User name: [no user name/blank]</li> <li>Password: <b>switch</b></li> </ul> </li> <li>CIP is enabled on VLAN 1 with the CIP security password set to <b>switch</b>.</li> <li>Express Setup parameters are completed in Device Manager or the Logix Designer application.</li> </ul>	<ul style="list-style-type: none"> <li>All configuration settings in internal memory are reset to factory defaults.</li> <li>The switch restarts with factory default settings.</li> </ul>

### Express Setup Requirements

To run Express Setup in Short Press mode, do the following:

- Disable other networks in your system.
- Set your computer to determine its IP address automatically versus statically.
- Disable any static domain name servers (DNS).
- Disable any wireless interface on your computer.
- Disable browser proxy settings.
- Make at least one switch port available for Express Setup.

Confirm the following hardware and software requirements.

**Table 4 - Express Setup Hardware Requirements**

Component	Requirement
Processor	1 GHz or faster 32-bit (x86) or 64-bit (x64)
RAM	1 GB RAM (32-bit) or 2 GB RAM (64-bit)
Hard disk space	16 GB (32-bit) or 20 GB (64-bit)
Computer-to-switch connection (Required for Express Setup in Short Press mode)	Straight-through or crossover Category 5 Ethernet cable

**Table 5 - Express Setup Software Requirements**

Component	Requirement
Operating system	Microsoft Windows 7 or Windows 10
Web browser	Latest version of Internet Explorer™ or Firefox with JavaScript enabled. Express Setup verifies the browser version when starting a session, and it does not require a plug-in.

## Run Express Setup in Short Press Mode

The following conditions cause the switch to exit Short Press mode.

**Table 6 - Conditions Cause the Switch to Exit Short Press Mode**

Condition	Status Indicator Behavior
A non-default configuration exists on the switch.	The Setup status indicator turns red for 10 seconds.
You do not connect to the Express Setup port within 2 minutes from when the port status indicator flashes green.	The unconnected port status indicator and the Setup status indicator turn off.
No DHCP request is received for 2 minutes from when you connect to the Express Setup port.	The Setup status indicator turns red for 10 seconds.
No browser session is started for 2 minutes after an IP address is assigned to the computer.	The unconnected port status indicator and the Setup status indicator turn off.
You disconnect your computer from the switch before the setup process is complete.	All Express Setup temporary configurations, such as DHCP server, are removed.

To run Express Setup in Short Press mode, follow these steps.

1. Apply power to the switch.

When the switch powers on, it begins its power-on sequence. The power-on sequence can take as many as 45 seconds to complete.

2. Make sure that the power-on sequence has completed by verifying that the EIP Mod indicator is flashing green.

If the switch fails the power-on sequence, the EIP Mod status indicator turns red.

3. Press and hold the Express Setup button until the Setup status indicator flashes green during seconds 1...5, and then release.

The switch selects a port to use for Express Setup.

4. Connect a Category 5 Ethernet cable from the flashing switch port to the Ethernet port on a computer.

Once you connect the switch to the computer, the Setup status indicator and the status indicator for the port connected to the computer change from flashing green to solid green.

The switch acts as a DHCP server on VLAN 1 with the address of 169.254.0.1, and serves address 169.254.0.2 to the computer.

5. Access Device Manager by starting a web browser session and entering the switch IP address, 169.254.0.1. The default login credentials are:

- User name: [no user name/blank]
- Password: **switch**

For detailed steps about how to access Device Manager, see page [28](#).

---

**IMPORTANT** If the Device Manager window does not appear, try the following:

- Verify that your network adapter is set to accept a DHCP address.
  - Verify that any wireless interface is disabled on the computer.
  - Verify that any proxy settings or popup blockers are disabled on your browser.
  - Enter the URL of a well-known website in your browser to be sure that the browser is working correctly. Your browser then redirects to Device Manager.
- 

6. Proceed to [Configure Network Settings in Device Manager on page 22](#).

## Run Express Setup in Medium Press Mode

The following conditions cause the switch to exit Medium Press mode.

**Table 7 - Conditions Cause the Switch to Exit Medium Press Mode**

Condition	Status Indicator Behavior
A non-default configuration exists on the switch.	The Setup status indicator turns red for 10 seconds.
No DHCP response is received for 10 minutes from when the switch broadcast the request.	

---

**IMPORTANT** Before you begin, confirm that your system has a DHCP server configured to assign the switch an IP address.

---

To run Express Setup in Medium Press mode, follow these steps.

1. Apply power to the switch.  
When the switch powers on, it begins its power-on sequence. The power-on sequence can take as many as 45 seconds to complete.
2. Make sure that the power-on sequence has completed by verifying that the EIP Mod and Setup status indicators are flashing green:
  - If the switch fails the sequence, the EIP Mod status indicator turns red.
  - If you do not press the Express Setup button within 5 minutes after the sequence completes, the Setup status indicator turns off.
3. Press and hold the Express Setup button until the Setup status indicator flashes red during seconds 6...10, and then release:

---

**IMPORTANT** You must complete the switch setup within 60 minutes of releasing the Express Setup button. Otherwise, the switch exits Express Setup.

---

- The Setup status indicator flashes green during seconds 1...5, and then red during seconds 6...10.
  - The switch broadcasts a DHCP request out of all ports on VLAN 1.
  - VLAN 1 is configured with the IP address that is returned by the DHCP server.
  - The default login credentials are set to the following:
    - User name: [no user name/blank]
    - Password: **switch**
  - CIP is enabled on VLAN 1 with CIP security password set to **switch**.
4. Configure network settings:
    - To use Device Manager, see [page 22](#).
    - To use the Logix Designer application, see [page 24](#).

## Run Express Setup in Long Press Mode

**IMPORTANT** Long Press mode overwrites all existing configuration files in internal or external memory and resets the switch to use factory default settings.

Press and hold the Express Setup button until the Setup status indicator flashes alternating green and red during seconds 16...20, and then release.

Upon release of the Express Setup button, the switch restarts with factory default settings.

## Configure Network Settings in Device Manager

To configure network settings in Device Manager after you run Express Setup, follow these steps.

1. Access Device Manager, as described on [page 28](#).
2. On the Express Setup page, complete the fields that are described in [Table 8](#).

**▼ Network Settings**

Host Name:

Management Interface (VLAN):

IP Assignment Mode:  Static  DHCP

IP Address:  /

Default Gateway:

Primary DNS Server:

Secondary DNS Server:

NTP Server:

---

**▼ Advance Settings**

Enable CIP :

CIP VLAN :

IP Address :  /

Same as Management VLAN :

Security Timeout (in seconds) :  (Range: 1-3600 secs, Recommended: >= 300 secs.)

Security Password :  Confirm Security Password:

(leave it blank if no change)

Table 8 - Express Setup Fields—Device Manager

Field	Description
<b>Network Settings</b>	
Host Name	Enter a name for the switch within these guidelines: <ul style="list-style-type: none"> <li>• Cannot be longer than 63 characters</li> <li>• Cannot contain the characters <code>_,!,@,#,\$,%^,&amp;,&amp;*,*(,)</code></li> <li>• Cannot start with numbers followed by characters. Numbers can follow characters</li> </ul>
Management Interface (VLAN)	Choose the ID of the management VLAN through which the switch is managed. The management VLAN is the broadcast domain through which management traffic is sent between specific users or devices. It provides broadcast control and security for management traffic that must be limited to a specific group of users, such as the administrators of your network. It also provides secure administrative access to all devices in the network. Choose an existing VLAN as the management VLAN. The default management VLAN ID is 1. <b>IMPORTANT:</b> Be sure that the switch and your network management station are in the same VLAN. Otherwise, you lose management connectivity to the switch.
IP Assignment Mode	Click an IP Assignment mode to determine whether the switch IP information is manually assigned (static) or is automatically assigned by a Dynamic Host Configuration Protocol (DHCP) server. The default mode is Static. We recommend that you check Static and manually assign the IP address for the switch. You can then use the same IP address whenever you want to access Device Manager. If you check DHCP, the DHCP server automatically assigns an IP address, subnet mask, default gateway, primary and secondary DNS server to the switch. Unless restarted, the switch continues to use the DHCP-assigned information, and you are able to use the DHCP-assigned address to access Device Manager. For a manually-assigned IP address in a network that uses a DHCP server, the IP address cannot be within the range of addresses that the DHCP server assigns. Otherwise, IP address conflicts can occur between the switch and another device.
IP Address	(Editable only if the IP Assignment Mode is Static). Enter the IP address and associated subnet mask to assign to the switch: <ul style="list-style-type: none"> <li>• The IP address format is a 32-bit numeric address that is written as four numbers that are separated by periods. Each number can be from 0...255.</li> <li>• The subnet mask is the network address that identifies the subnetwork (subnet) to which the switch belongs. Subnets are used to segment the devices in a network into smaller groups. The default is 255.255.255.0.</li> </ul> <b>IMPORTANT:</b> If you run multi-mode Express Setup in Medium Press mode, the IP Address field displays the address that is received from the DHCP server. If you change the address, the connection drops. To re-establish the connection with the new address, close your web browser and go to the address you specified. Make sure that the IP address that you assign to the switch is not assigned to another device in your network. The IP address and the default gateway cannot be the same.
Default Gateway	(Editable only if the IP Assignment Mode is Static). Enter the IP address for the default gateway. A gateway is a router or a dedicated network device that enables the switch to communicate with devices in other networks or subnetworks. The default gateway IP address must be part of the same subnet as the switch IP address. The switch IP address and the default gateway IP address cannot be the same. If all of your devices are in the same network and a default gateway is not used, you do not need to enter an IP address in this field. If your network management station and the switch are in different networks or subnetworks, you must specify a default gateway. Otherwise, the switch and your network management station cannot communicate with each other.
Primary DNS Server	(Editable only if the IP Assignment Mode is Static). Enter the IP address of the primary Domain Name Service (DNS) server. The primary DNS server transforms host names into IP addresses.
Secondary DNS Server	(Editable only if the IP Assignment Mode is Static). Enter the IP address of the secondary Domain Name Service (DNS) server. The secondary DNS server is the backup for the primary DNS server.
NTP Server	Enter the IP address of the Network Time Protocol (NTP) server. NTP is a networking protocol for clock synchronization between computer systems over packet-switched, variable-latency data networks.
Admin User	(Appears only during initial setup in Short Press mode; not editable). The default user name is 'admin.' Once Express Setup is complete, you can manage user names and passwords from the User page under the Admin menu in Device Manager.
Password, Confirm Password	(Appears only during initial setup in Short Press mode). Enter a password for the user name 'admin.' Once Express Setup is complete, you can manage user names and passwords from the User page under the Admin menu in Device Manager. Enter a password within these guidelines: <ul style="list-style-type: none"> <li>• Must be at least eight alphanumeric characters long</li> <li>• Must contain an uppercase character, a lowercase character, a special character such as <code>@\$!*+ =_?&amp;</code>, and a number</li> <li>• Is case sensitive</li> <li>• Cannot contain a tab, nor space at the beginning or end</li> </ul>
Submit	Click when your changes to Express Setup fields are complete.
<b>Advanced Settings</b>	
Enable CIP	To enable CIP on a VLAN, check Enable CIP. You can specify the settings that are required for CIP or check Same As Management VLAN.

**Table 8 - Express Setup Fields—Device Manager (continued)**

Field	Description
CIP VLAN	(Editable only if Same as Management VLAN is not checked). Choose the VLAN on which to enable CIP. The CIP VLAN can be the same as the management VLAN or you can isolate CIP traffic on another VLAN that is already configured on the switch. For Short Press and Medium Press modes, enter the VLAN ID in the following format: VLAN<space>ID <b>EXAMPLE:</b> VLAN 136 For Long Press mode, choose a VLAN ID from the pull-down menu.
IP Address	(Editable only if Same as Management VLAN is not checked). If the CIP VLAN differs from the management VLAN, enter the IP address and subnet mask for the CIP VLAN. The format is a 32-bit numeric address that is written as four numbers that are separated by periods. Each number can be from 0 . . .255. Make sure that the IP address that you assign to this device is not being used by another device in your network.
Same As Management VLAN	To make the settings for the CIP VLAN the same as the management VLAN, check Same As Management VLAN. By default, the CIP VLAN settings are the same as the management VLAN settings. If you enable this option, the CIP VLAN and IP Address fields are auto-populated and cannot be edited.
Security Timeout	Enter the CIP security timeout. The range is 1 . . .3600. The default is 600 for Short Press and Medium Press modes.
Security Password, Confirm Security Password	Enter the password to use for the CIP security string. Enter a password within these guidelines: <ul style="list-style-type: none"> <li>• Must be at least eight alphanumeric characters long</li> <li>• Must contain an uppercase character, a lowercase character, a special character such as @\$!%*+=_?&amp;, and a number</li> <li>• Is case sensitive</li> <li>• Cannot contain a tab, nor space at the beginning or end</li> </ul> If you leave this field blank, the password from the initial setup is used by default.
Same as Admin Password	(Appears only during initial setup in Short and Medium Press modes). To use the password that is specified in the Admin User field under Network Settings as the CIP security password, check Same as Admin Password. If you enable this option, the Security Password and Confirm Security Password fields become unavailable.
Enable SSH	(Appears only during initial setup in Short and Medium Press modes). To allow Secure Shell (SSH) sessions on the switch, check Enable SSH. SSH provides a secure, remote connection to the switch. SSH provides more security for remote connections than Telnet does by providing strong encryption when a device is authenticated. Once Express Setup is complete, you can enable or disable SSH from the Access Management page under the Admin menu in Device Manager.

## Configure Network Settings in the Logix Designer Application

To configure network settings in the Logix Designer application after running Express Setup in Medium Press mode, follow these steps.

1. If you have not yet added the switch to a controller project, complete Steps [1...4](#) on [page 33](#).
2. Configure general properties, as described [page 34](#).  
Specify the IP address that is assigned to the switch by the DHCP server.
3. Go online with the controller, and then open the Module Properties dialog box for the switch.
4. In the navigation pane, click Switch Configuration.
5. Complete the fields that are described in [Table 9](#).



**Table 9 - Express Setup Fields—Logix Designer Application**

Field	Description
Internet Protocol (IP) Settings	<p>Click the method to use for assigning the switch an IP address:</p> <ul style="list-style-type: none"> <li>Manually Configure IP settings (default)—The switch uses a manually assigned, static IP address. If you manually assign the IP address of the switch and your network uses a DHCP server, the IP address cannot be within the range of addresses that the DHCP server assigns. Otherwise, IP address conflicts can occur between the switch and another device.</li> <li>Obtain IP settings automatically using DHCP—A Dynamic Host Configuration Protocol (DHCP) server automatically assigns the switch an IP address, subnet mask, and default gateway. Unless restarted, the switch continues to use the DHCP-assigned information.</li> </ul>
Physical Module IP Address	<p>Displays the IP address that is assigned to the switch by the DHCP server during Express Setup. This value must match the IP address on the General view. If you change the assigned IP address, make sure that the new IP address is not assigned to another device in your network. The IP address and the default gateway cannot be the same.</p> <p><b>IMPORTANT:</b> If you reconfigure your switch with another IP address, you can lose communication with the switch when you click Set. To correct this problem, you must return to the Express Setup and General view, set the new IP address, and download to the controller.</p>
Subnet Mask	<p>Displays the IP address that is assigned to the switch by the DHCP server during Express Setup. The subnet mask is the network address that identifies the subnetwork (subnet) to which the switch belongs. Subnets are used to segment the devices in a network into smaller groups. The subnet mask is a 32-bit number. Set each octet between 0 . . 255. The default is 255.255.255.0.</p>
Host Name	<p>Enter a name to identify the switch. The name can be up to 64 characters and can include alphanumeric and special characters (comma and dash).</p>
Gateway Address	<p>Displays the gateway address that is assigned to the switch by the DHCP server during Express Setup. A gateway is a router or a dedicated network device that enables the switch to communicate with devices in other networks or subnetworks. The default gateway IP address must be part of the same subnet as the switch IP address. The switch IP address and the default gateway IP address cannot be the same. If all of your devices are in the same network and a default gateway is not used, you do not need to enter an IP address in this field. This field is enabled only if the IP assignment mode is Static. If your network management station and the switch are in different networks or subnetworks, you must specify a default gateway. Otherwise, the switch and your network management station cannot communicate with each other.</p> <p><b>IMPORTANT:</b> Communication is disrupted when you change the gateway (IP) address.</p>
Network Time Protocol (NTP) Server	<p>Enter the IP address of the NTP server. NTP is a networking protocol for clock synchronization between computer systems over packet-switched, variable-latency data networks.</p>
User	<p>Displays the default user name: <b>Admin</b></p>

**Table 9 - Express Setup Fields—Logix Designer Application (continued)**

Field	Description
Password, Confirm Password	<p>Enter a password for the switch. To complete initial setup, you must change the password from the default password. The default password is switch.</p> <p>This password is also used as the Common Industrial Protocol (CIP) security password. You must provide a password to the switch to secure access to Device Manager.</p> <p>Enter a password within these guidelines:</p> <ul style="list-style-type: none"> <li>• Must be at least eight alphanumeric characters long</li> <li>• Must contain an uppercase character, a lowercase character, a special character such as @\$!%*+=_?&amp;, and a number</li> <li>• Is case sensitive</li> <li>• Cannot contain a tab, nor space at the beginning or end</li> </ul>
Management Interface (VLAN)	<p>Choose a management VLAN. The default management VLAN ID is 1.</p> <p>The management VLAN through which the switch is managed. The management VLAN is the broadcast domain through which management traffic is sent between specific users or devices. It provides broadcast control and security for management traffic that must be limited to a specific group of users, such as the administrators of your network. It also provides secure administrative access to all devices in the network.</p> <p><b>IMPORTANT:</b> Be sure that the switch and your network management station are in the same VLAN. Otherwise, you lose management connectivity to the switch.</p>

6. Click OK.

The switch initializes its configuration for typical industrial EtherNet/IP applications. You can then use the Logix Designer application for further configuration or exit the application.

7. Turn off power at the source, disconnect any cables to the switch, and install the switch in your network.

## Configuration in Device Manager

Device Manager is a web-based management tool for configuring, monitoring, and troubleshooting individual switches. You can display Device Manager from anywhere in your network through a web browser.

Device Manager displays real-time views of switch configuration and performance. It simplifies configuration tasks with features such as Smartports. It uses graphical, color-coded displays, including the front panel view, graphs, and animated indicators to simplify monitoring tasks. It provides alert tools to help you to identify and to solve networking problems.

**Table 10 - Device Manager Hardware Requirements**

Attribute	Requirement
Processor speed	1 GHz or faster (32 bit or 64 bit)
RAM	1 GB (32 bit) or 2 GB (64 bit)
Available hard disk space	16 GB (32 bit) or 20 GB (64 bit)
Number of colors	256
Resolution	1024 x 768
Font size	Small

**Table 11 - Device Manager Software Requirements**

Web Browser	Version
Microsoft Internet Explorer	Latest version with JavaScript enabled
Mozilla Firefox	Latest version with JavaScript enabled

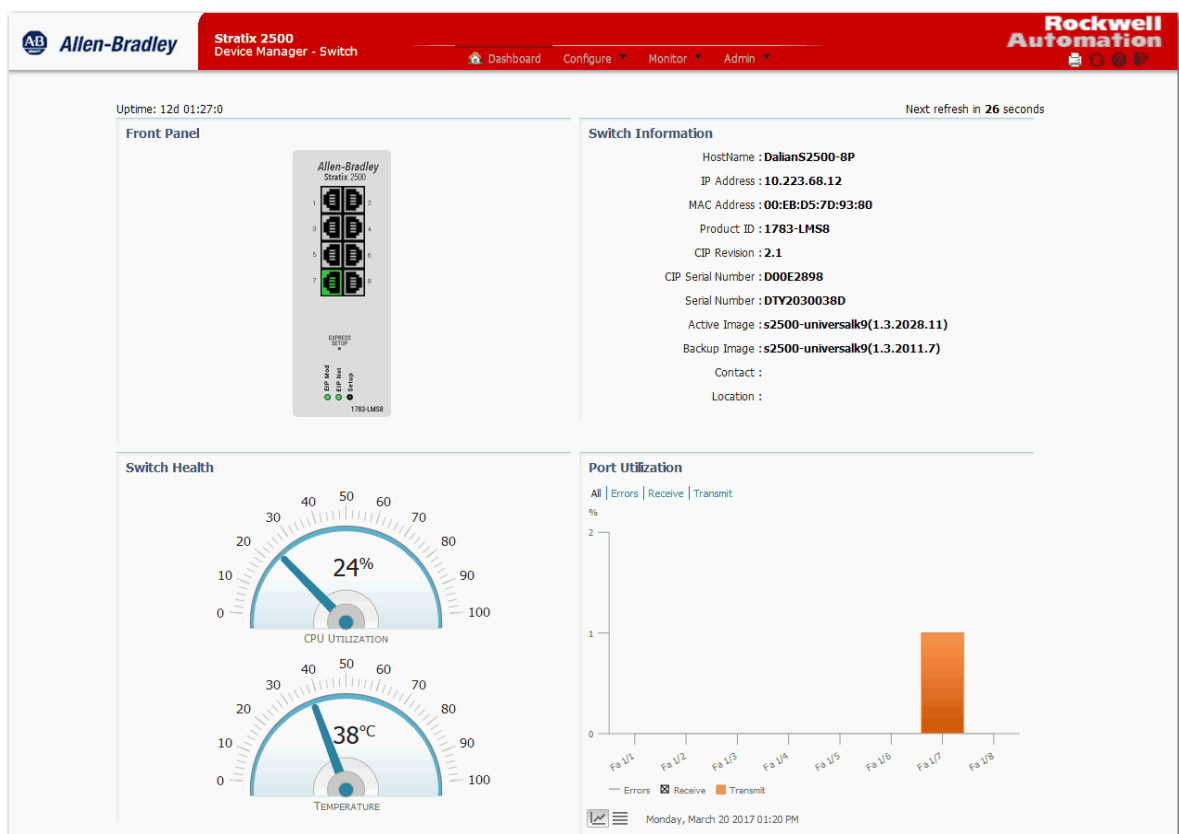

## Access Device Manager

Device Manager provides a secure connection with the latest version of Internet Explorer or Firefox. Security messages from your browser can appear when you access Device Manager.

To make sure that Device Manager runs properly, disable any pop-up blockers or proxy settings in your browser and any wireless clients on your computer. Device Manager verifies the browser version when starting a session to be sure that the browser is supported.

To access Device Manager, follow these steps.

1. Start a web browser session and go to the switch IP address, 169.254.0.1.
2. (Internet Explorer). If the following message appears, click Continue to this website.

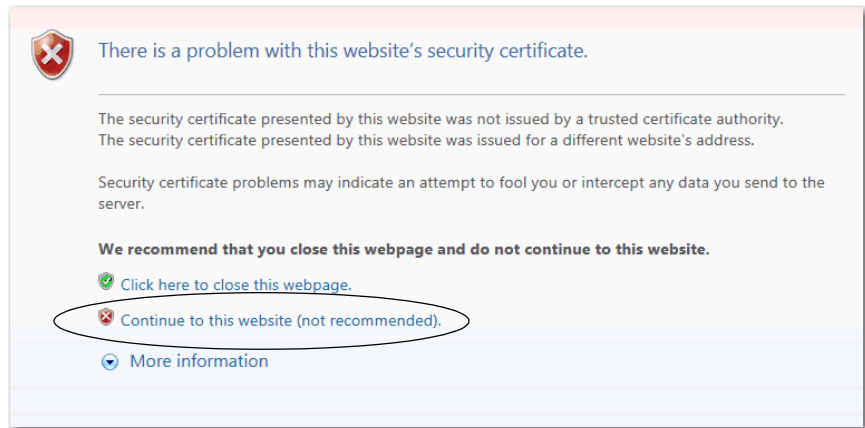

- (Firefox). If the following message appears, do the following:
- a. Click Advanced.

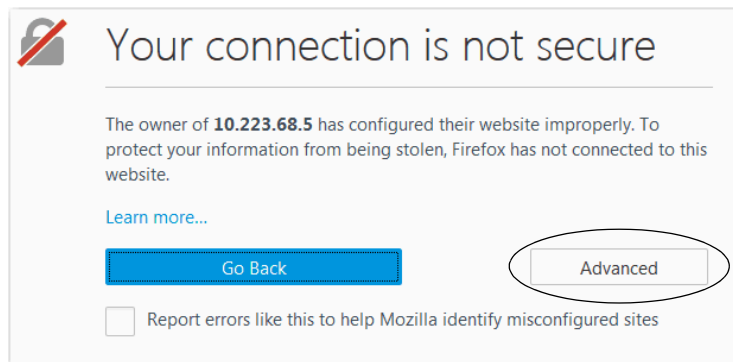

- b. Click Add Exception.

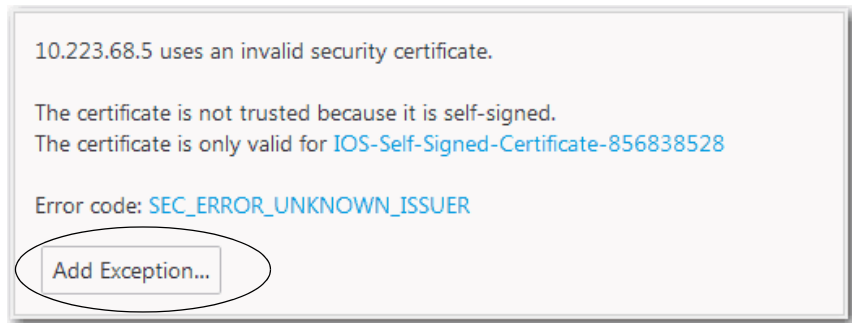

- c. Click Confirm Security Exception.

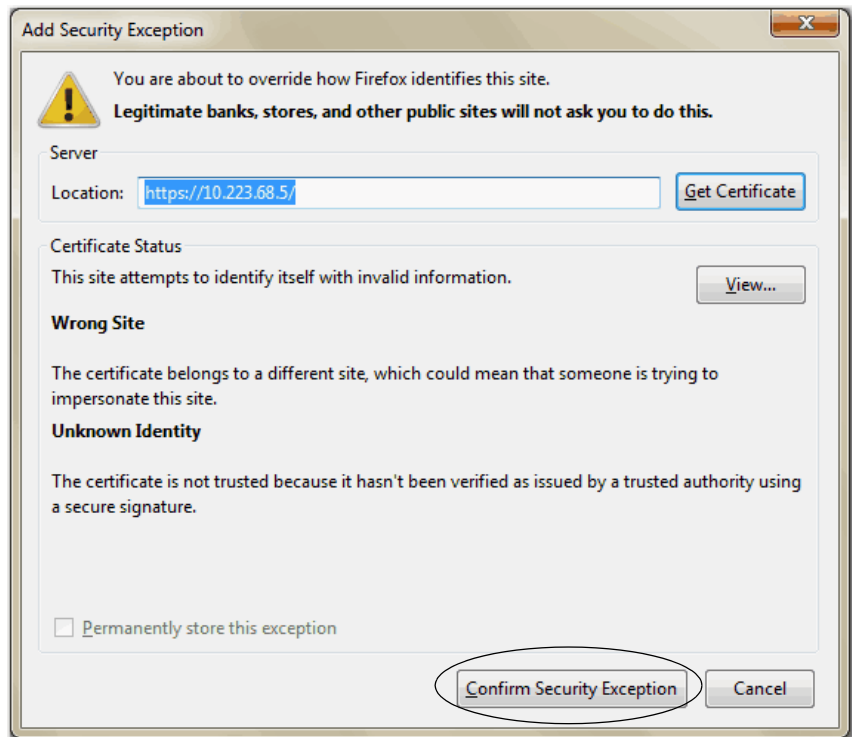

3. On the Device Manager Login, enter the switch name and password.

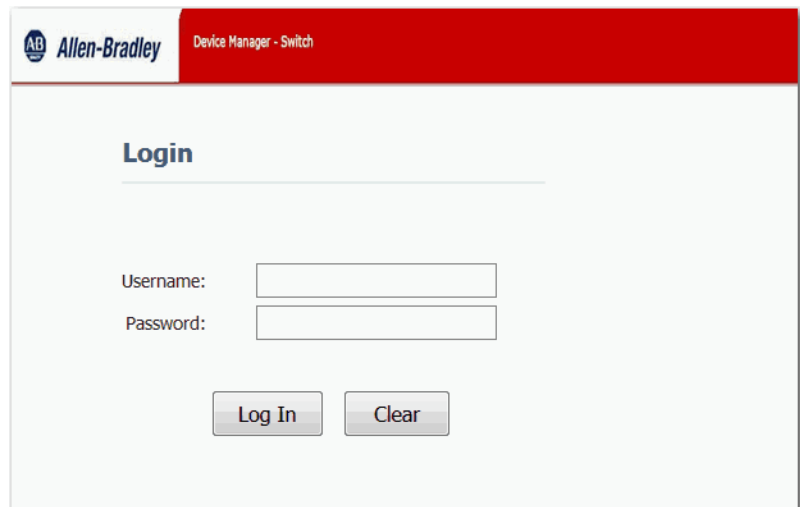

## Configure Port Settings

Port settings determine how data is sent and received between the switch and the connected device. You can change port settings based on your network needs or use them and to troubleshoot network problems. The settings on a switch port must be compatible with the port settings of the connected device.

To configure port settings, follow these steps.

1. From the Configure menu, under Network, choose Port Settings.
2. To disable a port automatically that encounters a link flap error, check Error Disable.

A link flap error occurs when an interface continually goes up and down more than 5 times in 10 seconds. A single link flap event includes the complete cycling up and down of the link.

3. To re-enable an interface automatically that is disabled by a link flap error, check Auto Recovery. After a specified timeout period, the re-enable occurs.

Auto Recovery is editable only if you check Error Disable.

4. To disable a port automatically that encounters a DHCP rate limit error, check Error Disable.

A DHCP rate limit error occurs when the rate of DHCP packets per second rate exceeds the value set for the port. This value is set in the DHCP Port Configurations tab. See [Table 26](#).

5. To re-enable an interface automatically that is disabled by a DHCP rate limit error, check Auto Recovery. After a specified timeout period, the re-enable occurs.

Auto Recovery is editable only if you check Error Disable.

6. In the Recovery Interval field, enter the number of seconds for a port with a link flap error, or DHCP rate limit error, to remain disabled before the Auto Recovery feature re-enables the port.

Valid values are 30...86400 seconds. The default recovery interval is 300 seconds.

7. Click Submit.
8. To edit basic settings for a specific port, click the radio button next to the port name and click Edit.
9. Edit the fields on the Edit Physical Port dialog box and click OK.

### Edit Physical Port ✖

Port Name

MTU  (Range: 1518-1998 bytes)

Administrative  Enable

Speed

Duplex

---

Administrative Mode

Access VLAN

Allowed VLAN  All VLANs  
 VLAN IDs  (e.g., 2,4)

Native VLAN

For more information about a field on the Port Settings page or Edit Physical Port dialog box, see [Table 12 on page 32](#).

**Network | Port Settings**

Link Flap : **Error Disable**  **Auto Recovery**

DHCP rate limit:

Recovery Interval:  seconds

---

**Edit**

	Port Name	MTU	Port Status	Speed	Duplex	Media Type	Access VLAN	Administrative Mode
<input type="radio"/>	Fa 1/1	1998	<input type="radio"/>	Auto	Auto	10/100BaseTX	3680	access
<input type="radio"/>	Fa 1/2	1998	<input type="radio"/>	Auto	Auto	10/100BaseTX	3680	access
<input type="radio"/>	Fa 1/3	1998	<input type="radio"/>	Auto	Auto	10/100BaseTX	3680	access
<input type="radio"/>	Fa 1/4	1998	<input type="radio"/>	Auto	Auto	10/100BaseTX	3680	access
<input type="radio"/>	Fa 1/5	1998	<input checked="" type="radio"/>	100Mbps	Full	10/100BaseTX	3680	access

**Table 12 - Port Settings**

Field	Description
Port Name	Displays the port type (Fa for Fast Ethernet) and number.
MTU	The Maximum Transmission Unit (MTU) of the port. The range is 1518 . . . 1998 bytes. The default is 1998. MTU sizes larger than 1518 are jumbo frames.
Administrative	(Appears only on the Edit Physical Port dialog box). Indicates whether the port is enabled or disabled: <ul style="list-style-type: none"> <li>• Checked—The port is enabled.</li> <li>• Cleared—The port is disabled.</li> </ul> By default, all ports are enabled.
Port Status	(Appears only on the Port Settings page; not editable). The state of the switch port: <ul style="list-style-type: none"> <li>• Green—Link is up.</li> <li>• Gray—No link or not connected.</li> <li>• Brown—Link is administratively shut down.</li> </ul>
Speed	The operating speed of the switch port: <ul style="list-style-type: none"> <li>• 10 Mbps</li> <li>• 100 Mbps</li> <li>• Auto—Enables a connected device to negotiate the link speed.</li> </ul> The default speed is Auto.
Duplex	The Duplex mode of the switch port: <ul style="list-style-type: none"> <li>• Auto (autonegotiation)—The connected device can negotiate the duplex setting with the switch. If the port is not connected or has not completed negotiation, the status is Auto.</li> <li>• Full (Full-duplex mode)—Both devices can send data simultaneously.</li> <li>• Half (Half-duplex mode)—The connected device must alternate sending or receiving data. Both devices cannot send data simultaneously.</li> </ul> The default is Duplex mode is Auto. We recommend that you use the default so that the duplex setting on the switch port automatically matches the setting on the connected device. Change the Duplex mode on the switch port if the connected device requires a specific mode. An example of when to change this setting is during troubleshooting. If you are troubleshooting a connectivity problem, you can change this setting to verify if the switch port and connected device have a duplex mismatch.
Administrative Mode	The administrative mode of the port: <ul style="list-style-type: none"> <li>• Access—The interface is in permanent non-trunk mode and negotiates to convert the neighboring link into a non-trunk link even if the neighboring interface is a trunk interface. If you choose this option, also choose an Access VLAN. Access ports have the following characteristics: <ul style="list-style-type: none"> <li>– Member of exactly one VLAN (the Access VLAN). The Access VLAN is 1 by default.</li> <li>– Accepts untagged frames only.</li> <li>– Discards all frames that are not classified to the Access VLAN.</li> <li>– On egress, all frames are transmitted untagged.</li> </ul> </li> <li>• Trunk—The interface is in permanent trunk mode and negotiates to convert the neighboring link into a trunk link even if the neighboring interface is not a trunk interface. If you choose this option, also choose whether to allow All VLANs or specified VLAN IDs. Trunk ports have the following characteristics: <ul style="list-style-type: none"> <li>– By default, a trunk port is member of all VLANs (1 . . . 4094).</li> <li>– Limit the VLANs that a trunk port is a member of by using Allowed VLANs.</li> <li>– Frames that are classified to a VLAN that the port is not a member of are discarded.</li> <li>– By default, all frames except frames that are classified to the Port VLAN (the Native VLAN) get tagged on egress. Frames that are classified to the Port VLAN do not get C-tagged on egress.</li> <li>– Egress can be changed to tag all frames, in which case only tagged frames are accepted on ingress.</li> </ul> </li> <li>• Hybrid—Similar to a trunk port, with the default configuration being VLAN tag unaware.</li> </ul> The default administrative mode is Access.
Access VLAN	The VLAN that an interface belongs to and carries traffic for, when the link is configured as or is acting as a nontrunking interface.
Allowed VLAN	(Appears only on the Edit Physical Port dialog box). The VLAN or VLANs for which the interface handles traffic when the link is configured as or is dynamically acting as a trunking interface. To allow traffic on all available VLANs, click All VLANs. To limit traffic to specific VLANs, click VLAN IDs and enter the VLAN numbers.
Native VLAN	(Appears only on the Edit Physical Port dialog box). The VLAN that transports untagged packets.



## Configuration in the Studio 5000 Environment

You can manage the switch by using the Logix Designer application in the Studio 5000® environment. The Logix Designer application is IEC 61131-3 compliant and offers relay ladder, Structured Text, Function Block Diagram, and Sequential Function Chart editors for you to develop application programs.

To add the switch to a controller project in the Logix Designer application, follow these steps.

---

**IMPORTANT** These steps are required before you can go online to configure and monitor the switch. You must be online to view and configure most switch parameters in the Logix Designer application.

---

1. Open the project file for the controller to monitor the switch.
2. Right-click Ethernet and choose New Module.

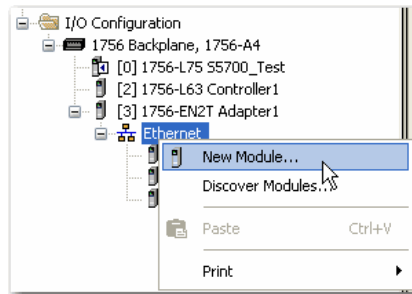

3. On the Select Module Type dialog box, select the switch and click Create.

If you do not see the switch on the list, you can obtain the AOP from the Rockwell Automation support website:

<http://www.rockwellautomation.com/support/>

## General Properties

To configure general properties, follow these steps.

1. In the navigation pane, click General.
2. Complete the fields, and then click Apply.

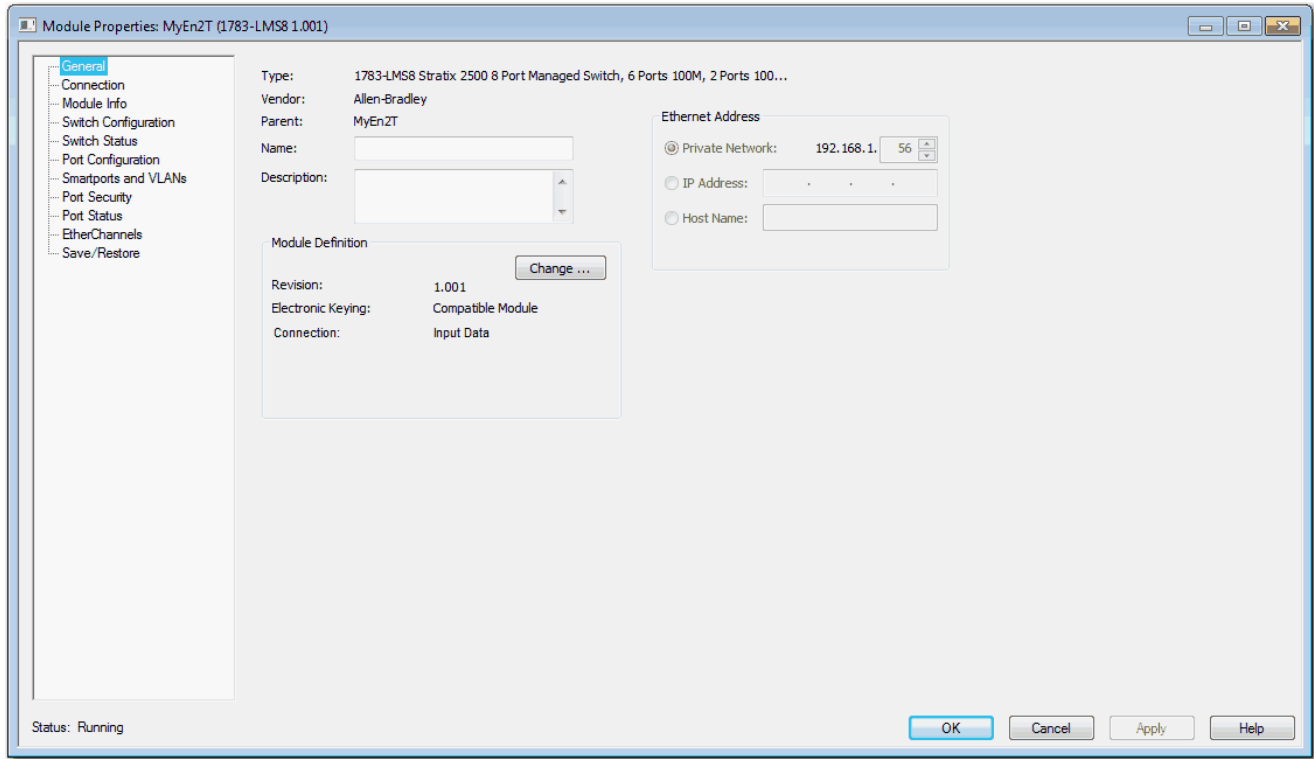

**IMPORTANT** The IP address and host name must match the values that you used during Express Setup. On the Module Properties dialog box, you can choose either an IP address or host name.

**Table 13 - General Fields**

Field	Description
Name	Enter a name to identify the switch.
Description	Enter a description for the switch.
Ethernet Address	Displays the IP address or host name for the switch that was specified during Express Setup. <ul style="list-style-type: none"> <li>• Private Network—The IP address of your private network.</li> <li>• IP Address—The IP address that was specified during Express Setup.</li> <li>• Host Name—The host name that was specified during Express Setup. The host name requires that you have a DNS server that is configured on the network for the Ethernet interface module of the controller.</li> </ul>

3. In the Module Definition area, click Change.
4. On the Module Definition dialog box, complete the fields and click OK.

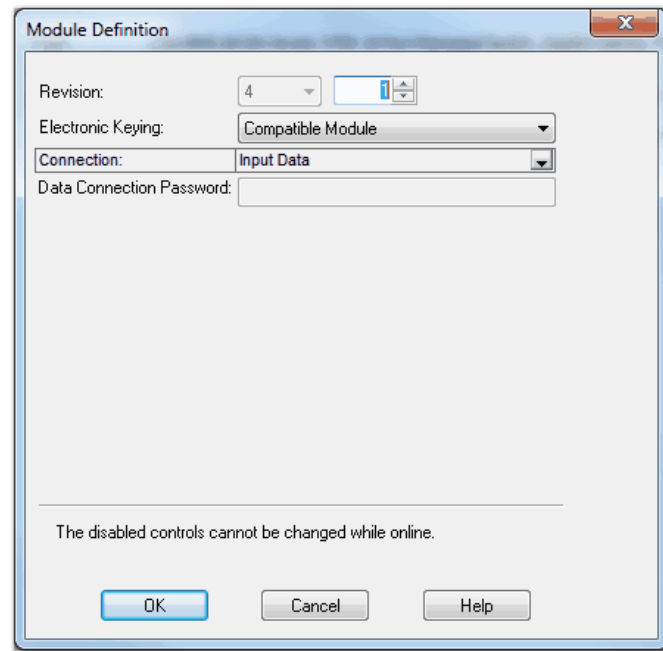
**Table 14 - Module Definition Fields**

Field	Description
Revision	The major and minor revision of the switch: <ul style="list-style-type: none"> <li>• Major revision: 1...128</li> <li>• Minor revision: 1...255</li> </ul>
Electronic Keying	Choose one of the following: <ul style="list-style-type: none"> <li>• Compatible Module (default)</li> <li>• Exact Match</li> <li>• Disable Keying</li> </ul>
Connection	Choose one of the following: <ul style="list-style-type: none"> <li>• Input Data (default): Enables only an input data connection.</li> <li>• Data: Enables an input and output data connection.</li> </ul> <p><b>ATTENTION:</b> This selection enables output tags, which can disable ports and interrupt connections to and through the switch. You can disable a switch port by setting the corresponding bit in the output tag. The output bits are applied every time that the switch receives the output data from the controller when the controller is in Run mode. When the controller is in Program mode, the output bits are not applied. If the corresponding output bit is 0, the port is enabled. If you enable or disable a port by using Device Manager, the port setting is overridden by the output bits from the controller on the next cyclic update of the I/O connection. The output bits always take precedence.</p>
Data Connection Password	(Data connections only). Enter the password for accessing the switch. Enter a password within these guidelines: <ul style="list-style-type: none"> <li>• Must be at least eight alphanumeric characters long</li> <li>• Must contain an uppercase character, a lowercase character, a special character such as @\$!%*+=_?&amp;, and a number</li> <li>• Is case sensitive</li> <li>• Cannot contain a tab, nor space at the beginning or end</li> </ul>

## Connection Properties

To configure connection properties, follow these steps.

1. In the navigation pane, click Connection.
2. Complete the fields, and then click Apply.

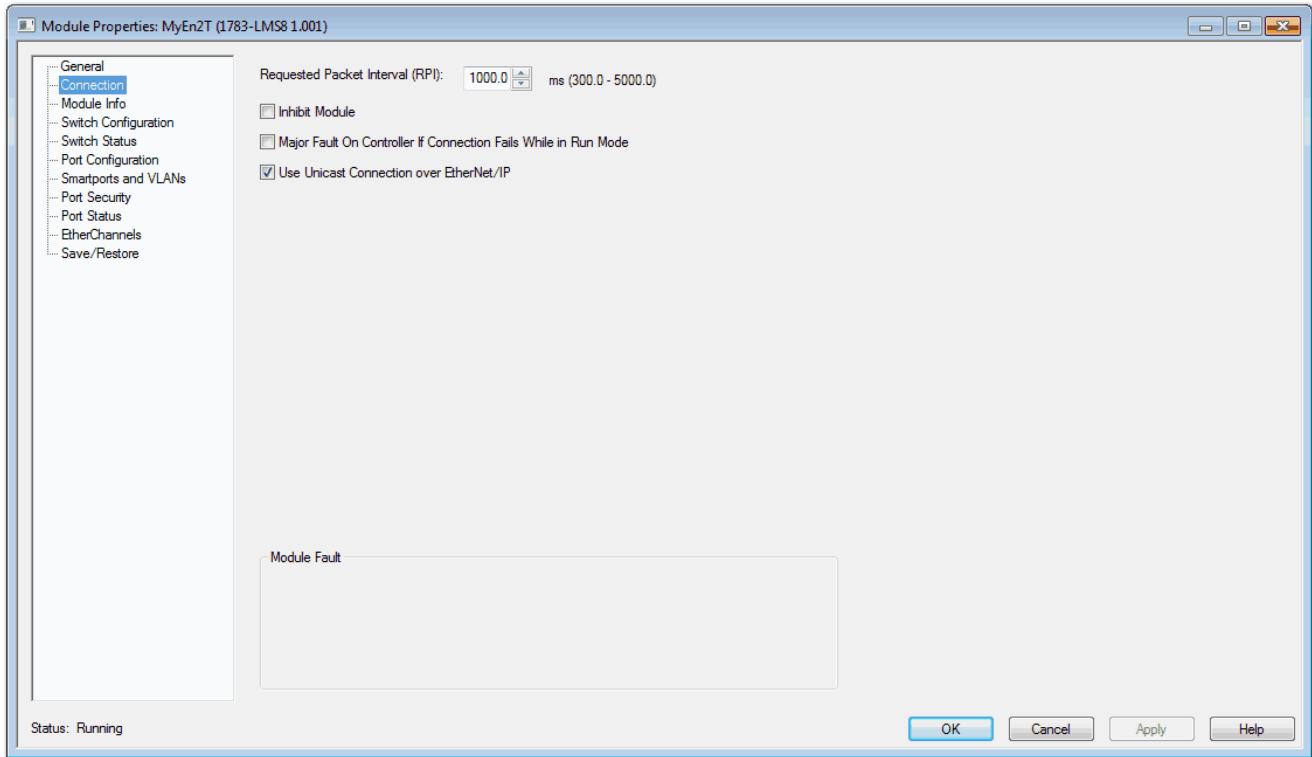

**Table 15 - Connection Fields**

Field	Description
Requested Packet Interval (RPI)	Enter the period in milliseconds at which data updates over a connection. For example, an input module sends data to a controller at the RPI that you assign to the module. Valid range: 300 . . 5000 ms
Inhibit Module	To disable communication between the controller and the switch, check Inhibit Module. Clear Inhibit Module to restore communication.
Major Fault on Controller If Connection Fails While in Run mode	To have the controller create a major fault if connection fails in Run mode, check the checkbox.
Use Unicast Connections over EtherNet/IP	To use Unicast connections with the EtherNet/IP network, check the checkbox.
Module Fault	Displays the fault code from the controller and the text that indicates the module fault has occurred.

## Switch Configuration

On the Switch Configuration view, you can do the following:

- Change switch IP settings
- Enter contact geographic location information for the switch
- View the management VLAN for the switch

To configure switch IP and administrative settings, follow these steps.

1. In the navigation pane, click Switch Configuration.
2. Complete the fields that are described in [Table 16 on page 38](#).
3. Click Set.

The screenshot shows a window titled "Module Properties: MyEn2T (1783-LMS8 1.001)". The left navigation pane is expanded to "Switch Configuration". The main content area is titled "Switch Configuration" and contains the following sections:

- Internet Protocol (IP) Settings**
  - Manually Configure IP settings
  - Obtain IP settings automatically using DHCP
- IP Settings Configuration**
  - Physical Module IP Address: 192 . 168 . 1 . 56
  - Subnet Mask: 255 . 255 . 255 . 0
  - Gateway Address: 0 . 0 . 0 . 0
  - Domain Name: [Empty]
  - Primary DNS Server Address: 0 . 0 . 0 . 0
  - Host Name: Switch1234567890123456
  - Secondary DNS Server Address: 0 . 0 . 0 . 0
- Administration**
  - Contact: [Empty]
  - Geographic Location: [Empty]
  - Management Interface VLAN: 1

At the bottom right, there is a "Refresh Communication" link, a "Set" button with a left arrow, and a "Status: Running" indicator at the bottom left. At the very bottom, there are "OK", "Cancel", "Apply", and "Help" buttons.

Table 16 - Switch Configuration Fields

Field	Description
Internet Protocol (IP) Settings	<p>Click the method to use for assigning the switch an IP address:</p> <ul style="list-style-type: none"> <li>Manually Configure IP settings (default)—The switch uses a manually assigned, static IP address. If you manually assign the IP address of the switch and your network uses a DHCP server, the IP address cannot be within the range of addresses that the DHCP server assigns. Otherwise, IP address conflicts can occur between the switch and another device.</li> <li>Obtain IP settings automatically using DHCP—A Dynamic Host Configuration Protocol (DHCP) server automatically assigns the switch an IP address, subnet mask, and default gateway. Unless restarted, the switch continues to use the DHCP-assigned information.</li> </ul> <p>We recommend that you manually assign the IP address for the switch. You can then use the same IP address whenever you want to access the switch.</p>
Physical Module IP Address	<p>Displays the IP address that is assigned to the switch by the DHCP server during Express Setup. This value must match the IP address on the General view. If you change the assigned IP address, make sure that the new IP address is not assigned to another device in your network. The IP address and the default gateway cannot be the same.</p> <p><b>IMPORTANT:</b> If you reconfigure your switch with another IP address, you can lose communication with the switch when you click Set. To correct this problem, you must return to the Express Setup and General view, set the new IP address, and download to the controller.</p>
Subnet Mask	<p>Displays the IP address that is assigned to the switch by the DHCP server during Express Setup. The subnet mask is the network address that identifies the subnetwork (subnet) to which the switch belongs. Subnets are used to segment the devices in a network into smaller groups. The subnet mask is a 32-bit number. Set each octet between 0 . . . 255. The default is 255.255.255.0.</p>
Gateway Address	<p>Displays the gateway address that is assigned to the switch by the DHCP server during Express Setup. A gateway is a router or a dedicated network device that enables the switch to communicate with devices in other networks or subnetworks. The default gateway IP address must be part of the same subnet as the switch IP address. The switch IP address and the default gateway IP address cannot be the same.</p> <p>If all of your devices are in the same network and a default gateway is not used, you do not need to enter an IP address in this field. This field is enabled only if the IP assignment mode is Static.</p> <p>If your network management station and the switch are in different networks or subnetworks, you must specify a default gateway. Otherwise, the switch and your network management station cannot communicate with each other.</p> <p><b>IMPORTANT:</b> Communication is disrupted when you change the gateway (IP) address.</p>
Primary DNS Server Address	<p>(Required for DNS addressing). Enter the addresses to identify any DNS servers in the network. You must configure a DNS server if you specify a domain name or a host name. The DNS server converts the domain name or host name to an IP address that the network uses.</p>
Secondary DNS Server Address	
Domain Name	<p>(Required for DNS addressing). Enter a domain name to identify the domain in which the switch resides.</p> <p>A domain name is part of a text address. The full text address of a module is host_name.domain_name. The domain name has a 48-character limit. If you specify a DNS server, you must enter a domain name.</p>
Host Name	<p>(Required for DNS addressing). Enter a host name to identify the host for the switch. A host name is part of a text address. The full text address of a module is host_name.domain_name.</p>
Contact	<p>Enter contact information for the switch, up to 200 characters. The contact information can include alphanumeric and special characters (dash and comma) and a carriage return.</p>
Geographic Location	<p>Enter a geographic location of the switch, up to 200 characters. The geographic location can include alphanumeric and special characters (dash and comma) and a carriage return.</p>
Management Interface VLAN	<p>Displays the VLAN through which the switch is managed. The management VLAN is the broadcast domain through which management traffic is sent between specific users or device. It also provides secure administrative access to all devices in the network.</p> <p><b>IMPORTANT:</b> Be sure that the switch and your network management station are in the same VLAN. Otherwise, you lose management connectivity to the switch.</p>

## Port Configuration

Configure ports to specify how data is sent and received between the switch and a connected device.

To configure ports, follow these steps.

1. In the navigation pane, click Port Configuration.
2. Complete the fields, and click Set.

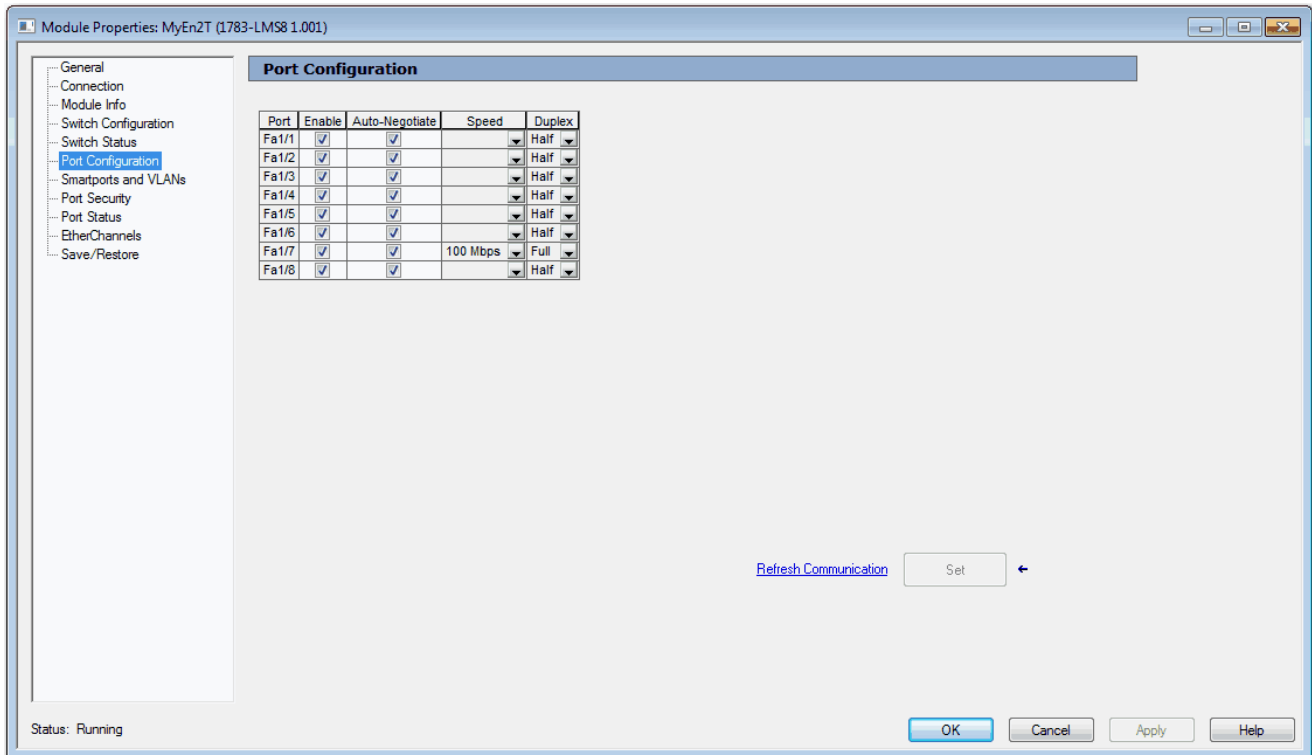
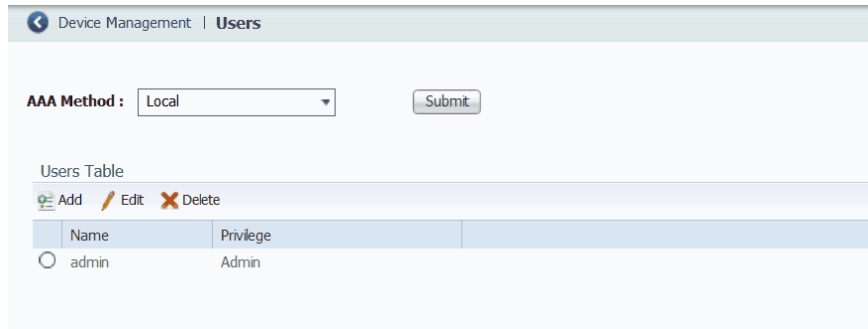

**Table 17 - Port Configuration Fields**

Field	Description
Port	Displays the port type (Fa for Fast Ethernet) and number.
Enable	To enable the port, check Enable. To disable the port manually, clear the Enable checkbox. If the port is not in use and is not attached to a device, we recommend that you disable the port. You can troubleshoot a suspected unauthorized connection by manually disabling the port.
Auto-Negotiate	If you want the port and end-device to auto-negotiate the link speed and Duplex mode, check Auto-Negotiate. To specify the port speed and Duplex mode manually, clear the Auto-Negotiate checkbox. We recommend that you use the default (auto-negotiate) so that the speed and duplex settings on the switch port match the setting on the connected device. Change the switch port speed and duplex if the connected device requires a specific speed and duplex. If you set the speed and duplex for the switch port, the connected device must be configured for the same speed and duplex and not set to auto-negotiate. Otherwise, a speed/duplex mismatch occurs.
Speed	Choose the operating speed of the port: <ul style="list-style-type: none"> <li>• 10 Mbps</li> <li>• 100 Mbps</li> </ul>
Duplex	Choose one of these Duplex modes: <ul style="list-style-type: none"> <li>• Half-duplex—Both devices cannot send data simultaneously.</li> <li>• Full-duplex—Both devices can send data simultaneously.</li> </ul>

## User Administration in Device Manager

From the Admin menu, under Device Management, choose Users.



Users are validated based on the Authentication, Authorization, and Accounting (AAA) method chosen from the pull-down menu. Click Submit after choosing the desired method. See [Terminal Access Controller Access Control System Plus/Remote Authentication Dial-In User Service \(TACACS+/RADIUS\) on page 97](#) for server configuration information.

**Table 18 - AAA Method Pull-down Menu**

Field	Description
Local	Use the local user database that is configured on the device. Local is the default setting.
Tacacs -> Local	Use the TACACS server. Use the local user database if the TACACS server is unavailable.
Radius -> Local	Use the RADIUS server. Use the local user database if the RADIUS server is unavailable.

You can add, edit, or delete users for the switch:

- To add a user, click Add. Complete the fields that are described in [Table 19](#) and click OK.
- To edit a user, click the radio button next to the user and click Edit. Edit the fields that are described in [Table 19](#) and click OK.
- To delete a user, click the radio button next to the user and click Delete.

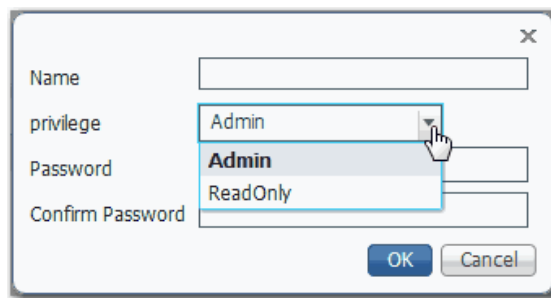



**Table 19 - Add/Edit User Fields**

<b>Field</b>	<b>Description</b>
Name	Enter a unique user name. The user name cannot contain spaces.
Privilege	Choose the level of access for the user: <ul style="list-style-type: none"><li>• Admin—Users can view and change all switch parameters.</li><li>• ReadOnly—Users can only view switch status and monitoring information. Users cannot view configuration information, view administration information, or make changes to the switch.</li></ul>
Password	Enter the password that is required for access with this user name.
Confirm Password	Enter a password within these guidelines: <ul style="list-style-type: none"><li>• Must be at least eight alphanumeric characters long</li><li>• Must contain an uppercase character, a lowercase character, a special character such as @\$!%*+=_?&amp;, and a number</li><li>• Is case sensitive</li><li>• Cannot contain a tab, nor space at the beginning or end</li></ul>

## Configuration Files

When any changes are made to the switch configuration, the changes immediately take effect in the running configuration file. Device Manager and the Logix Designer application automatically save changes to internal memory to be retained for the next power-on cycle. You can move configuration files to or from the switch.

### Manage Configuration Files in Device Manager

Device Manager uses Trivial File Transfer Protocol (TFTP) or Hypertext Transfer Protocol (HTTP) for the file transfer.

The following configuration files are available for transfer:

- **running-config**—Stores the running configuration of the switch. Available for upload and download.
- **startup-config**—Stores the start-up configuration of the switch. Available for download only.

#### Upload a File

To upload the running-config file to the switch, follow these steps.

1. From the Admin menu, under File Management, choose Load/Save.
2. If the file is on your local computer, click Browse, select the file, and then click Upload.

or

If the file is on a remote TFTP server, in the TFTP Address and File location fields, enter the IP address of the server and the path to the file. Click Upload.

The configuration file must be named running-config to replace the existing file.

▼ **Upload a file to device**

Select a configuration file:  No file selected.

(OR)

TFTP Address:  File location:

\*Configuration file must be named 'running-config' to replace the existing file

### Download a File

To download a running-config or startup-config file, follow these steps.

1. From the Admin menu, under File Management, choose Load/Save.
2. If the file is on your local computer, from the Select a configuration file pull-down menu, choose the configuration file to download, and then click Download.

or

If the file is on a remote TFTP server, in the TFTP Address and File location fields, enter the IP address of the server and the path to the file. Click Download.

---

**IMPORTANT** After you have completed this download, you must save the running configuration without restarting the switch as shown on page [130](#). Saving the running configuration without restarting the switch maintains the configuration through the next power cycle.

---

▼ Download configuration files from booting device

Select a configuration file:

(OR)

TFTP Address:  File location:

\*Download configuration files must be named 'running-config' or 'startup-config'

## Manage Configuration Files in the Logix Designer Application

In the Logix Designer application, you can save and restore the following two configuration files:

- Text file with switch configuration parameters (config.text)
- Binary file with VLAN information (vlan.dat)

Be prepared to enter a valid switch password. Enter a password within these guidelines:

- Must be at least eight alphanumeric characters long
- Must contain an uppercase character, a lowercase character, a special character such as @\$!%\*+=\_?&, and a number
- Is case sensitive
- Cannot contain a tab, nor space at the beginning or end

To save and restore configuration files, follow these steps.

1. In the navigation pane, click Save/Restore:
  - To replace the configuration files in the controller project with the configuration files on the switch, click Upload.
  - To replace the configuration files on the switch with the configuration files in the controller project, click Download.
  - To restore the configuration files in the controller project with files on your local computer, click Import.
  - To save the configuration files in the controller project to your local computer, click Export.
2. Click OK.

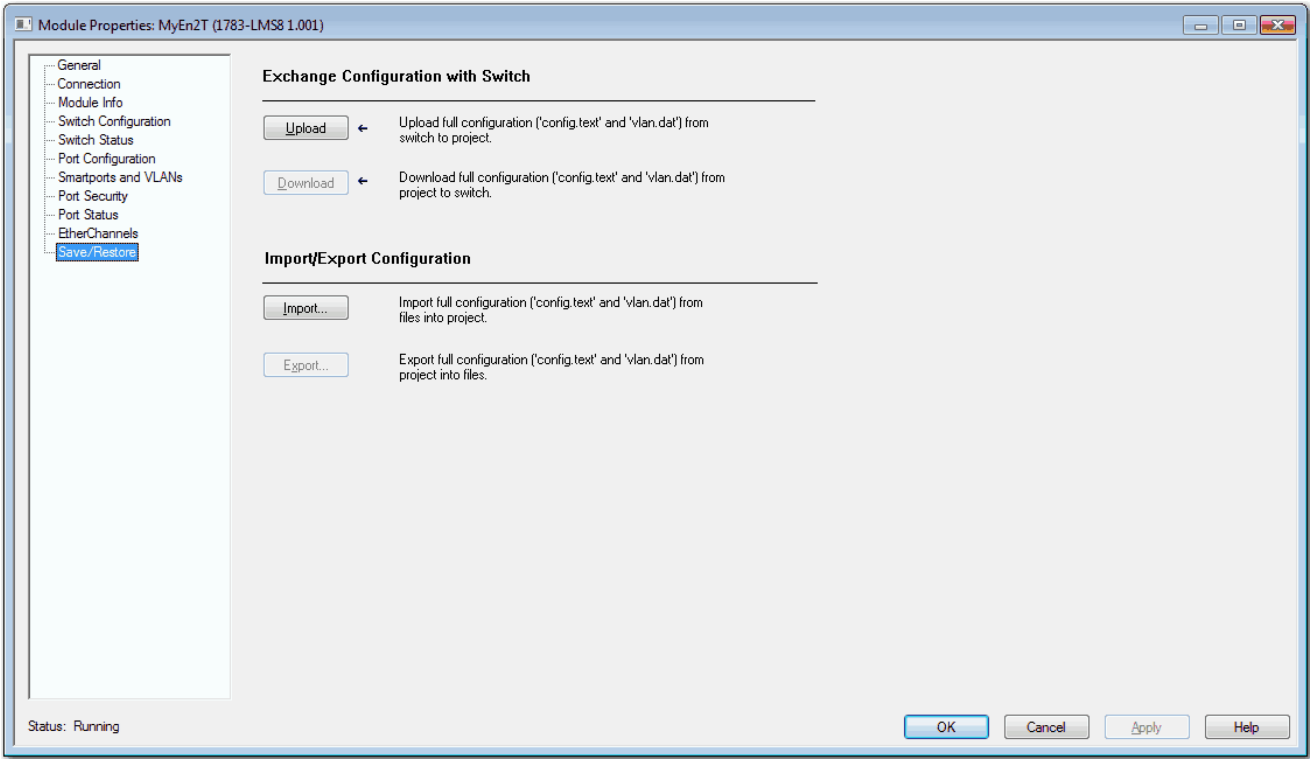

## Software Updates

You can download the latest software for all switches from <http://www.rockwellautomation.com>.

In Device Manager, you can do the following with the firmware file:

- Use TFTP to transfer the file to the switch
- Use HTTP to download the file to your personal computer or a network drive, and then select it for the update.
- Swap to a backup image file.

The Software Update page shows the following information:

- Active Image—Version of the software that is currently installed on the switch.
- Backup Image—Version of the backup image file.

When the device ships from the factory, the backup image is the same as the installed image. When you upgrade the software, the previously installed image becomes the backup.

### Apply a Software Update

To apply the latest software (.bin file) to the switch, follow these steps.

1. From the Admin menu, under File Management, choose Software Update.
2. If the file is on your local computer, click Browse, select the file, and then click Update.

or

If the file is on a remote TFTP server, in the TFTP Address and Image location fields, enter the IP address of the TFTP server and path to the file location. Click Update.

The Software Update page displays the progress of the software update.

---

**IMPORTANT** After the update completes successfully as indicated by a message notification, we recommend that you clear your browser cache and restart Device Manager in a new browser session.

---

▼ **Software update**

Click on browse to select an image  No file selected.

(OR)

TFTP Address:  Image location:

Stage	Status
1. Loading the bin file to the switch	
2. Software image is installed. Attempting to connect.	

## Apply a Backup Image

To swap to a backup image, follow these steps.

1. From the Admin menu, under File Management, choose Software Update.
2. Check Swap to backup image.
3. Click Submit.

A message notifies you of the swap, and the device reloads.

▼ **Swap to backup image**

Swap to backup image :  (S2500, Software (s2500-universalk9), Version (1.3.2011.7), Build Date (2016-11-17T23:35:33+00:00))

## Access Management in Device Manager

If a Technical Support representative requires remote access to the switch via the command-line interface (CLI), you must configure access to the switch following these steps:

1. From the Admin menu, under Device Management, choose Access Management.
2. To enable remote access to the switch via the CLI, check Enable SSH.
3. Click Submit.

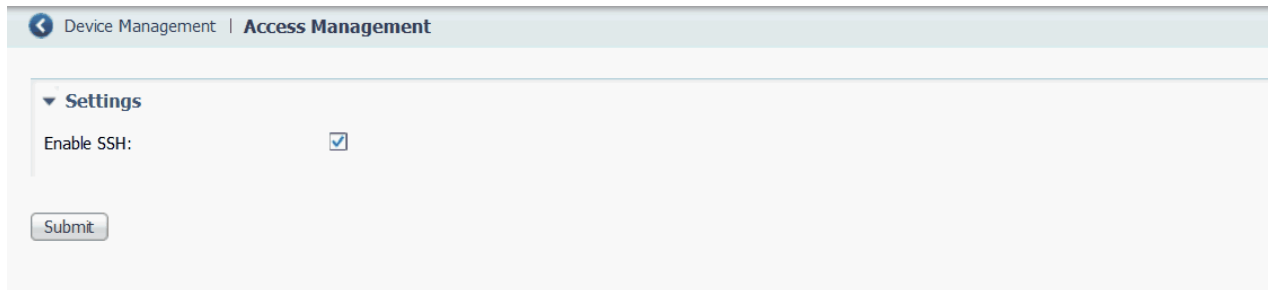



## Configure Switch Features

<b>Topic</b>	<b>Page</b>
802.1X Authentication	50
Alarms	51
Dynamic Host Configuration Protocol (DHCP)	54
EtherChannels	64
Internet Group Management Protocol (IGMP) Snooping with Querier	69
Port Mirroring	71
Port Security	72
Quality of Service (QoS)	76
Simple Network Management Protocol (SNMP)	77
Smartports	87
Spanning Tree Protocol (STP)	90
Storm Control	96
Terminal Access Controller Access Control System Plus/Remote Authentication Dial-In User Service (TACACS+/RADIUS)	97
Virtual Local Area Networks (VLANs)	98

This chapter describes software features that you can configure in Device Manager, the Studio 5000 Logix Designer® application, or both.

## 802.1X Authentication

IEEE 802.1X enables port-based access control using authentication. An 802.1X-enabled port can be dynamically enabled or disabled based on the identity of the client that connects to it.

Before authentication, the identity of the client is unknown and traffic is blocked. After authentication, the identity of the client is known and traffic from that endpoint is permitted. The switch performs source MAC filtering to help ensure that only the authenticated client is permitted to send traffic.

802.1X includes these components:

- **Supplicant**—A client on the endpoint that submits credentials for authentication.
- **Authenticator**—The network access device that relays the credentials of the supplicant to the authentication server.
- **Authentication server**—A server that validates the credentials and determines what level of network access the client receives. See RADIUS server information on page 97.

Use the 802.1X page to configure 802.1X port-based authentication on the switch.

← Security | **802.1x**

**Global Configuration**

Enable 802.1x:

Enable Reauthentication:

EAPOL Timeout:  seconds (Range 1-65535)

Hold Time:  seconds (Range 10- 1000000)

Max Reauth Count:  (Range 1 -255)

Dot1x Port Table Selected 0 | Total 5

<input type="checkbox"/> Interface	Dot1x Control State	Dot1x State
<input type="checkbox"/> Fa 1/1	Force Authorized	disabled
<input type="checkbox"/> Fa 1/2	Force Authorized	disabled
<input type="checkbox"/> Fa 1/3	Force Authorized	disabled
<input type="checkbox"/> Fa 1/4	Force Authorized	disabled
<input type="checkbox"/> Fa 1/5	Force Authorized	disabled

**IMPORTANT** You must configure the RADIUS server before configuring 802.1X authentication. See [Table 50 on page 98](#).

**Table 20 - Global Settings to Configure 802.1X Authentication**

Field	Description
Enable 802.1X	Choose one of the following: <ul style="list-style-type: none"> <li>enable—Globally activates 802.1X authentication on the switch.</li> <li>disable—Globally deactivates 802.1X authentication on the switch. All physical interfaces are permitted to forward frames.</li> </ul>
Enable Reauthentication	Choose one of the following: <ul style="list-style-type: none"> <li>enable—Successfully authenticated clients can be reauthenticated after the interval specified by the Reauthentication Period.</li> <li>disable—Reauthentication is not activated.</li> </ul> Reauthentication for 802.1X-enabled interfaces can be used to detect if a new device is plugged into a switch port or if a supplicant is no longer attached. For MAC-based ports, reauthentication is only useful if the RADIUS server configuration has changed. Reauthentication does not involve communication between the switch and the client device, and therefore does not imply that a client is still present on a port.
EAPOL Timeout	The time limit for retransmission of Request Identity EAPOL frames. EAPOL timeout is not applicable for MAC-based ports. Valid range: 1...65535 seconds Default: 30
Hold Time	The wait time before attempting to reauthenticate after reauthentication failed for a client. Valid range: 10...1000000 seconds Default: 10
Max Reauth Count	The maximum number of retransmissions to Request Identity for EAPOL frame. Valid range: 1...255 Default: 2
Submit	Click when your changes to Global Configuration fields are complete.

To modify the 802.1X administrative state for an individual port, select the row in the Dot1x Port Table. See [Table 21](#).

**Table 21 - Modify Administrative State Per Port**

Field	Description
Interface	The number of the switch port, including port type (such as Fa for Fast Ethernet), and the specific port number. For example, Fa1/1 is Fast Ethernet port 1 on the switch.
Dot1x Control State	Choose one of the following administrative modes: <ul style="list-style-type: none"> <li>Force Authorized—802.1X authentication is disabled. The port is in the authorized state and grants access to all clients. Force Authorized is the default setting.</li> <li>Force Unauthorized—The port is in the unauthorized state and all denies access to all clients.</li> <li>MAC Base Auth—This mode is used for 802.1X-unaware devices. The switch authenticates on behalf of the client, using the client MAC address as the username and password for the Microsoft Extensible Authentication Protocol-Message Digest 5 (EAP-MD5) method.</li> <li>Single 802.1X—The authentication server authorizes only one 802.1X-aware client. A client that is not 802.1X-aware is denied access. If the client leaves or is replaced with another, the device changes the port link state to down and the port enters the unauthorized state.</li> </ul> The administrative mode cannot be changed to anything other than Force Authorized when Spanning Tree is enabled on the interface. See <a href="#">Spanning Tree Protocol (STP) on page 90</a> .
Dot1x State	The 802.1X status of the port (enabled or disabled). This field is not editable.
Re-Authenticate	Select a row or multiple rows in the Port Security Table and click Re-Authenticate to force a new authentication.

## Alarms

In Device Manager, you can configure alarms to monitor the following types of temperatures:

- Switch temperature

- Junction temperature

You can define maximum, minimum, and critical temperatures parameters. If the switch detects a temperature condition that does not match the defined temperature parameters, an alarm is triggered.

When an alarm is triggered, it appears in the system log and the Alarms area in the lower-right corner of the Device Manager window. The severity of the alarms you configure on the Alarms Settings page is always Major.

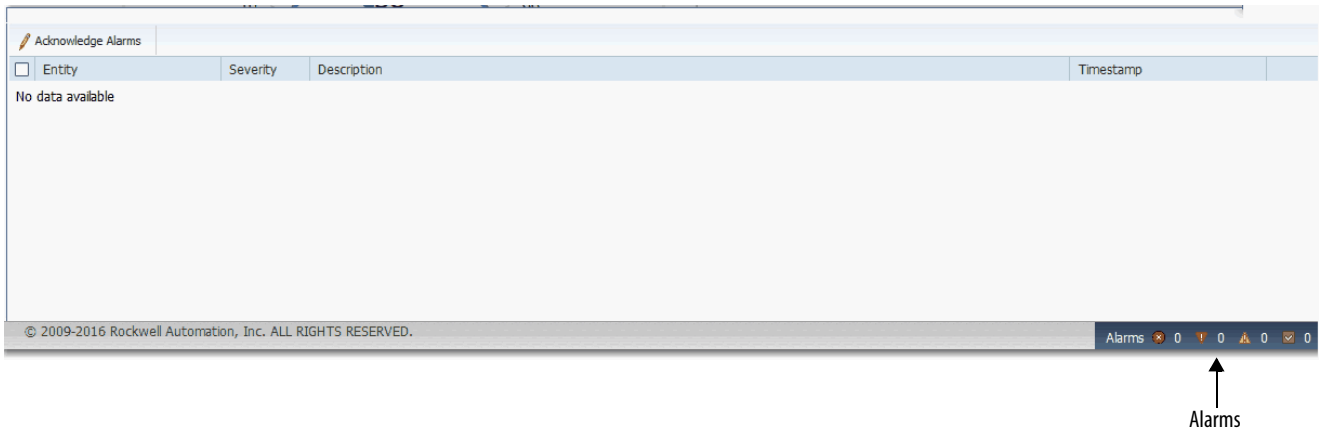

To configure alarm settings, follow these steps.

1. From the Configure menu, under Alarms, choose Alarm Settings.
2. In the Alarm Settings table, click the alarm name to configure.
3. Complete the fields that are described in [Table 22](#).
4. Click Save.

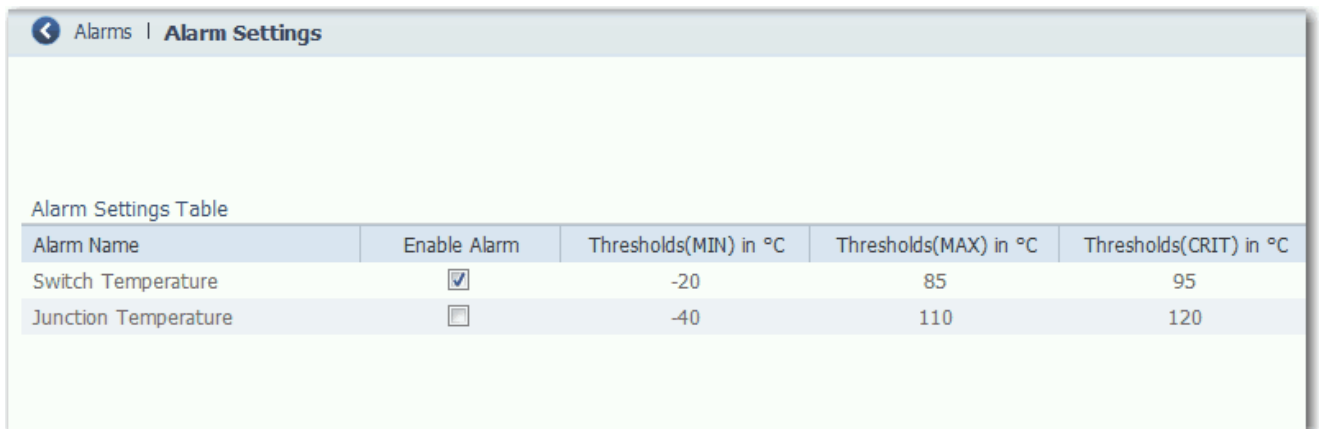

**Table 22 - Alarm Settings**

Alarm Name	Field	Description
Switch Temperature	Enable Alarm	To enable the alarm, check Enable Alarm. To disable the alarm, clear the Enable Alarm checkbox. By default, the alarm for switch temperature is enabled.
	Thresholds (MIN) in °C	Enter a minimum temperature threshold in degrees Celsius. If the temperature falls below the minimum threshold value, the switch triggers an alarm. Valid range: -40...+125 °C (-40...+257 °F) Default: -20 °C (-4 °F)
	Thresholds (MAX) in °C	Enter a maximum temperature threshold in degrees Celsius. If the temperature exceeds the maximum threshold value, the switch triggers an alarm. Valid range: -40...+125 °C (-40...+257 °F) Default: 85 °C (185 °F)
	Thresholds (CRIT) in °C	Enter a critical temperature threshold in degrees Celsius. If the temperature exceeds the critical threshold value, the switch triggers an alarm. Valid range: 90...150 °C (194...302 °F) Default: 95 °C (203 °F)
Junction Temperature	Enable Alarm	To enable the alarm, check Enable Alarm. To disable the alarm, clear the Enable Alarm checkbox. By default, the alarm for junction temperature is disabled.
	Thresholds (MIN) in °C	Enter a minimum temperature threshold in degrees Celsius. If the temperature falls below the minimum threshold value, the switch triggers an alarm. Valid range: -40...+125 °C (-40...+257 °F) Default: -40 °C (-40 °F)
	Thresholds (MAX) in °C	Enter a maximum temperature threshold in degrees Celsius. If the temperature exceeds the maximum threshold value, the switch triggers an alarm. Valid range: -40...+125 °C (-40...+257 °F) Default: 110 °C (230 °F)
	Thresholds (CRIT) in °C	Enter a critical temperature threshold in degrees Celsius. If the temperature exceeds the critical threshold value, the switch triggers an alarm. Valid range: 90...150 °C (194...302 °F) Default: 120 °C (248 °F)

## Dynamic Host Configuration Protocol (DHCP)

The switch can operate as a DHCP server by automatically assigning IP addresses to connected devices.

Every device in an IP-based network must have a unique IP address. DHCP assigns IP address information from a pool of available addresses to newly connected devices (DHCP clients) in the network. If a device leaves and then rejoins the network, the device receives the next available IP address, which is not necessarily the same address that the device had before.

To configure DHCP server settings and the IP address pools in Device Manager, click the Global Settings tab.

### DHCP Persistence

Use the DHCP persistence feature to assign a specific, reserved IP address to each port. The device that is connected to that port always receives the same IP address regardless of the MAC address of the connected device. DHCP persistence is useful in networks that you configure in advance, where dependencies on the exact IP addresses of some devices exist. Use DHCP persistence when the attached device has a specific role to play and when other devices know its IP address. If the device is replaced, the replacement device is assigned the same IP address, and the other devices in the network require no reconfiguration.

DHCP persistence works with only one device that is connected to each port configured for the feature.

---

**IMPORTANT** To make sure DHCP persistence works correctly, follow the application rules.

---

When the DHCP persistence feature is enabled, the switch acts as a DHCP server for other devices on the same subnet, including devices that are connected to other switches. If the switch receives a DHCP request, it responds with any unassigned IP addresses in its pool. To keep the switch from responding when it receives a request, check the Reserved Only box on the DHCP page, Global Settings tab.

When DHCP persistence is enabled and a DHCP request is made from a connected device on that port, the switch assigns the IP address for that port. The switch also broadcasts the DHCP request to the remainder of the network. If another DHCP server with available addresses is on the network and receives this request, it can try to respond. The response can override the initial IP address that the switch assigns depending on the end device (takes first IP address response or the last). To keep the IP address from being overridden, enable DHCP Snooping on the appropriate VLAN. DHCP snooping blocks the broadcast of this DHCP request, so that no other server, including another Stratix switch with DHCP persistence enabled, responds.

If you are using DHCP persistence, we recommend that you initially assign static IP addresses to end devices. If an end device fails and is replaced, the

DHCP persistence feature assigns an IP address from the DHCP persistence table. We recommend that you reassign a static IP address to the replaced device.

The following figure and table illustrate DHCP persistence behavior.

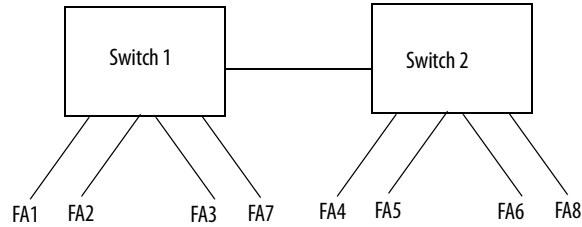

**Table 23 - DHCP Persistence Behavior**

If	Then
<ul style="list-style-type: none"> <li>Switch 1 has ports FA1...FA3 in its persistence table</li> <li>Switch 2 has ports FA4, FA5, FA6, and FA8 in its DHCP Persistence table</li> <li>Reserve Only is not selected and DHCP Snooping is off</li> </ul>	<p>A new device that is connected to switch 1 FA1 receives an IP address from the switch 1 in the persistence table. A broadcast request is also sent across the network. Switch 2 responds if there is an unassigned address in its pool. The response can override the assignment that is made by switch 1.</p>
<ul style="list-style-type: none"> <li>Switch 1 has ports FA1...FA3 in its persistence table</li> <li>Switch 2 has ports FA4, FA5, FA6, and FA8 in its DHCP Persistence table</li> <li>Reserve Only is selected in both switches and DHCP Snooping is off</li> </ul>	<p>A new device that is connected to switch 1 FA1 receives an IP address from the switch 1 in the persistence table. A broadcast request is also sent across the network. Switch 2 does not respond to the request. If the device is connected to FA7 of switch 1, it does not receive an IP address from the switch pool because it is not defined in the table. Also, unused addresses in the pool are blocked.</p>
<ul style="list-style-type: none"> <li>Switch 1 has ports FA1...FA3 in its persistence table</li> <li>Switch 2 has ports FA4, FA5, FA6, and FA8 in its DHCP Persistence table</li> <li>Reserve Only is selected in switch 1 and DHCP snooping is off, but not switch 2 when DHCP Snooping is off</li> </ul>	<p>A new device is connected to FA1 receives an IP address from the persistence table. A broadcast request is also sent across the network. Switch 2 does not respond to the request. In addition, a device that is connected to FA4 receives an IP address from the switch 2 in the persistence table. A broadcast request is sent out, and switch 1 responds with an unused IP address from its pool. The response can override the assigned port.</p>
<ul style="list-style-type: none"> <li>Switch 1 has ports FA1...FA3 in its persistence table</li> <li>Switch 2 has ports FA4, FA5, FA6, and FA8 in its DHCP Persistence table</li> <li>DHCP Snooping is selected</li> <li>Reserved Only is checked</li> </ul>	<p>A new device that is connected to switch 1 FA1 receives an IP address from the Switch 1 persistence table. A broadcast request is not sent across the network, so Switch 2 does not respond. If a device is connected to FA7 of Switch 1, it does not receive an IP address from the switch pool because it is not defined in the table. Also, unused addresses in the pool are blocked.</p>
<ul style="list-style-type: none"> <li>Switch 1 has ports FA1...FA3 in its persistence table</li> <li>Switch 2 has ports FA4, FA5, FA6, and FA8 in its DHCP Persistence table</li> <li>DHCP Snooping is selected</li> <li>Reserved Only is not checked</li> </ul>	<p>A new device that is connected to switch 1 FA1 receives an IP address from the Switch 1 persistence table. A broadcast request is not sent across the network, therefore Switch 2 does not respond. If a device is connected to FA7 (not defined in the DHCP Persistence table) of Switch 1, it receives an unassigned IP address from the switch 1 pool.</p>

To configure DHCP persistence for individual interfaces, click the DHCP Port Configurations tab. See [Table 26 on page 59](#).

### Configure DHCP Persistence Via Device Manager

To configure DHCP persistence, complete this process.

1. Enable the DHCP server.
2. Configure the IP address pool.
3. Assign an IP address to a switch port.

### Enable the DHCP Server

1. From the Configure menu, choose DHCP.
2. Click Enable DHCP.

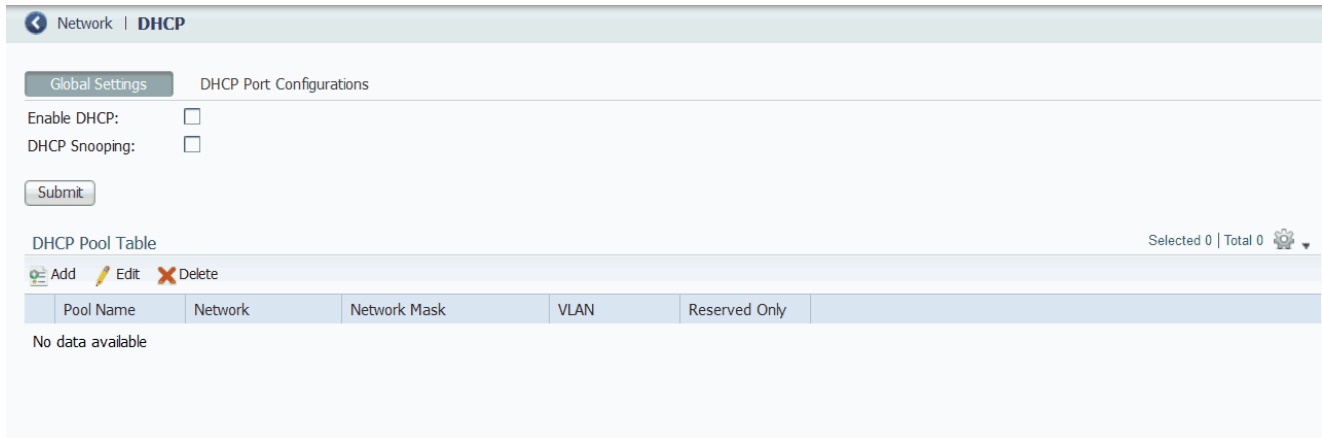

3. Click Submit.

### Configure the DHCP IP Address Pool

Once DHCP is enabled, you can create the DHCP address pool.

1. From the Configure menu, choose DHCP.
2. Click Add.

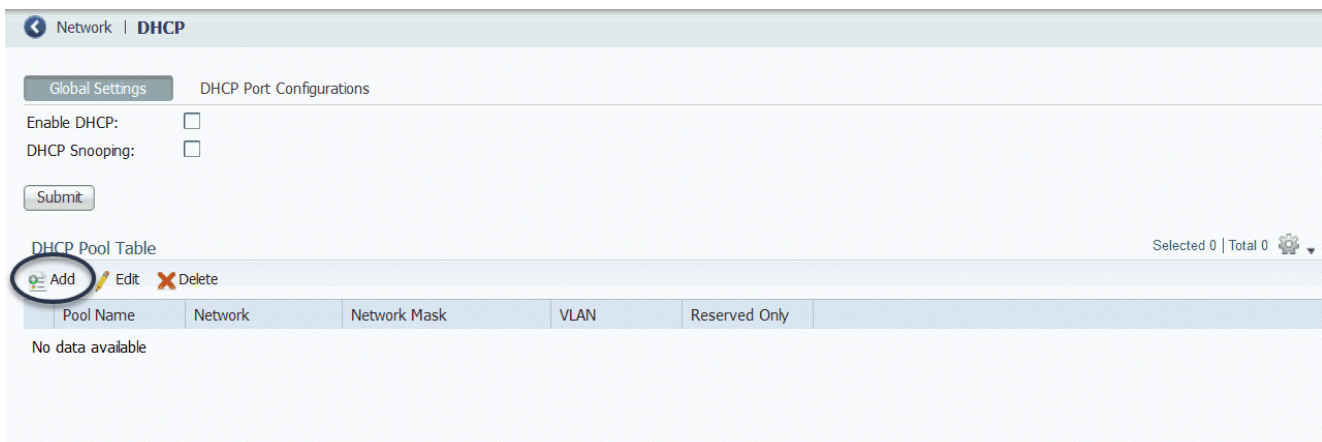

3. Complete the fields and click OK.



**Table 24 - DHCP Pool Table Add Fields**

Field	Description
DHCP Pool Name	The name of the DHCP IP address pool that is configured on the switch. The name can have up to 31 alphanumeric characters. The name cannot contain a ? or a tab. This field is required. A DHCP IP address pool is a range (or pool) of available IP addresses that the switch can assign to connected devices.
DHCP Pool Network	The subnetwork IP address of the DHCP IP address pool. The format is a 32-bit numeric address that is written as four numbers that are separated by periods. Each number can be from 0...255. This field is required.
Subnet Mask	The network address that identifies the subnetwork (subnet) of the DHCP IP address pool. Subnets segment the devices in a network into smaller groups. The default is 255.255.255.0. This field is required.
Starting IP	The starting IP address that defines the range of addresses in the DHCP IP address pool. The format is a 32-bit numeric address that is written as four numbers that are separated by periods. Each number can be from 0...255. Be sure that none of the IP addresses that you assign are being used by another device in your network. This field is required.
Ending IP	The ending IP address that defines the range of addresses in the DHCP IP address pool. The format is a 32-bit numeric address that is written as four numbers that are separated by periods. Each number can be from 0...255. Make sure that none of the IP address you assign are being used by other devices in your network. This field is required.
Default Router	The default router IP address for the DHCP client that uses this server. The format is a 32-bit numeric address that is written as four numbers that are separated by periods. Each number can be from 0...255.
Domain Name	The domain name for the DHCP client. The name can have up to 31 alphanumeric characters. The name cannot contain a ? or a tab.
DNS Server	The IP addresses of the domain name system (DNS) IP servers available to a DHCP client. The format is a 32-bit numeric address that is written as four numbers that are separated by periods. Each number can be from 0...255.
[Lease Length]	The duration of the lease for an IP address that is assigned to a DHCP client. Click one of the following: <ul style="list-style-type: none"> <li>• Never Expires</li> <li>• User Defined</li> </ul> If you click User Defined, enter the duration of the lease in the numbers of days, hours, and minutes. This lease length is used for all assignments.

After the DHCP IP address pool is configured, the Global Settings tab displays the Pool Name, Network, and Network Mask information within the DHCP Pool Table. Two additional fields are also populated.

---

**IMPORTANT** An IP address must be within your DHCP pool to populate the VLAN field successfully.

---

**Table 25 - DHCP Pool Table Fields**

Field	Description
VLAN	The name of the VLAN that is associated with this address pool. The VLAN is automatically chosen based on the subnet and is not editable. If a pool address is not associated with a VLAN, no information is displayed and no addresses are assigned.
Reserved Only	Choose one of the following: <ul style="list-style-type: none"> <li>enable—The switch offers this single IP address to a DHCP client. DHCP requests from other ports are ignored, however, other DHCP servers on the network can still assign addresses to devices that are connected to this switch. To configure the IP address, click the DHCP Port Configurations tab. See <a href="#">Table 26 on page 59</a>.</li> <li>disable—A connected device receives the next available address from the pool.</li> </ul>

## DHCP Snooping

DHCP Snooping is a security feature that performs as a firewall between untrusted hosts and trusted DHCP servers. To enable DHCP Snooping globally on the switch, click DHCP Snooping on the Global Settings tab. This feature is disabled by default.

To enable DHCP snooping on a specific interface, check Enable Snooping for the interface in the DHCP Port Configurations tab. This setting differentiates between untrusted ports that are connected to the end user, and trusted ports connected to the DHCP server or another switch. See [Table 26](#).

---

**IMPORTANT** All DHCP servers must be connected to the switch through a trusted interface for DHCP Snooping to function properly.

---

## Assign an IP Address to a Switch Port and Enable Snooping Via Device Manager

To manage switch port IP addresses and DHCP Snooping, click the DHCP Port Configurations tab.

Network | DHCP

Global Settings DHCP Port Configurations

Interface	Pool Name	Reserved IP Address	Enable Snooping	DHCP Rate Limit
Fa 1/1	None		<input type="checkbox"/>	0
Fa 1/2	None		<input type="checkbox"/>	0
Fa 1/3	None		<input type="checkbox"/>	0
Fa 1/4	None		<input type="checkbox"/>	0
Fa 1/5	None		<input type="checkbox"/>	0

**Table 26 - DHCP Port Configurations Fields**

Field	Description
Interface	The number of the switch port, including port type (such as Fa for Fast Ethernet), and the specific port number. For example, Fa1/1 is Fast Ethernet port 1 on the switch.
Pool Name	The name of the DHCP IP address pool that is configured on the switch.
Reserved IP Address	The IP address that is assigned to the switch port. The IP address that you assign is reserved for the selected port and is not available for normal DHCP dynamic assignment. The IP address must be an address from the pool that is specified in the DHCP Pool Name field.
Enable Snooping	Choose one of the following: <ul style="list-style-type: none"> <li>enable—Check Enable Snooping to configure the interface to transmit DHCP Discovery and Request messages to a DHCP Server. Check Enable Snooping on the interface that is attached to an external DHCP server.</li> <li>disable—Clear the Enable Snooping checkbox to receive DHCP Discovery and Request messages from a client. Leave Enable Snooping disabled for all clients that request an IP Address from an external DHCP Server.</li> </ul>
DHCP Rate Limit	Set the rate of DHCP packets that are allowed through the port per second. If the number of packets exceeds this value, and Error Disable is selected for DHCP rate limit on the Port Settings page, the port is placed in the error-disabled state. Error disable is triggered on trusted ports with Enable Snooping enabled on relevant VLANs. For example, if the DHCP rate limit is set to 5, and six DHCP frames are received per second, the port enters the error-disabled state. The number of clients to receive an IP address before the port enters this state depends on the type of DHCP packets that are exchanged within that second. It is recommended you set the limit to 100 and above so that valid clients can receive an IP address. Range is 0 -500. Zero indicates that DHCP rate limit is not active.

## Bootstrap Protocol (BOOTP)

The switch also supports BOOTP for the assignment of IP addresses. When the DHCP server is enabled and a client sends a BOOTP request, the server responds with a BOOTP response that is based on the DHCP pool configuration. DHCP options are not supported in the BOOTP process. The switch does not distinguish between BOOTP requests or DHCP requests when a reserved IP address is configured for an interface. To use BOOTP, you must enable DHCP; there are no BOOTP-specific settings to configure through Device Manager.

## Configure DHCP Persistence Via Logix Designer

To configure DHCP persistence, complete this process.

1. Configure the DHCP server.
2. Configure the DHCP IP address pool.
3. Assign an IP address to a switch port.

### Configure the DHCP Server

1. In the navigation pane, click DHCP Pools.
2. Click Enable Dynamic Host Configuration Protocol (DHCP).

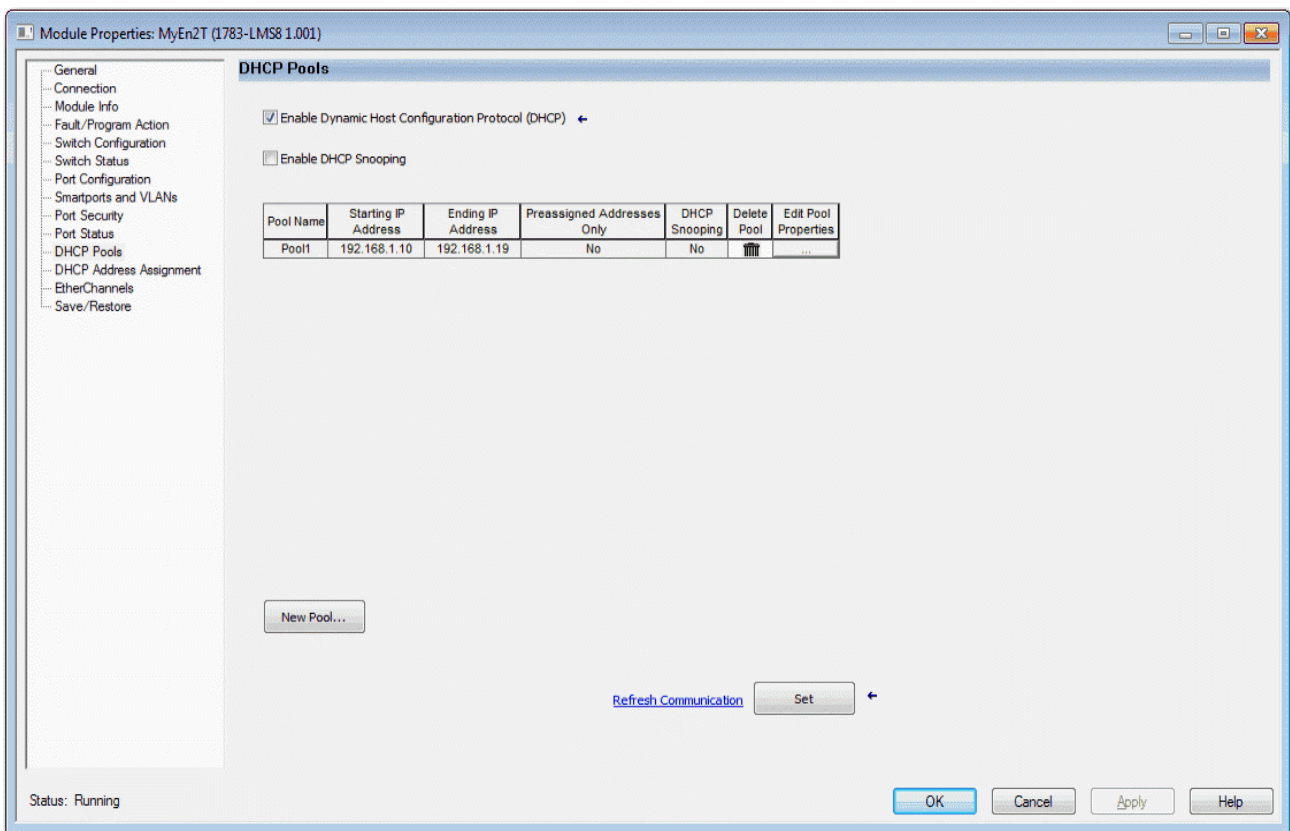

3. To enable DHCP snooping on the switch, click Enable DHCP Snooping.

DHCP snooping restricts the broadcast of DHCP requests beyond the connected switch. As a result, devices receive address assignments from only the connected switch. This option is available only on ports that are assigned to a VLAN.

To enable DHCP snooping on a specific VLAN, check DHCP Snooping for the specific VLAN in the DHCP pool table.

### Configure the DHCP IP Address Pool

Once DHCP is enabled, you can create the DHCP address pool.

1. In the navigation pane, click DHCP Pools.
2. Click New Pool.

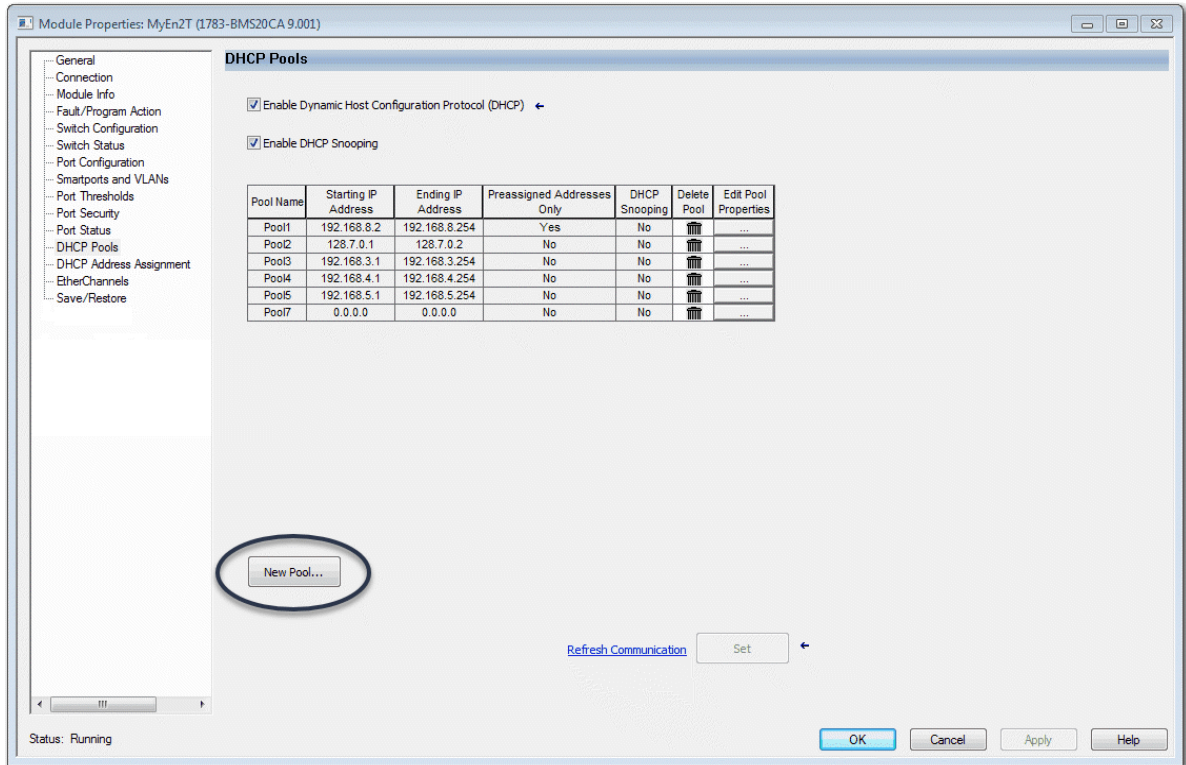

3. Complete the fields as shown in [Table 27](#).

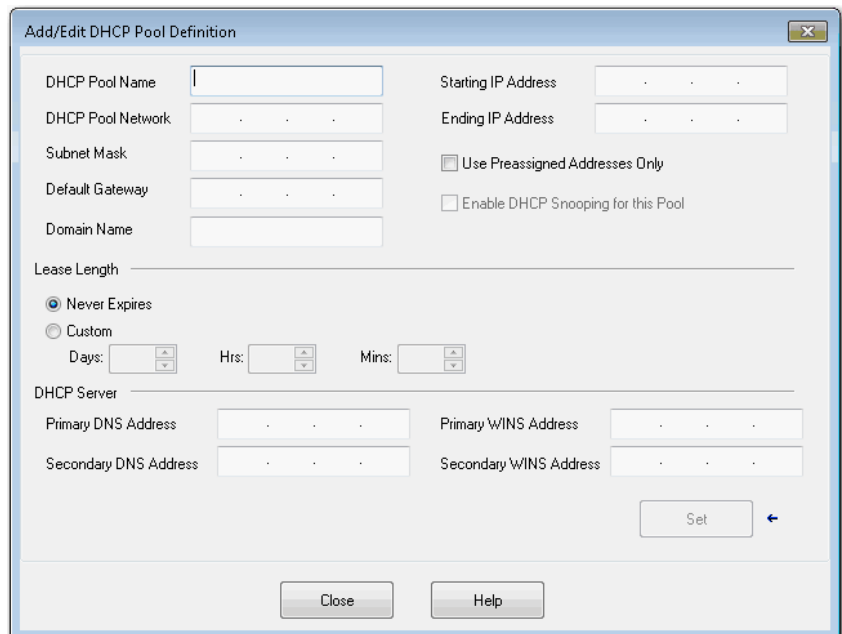

**Table 27 - Add/Edit DHCP Pool Definition Fields**

Field	Description
DHCP Pool Name	The name of the DHCP IP address pool that is configured on the switch. The name can have up to 31 alphanumeric characters. The name cannot contain a ? or a tab. This field is required. A DHCP IP address pool is a range (or pool) of available IP addresses that the switch can assign to connected devices.
DHCP Pool Network	The subnetwork IP address of the DHCP IP address pool. The format is a 32-bit numeric address that is written as four numbers that are separated by periods. Each number can be from 0 . . . 255. This field is required.
Subnet Mask	The network address that identifies the subnetwork (subnet) of the DHCP IP address pool. Subnets segment the devices in a network into smaller groups. The default is 255.255.255.0. This field is required.
Default Gateway	The default gateway IP address for the DHCP client. The format is a 32-bit numeric address that is written as four numbers that are separated by periods (for example, 255.255.255.255). Each number can be from 0 . . . 255.
Domain Name	The domain name for the DHCP client.
Starting IP Address	The starting IP address that defines the range of addresses in the DHCP IP address pool. The format is a 32-bit numeric address that is written as four numbers that are separated by periods. Each number can be from 0 . . . 255. Be sure that none of the IP addresses that you assign are being used by another device in your network. This field is required.
Ending IP Address	The ending IP address that defines the range of addresses in the DHCP IP address pool. The format is a 32-bit numeric address that is written as four numbers that are separated by periods. Each number can be from 0 . . . 255. Make sure that none of the IP address you assign are being used by other devices in your network. This field is required.
Use Preassigned Addresses Only	If checked, IP addresses are assigned only when configured for specific ports on the DHCP Address Assignment view.
Enable DHCP Snooping for this Pool	If checked, devices only receive address assignments from the connected switch.
Never Expires or Custom	The duration of the lease for an IP address that is assigned to a DHCP client. Click one of the following: <ul style="list-style-type: none"> <li>• Never Expires</li> <li>• Custom</li> </ul> If you click Custom, enter the duration of the lease in the numbers of days, hours, and minutes. This lease length is used for all assignments.
Primary DNS Address	The IP addresses of the primary domain name system (DNS) IP servers available to a DHCP client.
Secondary DNS Address	The IP addresses of the secondary domain name system (DNS) IP servers available to a DHCP client.
Primary WINS Address	The IP address of the primary Microsoft NetBIOS name server (WINS server) available to a DHCP client.
Secondary WINS Address	The IP address of the secondary Microsoft NetBIOS name server (WINS server) available to a DHCP client.

4. Click Set and Close.

### Assign an IP Address to a Switch Port

In the navigation pane, click DHCP Address Assignment.

You can assign a specific IP address to each port so that the device that is attached to a given port receives the same IP address.

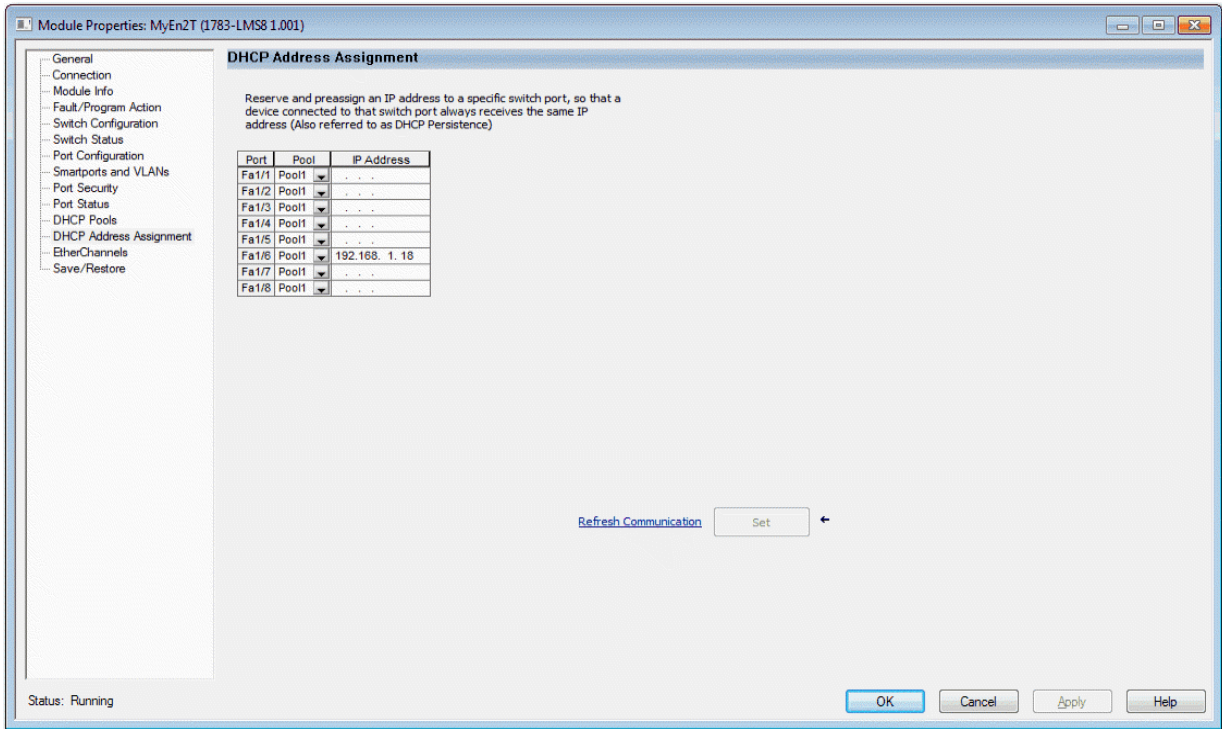

**Table 28 - DHCP Address Assignment Fields**

Field	Description
Port	The number of the switch port, including port type (such as Fa for Fast Ethernet), and the specific port number. For example, Fa1/1 is Fast Ethernet port 1 on the switch.
Pool	Displays the pool names from the DHCP IP address pool that corresponds to the instances available in the switch. If you delete all rows that contain pools on the DHCP Pool Display tab and click Refresh, the Pool field is blank.
IP Address	Displays the IP address that is assigned to the switch port. The format is a 32-bit numeric address that is written as four numbers that are separated by periods (for example, 255.255.255.255). Each number can be from 0...255. The IP address that you assign is reserved for the selected port and is not available for normal DHCP dynamic assignment. The IP address must be an address from the pool that is specified in the DHCP Pool Name field.

## EtherChannels

An EtherChannel, or port group, is a group of two or more switch ports that are bundled into one logical link to create a higher bandwidth link between two switches. For example, four Fast Ethernet switch ports that are all configured to operate at 100 Mbps can be assigned to an EtherChannel to provide full-duplex bandwidth of up to 400 Mbps. If one of the ports in the EtherChannel becomes unavailable, traffic is carried over the remaining ports within the EtherChannel. The maximum number of channels that you can configure is half of the number of available ports. For example, for a five-port device you can configure two channels. You must have at least two ports in an EtherChannel, and the maximum number of ports in a channel is the maximum number of ports on the switch minus one.

All ports in an EtherChannel must have the same characteristics:

- All are configured with the same speed and duplex mode.
- The ports in an EtherChannel cannot already be in use in another EtherChannel.
- All ports are enabled. A disabled port in an EtherChannel is treated as a link failure, and its traffic is transferred to one of the remaining ports in the EtherChannel.

[Figure 1](#) shows two EtherChannels. Two full-duplex 10/100 ports on Switches A and C create an EtherChannel with a bandwidth of up to 400 Mbps between both switches. Similarly, two full-duplex 10/100 ports on Switches B and D create an EtherChannel with a bandwidth of up to 400 Mbps between both switches.

If one of the ports in the EtherChannel becomes unavailable, traffic is sent through the remaining ports within the EtherChannel.

**Figure 1 - EtherChannel Example**

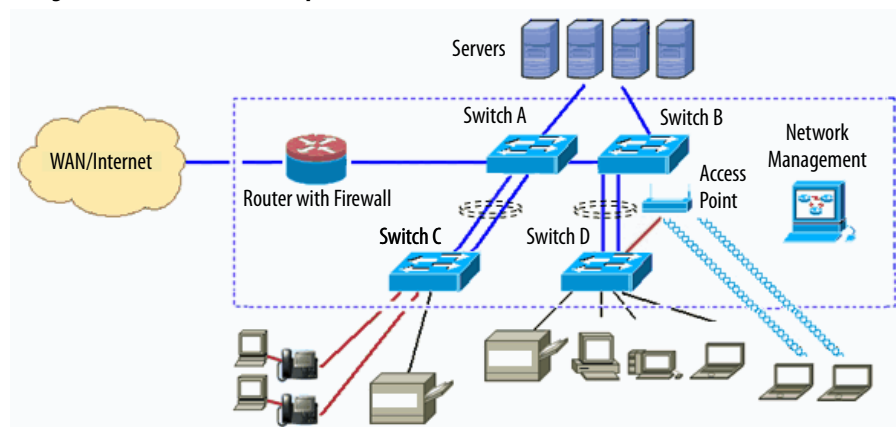

[Table 29](#) describes the modes that you can assign to an EtherChannel:



**Table 29 - EtherChannel Modes**

Mode	Description
Static	All ports join the EtherChannel, without negotiations. This mode can be useful if the remote device does not support the protocols that other modes require. The switches at both ends of the link must be configured in Static mode. In this mode, the system assigns a channel group number even if there is no connection to any device on the assigned ports.
Link Aggregation Control Protocol (LACP) (active)	This mode enables LACP unconditionally. The port sends LACP packets to other ports to initiate negotiations to create EtherChannels. A port in active LACP mode can form an EtherChannel with another port that is in active or passive LACP mode. The ports must be configured for full-duplex. In this mode, the system assigns a channel group number only when a device is connected to create a physical channel.
Link Aggregation Control Protocol (LACP) (passive)	This mode enables LACP only if an LACP device is detected at the other end of the link. The port responds to requests to create EtherChannels but does not initiate negotiations. The ports must be configured for full-duplex. In this mode, the system assigns a channel group number only when a device is connected to create a physical channel.

Configure both ends of the EtherChannel in the same mode:

- When you configure one end of an EtherChannel in LACP mode, the system negotiates with the other end of the channel to determine the ports to become active. Incompatible ports are suspended. Instead of a suspended state, the local port is put into an independent state and continues to carry data traffic as any other single link. The port configuration does not change, but the port does not participate in the EtherChannel.
- When you configure an EtherChannel in Static mode, no negotiations take place. The switch forces all compatible ports to become active in the EtherChannel. The other end of the channel on the other switch must also be configured in the Static mode. Otherwise, packet loss can occur.

If a link within an EtherChannel fails, traffic previously carried over that failed link moves to the remaining links within the EtherChannel. If traps are enabled on the switch, a trap is sent for a failure that identifies the switch, the EtherChannel, and the failed link. Inbound broadcast and multicast packets on one link in an EtherChannel are blocked from returning on any other link of the EtherChannel.

You can configure EtherChannels in Device Manager or the Logix Designer application.

The screenshot shows a software interface for configuring EtherChannels. At the top, it says 'Network | EtherChannels'. Below that is a section titled 'EtherChannel Table' with 'Add', 'Edit', and 'Delete' buttons. The table has columns for 'Channel Group Number', 'Channel Mode', 'Configured Ports', 'Aggregated Ports', and 'Speed'. There are two rows of data:

Channel Group Number	Channel Mode	Configured Ports	Aggregated Ports	Speed
0	LACP (Active)	Fa 1/1, Fa 1/2		
1	Static	Fa 1/3, Fa 1/6		

**Table 30 - EtherChannel Table Fields**

Field	Description
Channel Group Number	A system-generated number to identify the EtherChannel. Valid values: 1 to the maximum number of EtherChannels, which is half of the number of available ports.
Channel Mode	Determines how ports become active. With all modes except Static, negotiations occur to determine which ports become active. Incompatible ports are put into an independent state and continue to carry data traffic, but do not participate in the EtherChannel. <b>IMPORTANT:</b> Make sure that all ports in an EtherChannel are configured with the same speed and duplex mode. See <a href="#">Table 29</a> for a description of EtherChannel modes.
Configured Ports	The ports that are configured to participate in the EtherChannel.
Aggregated Ports	The ports that connected during the setup of the physical device connection.
Speed	The operating speed. Auto (the default setting) allows a connected device to negotiate the link speed.

You can add, edit, or delete an EtherChannel:

- To add an EtherChannel, click Add. Complete the fields that are described in [Table 31](#) and click OK.
- To edit an EtherChannel, click the radio button next to the EtherChannel and click Edit. Complete the fields that are described in [Table 31](#) and click OK.
- To delete an EtherChannel, click the radio button next to the EtherChannel and click Delete.

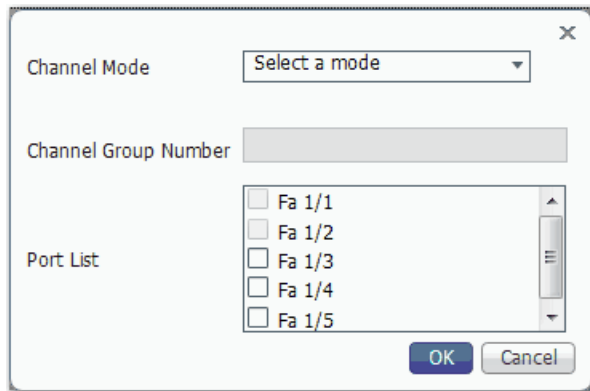
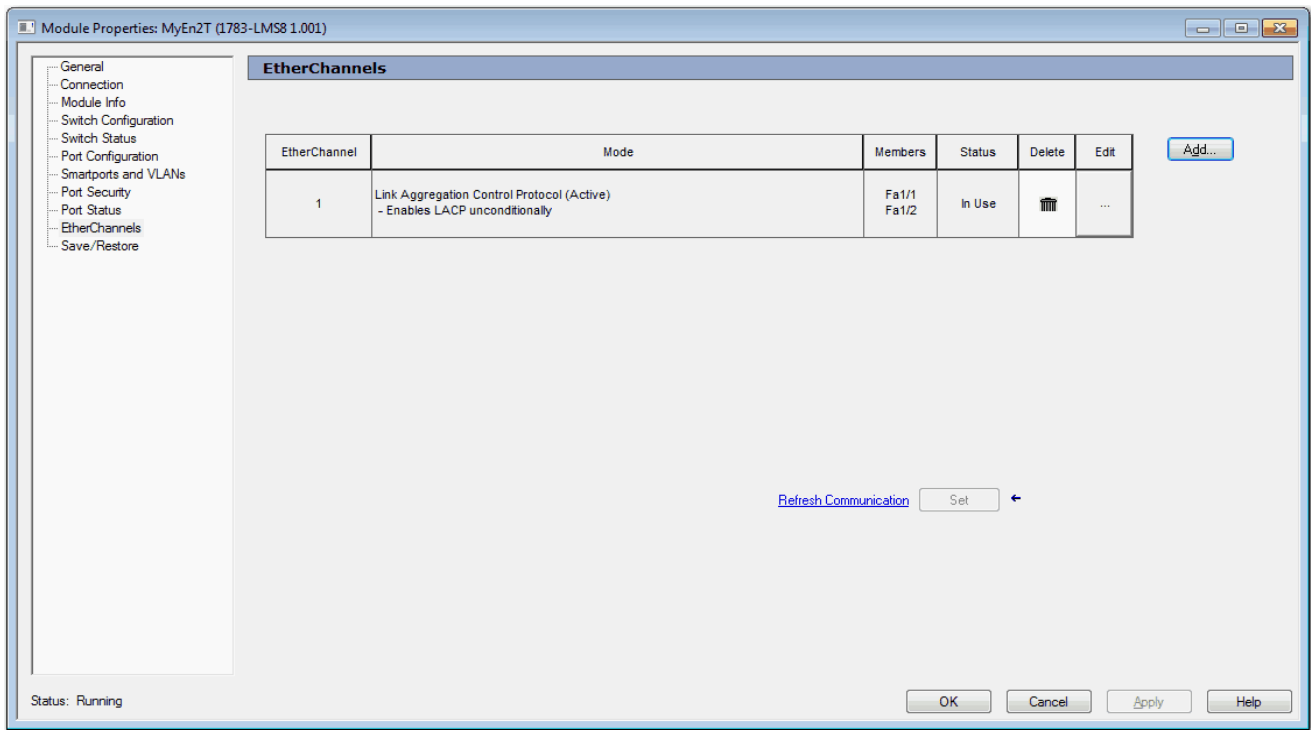

**Table 31 - Add/Edit EtherChannel Dialog Box**

Field	Description
Channel Mode	Choose a mode to assign to the EtherChannel. For a description of each mode, see <a href="#">Table 29 on page 65</a> .
Channel Group Number	(System-generated). A number from 1 to the maximum number of EtherChannels (half of the number of available ports) that identifies the EtherChannel.
Port List	To enable a port to participate in the EtherChannel, check its corresponding checkbox.

## Configure EtherChannels in the Logix Designer Application

In the navigation pane, click EtherChannels.

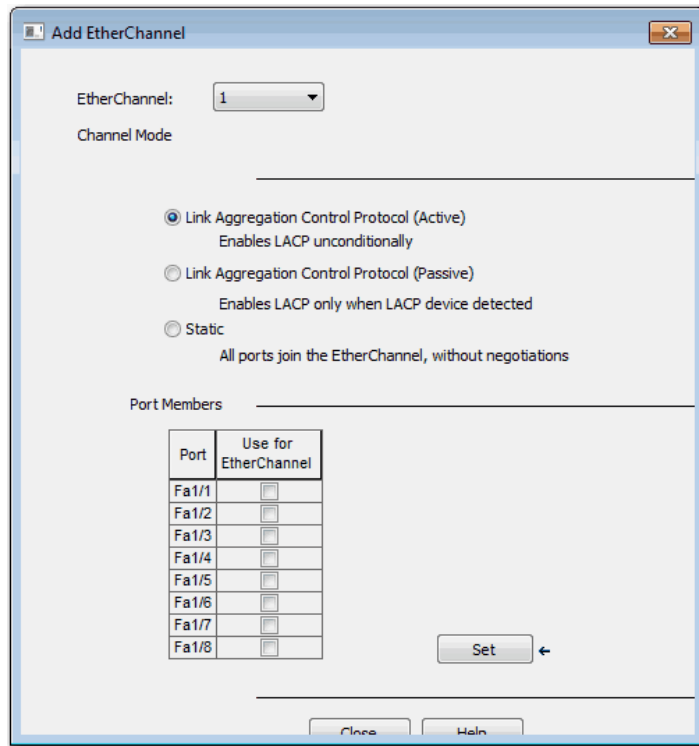

**Table 32 - EtherChannels Fields**

Field	Description
EtherChannel	A number to identify the EtherChannel.
Mode	Determines how ports become active. With all modes except Static, negotiations occur to determine which ports become active. Incompatible ports are put into an independent state and continue to carry data traffic, but do not participate in the EtherChannel. <b>IMPORTANT:</b> Make sure that all ports in an EtherChannel are configured with the same speed and duplex mode. For a description of each mode, see <a href="#">Table 29 on page 65</a> .
Members	The ports that can participate in the EtherChannel.
Status	The status of the group.

You can add, edit, or delete an EtherChannel:

- To add an EtherChannel, click Add. Complete the fields that are described in [Table 33](#). Click Set and click Close.
- To edit an EtherChannel, click the corresponding Ellipse button in the Edit column. Modify the fields that are described in [Table 33](#). Click Set and click Close.
- To delete an EtherChannel, click the corresponding Trash icon in the Delete column.



**Table 33 - Add/Edit EtherChannel Fields**

Field	Description
EtherChannel	Choose a number to identify the EtherChannel.
Channel Mode	Click to select a mode. For a description of each mode, see <a href="#">Table 29 on page 65</a> .
Port Members	To enable a port to participate in the EtherChannel, check Use for EtherChannel.

## Internet Group Management Protocol (IGMP) Snooping with Querier

Layer 2 switches can use IGMP snooping to constrain the flooding of multicast traffic. IGMP snooping dynamically configures Layer 2 interfaces so that multicast traffic is forwarded to only those interfaces that are associated with IP multicast devices. IGMP snooping requires the LAN switch to snoop on the IGMP transmissions between the host and the router and track multicast groups and member ports. When the switch receives an IGMP report from a host for a particular multicast group, it adds the host port number to the forwarding table entry. When the switch receives an IGMP Leave Group message from a host, it removes the host port from the table entry. It also periodically deletes entries if it does not receive IGMP membership reports from the multicast clients.

For IGMP snooping to function, a multicast querier must exist on the network and generate IGMP queries. The tables that are created for snooping (contain the member ports for each a multicast group) are associated with the querier. When there is no multicast router in the VLAN to originate the queries, enable the IGMP snooping querier to send membership queries. When the IGMP snooping querier is enabled, it sends out periodic IGMP queries that trigger IGMP report messages from hosts that want to receive IP multicast traffic. IGMP snooping listens to these IGMP reports to establish appropriate forwarding.

The switch supports IP multicast group-based bridging, rather than MAC-addressed based groups. With multicast MAC address-based groups, if an IP address being configured translates (aliases) to a previously configured MAC address or to any reserved multicast MAC addresses (in the range 224.0.0.xxx), the command fails. Because the switch uses IP multicast groups, there are no address alias issues.

The IP multicast groups that are learned through IGMP snooping are dynamic. The switch learns multicast IP addresses that are used by the EtherNet/IP network for I/O traffic.

IGMP implementation in the switch is IGMP V2. This version is backward-compatible with switches running IGMP V1. The switch has a built-in querier function, and the global macro enables IGMP snooping and the querier.

For more information on IP multicast and IGMP, see [RFC 1112](#) and [RFC 2236](#).

You can configure IGMP snooping in Device Manager.

To configure IGMP snooping, follow these steps.

1. From the Configure menu, under Security, choose IGMP Snooping.
2. To enable IGMP Snooping globally, check Enable and click Submit.
3. To enable IGMP Snooping for a VLAN, click the VLAN in the IGMP Snooping table, check Enable IGMP Snooping, and click Save.
4. To enable IGMP Querier for a VLAN, click the VLAN in the IGMP Snooping table, check Enable IGMP Querier, and click Save.

---

**IMPORTANT** You must enable IGMP both at the global level and the individual VLAN level for the feature to work.

---

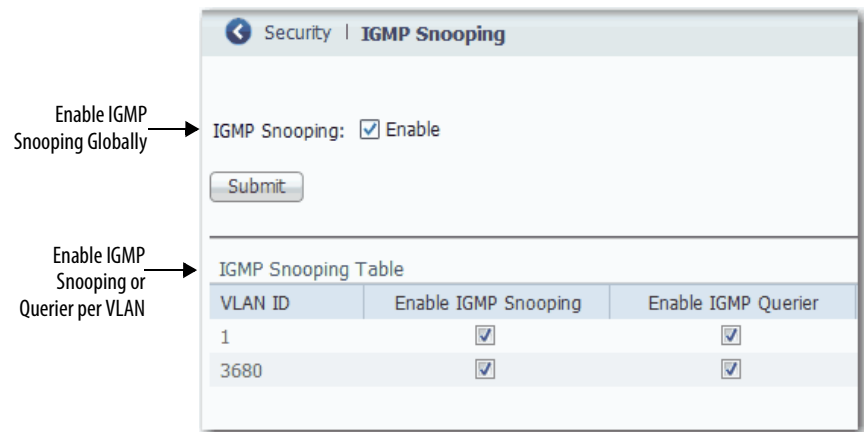

## Port Mirroring

Port mirroring is for advanced users with experience in troubleshooting traffic and protocol issues on networks. Port mirroring copies, or mirrors, traffic on a source port to a destination port on the same switch for analysis.

---

**EXAMPLE** You can configure all traffic on Fa1/1 (the source port) to be mirrored to Fa1/2 (the destination port). A network analyzer on Fa1/2 can receive all network traffic from Fa1/1 without being physically attached to Fa1/1.

---

Port mirroring does not affect the switching of network traffic on the monitored port. You must dedicate a monitoring port for port mirroring. Except for traffic that is being copied for the port mirroring session, the monitoring port does not receive or forward traffic.

- 
- IMPORTANT**
- You can configure only one interface at a time for port mirroring.
  - Port mirroring is a tool for the analysis of end node traffic. Because the switch can filter certain network control traffic, we recommend that you do not use port mirroring when you require an exact copy of all network traffic.
  - If the destination port is in the management VLAN and is connected, Device Manager alerts you about possible loss in connectivity or network performance.
- 

You can configure port mirroring in Device Manager.

To configure port mirroring, follow these steps.

1. From the Configure menu, under Network, choose Port Mirroring.
2. To select a row in the Port Mirroring table, click it.
3. From the Source Port pull-down menu, choose the port that you want to mirror, or to remove the configuration of the port mirroring, choose None.
4. From the Destination Port pull-down menu, choose the port to receive the mirrored traffic, or to remove the configuration of the port mirroring, choose None.
5. Click Save.

Port Mirroring Table		
Session ID	Source Port	Destination Port
1	Fa 1/1	Fa 1/2

## Port Security

Port security limits the number of devices on a given port. The switch identifies a device by its MAC address and VLAN ID. You can enable port security for a given port and specify the maximum number of MAC addresses to secure on the port. The switch sends traffic through only those devices.

You can also enable aging for a secured MAC address. When you enable aging, a timer begins counting in seconds after a MAC address is secured. When the aging period expires, if no traffic is seen on the device within the next aging period, the switch frees the MAC address. If the security mode of the port is set to Restrict, the switch replaces the expired MAC address with any violating MAC addresses that are held in the MAC table.

If the number of secured MAC addresses on a port exceeds the maximum number that is defined in port security, a security violation occurs. A security violation triggers an action that is based on the security mode that is configured for the port, as described in [Table 34](#).

**Table 34 - Security Modes**

Security Mode	Description
Protect	When a security violation occurs, the switch stops securing MAC addresses. A syslog entry is generated to notify that a port security violation has occurred. The port continues to forward traffic on devices with already secured MAC addresses. Protect mode is the default mode.
Restrict	When a security violation occurs, the switch continues to secure a maximum of four new MAC addresses. These MAC addresses are known as violating and are kept blocked in the MAC table until the aging period expires. In Device Manager, you can view violating MAC addresses on the Port Security page available from the Monitor menu.
Shutdown	When a security violation occurs, these actions occur: <ul style="list-style-type: none"> <li>The switch stops forwarding traffic on the port. The port goes into the error-disabled state, and all secured MAC addresses are removed from the MAC table.</li> <li>If an SNMP trap is enabled for port security violations, the switch generates an SNMP trap. In Device Manager, you enable traps for port security violations on the Traps tab of the SNMP page available from the Configure menu.</li> <li>The switch generates an entry in the syslog.</li> </ul> <p><b>IMPORTANT:</b> To make the port available for forwarding traffic after it is error-disabled, you must re-enable the port in port settings.</p>

You can configure port security in Device Manager or the Logix Designer application.



## Configure Port Security in Device Manager

To configure port security, follow these steps.

1. From the Configure menu, under Security, choose Port Security.
2. To make a secured MAC address subject to expiration, check Enable Aging.
3. In the Aging Period field, type the length of time from 10...10000000 seconds to hold a secured MAC address before it expires.  
The default is 3600 seconds.
4. Click Submit.
5. To configure port security parameters for a port, click the radio button next to the port name to select the row, and then complete the fields that are described in [Table 35](#).
6. Click Save.

← Security | **Port Security**

Enable Aging:

Aging Period:  Seconds

Port Security Table Selected 0 | Total 5

Port Name	Enable	Maximum MAC Count Allowed	Violation Mode	Sticky MAC
<input type="radio"/> Fa 1/1	false	1	protect	<input type="checkbox"/>
<input type="radio"/> Fa 1/2	false	1	protect	<input type="checkbox"/>
<input type="radio"/> Fa 1/3	false	1	protect	<input type="checkbox"/>
<input type="radio"/> Fa 1/4	false	1	protect	<input type="checkbox"/>
<input type="radio"/> Fa 1/5	false	1	protect	<input type="checkbox"/>

**Table 35 - Port Security Table Fields**

Field	Description
Port Name	Displays the port type (Fa for Fast Ethernet) and number.
Enable	To enable port security, choose true. To disable port security, choose false.

**Table 35 - Port Security Table Fields (continued)**

Field	Description
Maximum MAC Count Allowed	Enter the maximum number of MAC addresses that the switch can secure on this port before a security violation occurs. Valid range: 1 . . . 1024 Default: 4
Violation Mode	Choose one of the following modes to indicate the action to occur if the maximum number of secured MAC addresses is exceeded: <ul style="list-style-type: none"> <li>• protect</li> <li>• restrict</li> <li>• shutdown</li> </ul> For a description of each mode, see <a href="#">Table 34</a> .
Sticky MAC	Available only when port security is enabled (True). To convert a dynamic, secure MAC address to an address that is stored in the address table and added to the running configuration, check Sticky MAC. You can view the list of sticky MAC Enabled addresses and add them to the start-up configuration file on the Port Security page. See <a href="#">Table 54 on page 112</a> for information. If you clear a sticky MAC checkbox, the associated MAC address is converted to a dynamic, secure address and is removed from the running configuration.

## Configure Port Security in the Logix Designer Application

To configure port security, follow these steps.

1. In the navigation pane, click Port Security.
2. Complete the fields that are described in [Table 36](#).
3. Click Set.

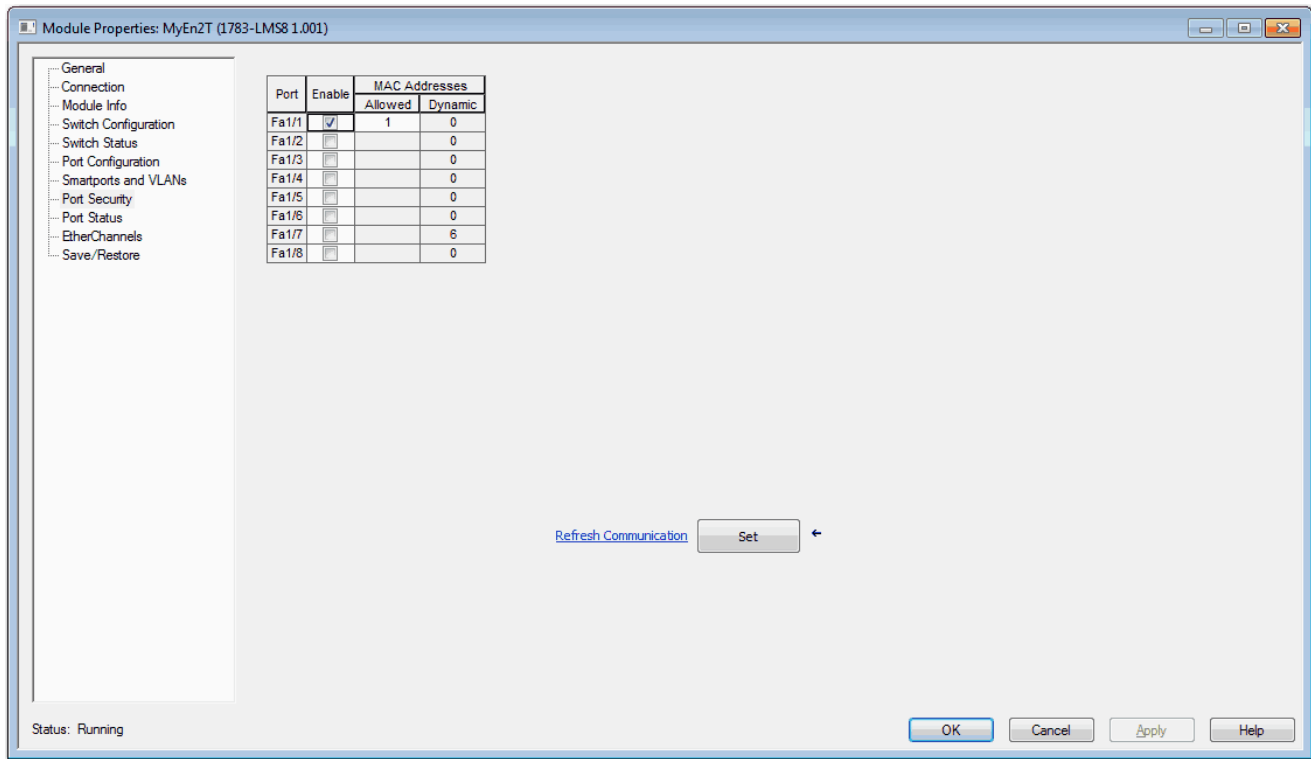

**Table 36 - Port Security Fields**

Field	Description
Port	Displays the port type (Fa for Fast Ethernet) and number.
Enable	To enable port security, check Enable. To disable port security, clear the Enable checkbox.
<b>MAC Addresses</b>	
Allowed	Enter the maximum number of MAC addresses that the switch can secure on this port before a security violation occurs: Valid range: 1...80 Default: 1 <ul style="list-style-type: none"> <li>• Dynamic—The number of MAC addresses (devices) currently connected to the port that is not manually (statically) defined.</li> <li>• Static—The number of MAC addresses (devices) statically defined by using Device Manager.</li> </ul> This number must be greater than the sum of the static + dynamic for a given port. If you wish to set the number to less, disconnect the appropriate devices and let their entries in the port security table timeout.
Dynamic	Displays the number of MAC addresses (devices) currently connected to the port that is not manually (statically) defined.
Static	Displays the number of MAC addresses (devices) statically defined in Device Manager.

## Quality of Service (QoS)

QoS provides priority service to different types of traffic. Without QoS, the switch offers best-effort service to each packet, regardless of the packet contents or size. QoS makes network performance more predictable and bandwidth utilization more effective.

The out-the-box configuration for Stratix® 2500 switches automatically provides QoS to prioritize EtherNet/IP, Precision Time Protocol (PTP), and other industrial traffic. To provide priority service to a type of traffic, a device can be configured to mark packets. Other devices can be configured to trust these markings. The QoS configuration that is provided with a Stratix 2500 switch enables the switch to trust markings on packets, but the switch does not mark packets itself.

In Device Manager, you can enable additional QoS priority settings on switch ports. These settings prioritize the streaming media traffic. We do not recommend enabling QoS priority settings on ports that transmit industrial automation traffic.

To enable QoS priority settings on a switch port, follow these steps.

1. From the Configure menu, under Network, choose QoS.
2. Click the port name of the desired row.
3. Check Enable.
4. Click Save.

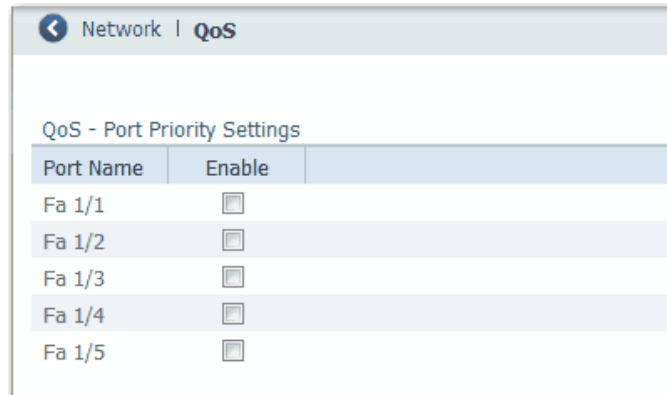

## Simple Network Management Protocol (SNMP)

SNMP is based on three concepts:

- SNMP manager (client software)—The SNMP manager runs SNMP management software.
- SNMP agents (network devices)—Network devices to be managed, such as bridges, routers, servers, and workstations, have an agent software module.
- Management Information Base (MIB)—A local MIB of objects that reflects the resources and activity of the device.

The agent provides access to the MIB. The agent also responds to manager commands to retrieve values from the MIB and to set values in the MIB. The agent and the MIB are on the switch. To configure SNMP on the switch, you define the relationship between the manager and the agent.

SNMP is enabled on the switch by default. The switch supports SNMP versions SNMPv1, SNMPv2C, and SNMPv3. Both SNMPv1 and SNMPv2C use a community-based form of security. The community of managers able to access the MIB of the agent is defined by an IP address access control list (ACL) and password. The switch supports the MIBs listed on [page 78](#).

The SNMPv3 architecture uses the User-based Security Model (USM) for message security and the View-based Access Control Model (VACM) for access control. SNMPv3 provides for both security models and security levels. A security model is an authentication strategy set for a user and the group within which the user resides. A security level is the permitted level of security within a security model. A combination of the security level and the security model determines which security mechanism is used when handling an SNMP packet. Available security models are SNMPv1, SNMPv2C, and SNMPv3.

The following are guidelines for SNMPv3 objects:

- Each user belongs to a group.
- A group defines the access policy for a set of users.
- An access policy defines which SNMP objects can be accessed for read, write, and notify operations.
- A group determines the list of notifications that its users can receive and the security model and security level for its users.
- An SNMP view is a list of MIBs that a group can access. Data can be securely collected from SNMP devices without fear of the data being tampered with or corrupted.
- Confidential information, for example, SNMP Set command packets that change a router configuration, can be encrypted to help prevent the contents from being exposed on the network.

Stratix 2500 switches support the following MIBs.

<b>MIB Name</b>
CIE1000-AGGR-MIB
CIE1000-ALARM-MIB
CIE1000-DHCP-SNOOPING-MIB
CIE1000-FIRMWARE-MIB
CIE1000-HTTPS-MIB
CIE1000-ICFG-MIB
CIE1000-IP-MIB
CIE1000-IPMC-PROFILE-MIB
CIE1000-IPMC-SNOOPING-MIB
CIE1000-LACP-MIB
CIE1000-LLDP-MIB
CIE1000-MAC-MIB
CIE1000-MIRROR-MIB
CIE1000-MSTP-MIB
CIE1000-NTP-MIB
CIE1000-PORT-MIB
CIE1000-PSEC-MIB
CIE1000-QOS-MIB
CIE1000-SNMP-MIB
CIE1000-SSH-MIB
CIE1000-SYSLOG-MIB
CIE1000-SYSUTIL-MIB
CIE1000-TC
CIE1000-USERS-MIB
CIE1000-VLAN-MIB
CISCO-IE1000-MIB
CISCO-SMI

You can configure SNMP in Device Manager.

To configure SNMP, follow these steps.

1. From the Configure menu, under Security, choose SNMP.
2. To enable SNMP, check Enable.  
or  
To disable SNMP, clear the Enable checkbox.  
By default, SNMP is enabled.
3. Click Submit.
4. Proceed to the following sections:
  - [System Options on page 80](#)
  - [Community Strings on page 81](#)
  - [Traps on page 82](#)
  - [View on page 83](#)
  - [Users on page 83](#)
  - [Group on page 84](#)

The screenshot shows the SNMP configuration page in a web interface. The page title is "Security | SNMP". The "SNMP Mode" is set to "Enable" with a checked checkbox. The "Engine Id" is "800000090300EBD57D9380". There is a "Submit" button below the Engine Id field. Below this, there are tabs for "System Options", "Community Strings", "Traps", "View", "Users", and "Group". The "System Options" tab is active, showing "System Location" and "System Contact" input fields, each with a "Submit" button below it. Below the input fields, there is a section for "SNMP Trap Host" with a "Selected 0 | Total 0" indicator and a gear icon. There are "Add", "Edit", and "Delete" icons. Below this is a table with columns: Name, IP Address, Community, Port, Version, and User Name. The table is currently empty, with the text "No data available" below it.

### System Options

To enter system information, click the System Options tab:

- System Location—Enter the location of the switch. The location name cannot contain ?, tab, or ^. The maximum length is 256 characters.
- System Contact—Enter the name of the administrator for the switch or network. The name cannot contain ?, tab, or ^. The maximum length is 256 characters.

In the SNMP Trap Host table, click Add to set SNMP trap recipients. To edit or delete a host, select the row in the SNMP Host table and click Edit or Delete.

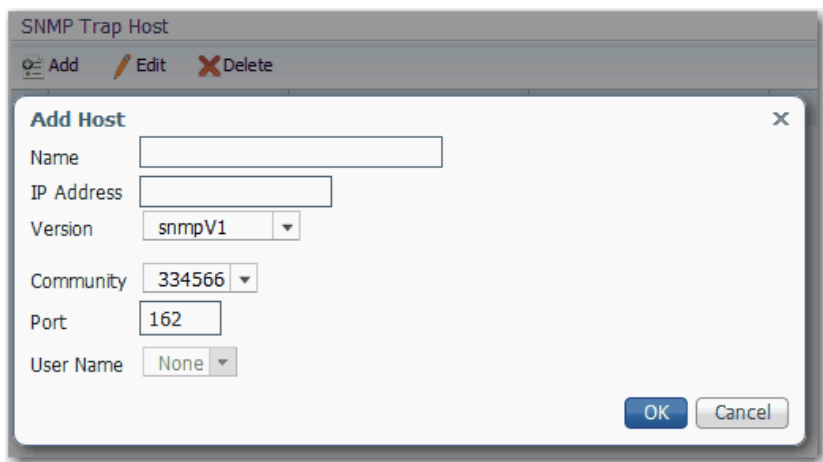

**Table 37 - Add Host Fields**

Field	Description
Name	Enter the name of the trap destination.
IP Address	Enter the SNMP trap destination IP address in dotted decimal notation.
Version	Choose the version of SNMP used to send traps: <ul style="list-style-type: none"> <li>• snmpV1—SNMP version 1</li> <li>• snmpV2c—SNMP version 2c</li> <li>• snmpV3—SNMP version 3</li> </ul>
Community	Choose the community string for this host. Community strings are configured on the SNMP Community Strings tab.
Port	Enter the SNMP trap destination port. The SNMP agent sends SNMP messages through this port. Valid port range: 1...65535 Default: 162
User Name	Choose the name of the user on the host that connects to the agent. Users are configured on the SNMP Users tab.



## Community Strings

Community strings are passwords to the MIB of the device. When you create a community, Device Manager automatically adds the community to default group default\_ro\_group or default\_rw\_group, based on the access you configure for the community (read-only or read-write). Two entries are added to the table on the Groups tab, one for version v1 and one for version v2c.

A read-only community string enables the switch to validate Get (read-only) requests from a network management station. If you set the SNMP read community, users can access MIB objects, but cannot change them.

A read-write community string enables the switch to validate Set (read-write) requests from a network management station.

If you delete a community, Device Manager automatically removes the community from the group.

To add, edit, or delete community strings, click the Community Strings tab.

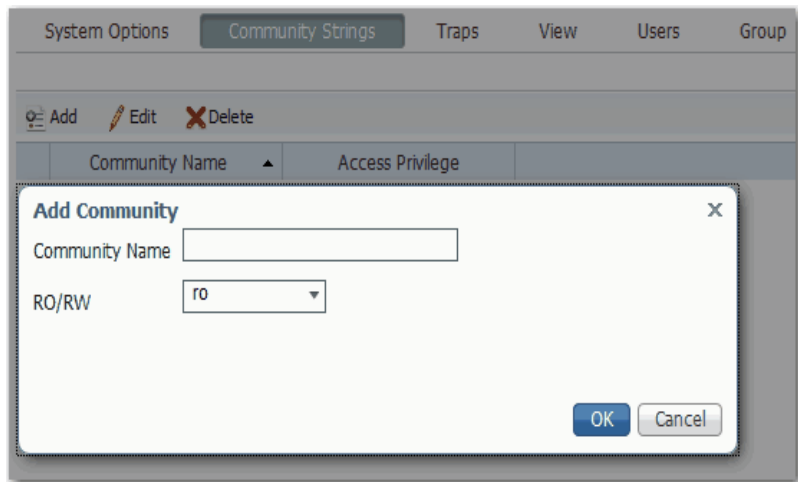

**Table 38 - Add Community Fields**

Field	Description
Community Name	(Editable only when adding a string). Enter a name for the community string. Valid length: 1...255 characters Valid characters: ASCII characters from 33 ... 126
RO/RW	Choose the type of access to the agent to permit the community string: <ul style="list-style-type: none"> <li>ro—Read-only: Authorized managers can retrieve MIB objects.</li> <li>rw—Read-write: Authorized managers can retrieve and edit MIB objects.</li> </ul>

### Traps

Traps are messages that alert the SNMP manager to a condition on the network, such as improper user authentication, restarts, link status (up or down), or other significant events.

To enable and disable traps, click the Traps tab:

- To enable a trap, check the corresponding checkbox and click Submit.
- To disable a trap, clear the corresponding checkbox and click Submit. To clear all checkboxes at once, click Clear All.

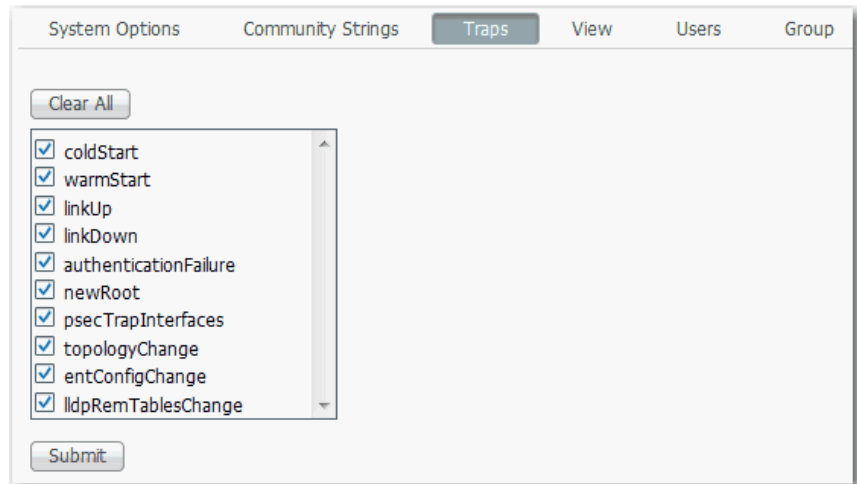

**Table 39 - Traps Tab Checkboxes**

Trap	Description
coldStart	The trap is generated when the device is reloaded.
warmStart	The trap is generated when the SNMP server is manually started.
linkUp	The trap is generated when the port changes from the Down state to the Up state.
linkDown	The trap is generated when the port changes from the Up state to the Down state.
authenticationFailure	The trap is generated if any network management server polls the device using SNMP with the wrong community string.
newRoot	The trap is generated when STP is enabled, the topology changes, and the protocol selects a new root.
psecTrapInterfaces	The trap is generated when a port security violation occurs and the violation mode is shut down. The trap message includes information about the violation, such as the interface, violation count, and error disable status. For more information, see <a href="#">page 72</a>
topologyChange	The trap is generated by a bridge when any of the bridge configured ports transitions from the Learning state to the Forwarding state or from the Forwarding state to the Blocking state.
entConfigChange	The trap is generated to signal a change to the last change time stamp. This trap is generated when the value of entLastChangeTime changes.
lldpRemTablesChange	The trap is generated when Link Layer Discovery Protocol (LLDP) is enabled and connected to another device with LLDP. When LLDP at the remote device changes, this event is transmitted through LLDP and triggers this trap.

### View

To display Management Information Base (MIB) views that control the Object Identifier (OID) range that SNMPv3 users can access, click the View tab. View information is read-only, and the only available view is default\_view, which is included in the default configuration in the switch software image. All groups are associated with default\_view.

View Name	Subtree	View Type
default_view	.1	included

**Table 40 - View Tab Fields**

Field	Description
View Name	A string that identifies the view.
Subtree	The OID that defines the root of the subtree for the named view.
View Type	The type of view: <ul style="list-style-type: none"> <li>included—The subtree is included in the view.</li> <li>excluded—The subtree is excluded from the view.</li> </ul>

### Users

To add, edit, or delete SNMP users, click the Users tab.

- To add a user, click Add. Complete the fields that are described as follows and click OK.
- To edit a user, click the radio button next to the user. Edit the fields that are described as follows and click OK.
- To delete a user, click the radio button next to the user and click Delete.

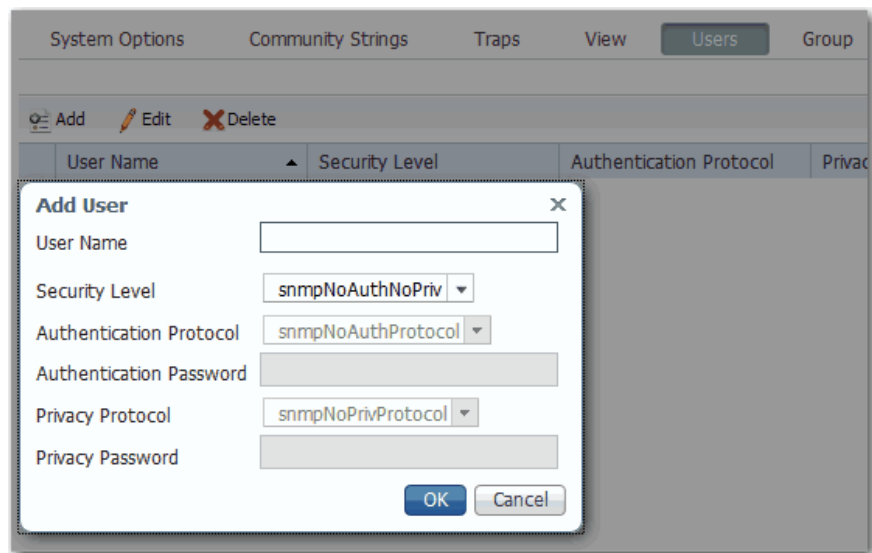

**Table 41 - Add User Fields**

Field	Description
User Name	(Editable only when adding a user). Enter a name to identify the user. Valid length: 1 . . . 32 characters Valid characters: ASCII characters from 33 . . . 126
Security Level	Choose a security level for the user: <ul style="list-style-type: none"> <li>• snmpNoAuthNoPriv—No authentication and no privacy.</li> <li>• snmpAuthNoPriv—Authentication and no privacy.</li> <li>• snmpAuthPriv—Authentication and privacy.</li> </ul>
Authentication Protocol	(Editable when the security level is snmpAuthNoPriv or snmpAuthPriv). Choose an authentication protocol for the user: <ul style="list-style-type: none"> <li>• snmpNoAuthProtocol—No authentication protocol. This protocol is automatically assigned when the security level is snmpNoAuthNoPriv.</li> <li>• snmpMD5AuthProtocol—MD5 Message-Digest Algorithm authentication protocol.</li> <li>• snmpSHAAuthProtocol—Secure Hash Algorithm authentication protocol.</li> </ul>
Authentication Password	Enter an authentication password phrase. Valid length for MD5 authentication protocol: 8 . . . 32 characters Valid length for SHA authentication protocol: 8 . . . 40 characters Valid characters: ASCII characters from 33 . . . 126 Enter a password within these guidelines: <ul style="list-style-type: none"> <li>• Must be at least eight alphanumeric characters long</li> <li>• Must contain an uppercase character, a lowercase character, a special character such as @\$!%*+=_?&amp;, and a number</li> <li>• Is case sensitive</li> <li>• Cannot contain a tab, nor space at the beginning or end</li> </ul>
Privacy Protocol	(Editable when the security level is snmpAuthPriv). Choose a privacy protocol for the user: <ul style="list-style-type: none"> <li>• snmpNoPrivProtocol—No privacy protocol. This protocol is automatically assigned when the security level is snmpNoAuthNoPriv or snmpAuthNoPriv.</li> <li>• snmpDESPrivProtocol—Data Encryption Standard privacy protocol.</li> <li>• snmpAESPrivProtocol—Advanced Encryption Standard privacy protocol.</li> </ul>
Privacy Password	Enter a privacy password phrase. Valid length: 8 . . . 32 characters Valid characters: ASCII characters from 33 . . . 126 Enter a password within these guidelines: <ul style="list-style-type: none"> <li>• Must be at least eight alphanumeric characters long</li> <li>• Must contain an uppercase character, a lowercase character, a special character such as @\$!%*+=_?&amp;, and a number</li> <li>• Is case sensitive</li> <li>• Cannot contain a tab, nor space at the beginning or end</li> </ul>

*Group*

An SNMP group is an access control policy to which you can assign users. Each SNMP group is associated with a security model and an SNMP view. A user within an SNMP group must match the security model of the SNMP group. These parameters specify what type of authentication and privacy a user within an SNMP group uses. Each SNMP group name and security model pair must be unique.

Users that you add on the Users tab automatically use the USM (SNMPv3) security model.

When you create a community, Device Manager automatically assigns the community to one of the following default groups:

- default\_ro\_group for communities with read-only access
- default\_rw\_group for communities with read-write access

Two entries are added to the table on the Groups tab, one for version v1 and one for version v2c.

If you delete a community, Device Manager automatically removes the community from the group.

To add, edit, or remove SNMP groups, click the Group tab:

- To add a group, click Add. Complete the fields and click OK.

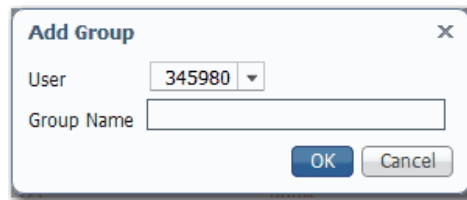

The 'Add Group' dialog box contains the following fields and controls:

- User:** A dropdown menu with the value '345980' selected.
- Group Name:** An empty text input field.
- Buttons:** 'OK' and 'Cancel' buttons at the bottom right.

- To edit the name of a group, click the radio button next to the group. Edit the name and click OK. You cannot edit the default RO/RW groups.
- To delete a group, click the radio button next to the group and click Delete. You cannot delete the default RO/RW groups.

System Options    Community Strings    Traps    View    Users <b>Group</b>			
Add    Edit    Delete			
	Version	User Or Community	Group Name
<input type="radio"/>	v1	public	default_ro_group
<input checked="" type="radio"/>	v1	private	default_rw_group
<input type="radio"/>	v2c	public	default_ro_group
<input type="radio"/>	v2c	private	default_rw_group

**Table 42 - Group Tab Fields**

Field	Description
Version	(Not editable). Displays the security model for the group: <ul style="list-style-type: none"> <li>• v1—SNMPv1</li> <li>• v2c—SNMPv2c</li> <li>• usm—SNMPv3 User-based Security Model (USM)</li> </ul>
User or Community	(Editable only when adding a group). Enter the name of the user or community to assign to the group. You must add users on the Users tab before you can assign them to a group. Communities are automatically assigned to the default_ro_group or default_rw_group when you create the community on the Community Strings tab.
Group Name	Enter a name to identify the group. Valid length: 1 . . . 32 characters Valid characters: ASCII characters from 33 . . . 126

## Smartports

Smartports are recommended configurations for switch ports. These configurations, referred to as Smartport roles, optimize the switch connections and provide security, transmission quality, and reliability for traffic from the switch ports. Smartport roles also help prevent port misconfigurations. You can apply a Smartport role to a specific port or multiple ports.

- 
- IMPORTANT**
- Use Smartports immediately after the initial setup of the switch to configure the switch ports before they connect to devices.
  - Always verify that the correct Smartport Role is applied before you connect a device to the port or reconnect a device that was moved.
  - When you apply a Smartport role, some existing settings on the port are removed.
  - We recommend that you do not change the port settings after enabling a Smartport role. Any such changes can alter the effectiveness of the Smartport role.
- 

The Smartport roles that are described in [Table 43](#) are based on the type of devices to be connected to the switch ports. For example, the Desktop for Automation port role is specifically for switch ports to be connected to desktop and laptop computers.

You can assign Smartport roles in Device Manager or the Logic Designer application.

**Table 43 - Smartport Roles**

Role	Description
Automation Device	Apply this role to ports to be connected to EtherNet/IP (Ethernet Industrial Protocol) devices. It can be used for industrial automation devices, such as logic controllers and I/O: <ul style="list-style-type: none"> <li>• Port is set to Access mode.</li> <li>• Port security supports only one MAC address.</li> </ul>
Multiport Automation Device	Apply this role to ports connected to multiport EtherNet/IP devices. Devices include multiport EtherNet/IP devices that are arranged in a linear or daisy chain topology, the 1783-ETAP module (for connection to only the device port), unmanaged switches, such as the Stratix 2000, and managed switches with Remote Spanning Tree Protocol (RSTP) disabled: <ul style="list-style-type: none"> <li>• Port is set to Access mode.</li> <li>• No port security.</li> </ul>
Desktop for Automation	Apply this role to ports to be connected to desktop devices, such as desktop computers, workstations, notebook computers, and other client-based hosts: <ul style="list-style-type: none"> <li>• Port is set to Access mode.</li> <li>• Portfast enabled.</li> <li>• Port security supports only one MAC address.</li> </ul> Do not apply to ports to be connected to switches, routers, or access points.
Virtual Desktop for Automation	Apply this role to ports connected to computer running virtualization software. Virtual Desktop for Automation can be used with devices running up to two MAC addresses: <ul style="list-style-type: none"> <li>• Port is set to Access mode.</li> <li>• Portfast is enabled.</li> <li>• Port security supports two MAC addresses.</li> </ul> <b>IMPORTANT:</b> Do not apply the Virtual Desktop for Automation role to ports that are connected to switches, routers, or access points.
Switch for Automation	Apply this role to ports to be connected to other switches with Spanning Tree enabled. Port is set to Trunk mode.
Wireless-automation-access	(Available in Device Manager only). Apply this role to ports to be connected to wireless access points that use a single VLAN.
Wireless-automation-trunk	(Available in Device Manager only). Apply this role to ports to be connected to wireless access points that use multiple VLANs.

## Avoid Smartport Mismatches

A Smartport mismatch occurs when an attached device does not match the Smartport role that is applied to the switch port. Mismatches can have adverse effects on devices and your network.

Mismatches can result in the following conditions:

- Affect the behavior of the attached device
- Lower network performance, such as the level of QoS on CIP, wireless, and switch traffic
- Reduce restrictions on guest access to the network
- Reduce protection from denial-of-service (DoS) attacks on the network
- Disable or shut down the port

## Assign Smartport Roles and VLANs in Device Manager

To assign Smartport roles and VLANs, follow these steps.

1. From the Configure menu, under Network, choose Smartports.
2. Check the checkbox next to the port to which to assign a Smartport role and click Edit.
3. From the Role pull-down menu, choose the Smartport role to assign to the port, or choose None to remove the assigned Smartport role.

For a description of Smartport roles, see [Table 43](#).

4. From the Access VLAN or Native VLAN pull-down menu, choose a VLAN to assign to the port.
5. Click Submit.

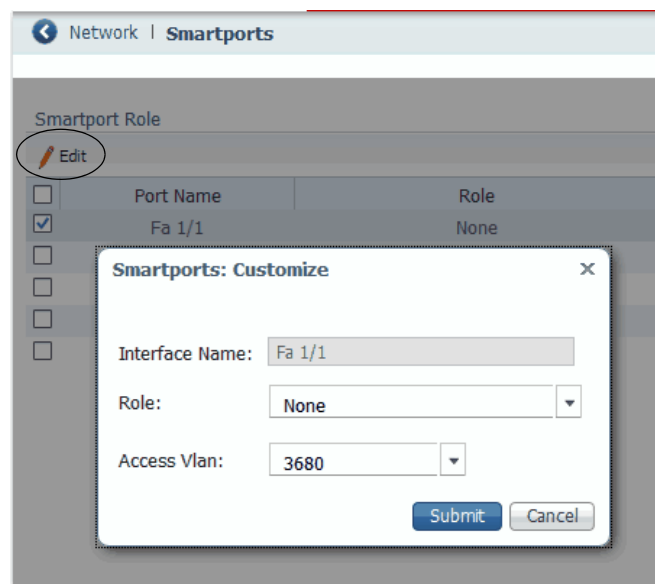



## Assign Smartport Roles and VLANs in the Logix Designer Application

To assign Smartport roles and VLANs, follow these steps.

1. In the navigation pane, click Smartports and VLANs.
2. Complete the fields that are described in [Table 44](#).
3. Click Set.

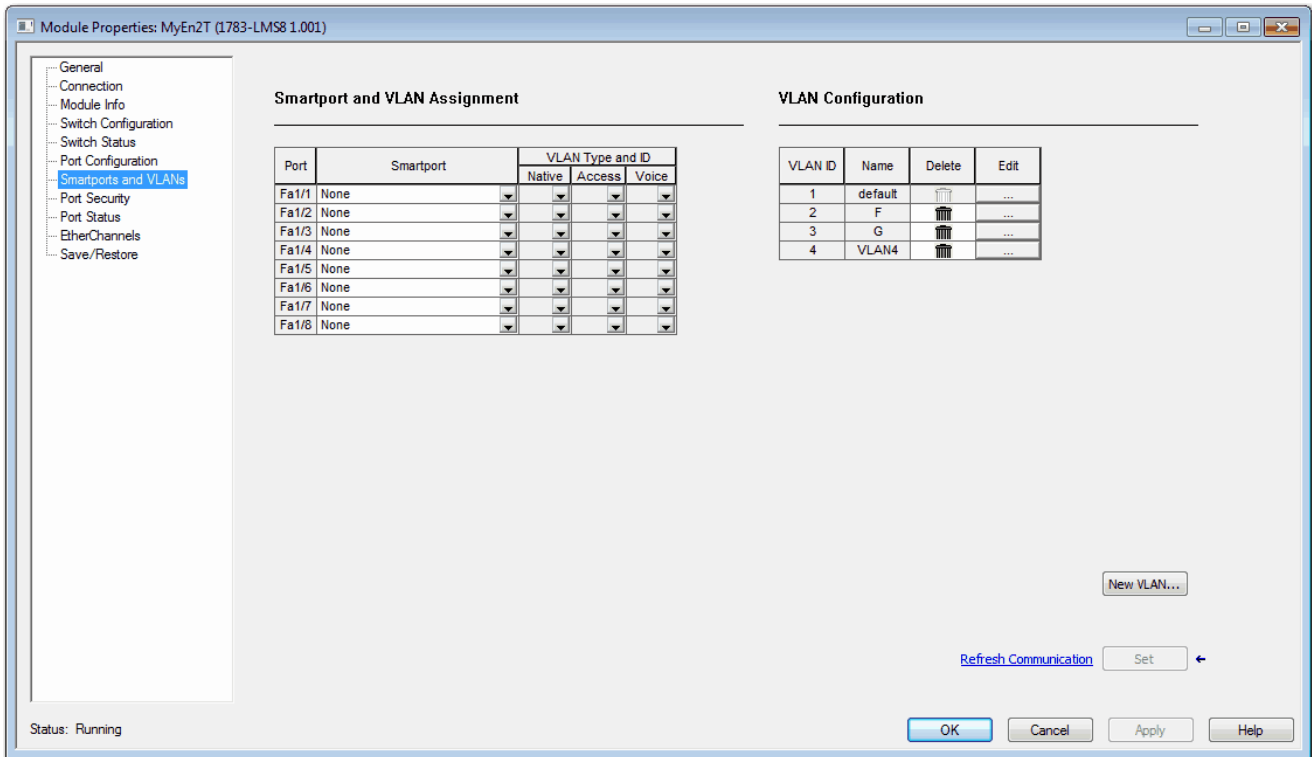

**Table 44 - Smartport and VLAN Assignment Fields**

Field	Description
Port	Displays the port type (Fa for Fast Ethernet) and number.
Smartport	Choose the Smartport role to apply to the connected port. For descriptions of each role, see <a href="#">Table 43 on page 87</a> .
<b>VLAN Type and ID</b>	
Native	Choose the native VLAN ID for ports set to Switch for Automation. A native VLAN is for ports that can belong to multiple VLAN.
Access	Choose the access VLAN ID for ports set to Automation Device, Desktop for Automation, Phone for Automation, or Automation Device. An access VLAN is for ports that can belong to only one VLAN.
Voice	Not available in the current release.

## Spanning Tree Protocol (STP)

STP is a Layer 2 link management protocol that provides path redundancy while helping to prevent loops in the network. For a Layer 2 Ethernet network to function properly, only one active path can exist between any two stations. Multiple active paths among end stations cause loops in the network. If a loop exists in the network, end stations can receive duplicate messages. Switches can also learn end-station MAC addresses on multiple Layer 2 interfaces. These conditions result in an unstable network. Spanning-tree operation is transparent to end stations, which cannot detect whether they are connected to a single LAN segment or a switched LAN of multiple segments.

The STP uses a spanning-tree algorithm to select one switch of a redundantly connected network as the root of the spanning tree. The algorithm calculates the best loop-free path through a switched Layer 2 network by assigning a role to each port based on the role of the port in the active topology:

- Root—A forwarding port that is elected for the spanning-tree topology.
- Designated—A forwarding port that is elected for every switched LAN segment.
- Alternate—A blocked port providing an alternate path to the root bridge in the spanning tree.
- Backup—A blocked port in a loopback configuration.

The switch that has the Designated role or the Backup role assigned to all of its ports is the root switch. The switch that has the Designated role assigned to at least one of its ports is called the designated switch.

Spanning tree forces redundant data paths into a standby (blocked) state. If a network segment in the spanning tree fails and a redundant path exists, the spanning-tree algorithm recalculates the spanning-tree topology and activates the standby path. Switches send and receive spanning-tree frames, called bridge protocol data units (BPDUs), at regular intervals. The switches do not forward these frames but use them to construct a loop-free path. BPDUs contain information about the sending switch and its ports, including switch and MAC addresses, switch priority, port priority, and path cost. Spanning tree uses this information to elect the root switch and root port for the switched network and the root port and designated port for each switched segment.

For more information about STP, see the IEEE 802.1D MAC Bridges Standard.

## Spanning Tree Modes

The switch supports three Spanning Tree modes, as described in [Table 45](#).

**Table 45 - Spanning Tree Modes**

Mode	Description
STP (Spanning Tree Protocol)	Creates a spanning tree within a network of connected, Layer 2 switches and disables links that are not part of the spanning tree. Creates a single active path between any two network nodes.
MSTP (Multiple Spanning Tree Protocol)	Multiple VLANs are mapped to the same spanning-tree instance, reducing the number of spanning-tree instances that are needed to support many VLANs. MSTP is the default mode.
RSTP (Rapid Spanning Tree Protocol)	Provides rapid convergence of the spanning tree through explicit handshaking that minimizes the 802.1D forwarding delay and quickly transitions root ports and designated ports to the forwarding state.

## PortFast Features

PortFast features are typically enabled only on access ports. Access ports connect to devices such as personal computers, access points, and servers that are not expected to send bridge protocol data units (BPDUs). These features are typically not enabled on ports that connect to switches because spanning tree loops can occur.

Switches exchange special frames that are called BPDUs to communicate network information, to track changes, and to create the STP topology. Because transmitted BPDUs reveal network information and received BPDUs can influence your STP topology, consider enabling BPDU Filtering and BPDU Guard on your access ports. These features help prevent a rogue device from interfering with your STP topology. However, we recommend that you use these features with caution:

- **BPDU Filtering**—This PortFast feature blocks all sending and receipt of BPDUs through all PortFast-enabled ports. This feature effectively disables STP on these ports and loops can result. If a BPDU is received, PortFast is disabled on the port and the global STP settings apply.
- **BPDU Guard**—This PortFast feature shuts down a port if it receives a BPDU.

If you enable both of these features, BPDU Guard has no effect because BPDU Filtering restricts the port from receiving any BPDUs.

Spanning tree requires an interface to progress through the listening and learning states, to exchange information and establish a loop-free path before it can forward frames. On ports that connect to devices such as workstations and servers, you can allow an immediate connection. PortFast immediately transitions the port into STP forwarding mode upon linkup.

## Configure STP in Device Manager

To configure STP, follow these steps.

1. From the Configure menu, under Spanning Tree, choose STP Settings.
2. On the Global tab, configure STP system settings for all STP bridge instances in the switch and click Submit.

---

**IMPORTANT** To change the Spanning Tree mode or the bridge priority affects connectivity to the switch. You can only change one of these settings at a time.

---

Spanning Tree | STP Settings

Global Port Fast

Spanning Tree Mode: MSTP

Bridge Priority: 32768

MSTP Name: e4-aa-5d-dc-6d-80

MSTP Revision: 0

Hello Time: 2

Forward Delay: 15

Max Age: 20

Maximum Hop Count: 20

Transmit Hold Count: 6

Submit

Add Edit Delete

Instance	VLANs Mapped
0	1-4094

**Table 46 - Global Tab Fields**

Field	Description
Spanning Tree Mode	Choose the STP mode to configure: <ul style="list-style-type: none"> <li>• STP</li> <li>• MSTP</li> <li>• RSTP</li> </ul> MSTP is the default mode. For a description of each mode, see <a href="#">Table 45 on page 91</a> .
Bridge Priority	Choose a bridge priority from the list of predefined values. The range is 0 . . 61440. Lower numeric values have higher priority. The bridge priority plus the Multiple Spanning Tree Instances (MSTI) number, concatenated with the 6-byte MAC address of the switch, forms a Bridge Identifier. For MSTP operation, the Bridge Identifier is the priority of the Common and Internal Spanning Tree (CIST). Otherwise, it is the priority of the STP/RSTP bridge.
MSTP Name	(Appears only when the Spanning Tree Mode is MSTP). Enter a name for the MSTP region. The name can have a maximum of 32 characters, which can include -, _ , ; , and . as special characters. The default MSTP name is blank.
MSTP Revision	(Appears only when the Spanning Tree Mode is MSTP). Enter a revision level for the MSTP region. Valid range: 0 . . 65535 Default: 0
Hello Time	Enter the interval between STP Bridge Protocol Data Units (BPDUs) to be sent. Valid range: 1 . . 10 seconds The default interval is 2 seconds. <b>IMPORTANT:</b> To change this parameter from the default value is not recommended and can have adverse effects on your network.
Forward Delay	Enter the delay that is used by STP bridges to transit root and designated ports to forwarding (used in STP compatible mode). Valid range: 4 . . 30 seconds Default: 15 seconds
Max Age	Enter the maximum age of the information that is transmitted by the bridge when it is the root bridge. Valid range: 6 . . 40 seconds, and Max Age must be $\leq (\text{FwdDelay}-1)*2$ . Default: 20 seconds
Maximum Hop Count	Enter the initial value of the remaining hops for MSTI information that is generated at the boundary of an MSTI region. It defines how many bridges a root bridge can distribute its BPDU information to. Valid range: 6 . . 40 hops Default: 20 hops
Transmit Hold Count	Enter the number of BPDUs a bridge port can send per second. When this count is exceeded, transmission of the next BPDU is delayed. Valid range: 1 . . 10 BPDUs per second Default: 6 hops

- To add a Multiple Spanning Tree (MST) instance and map VLANs to the instance, click Add, enter the instance and VLAN numbers and click OK.

You can add a maximum of seven MST instances. The default instance is 0.

All unmapped VLANs are mapped to instance 0. You cannot delete instance 0.

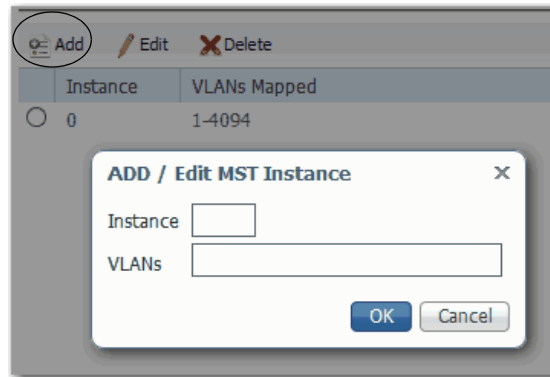

- On the Port Fast tab, specify the features to enable on all PortFast-enabled ports and click Submit:
  - To enable a feature, check Enable.
  - To disable a feature, clear the Enable checkbox.

By default, all features are enabled.

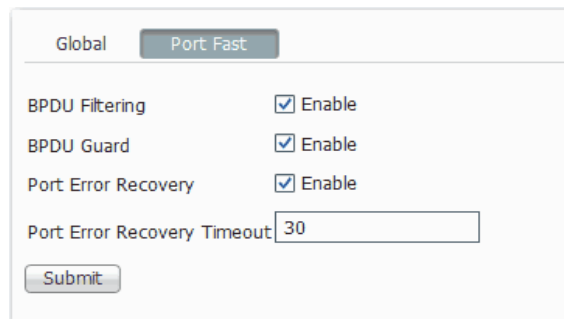

**Table 47 - Port Fast Fields**

Field	Description
BPDU Filtering	Avoids transmitting BPDUs on PortFast-enabled ports that are connected to an end system. When you enable PortFast on the device, spanning tree places ports in the forwarding state immediately, instead of going through the listening, learning, and forwarding states.
BPDU Guard	Helps prevent loops by moving a non-trunking port into an errdisable state when a BPDU is received on that port. When you enable BPDU guard on the switch, Spanning Tree shuts down PortFast-configured interfaces that receive BPDUs instead of putting them into the spanning tree blocking state. In a valid configuration, PortFast-configured interfaces do not receive BPDUs. If a PortFast-configured interface receives a BPDU, an invalid configuration exists. BPDU guard provides a secure response to invalid configurations because the administrator must manually put the interface back in service.
Port Error Recovery	Controls whether a port in the error-disabled state is automatically enabled after a certain time. If recovery is not enabled, ports must be disabled and re-enabled for normal STP operation. The condition is also cleared by a system restart.
Port Error Recovery Timeout	Enter the time to pass before a port in the error-disabled state can be enabled. Valid range: 30 . . . 6400 seconds (24 hours) Default: 30

- To configure how STP is implemented on individual ports, click a row in the Port-Interface Port Fast table, edit the settings, and click Save.

Per-Interface Port Fast Table											Total 5
Port Name	Port Type	STP Enabled	Admin Edge	Auto Edge	PathCost M...	Path Cost	Priority	Point-to-point	BPDU Guard	Restrict...	Restricted
Fa 1/1	access	<input checked="" type="checkbox"/>	<input type="checkbox"/>	<input checked="" type="checkbox"/>	Auto		128	auto	<input type="checkbox"/>	<input type="checkbox"/>	<input type="checkbox"/>
Fa 1/2	access	<input checked="" type="checkbox"/>	<input type="checkbox"/>	<input checked="" type="checkbox"/>	Auto		128	auto	<input type="checkbox"/>	<input type="checkbox"/>	<input type="checkbox"/>
Fa 1/3	access	<input checked="" type="checkbox"/>	<input type="checkbox"/>	<input checked="" type="checkbox"/>	Auto		128	auto	<input type="checkbox"/>	<input type="checkbox"/>	<input type="checkbox"/>
Fa 1/4	access	<input checked="" type="checkbox"/>	<input type="checkbox"/>	<input checked="" type="checkbox"/>	Auto		128	auto	<input type="checkbox"/>	<input type="checkbox"/>	<input type="checkbox"/>
Fa 1/5	access	<input checked="" type="checkbox"/>	<input type="checkbox"/>	<input checked="" type="checkbox"/>	Auto		128	auto	<input type="checkbox"/>	<input type="checkbox"/>	<input type="checkbox"/>

**Table 48 - Port-Interface Port Fast Table Fields**

Field	Description
Port Name	Displays the port type (Fa for Fast Ethernet) and number.
Port Type	Displays whether the port is an access port, trunk port, or hybrid port.
STP Enabled	Check STP Enabled to enable Spanning Tree Protocol on the port. By default, this setting is enabled.
Admin Edge	Check Admin Edge to enable the PortFast feature on the port. PortFast enables the port to bypass the listening and learning states and move immediately to forwarding. By default, this setting is disabled.
Auto Edge	Check Auto Edge to enable the port to transition to and from an edge port state automatically: <ul style="list-style-type: none"> <li>When the port receives a BPDU, the port automatically transitions from an edge port state into an STP port.</li> <li>When the port stops receiving a BPDU, the port automatically becomes an edge port and transitions through the discarding and learning states before resuming forwarding.</li> </ul> By default, this setting is enabled.
PathCost Mode	Choose a mode to determine how the path cost incurred by the port: <ul style="list-style-type: none"> <li>Auto—Sets the path cost as appropriate by the physical link speed by using the 802.1D recommended values.</li> <li>Specific—Allows you to enter a user-defined value.</li> </ul> The default mode is Auto.
Path Cost	(Editable when PathCost Mode is Specific). Enter the path cost to use when establishing the active topology of the network. Lower path cost ports are chosen as forwarding ports in favor of higher path cost ports. Valid range: 1 . . . 200000000
Priority	Choose a priority to assign to the port. Priority can be used to control ports having identical Path Cost. The lower the priority number, the higher the priority. Valid range: 0 . . . 240 Default: 128
Point-to-point	Choose whether the port connects to a point-to-point LAN rather than to a shared medium: <ul style="list-style-type: none"> <li>auto—The connection is automatically determined.</li> <li>forceFalse—The port connects to a shared medium.</li> <li>forceTrue—The port connects to a point-to-point LAN.</li> </ul> Transition to the forwarding state is faster for point-to-point LANs than for shared media. The default method is auto.
BPDU Guard	Check BPDU Guard to cause the port to disable itself upon receiving valid BPDUs. The edge status of the port does not affect this setting. By default, this setting is disabled.
Restricted Role	Check Restricted Role to cause the root port not to be selected as the root port for the CIST or any MSTI, even if it has the best spanning tree priority vector. A port with this setting is selected as an alternate port after the root port has been selected. <b>IMPORTANT:</b> If enabled, Restricted Role can cause a lack of spanning tree connectivity. A network administrator can use this setting to help prevent bridges external to a core region of the network from influencing the spanning tree active topology. This feature is also known as Root Guard. By default, this setting is disabled.
Restricted TCN	Check Restricted TCN to cause the port not to propagate received topology change notifications (TCNs) and topology changes to other ports. <b>IMPORTANT:</b> If enabled, Restricted TCN can cause temporary loss of connectivity after changes in the active topology of a spanning tree as a result of persistently incorrect learned station location information. A network administrator can use this setting to help prevent bridges external to a core region of the network to cause flushing of addresses in that region. By default, this setting is disabled.

## Storm Control

A traffic storm occurs when packets flood the LAN. This flooding creates excessive traffic and degrades network performance. You can configure the Storm Control policer level, or rate, to help prevent disruption of LAN ports by a unicast, multicast, or broadcast traffic storm on physical interfaces. Storm Control is configured globally on the switch.

When storm control is enabled for the specified packet type and a storm is detected, a syslog entry is generated. The interface remains up and drops all unknown packets that exceed the configured policer rate. An unknown packet is one for which the switch has no record of the MAC address or multicast group that is associated with it. No actions, such as error-disable, can be performed when a storm is detected.

When a storm is detected, an alarm appears in the Alarms area in the lower-right corner of the Device Manager window. This alarm causes the EIP Mod status indicator to flash red until the storm control condition is cleared.

You can configure storm control in Device Manager.

To configure storm control, follow these steps.

1. From the Configure menu, under Security, choose Storm Control.
2. Click the row for the traffic type to configure.
3. To enable storm control for the traffic type, check Enable.
4. In the Rate field, enter the rate in packets per second (pps).

The valid range is 1...1024000 pps.

5. Click Save.

Storm Control Table		
Storm	Enable	Rate (pps)
Unicast Packets	<input type="checkbox"/>	1
Multicast Packets	<input type="checkbox"/>	1
Broadcast Packets	<input type="checkbox"/>	1



## Terminal Access Controller Access Control System Plus/Remote Authentication Dial-In User Service (TACACS+/RADIUS)

TACACS+ and RADIUS are two security protocols that are used to control access to networks. The switch performs as a TACACS or RADIUS client to authenticate and authorize users.

You can configure up to two servers each for TACACS and RADIUS. TACACS+ uses TCP for communication between client and server, and RADIUS uses UDP.

You must configure at least one TACACS or RADIUS server to be able to select the TACACS or RADIUS AAA method for a user. Choose the Authentication, Authorization, Accounting (AAA) method (Tacacs, Radius, or local) for users on the Admin menu, Users page. See [Table 18 on page 40](#).

---

**IMPORTANT** Device Manager supports Admin (Privilege 15) and Read-Only (Privilege 5) user privileges. Confirm that these privileges are specified in the TACACS or RADIUS server configuration files.

---

You can configure a server or change server settings in Device Manager.

To access the settings, follow these steps.

1. From the Configure menu, under Security, choose Tacacs/Radius.
2. Click the tab for Tacacs or Radius to configure the server.

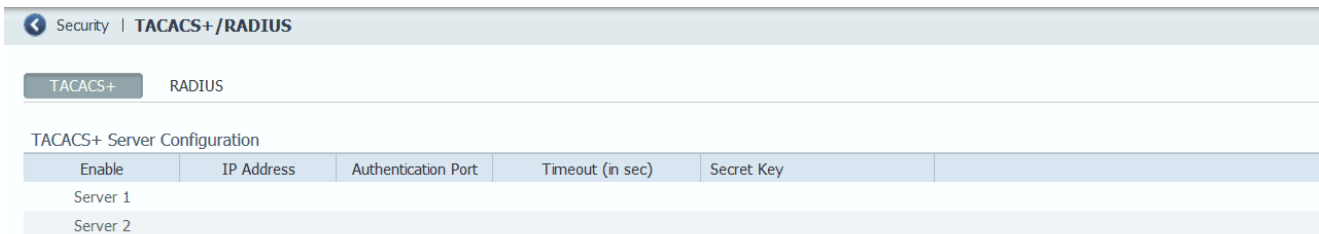

**Table 49 - Tacacs+ Server Configuration Fields**

Field	Description
Enable	Enter the server 1 or server 2 IP address to enable communication with the TACACS server.
IP Address	Enter the IP address of the TACACS server.
Authentication Port	Enter the TACACS server port number. Valid range: 1...65535 Default: 49
Timeout (in sec)	Enter the time interval for the switch to wait for a response from the TACACS server to reply before resending communication. Valid range: 1...1000 Default: 5
Secret Key	Enter the secret key text string to provide encryption for the TACACS server communications. The value is displayed as ****.

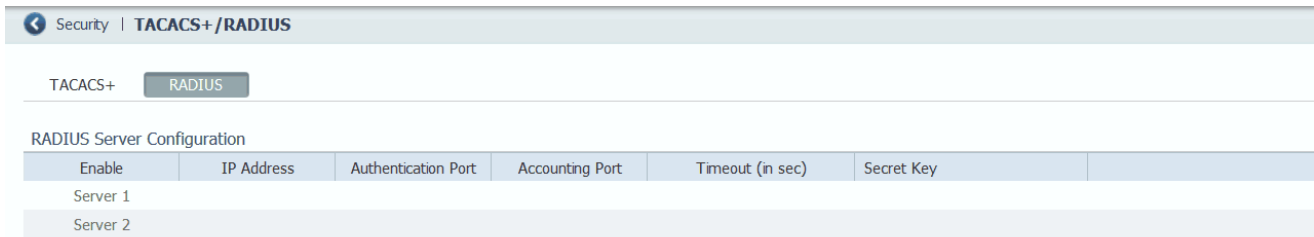

**Table 50 - Radius Server Configuration Fields**

Field	Description
Enable	Enter the server 1 or server 2 IP address to enable communication with the RADIUS server.
IP Address	Enter the IP address of the RADIUS server.
Authentication Port	Enter the RADIUS UDP destination port for authentication requests. Default: 1812
Accounting Port	Enter the RADIUS UDP destination port for accounting requests. Default: 1813
Timeout (in sec)	Enter the time interval for the switch to wait for a response from the RADIUS server to reply before resending communication. Valid range: 1 . . . 1000 Default: 5
Secret Key	Enter the secret key text string to provide encryption for the RADIUS server communications. The value is displayed as ****.

## Virtual Local Area Networks (VLANs)

Stratix 2500 switches can segment your network into VLANs. A VLAN is a logical segment of the network that isolates traffic types and helps prevent collisions among data packets. The isolation of different types of traffic helps to preserve the quality of the transmission and to minimize excess traffic among the logical segments. VLANs can also reduce the amount of administrative effort that is required to examine requests to network resources.

Devices that are attached to the switch ports in the same VLAN can communicate only with each other and can share data. Devices that are attached to switch ports in different VLANs cannot communicate with each other through the switch, unless the switch is configured for routing. A Layer 3 switch or router must be configured to enable routing across multiple VLANs and additional security policies must be set. If your network is using a DHCP server, make sure that the server is accessible to the devices in all VLANs.

We recommend that you first determine your VLAN needs before creating VLANs. For more information about VLANs, refer to these publications:

- Converged Plantwide Ethernet (CPwE) Design and Implementation Guide, publication [ENET-TD001](#)
- Ethernet Design Considerations, publication [ENET-RM002](#)

With the Stratix 2500 switch, you can configure a maximum of 64 VLANs. The switch is preconfigured with a default VLAN, which has ID 1. To create a VLAN, you must give the VLAN a name and a unique ID. You can edit the name of a VLAN but not its ID. You cannot rename or delete the default VLAN ID.

The default VLAN is also the management VLAN. After the initial setup, you can create VLANs and designate any VLAN on the switch as the management VLAN. The management VLAN provides administrative access to the switch. You must assign one of the switch ports to the management VLAN. Otherwise, you do not have administrative access to the switch. Initially, all ports are assigned to the management VLAN.

You can configure VLANs in Device Manager or the Logix Designer application.

---

**IMPORTANT** Before you assign a port to a VLAN, make sure that the port has the appropriate Smartport role.

---

## Configure VLANs in Device Manager

To add or remove a port that is assigned to a VLAN, edit the port settings, as described on [page 30](#).

From the Configure menu, under Network, choose VLAN Management.

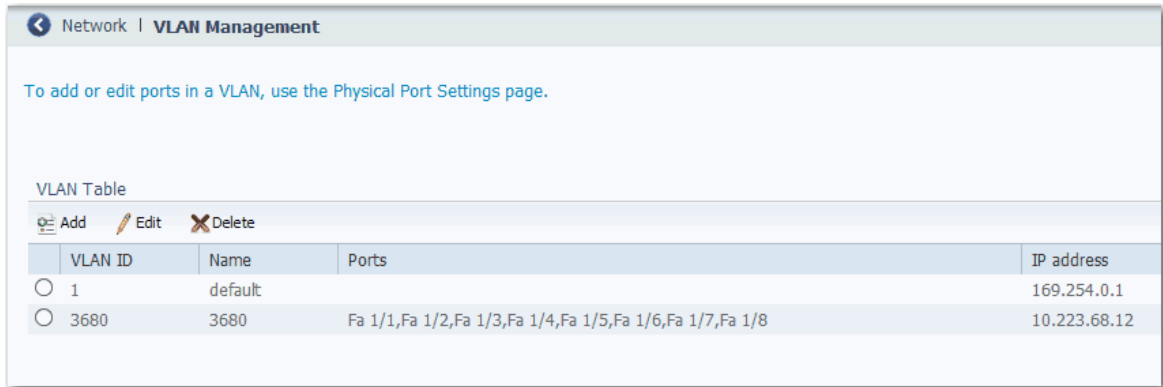

You can add, edit, or delete a VLAN:

- To add a VLAN, click Add, complete the fields, and click OK.

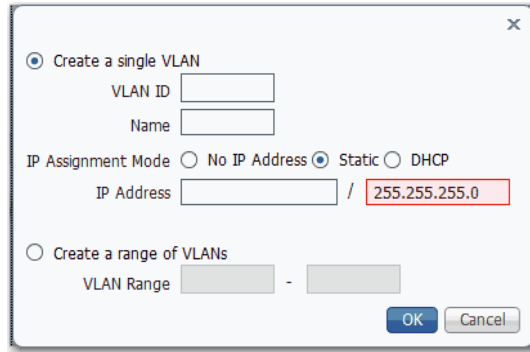
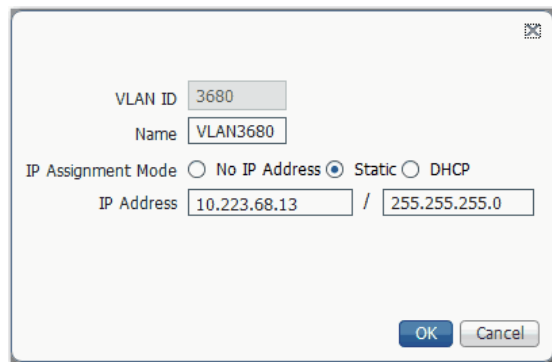

**Table 51 - Add VLAN Fields**

Field	Description
Create a single VLAN VLAN ID, Name	Click this radio button to configure one VLAN, and then enter a unique ID and name to identify the VLAN. Valid range: 1...4094
IP Assignment Mode IP Address	(Editable only when Create a single VLAN is clicked). Click to specify how to assign an IP address for the VLAN: <ul style="list-style-type: none"> <li>No IP Address—Assign no IP address.</li> <li>Static—Assign a static IP address.</li> <li>DHCP—Allow a DHCP server to assign an IP address.</li> </ul> If you clicked Static, then in the IP Address fields, enter the static IP address and subnet mask to assign to the VLAN.
Create a range of VLANs VLAN Range	Click this radio button to configure multiple VLANs and to enter a range of numbers to identify each VLAN. Valid range: 1...4094

- To edit a VLAN, click the radio button next to the VLAN. Click Edit, edit the fields, and click OK.

You can edit the name of a VLAN, but not the VLAN ID.



- To delete a VLAN, click the radio button next to the VLAN and click Delete.

### Configure VLANs in the Logix Designer Application

To assign ports to VLANs, see [page 89](#).

From the navigation pane, click Smartports and VLANs.

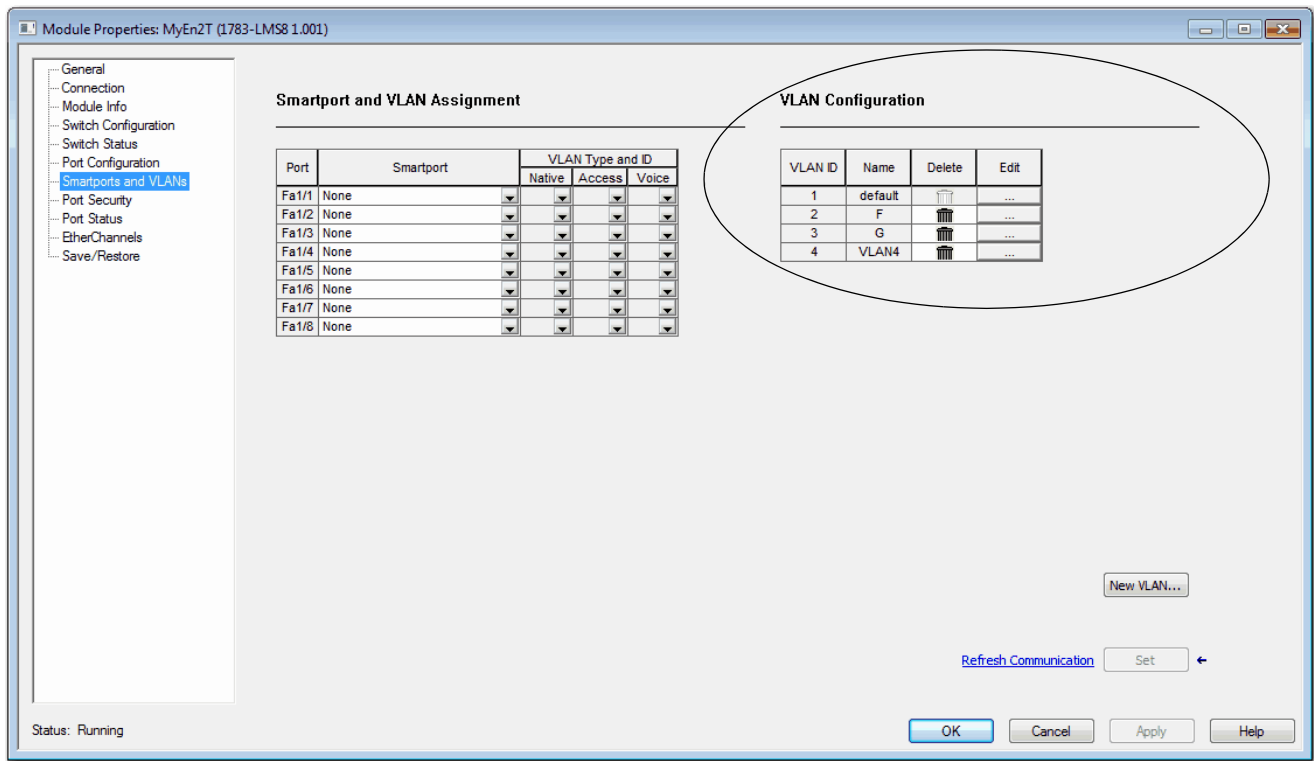

You can add, edit, or delete a VLAN:

- To add a VLAN, click New VLAN. Enter the VLAN ID and name. Click Set and click Close.

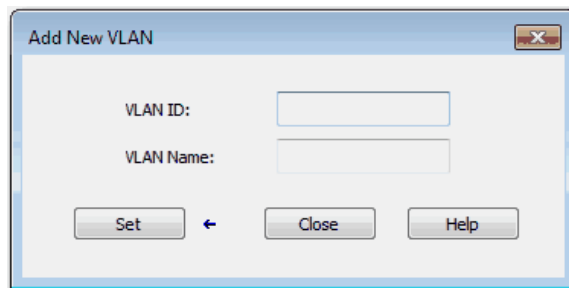

- To edit a VLAN, click the corresponding Ellipse button in the Edit column. Edit the VLAN ID and name. Click Set and click Close.

You can edit the name of a VLAN, but not the VLAN ID.

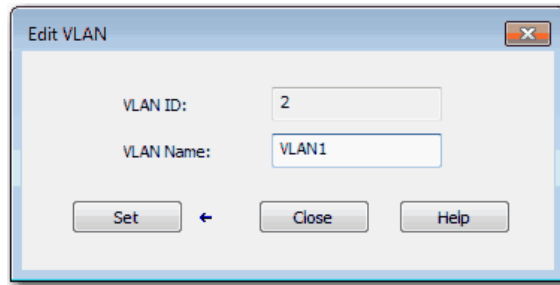

- To delete a VLAN, click the corresponding Trash icon in the Delete column and click Set.

## Monitor the Switch

<b>Topic</b>	<b>Page</b>
Dashboard	104
System Alarms	109
Port Statistics	110
Port Security Statistics	111
CIP Status	113
DHCP Clients Status	115
System Log Messages	115
Ping Utility	117
Switch Status	118
Module Information	120
Port Status	121
Port Diagnostics	122

This chapter describes tools to monitor the switch in Device Manager and the Studio 5000 Logix Designer® application.

## Dashboard

The dashboard in Device Manager lets you monitor the following:

- Front panel status indicators
- Switch information
- Switch health
- Port utilization

Figure 2 - Dashboard

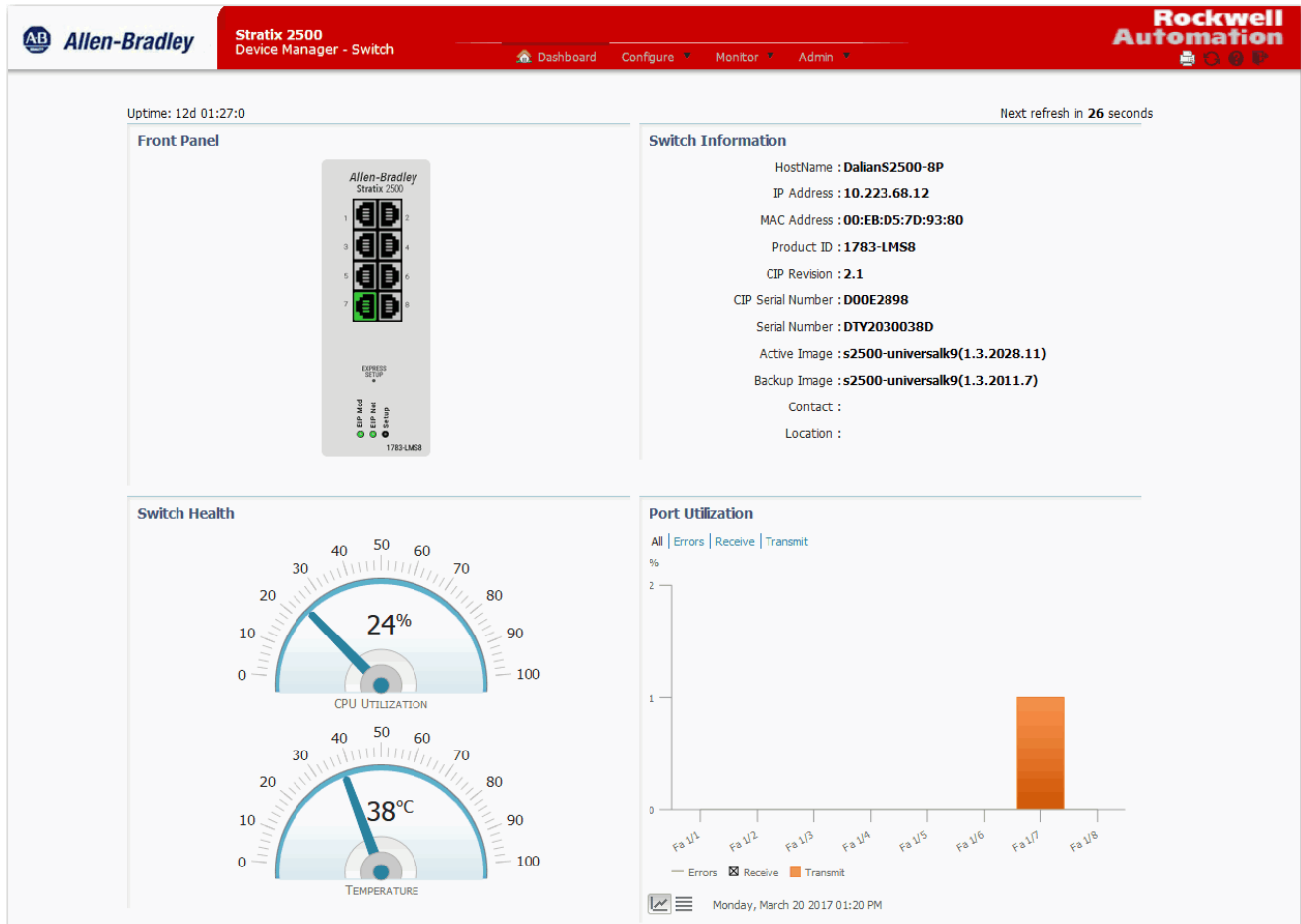

## Front Panel

The Front Panel area on the dashboard is a graphical display of the front panel on the physical switch. The switch components on the front panel view are color-coded by status.

To display specific information about a port and its status, hover your mouse pointer over a port image, as shown in the following graphic.

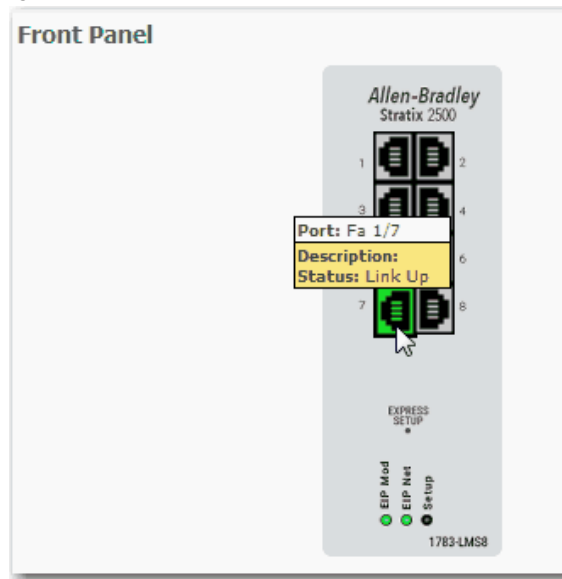
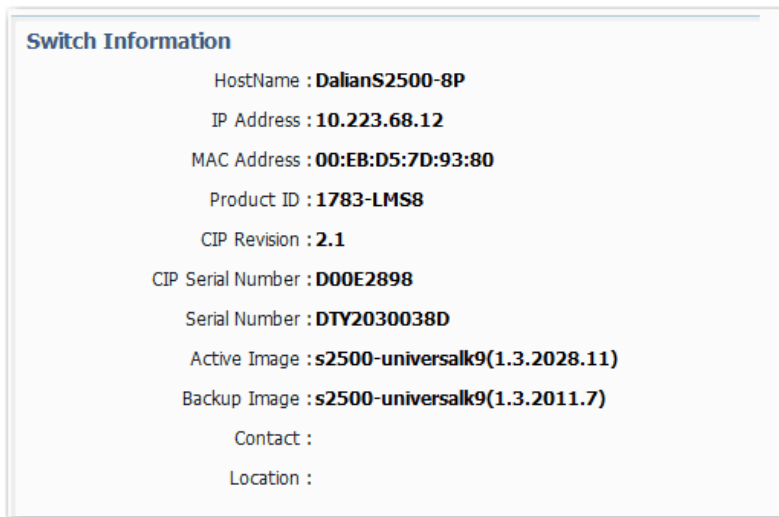

**Figure 3 - Port Hover Text**

For descriptions of the IEP Mod, EIP Net, and Setup status indicators, see [System Status Indicators on page 134](#).

## Switch Information

The Switch Information area on the dashboard displays information about the switch.

**Table 52 - Switch Information Fields**

Field	Description
HostName	A descriptive name for this switch. The default name is Switch. You can set this parameter on the Express Setup page.
IP Address	The IP address of this switch. You can configure this setting on the Express Setup page.
MAC Address	The MAC address of this switch. This information cannot be changed.
Product ID	The model of this switch. This information cannot be changed.

**Table 52 - Switch Information Fields (continued)**

Field	Description
CIP Revision	The CIP revision that is supported by the firmware revision that switch is running. The supported CIP revision changes with firmware updates.
CIP Serial Number	The CIP serial number. This information cannot be changed.
Serial Number	The serial number of this switch. This information cannot be changed.
Active Image	The firmware revision that the switch is running. This information is updated when you upgrade the switch firmware.
Backup Image	The firmware revision that is stored as a backup. You can change to the backup revision on the Software Update page.
Contact	The person who is the administrative contact for this switch. You can set this parameter on the SNMP page.
Location	The physical location of this switch. You can set this parameter on the SNMP page.

### Switch Health

The Switch Health area on the dashboard displays gauges to monitor CPU utilization and temperature.

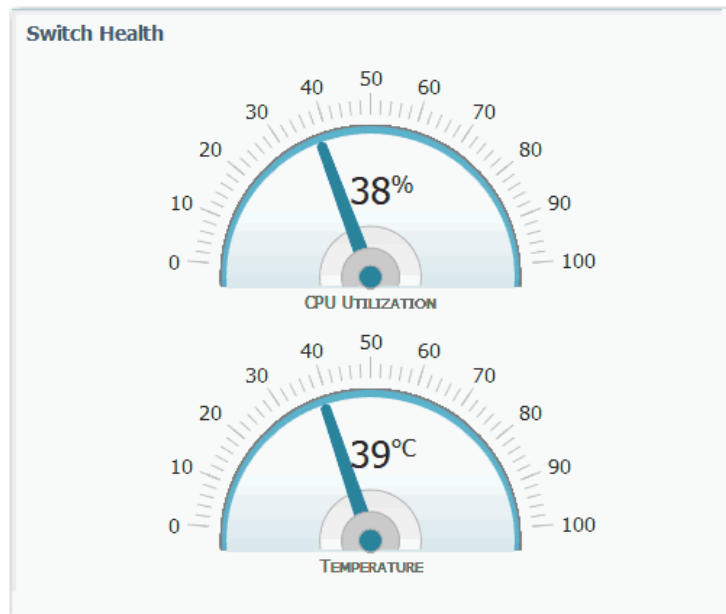

The CPU Utilization gauge shows the percentage of CPU processing power that is in use on the switch. Data is collected at each 60-second system refresh. The gauge changes as the switch experiences the network activity from devices sending data through the network. As network activity increases, so does contention between devices to send data through the network.

As you monitor utilization on the switch, note whether the percentage of usage is what you expect during that given time of network activity. If utilization is high when you expect it to be low, perhaps a problem exists. As you monitor the switch, note if the bandwidth utilization is consistently high, which can indicate congestion in the network. If the switch reaches its maximum bandwidth (above 90% utilization) and its buffers become full, it begins to discard the data packets that it receives. Some packet loss in the network is not considered unusual, and the switch is configured to help recover lost packets,



such as by signaling to other devices to resend data. However, excessive packet loss can create packet errors, which can degrade overall network performance.

To reduce congestion, consider segmenting the network into subnetworks that are connected by other switches or routers. Look for other causes, such as faulty devices or connections, which can also increase bandwidth utilization on the switch.

The Temperature gauge shows the internal temperature of the switch. For information about the switch temperature range and the operating environment guidelines, see the Stratix Ethernet Device Specifications Technical Data, publication [1783-TD001](#).

## Port Utilization

The Port Utilization area on the dashboard displays network traffic:

- By default, all traffic is displayed for all interfaces. Click the links above the graph to display all traffic, errors, received traffic, or transmitted traffic.
- You can view the data in chart or grid format. Click the buttons below the graph to choose a format:
  - Chart format 
  - Grid format 
- When displaying a chart, position your mouse pointer over a bar or a point on the chart to view the data.

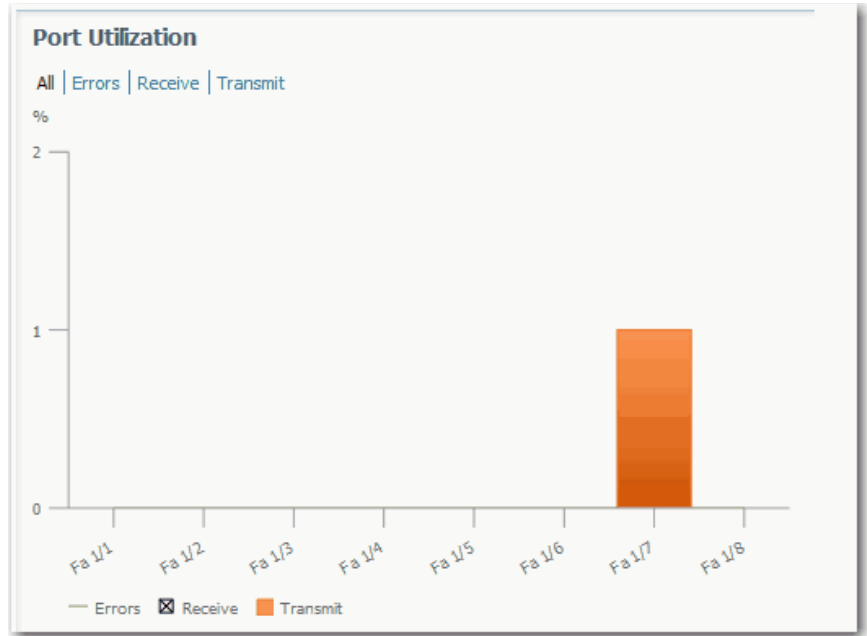

As you monitor the usage on the ports, note whether the percentage is what you expect during that given time of network activity. If usage is high when you expect it to be low, a problem can exist. Bandwidth allocation can also be based on whether the connection is operating in Half-duplex or Full-duplex mode.

Reasons for errors that are received on or sent from the switch ports include the following:

- Bad cable connection
- Defective ports
- Software problems
- Driver problems

Data is collected at each 60-second system refresh.

For more details about data and errors on ports, see [Port Statistics on page 110](#).

## System Alarms

In Device Manager, you can view system alarm counts in the lower-right corner of the window. To display the table of alarm events as follows, hover your mouse pointer over the Alarms area.

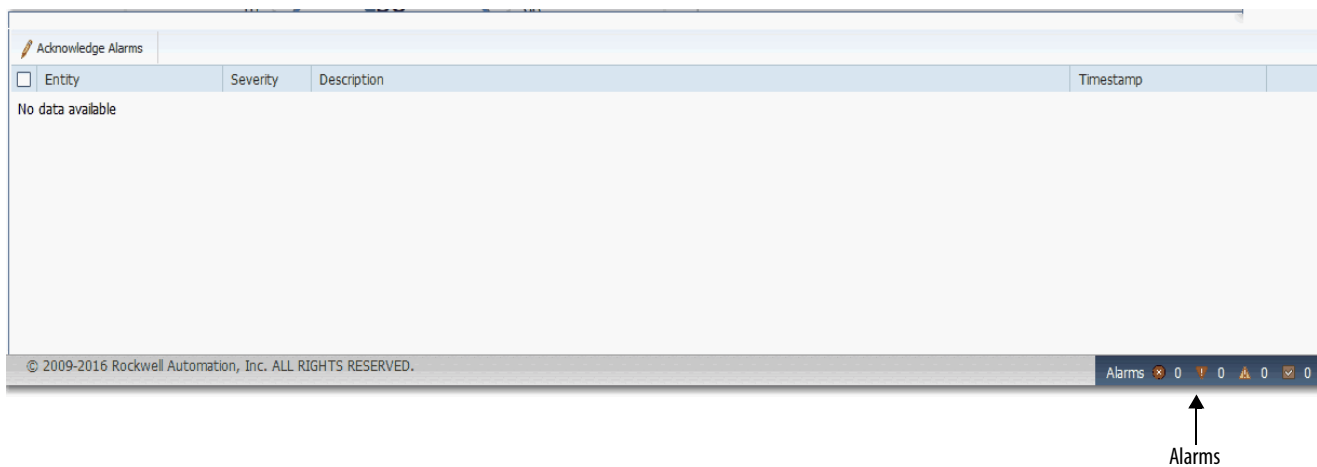

Device Manager refreshes data every 60 seconds. To refresh alarms data manually, click the Refresh icon in the upper-right corner of the Device Manager window.

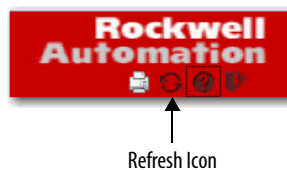

Only active alarms appear. Alarms are removed from the table in the next auto-refresh cycle when the following occurs:

- You acknowledge the alarm.
- You disable the alarm on the Alarm Settings page.
- The alarm becomes inactive.
- You clear logs on the Syslog page.

---

**IMPORTANT** System alarms are filtered from the Syslog page, so Enable Syslog must be checked on the Alarm Settings page under the Configuration menu.

---

To suppress an active alarm, select the alarm in the Alarms table and click Acknowledge Alarms. To acknowledge an alarm turns off the associated status indicator that is lit when the alarm is raised and removes the alarm from the Alarms table.

## Port Statistics

On the Port Statistics page, you can view statistics for data that passes through the switch ports.

In Device Manager, from the Monitor menu, under Statistics, choose Port Statistics.

Statistics | Port Statistics

Data unit: Byte | MB

Port	Transmitted	Total Transmitted(packets)	Received	Total Received(packets)	Total Transmit Errors(packets)	Total Receive Errors(packets)
<input type="checkbox"/> Fa 1/1	0	0	0	0	0	0
<input type="checkbox"/> Fa 1/2	0	0	0	0	0	0
<input type="checkbox"/> Fa 1/3	0	0	0	0	0	0
<input type="checkbox"/> Fa 1/4	0	0	0	0	0	0
<input type="checkbox"/> Fa 1/5	0	0	0	0	0	0
<input type="checkbox"/> Fa 1/6	0	0	0	0	0	0
<input type="checkbox"/> Fa 1/7	68925975	139323	1179226032	4888183	0	0
<input type="checkbox"/> Fa 1/8	0	0	0	0	0	0

Clear Counters

The types of port statistics are grouped under the tabs that are described in [Table 53](#). For more information, see the online help in Device Manager.

**Table 53 - Port Statistics Tabs**

Tab	Description
Overview	Use this tab to view the number of error packets that is received and sent from the port. This level of detail is not available from the Port Utilization area of the Dashboard page. The number of error packets can mean a duplex mismatch, incompatibilities with the port and its attached device, or faulty cables or attached devices. Any of these problems can cause slow network performance, data loss, or lack of connectivity.
Transmit Detail	Use this tab to troubleshoot unusual changes in network traffic. This tab displays these statistics: <ul style="list-style-type: none"> <li>• Unicast, multicast, and broadcast packets that are sent from each port</li> <li>• Detailed statistics of errors that are sent to each port</li> </ul> If a port is sending an unusually high amount of traffic, such as multicast or broadcast packets, monitor the connected device to see whether the traffic pattern is normal.
Receive Detail	Use this tab to troubleshoot unusual changes in network traffic. This tab displays these statistics: <ul style="list-style-type: none"> <li>• Unicast, multicast, and broadcast packets that are received on each port</li> <li>• Detailed statistics of errors that are received on each port</li> </ul> If a port is receiving an unusually high amount of traffic, such as multicast or broadcast packets, monitor the connected device to see whether the traffic pattern is normal.

## Port Security Statistics

The Port Security page lets you monitor the information that is related to port security settings. In Device Manager, you configure port security settings on the Port Security page under the Configuration menu.

To view port security status, from the Monitor menu, choose Port Security.

← Statistics | **Port Security**

Port Security
Sticky MAC

Port Security Status Total 5

Interface	MAC Limit	MAC Count	Violation Mode	Sticky MAC Enabled	State
Fa 1/1	1	0	protect	No	Ready
Fa 1/2	1	0	protect	No	Ready
Fa 1/3	1	0	protect	No	Ready
Fa 1/4	1	0	protect	No	Ready
Fa 1/5	1	0	protect	No	Ready

Violating MAC Table (Applicable for Violation Mode - Restrict)

Select a port ▼

Interface	Violating MAC Address	Violating VLAN	Age
Total 0			

**Table 54 - Port Security Tab Fields**

Field	Description
Interface	The port type (Fa for Fast Ethernet) and number.
MAC Limit	The value that is defined in the Maximum MAC Count Allowed field on the Port Security page under the Configuration menu.
MAC Count	Number of learned MAC addresses.
Violation Mode	The action to take if the value in the maximum number of learned MAC addresses is reached. See descriptions in <a href="#">Table 34</a> .
Sticky MAC Enabled	Indicates if Sticky MAC is enabled for each Interface (Yes/No).
State	Displays if the number of learned MAC addresses exceeds the configured maximum: <ul style="list-style-type: none"> <li>• Ready—Maximum not reached.</li> <li>• Limited Reached—Number of learned MAC addresses exceeds the configured maximum.</li> </ul>

Below the Port Security Status tabs, you can view information about the violating MAC addresses in the Violating MAC Table. This table displays data only for interfaces that meet these conditions, as configured on the Port Security page under the Configuration menu:

- The Violation mode is set to ‘restrict.’
- The value that is defined in the Maximum MAC Count Allowed field has been exceeded.

**Table 55 - Violating MAC Table Fields**

Field	Description
Interface	The port type (Fa for Fast Ethernet) and number.
Violating MAC Address	The MAC address that exceeds the limit.
Violating VLAN	The VLAN associated with the violating MAC address for the interface.
Age	The time that remains to flush the MAC address, or the hold time, which is measured in seconds. A value of zero means that aging is disabled.

Use the Sticky MAC tab to monitor the information that is related to Sticky MAC settings. To display the sticky MAC addresses for a port, select the port from the Select a port pull-down menu.

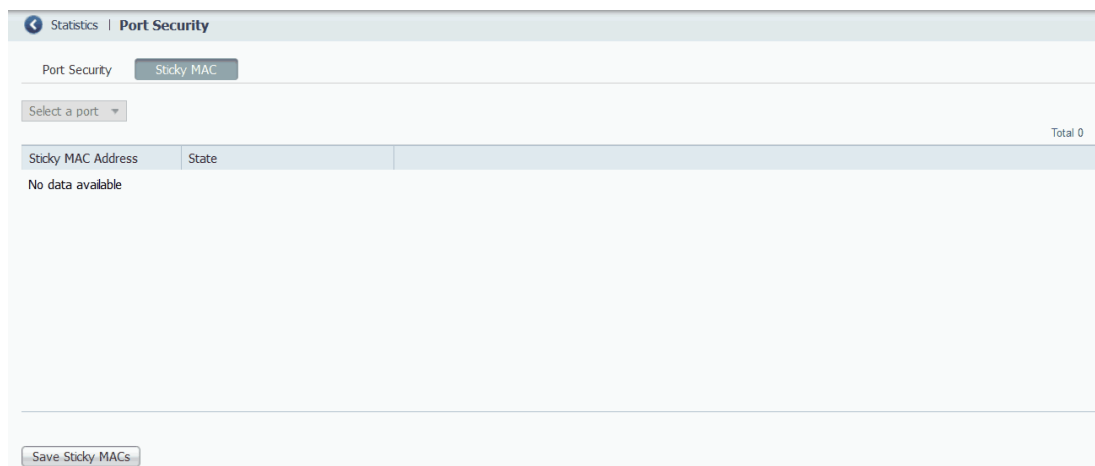



**Table 56 - Sticky MAC Tab Fields**

Field	Description
Sticky MAC Address	The sticky MAC addresses for the selected port.
State	Displays if the number of learned MAC addresses exceeds the configured maximum: <ul style="list-style-type: none"> <li>Forwarding—The port is active and forwarding traffic.</li> <li>Violating—Number of MAC addresses exceeds the maximum.</li> </ul>
Save Sticky MACs	To save the sticky MAC addresses into the startup configuration file. Sticky MAC addresses are not automatically added to the startup configuration. If you do not save an updated configuration, the addresses are lost and the interface must relearn the addresses upon device reboot. Save the addresses into the startup configuration to essentially make these addresses static. The port type (Fa for Fast Ethernet) and number.

## CIP Status

In Device Manager, you can monitor Common Industrial Protocol (CIP) status and statistics. CIP is an application layer messaging protocol that industrial automation and control devices use to communicate as part of a control system. CIP is the application layer for the EtherNet/IP network. Stratix® switches contain an EtherNet/IP server that enables the switch to be part of the industrial automation and control system for management and monitoring.

The CIP page displays information since the switch was last powered on, was restarted, or the counters were last reset. To reset the counters to zero, click Reset Counters. To troubleshoot an issue, reset the CIP counters, and see if the counters show that the issue still exists.

---

**IMPORTANT** Except for Active Multicast Groups, all other categories are related to the CIP server in the switch. The categories pertain to CIP traffic directed to the switch as a CIP target device. The categories do not refer to CIP (EtherNet/IP) traffic that flows through the switch among these devices:

- Various CIP controllers
  - HMI devices
  - Configuration tools
  - Other CIP target devices, such as drives, I/O modules, motor starters, sensors, and valves
- 

From the Monitor menu, under Status, choose CIP.

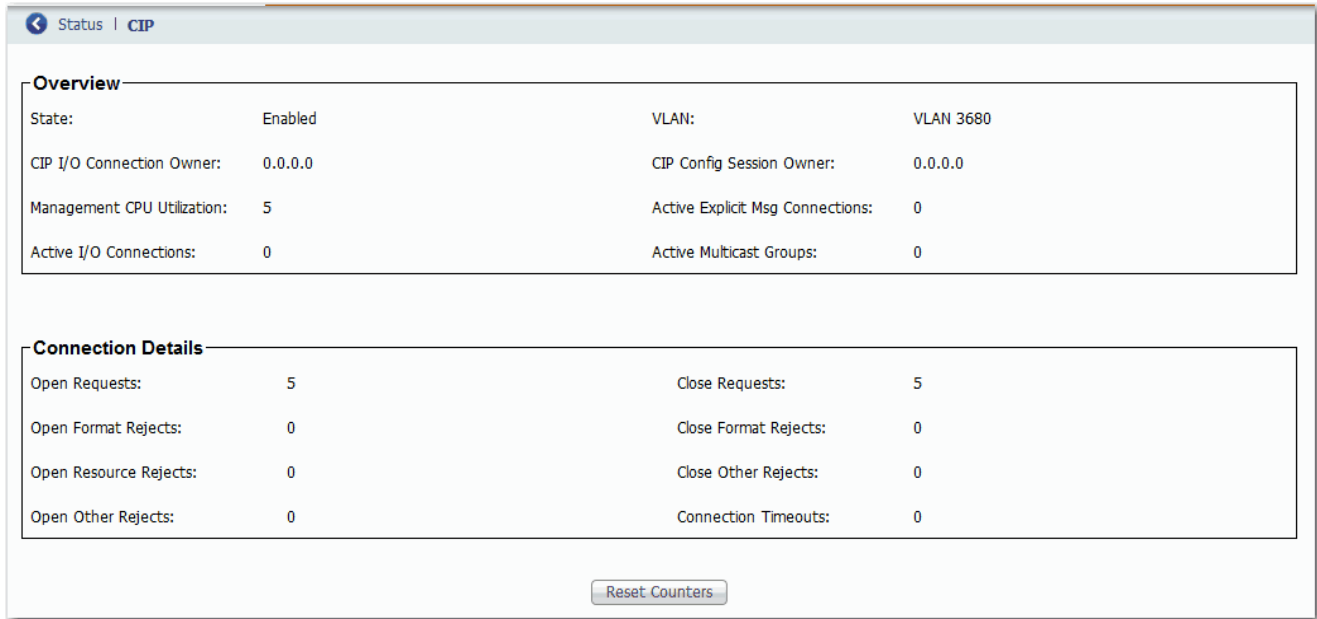

Table 57 - CIP Fields

Field	Description
<b>Overview—Displays the state of the DIP connection to the device.</b>	
State	The state of the CIP connection (Enabled or Disabled).
VLAN	The VLAN ID.
CIP I/O Connection Owner	The IP address of the device to and from which application-specific I/O output data is sent and received.
CIP Config Session Owner	The IP address of the device controlling the CIP configuration session.
Management CPU Utilization	Percentage of the management CPU that is used for management functions. Switch functions have dedicated ASICs. Management functions do not impact the ASICs.
Active Explicit Msg Connections	The number of active, explicit messaging connections to the switch as a target.
Active I/O Connections	The number of active I/O connections with the switch as a target.
Active Multicast Groups	The number of multicast groups, including CIP multicast groups, that flow through the switch.
<b>Connection Details—Displays request activity.</b>	
Open Requests	The number of Forward Open requests received by the switch to establish a connection with the switch.
Close Requests	The number of Forward Close requests received by the switch after a connection was successfully established with the switch.
Open Format Rejects	The number of Forward Open requests directed to the switch that failed because the request is not in the proper format.
Close Format Rejects	The number of Forward Close requests directed to the switch that failed because the request is not in the proper format.
Open Resource Rejects	The number of Forward Open requests that failed to establish a new connection for reasons such as insufficient memory.
Close Other Rejects	The number of Forward Close requests that failed for reasons such as incompatible electronic keying.
Open Other Rejects	The number of Forward Open requests that failed for reasons such as incompatible electronic keying.
Connection Timeouts	The number of CIP connections that timed out due to inactivity.

## DHCP Clients Status

In Device Manager, the DHCP Clients Table displays information about devices that are connected to a switch with DHCP snooping enabled. The DHCP snooping feature dynamically builds and maintains entries in the DHCP Clients Table. An entry is recorded for each untrusted host with a leased IP address, if the host is associated with a VLAN that has DHCP snooping enabled. Entries are not recorded for hosts that are connected through trusted interfaces. See [DHCP Snooping on page 58](#) for information about setting this feature.

← Status | DHCP Clients

DHCP Clients Table Total 5

MAC Address	IP Address	Lease(sec)	VLAN ID	Interface
00:1D:9C:C9:AD:34	192.168.1.25	4294967295	531	Fa 1/1
00:1D:9C:CE:24:68	192.168.1.26	4294967295	531	Fa 1/2
E4:90:69:A4:09:B5	192.168.1.28	4294967295	531	Fa 1/4
E4:90:69:A4:0A:0F	192.168.1.29	4294967295	531	Fa 1/5
E4:90:69:A4:0A:95	192.168.1.27	4294967295	531	Fa 1/3

Clear DHCP Clients

**Table 58 - DHCP Clients Table Fields**

Field	Description
MAC Address	Displays the client hardware MAC address.
IP Address	Displays the client IP address assigned from the DHCP server.
Lease(sec)	Displays IP address lease time in seconds.
VLAN ID	Displays the VLAN number of the client interface.
Interface	Displays the interface that connects to the DHCP client host.
Clear DHCP Clients	Click to reset leases for unconnected devices.

## System Log Messages

In Device Manager, the system log displays events that occur on the switch and its ports. On the Syslog page, you can configure the system log server and view system log entries by severity and type.

To clear the entries on the Syslog page, click Clear Log. Clicking Clear Log does not resolve the issues.

**Syslog Server Configuration**

Enable Server :

IP Address:

Message Level:

Severity Filter  Type Filter

Total 14

Time Stamp	Severity	Description
2017-03-08 15:58:52	notice	LINK-UPDOWN: Interface FastEthernet 1/1, changed state to down.
2017-03-08 15:58:50	notice	LINK-UPDOWN: Interface FastEthernet 1/7, changed state to up.
2017-03-08 15:58:31	notice	LINK-UPDOWN: Interface Vlan 3680, changed state to up.
2017-03-08 15:58:28	notice	LINK-UPDOWN: Interface Vlan 1, changed state to up.
2017-03-08 15:58:28	notice	LINK-UPDOWN: Interface Vlan 3680, changed state to down.
2017-03-08 15:58:28	notice	LINK-UPDOWN: Interface Vlan 1, changed state to down.
2017-03-08 15:58:26	notice	LINK-UPDOWN: Interface Vlan 3680, changed state to down.

## Configure the System Log Server

To configure the system log server, follow these steps.

1. From the Monitor menu, under Troubleshoot, choose Syslog.
2. Check Enable Server.
3. In the IP Address field, type the IP address of the server where the switch sends the logs.
4. From the Message Level pull-down menu, choose the level of messages to send to the system log server.

The switch sends messages to the server at the level you choose and numerically lower levels:

- informational—Sends messages with severity code of 6 or less. This level indicates that the message is for information only.
- notifications—Sends messages with severity code of 5 or less. This level indicates that the switch is operating normally but has a significant condition.
- warnings—Sends messages with severity code of 4 or less. This level indicates that the switch has a warning condition.
- errors—Sends messages with severity code of 3 or less. This level indicates that the switch has an error condition.

5. Click Submit.

## View System Log Entries

To view system log entries, follow these steps.

1. From the Monitor menu, under Troubleshoot, choose Syslog.
2. From the Severity Filter pull-down menu, choose the severity of the entries to view:
  - all—Displays all severities.
  - informational—Displays informational messages.
  - notifications—Displays significant conditions while the switch is operating normally.
  - warnings—Displays warning conditions.
  - errors—Displays error conditions.
3. From the Type Filter pull-down menu, choose the type of message of view:
  - NONE—Displays all types.
  - SYS-BOOTING—Displays system boot events.
  - SUDI verification passed—Displays Secure Unique Device Identifier (SUDI) events.
  - LINK-UPDOWN—Displays interface state change events.

## Ping Utility

In Device Manager, use the Ping Utility to troubleshoot connectivity from the switch to another device.

Enter the IP address or host name and click Ping to initiate a request for information. The response is displayed in the Ping Statistics field.

The screenshot shows the 'Ping Utility' interface within a 'Troubleshoot' menu. It features three input fields: 'IP Address/ DNS Name' (empty), 'Repeat' (set to 5, with a range of 1-10), and 'Packet Size' (set to 100 bytes, with a range of 2-1452). A 'Ping' button is located below these fields. Underneath is a 'Ping Statistics' section with a large, empty rectangular area for displaying results, and a 'Clear' button at the bottom.

Table 59 - Ping Utility Fields

Field	Description
IP Address/DNS Name	Enter the IP address or host name of the ping target.
Repeat	Enter the number of times to reissue the ping request. Range: 1...10 Default: 5
Packet Size	Enter the length (in bytes) of the ping packet. Range: 2...1452 Default: 100
Clear	Click to remove all current information from the Ping Statistics field.

## Switch Status

The Switch Status view in the Studio 5000 Logix Designer application lets you view status parameters for the switch.

In the navigation pane, click Switch Status.

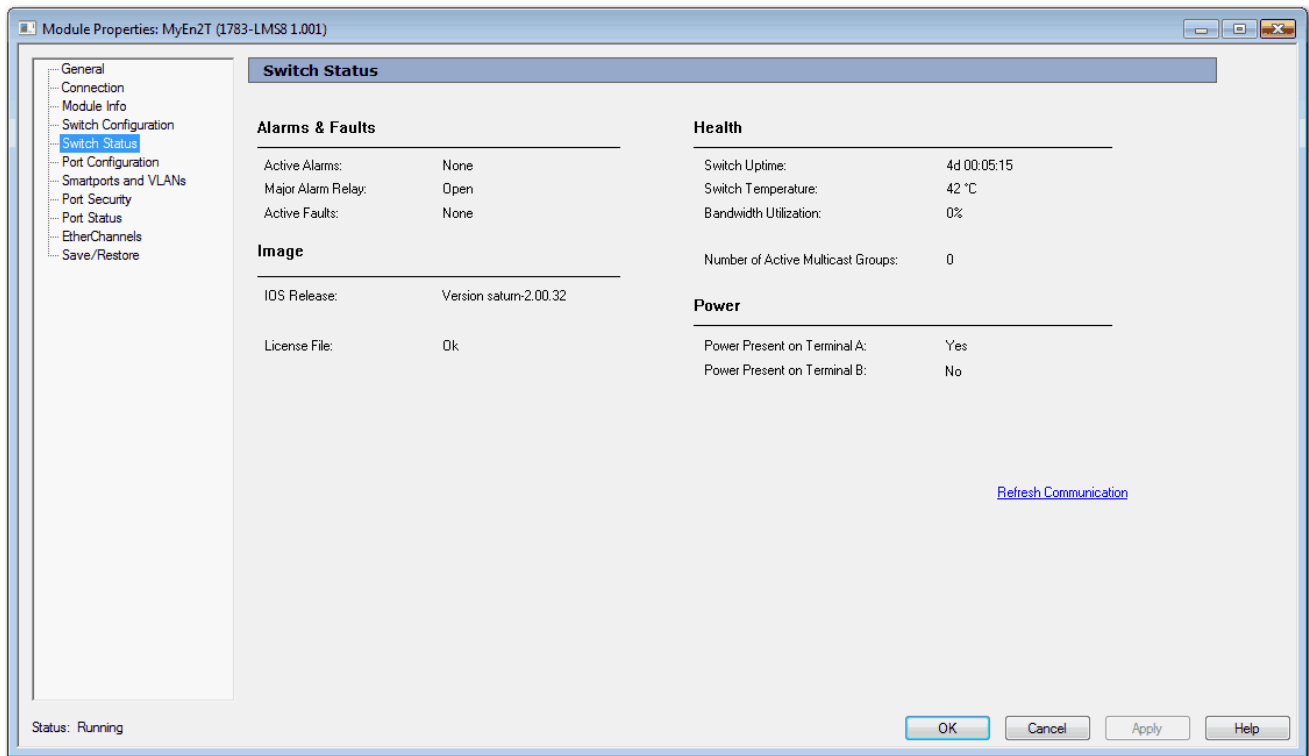

**Table 60 - Switch Status Fields**

<b>Field</b>	<b>Description</b>
<b>Alarms &amp; Faults</b>	
Active Alarms	Displays one of these values: <ul style="list-style-type: none"> <li>• None</li> <li>• Port alarm</li> <li>• Dual Mode Power Supply alarm</li> <li>• Primary Temperature alarm</li> </ul>
Major Alarm Relay	Displays one of these values: <ul style="list-style-type: none"> <li>• Open</li> <li>• Closed</li> </ul>
Active Faults	Displays one of these values: <ul style="list-style-type: none"> <li>• None</li> <li>• Port fault</li> <li>• Hardware fault</li> </ul> <p>If the port and hardware faults are active, the Hardware fault status appears.</p>
<b>Health</b>	
Switch Uptime	Displays the days, hours, and minutes that the switch has been functioning since the last restart.
Switch Temperature	Displays the current internal temperature (in degree Celsius) of the switch.
Bandwidth Utilization	Displays the total percentage of the switch bandwidth being used.
Number of Active Multicast Groups	Displays the number of active multicast groups.
<b>Image</b>	
IOS Release	Displays the current version of the switch operating system.
License File	Displays whether the license file is valid.
<b>Power</b>	
Power Present on Terminal A	Displays a yes or no value to indicate whether power is present on the power terminal.

## Module Information

You can use the Studio 5000 Logix Designer application to view general information about the switch on the Module Info view.

In the navigation pane, click Module Info.

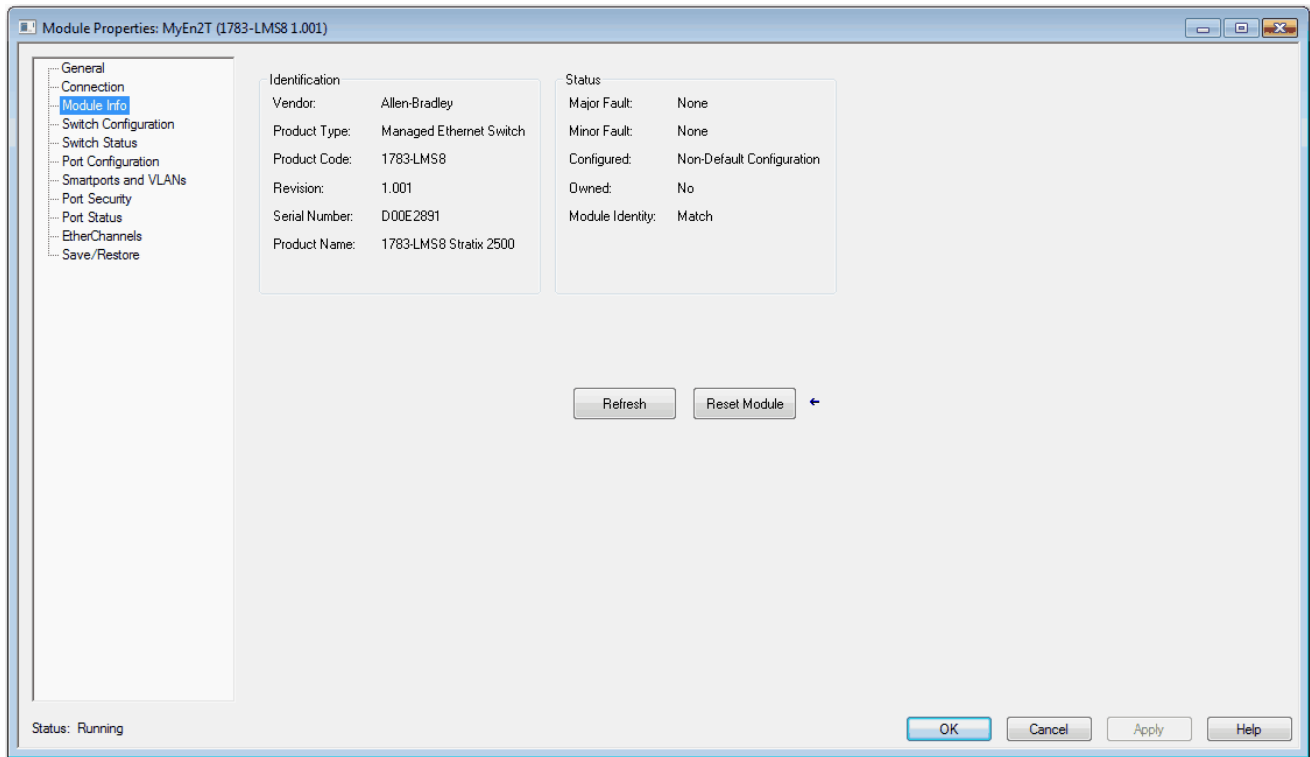

**Table 61 - Module Info Fields**

Field	Description
Identification	<p>Displays the following switch information:</p> <ul style="list-style-type: none"> <li>• Vendor</li> <li>• Product type</li> <li>• Product code</li> <li>• Revision</li> <li>• Serial number</li> <li>• Product name</li> </ul>
Status	<p>Displays the following status information:</p> <ul style="list-style-type: none"> <li>• Major/minor fault status                             <ul style="list-style-type: none"> <li>– None</li> <li>– Recoverable</li> <li>– Nonrecoverable</li> </ul> </li> <li>• Configuration                             <ul style="list-style-type: none"> <li>– Non-default configuration</li> <li>– Default configuration</li> </ul> </li> <li>• Owned                             <ul style="list-style-type: none"> <li>– Yes. There is an I/O connection.</li> <li>– No. There is not an I/O connection.</li> </ul> </li> <li>• Module Identity                             <ul style="list-style-type: none"> <li>– Match. Agrees with what is specified on the General view. In order for the Match condition to exist, the vendor, product type, product code, and major revision must agree.</li> <li>– Mismatch. Does not agree with what is specified on the General view.</li> </ul> </li> </ul> <p>The Module Identity field does not consider the Electronic Keying or Minor Revision selections for the switch that were specified on the General view.</p>



## Port Status

You can monitor alarms, statuses, thresholds, and bandwidth utilization for each switch port using the Studio 5000 Logix Designer application.

In the navigation pane, click Port Status.

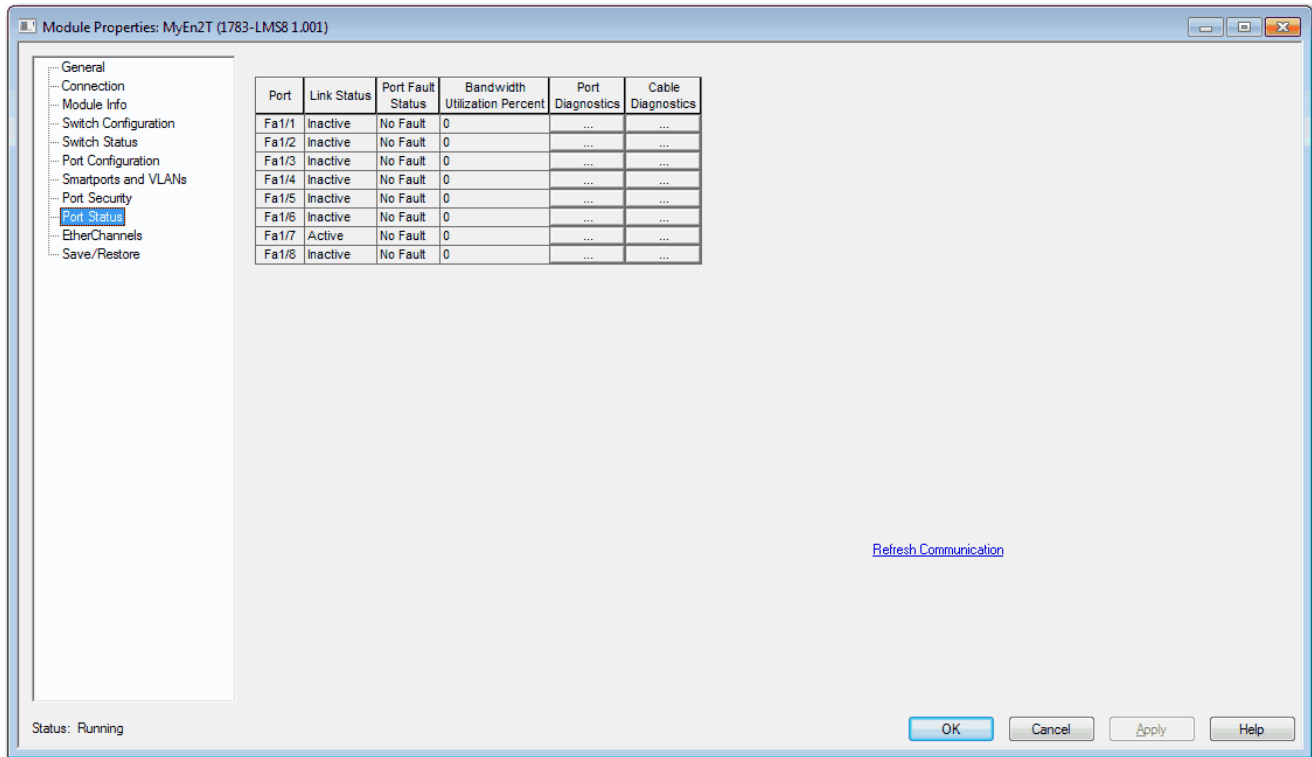

**Table 62 - Port Status Fields**

Field	Description
Port	Displays the port type (Fa for Fast Ethernet) and number.
Link Status	Displays whether the link is active or inactive.
Port Fault Status	Displays the status of the port alarm. Valid values: <ul style="list-style-type: none"> <li>• Error - Disable event</li> <li>• CDP native VLAN mismatch</li> <li>• MAC address flap</li> <li>• Port security violation</li> <li>• No fault</li> </ul>
Bandwidth Utilization Percent	Displays the percentage of the bandwidth being used. Note whether the percentage of usage is what you expect during the given time of network activity. If usage is higher than expected, an issue can exist.
Port Diagnostics	Click to display information to diagnose a network performance issue for the corresponding port. See <a href="#">page 122</a> .
Cable Diagnostics	Not available in the current release.

## Port Diagnostics

The Port Diagnostics feature in the Studio 5000 Logix Designer application lets you view the status of the link performance:

- View octet and packet counters
- View collisions on the link
- View errors on the link

You can also reset and clear all status counters.

In the navigation pane, click Port Status, and then click the button in the Port Diagnostics column for the corresponding port.

Port	Link Status	Port Fault Status	Bandwidth Utilization Percent	Port Diagnostics	Cable Diagnostics
Fa1/1	Inactive	No Fault	0	...	...
Fa1/2	Inactive	No Fault	0	...	...
Fa1/3	Inactive	No Fault	0	...	...
Fa1/4	Inactive	No Fault	0	...	...
Fa1/5	Inactive	No Fault	0	...	...
Fa1/6	Inactive	No Fault	0	...	...
Fa1/7	Active	No Fault	0	...	...
Fa1/8	Inactive	No Fault	0	...	...

**Port Diagnostics**

Unit: 8 Port Base  
Port: Fa1/1

<b>Interface Counters</b>		<b>Media Counters</b>	
Octets In:	0	Alignment Errors:	0
Octets Out:	0	FCS Errors:	0
Ucast Packets In:	0	Single Collisions:	0
Ucast Packets Out:	0	Multiple Collisions:	0
NUcast Packets In:	0	SQE Test Errors:	0
NUcast Packets Out:	0	Deferred Transmissions:	0
Discards In:	0	Late Collisions:	0
Discards Out:	0	Excessive Collisions:	0
Errors In:	0	MAC Xmit Errors:	0
Errors Out:	0	MAC Recv Errors:	0
Unknown Protos In:	0	Carrier Sense:	0
		Frame Too Long:	0

Refresh    Reset Counters    Close    Help

**Table 63 - Port Diagnostics Fields**

Field	Description
Unit	Displays the switch model: <ul style="list-style-type: none"> <li>• 5 Port Base</li> <li>• 8 Port Base</li> </ul>
Port	Displays the port type (Fa for Fast Ethernet) and number.
Interface Counters	Displays the following interface counters: <ul style="list-style-type: none"> <li>• Octets In—The number of octets that the port receives.</li> <li>• Octets Out—The number of octets that the port sends.</li> <li>• Ucast Packets In—The number of unicast packets that the port receives.</li> <li>• Ucast Packets Out—The number of unicast packets that the port sends.</li> <li>• NUCast packets In—The number of multicast packets that the port receives.</li> <li>• NUCast packets Out—The number of multicast packets that the port sends.</li> <li>• Discards In—The number of inbound packets that have been discarded.</li> <li>• Discards Out—The number of outbound packets that have been discarded.</li> <li>• Errors In—The number of inbound packets that contain errors.</li> <li>• Errors Out—The number of outbound packets that contain errors.</li> <li>• Unknown Protos (Protocols) In —The number of inbound packets with unknown protocols.</li> </ul>
Media Counters	Displays the following media counters: <ul style="list-style-type: none"> <li>• Alignment—The number of frames received that are not an integral number of octets in length.</li> <li>• FCS (Frame Check Sequence)—The number of frames received that do not pass the FCS check.</li> <li>• SQE Test Errors —The number of times that the SQE TEST ERROR message is generated.</li> <li>• Deferred Transmissions—The count of transmissions that are deferred by busy network.</li> <li>• Late Collisions—The number of late collisions.</li> <li>• Excessive Collisions—The number of frames for which transmission fails due to excessive collisions.</li> <li>• MAC Xmit Errors—The number of frames that failed to transmit due to an internal MAC sublayer transmit error.</li> <li>• MAC Recv Errors—The number of frames that failed to be received due to an internal MAC sublayer receive error.</li> <li>• Carrier Sense—The number of times the carrier sense condition was lost or never asserted when attempting to transmit a frame.</li> <li>• Frame Too Long —The number of frames received that exceed the maximum permitted frame size.</li> </ul>

**Notes:**

## Troubleshoot the Switch

<b>Topic</b>	<b>Page</b>
Troubleshoot the Installation	126
Troubleshoot IP Addresses	128
Troubleshoot Device Manager	129
Restart or Reset the Switch	129
Troubleshoot a Firmware Update	131
Troubleshoot with the Command-line Interface	132

This chapter helps you resolve issues that are related to Stratix® 2500 switches and perform common functions, such as reset the switch.

See also Troubleshoot EtherNet/IP Networks, publication [ENET-AT003](#).

## Troubleshoot the Installation

If you encounter problems with the installation of the switch, refer to these topics for possible resolutions:

- [Status Indicators on page 126](#)
- [Power-on Self-test on page 126](#)
- [Bad or Damaged Cable on page 127](#)
- [Ethernet Cables on page 127](#)
- [Link Status on page 128](#)
- [Port Settings on page 128](#)

## Status Indicators

The status indicators on the front panel provide troubleshooting information about the switch. They show system faults, port connectivity problems, and overall switch performance. For a description of status indicators, see [Status Indicators on page 133](#).

## Power-on Self-test

The power-on self-test (POST) is a diagnostic testing sequence that verifies whether the switch is functioning properly. For example, you can use POST to verify that individual switch ports are working correctly.

To run POST, follow these steps.

1. In Device Manager, from the Admin menu, choose Restart/Reset.
2. Check Enable Post.
3. Click Submit.

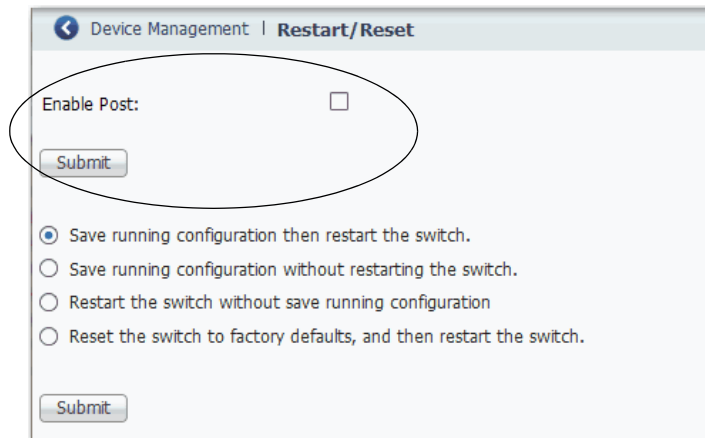

5. Restart the switch.

As the switch powers on, POST begins to run. This process can take several minutes to complete.

6. Check the status of the EIPMod status indicator on the front panel of the switch.

If the EIPMod status indicator remains solid red, the switch has a non-recoverable fault.

---

**IMPORTANT** POST failures are fatal to the switch. Contact your Rockwell Automation technical support representative if your switch does not pass POST.

---

## Bad or Damaged Cable

Always make sure that the cable does not have marginal damage or failure. Even if a cable can connect at the physical layer, subtle damage to the wiring or connectors can corrupt packets.

This situation is likely when the port has many packet errors or the port constantly loses and regains the link. To troubleshoot, try the following:

- Swap the copper cable with a known, undamaged cable.
- Look for broken, bent, or missing pins on cable connectors.
- Rule out any bad patch panel connections or media converters between the source and destination. If possible, bypass the patch panel, or eliminate faulty media converters (fiber-optic-to-copper).
- Try the cable in another port or interface to determine if the problem follows the cable.

## Ethernet Cables

Make sure that you have the correct cable type for the connection:

- Use Category 3 copper cable for 10-Mb/s UTP connections.
- Use Category 5, 5e, or 6 UTP or STP cable for 10/100-Mbps connections.

## Link Status

Verify that both sides of a network link are connected. A broken wire or disabled port can cause one side to show a connection, but not the other side. A port status indicator does not necessarily indicate that the cable is fully functional. The cable can encounter physical stress that causes it to function at a marginal level. If the port status indicator for the port is not lit, do the following:

- Connect the cable from the switch to a known good device.
- Make sure that both ends of the cable are connected to the correct ports.
- Verify that both devices have power.
- Verify that you are using the correct cable type.
- Rule out loose connections. Sometimes a cable appears to be seated, but is not. Disconnect the cable, and then reconnect it.

## Port Settings

A cause of connectivity failure can be a disabled port. Use the Port Settings page in Device Manager to verify the status of the connection. If needed, enable the interface to restore the connection.

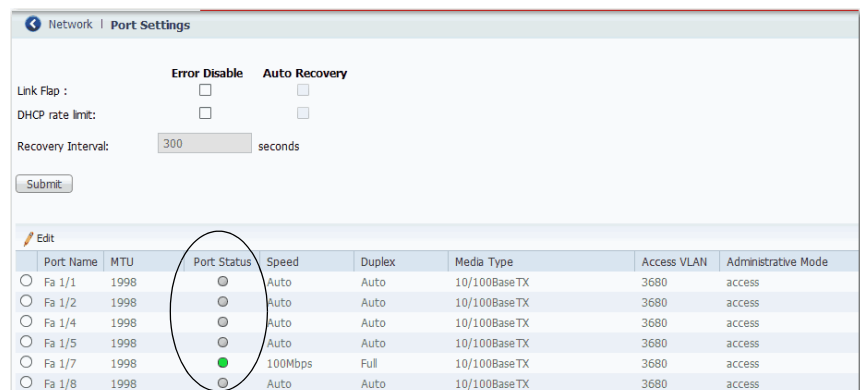

## Troubleshoot IP Addresses

The following table includes basic troubleshooting for issues that are related to the switch IP address.

Issue	Resolution
The switch does not receive an IP address from the DHCP server	If the switch does not receive an IP address from an upstream device operating as a DHCP server, make sure that the device is operating as a DHCP server. Repeat Express Setup.
The switch has the wrong IP address	If the switch is installed in your network, but you cannot access the switch because it has the wrong IP address, assign a new switch IP address and update the switch IP address on the Express Setup page.



## Troubleshoot Device Manager

The following table includes basic troubleshooting for Device Manager issues. If the issue persists, follow the procedure in [Restart or Reset the Switch on page 129](#).

Issue	Resolution
Device Manager does not appear	<p>If you cannot display Device Manager from your computer, make sure that you entered the correct switch IP address in the browser. If you entered the correct switch IP address in the browser, make sure that the switch and your computer are in the same network or subnetwork:</p> <ul style="list-style-type: none"> <li>For example, if your switch IP address is 172.20.20.85 and your computer address is 172.20.20.84, both devices are in the same network.</li> <li>For example, if your switch IP address is 172.20.20.85 and your computer IP address is 10.0.0.2, the devices are in different networks and cannot directly communicate without a router. You must either change the switch IP address or change the computer IP address.</li> </ul>
Device Manager does not operate properly	<p>Open Device Manager in a new browser window by using a private browsing mode:</p> <ul style="list-style-type: none"> <li>In Internet Explorer, choose Safety &gt; InPrivate Browsing.</li> <li>In Firefox, choose New Private Window.</li> </ul>

## Restart or Reset the Switch

If you cannot solve an issue by reconfiguring a feature, you can restart or reset the switch to solve the issue. If the issue exists after you reset the switch to its default settings, it is unlikely that the switch is causing the issue.



**ATTENTION:** Resetting the switch deletes all customized switch settings, including the IP address, and returns the switch to its factory default. The same software image is retained. To manage the switch or display Device Manager, you must reconfigure switch settings, as described in [Chapter 2](#), and use the new IP address.

**IMPORTANT** When you restart or reset the switch, connectivity of your devices to the network is interrupted.

Option	Method	Description
Restart	<ul style="list-style-type: none"> <li>Device Manager</li> <li>Logix Designer application</li> </ul>	This option restarts the switch without turning off power. The switch retains its saved configuration settings during the restart process. However, Device Manager is unavailable during the process. When the process completes, the switch displays Device Manager.
Reset the switch to factory defaults	<ul style="list-style-type: none"> <li>Device Manager</li> <li>Express Setup button</li> </ul>	This option resets the switch, deletes the current configuration settings, returns to the factory default settings, and then restarts the switch.

## Restart or Reset the Switch from Device Manager

To restart or reset the switch, follow these steps.

1. From the Admin menu, under Device Management, choose Restart/Reset.
2. Click the radio button that corresponds to one of the actions that are described in [Table 64](#).
3. Click Submit.

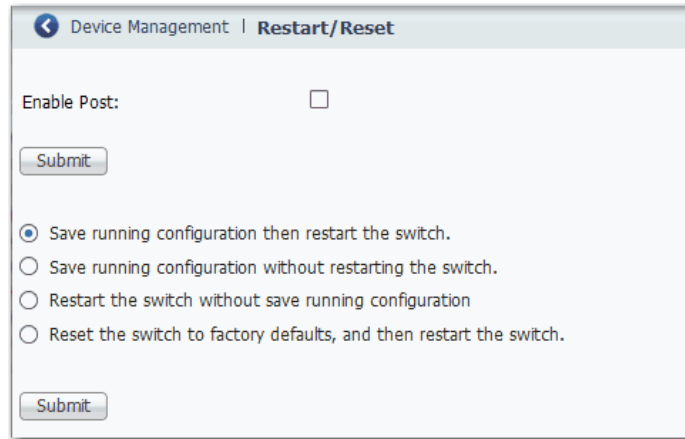

**Table 64 - Restart/Reset Fields**

Field	Description
Save running configuration and then restart the switch	Saves any changes in the running configuration and restarts the switch.
Save running configuration without restarting the switch	Saves the running configuration only and does not restart the switch,
Restart the switch without saving running configuration	Restarts the switch with its previously saved configuration settings.
Reset the switch to factory defaults, and then restart the switch	Resets the device to the factory default settings, which deletes the current configuration settings, and then restarts the device. You lose connectivity with the device and must run Express Setup to reconfigure the device.

## Reset the Switch with the Express Setup Button

Press and hold the Express Setup button until the Setup status indicator flashes alternating green and red during seconds 16...20, and then release. See also [Run Express Setup in Long Press Mode on page 22](#).

## Restart the Switch from the Logix Designer Application

To restart the switch, follow these steps.

1. In the navigation pane, click Module Info.
2. To restart the switch and save the current configuration, click Reset Module.
3. When a password prompt appears, enter your password and click Enter.

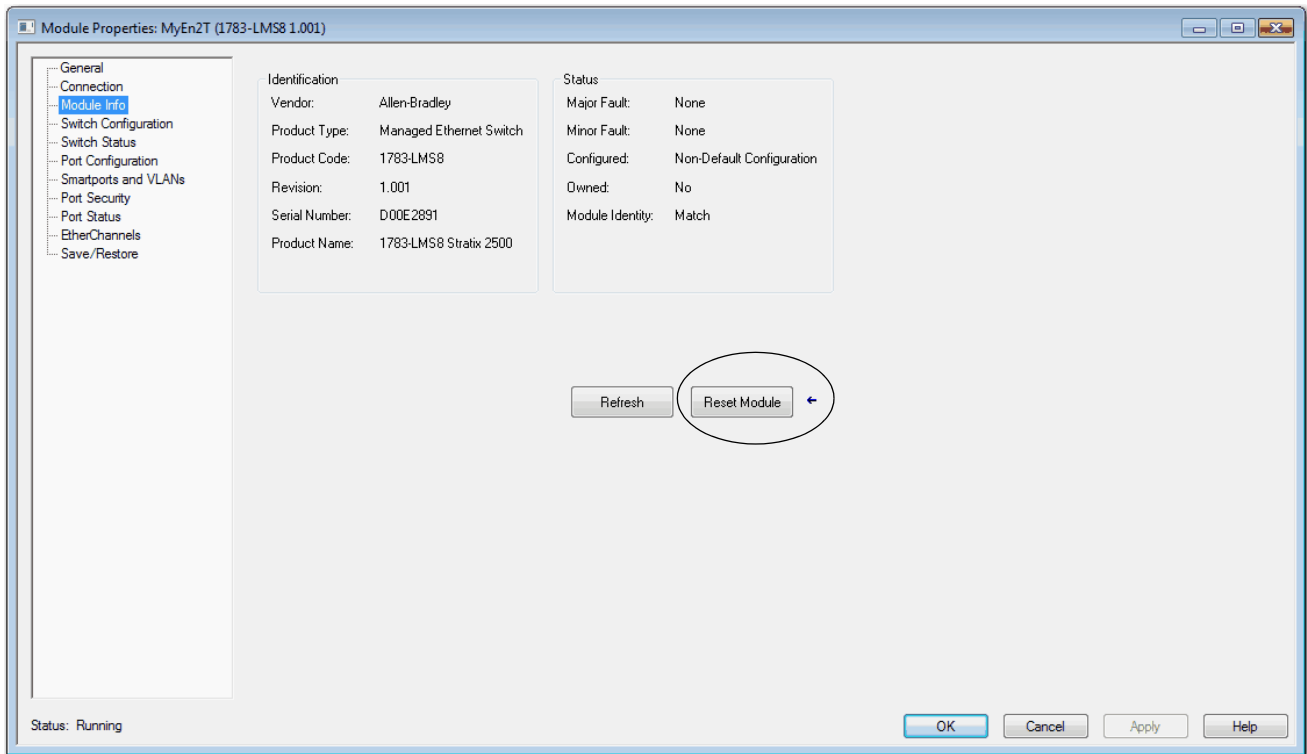

## Troubleshoot a Firmware Update

If you attempted to update the switch firmware but received a message that the update failed, make sure that you still have access to the switch. If you still have switch access, follow these steps.

1. Make sure that you downloaded the correct .bin file.
2. If you downloaded the correct .bin file, refresh the browser session for Device Manager to verify connectivity between the switch and your computer or network drive.
  - If you have connectivity to the switch and Device Manager, retry the update.
  - If you do not have connectivity to the switch and Device Manager, refer to [Restart or Reset the Switch on page 129](#).

## Troubleshoot with the Command-line Interface

Technical Support representatives from Rockwell Automation can use the command-line interface (CLI) to troubleshoot the switch.

To configure access to the switch via the CLI, follow the procedure in [Access Management in Device Manager on page 48](#).

## Status Indicators

Topic	Page
Port Status Indicators	134
System Status Indicators	134

The status indicators on the front panel of the switch let you monitor the switch status, activity, and performance.

The following figure shows the location of the port and system status indicators on the switch.

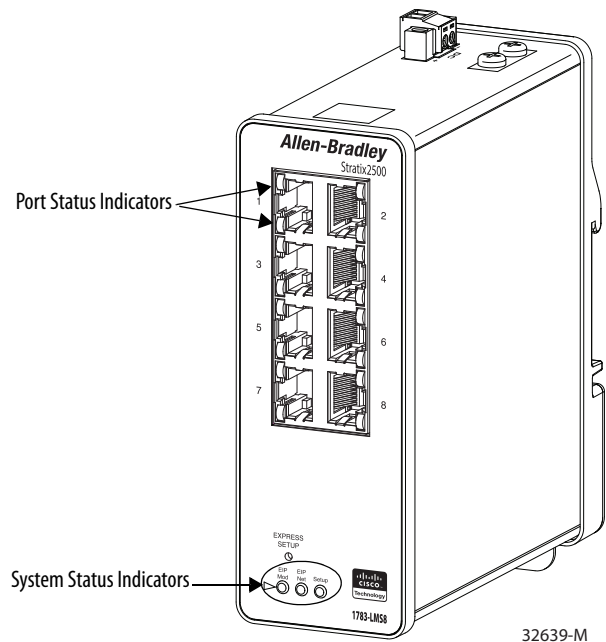

## Port Status Indicators

There are two status indicators for each port on the switch:

- The top status indicator is green.
- The bottom status indicator is amber.

Status	Description
Off	No link is present on the port.
Flashing green	The port is actively sending or receiving data.
Solid green	A port link is present, but there is no activity.
Alternating green and amber	There is a fault or error on the port.
Solid amber	The port is disabled. After a port is reconfigured, the port status indicator can remain amber for as long as 30 seconds while STP checks the switch for loops.

## System Status Indicators

The system status indicators include the EIP Mod, EIP Net, and Setup status indicators.

Indicator	Status	Description
EIP Mod		The EIP Mod status indicator shows the status of the switch.
	Off	Power to the switch is off or is not properly connected.
	Flashing green	The switch is not configured. For example, the switch does not have an IP address configured.
	Solid green	The switch is operating properly.
	Flashing red	The switch has detected a recoverable system fault.
	Solid red	The switch has detected a non-recoverable system fault.
EIP Net	Flashing green and red	The switch is running its power-on self-test (POST).
		The EIP Net status indicator shows the network status of the switch.
	Off	Power to the switch is off or the switch has no IP address.
	Flashing green	The switch has an IP address but does not have an established connection to one or more attached devices.
	Solid green	The switch has an established CIP connection to one or more attached devices.
	Flashing red	One or more connections to attached devices have timed out.
Setup	Solid red	The switch has detected that its IP address is already in use by another device in the network.
	Flashing green and red	The switch is running its power-on self-test (POST).
		The Setup status indicator shows the status of the initial setup of the switch.
	Off	The switch is operating as an unmanaged switch.
	Flashing green	The switch is in initial setup, in recovery, or initial setup is incomplete.
	Solid green	The switch is operating normally.
Solid red	The switch failed to start initial setup or recovery because there is no available switchport to which to connect the management station. Disconnect a device from a switch port, and then press the Express Setup button.	

## Data Types

Topic	Page
1783-LMS5 Data Types	136
1783-LMS8 Data Types	137

In the Studio 5000 Logix Designer® application, predefined tags for Input and Output data types have a structure that corresponds to the switch selected when it was added to the I/O tree. Its members are named in accordance with the port names.

You can disable a switch port by setting the corresponding bit in the output tag. The output bits are applied every time that the switch receives the output data from the controller when the controller is in Run mode. When the controller is in Program mode, the output bits are not applied.

The port is enabled if the corresponding output bit is 0. If you enable or disable a port by using Device Manager or the CLI, the port setting can be overridden by the output bits the next time they are applied. The output bits always take precedence, regardless of whether Device Manager or the CLI is used to enable or disable the port.

The following tables list module-defined data types for Stratix® 2500 switches. The tables include information for input (I) and output (O).

## 1783-LMS5 Data Types

**Table 65 - Input Data Types**

<b>AB:STRATIX_2500_5PORT_MANAGED:I:0</b>			
<b>Member Name</b>	<b>Type</b>	<b>Default Display Style</b>	<b>Valid Values</b>
Fault	DINT	Binary	
AnyPortConnected	BOOL	Decimal	LinkStatus:0
PortFa1_1Connected	BOOL	Decimal	LinkStatus:1
PortFa1_2Connected	BOOL	Decimal	LinkStatus:2
PortFa1_3Connected	BOOL	Decimal	LinkStatus:3
PortFa1_4Connected	BOOL	Decimal	LinkStatus:4
PortFa1_5Connected	BOOL	Decimal	LinkStatus:5
AnyPortUnauthorizedDevice	BOOL	Decimal	UnauthorizedDevice:0
PortFa1_1UnauthorizedDevice	BOOL	Decimal	UnauthorizedDevice:1
PortFa1_2UnauthorizedDevice	BOOL	Decimal	UnauthorizedDevice:2
PortFa1_3UnauthorizedDevice	BOOL	Decimal	UnauthorizedDevice:3
PortFa1_4UnauthorizedDevice	BOOL	Decimal	UnauthorizedDevice:4
PortFa1_5UnauthorizedDevice	BOOL	Decimal	UnauthorizedDevice:5
AnyPortThreshold	BOOL	Decimal	ThresholdExceeded:0
PortFa1_1Threshold	BOOL	Decimal	ThresholdExceeded:1
PortFa1_2Threshold	BOOL	Decimal	ThresholdExceeded:2
PortFa1_3Threshold	BOOL	Decimal	ThresholdExceeded:3
PortFa1_4Threshold	BOOL	Decimal	ThresholdExceeded:4
PortFa1_5Threshold	BOOL	Decimal	ThresholdExceeded:5
AllPortsUtilization	SINT	Decimal	
PortFa1_1Utilization	SINT	Decimal	
PortFa1_2Utilization	SINT	Decimal	
PortFa1_3Utilization	SINT	Decimal	
PortFa1_4Utilization	SINT	Decimal	
PortFa1_5Utilization	SINT	Decimal	
MajorAlarmRelay	BOOL	Decimal	AlarmRelay:0
MulticastGroupActive	DINT	Binary	

**Table 66 - Output Data Types**

<b>AB:STRATIX_2500_5PORT_MANAGED:O:0</b>			
<b>Member Name</b>	<b>Type</b>	<b>Default Display Style</b>	<b>Valid Values</b>
AllPortsDisabled	BOOL	Decimal	DisablePort:0
PortFa1_1Disable	BOOL	Decimal	DisablePort:1
PortFa1_2Disable	BOOL	Decimal	DisablePort:2
PortFa1_3Disable	BOOL	Decimal	DisablePort:3
PortFa1_4Disable	BOOL	Decimal	DisablePort:4
PortFa1_5Disable	BOOL	Decimal	DisablePort:5



**1783-LMS8 Data Types****Table 67 - Input Data Types**

<b>AB:STRATIX_2500_8PORT_MANAGED:I:0</b>			
<b>Member Name</b>	<b>Type</b>	<b>Default Display Style</b>	<b>Valid Values</b>
Fault	DINT	Binary	
AnyPortConnected	BOOL	Decimal	LinkStatus:0
PortFa1_1Connected	BOOL	Decimal	LinkStatus:1
PortFa1_2Connected	BOOL	Decimal	LinkStatus:2
PortFa1_3Connected	BOOL	Decimal	LinkStatus:3
PortFa1_4Connected	BOOL	Decimal	LinkStatus:4
PortFa1_5Connected	BOOL	Decimal	LinkStatus:5
PortFa1_6Connected	BOOL	Decimal	LinkStatus:6
PortFa1_7Connected	BOOL	Decimal	LinkStatus:7
PortFa1_8Connected	BOOL	Decimal	LinkStatus:8
AnyPortUnauthorizedDevice	BOOL	Decimal	UnauthorizedDevice:0
PortFa1_1UnauthorizedDevice	BOOL	Decimal	UnauthorizedDevice:1
PortFa1_2UnauthorizedDevice	BOOL	Decimal	UnauthorizedDevice:2
PortFa1_3UnauthorizedDevice	BOOL	Decimal	UnauthorizedDevice:3
PortFa1_4UnauthorizedDevice	BOOL	Decimal	UnauthorizedDevice:4
PortFa1_5UnauthorizedDevice	BOOL	Decimal	UnauthorizedDevice:5
PortFa1_6UnauthorizedDevice	BOOL	Decimal	UnauthorizedDevice:6
PortFa1_7UnauthorizedDevice	BOOL	Decimal	UnauthorizedDevice:7
PortFa1_8UnauthorizedDevice	BOOL	Decimal	UnauthorizedDevice:8
AnyPortThreshold	BOOL	Decimal	ThresholdExceeded:0
PortFa1_1Threshold	BOOL	Decimal	ThresholdExceeded:1
PortFa1_2Threshold	BOOL	Decimal	ThresholdExceeded:2
PortFa1_3Threshold	BOOL	Decimal	ThresholdExceeded:3
PortFa1_4Threshold	BOOL	Decimal	ThresholdExceeded:4
PortFa1_5Threshold	BOOL	Decimal	ThresholdExceeded:5
PortFa1_6Threshold	BOOL	Decimal	ThresholdExceeded:6
PortFa1_7Threshold	BOOL	Decimal	ThresholdExceeded:7
PortFa1_8Threshold	BOOL	Decimal	ThresholdExceeded:8
AllPortsUtilization	SINT	Decimal	
PortFa1_1Utilization	SINT	Decimal	
PortFa1_2Utilization	SINT	Decimal	
PortFa1_3Utilization	SINT	Decimal	
PortFa1_4Utilization	SINT	Decimal	
PortFa1_5Utilization	SINT	Decimal	
PortFa1_6Utilization	SINT	Decimal	
PortFa1_7Utilization	SINT	Decimal	

**Table 67 - Input Data Types (continued)**

<b>AB:STRATIX_2500_8PORT_MANAGED:I:0</b>			
<b>Member Name</b>	<b>Type</b>	<b>Default Display Style</b>	<b>Valid Values</b>
PortFa1_8Utilization	SINT	Decimal	
MajorAlarmRelay	BOOL	Decimal	AlarmRelay:0
MulticastGroupActive	DINT	Binary	

**Table 68 - Output Data Types**

<b>AB:STRATIX_2500_8PORT_MANAGED:O:0</b>			
<b>Member Name</b>	<b>Type</b>	<b>Default Display Style</b>	<b>Valid Values</b>
AllPortsDisabled	BOOL	Decimal	DisablePort:0
PortFa1_1Disable	BOOL	Decimal	DisablePort:1
PortFa1_2Disable	BOOL	Decimal	DisablePort:2
PortFa1_3Disable	BOOL	Decimal	DisablePort:3
PortFa1_4Disable	BOOL	Decimal	DisablePort:4
PortFa1_5Disable	BOOL	Decimal	DisablePort:5
PortFa1_6Disable	BOOL	Decimal	DisablePort:6
PortFa1_7Disable	BOOL	Decimal	DisablePort:7
PortFa1_8Disable	BOOL	Decimal	DisablePort:8

## Port Assignments for CIP Data

<b>Topic</b>	<b>Page</b>
1783-LMS5 Port Assignments	140
1783-LMS8 Port Assignments	140

The following tables identify the instance numbers of the Ethernet link objects that are associated with each port on the switch. Instance 0 does not apply to all ports as it does for bitmaps.

The bit numbers identify each port when they are contained in a structure of all ports, such as in the output assembly. Bit 0 refers to any or all ports.

### 1783-LMS5 Port Assignments

Bit	Port
0	Any/All ports
1	Fa1/1
2	Fa1/2
3	Fa1/3
4	Fa1/4
5	Fa1/5

### 1783-LMS8 Port Assignments

Bit	Port
0	Any/All ports
1	Fa1/1
2	Fa1/2
3	Fa1/3
4	Fa1/4
5	Fa1/5
6	Fa1/6
7	Fa1/7
8	Fa1/8

## Port Numbering

<b>Topic</b>	<b>Page</b>
1783-LMS5 Port Numbering	142
1783-LMS8 Port Numbering	142

The port ID consists of the following:

- Port type (Fast Ethernet for 10/100 Mbps ports)
- Unit number (always 1)
- Port number (1...8, depending on the catalog number)

Fast Ethernet is abbreviated as Fa.

## 1783-LMS5 Port Numbering

Port Numbering on Switch Labels	Port Numbering in config.txt Text File
1	Fa1/1
2	Fa1/2
3	Fa1/3
4	Fa1/4
5	Fa1/5

## 1783-LMS8 Port Numbering

Port Numbering on Switch Labels	Port Numbering in config.txt Text File
1	Fa1/1
2	Fa1/2
3	Fa1/3
4	Fa1/4
5	Fa1/5
6	Fa1/6
7	Fa1/7
8	Fa1/8

## **Cables and Connectors**

<b>Topic</b>	<b>Page</b>
10/100 Ports	144
Connect to 10BASE-T- and 100BASE-TX-Compatible Devices	144

This appendix describes how to connect to Stratix® 2500 ports.

## 10/100 Ports

The 10/100 Ethernet ports use standard RJ45 connectors and Ethernet pinouts with internal crossovers.

**Figure 4 - 10/100 Connector Pinouts**

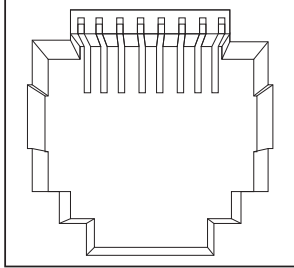
Pin	Label	1	2	3	4	5	6	7	8
1	RD+								
2	RD-								
3	TD+								
4	NC								
5	NC								
6	TD-								
7	NC								
8	NC								

## Connect to 10BASE-T- and 100BASE-TX-Compatible Devices

The auto-MDIX feature is enabled by default. Follow these cabling guidelines when the auto-MDIX feature has been disabled.

When connecting the ports to 10BASE-T- and 100BASE-TX-compatible devices, such as servers and routers, you can use a two or four twisted-pair, straight-through cable that is wired for 10BASE-T and 100BASE-TX.

To identify a crossover cable, compare the two modular ends of the cable. Hold the cable ends side by side, with the tab at the back. The color of the wire that is connected to the pin on the outside of the left plug must differ in color from the wire that is connected to the pin on the inside of the right plug.

[Figure 5](#) and [Figure 6](#) show the cable schematics.

**Figure 5 - Two Twisted-pair Straight-through Cable Schematics**

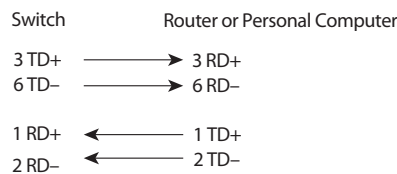

**Figure 6 - Four Twisted-pair Straight-through Cable Schematics**

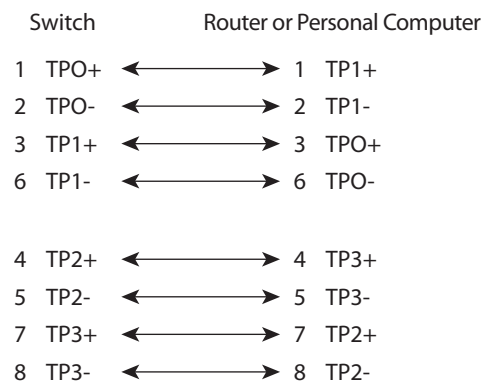



When connecting the ports to 10BASE-T- and 100BASE-TX-compatible devices, such as switches or repeaters, you can use a two or four twisted-pair, crossover cable.

Use a straight-through cable to connect two ports when only one port is designated with an X. Use a crossover cable to connect two ports when both ports are designated with an X or when both ports do not have an X.

You can use Category 3, 4, or 5 cabling when connecting to 10BASE-T-compatible devices. You must use Category 5 cabling when connecting to 100BASE-TX-compatible devices.

---

**IMPORTANT** Use a four twisted-pair, Category 5 cable when connecting to a 100BASE-T-compatible device.

---

[Figure 7](#) and [Figure 8](#) show the cable schematics.

**Figure 7 - Two Twisted-pair Crossover Cable Schematics**

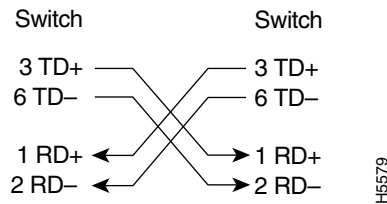

**Figure 8 - Four Twisted-pair Crossover Cable Schematics**

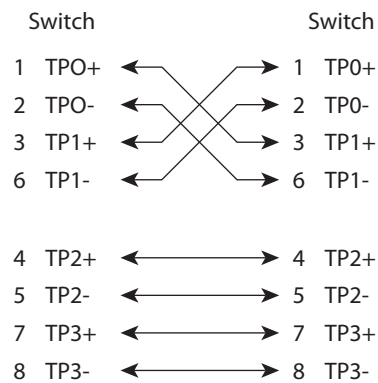

**Notes:**

## Numerics

802.1X 50

## A

### AAA validation method

local 40  
radius-local 40  
tacacs-local 40

### access

Device Manager 28, 48  
release notes 7

### Access mode, port 32

### access VLAN 32

### acknowledge alarm 110

### active image 46

### add

controller project 33  
Device Manager user 40  
EtherChannel 66  
MST instance 94  
port to VLAN 99  
SNMP community string 81  
SNMP group 85  
SNMP trap recipients 80  
SNMP user 83  
VLAN 99, 101

### address aliasing 69

### address, gateway 38

### address, IP 17, 20, 23, 24, 25, 128

### administrative user 23

### agent, SNMP 77

### alarm

acknowledge 110  
configure 52  
junction temperature 51  
switch temperature 51  
system 109

### alert log 115

### autonegotiation 32, 39

## B

### backup image 46

### bootstrap protocol, BOOTP 59

### BPDU 16

### BPDU Filtering 91

### BPDU Guard 91

### browser requirements 27

### button, Express Setup 17

## C

### cables

crossover 144, 145  
damaged 127  
Ethernet 127  
straight-through 144, 145

## CIP

about 10  
data 12  
enable 16  
enable on VLAN 23

### CIP security timeout 24

### CIP status 113

### CLI

access via SSH 23, 48, 132

### communication to controller 36

### community string, SNMP 81

### configuration file

manage in Device Manager 42  
manage in Logix Designer application 44

### configuration, out-of-the-box 16

### configure

802.1X 50  
alarms 52  
connection properties 36  
DHCP persistence 55, 60  
EtherChannels 64  
general switch properties 34  
IGMP snooping 69  
IP address settings 37, 38  
IP settings 25  
network settings 22, 24  
port mirroring 71  
port security 73  
port settings 30  
ports 39  
QoS priority 76  
Smartports 87  
SNMP 77  
storm control 96  
STP 90  
tacacs/radius server 97  
VLAN 98

### connection

CIP 10  
Data 35  
Input Data 35  
properties 36  
unicast 36

### connectors and cables

10/100 ports 144, 145

### control, storm 96

### controller project 33

### CPU utilization 106

### crossover cable

identify 144  
pinout 145

### customization

DHCP server 55, 60  
IP address  
DHCP IP address pool 57, 62  
switch port 59, 63  
IP address (for connected devices) 55, 60

## D

### dashboard, Device Manager 104

**data connection password** 35

**data type** 135

**default**

login credentials 20

**default gateway** 62

**default router** 57

**delete**

Device Manager user 40

EtherChannel 66

SNMP group 85

SNMP user 83

VLAN 99, 101

**Device Manager**

about 27

access 28, 48

hardware requirements 27

software requirements 27

troubleshoot 129

user 40

**DHCP**

IP address assignment 23, 25, 38, 63

IP address pool, Device Manager 56

IP address pool, Logix Designer 61

persistence 54

port configurations, Device Manager 58

troubleshoot 128

**DHCP persistence behavior** 55

**DHCP snooping**

Device Manager 58

Logix Designer 60

**diagnostics, port** 122

**disable** 36

BPDU filter 94

BPDU Guard 94

junction temperature alarm 53

keying 35

port 39, 135

port error recovery 94

port security 73

switch temperature alarm 53

traps 82

**DNS address** 62

**DNS server** 38

**DNS server1 and 2** 57

**domain name** 38, 57, 62

**Dot 1x** 51

**download**

configuration file 43

EDS file 11

publications 8

release notes 7

software update 46

**Duplex mode** 32

## E

**edit**

Device Manager user 40

EtherChannel 66

SNMP group 85

SNMP user 83

VLAN 99, 101

**EDS file** 11

**EIP Mod status indicator** 134

**EIP Net status indicator** 134

**electronic keying** 35

**enable**

802.1X 51

BPDU Filter 16

BPDU Guard 16

CIP 16, 23

DHCP snooping, Device Manager 58

DHCP snooping, Logix Designer 60

MSTP 16

port security 73

POST 126

QoS priority 76

storm control 96

traps 82

**encryption** 16

**entry, system log** 117

**EtherChannels**

about 64

configure via Logix Designer application 67

example 64

**Ethernet cable** 127

**EtherNet/IP CIP interface** 10

**EtherNet/IP network** 10, 125

**EtherNet/IP protocol** 87, 113

**explicit messaging** 10

**Express Setup**

about 16

button 17

Device Manager 22

Logix Designer application 25

Long Press mode 22

Medium Press mode 21

modes 18

requirements 18

Short Press mode 19

## F

**factory default settings** 22

**fault, major** 36

**fault, module** 36

**features**

hardware 13

software 13

**file, configuration** 42, 44

**file, EDS** 11

**firmware update, troubleshoot** 131

**front panel** 104

**Full-duplex mode** 32

## G

**gateway address** 38

**global settings, 802.1X** 51

**group, SNMP** 84

**H**

**Half-duplex mode** 32  
**hardware features** 13  
**hardware requirements**  
     Device Manager 27  
**host name** 38  
**HTTP** 16, 42, 46  
**HTTPS** 16  
**Hybrid mode, port** 32

**I**

**IGMP snooping**  
     about 69  
     address aliasing 69  
     configure via Device Manager 70  
**image**  
     active 46  
     backup 46  
**implicit messaging** 10  
**indicator**  
     Setup status 18  
     setup status 18  
**indicators**  
     port status 134  
     system status 134  
**individual port administration**  
     802.1X 51  
**inhibit module** 36  
**Input Data connection** 35  
**input data types** 135  
**installation instructions** 8  
**installation options** 9, 16  
**instructions, installation** 8  
**IP address** 38  
     assignment mode 23  
     CIP 24  
     computer 20  
     customization  
         connected devices 55  
         DHCP IP address pool 57, 62  
         switch port 59, 63  
     DHCP 25  
     DHCP IP address pool  
         ending range 57, 62  
         starting range 57, 62  
     switch port 59, 63  
         assigning 59  
         deleting 59  
         modifying 59  
         troubleshoot 128  
**IP assignment mode** 23, 38

**J**

**junction temperature** 51

**K**

**keying, electronic** 35

**L**

**lease length** 57  
**LED. See status indicators**  
**limits, MAC address** 72  
**link status** 128  
**local**  
     AAA validation method 40  
**log, system** 115  
**Logix Designer**  
     DHCP persistence 60  
**Logix Designer application**  
     about 33  
**Long Press mode Express Setup** 18, 22

**M**

**MAC address limits** 72  
**major fault** 36  
**management interface** 27  
**management protocol** 16  
**management VLAN** 26, 99  
**manager, SNMP** 77  
**Medium Press mode Express Setup** 18, 21  
**messages** 10  
     explicit 10  
     implicit 10  
     SNMP 82  
     system log 115  
**MIB** 78  
**mirroring, port** 71  
**mismatch prevention, Smartports** 88  
**mode**  
     Access 87  
     EtherChannel 64, 66  
     Express Setup 18  
     IP assignment 23  
     Protect 72  
     Restrict 72  
     Shutdown 72  
     STP 91  
     Trunk 87  
**module fault** 36  
**module information** 120  
**module, inhibit** 36  
**module-defined data type** 135  
**monitor**  
     alert log 115  
     CIP status 113  
     front panel 104  
     module information 120  
     port diagnostics 122  
     port mirroring 71  
     port security 111  
     port statistics 110  
     port status 121  
     port utilization 107  
     status indicators 126  
     switch health 106  
     switch status 118  
     system alarm 109

**MST instance** 94

**MSTP** 16

## N

**native VLAN** 32

**network access**

tacacs/radius 97

**network settings**

configure via Device Manager 22

configure via Logix Designer application 24

**NTP server** 23, 25

## O

**out-of-the-box configuration** 16

**output data types** 135

## P

**password**

administrative user 23

CIP security 24

data connection 35

**persistence**

DHCP 54

**persistence behavior**

DHCP 55

**ping utility**

statistics 117

**pinout**

crossover cable 145

RJ45 connector 144

straight-through cable 144

**pool name** 57, 59, 62

**port**

configure via Device Manager 30

configure via Logix Designer application 39

enable/disable 32

**port administrative mode** 32

**port assignments for CIP data** 139, 141

**port diagnostics** 122

**port Duplex mode** 32

**port mirroring**

about 71

configure via Device Manager 71

**port numbering** 32

**port security** 72, 73

**port security statistics** 111

**port settings** 128

**port speed** 32

**port statistics** 110

**port status** 121

**port status indicators** 134

**port utilization** 107

**PortFast** 91

**POST** 126

**Primary DNS server** 23

**project, controller** 33

**properties, connection** 36

**Protect mode** 72

**protocol**

HTTPS 16

IGMP 69

management 16

SNMP 16

SSH 16

STP 90

**PTP** 76

## Q

**QoS**

about 76

configure via Device Manager 76

**quieter, IGMP snooping** 69

## R

**radius security protocol** 97

**radius-local**

AAA validation method 40

**recovery**

firmware update 131

**release notes** 7

**requested packet interval** 36

**requirements**

Device Manager 27

Express Setup 18

web browser 27

**reset switch** 130

**restart switch**

via Device Manager 129, 130

via Logix Designer application 129, 131

with factory defaults 22

**restore connection** 128

**Restrict mode** 72

**revision, switch** 35

**RJ45 connector**

pinout 144

**roles, Smartport** 87

**RSLinux software** 11

**RSWho** 11

## S

**Secondary DNS server** 23

**security modes, port security** 72

**security, CIP** 24

**security, port** 111

configure via Device Manager 73

configure via Logix Designer application 75

**server configuration**

tacacs/radius 97

**server, DNS** 38

**server, NTP** 23, 25

**server, Primary DNS** 23

**server, Secondary DNS** 23

- settings, factory default** 22, 129
  - Setup status indicator** 18, 19, 21, 22, 134
  - Short Press mode Express Setup** 18, 19
  - Shutdown mode** 72
  - Smartports**
    - about 87
    - assign via Device Manager 88
    - assign via Logix Designer application 89
    - mismatch prevention 88
    - VLAN assignment 89
  - SNMP** 16
    - about 77
    - agent 77
    - community string 81
    - configure via Device Manager 79
    - group 84
    - manager 77
    - MIB 78
    - system options 80
    - traps 82
    - user 83
    - view 83
  - snooping**
    - DHCP, Device Manager 58
    - DHCP, Logix Designer 60
    - IGMP 69
  - snooping, IGMP** 69
  - software**
    - Device Manager requirements 27
    - features 13
    - RSLinx 11
    - update 46
  - software features**
    - customization
      - DHCP server settings 55, 60
  - specifications, switch** 8
  - speed, port** 32
  - SSH** 16, 48, 132
  - statistics**
    - ping 117
    - port 110
    - port security 111
  - status indicators** 126, 133
  - status, CIP** 113
  - status, link** 128
  - status, port** 121
  - status, setup** 18
  - status, switch** 118
  - sticky MAC** 74, 112
  - storm control**
    - about 96
    - configure via Device Manager 96
  - STP**
    - about 90
    - configure via Device Manager 92
    - modes 91
  - straight-through cable**
    - pinout 144
  - string, community** 81
  - Studio 5000 environment** 33
  - subnet mask**
    - DHCP IP address pool 57, 62
  - switch**
    - configure via Device Manager 27
    - configure via Logix Designer application 37
    - install 8
    - monitor 104
    - reset 130
    - restart 129
    - troubleshoot 125
      - Device Manager 129
      - DHCP 128
      - firmware update 131
      - IP address 128
  - switch health** 106
  - switch information** 105
  - switch installation options** 9
  - switch IP settings** 37
  - switch revision** 35
  - switch specifications** 8
  - switch status** 118
  - switch status indicators** 126
  - switch temperature** 51
  - SYSLOG** 16, 115
  - system alarm** 109
  - system log** 115
  - system options, SNMP** 80
  - system status indicators** 134
- T**
- tacacs+ security protocol** 97
  - tacacs-local**
    - AAA validation method 40
  - technical specifications** 8
  - Telnet** 16
  - temperature**
    - junction 51
    - switch 51
  - TFTP** 42, 46
  - timeout, CIP security** 24
  - traffic prioritization** 76
  - traffic storm** 96
  - traps, SNMP** 82
  - troubleshoot**
    - Device Manager 129
    - DHCP 128
    - EtherNet/IP network 125
    - firmware update 131
    - IP address 128
    - link status 128
    - port settings 128
    - reset switch 130
    - switch 125
  - troubleshoot connectivity**
    - ping 117
  - Trunk mode, port** 32

## U

**unicast connection** 36

**update, software** 46

**upload**

configuration file 42, 44  
EDS file 11

**user**

add 40  
administrative password 23  
delete 40  
edit 40  
password 41  
privilege 41  
SNMP 83  
validation 40

**utility**

ping 117

## V

**validating users**

AAA method 40

**view, SNMP** 83

**violation, security** 72

**VLAN**

access 32  
add port 99  
configure via Device Manager 99  
configure via Logix Designer application 100  
enable CIP 23  
management VLAN 38, 99  
native 32

## W

**web browser requirements** 27





## Rockwell Automation Support

Use the following resources to access support information.

<b>Technical Support Center</b>	Knowledgebase Articles, How-to Videos, FAQs, Chat, User Forums, and Product Notification Updates.	<a href="https://rockwellautomation.custhelp.com/">https://rockwellautomation.custhelp.com/</a>
<b>Local Technical Support Phone Numbers</b>	Locate the phone number for your country.	<a href="http://www.rockwellautomation.com/global/support/get-support-now.page">http://www.rockwellautomation.com/global/support/get-support-now.page</a>
<b>Direct Dial Codes</b>	Find the Direct Dial Code for your product. Use the code to route your call directly to a technical support engineer.	<a href="http://www.rockwellautomation.com/global/support/direct-dial.page">http://www.rockwellautomation.com/global/support/direct-dial.page</a>
<b>Literature Library</b>	Installation Instructions, Manuals, Brochures, and Technical Data.	<a href="http://www.rockwellautomation.com/global/literature-library/overview.page">http://www.rockwellautomation.com/global/literature-library/overview.page</a>
<b>Product Compatibility and Download Center (PCDC)</b>	Get help determining how products interact, check features and capabilities, and find associated firmware.	<a href="http://www.rockwellautomation.com/global/support/pcdc.page">http://www.rockwellautomation.com/global/support/pcdc.page</a>

## Documentation Feedback

Your comments will help us serve your documentation needs better. If you have any suggestions on how to improve this document, complete the How Are We Doing? form at [http://literature.rockwellautomation.com/idc/groups/literature/documents/du/ra-du002\\_-en-e.pdf](http://literature.rockwellautomation.com/idc/groups/literature/documents/du/ra-du002_-en-e.pdf).

Rockwell Automation maintains current product environmental information on its website at <http://www.rockwellautomation.com/rockwellautomation/about-us/sustainability-ethics/product-environmental-compliance.page>.

Allen-Bradley, Rockwell Automation, Rockwell Software, RSLinx, RSLogix 5000, RSNetWorx, Stratix, Studio 5000, and Studio 5000 Logix Designer are trademarks of RockwellAutomation, Inc. Trademarks not belonging to Rockwell Automation are property of their respective companies.

Rockwell Otomasyon Ticaret A.Ş., Kar Plaza İş Merkezi E Blok Kat:6 34752 İçerenköy, İstanbul, Tel: +90 (216) 5698400

**[www.rockwellautomation.com](http://www.rockwellautomation.com)**

### Power, Control and Information Solutions Headquarters

Americas: Rockwell Automation, 1201 South Second Street, Milwaukee, WI 53204-2496 USA, Tel: (1) 414.382.2000, Fax: (1) 414.382.4444  
Europe/Middle East/Africa: Rockwell Automation NV, Pegasus Park, De Kleetlaan 12a, 1831 Diegem, Belgium, Tel: (32) 2 663 0600, Fax: (32) 2 663 0640  
Asia Pacific: Rockwell Automation, Level 14, Core F, Cyberport 3, 100 Cyberport Road, Hong Kong, Tel: (852) 2887 4788, Fax: (852) 2508 1846

Publication 1783-UM009B-EN-P - June 2018

Supersedes Publication 1783-UM009A-EN-P May 2017

Copyright © 2018 Rockwell Automation, Inc. All rights reserved. Printed in the U.S.A.