

# Stratix Managed Switches

Stratix 5400 Switches (1783-HMS)

Stratix 5410 Switches (1783-IMS)

Stratix 5700 Switches (1783-BMS)

ArmorStratix 5700 Switches (1783-ZMS)

Stratix 8000 and 8300 Switches (1783-MS, 1783-RMS, 1783-MX)



## Important User Information

Read this document and the documents listed in the additional resources section about installation, configuration, and operation of this equipment before you install, configure, operate, or maintain this product. Users are required to familiarize themselves with installation and wiring instructions in addition to requirements of all applicable codes, laws, and standards.

Activities including installation, adjustments, putting into service, use, assembly, disassembly, and maintenance are required to be carried out by suitably trained personnel in accordance with applicable code of practice.

If this equipment is used in a manner not specified by the manufacturer, the protection provided by the equipment may be impaired.

In no event will Rockwell Automation, Inc. be responsible or liable for indirect or consequential damages resulting from the use or application of this equipment.

The examples and diagrams in this manual are included solely for illustrative purposes. Because of the many variables and requirements associated with any particular installation, Rockwell Automation, Inc. cannot assume responsibility or liability for actual use based on the examples and diagrams.

No patent liability is assumed by Rockwell Automation, Inc. with respect to use of information, circuits, equipment, or software described in this manual.

Reproduction of the contents of this manual, in whole or in part, without written permission of Rockwell Automation, Inc., is prohibited

Throughout this manual, when necessary, we use notes to make you aware of safety considerations.



**WARNING:** Identifies information about practices or circumstances that can cause an explosion in a hazardous environment, which may lead to personal injury or death, property damage, or economic loss.



**ATTENTION:** Identifies information about practices or circumstances that can lead to personal injury or death, property damage, or economic loss. Attentions help you identify a hazard, avoid a hazard, and recognize the consequence.

---

**IMPORTANT** Identifies information that is critical for successful application and understanding of the product.

---

Labels may also be on or inside the equipment to provide specific precautions.



**SHOCK HAZARD:** Labels may be on or inside the equipment, for example, a drive or motor, to alert people that dangerous voltage may be present.



**BURN HAZARD:** Labels may be on or inside the equipment, for example, a drive or motor, to alert people that surfaces may reach dangerous temperatures.



**ARC FLASH HAZARD:** Labels may be on or inside the equipment, for example, a motor control center, to alert people to potential Arc Flash. Arc Flash will cause severe injury or death. Wear proper Personal Protective Equipment (PPE). Follow ALL Regulatory requirements for safe work practices and for Personal Protective Equipment (PPE).

---

	<b>Preface</b> .....	<b>11</b>
	Summary of Changes .....	11
	Additional Resources .....	12
	 <b>Chapter 1</b>	
<b>About the Switches</b>	Stratix Managed Switches .....	14
	Stratix 5700 Lite Versus Full Firmware Features .....	15
	Software Features .....	16
	Hardware Features .....	19
	Memory Allocation .....	22
	Stratix 5400 Templates .....	22
	Stratix 5410 Templates .....	23
	Stratix 5700 and ArmorStratix 5700 Templates .....	24
	Stratix 8000 and 8300 Templates .....	25
	 <b>Chapter 2</b>	
<b>Get Started</b>	Express Setup Overview .....	28
	Express Setup Requirements .....	28
	Express Setup Button .....	29
	Multi-mode Express Setup .....	32
	Run Multi-mode Express Setup in Short Press Mode .....	33
	Run Multi-mode Express Setup in Medium Press Mode .....	34
	Run Multi-mode Express Setup in Long Press Mode .....	35
	Single-mode Express Setup .....	36
	Configure Network Settings via Device Manager .....	37
	Apply the PnP Setup Mode .....	37
	Apply the Express Setup Configuration .....	39
	Configure Network Settings via the Logix Designer Application ..	42
	Default Global Macro .....	44
	Linux-based Software and Network Who Support .....	45
	Electronic Data Sheet (EDS) Files .....	45
	Data Accessible with CIP .....	46
	Configuration via Device Manager .....	47
	Access Device Manager .....	48
	Configure Port Settings .....	51
	Configuration via the Studio 5000 Environment .....	53
	General Properties .....	55
	Connection Properties .....	57
	Switch Configuration .....	58
	Port Configuration .....	59
	Port States During Program Mode and Connection Faults .....	60
	User Administration via Device Manager .....	62
	Configuration Files .....	63
	Manage Configuration Files via Device Manager .....	63
	Manage Configuration Files via the Logix Designer Application ..	64

Secure Digital (SD) Card ..... 65  
     Synchronize the SD Card via Device Manager ..... 66  
     Synchronize the SD Card via the Logix Designer Application . 70  
 CompactFlash Memory Card ..... 71  
 Firmware Updates..... 71  
 Cisco Network Assistant..... 72  
 Command-line Interface..... 73  
     Connect to the Console Port ..... 73  
     Enable SSH or Telnet in Device Manager..... 74

**Chapter 3**

**Configure Switch Features**

Access Control Lists (ACLs) ..... 76  
     Configure ACLs via Device Manager..... 77  
 Alarms ..... 81  
     Configure Alarms via Device Manager..... 82  
 CIP Sync Time Synchronization (Precision Time Protocol) ..... 86  
     Boundary Mode ..... 87  
     End to End Transparent Mode ..... 87  
     Forward Mode ..... 87  
     NTP-PTP Clock Mode ..... 88  
     Configure Time Synchronization via Device Manager ..... 89  
     Configure Time Synchronization via the Logix Designer  
     Application ..... 96  
     View Time Sync Information in the Logix Designer Application. 101  
 Cryptographic IOS..... 103  
 Device Level Ring (DLR) Topology..... 104  
     Overview ..... 104  
     DLR Port Choices..... 106  
     DLR Considerations..... 107  
     Redundant Gateways ..... 108  
     DHCP for Ring Devices ..... 113  
     Multiple Rings ..... 117  
     Configure DLR via Device Manager ..... 119  
     Configure DLR via the Logix Designer Application ..... 123  
 Dynamic Host Configuration Protocol (DHCP) Persistence .... 131  
     Configure DHCP Persistence via Device Manager ..... 133  
     Configure DHCP Persistence via the Logix Designer Application 136  
 Enhanced Interior Gateway Routing Protocol (EIGRP) ..... 140  
     Configure EIGRP via Device Manager ..... 141  
 EtherChannels..... 146  
     Configure EtherChannels via Device Manager ..... 148  
     Configure EtherChannels via the Logix Designer Application 151  
 Feature Mode..... 153  
 Global Navigation Satellite System (GNSS) ..... 154  
     GNSS Hardware ..... 154  
     GNSS Software..... 154  
     GNSS Signaling ..... 155

GNSS Considerations .....	156
Configure GNSS .....	156
High-availability Seamless Redundancy (HSR) .....	156
Horizontal Stacking .....	157
Internet Group Management Protocol (IGMP) Snooping with Querier .....	159
Configure IGMP Snooping with Querier via Device Manager	160
Maximum Transmission Unit (MTU) .....	161
Configure the MTU via Device Manager .....	161
Motion Prioritized QoS Macros .....	162
Configure Motion Prioritized QoS Macros via Device Manager .....	162
NetFlow .....	163
NetFlow Templates .....	164
Configure NetFlow via Device Manager .....	165
Apply a NetFlow Configuration via Device Manager .....	166
Network Address Translation (NAT) .....	167
Configuration Overview .....	167
VLAN Assignments .....	173
Configuration Considerations .....	174
Traffic Permits and Fixups .....	175
Configure NAT via Device Manager .....	175
Configure NAT via the Logix Designer Application .....	187
Configure NAT via the Logix Designer Application (Stratix 5410 Switches) .....	199
View Address Translations in Linx-based Software .....	207
Network Time Protocol (NTP) .....	208
Configure NTP in Device Manager .....	208
Configure NTP via the Logix Designer Application .....	211
Open Shortest Path First (OSPF) Routing Protocol .....	212
Configure OSPF via Device Manager .....	214
Parallel Redundancy Protocol (PRP) .....	219
RedBox PRP Channel Groups .....	220
Traffic and Supervisory Frames .....	221
Node and VDAN Limitations .....	221
Configuration Considerations .....	222
Configure a RedBox via Device Manager .....	222
Troubleshoot PRP .....	225
Port Mirroring .....	225
Configure Port Mirroring in Device Manager .....	226
Port Security .....	227
Dynamic Secure MAC ID .....	227
Static Secure MAC ID .....	228
Security Violations .....	228
Configure Port Security via Device Manager .....	229
Configure Port Security via the Logix Designer Application ..	231
Port Thresholds .....	233

Incoming (storm control) .....	233
Outgoing (rate limiting) .....	234
Default Port Thresholds Configuration .....	234
Configure Port Thresholds via Device Manager .....	235
Configure Port Thresholds via the Logix Designer Application ..	236
Power over Ethernet (PoE).....	238
Powered Device Detection and Initial Power Allocation .....	239
Power Management Modes.....	240
Configure PoE Ports via Device Manager .....	243
Configure PoE via the Logix Designer Application .....	246
PROFINET .....	249
Configure PROFINET Traffic Forwarding.....	249
Configure a Stratix 5700 or ArmorStratix 5700 Switch for PROFINET Management.....	251
Verify the GSD File.....	254
Monitor and Maintain PROFINET.....	254
Resilient Ethernet Protocol (REP) .....	255
REP Open Segment.....	256
REP Ring Segment .....	257
Access Ring Topologies .....	257
Link Integrity .....	258
Configure REP via Device Manager .....	259
Routing, Layer 3 .....	260
Routing, Static and Connected .....	262
Reallocate Switch Memory for Routing via Device Manager ..	263
Enable and Configure Routing via Device Manager.....	264
Simple Network Management Protocol (SNMP) .....	265
Supported MIBs.....	266
Configure SNMP via Device Manager.....	267
Use SNMP Management Applications .....	268
Smartports.....	268
Custom Smartport Roles .....	269
Avoid Smartport Mismatches.....	269
Configure Smartports via Device Manager.....	270
Assign Smartports and VLANs via the Logix Designer Application	276
Spanning Tree Protocol (STP) .....	278
Configure STP via Device Manager .....	279
Configure STP via the Logix Designer Application.....	282
Virtual Local Area Networks (VLANs) .....	283
Management VLAN.....	284
Configure VLANs via Device Manager.....	284
Configure VLANs via the Logix Designer Application.....	284
VLAN 0 Priority Tagging.....	286
802.1Q Tagging.....	286
Native VLANs .....	286
VLAN 0 Priority Tagging and Priority Values.....	287
Configure VLAN 0 Priority Tagging .....	287

<b>Monitor the Switch</b>	<b>Chapter 4</b>	
	Switch Status via Device Manager .....	290
	Front Panel .....	291
	Switch Information .....	302
	Switch Health .....	303
	Port Utilization .....	304
	Switch Status via the Logix Designer Application .....	305
	Port Status .....	308
	System Log Messages .....	309
	Trends .....	310
	Port Statistics .....	312
	NAT Statistics .....	313
	Monitor NAT Statistics via Device Manager .....	313
	Monitor NAT Statistics via the Logix Designer Application ..	316
	NetFlow .....	319
	REP Status .....	320
	CIP Status .....	320
	DHCP Clients .....	322
	DLR Status .....	323
	Monitor DLR Status via Device Manager .....	323
	Monitor DLR Status via the Logix Designer Application .....	325
	PRP Status .....	327
	STP Status .....	329
	Port Diagnostics .....	331
	Neighbors .....	334
	Cable Diagnostics .....	335
	Diagnose Cables via Device Manager .....	335
	Diagnose Cables via the Logix Designer Application .....	336
<b>Troubleshoot the Switch</b>	<b>Chapter 5</b>	
	Troubleshoot the Installation .....	338
	Switch POST Results .....	338
	POST Results with a Terminal .....	338
	Bad or Damaged Cable .....	339
	Ethernet and Fiber Cables .....	339
	Link Status .....	340
	SFP Module Issues .....	340
	Port and Interface Settings .....	340
	Verify Boot Fast .....	341
	Troubleshoot IP Addresses .....	341
	Troubleshoot Device Manager .....	341
	Troubleshoot Switch Performance .....	342
	Restart or Reset the Switch .....	343
	Restart or Reset the Switch from Device Manager .....	343
	Reset the Switch via the Express Setup Button .....	344
	Restart the Switch from the Logix Designer Application .....	344

Troubleshoot a Firmware Update..... 344  
 Collect System and Configuration Information for Technical Support 345

**Data Types**

**Appendix A**

Stratix 5400 Data Types ..... 348  
     8-port Switches..... 348  
     12-port Switches ..... 350  
     12-port Gigabit Switches ..... 352  
     16-port Switches ..... 354  
     16-port Gigabit Switches ..... 357  
     20-port Switches ..... 360  
     20-port Gigabit Switches ..... 363  
 Stratix 5410 Data Types ..... 367  
 Stratix 5700 and ArmorStratix 5700 Data Types..... 372  
     6-port Gb Switches ..... 372  
     6-port Switches..... 373  
     8-port Switches..... 375  
     10-port Gb Switches ..... 376  
     10-port Switches ..... 378  
     16-port Switches ..... 380  
     20-port Gb Switches ..... 383  
     18-port Gb Switches ..... 385  
     20-port Gb Switches ..... 389  
     20-port Switches ..... 392  
     24-port Switches ..... 395  
 Stratix 8000 and 8300 Data Types ..... 399

**Port Assignments for CIP Data**

**Appendix B**

Stratix 5400 Port Assignments ..... 406  
 Stratix 5410 Port Assignments ..... 408  
 Stratix 5700 Port Assignments ..... 409  
 ArmorStratix 5700 Port Assignments ..... 410  
 Stratix 8000 and 8300 Port Assignments ..... 411

**Port Numbering**

**Appendix C**

Stratix 5400 Port Numbering ..... 414  
 Stratix 5410 Port Numbering ..... 422  
 Stratix 5700 Port Numbering ..... 423  
 ArmorStratix 5700 Port Numbering..... 430  
 Stratix 8000 and 8300 Port Numbering ..... 433



<b>Cables and Connectors</b>	<b>Appendix D</b>
	Stratix 5410 Cables and Connectors ..... 435
	10/100/1000 Ports ..... 435
	Connect to 10BASE-T- and 100BASE-TX-Compatible Devices 436
	Console Ports ..... 438
	Alarm Port..... 440
	Ethernet, PoE Port Cable Specifications ..... 440
	Stratix 5400 and 5700 Cables and Connectors ..... 441
	10/100 and 10/100/1000 Ports..... 441
	Connect to 10BASE-T- and 100BASE-TX-Compatible Devices 442
	Dual-purpose Ports (combo ports) ..... 443
	Console Ports ..... 444
	Alarm Ports ..... 446
	PoE Port Cable Specifications ..... 446
	ArmorStratix 5700 Cables and Connectors..... 447
	10/100 Ports ..... 447
	100/1000 Ports ..... 447
	Connect to 10BASE-T- and 100BASE-TX-Compatible Devices 448
	Console Port ..... 450
	Alarm Ports ..... 451
	PoE Port Cable Specifications ..... 452
	Stratix 8000/8300 Cables and Connectors ..... 452
	10/100 and 10/100/1000 Ports..... 452
	Connect to 10BASE-T- and 100BASE-TX-compatible Devices. 453
	100Base-FX Ports ..... 455
	SFP Transceiver Ports..... 455
	Dual-purpose Ports ..... 455
	Console Port ..... 456
	PoE Port Cable Specifications ..... 457
	<b>Index ..... 459</b>

**Notes:**

This publication describes how to set up, configure, and troubleshoot Stratix switches.

This manual assumes that you understand the following:

- Local area network (LAN) switch fundamentals
- Concepts and terminology of the Ethernet protocol and local area networking

## **Summary of Changes**

This manual contains new and updated information.

<b>Topic</b>	<b>Page</b>
Cisco Discovery Protocol (CDP) and Link Layer Discovery Protocol (LLDP) monitoring	16, 334
Auto sync changes for Stratix 5700 and ArmorStratix 5700 switches	68
Configure active and backup DHCP servers for ring devices	116
Multiple ring topologies for Device Level Ring (DLR)	117
Extended Flood option for IGMP snooping	160
Configure NetFlow	163
Configure Network Time Protocol (NTP) via the Logix Designer application	211
Enable PortFast Trunk option for Spanning Tree Protocol (STP)	281
Monitor NetFlow	319

## Additional Resources

These documents contain additional information concerning related products from Rockwell Automation.

Resource	Description
Stratix Ethernet Device Specifications Technical Data, publication <a href="#">1783-TD001</a>	Provides specifications for the switches and other devices.
Converged Plantwide Ethernet (CPwE) Design and Implementation Guide, publication <a href="#">ENET-TD001</a>	Represents a collaborative development effort from Rockwell Automation and Cisco Systems. The design guide is built on, and adds to, design guidelines from the Cisco Ethernet-to-the-Factory (EttF) solution and the Rockwell Automation Integrated Architecture™. The design guide focuses on the manufacturing industry.
Stratix 5400 Ethernet Managed Switches Installation Instructions, publication <a href="#">1783-IN014</a>	Describes how to install the switches.
Stratix 5410 Ethernet Managed Switches and Power Supply Installation Instructions, publication <a href="#">1783-IN015</a>	
Stratix 5700 Ethernet Managed Switches Installation Instructions, publication <a href="#">1783-IN016</a>	
ArmorStratix 5700 Ethernet Managed Switches Installation Instructions, publication <a href="#">1783-IN017</a>	
Stratix 8000 and 8300 Ethernet Managed Switches Installation Instructions, publication <a href="#">1783-IN012</a>	
Ethernet Design Considerations Reference Manual, publication <a href="#">ENET-RM002</a>	Describes how to implement a system based on the EtherNet/IP platform.
Device Manager web interface online help (provided with the switch)	Provides context-sensitive information about configuring and using the switch.
Industrial Automation Wiring and Grounding Guidelines, publication <a href="#">1770-4.1</a>	Provides general guidelines for installing a Rockwell Automation industrial system.
Product Certifications website, <a href="http://www.rockwellautomation.com/global/certification/overview.page">http://www.rockwellautomation.com/global/certification/overview.page</a>	Provides declarations of conformity, certificates, and other certification details.

You can view or download publications at <http://www.rockwellautomation.com/global/literature-library/overview.page>. To order paper copies of technical documentation, contact your local Allen-Bradley distributor or Rockwell Automation sales representative.

For information on additional software features or further configuration, see Cisco publications for Industrial Ethernet series switches at <http://www.Cisco.com>.

## About the Switches





Topic	Page
Stratix Managed Switches	14
Stratix 5700 Lite Versus Full Firmware Features	15
Software Features	16
Hardware Features	19
Memory Allocation	22

Stratix® managed switches provide a secure switching infrastructure for harsh environments. You can connect the switches to network devices such as servers, routers, and other switches. In industrial environments, you can connect Ethernet-enabled industrial communication devices, including programmable logic controllers (PLCs), human machine interfaces (HMIs), drives, sensors, and I/O.

Stratix switches contain an EtherNet/IP network interface. The EtherNet/IP network is an industrial automation network specification from the Open DeviceNet Vendor Association (ODVA). The network uses the Common Industrial Protocol (CIP) for its application layer and TCP/UDP/IP for its transport and network layers. This interface is accessible via any of the Ethernet ports by using the IP address of the switch.

## Stratix Managed Switches

The following table describes the Stratix managed switches.

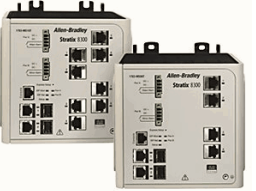
Switch Family	Description
<p>Stratix 5400 switches</p> 	<p>Layer 2 and Layer 3 scalable managed switches. Available in 8...20 port versions, including all Gigabit port versions.</p>
<p>Stratix 5410 switches</p> 	<p>Layer 2 and Layer 3 scalable managed switches. Available in 28-port versions.</p>
<p>Stratix 5700 switches</p> 	<p>Layer 2 scalable managed switches. Available in 6...20 port versions.</p>
<p>ArmorStratix™ 5700 switches</p> 	<p>Layer 2 managed switches with IP67-rating for protection in extreme conditions. Available in 8...24 port versions.</p>
<p>Stratix 8000 switches</p> 	<p>Layer 2 modular managed switches available with copper, fiber, SFP, and Power over Ethernet (PoE) expansion modules. Available in 6...26 port versions.</p>
<p>Stratix 8300 switches</p> 	<p>Layer 3 modular managed switches available with copper, fiber, SFP, and Power over Ethernet (PoE) expansion modules. Available in 6...26 port versions.</p>

## Stratix 5700 Lite Versus Full Firmware Features

The following table lists the features available for Stratix 5700 Full versus Lite firmware. All Stratix 8000 and ArmorStratix 5700 switches have Full firmware. To determine the firmware type available for specific catalog numbers, see the Stratix 5700 switch descriptions in [Table 179 on page 423](#).

Feature	Lite Firmware	Full Firmware
CIP Sync (IEEE 1588)		Separate option
Resilient Ethernet Protocol (REP)	•	•
FlexLinks		•
Quality of Service (QoS)		•
Spanning Tree Protocol (STP), Rapid Spanning Tree Protocol (RSTP), MST (instances)	64	128
Internet Group Management Protocol (IGMP) Snooping with querier	•	•
Virtual local area networks (VLANs) with trunking	64	255
VLAN Trunk Protocol (VTP)	VTP versions 1 and 2	VTP versions 1, 2, and 3
EtherChannel (link aggregation)		•
Port Threshold (Storm control and traffic shaping)		•
IPv6 support		•
Access Control Lists (ACL)		•
Routing, static and connected		•
CIP port control and fault detection	•	•
MAC ID Port security		•
IEEE 802.1x security		•
TACACS+, RADIUS authentication	•	•
Encryption (SSH, SNMPv3, https)	Separate IOS firmware available as a separate item	
Port mirroring	•	•
Syslog	•	•
Broken wire detection	•	•
Duplicate IP address detection	•	•
Simple Network Management Protocol (SNMP)	•	•
Smartports	•	•
Dynamic Host Configuration Protocol (DHCP) per port	•	•
Command-line interface (CLI)	•	•
Compatible with Cisco tools: Cisco Network Assistant (CNA); CiscoWorks	•	•
EtherNet/IP (CIP) interface	•	•
Device Level Ring (DLR)	Available on specific models that are listed on <a href="#">page 106</a>	

## Software Features

Switch software features can be configured via Device Manager, the Logix Designer application, or both:

- See [Configuration via Device Manager on page 47](#)
- See [Configuration via the Studio 5000 Environment on page 53](#)

All features can be configured via the command-line interface (CLI).

**Table 1 - Software Features**

Feature	Switches	Device Manager	Logix Designer
Access Control Lists (ACLs)	All	•	—
Alarms	All	•	—
Cisco Discovery Protocol (CDP) and Link Layer Discovery Protocol (LLDP) neighbor monitoring	Stratix 5400 switches Stratix 5410 switches Stratix 5700 switches ArmorStratix 5700 switches Stratix 8000 switches	•	
CIP Sync Time Synchronization/ Precision Time Protocol (PTP)	All Stratix 5400 switches All Stratix 5410 switches Stratix 5700 switches: 1783-BMS10CGN, 1783-BMS10CGP, 1783-BMS12T4E2CGNK, 1783-BMS12T4E2CGP, 1783-BMS20CGN, 1783-BMS20CGP, 1783-BMS20CGPK ArmorStratix 5700 switches: 1783-ZMS4T4E2TGP, 1783-ZMS8T8E2TGP, 1783-ZMS4T4E2TGN, 1783-ZMS8T8E2TGN All Stratix 8000 and 8300 switch base units (PTP traffic can be only forwarded through expansion modules)	•	•
Device Level Ring (DLR) topology	All Stratix 5400 switches Stratix 5700 switches: 1783-BMS10CGP, 1783-BMS10CGN, 1783-BMS12T4E2CGL, 1783-BMS12T4E2CGP, 1783-BMS12T4E2CGNK, 1783-BMS20CL, 1783-BMS20CA, 1783-BMS20CGL, 1783-BMS20CGP, 1783-BMS20CGN, 1783-BMS20CGPK ArmorStratix 5700 switches: 1783-ZMS4E4T2GP, 1783-ZMS8E8T2GP, 1783-ZMS8E8T2GN, 1783-ZMS8E8T2GN	•	•
Dynamic Host Configuration Protocol (DHCP) Persistence	All	•	•
DHCP for ring devices	Stratix 5400 switches Stratix 5700 switches ArmorStratix 5700 switches	•	•
Enhanced Interior Gateway Routing Protocol (EIGRP)	Stratix 5400 switches with Layer 3 firmware Stratix 5410 switches with Layer 3 firmware Stratix 8300 base units	•	—
EtherChannels	All	•	—
Global Navigation Satellite System (GNSS)	Stratix 5410 series B switches with IOS release 15.2(6)E0a and later	—	—
Maximum transmission unit (MTU)	All	•	—
Motion prioritized QoS macros	Stratix 5400 switches Stratix 5410 switches Stratix 5700 switches with Full firmware ArmorStratix 5700 switches	•	—
Horizontal stacking	Stratix 5410 switches: 1783-IMS28NAC, 1783-IMS28RAC, 1783-IMS28NDC, 1783-IMS28RDC	—	—
High-availability Seamless Redundancy (HSR)	Stratix 5400 switches	—	—
Internet Group Management Protocol (IGMP) Snooping with Querier	All	•	—



Table 1 - Software Features (Continued)

Feature	Switches	Device Manager	Logix Designer
Multimode Express Setup	Stratix 5400 switches Stratix 5410 switches Stratix 5700 switches ArmorStratix 5700 switches Stratix 8000 switches Stratix 8300 switches	•	•
NetFlow	Stratix 5400 switches Stratix 5410 switches	—	—
Network address translation (NAT)	All Stratix 5400 switches All Stratix 5410 switches Stratix 5700 switches: 1783-BMS10CGN, 1783-BMS20CGN, 1783-BMS12T4E2CGNK ArmorStratix 5700 switches: 1783-ZMS4T4E2TGN, 1783-ZMS8T8E2TGN	•	•
Network Time Protocol	Stratix 5400 switches Stratix 5410 switches Stratix 5700 switches ArmorStratix 5700 switches Stratix 8000 switches	•	•
Parallel Redundancy Protocol (PRP)	Stratix 5400 switches Stratix 5410 switches	•	—
Port mirroring	All	•	—
Port security	All	•	•
Port thresholds	All	•	•
Power over Ethernet (PoE)	Stratix 5400 switches: 1783-HMS4T4E4CGN, 1783-HMS4S8E4CGN, 1783-HMS4EG8CGN, 1783-HMS8TG8EG4CGN, 1783-HMS4SG8EG4CGN, 1783-HMS4EG8CGR, 1783-HMS8TG8EG4CGR, 1783-HMS4SG8EG4CGR All Stratix 5410 switches Stratix 5700 switches: 1783-BMS12T4E2CGNK, 1783-BMS12T4E2CGP, 1783-BMS12T4E2CGL ArmorStratix 5700 switches: 1783-ZMS4T4E2TGP, 1783-ZMS8T8E2TGP, 1783-ZMS4T4E2TGN, 1783-ZMS8T8E2TGN Stratix 8000 and 8300 expansion modules: 1783-MX04E, 1783-MX04T04E	•	•
PROFINET	All switches support PROFINET traffic forwarding and VLAN 0 priority tagging Stratix 5700 and ArmorStratix switches support PROFINET management via General Station Description (GSD) files	—	—
Resilient Ethernet Protocol (REP)	All	•	—
Routing, Layer 3	Stratix 5400 switches with Layer 3 firmware Stratix 5410 switches with Layer 3 firmware Stratix 8300 base units		
Routing, static and connected	Stratix 5400 switches Stratix 5410 switches Stratix 5700 switches with Full firmware ArmorStratix 5700 switches	•	—
Open Shortest Path First (OSPF) Gateway Routing Protocol	Stratix 5400 switches with Layer 3 firmware Stratix 5410 switches with Layer 3 firmware Stratix 8300 base units	•	—
Simple Network Management Protocol (SNMP)	All	•	—
Smartports	All	•	•

**Table 1 - Software Features (Continued)**

<b>Feature</b>	<b>Switches</b>	<b>Device Manager</b>	<b>Logix Designer</b>
Spanning Tree Protocol (STP)	All	•	•
Virtual local area networks (VLANs)	All	•	•
VLAN 0 priority tagging	All	•	—

## Hardware Features

See the following for a description of hardware features:

- For Stratix 5400, Stratix 5700, ArmorStratix 5700, and Stratix 8000/8300 switches, see [Table 2 on page 19](#).
- For Stratix 5410 switches, see [Table 3 on page 20](#).
- For supported SFP modules, see the Stratix Ethernet Device Specifications Technical Data, publication [1783-TD001](#).

**Table 2 - Hardware Features for Stratix 5400, Stratix 5700, ArmorStratix 5700, and Stratix 8000/8300 Switches**

Feature	Description
Power and relay connectors	<p>You connect the power and alarm signals to the front panel of a switch:</p> <ul style="list-style-type: none"> <li>• Stratix 5400 switches—One connector provides primary DC power. A second connector provides secondary power. The two connectors are physically identical. You can activate alarms for environmental, power supply, and port status alarm conditions. You can configure an alarm to indicate open or closed contacts. There is no separate power connector for PoE.</li> <li>• Stratix 5700 switches—One connector provides primary DC power and a second connector provides secondary power. The two connectors are physically identical. You can activate alarms for environmental, power supply, and port status alarm conditions. You can configure an alarm to indicate open or closed contacts. A separate power connector is required for PoE.</li> <li>• ArmorStratix 5700 switches—One cable provides DC power from one or dual power sources. Relay connectors and alarm relays are available for only catalog numbers 1783-ZMS4T4E2TGP, 1783-ZMS8T8E2TGP, 1783-ZMS4T4E2TGN, and 1783-ZMS8T8E2TGN. There is no separate power connector for PoE.</li> <li>• Stratix 8000/8300 switches—One connector provides primary DC power (supply A) and the major alarm signal. A second connector provides secondary power (supply B) and the minor alarm signal. The two connectors are physically identical and are in the upper-left side of the front panel.</li> </ul> <p>The power and relay connectors also provide an interface for two independent alarm relays: the major alarm and the minor alarm. You can activate the relays for environmental, power supply, and port status alarm conditions. You can configure an alarm to indicate open or closed contacts. The relay itself is normally open, so under power failure conditions, the contacts are open. From the Command-line interface (CLI), you can associate any alarm condition with one alarm relay or with both relays.</p> <p>When dual power sources are operational for any of the switches, the switch draws power from the DC source with the higher voltage. If one of the two power sources fail, the other continues to power the switch.</p>
Console port	<p>To configure, monitor, and manage a switch, you can connect a switch to a computer through the console port:</p> <ul style="list-style-type: none"> <li>• Stratix 5400 and Stratix 5700 switches—Connect to the console port with an RJ45-to-DB-9 adapter cable or a mini USB cable. The mini USB driver is available in the firmware download section at <a href="http://www.rockwellautomation.com">http://www.rockwellautomation.com</a>.</li> <li>• ArmorStratix 5700 switches— Connect to the console port with an M12-to-DB-9 cable. See <a href="#">page 450</a>.</li> <li>• Stratix 8000/8300 switches—Connect to the console port with an RJ45-to-DB-9 adapter cable.</li> </ul>
Dual-purpose (combo) uplink ports	<p>You can configure the dual-purpose uplink ports available on some models for RJ45 (copper) or SFP (fiber) media types. Only one of these connections in each of the dual-purpose ports can be active at a time. If both ports are connected, the SFP module port has priority.</p> <p>You can set the copper RJ45 ports to operate at 10 Mbps, 100 Mbps, or 1000 Mbps, full-duplex, or half-duplex. You can configure them as fixed 10 Mbps, 100 Mbps, or 1000 Mbps (Gigabit) Ethernet ports and can configure the duplex setting. 1000 Mbps is not supported on all modules with combo ports.</p> <p>You can use approved Gigabit (or 100 Mbps) Ethernet SFP modules to establish fiber-optic connections to other devices. These transceiver modules are field-replaceable and provide the uplink interfaces when inserted into an SFP module slot. You use fiber-optic cables with LC connectors to connect to a fiber-optic SFP module. These ports operate only in full-duplex.</p>
10/100 copper ports	<p>You can set the 10/100 copper ports to operate at 10 Mbps or 100 Mbps, full-duplex, or half-duplex. You can also set these ports for speed and duplex autonegotiation in compliance with IEEE 802.3-2002. The default setting is autonegotiate.</p> <p>When set for autonegotiation, the port senses the speed and duplex settings of the attached device. If the connected device also supports autonegotiation, the switch port negotiates the connection with the fastest line speed that both devices support. The port also negotiates full-duplex transmission if the attached device supports it. The port then configures itself accordingly. In all cases, the attached device must be within 100 m (328 ft) of the switch.</p>

**Table 2 - Hardware Features for Stratix 5400, Stratix 5700, ArmorStratix 5700, and Stratix 8000/8300 Switches (Continued)**

Feature	Description
100/1000 SFP ports	The SFP ports on some models provide full-duplex, 100- or 1000-Mbps connectivity. ArmorStratix 5700 switches and Stratix 8000/8300 base switches do not have SFP ports.
PoE/PoE+ ports	The PoE ports available on some switches and expansion modules can be configured for PoE (IEEE 802.3af) or PoE+ (IEEE 802.3at Type 2). You can configure PoE /PoE+ ports in any combination of PoE and PoE+. Stratix 5400 and ArmorStratix 5700 switches use one power connection for both basic power supply and PoE power supply. Stratix 5700 switches and Stratix 8000/8300 expansion modules require a dedicated power supply for PoE.
Auto-MDIX	When connecting the switch to workstations, servers, and routers, straight-through cables are typically used. However, the automatic medium-dependent interface crossover (auto-MDIX) feature of the switch is enabled by default and reconfigures the ports to use either a straight-through or crossover cable type. The auto-MDIX feature is enabled by default. When the auto-MDIX feature is enabled, the switch detects the required cable type (straight-through or crossover) for copper Ethernet connections and configures the interfaces accordingly. You can use the Command-line interface (CLI) to disable the auto-MDIX feature. See the online help for more information.

**Table 3 - Hardware Features for Stratix 5410 Switches**

Feature	Description
Dual power supply modules	Depending on the switch model, one AC or DC power supply module comes pre-installed in the switch. You can order an optional second power supply of any voltage type to provide redundancy and additional power for PoE devices: <ul style="list-style-type: none"> <li>One power supply provides 60 W for PoE/PoE+.</li> <li>Two power supplies provide 185 W for PoE/PoE+.</li> </ul> The power-input terminal on the cable-side of the switch provides connections for high-voltage AC, high-voltage DC, or low-voltage DC power for the two power supplies. When dual power sources are operational, the switch draws power from the power source with the higher voltage. If one of the two power sources fail, the other continues to power the switch.
Alarm relay connector	The front panel alarm port uses an RJ45 connector. You can connect four alarm inputs and one alarm output for environmental, power supply, and port status conditions. You can configure an alarm to indicate open or closed contacts.
Console port	To configure, monitor, and manage a switch, you can connect a switch to a computer through the console port: Connect to the console port with an RJ45-to-DB-9 adapter cable or a mini USB cable. The mini USB driver is available in the firmware download section at <a href="http://www.rockwellautomation.com">http://www.rockwellautomation.com</a> .
10/100/1000 Ethernet, PoE/PoE+ ports	You can set the 10/100/1000 ports to operate at 10 Mbps, 100 Mbps, or 1000 Mbps, full-duplex, or half-duplex. You can also set these ports for speed and duplex autonegotiation in compliance with IEEE 802.3-2002. The default setting is autonegotiate. When set for autonegotiation, the port senses the speed and duplex settings of the attached device. If the connected device also supports autonegotiation, the switch port negotiates the connection with the fastest line speed that both devices support. The port also negotiates full-duplex transmission if the attached device supports it. The port then configures itself accordingly. In all cases, the attached device must be within 100 m (328 ft) of the switch. The ports can also be configured for PoE (IEEE 802.3af) or PoE+ (IEEE 802.3at Type 2): <ul style="list-style-type: none"> <li>You can configure the ports in any combination of PoE and PoE+.</li> <li>A second power supply is required to support PoE+.</li> <li>The ports deliver up to 15.4 W of PoE and 30 W of PoE+.</li> </ul> The ports can be designated as high or low priority PoE/PoE+ ports. When two power-supply modules are installed, the system has enough power to support all ports as PoE/PoE+ ports. If one of the power-supply modules fails, the power to the low priority ports is dropped, while power to the high priority ports remains uninterrupted. For more information, see pages <a href="#">238</a> , <a href="#">245</a> , and <a href="#">248</a> . The ports use RJ45 connectors with Ethernet pinouts. The maximum cable length is 100 m (328 ft).
100/1000 SFP ports	100/1000 SFP ports provide full-duplex, 100-Mbps or 1-Gbps connectivity.
1000 SFP ports	1000 SFP ports provide only 1-Gbps connectivity. These uplink ports are available on catalog numbers 1783-IMS28GNDC, 1783-IMS28GNAC, 1783-IMS28GRDC, and 1783-IMS28GRAC.
1000/10 Gigabit SFP/SFP+ ports	1000/10 Gigabit SFP/SFP+ ports provide full-duplex, 1-Gbps or 10-Gbps connectivity. The port speed is 1 Gbps when a 1000BASE SFP module is installed and 10 Gbps when a 10GBASE SFP+ module is installed.
Auto-MDIX	When connecting the switch to workstations, servers, and routers, straight-through cables are typically used. However, the automatic medium-dependent interface crossover (auto-MDIX) feature of the switch is enabled by default and reconfigures the ports to use either a straight-through or crossover cable type. The auto-MDIX feature is enabled by default. When the auto-MDIX feature is enabled, the switch detects the required cable type (straight-through or crossover) for copper Ethernet connections and configures the interfaces accordingly. You can use the Command-line interface (CLI) to disable the auto-MDIX feature. See the online help for more information.

**Table 3 - Hardware Features for Stratix 5410 Switches (Continued)**

<b>Feature</b>	<b>Description</b>
Global navigation satellite system (GNSS)	Requires Stratix 5410 series B switches with IOS release 15.2(6)E0a and later. Stratix 5410 series B switches have a built-in GNSS receiver that enables the switch to determine its own location and get an accurate time from a satellite constellation. The switch can then become the Grandmaster clock for time distribution in the network. For more information about GNSS, see <a href="#">page 154</a> . The GPS status indicator on the front panel of the switch provides GNSS status as described on <a href="#">page 298</a> .
Inter-range instrumentation group (IRIG) time codes	Not available in the current release.
Time of day (ToD) synchronization	Not available in the current release.

## Memory Allocation

You can use Switch Database Management (SDM) templates to configure system resources in the switch to optimize specific features. You can select a template to provide maximum system usage for some functions. For example, use the default template to balance resources, and use the access template to obtain maximum ACL usage. To allocate hardware resources for different usages, the switch SDM templates prioritize system resources to optimize support for certain features.

### Stratix 5400 Templates

The selected template optimizes the resources in the switch to support features for eight routed interfaces and 1024 VLANs.

Layer 2 firmware models have the IPv4 Default template.

Layer 3 firmware models have these templates:

- IPv4 Default
- Dual IPv4/IPv6 Default
- IPv4 Routing
- Dual IPv4/IPv6 Routing

**Table 4 - Stratix 5400 Templates**

Feature	Memory Allocation			
	IPv4 Default	Dual IPv4/IPv6 Default	IPv4 Routing	Dual IPv4/IPv6 Routing
Unicast MAC IDs	16K	16K	16K	16K
IPv4 IGMP groups + multicast routes	1K	1K	1K	1K
IPv4 unicast routes	18K	5.25K	24K	6K
IPv6 multicast groups	0	1K	0	1K
IPv6 unicast groups	0	5.25K	0	7K
Directly connected IPv4 hosts	16K	4K	16K	4K
Directly connected IPv6 addresses	0	4K	0	4K
Indirect IPv4 routes	2K	1.25K	8K	2K
Indirect IPv6 unicast routes	0	5.25K	0	3K
IPv4 policy-based routing aces	0.125K	0.25K	0.375K	0.125K
IPv4/MAC QoS aces	1.875K	0.5K	0.5K	0.5K
IPv4/MAC security aces	1.875K	0.75K	1K	0.625K
IPv6 policy-based routing aces	0	0.25K	0	0.125K
IPv6 QoS aces	0	0.375K	0	0.125K
IPv6 security aces	0	0.375K	0	0.125K

## Stratix 5410 Templates

The selected template optimizes the resources in the switch to support features for eight routed interfaces and 1024 VLANs.

Layer 2 firmware models have the Default template.

**Table 5 - Stratix 5410 Layer 2 Firmware Model Template**

Feature	Memory Allocation
Unicast MAC IDs	16K
IPv4 IGMP groups or IPv6 groups	1K IPv4
Direct routes	1K IPv4
Indirect routes	0.25K IPv4
IPv4 or IPv6 policy-based routing ACEs	0
IPv4 or IPv6 QoS ACEs	1K (IPv4 QoS)
IPv4 or IPv6 port or MAC security ACEs	1K (IPv4 ACL)

Layer 3 firmware models have these templates:

- Default
- Dual-default
- IPv4 Routing
- Dual-routing

**Table 6 - Stratix 5410 Layer 3 Firmware Model Templates**

Feature	Memory Allocation			
	Default	Dual-default	IPv4 Routing	Dual-routing
Unicast MAC IDs	16K	16K	16K	16K
IPv4 IGMP groups or IPv6 groups	1K IPv4	1K IPv4 1K IPv6	1K IPv4	1K IPv4 1K IPv6
Direct routes	16K IPv4	4K IPv4 4K IPv6	16K IPv4	4K IPv4 4K IPv6
Indirect routes	2K IPv4	1.25K IPv4 1.25K IPv6	8K IPv4	2K IPv4 3K IPv6
IPv4 or IPv6 policy-based routing ACEs	0.125K (IPv4 PBR)	0.25K (IPv4 PBR) 0.25K (IPv6 PBR)	0.5K (IPv4 PBR)	0.125K (IPv4 PBR) 0.125K (IPv6 PBR)
IPv4 or IPv6 QoS ACEs	1.75K (IPv4 QoS)	0.5K (IPv4 QoS) 0.5K (IPv6 QoS)	0.5K (IPv4 QoS)	0.5K (IPv4 QoS) 0.125K (IPv6 QoS)
IPv4 or IPv6 port or MAC security ACEs	1.75K (IPv4 ACL)	0.75K (IPv4 ACL) 0.5K (IPv6 ACL)	1K (IPv4 ACL)	0.625K (IPv4 ACL) 0.125K (IPv6 ACL)

## Stratix 5700 and ArmorStratix 5700 Templates

The following SDM templates are available:

- Default
- Lanbase Routing
- Dual IPv4 and IPv6

If you enable static routing, or if you have more than 180 IGMP groups or multicast routes, consider using the routing template.

If you use IPv6, consider using the Dual IPv4 and IPv6 template.

You can select SDM templates for IP version 4 (IPv4) to optimize these features.

**Table 7 - Stratix 5700 and ArmorStratix 5700 Templates**

Feature	Memory Allocation		
	Default	Lanbase Routing	Dual IPv4 and IPv6
Unicast MAC IDs	8K	4K	7.5K
IPv4 IGMP groups + multicast routes	0.25K	0.25K	0.25K
IPv4 unicast routes	0	4.25K	0
IPv6 multicast groups	0	0	0.375K
Directly connected IPv4 hosts	0	4K	
Directly connected IPv6 addresses	0	0	0
Indirect IPv4 routes	0	0.25K	
Indirect IPv6 routes	0	0	0
IPv4 policy-based routing aces	0	0	
IPv4/MAC QoS aces	0.375K	0.375K	0.375K
IPv4/MAC security aces	0.375K	0.375K	0.375K
IPv6 policy-based routing aces	0	0	0
IPv6 QoS aces	0	0	0
IPv6 security aces	0	0	0.125K



## Stratix 8000 and 8300 Templates

The following SDM templates are recommended:

- Default
- Lanbase Routing

For static and connected routing, or if you have more than 180 IGMP groups or multicast routes, you can use the Lanbase Routing template. Other SDM templates are available, but are not covered in detail.

You can use SDM templates for IP Version 4 (IPv4) to optimize these features.

**Table 8 - Stratix 8000 and ArmorStratix 8300 Templates**

Feature	Memory Allocation	
	Default	Lanbase Routing
Unicast MAC IDs	8K	4K
IPv4 IGMP groups + multicast routes	0.25K	0.25K
IPv4 unicast routes	0	0.75
Directly connected IPv4 hosts	0	0.75
Indirect IPv4 routes	0	16
IPv4 policy-based routing ACEs	0	0
IPv4/MAC QoS ACEs	0.375K	0.375K
IPv4/MAC security ACEs	0.375K	0.375K



## Get Started

<b>Topic</b>	<b>Page</b>
Express Setup Overview	28
Multi-mode Express Setup	32
Single-mode Express Setup	36
Configure Network Settings via Device Manager	37
Configure Network Settings via the Logix Designer Application	42
Default Global Macro	44
Linux-based Software and Network Who Support	45
Configuration via Device Manager	47
Configuration via the Studio 5000 Environment	53
User Administration via Device Manager	62
Configuration Files	63
Secure Digital (SD) Card	65
CompactFlash Memory Card	71
Firmware Updates	71
Cisco Network Assistant	72
Command-line Interface	73

## Express Setup Overview

When you first install the switch, use Express Setup to perform these initial setup tasks:

- Assign the switch an initial IP address. You can then access the switch through the IP address for more configuration.
- Run the global macro to set initial configuration parameters as described on [page 44](#).

## Express Setup Requirements

Multi-mode and single-mode versions of Express Setup are available depending on your switch and IOS release:

- With IOS release **15.2(4)EA3 or later**, all switches use multi-mode Express Setup as described on [page 32](#).
- With IOS release **15.2(4)EA or earlier**, all switches use single-mode Express Setup as described on [page 36](#).

Multi-mode Express Setup enables you to configure network settings in either Device Manager or the Studio 5000 Logix Designer® application. To configure network settings via the Logix Designer application, you must have the Add-on Profile (AOP) for Stratix® switches, **version 11.01.xx or later**.

You need this equipment to install the switch.

Component	Requirement
<b>Hardware</b>	
Processor	1 GHz or faster 32-bit (x86) or 64-bit (x64)
RAM	1 GB RAM (32-bit) or 2GB RAM (64-bit)
Hard disk space	16 GB (32-bit) or 20 GB (64-bit)
<b>Software</b>	
Operating system	Windows 7
Web browser	Latest version of Internet Explorer™ or Firefox with JavaScript enabled. Express Setup verifies the browser version when starting a session, and it does not require a plug-in.
Computer-to-switch connection (single-mode Express Setup or multi-mode Express Setup in Short Press mode)	Straight-through or crossover Category 5 Ethernet cable or (ArmorStratix™ 5700 switches) M12-to-RJ45 patchcord, such as Allen-Bradley® catalog number 1585D-M4TBJM-2

For 1783-BMS4S2SGL or 1783-BMS4S2SGA switches, you also need a Gigabit copper SFP module, such as Allen-Bradley catalog number 1783-SFP1GSX, or a Gigabit fiber-to-Ethernet media converter.

Before you begin, do the following:

- Single-mode Express Setup or multi-mode Express Setup in Short Press mode:
  - Disable other networks in your system.
  - Set your computer to determine its IP address automatically versus statically.
  - Disable static DNS servers.
- Disable any wireless interface on your computer.
- Disable browser proxy settings.
- Make sure at least one switch Ethernet port is available for Express Setup.

---

**IMPORTANT** For catalog numbers 1783-BMS4S2SGL and 1783-BMS4S2SGA, you must use port Gi1/1 for Express Setup.  
Do not use the console port for Express Setup.

---

- For Stratix 5700 or ArmorStratix 5700 switches, make sure that the SD card is **not** inserted.

## Express Setup Button

Use the Express Setup button on the physical switch to perform Express Setup. This Express Setup button is recessed behind the panel. To reach the button, use a small tool, such as a paper clip.



---

**WARNING:** When you press the Express Setup button while power is on, an electric arc can occur. This could cause an explosion in hazardous location installations.

---

Stratix 5400 Switch

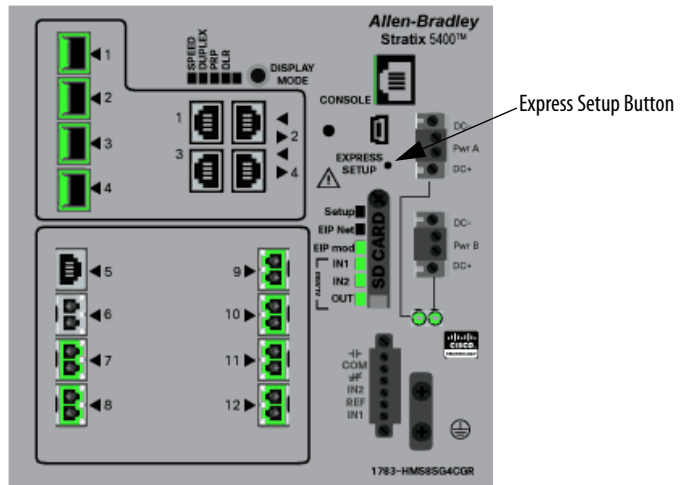

Stratix 5410 Switch

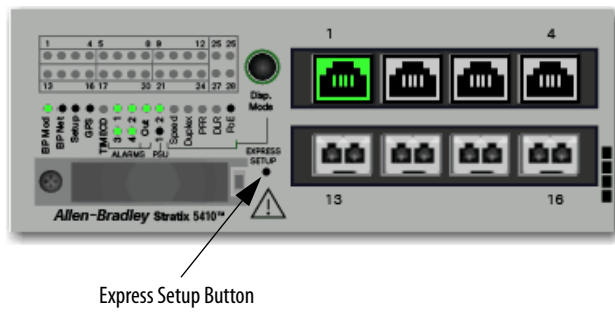

Stratix 5700 Switch

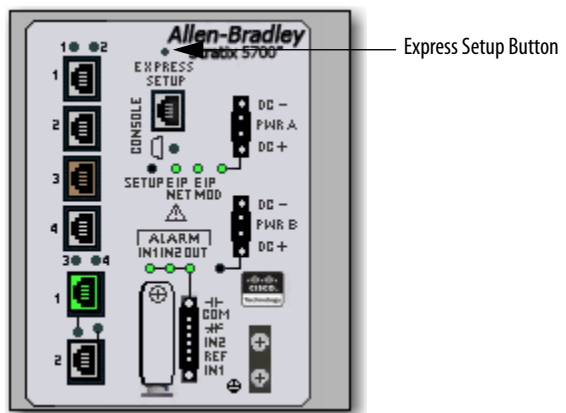

**ArmorStratix 5700 Switch**

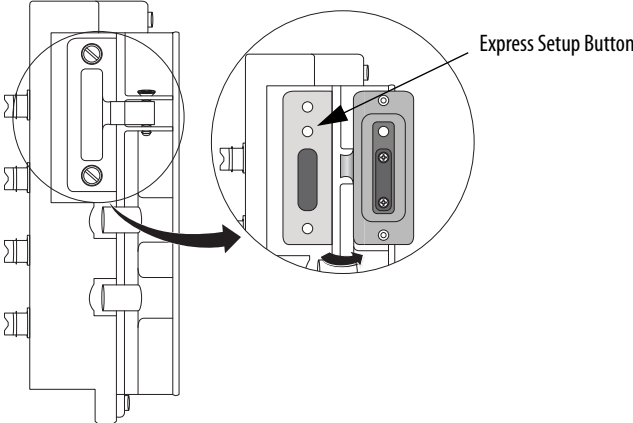

**Stratix 8000/8300 Switch**

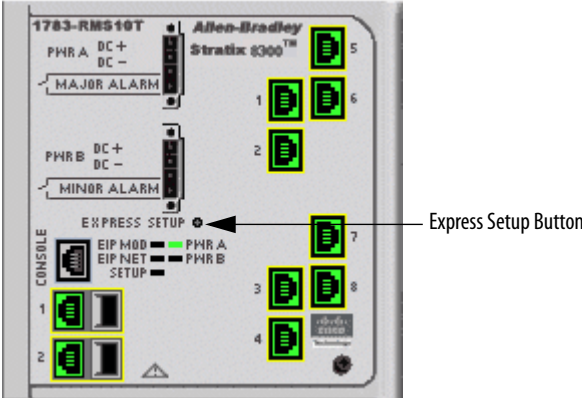

## Multi-mode Express Setup

Multi-mode Express Setup has three modes:

---

**IMPORTANT** The Studio 5000 Logix Designer® application supports only Medium-press mode.

---

- Short Press mode—You want to use Express Setup to enter the initial IP address of the switch. You can then configure additional network settings via Device Manager. To run Short Press mode, see [page 33](#).
- Medium Press mode—You want to use a DHCP server to assign the switch an IP address. You can then configure additional network settings via Device Manager or the Logix Designer application. To run Medium Press mode, see [page 34](#).
- Long Press mode—You want to reset the switch to use factory default settings. To run Long Press mode, see [page 35](#).

[Table 9](#) summarizes the function of each mode.

**Table 9 - Multi-mode Express Setup Modes**

Attribute	Short Press Mode	Medium Press Mode	Long Press Mode
Enable method	Press and hold the Express Setup button until the Setup status indicator flashes green during seconds 1...5, and then release.	Press and hold the Express Setup button until the Setup status indicator flashes red during seconds 6...10, and then release.	Press and hold the Express Setup button until the Setup status indicator flashes alternating green and red during seconds 16...20, and then release.
		Between seconds 11...15 and after 21 seconds, the Setup status indicator turns off. If you release the Express Setup button while the Setup status indicator is off, no Express Setup mode is enabled.	
Setup status indicator	Flashes green between seconds 1...5.	Flashes red between seconds 6...10.	Flashes green and red between seconds 16...20.
Function	<ul style="list-style-type: none"> <li>• The Express Setup management interface is selected.</li> <li>• The switch acts as a DHCP server on VLAN 1000 with an address of 169.254.0.1.</li> <li>• Once the DHCP session is successfully established, the switch assigns the computer an IP address of 169.254.0.2 on VLAN 1000.</li> <li>• The default login credentials are set to the following:                             <ul style="list-style-type: none"> <li>– User name: [no user name/blank]</li> <li>– Password: <b>switch</b></li> </ul> </li> <li>• Express Setup parameters are completed via Device Manager.</li> </ul>	<ul style="list-style-type: none"> <li>• A DHCP client request is sent out of all switch ports on VLAN 1.</li> <li>• VLAN 1 is configured with the IP address returned by DHCP.</li> <li>• The default login credentials are set to the following:                             <ul style="list-style-type: none"> <li>– User name: [no user name/blank]</li> <li>– Password: <b>switch</b></li> </ul> </li> <li>• CIP (Common Industrial Protocol) is enabled on VLAN 1 with the CIP Security password set to <b>switch</b>.</li> <li>• Express Setup parameters are completed via Device Manager or the Logix Designer application.</li> </ul>	<ul style="list-style-type: none"> <li>• All configuration settings (config.text, vlan.dat, and private-config.text files) in internal memory or on the SD card or CompactFlash card are reset to factory defaults.</li> <li>• The switch restarts with factory default settings.</li> </ul>



## Run Multi-mode Express Setup in Short Press Mode

Be aware of the following conditions that cause the switch to exit Short Press mode.

Condition	Status Indicator Behavior
A non-default configuration exists on the switch.	The Setup status indicator turns red for 10 seconds.
You do not connect to the Express Setup port within 2 minutes from when the port status indicator flashes green.	The unconnected port status indicator and the Setup status indicator turn off.
No DHCP request is received for 2 minutes from when you connect to the Express Setup port.	The Setup status indicator turns red for 10 seconds.
No browser session is started for 2 minutes after an IP address is assigned to the computer.	The unconnected port status indicator and the Setup status indicator turn off.
You disconnect your computer from the switch before the setup process is complete.	All temporary configurations that are applied by Express Setup, such as DHCP server, are removed.

To run multi-mode Express Setup in Short Press mode, follow these steps.

1. Apply power to the switch.

When the switch powers on, it begins its power-on sequence. The power-on sequence can take as many as 90 seconds to complete.

2. Make sure that the power-on sequence has completed by verifying that the EIP Mod and Setup status indicators are flashing green.

If the switch fails the power-on sequence, the EIP Mod status indicator turns red.

If you do not press the Express Setup button within 5 minutes after the power-on sequence is complete, the Setup status indicator turns off.

However, you can still run Express Setup after the Setup status indicator turns off.

3. Press and hold the Express Setup button until the Setup status indicator flashes green during seconds 1...4, and then release.

The switch selects a port to use for Express Setup.

4. Connect a Category 5 Ethernet cable from the flashing switch port to the Ethernet port on a computer.

or

For 1783-BMS4S2SGL or 1783-BMS4S2SGA switches, do one of the following:

- Insert a copper SFP module into the Gi1/1 port on the switch. Then connect a Category 5 Ethernet cable from the SFP module to the Ethernet port on the computer.
- Connect the Gi1/1 port on the switch to the Ethernet port on the computer by using a fiber-to-Ethernet media converter.

**IMPORTANT** Port Gi1/1 does not flash during setup, but must be used to connect 1783-BMS4S2SGL or 1783-BMS4S2SGA switches to a computer.

Once you connect the switch to the computer, the following occurs:

- The status indicator for the port connected to the computer changes from flashing green to solid green.
- The switch acts as a DHCP server on VLAN 1000 with an address of 169.254.0.1.

**IMPORTANT** The IP address of the switch for multi-mode Express Setup is different than the IP address for single-mode Express Setup.

- The switch assigns the computer an IP address of 169.254.0.2 on VLAN 1000.
- The Setup status indicator changes from flashing green to solid green.

5. Proceed to [Configure Network Settings via Device Manager on page 37](#).

## Run Multi-mode Express Setup in Medium Press Mode

Be aware of the following conditions that cause the switch to exit Medium Press mode.

Condition	Status Indicator Behavior
A non-default configuration exists on the switch.	The Setup status indicator turns red for 10 seconds.
No DHCP response is received for 10 minutes from when the switch broadcast the request.	

**IMPORTANT** Before you begin, make sure that your system has a DHCP server configured to assign the switch an IP address. You can configure a switch to be a DHCP server as described on [page 131](#).

To run multi-mode Express Setup in Medium Press mode, follow these steps.

1. Apply power to the switch.  
When the switch powers on, it begins its power-on sequence. The power-on sequence can take as many as 90 seconds to complete.
2. Make sure that the power-on sequence has completed by verifying that the EIP Mod and Setup status indicators are flashing green:
  - If the switch fails the sequence, the EIP Mod status indicator turns red.
  - If you do not press the Express Setup button within 5 minutes after the sequence completes, the Setup status indicator turns off.
3. Press and hold the Express Setup button until the Setup status indicator flashes red during seconds 6...10, and then release.

---

**IMPORTANT** You must complete the switch setup within 10 minutes of releasing the Express Setup button. Otherwise, the switch exits Express Setup.

---

The following occurs:

- The Setup status indicator flashes green during seconds 1...5, and then red during seconds 6...10.
  - The switch broadcasts a DHCP request out of all ports on VLAN 1.
  - VLAN 1 is configured with the IP address returned by the DHCP server.
  - The default login credentials are set to the following:
    - User name: [no user name/blank]
    - Password: **switch**
  - CIP is enabled on VLAN 1 with CIP Security password set to **switch**.
4. Configure network settings:
    - To complete the configuration via Device Manager, see [page 37](#).
    - To complete the configuration via the Logix Designer application, see [page 42](#).

## Run Multi-mode Express Setup in Long Press Mode

---

**IMPORTANT** Long Press mode overwrites all existing configuration files in internal or external memory and resets the switch to use factory default settings.

---

Press and hold the Express Setup button until the Setup status indicator flashes alternating green and red during seconds 16...20, and then release.

Upon release of the Express Setup button, the switch restarts with factory default settings.

## Single-mode Express Setup

To run single-mode Express Setup, follow these steps.

1. Make sure that at least one switch Ethernet port is available for Express Setup.

2. Apply power to the switch.

When the switch powers on, it begins its power-on sequence. The power-on sequence can take up to 90 seconds to complete.

3. Make sure that the power-on sequence has completed by verifying that the EIP Mod and Setup status indicators are flashing green.

If the switch fails the power-on sequence, the EIP Mod status indicator turns red.

4. Press and release the Express Setup button.

Unlike multi-mode Express Setup, there is no time requirement for when you release the Express Setup button.

5. Wait a few seconds until the status indicator on one of the unconnected switch ports flashes green.

6. Connect a Category 5 Ethernet cable from the flashing switch port to the Ethernet port on a computer.

or

For 1783-BMS4S2SGL or 1783-BMS4S2SGA switches, do one of the following:

- Insert a copper SFP module into the Gi1/1 port on the switch. Then connect a Category 5 Ethernet cable from the SFP module to the Ethernet port on the computer.
- Connect the Gi1/1 port on the switch to the Ethernet port on the computer by using a fiber-to-Ethernet media converter.

---

**IMPORTANT** Port Gi1/1 does not flash during setup, but must be used to connect 1783-BMS4S2SGL or 1783-BMS4S2SGA switches to a computer.

---

---

**IMPORTANT** If you wait too long to connect the cable, the Setup status indicator turns off.

---

7. Proceed to [Configure Network Settings via Device Manager on page 37](#).

## Configure Network Settings via Device Manager

You can apply one of the following setup modes to the switch after you run Express Setup as described on [page 28](#):

- Express Setup—Enables the switch to operate as a managed switch with a default configuration that supports industrial automation applications. Express Setup is the default setup mode.
- Plug-n-Play (PnP)—Enables the switch to operate as an unmanaged switch without an IP address.

Configure PnP server settings to enable the switch to send a work request to a PnP server for further device configuration. The PnP agent is a software application on the switch. When the switch is powered on for the first time, the PnP agent discovery process, which is embedded in the switch, wakes up in the absence of the startup configuration file and attempts to discover the address of the PnP server. The PnP agent uses methods like DHCP, Domain Name System (DNS), and others to acquire the IP address of the PnP server. Once a server is found and connection established, the agent performs activities, such as configuration, image, license, and file updates by communicating with the server.

If an auto discovery mechanism is not available, you can use the PnP configuration option from Express Setup to configure the initial switch settings and PnP server information.

### Apply the PnP Setup Mode

To apply the PnP setup mode to the switch, follow these steps.

1. Access Device Manager as described on [page 48](#).

If the Express Setup page does not appear, try the following:

- Verify that your network adapter is set to accept a DHCP address
  - Enter the URL of a well-known website in your browser to be sure that the browser is working correctly. Your browser then redirects to Express Setup.
  - Verify that any proxy settings or popup blockers are disabled on your browser.
  - Verify that any wireless interface is disabled on the computer.
2. From the Select device initial setup mode pull-down menu, choose PnP.
  3. Complete the fields as described in [Table 10](#) and click Submit.

**Table 10 - PNP Mode Fields**

Field	Description
Management Interface (VLAN)	The ID of the management VLAN through which the switch is managed. The management VLAN is the broadcast domain through which management traffic is sent between specific users or devices. It provides broadcast control and security for management traffic that must be limited to a specific group of users. It also provides secure administrative access to all devices in the network. Choose an existing VLAN as the management VLAN. The default management VLAN ID is 1. <b>IMPORTANT:</b> Be sure that the switch and your network management station are in the same VLAN. Otherwise, you lose management connectivity to the switch.
IP Address	The IP address and associated subnet mask are unique identifiers for the switch in a network: <ul style="list-style-type: none"> <li>The IP address format is a 32-bit numeric address that is written as four numbers that are separated by periods. Each number can be from 0...255.</li> <li>The subnet mask is the network address that identifies the subnetwork (subnet) to which the switch belongs. Subnets are used to segment the devices in a network into smaller groups. The default is 255.255.255.0.</li> </ul> Make sure that the IP address that you assign to the switch is not being used by another device in your network.
Default Gateway	The IP address for the default gateway. A gateway is a router or a dedicated network device that enables the switch to communicate with devices in other networks or subnetworks. The default gateway IP address must be part of the same subnet as the switch IP address. The switch IP address and the default gateway IP address cannot be the same. If all of your devices are in the same network and a default gateway is not used, leave this field blank. If your network management station and the switch are in different networks or subnetworks, you must specify a default gateway. Otherwise, the switch and your network management station cannot communicate with each other.
PNP Server IP	The IP address of the PnP server.
PNP Server Port	The port number to use to connect to the PnP server.
User	Enter the user name for the switch.
Password, Confirm Password	The password for the switch can have a maximum of 63 alphanumeric characters, can start with a number, is case-sensitive, and can have embedded spaces. The password cannot be one digit, it cannot contain a ? or a tab, and it does not allow spaces at the beginning or the end. The default is <b>switch</b> . To complete initial setup, you must change the password from the default password, <b>switch</b> . This password is also used as the Control Industrial Protocol (CIP) security password. We recommend that you provide a password to the switch to secure access to Device Manager.

## Apply the Express Setup Configuration

To apply the Express Setup configuration to the switch, follow these steps.

1. Access Device Manager as described on [page 48](#).

If the Express Setup page does not appear, try the following:

- Verify that your network adapter is set to accept a DHCP address
  - Enter the URL of a well-known website in your browser to be sure that the browser is working correctly. Your browser then redirects to Express Setup.
  - Verify that any proxy settings or popup blockers are disabled on your browser.
  - Verify that any wireless interface is disabled on the computer.
2. From the Select device initial setup mode pull-down menu, choose Express Setup.
  3. Complete the fields as described in [Table 11](#).

Allen-Bradley Stratix 5400 Solution Device Manager - Switch Express Setup

Select device initial setup mode: Express Setup

**Network Settings**

Host Name:

Management Interface (VLAN):

IP Assignment Mode:  Static  DHCP

IP Address:  /

Default Gateway:

NTP Server:

User:  Password:  Confirm Password:

**Advanced Settings**

Enable CIP VLAN:

CIP VLAN:

IP Address:  /

Same As Management VLAN:

Enable SSH:

Telnet:

CIP and Enable Password:(leave it blank if no change)  Confirm Password:

Same As Admin Password:

Submit

Table 11 - Express Setup Mode Fields

Field	Description
<b>Network Settings</b>	
Host Name	The name of the switch.
Management Interface (VLAN)	<p>The ID of the management VLAN through which the switch is managed. The management VLAN is the broadcast domain through which management traffic is sent between specific users or devices. It provides broadcast control and security for management traffic that must be limited to a specific group of users, such as the administrators of your network. It also provides secure administrative access to all devices in the network.</p> <p>Choose an existing VLAN as the management VLAN. The default management VLAN ID is 1 and the VLAN name is default.</p> <p>Valid IDs for single-mode Express Setup: 1 . . . 1001</p> <p>Valid IDs for multi-mode Express Setup: 1 . . . 4096</p> <p><b>IMPORTANT:</b> Be sure that the switch and your network management station are in the same VLAN. Otherwise, you lose management connectivity to the switch.</p>
IP Assignment Mode	<p>The IP Assignment mode determines whether the switch IP information is manually assigned (static) or is automatically assigned by a Dynamic Host Configuration Protocol (DHCP) server. The default is Static.</p> <p>We recommend that you click Static and manually assign the IP address for the switch. You can then use the same IP address whenever you want to access Device Manager.</p> <p>If you click DHCP, the DHCP server automatically assigns an IP address, subnet mask, and default gateway to the switch. Unless restarted, the switch continues to use the DHCP-assigned information, and you are able to use the DHCP-assigned address to access Device Manager.</p> <p>For a manually assigned IP address in a network that uses a DHCP server, make sure that the IP address is not within the range of addresses that the DHCP server assigns. Otherwise, IP address conflicts can occur between the switch and another device.</p>
IP Address	<p>The IP address and associated subnet mask are unique identifiers for the switch in a network:</p> <ul style="list-style-type: none"> <li>• The IP address format is a 32-bit numeric address that is written as four numbers that are separated by periods. Each number can be from 0 . . . 255.</li> <li>• The subnet mask is the network address that identifies the subnetwork (subnet) to which the switch belongs. Subnets are used to segment the devices in a network into smaller groups. The default is 255.255.255.0.</li> </ul> <p><b>IMPORTANT:</b> If you run multi-mode Express Setup in Medium Press mode, the IP Address field displays the address received from the DHCP server. If you change the address, the connection drops. To re-establish the connection with the new address, close your web browser and go to the address you specified.</p> <p>Be sure that the IP address that you assign to the switch is not assigned to another device in your network. The IP address and the default gateway cannot be the same.</p>
Default Gateway	<p>The IP address for the default gateway. A gateway is a router or a dedicated network device that enables the switch to communicate with devices in other networks or subnetworks. The default gateway IP address must be part of the same subnet as the switch IP address. The switch IP address and the default gateway IP address cannot be the same.</p> <p>If all of your devices are in the same network and a default gateway is not used, you do not need to enter an IP address in this field. This field is enabled only if the IP assignment mode is Static.</p> <p>If your network management station and the switch are in different networks or subnetworks, you must specify a default gateway. Otherwise, the switch and your network management station cannot communicate with each other.</p>
NTP Server	The IP address of the Network Time Protocol (NTP) server. NTP is a networking protocol for clock synchronization between computer systems over packet-switched, variable-latency data networks.
User	Enter the user name for the switch.
Password, Confirm Password	<p>The password for the switch can have up to 63 alphanumeric characters, can start with a number, is case-sensitive, and can have embedded spaces. The password cannot be one digit, it cannot contain a ? or a tab, and it does not allow spaces at the beginning or the end.</p> <p>To complete initial setup, you must change the password from the default password, <b>switch</b>.</p> <p>This password is also used as the Control Industrial Protocol (CIP) security password. We recommend that you provide a password to the switch to secure access to Device Manager.</p>
<b>Advanced Settings</b>	
Enable CIP VLAN	Check Enable CIP VLAN to enable CIP on a VLAN. You can specify the settings required for CIP or check the Same As Management VLAN checkbox.
CIP VLAN	The VLAN on which CIP is enabled. The CIP VLAN can be the same as the management VLAN or you can isolate CIP traffic on another VLAN that is already configured on this device.
IP Address	<p>The IP address and subnet mask for the CIP VLAN if the CIP VLAN differs from the management VLAN. The format is a 32-bit numeric address that is written as four numbers that are separated by periods. Each number can be from 0 . . . 255.</p> <p>Make sure that the IP address that you assign to this device is not being used by another device in your network.</p>
Same As Management VLAN	Check the Same As Management VLAN to make the settings for the CIP VLAN the same as the management VLAN.
Enable SSH	Check SSH to enable Secure Shell (SSH) sessions on the switch. SSH must be enabled to access the switch via the command-line interface (CLI). For more information about the CLI, see <a href="#">page 73</a> .



**Table 11 - Express Setup Mode Fields (Continued)**

Field	Description
Telnet	Check Telnet to enable Telnet. You can use Telnet to access the switch via the command-line interface (CLI). For more information about the CLI, see <a href="#">page 73</a> . Telnet uses the local account user name and password. <b>IMPORTANT:</b> We recommend that you use SSH instead of Telnet for access to the switch. SSH provides more security for remote connections than Telnet by providing strong encryption.
CIP and Enable Password, Confirm Password	Enter the CIP and Enable password, or leave this field blank if you do not want to change the password. Reenter the password to confirm.
Same As Admin Password	Check Same As Admin Password to set the password that is used for CIP to the same user password specified under Network Settings.

4. Click Submit.

The switch initializes its configuration for typical industrial EtherNet/IP applications by running the global macro as described on [page 44](#). You can then log on to Device Manager for further configuration or exit the application.

5. Turn off DC or AC power at the source, disconnect any cables to the switch, and install the switch in your network.

---

**IMPORTANT** For 1783-BMS4S2SGL or 1783-BMS4S2SGA switches, make sure that DC power is disconnected before disconnecting Ethernet cables.

---

6. If you used single-mode Express Setup or multi-mode Express Setup in Short Press mode, refresh the computer IP address:

- For a dynamically assigned IP address, disconnect the computer from the switch and reconnect the computer to the network. The network DHCP server assigns a new IP address to the computer.
- For a statically assigned IP address, change it to the previously configured IP address.

7. For Stratix 5400 and 5410 switches, synchronize the SD card that came with the switch with the internal memory of the switch:

- To synchronize the SD card via Device Manager, see [page 66](#).
- To synchronize the SD card via the Logix Designer application, see [page 70](#).

After initial setup with Express Setup, you can change the settings if you want to move the switch to another management VLAN or to another network. To change Express Setup settings after initial setup, access the Express Setup page from the Admin menu in Device Manager.

## Configure Network Settings via the Logix Designer Application

To configure network settings via the Logix Designer application after running multi-mode Express Setup in Medium Press mode, follow these steps.

1. Add the switch to a controller project as described on [page 53](#).

2. Configure general properties as described [page 55](#).

Be sure to specify the IP address assigned to the switch by the DHCP server.

3. Go online with the controller, and then open the Module Properties dialog box for the switch.

4. In the navigation pane, click Switch Configuration.

5. When the Express Setup dialog box appears, complete the fields.

**Express Setup**

Express Setup has been initiated.  
Please provide the following information to complete the initialization of the switch

**Internet Protocol (IP) Settings**

Manually Configure IP settings  
 Obtain IP settings automatically using DHCP

**IP Settings Configuration**

Physical Module IP Address:  Subnet Mask:

Host Name:  Gateway Address:

Network Time Protocol (NTP) Server:

**Create Password**

User:

Password:

Confirm Password:

**Switch Management**

Management Interface VLAN:

OK Cancel Help

Table 12 - Express Setup Fields

Field	Description
Internet Protocol (IP) Settings	<p>Click the method to use for assigning the switch an IP address:</p> <ul style="list-style-type: none"> <li>Manually Configure IP settings (default)—The switch uses a manually-assigned, static IP address. If you manually assign the IP address of the switch and your network uses a DHCP server, make sure that the IP address is not within the range of addresses that the DHCP server assigns. Otherwise, IP address conflicts can occur between the switch and another device.</li> <li>Obtain IP settings automatically using DHCP—A Dynamic Host Configuration Protocol (DHCP) server automatically assigns the switch an IP address, subnet mask, and default gateway. Unless restarted, the switch continues to use the DHCP-assigned information.</li> </ul>
Physical Module IP Address	<p>Displays the IP address assigned to the switch by the DHCP server during Express Setup. This value must match the IP address on the General view. If you change the assigned IP address, make sure that the new IP address is not assigned to another device in your network. The IP address and the default gateway cannot be the same.</p> <p><b>IMPORTANT:</b> If you reconfigure your switch with another IP address, you can lose communication with the switch when you click Set. To correct this problem, you must return to the Express Setup and General view, set the new IP address, and download to the controller.</p>
Subnet Mask	<p>Displays the IP address assigned to the switch by the DHCP server during Express Setup. The subnet mask is the network address that identifies the subnetwork (subnet) to which the switch belongs. Subnets are used to segment the devices in a network into smaller groups. The subnet mask is a 32-bit number. Set each octet between 0 . . .255. The default is 255.255.255.0.</p>
Host Name	Type a name to identify the switch. The name can be up to 64 characters and can include alphanumeric and special characters (comma and dash).
Gateway Address	<p>Displays the gateway address assigned to the switch by the DHCP server during Express Setup. A gateway is a router or a dedicated network device that enables the switch to communicate with devices in other networks or subnetworks. The default gateway IP address must be part of the same subnet as the switch IP address. The switch IP address and the default gateway IP address cannot be the same.</p> <p>If all of your devices are in the same network and a default gateway is not used, you do not need to enter an IP address in this field. This field is enabled only if the IP assignment mode is Static.</p> <p>If your network management station and the switch are in different networks or subnetworks, you must specify a default gateway. Otherwise, the switch and your network management station cannot communicate with each other.</p> <p><b>IMPORTANT:</b> Communication is disrupted when you change the gateway (IP) address.</p>
Network Time Protocol (NTP) Server	(Optional). Type the IP address of the NTP server. NTP is a networking protocol for clock synchronization between computer systems over packet-switched, variable-latency data networks.
User	Displays the default user name: <b>Admin</b>
Password, Confirm Password	<p>The password for the switch can have up to 63 alphanumeric characters, can start with a number, is case-sensitive, and can have embedded spaces. The password cannot be one digit, it cannot contain a ? or a tab, and it does not allow spaces at the beginning or the end. The default password is <b>switch</b>.</p> <p>To complete initial setup, you must change the password from the default password.</p> <p>This password is also used as the Control Industrial Protocol (CIP) security password. You must provide a password to the switch to secure access to Device Manager.</p>
Management Interface (VLAN)	<p>Choose a management VLAN. The default management VLAN ID is 1.</p> <p>The management VLAN through which the switch is managed. The management VLAN is the broadcast domain through which management traffic is sent between specific users or devices. It provides broadcast control and security for management traffic that must be limited to a specific group of users, such as the administrators of your network. It also provides secure administrative access to all devices in the network.</p> <p><b>IMPORTANT:</b> Be sure that the switch and your network management station are in the same VLAN. Otherwise, you lose management connectivity to the switch.</p>

**6.** Click OK.

The switch initializes its configuration for typical industrial EtherNet/IP applications by running the global macro as described on [page 44](#). You can perform for further configuration or close the application.

**7.** Turn off DC or AC power at the source, disconnect any cables to the switch, and install the switch in your network.

---

**IMPORTANT** For 1783-BMS4S2SGL or 1783-BMS4S2SGA switches, make sure that DC power is disconnected before disconnecting Ethernet cables.

---

**8.** For Stratix 5400 and Stratix 5410 switches, synchronize the SD card that came with the switch with the internal memory of the switch as described on [page 70](#).

## Default Global Macro

Once you complete Express Setup, the switch runs a default global macro (ab-global). This macro configures the switch for industrial automation applications that use the EtherNet/IP protocol. This macro sets many parameters, including these major settings:

- Enable IGMP snooping and querier
- Enable CIP
- Enables alarms, SYSLOG, and SNMP notifications
- Enables Rapid Spanning Tree (RSTP), BPDU Guard, BPDU Filter, and loop guard
- Configure Quality of Service (QoS) settings and classify CIP, PTP, and other traffic (does not apply to switches with lite firmware revisions)

---

**IMPORTANT** The default QoS setting applied by the default global macro assigns the same priority to traffic for CIP and traffic for Integrated Motion on the EtherNet/IP network applications. However, you can assign a higher priority to motion traffic by manually applying optional QoS macros after you run Express Setup. For more information, see [page 157](#).

---

If you do not run Express Setup to initialize the switch, the global macro does not run. You can use the CLI, described on [page 73](#), to run the global macro.

## Linx-based Software and Network Who Support

The EtherNet/IP network interface also supports the List Identity command that is used by CIP-based network tools, such as the Linx-based software RSWho function. RSWho enables you to locate and identify your switch on the network by using the electronic data sheet (EDS) files.

To access the RSWho function, from the Linx-based software toolbar, choose Communications > RSWho.

---

**IMPORTANT** After using the RSWho function, if you access the switch and view the Ethernet link counters, you see the counts for only the first port (Port Gi1/1).

---

### Electronic Data Sheet (EDS) Files

Electronic Data Sheet (EDS) files are text files that are used by network configuration tools, such as RSNetWorx™ for EtherNet/IP software. EDS files help you identify products and commission them on a network. EDS files contain details about the readable and configurable parameters of the device. They also provide information about the I/O connections the device supports and the content of the associated data structures.

If you are using the switch in a system without a Rockwell Automation Logix controller, you cannot use the AOP supplied with Logix controllers. You must use information from the EDS files to configure the I/O connection.

EDS files for the Stratix switches are included with the following software packages:

- Linx-based software
- Studio 5000® programming environment
- RSNetWorx for EtherNet/IP software

You can also obtain the EDS files in either of these two ways:

- By downloading it from <http://www.rockwellautomation.com/resources/eds/>.
- By using the EDS Hardware Installation tool included in the Studio 5000 environment.

## Data Accessible with CIP

The CIP interface lets you access the information in [Table 13](#).

**Table 13 - Data Accessible with CIP**

Data Type	Details
Input data via I/O connection	<ul style="list-style-type: none"> <li>Link status per port: not connected, connected</li> <li>Unauthorized device per port: OK, not OK</li> <li>Unicast threshold exceeded per port: OK, exceeded</li> <li>Multicast threshold exceeded on each port: OK, exceeded</li> <li>Broadcast threshold exceeded on each port: OK, exceeded</li> <li>Port bandwidth utilization per port: value in %</li> <li>Alarm relay major: OK, tripped</li> <li>Multicast groups active: quantity</li> </ul>
Output data via I/O connection	Port disable per port: enabled, disabled
Other status data	<ul style="list-style-type: none"> <li>Module identification (vendor ID, device type, product code, product name, revision, serial number)</li> <li>Major/minor fault status, I/O connection, module identity match</li> <li>Active alarms</li> <li>Major alarm relay (open, closed)</li> <li>Active faults</li> <li>Switch uptime since last restart</li> <li>Switch internal temperature in degrees Centigrade</li> <li>Management CPU utilization in percentage</li> <li>Power supply A present: yes, no</li> <li>Power supply B present: yes, no</li> <li>Number of active multicast groups</li> <li>IOS release version</li> <li>DLR ring status, members, and faults</li> <li>CIP connection counters: open/close requests, open/close rejects, timeouts</li> <li>Port alarm status per port: OK, Link Fault, Not Forwarding, Not Operating, High Bit Error Rate</li> <li>Port fault status per port: Error Disable, SFP Error, Native VLAN Mismatch, MAC ID Flap Condition, Security Violation</li> <li>Port diagnostic counters per port: Ethernet interface counters (10), Ethernet media counters (12)</li> <li>Link status</li> <li>Traffic threshold exceeded per port: unicast, multicast, broadcast</li> <li>Cable diagnostics per port selected</li> <li>DHCP pool display: name, starting and ending IP address</li> <li>NAT: display name of instance, VLANs assigned per instance</li> <li>NAT diagnostics: active translations, total translated packets, blocked and pass-through traffic, ICMP and ARP fixups</li> </ul>
Configuration data	<ul style="list-style-type: none"> <li>Major and minor revision of switch</li> <li>Electronic keying (Exact Match, Disable Keying)</li> <li>Connection (Input Data, Data)</li> <li>Data connection password</li> <li>Requested packet interval (RPI)</li> <li>Inhibit module</li> <li>Major fault on controller if connection fails while in Run mode</li> <li>Use unicast connections over EtherNet/IP</li> <li>Module fault display</li> <li>IP addressing method: Manual, DHCP</li> <li>IP address, subnet mask, primary and secondary DNS server address, default gateway (all if static)</li> <li>Host name</li> <li>Administration: contact name, geographic location</li> <li>Spanning Tree Mode (MST, RSTP, PVST+, RPVST+)</li> <li>Dual-power supply alarm enable</li> <li>Port configuration per port: enable/disable, auto-negotiate, speed, duplex</li> <li>Power over Ethernet (PoE): mode, status, power limit, power used, total power supported, total power used, remaining power available</li> <li>Smartports and VLANs: assign roles per port, VLAN ID and name</li> <li>Port thresholds (incoming: unicast, multicast, broadcast, all outgoing traffic) rate limiting threshold per port: in packets per second, bits per second, or percentage</li> <li>Port security: enable, allowed MAC IDs per port, dynamic, static</li> <li>DHCP pool: enable, delete, refresh, create</li> <li>DHCP address assignment per port</li> <li>Time sync configuration: enable per port, port state</li> <li>NAT configuration: create instance (private-to-public, public-to-private, traffic permits, and fixups)</li> </ul>
Smartport assignment per port	<ul style="list-style-type: none"> <li>Role</li> <li>VLAN</li> </ul>
Save and restore configuration	Via File Obj

## Configuration via Device Manager

Device Manager is a web-based management tool for configuring, monitoring, and troubleshooting individual switches. You can display Device Manager from anywhere in your network through a web browser.

Device Manager displays real-time views of switch configuration and performance. It simplifies configuration tasks with features such as Smartports. It uses graphical, color-coded displays, such as the front panel view, graphs, and animated indicators to simplify monitoring tasks. It provides alert tools to help you to identify and to solve networking problems.

**Table 14 - Device Manager Hardware Requirements**

Attribute	Requirement
Processor speed	1 GHz or faster (32 bit or 64 bit)
RAM	1 GB (32 bit) or 2 GB (64 bit)
Available hard disk space	16 GB (32 bit) or 20 GB (64 bit)
Number of colors	256
Resolution	1024 x 768
Font size	Small

**Table 15 - Device Manager Software Requirements**

Web Browser	Version
Microsoft Internet Explorer	Latest version with JavaScript enabled
Mozilla Firefox	Latest version with JavaScript enabled

The screenshot displays the Device Manager web interface for an Allen-Bradley Stratix 5400 switch. The interface is organized into several sections:

- Header:** Includes the Allen-Bradley logo, the title "Stratix 5400 Solution Device Manager - Switch", and navigation tabs for "Dashboard", "Configure", "Monitor", and "Admin".
- Uptime:** Shows "Uptime: 1 week, 6 days, 14 minutes".
- Front Panel:** A graphical representation of the switch's front panel with a "View: Status" dropdown and a "Locate Switch: 255" input field.
- Switch Information:** A list of key identifiers:
  - HostName: HMS8SG4CGR\_68\_132
  - IP Address: 10.223.68.132
  - MAC Address: F4:54:33:15:F7:80
  - Product ID: 1783-HMS8SG4CGR
  - CIP Revision: 4.001
  - CIP Serial Number: 0x60158E57
  - Serial Number: FD01914U00P
  - Version ID: V01
  - Software Version: 15.2(6.2.22)E (Crypto) UNIVERSAL
  - Contact: (blank)
  - Location: Stratix WOS
- Switch Health:** Two gauge charts:
  - CPU UTILIZATION: 24%
  - TEMPERATURE: 60°C
- Port Utilization:** A line graph showing utilization for ports G0/1 through G0/12. The legend indicates "Errors", "Receive", and "Transmit".
- Footer:** Includes "Transferring data from 10.223.68.132...", "ALL RIGHTS RESERVED.", and "Alarms" status indicators.

## Access Device Manager

With IOS release 15.2(5)EA.fc4 and later, Device Manager provides a secure connection via the latest version of Internet Explorer or Firefox. Security messages from your browser can appear when you access Device Manager.

To make sure that Device Manager runs properly, disable any popup blockers or proxy settings in your browser and any wireless clients on your computer. Device Manager verifies the browser version when starting a session to be sure that the browser is supported.

---

**IMPORTANT** With IOS release 15.2(6)E0a and later, Device Manager has an auto-logout feature:

- If you upgrade to IOS release 15.2(6)E0a and use the Express Setup process, Device Manager automatically logs you out if you are inactive for 20 minutes or longer.
- If you reset the switch to factory defaults or set up the switch via the CLI instead of Express Setup, Device Manager automatically logs you out if you are inactive for 3 minutes or longer.

To configure the inactivity timeout value for Device Manager sessions, use the following CLI command:

```
ip http session-idle-timeout [seconds]
```

Example: ip http session-idle-timeout 1200

---

To access Device Manager, follow these steps.

1. Start a web browser session and go to the switch IP address.

---

**IMPORTANT** If you set up bookmarks for accessing previous versions of Device Manager, be sure to recreate new bookmarks. Addresses that end with /homed.shtml do not provide the latest login authentication method.

---

2. (Internet Explorer). If one of the following messages appear, click the links circled in the following images to proceed to Device Manager.



## This site is not secure

This might mean that someone's trying to fool you or steal any info you send to the server. You should close this site immediately.

 [Close this tab](#)

 [More information](#)

**Your PC doesn't trust this website's security certificate.**  
**The hostname in the website's security certificate differs from the website you are trying to visit.**

Error Code: DLG\_FLAGS\_INVALID\_CA  
 DLG\_FLAGS\_SEC\_CERT\_CN\_INVALID

 [Go on to the webpage \(not recommended\)](#)



There is a problem with this website's security certificate.

The security certificate presented by this website was not issued by a trusted certificate authority. The security certificate presented by this website was issued for a different website's address.

Security certificate problems may indicate an attempt to fool you or intercept any data you send to the server.

**We recommend that you close this webpage and do not continue to this website.**

 [Click here to close this webpage.](#)

 [Continue to this website \(not recommended\).](#)

 [More information](#)

3. (Firefox). If the following message appears, do the following:
  - a. Click Advanced.

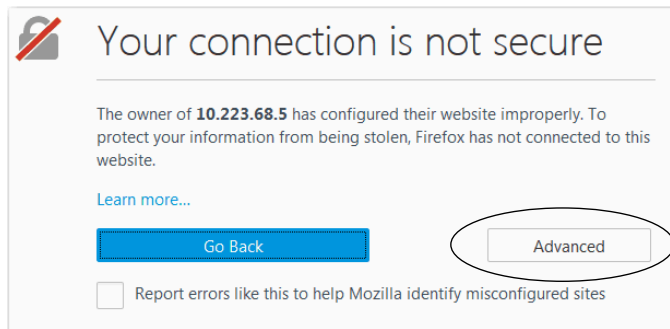

- b. Click Add Exception.

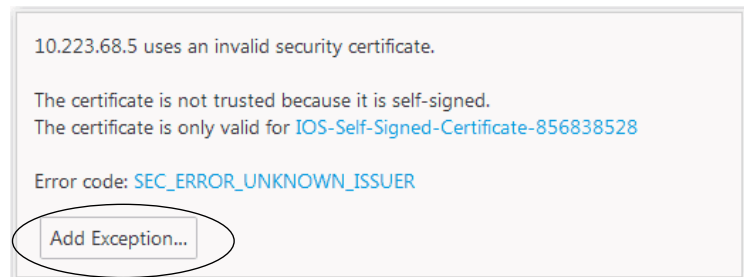

c. Click Confirm Security Exception.

**IMPORTANT** Do not check Permanently store this exception. Permanently storing the exception can cause issues to arise.

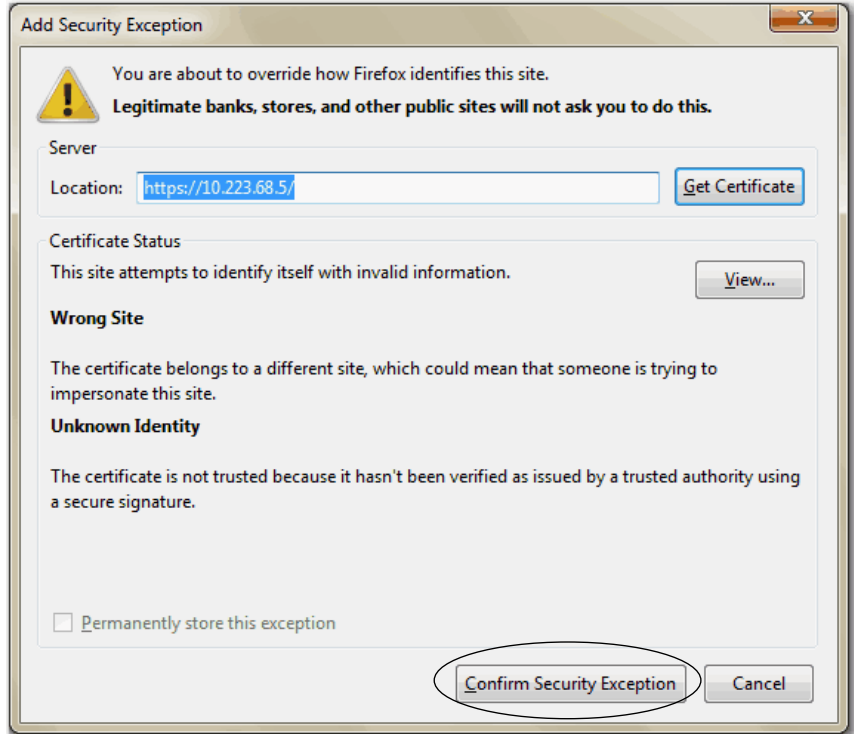

4. On the Login page, enter the switch user name and password.

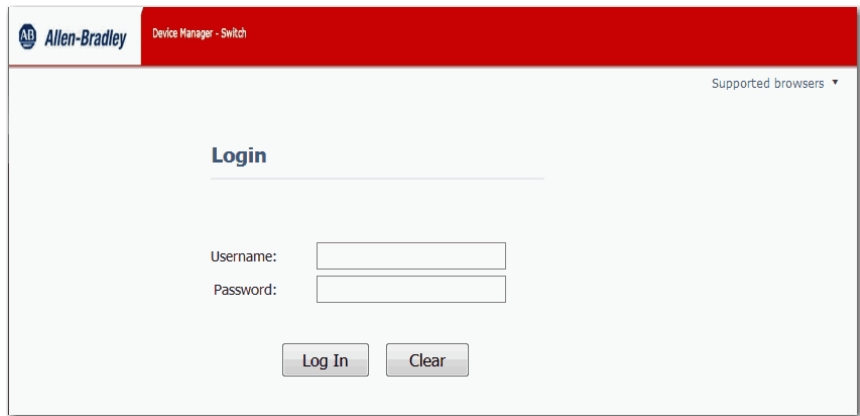

## Configure Port Settings

The basic port settings determine how data is received and sent between the switch and the attached device. You can change these settings to fit your network needs and to troubleshoot network problems. The settings on a switch port must be compatible with the port settings of the connected device.

To change basic port settings, from the Configure menu, choose Port Settings.

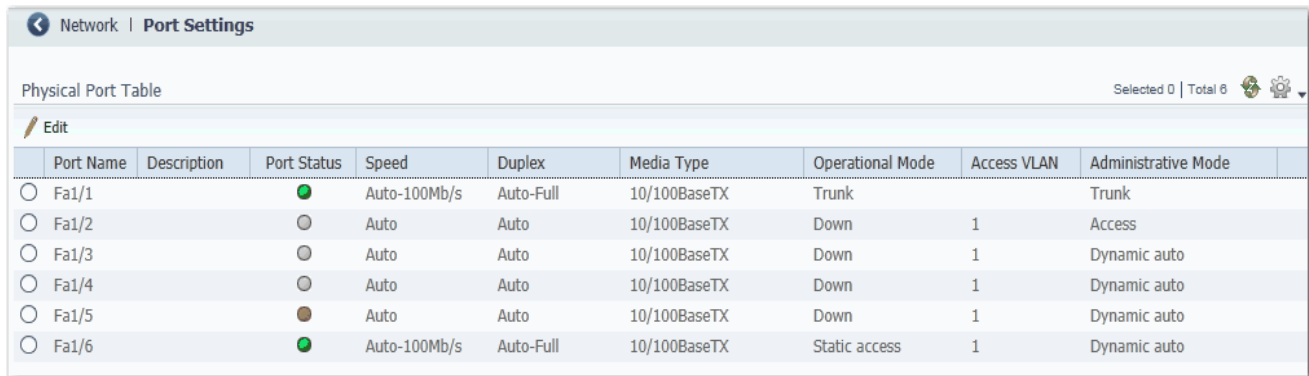

	Port Name	Description	Port Status	Speed	Duplex	Media Type	Operational Mode	Access VLAN	Administrative Mode
<input type="radio"/>	Fa1/1		<span style="color: green;">●</span>	Auto-100Mb/s	Auto-Full	10/100BaseTX	Trunk		Trunk
<input type="radio"/>	Fa1/2		<span style="color: gray;">●</span>	Auto	Auto	10/100BaseTX	Down	1	Access
<input type="radio"/>	Fa1/3		<span style="color: gray;">●</span>	Auto	Auto	10/100BaseTX	Down	1	Dynamic auto
<input type="radio"/>	Fa1/4		<span style="color: gray;">●</span>	Auto	Auto	10/100BaseTX	Down	1	Dynamic auto
<input type="radio"/>	Fa1/5		<span style="color: brown;">●</span>	Auto	Auto	10/100BaseTX	Down	1	Dynamic auto
<input type="radio"/>	Fa1/6		<span style="color: green;">●</span>	Auto-100Mb/s	Auto-Full	10/100BaseTX	Static access	1	Dynamic auto

[Table 16](#) lists the basic settings for the switch ports. To change these settings, click the radio button next to the port name and click Edit to display the Edit Physical Port page.

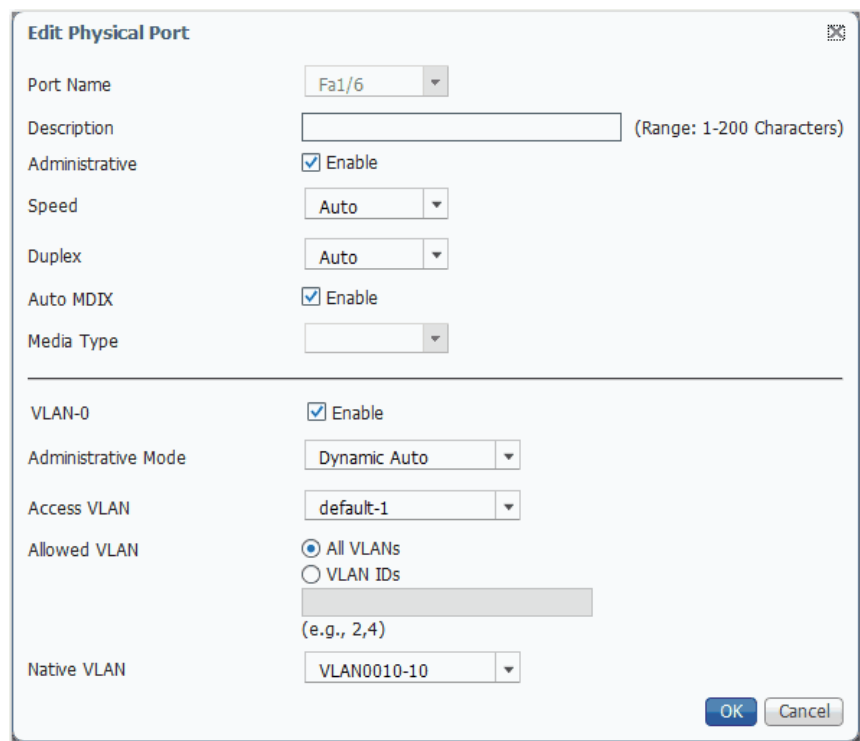

**Edit Physical Port**

Port Name:

Description:  (Range: 1-200 Characters)

Administrative:  Enable

Speed:

Duplex:

Auto MDIX:  Enable

Media Type:

---

VLAN-0:  Enable

Administrative Mode:

Access VLAN:

Allowed VLAN:  All VLANs  
 VLAN IDs  
  
(e.g., 2,4)

Native VLAN:

**Table 16 - Port Settings**

Field	Description
Port Name	The number of the switch port, including port type, such as Fa for Fast Ethernet and Gi for Gigabit Ethernet, and the specific port number: <ul style="list-style-type: none"> <li>• Gi/1 is the gigabit port 1 of the switch.</li> <li>• Fa1/1 is Fast Ethernet port 1 on the switch.</li> </ul>
Description	The description of the switch port. We recommend that you provide a port description to help identify the port during monitoring and troubleshooting. The description can be the location of the connected device or the name of the person using the connected device.
Port Status	(Appears only on the Edit Physical Port page; not editable). Indicates whether a device is connected to the port: <ul style="list-style-type: none"> <li>• Green = Connected</li> <li>• Gray = Not connected</li> </ul>
Speed	The operating speed of the switch port. If the connected device can negotiate the link speed with the switch port, choose Auto (autonegotiation). We recommend that you use Auto speed so that the speed of the switch port automatically matches the speed of the connected device. If the connected device requires a specific speed, change the speed of the switch port. Default: Auto
Duplex	The duplex mode of the switch port: <ul style="list-style-type: none"> <li>• Auto—(Autonegotiation). The connected device can negotiate the duplex mode with the switch. In the Physical Port table, the negotiated setting is Auto-Full or Auto-Half. If the port is not connected or has not completed negotiation, the status is Auto.</li> <li>• Half—(Half-duplex mode). The connected device must alternate sending or receiving data.</li> <li>• Full—(Full-duplex mode). Both devices can send data at the same time.</li> </ul> On Gigabit Ethernet ports, you cannot set the port to Half-duplex mode if the port speed is set to Auto. We recommend that you use Auto mode so that the mode on the switch port automatically matches the mode of the connected device. If the connected device requires a specific duplex mode, change the mode of the switch port. Default: Auto
Auto MDIX	(Appears only on the Edit Physical Port page). When enabled, this feature detects the port cable (straight-through or crossover) and configures the port pinouts, speed, and duplex mode to correctly communicate with the connected device. This setting is not available on SFP module ports. Default: Enabled
Media Type	(Applies to dual-purpose uplink ports). The active port type (either the RJ45 port or the SFP module port) of a dual-purpose uplink port. By default, the switch detects whether the RJ45 port or SFP module port of a dual-purpose port is connected and uses the port accordingly. Only one port can be active at a time. If both ports are connected, the SFP module port has priority. You cannot change the priority setting. Choose from the following media types: <ul style="list-style-type: none"> <li>• SFP—Only the SFP module port of a dual port is active. You can set the speed and duplex settings. Auto-MDIX is not available. For Gigabit Ethernet SFP ports, you can set the speed and duplex to Auto, or you can set the speed to 1000Mb/s, which configures the port to not negotiate if connected to a device that does not support autonegotiation.</li> <li>• RJ45—Only the RJ45 port of a dual port is active. You can enter the settings for port speed and duplex or choose Auto MDIX.</li> <li>• Auto—(Autonegotiation). The switch detects whether the RJ45 port or the SFP module port is connected and uses the port accordingly. Only one port can be active at a time. If both ports are connected to the network, the SFP module port has priority. The speed and duplex are set to Auto.</li> </ul> Default: Auto
Operational Mode	(Appears only in the Physical Port table; not editable). The operational state of the port. Displays the administrative mode or Down if disabled.
VLAN-0	(Appears only on the Edit Physical Port page). Enables the system to handle 802.1Q Ethernet frames with VLAN ID 0. These are called priority tagged frames. The purpose of priority tagged frames is to give priority to the frames with no significance to the VLAN ID. For example, PROFINET messaging requires priority tagged frames to pass CIP messages through the switch. For more information about VLAN 0 priority tagging, see <a href="#">page 286</a> . Default: Enabled

**Table 16 - Port Settings (Continued)**

Field	Description
Administrative Mode	<p>Choose one of the following administrative modes:</p> <ul style="list-style-type: none"> <li>• Access—The port is in permanent nontrunking mode and negotiates to convert the neighboring link into a nontrunk link even if the neighboring port is a trunk port. If you choose this option, also choose an Access VLAN. An access port belongs to and carries the traffic of only one VLAN (unless it is configured as a voice VLAN port).</li> <li>• Trunk—The port is in permanent Trunk mode and negotiates to convert the neighboring link into a trunk link even if the neighboring port is not a trunk port. If you choose this option, also choose whether to allow All VLANs or specified VLAN IDs.</li> <li>• Dynamic Auto—The port converts the link to a trunk link if the neighboring port is set to Trunk mode or Dynamic Desirable mode. This mode is the default setting. If you choose this option, specify an Access VLAN to use when the link is in access mode. Also specify whether to allow All VLANs or specified VLAN IDs when the link is in trunk mode.</li> <li>• Dynamic Desirable—If the neighboring port is set to Trunk, Dynamic Desirable, or Auto mode, the port converts the link to a trunk link. If you choose this option, specify an Access VLAN to use when the link is in access mode. Also choose whether to allow All VLANs or specified VLAN IDs when the link is in Trunk mode.</li> <li>• Routed—The port acts like a port on a router but does not have to be connected to a router. A routed port is not associated with a particular VLAN, as is an access port. A routed port behaves like a regular router port, except that it does not support VLAN subports. Routed ports can be configured with a Layer 3 routing protocol. A routed port is a Layer 3 port only and does not support Layer 2 protocols, such as DTP and STP. Routed ports are supported only on switches running the IP base or IP services image.</li> </ul> <p>Default: Dynamic Auto</p>
Access VLAN	The VLAN that an port belongs to and carries traffic for when the port is configured as or is acting as a nontrunking port.
Allowed VLAN	<p>(Appears only on the Edit Physical Port page). The VLANs for which the port handles traffic when the port is configured as or is dynamically acting as a trunking port:</p> <ul style="list-style-type: none"> <li>• To allow traffic on all available VLANs, click All VLANs.</li> <li>• To limit traffic to specific VLANs, click VLAN IDs and enter the VLAN numbers.</li> </ul>
Native VLAN	(Appears only on the Edit Physical Port page). The VLAN that transports untagged packets.

## Configuration via the Studio 5000 Environment

You can manage the switch by using the Logix Designer application in the Studio 5000® environment. The Logix Designer application is IEC 61131-3 compliant and offers relay ladder, structured text, function block diagram, and sequential function chart editors for you to develop application programs.

**Table 17 - Logix Designer Hardware Requirements**

Attribute	Requirement
Processor speed	Pentium II 450 MHz min Pentium III 733 MHz (or better) recommended
RAM	128 MB min 256 MB recommended
Free hard disk space	3 GB
Optical drives	DVD
Video requirements	256-color VGA graphics adapter 800 x 600-min resolution (True Color 1024 x 768 recommended)
Resolution	800 x 600-min resolution (True Color 1024 x 768 recommended)

To add the switch to a controller project in the Logix Designer application, follow these steps.

**IMPORTANT** These steps are required before you can go online to configure and monitor the switch. You must be online to view and configure most switch parameters in the Logix Designer application.

1. Open the project file for the controller to monitor the switch.
2. Right-click Ethernet and choose New Module.

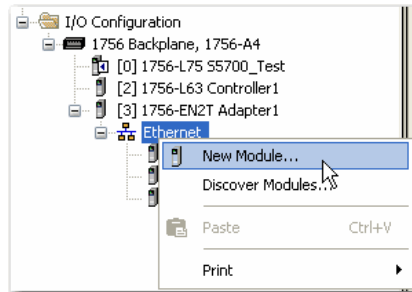

3. On the Select Module Type dialog box, select the switch and click Create.

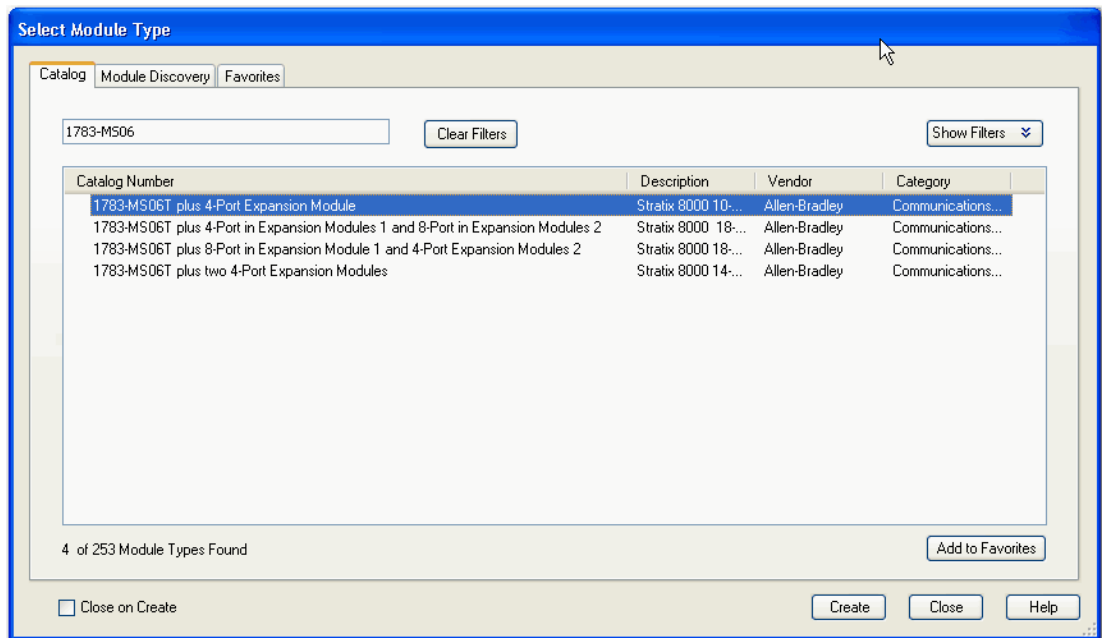

If you do not see the switch on the list, you can obtain the AOP from the Rockwell Automation support website:

<http://www.rockwellautomation.com/support/>

## General Properties

To configure general properties, follow these steps.

1. In the navigation pane, click General and complete the fields.

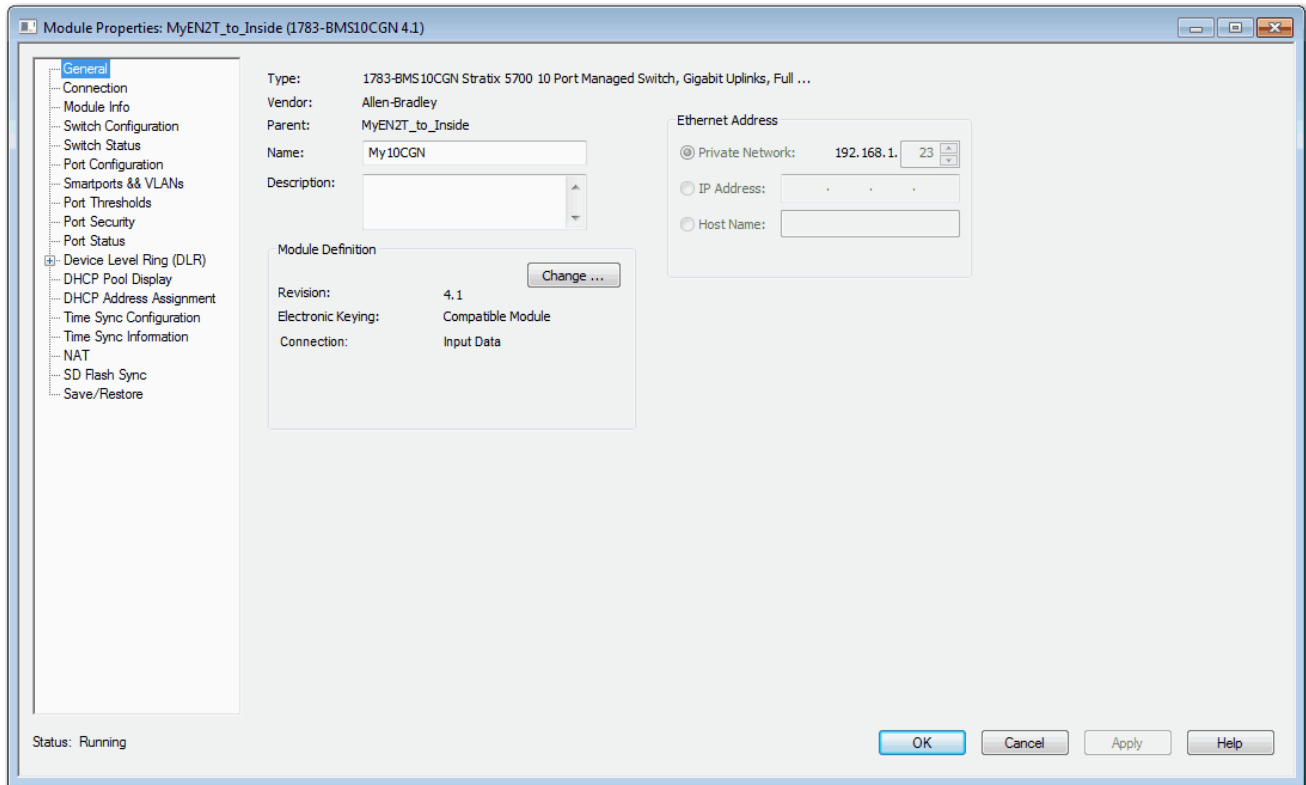

**IMPORTANT** Make sure that the IP address and host name match the values you used during Express Setup. On the Module Properties dialog box, you can choose either an IP address or host name. Only one of these two choices is enabled.

Field	Description
Name	A name that you choose for the switch.
Description	A description that helps you remember something important about the switch.
Ethernet Address	Choose one of the following: <ul style="list-style-type: none"> <li>• Private Network—The IP address of your private network.</li> <li>• IP Address—The IP address assigned to the switch during Express Setup.</li> <li>• Host Name—The host name that is provided on initial configuration when you performed Express Setup. The host name requires that you have a DNS server that is configured on the network for the Ethernet port module of the controller.</li> </ul>

2. In the Module Definition area, click Change.
3. On the Module Definition dialog box, complete the fields and click OK.

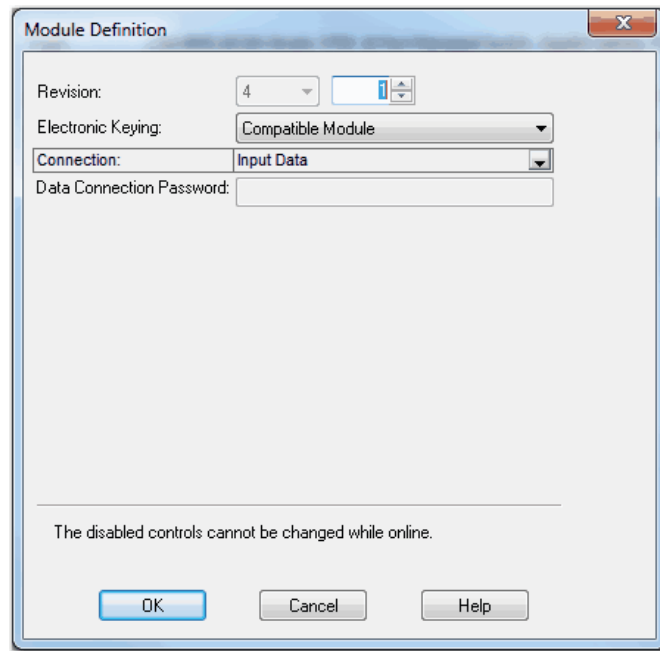

Field	Description
Revision	The major and minor revision of the switch: <ul style="list-style-type: none"> <li>• Major revision: 1...128</li> <li>• Minor revision: 1...255</li> </ul>
Electronic Keying	Choose one of the following: <ul style="list-style-type: none"> <li>• Compatible Module (default)</li> <li>• Exact Match</li> <li>• Disable Keying</li> </ul>
Connection	Choose one of the following: <ul style="list-style-type: none"> <li>• Input Data (default): Enables only an input data connection.</li> <li>• Data: Enables an input and output data connection.</li> </ul> <p><b>ATTENTION:</b> This selection enables output tags, which can disable ports and interrupt connections to and through the switch. You can disable a switch port by setting the corresponding bit in the output tag. The output bits are applied every time that the switch receives the output data from the controller when the controller is in Run mode. When the controller is in Program mode, the output bits are not applied. If the corresponding output bit is 0, the port is enabled. If you enable or disable a port by using Device Manager or the CLI, the port setting can be overridden by the output bits from the controller on the next cyclic update of the I/O connection. The output bits always take precedence, regardless of whether the Device Manager Web interface or CLI was used to enable or disable the port.</p>
Data Connection Password	(Data connections only). Enter the password for accessing the switch.
Switch Base (Stratix 8000/8300 switches)	Displays the switch base catalog number for the selected module.
Switch Expansion 1 (Stratix 8000/8300 switches)	(14, 18, 22 and 26 port switches only). The catalog number for the copper or fiber expansion modules you are using. For 14 and 18-port switches, user selection of the expansion module is supported. For 22 and 26-port switches, Switch Expansion 1 displays 1783-MX08T. User selection of the expansion module is not supported.
Switch Expansion 2 (Stratix 8000/8300 switches)	(22 and 26 port switches only). The catalog number for the copper or fiber expansion modules you are using. User selection of the expansion module is supported.



## Connection Properties

In the navigation pane, click Connection.

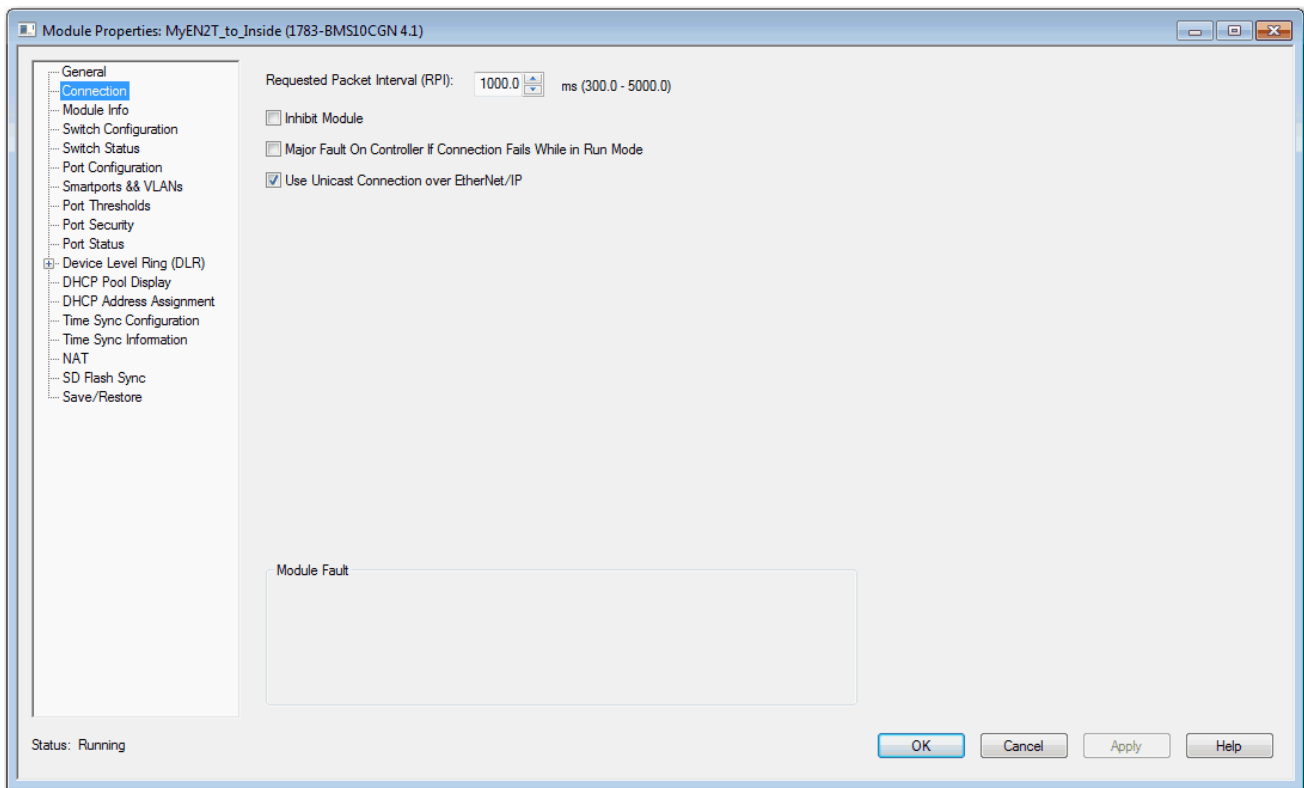

**Table 18 - Connection Fields**

Field	Description
Requested Packet Interval (RPI)	Enter a value between 300...5000.
Inhibit Module	Check to disable communication between the controller and the switch. Clear the checkbox to restore communication.
Major Fault on Controller If Connection Fails While in Run mode	Check to have the controller create a major fault if connection fails in Run mode.
Use Unicast Connections over EtherNet/IP	Check to use Unicast connections with the EtherNet/IP network.
Module Fault	Displays the fault code from the controller and the text that indicates the module fault has occurred.

## Switch Configuration

You can configure IP settings and administrative parameters. The IP address can be manually assigned (static) or it can be automatically assigned by a Dynamic Host Configuration Protocol (DHCP) server. The default is Static. We recommend that you choose Static and manually assign the IP address for the switch. You can then use the same IP address whenever you want to access the switch.

- Static—Manually enter the IP address, subnet mask, and gateway.
- DHCP—The switch automatically obtains an IP address, default gateway, and subnet mask from the DHCP server. As long as the switch is not restarted, it continues to use the assigned IP information.

In the navigation pane, click Switch Configuration.

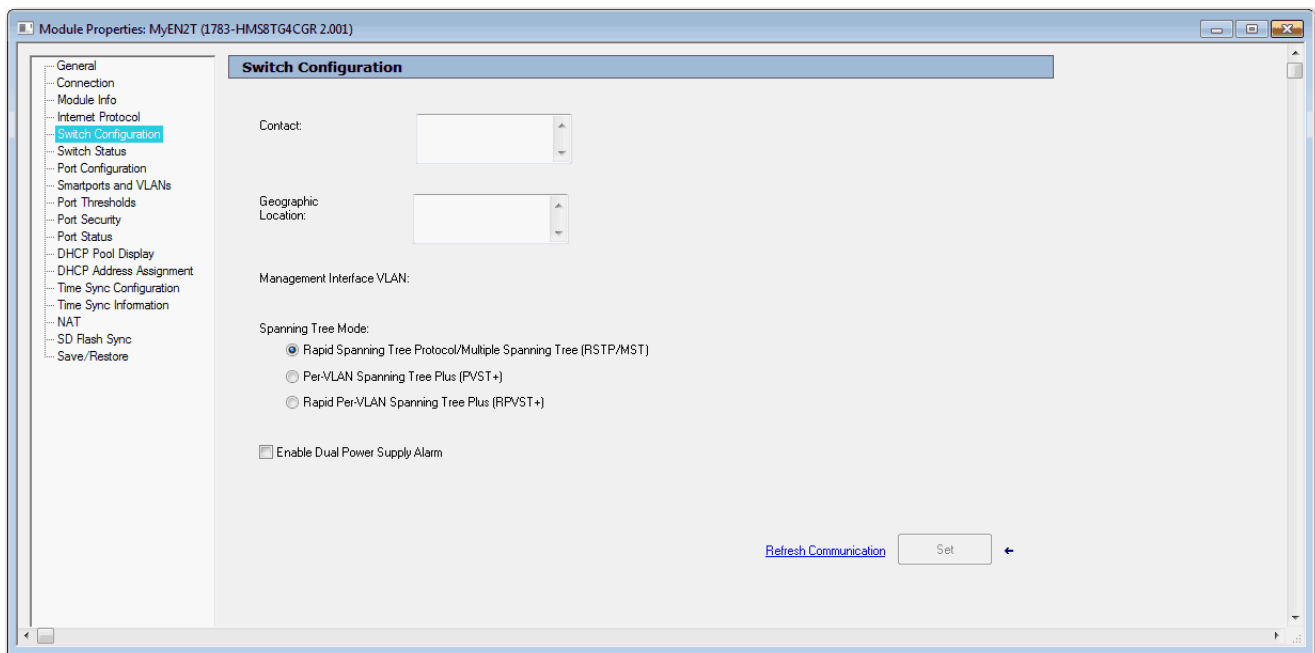

**Table 19 - Switch Configuration Fields**

Field	Description
Contact	(Optional). Enter contact information for the switch, up to 200 characters. The contact information can include alphanumeric and special characters (dash and comma) and a carriage return.
Geographic Location	(Optional). Enter a geographic location of the switch, up to 200 characters. The geographic location can include alphanumeric and special characters (dash and comma) and a carriage return.
Management Interface VLAN	Displays the VLAN through which the switch is managed. The management VLAN is the broadcast domain through which management traffic is sent between specific users or devices. It provides broadcast control and security for management traffic that must be limited to a specific group of users, such as the administrators of your network. It also provides secure administrative access to all devices in the network. <b>IMPORTANT:</b> Be sure that the switch and your network management station are in the same VLAN. Otherwise, you lose management connectivity to the switch.
Spanning Tree Mode (Stratix 5700 and ArmorStratix switches)	See <a href="#">Spanning Tree Protocol (STP) on page 278</a> .
Enable Dual-Power Supply Alarm (Stratix 5700 and ArmorStratix switches)	To enable dual-power supply alarms, check the checkbox. The feature is disabled by default.

## Port Configuration

Port settings determine how data is received and sent between the switch and the attached device.

In the navigation pane, click Port Configuration.

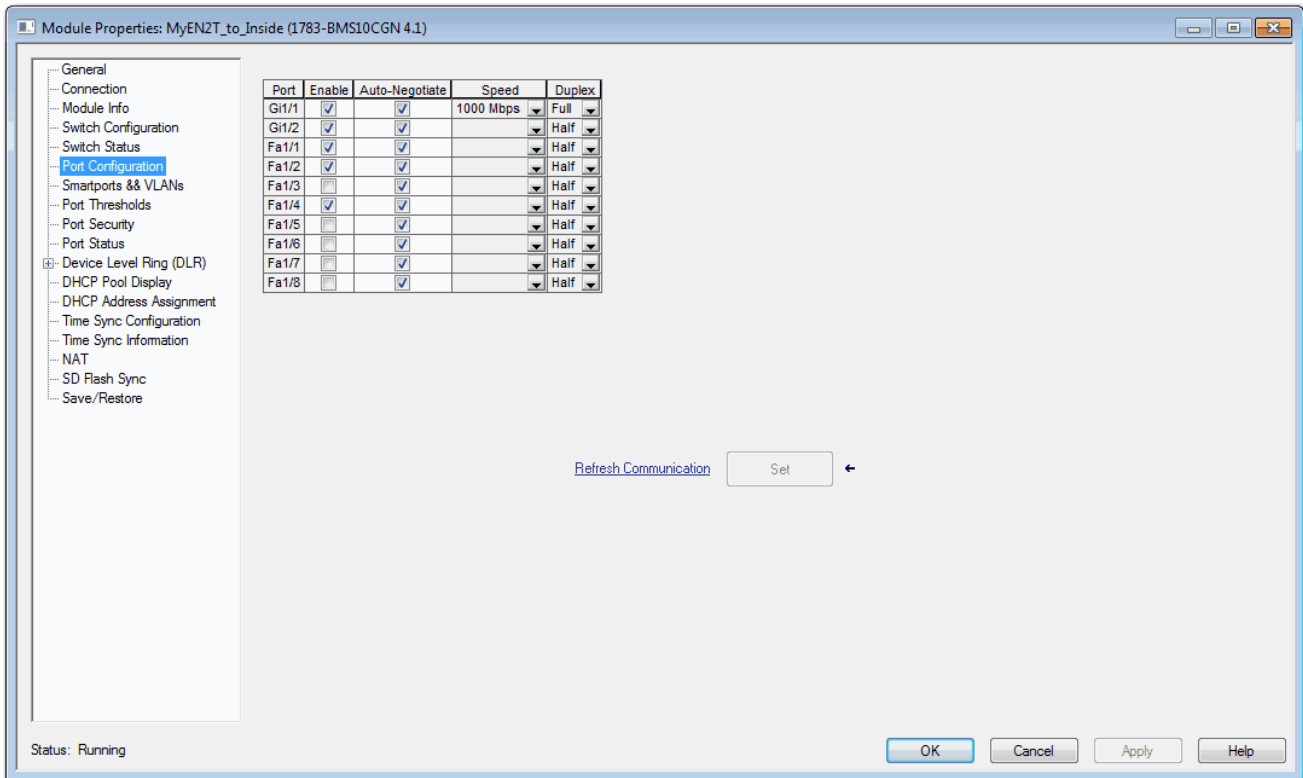

**Table 20 - Port Configuration Fields**

Field	Description
Unit (Stratix 8000/8300 switches)	Indicates where the port resides: <ul style="list-style-type: none"> <li>Base (for example, 1783-MS10T)</li> <li>Expansion module (for example, 1783-MX08T)</li> </ul>
Port	The port that is selected for configuration. The port number includes the port type (Fa for Fast Ethernet, Gi for Gigabit Ethernet, or Te for Ten Gigabit Ethernet) and the specific port number. <b>EXAMPLE:</b> Gi1/1 is Gigabit Ethernet port 1.
Enable	To enable the port, check the checkbox. To disable the port manually, clear the checkbox. If the port is not in use and is not attached to a device, we recommend that you disable the port. You can troubleshoot a suspected unauthorized connection by manually disabling the port.

**Table 20 - Port Configuration Fields (Continued)**

Field	Description
Auto-negotiate	<p>If you want the port and end-device to auto-negotiate the link speed and Duplex mode, check the checkbox. To specify the desired port speed and Duplex mode manually, clear the checkbox.</p> <p>We recommend that you use the default (auto-negotiate) so that the speed and duplex settings on the switch port automatically match the setting on the connected device. Change the switch port speed and duplex if the connected device requires a specific speed and duplex. If you set the speed and duplex for the switch port, the connected device must be configured for the same speed and duplex and not set to auto-negotiate. Otherwise, a speed/duplex mismatch occurs.</p> <p>Fiber-optic ports do not support auto-negotiation.</p>
Speed	<p>Choose the operating speed of the port.</p> <p>Gigabit (Gi):</p> <ul style="list-style-type: none"> <li>• 10 Mbps</li> <li>• 100 Mbps</li> <li>• 1 Gbps</li> </ul> <p>Fast Ethernet (Fa):</p> <ul style="list-style-type: none"> <li>• 10 Mbps</li> <li>• 100 Mbps</li> </ul> <p>10 Gigabit (Te)</p> <ul style="list-style-type: none"> <li>• 1 Gbps</li> <li>• 10 Gbps</li> </ul>
Duplex	<p>Choose one of these Duplex modes:</p> <ul style="list-style-type: none"> <li>• Half-duplex—Both devices cannot send data simultaneously. Half-duplex is not available when speed is set to 1 Gbps or higher.</li> <li>• Full-duplex—Both devices can send data simultaneously.</li> </ul>

## Port States During Program Mode and Connection Faults

You can configure the state of each port when these changes occur at the controller:

- The controller transitions to Program mode
- Communication is disrupted between the controller and the switch

In the navigation pane, click Fault/Program Action.

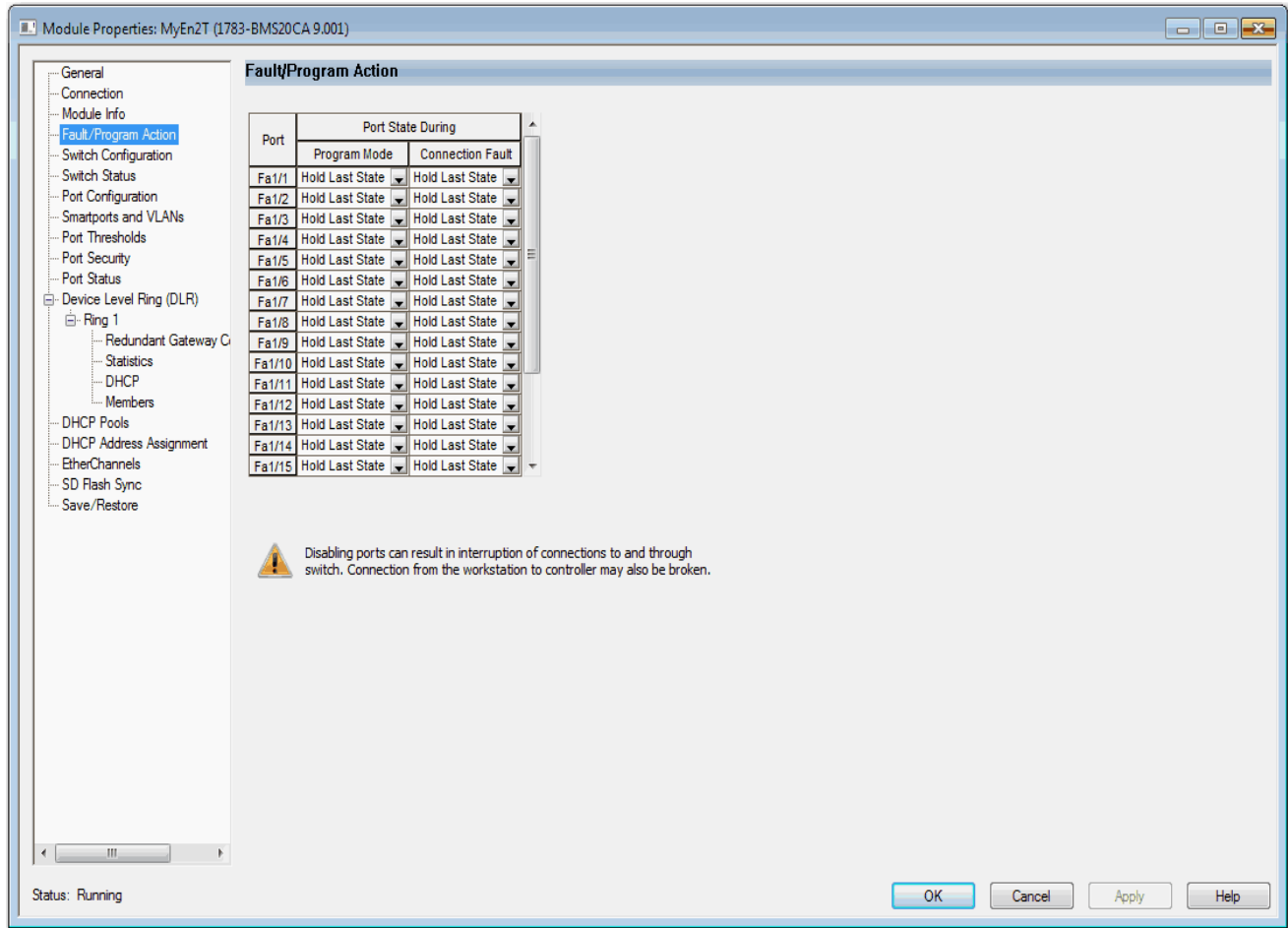

**Table 21 - Fault/Program Action Fields**

Field	Description
Port	Displays the port type and port number: <ul style="list-style-type: none"> <li>• Fa—Fast Ethernet</li> <li>• Gi—Gigabit Ethernet</li> <li>• Te—10 Gigabit Ethernet</li> </ul>
Program Mode	Choose what happens at the port when the controller transitions to Program mode: <ul style="list-style-type: none"> <li>• Hold Last State—The port maintains the current state.</li> <li>• Disable—The port is disabled.</li> <li>• Enable—The port is enabled.</li> </ul> The default is Hold Last State.
Connection Fault	Choose what happens at the port when communication is lost between the controller and the switch: <ul style="list-style-type: none"> <li>• Hold Last State—The port maintains the current state.</li> <li>• Disable—The port is disabled.</li> <li>• Enable—The port is enabled.</li> </ul> The default is Hold Last State.

## User Administration via Device Manager

You can add, modify, or delete users and user login information for the switch via Device Manager.

From the Admin menu, choose Users.

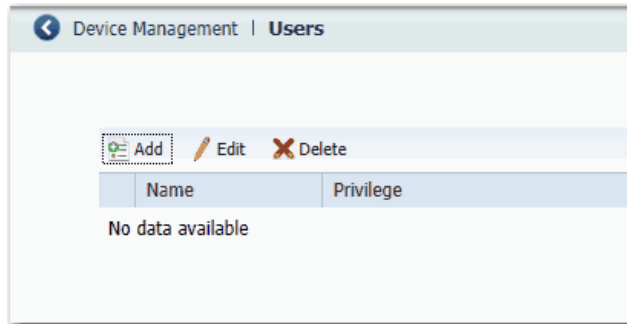

For each user, you can specify the information in [Table 22](#).

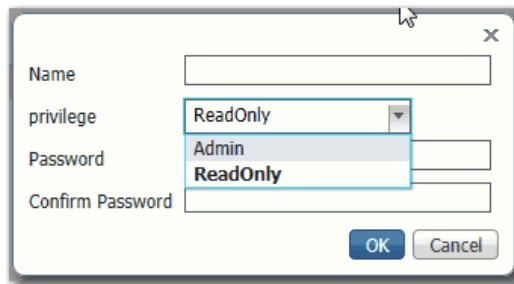

**Table 22 - Add User Fields**

Field	Description
Name	A unique user name. The user name cannot contain spaces.
Privilege	The level of access for the user: <ul style="list-style-type: none"> <li>Admin—Users can view and change all switch parameters.</li> <li>ReadOnly—Users can only view switch status and monitoring information. Users cannot view configuration information, view administration information, or make any changes to the switch.</li> </ul>
Password, Confirm Password	The password that is required for access with this user name.

## Configuration Files

The switch configuration files (config.text and vlan.dat) are in ASCII human-readable format. This configuration file is stored in nonvolatile memory and is read into the random access memory (RAM) of the switch as the running configuration when the switch is powered up. When any changes are made to the configuration, the changes immediately take effect in the running configuration. Device Manager and the Logix Designer application automatically save changes to internal memory to be retained for the next power-up cycle. Any changes that are made via the CLI must be manually saved in internal memory to be retained for the next power-up cycle.

### Manage Configuration Files via Device Manager

From the Admin menu, choose Load/Save and then do one of the following:

- To copy a configuration file from a file on another device to the internal memory, do the following:
  - a. Enter the directory name of the folder on the switch.
  - b. Browse to select the file.
  - c. Click Upload.
- To download a configuration file from the internal memory to your computer, right-click the link and choose Save Link As.

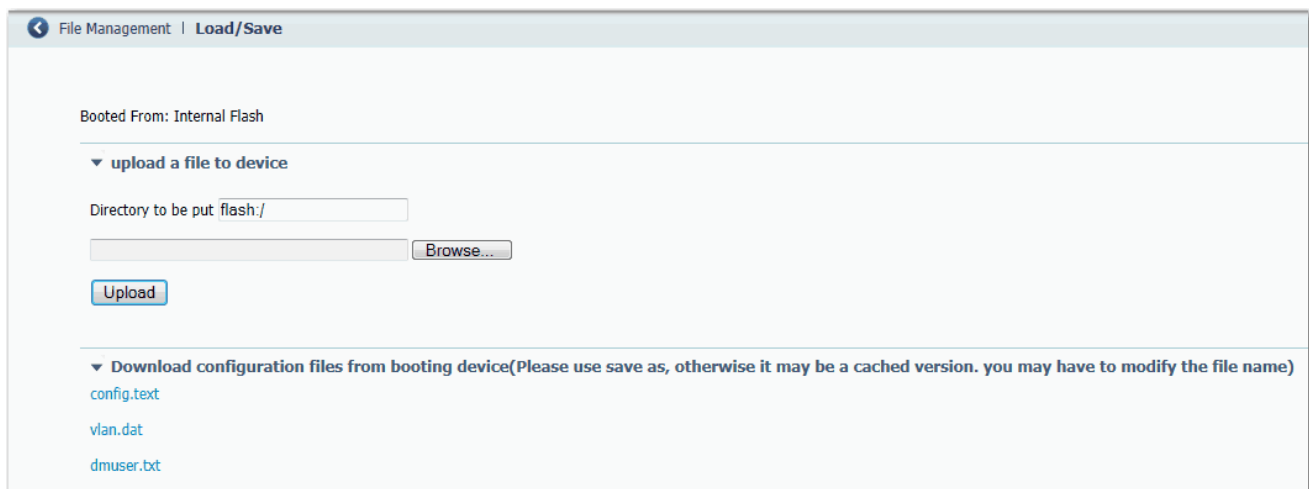

## Manage Configuration Files via the Logix Designer Application

You can do the following:

- Save the switch configuration to a file for archiving
- Restore a switch configuration that is stored locally on the computer or within the Logix Designer application project.

To save and restore a switch configuration, be prepared to enter a valid switch password.

In the navigation pane, click Save/Restore.

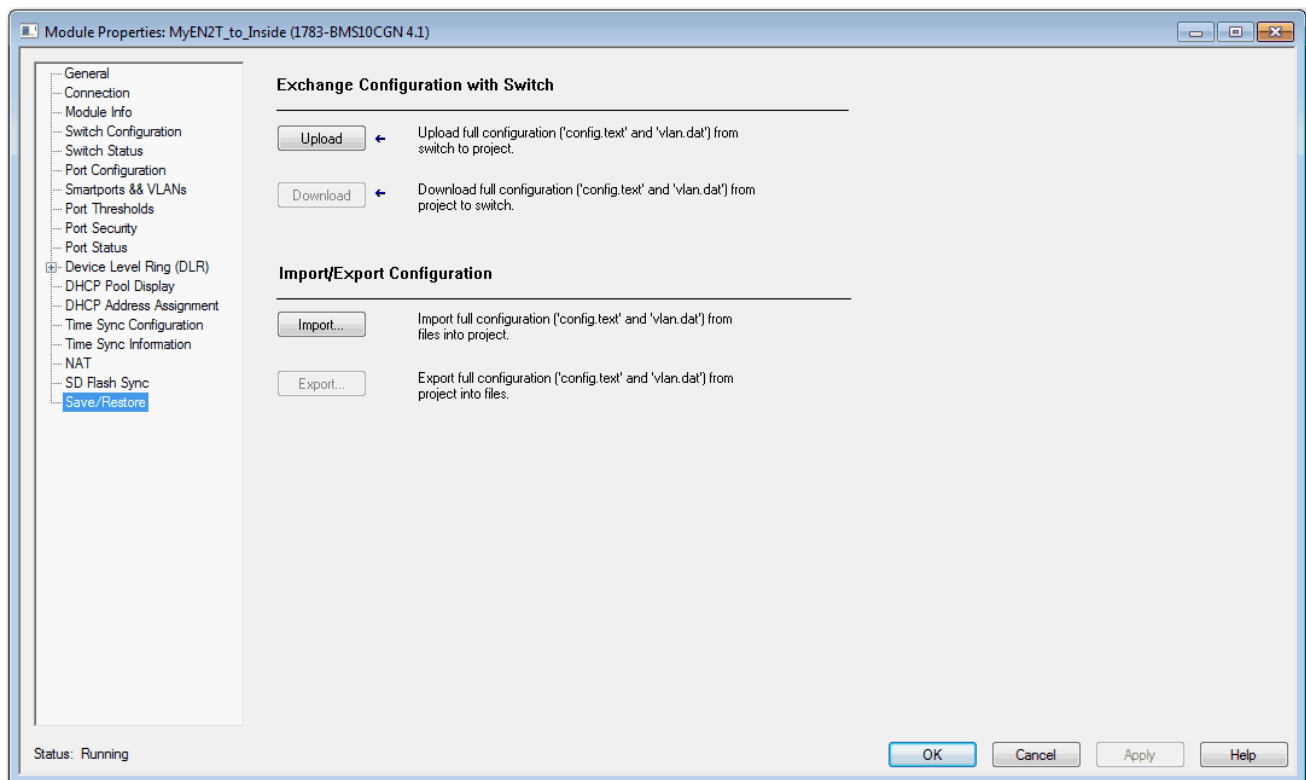

The switch configuration consists of these two files:

- Text file with configuration parameters
- Binary file with VLAN information

Once the switch configuration is uploaded to the project file in the Logix Designer application, the switch configuration can be exported as computer files by using the Export button.

You can import a switch configuration from the appropriate files on your computer to the project by using the Import button on the Save/Restore view. You can then download the configuration to the switch by using the Download button.



## Secure Digital (SD) Card

The following switches can store their configuration in an SD card or internal memory:

- Stratix 5700 and ArmorStratix 5700 switches have a slot for an optional SD card. You must use the 1784-SD1 card available from Rockwell Automation with the switches.
- Stratix 5400 and Stratix 5410 switches ship with an SD card, which stores the initial configuration and firmware for the switches.



**ATTENTION:** If a non-Rockwell Automation SD card is used in Stratix switches, Rockwell Automation reserves the right to withhold support.

---

You can use the SD card instead of internal memory to do the following:

- Restore a switch configuration in case of failure.
- Duplicate configurations when you are deploying a new network.
- Synchronize the initial configuration and firmware of a switch to internal memory.

In general, the start method for the switch becomes the source for any changes you make to the configuration. For example, if you start from the SD card, any changes you make are saved to the SD card. If you start the switch from internal memory, even if you insert an SD card while starting the system, changes are saved to internal memory.

You can use Device Manager or the Logix Designer application to synchronize the SD card for configuration and IOS updates. The configuration synchronization process synchronizes configuration files from the source to the destination. If other files, such as back-up configurations, are present on the SD card, they are not synchronized.



**ATTENTION:** When synchronizing, be aware of your startup source, so that you know which way to synchronize. Device Manager provides this information on the Manual Sync tab. If you synchronize in the wrong direction, you can overwrite your desired configuration.

---

If you start the switch from the SD card and then remove it while the switch is running, the following conditions apply:

- Device Manager is no longer accessible.
- Changes that are made by using the CLI or the Logix Designer application take effect, but are not saved when the switch is restarted.
- If you reinsert the SD card into the slot, changes are not saved to the card unless new changes are made. Then the entire configuration is saved to the card.



**ATTENTION:** SD cards commonly have a physical read-only lock switch. If the lock switch is engaged, the switch starts from the SD card successfully. Changes that are made by using the CLI, AOP, or Device Manager take effect, but are not saved when the switch is restarted.

---

## Synchronize the SD Card via Device Manager

In Device Manager, you can use the Sync page to display SD card and sync status and to synchronize files.

To enable manual sync or automated sync, from the Admin menu, choose Sync:

- For manual synchronization options, click the Manual Sync tab.
- For auto synchronization options, click the Auto Sync tab.

File Management | Sync

Manual Sync
Auto Sync

**▼ SD Card Status:**

Card Present: ✔ Yes

Card Status: Card File(s) Not Present

Booted From: Internal Flash

**▼ Sync Status:**

Config File: ✘ No

IOS Image: ✘ No

**▼ SD to Flash Sync:**

SD Card
Onboard Flash

Synchronize Configuration from SD Card to Onboard Flash

Synchronize IOS Image from SD Card to Onboard Flash (May take up to five minutes)

**▼ Flash to SD Sync:**

Onboard Flash
SD Card

Synchronize Configuration from Onboard Flash to SD Card

Synchronize IOS Image from Onboard Flash to SD Card (May take up to five minutes)

Submit

**Table 23 - Manual Sync Fields**

Field	Description
SD Card Status	Displays whether an SD card is present and whether the switch was started from the SD card.
Sync Status	Displays whether the configuration and firmware image files are synchronized.
SD to Flash Sync	Click whether to synchronize the configuration or the firmware image from the SD card to the internal memory of the switch.
Flash to SD Sync	Click whether to synchronize the configuration or the firmware image from the internal memory of the switch to the SD card.

As of IOS 15.2(6)E1 and later, Device Manager provides new auto sync options for Stratix 5700 and ArmorStratix 5700 switches, as shown in the following figure. These options are not mutually exclusive. You can enable one or all auto sync options as described in [Table 24](#). If all options on the Auto Sync tab are disabled, then synchronization only occurs manually when you submit an option on the Manual Sync tab.

You can use the Auto Sync at Reboot option to copy a configuration and firmware image from an SD card onto multiple switches without using Device Manager Express Setup. The configuration and firmware image on the SD card automatically syncs with internal memory after startup.

When you update a Stratix 5700 or ArmorStratix 5700 switch with IOS 15.2(6)E1 or later, the synchronization options that were configured in the earlier version are retained in IOS 15.2(6)E1 and later.

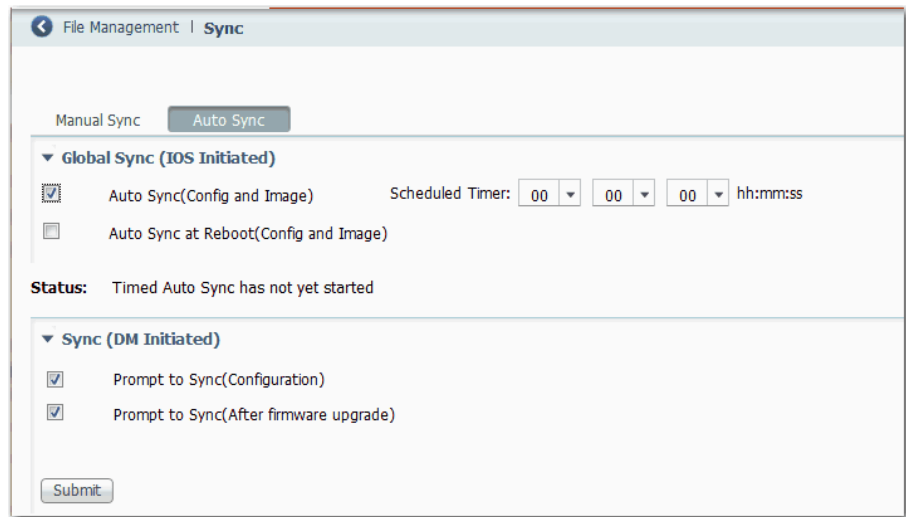
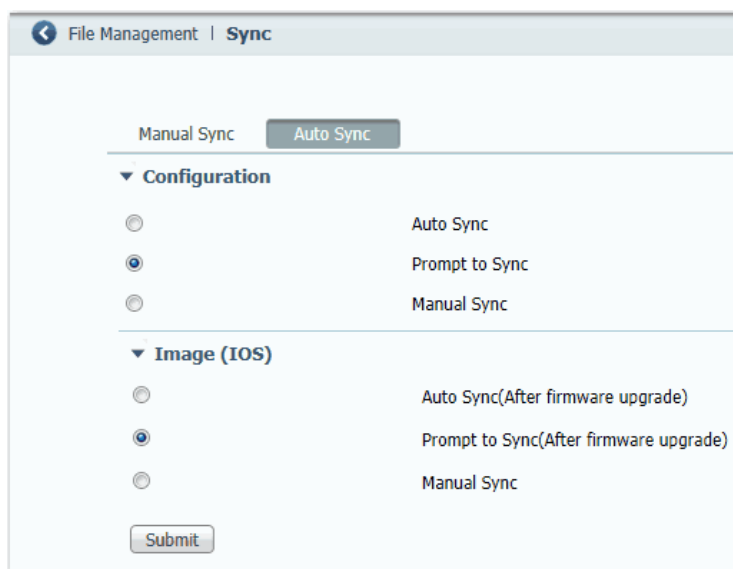

**Table 24 - Auto Sync Fields for Stratix 5700 and ArmorStratix 5700 Switches**

Field	Description
<b>Global Sync (IOS Initiated)</b>	
Auto Sync (Config and Image)	If your start up source is the SD card, the switch copies the configuration and firmware image from the SD card to the internal memory at a specified time every day. or If your startup source is the internal memory of the switch, the switch copies the configuration and firmware image from the internal memory to the SD card at a specified time every day. During the auto sync process, the Express Setup status indicator on the switch flashes red.
Scheduled Timer	Specify the time to initiate Auto Sync every day. If you do not specify a time and Auto Sync (Config and Image) is enabled, synchronization defaults to midnight every day. This field appears only when you check Auto Sync (Config and Image). <b>IMPORTANT:</b> If Network Time Protocol (NTP) is not enabled on the switch, be aware of the following: <ul style="list-style-type: none"> <li>The scheduled timer resets to zero if the switch restarts. Until you specify a time, the auto sync time defaults to midnight.</li> <li>Without NTP as a time source, the switch uses its internal clock. To set the internal clock on the switch, use the CLI.</li> </ul>
Auto Sync at Reboot (Config and Image)	If your startup source is the SD card, the switch copies the configuration and firmware image from the SD card to the internal memory whenever the switch restarts. or If your startup source is the internal memory of the switch, the switch copies the configuration and firmware image from the internal memory to the SD card whenever the switch restarts. During the auto sync process, the Express Setup status indicator on the switch flashes red.

**Table 24 - Auto Sync Fields for Stratix 5700 and ArmorStratix 5700 Switches**

Field	Description
Status	The status of the scheduled auto sync.
<b>Sync (DM Initiated)</b>	
Prompt to Sync (Configuration)	Device Manager prompts you to synchronize the SD card and internal memory after a configuration change.
Prompt to Sync (After firmware upgrade)	Device Manager prompts you to synchronize the SD card and internal memory after a firmware upgrade.

**Table 25 - Auto Sync Fields for Stratix 5400 and 5410 Switches**

Field	Description
<b>Configuration</b>	
Auto Sync	Automatically synchronizes the configuration when a configuration change is made in Device Manager. Auto Sync is the default configuration.
Prompt to Sync	After a configuration change, a message prompts you to confirm the synchronization.
Manual Sync	No synchronization occurs on a configuration change unless it is done manually.
<b>Image (IOS)</b>	
Auto Sync (After firmware update)	Automatically sync the changed configuration when firmware is upgraded.
Prompt to Sync (After firmware update)	After firmware is upgraded, a message prompts you to confirm the configuration. Prompt to Sync is the default configuration.
Manual Sync	No synchronization occurs after firmware is upgraded unless it is done manually.

## Synchronize the SD Card via the Logix Designer Application

You can synchronize the SD card to either the configuration file or the entire firmware image.

In the navigation pane, click SD Flash Sync.

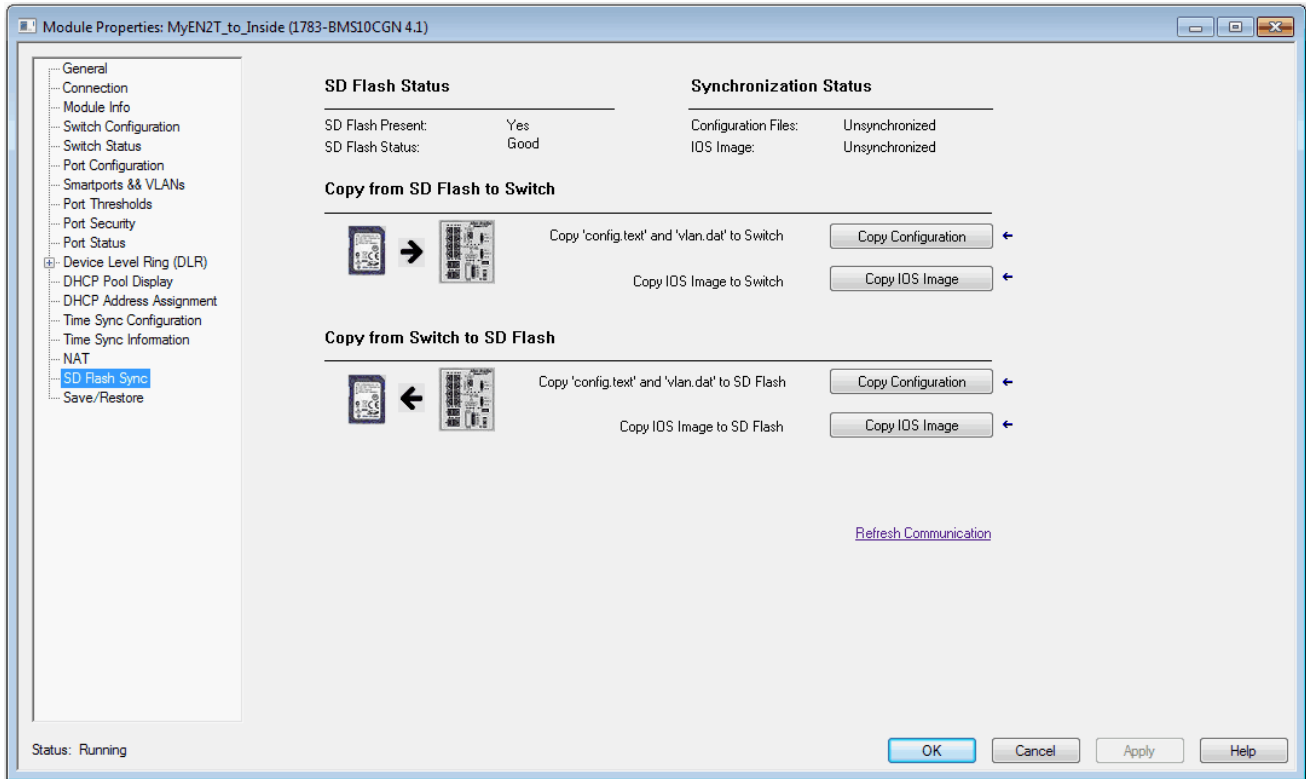

**Table 26 - SD Flash Sync Fields**

Field	Description
SD Flash Status	Indicates whether the SD card is present and the status. of the card
Synchronization Status	Indicates whether the configuration files and the IOS are synchronized or unsynchronized.
Copy from SD Flash to Switch	Choose from these options: <ul style="list-style-type: none"> <li>• Copy Configuration</li> <li>• Copy IOS Image</li> </ul>
Copy from Switch to SD Flash	Choose from these options: <ul style="list-style-type: none"> <li>• Copy Configuration</li> <li>• Copy IOS Image</li> </ul>

## CompactFlash Memory Card

The CompactFlash card for Stratix 8000/8300 switches contains the switch IOS operating system, Device Manager firmware, and user-defined configuration settings. Without the CompactFlash card, the switch cannot power up or restart.

If you remove the card with the switch running, the switch continues to function. However, Device Manager is no longer available.

If you change the switch configuration after the card is removed, the changes are applied and used by the switch. However, the changes are not saved. If you insert the CompactFlash card later, the previous changes are still not saved to the card. Only changes that are made while the card is inserted are saved.

Each time a change is made with the card installed, both Device Manager and the Logix Designer application save the entire running configuration to the card.

## Firmware Updates

You can download firmware for all switches from <http://www.rockwellautomation.com>.

From Device Manager, you can apply firmware updates to switches one at a time. From the Admin menu, choose Software Update.

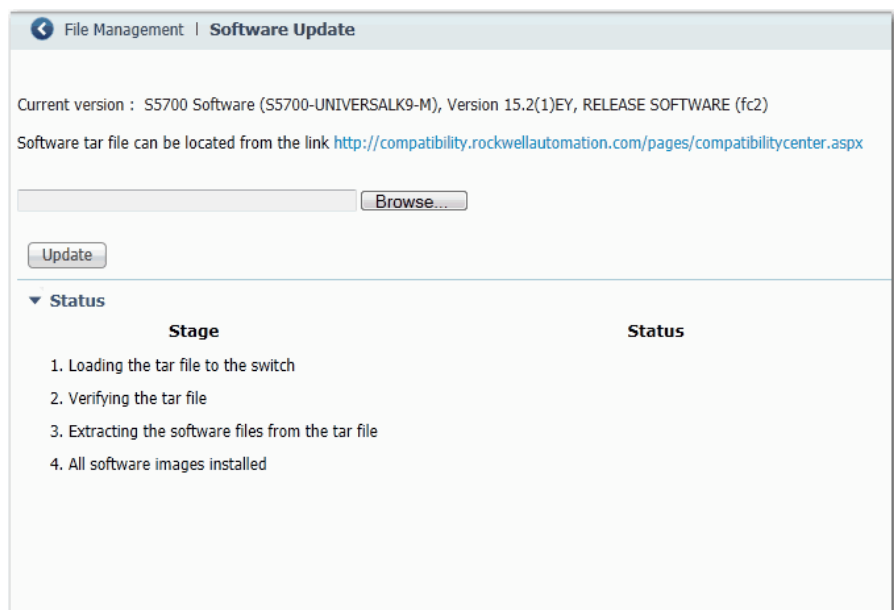

With firmware revision 2.001 or later, the firmware is installed to the running nonvolatile memory location:

- If you start the switch with the SD card inserted, the firmware is installed on the SD card.
- If you start the switch from internal memory without the SD card inserted, the firmware is installed in the internal memory.

---

**IMPORTANT** Wait for the update process to complete. Do not use or close the browser session with Device Manager active. Do not access Device Manager from another browser session.

---

When the update process completes, a success message appears, and the switch automatically restarts. It can take a few minutes for the switch to restart with the new firmware.

Verify that the latest firmware revision on the switch appears in the Software field in the Switch Information area of the dashboard.

For more information, see the online help for Device Manager.

## Cisco Network Assistant

Cisco Network Assistant is a web interface that you download from Cisco's website and run on your computer. It offers advanced options for configuring and monitoring multiple devices, including switches, switch clusters, switch stacks, routers, and access points.

Follow these steps to use the software.

1. Go to <http://www.cisco.com/go/NetworkAssistant>.

You must be a registered user, but you need no other access privileges.

2. Find the Network Assistant installer.
3. Download the Network Assistant installer, and run it.

You can run it directly from the web if your browser offers this choice.

4. When you run the installer, follow the displayed instructions.
5. In the final panel, click Finish to complete the Network Assistant installation.

For more information, see the online help for Network Assistant.



## Command-line Interface

Apart from Device Manager and the Logix Designer application, you can manage the switch from the Cisco IOS command-line interface (CLI). This interface enables you to execute Cisco IOS commands by using a router console or terminal or by using remote access methods.

You can use the following connection methods:

- Connect directly to the switch console port
- Enable Secure Shell (SSH) or Telnet in Device Manager

For more information about using the CLI, refer to [www.cisco.com](http://www.cisco.com).

### Connect to the Console Port

1. Connect to the console port in one of these ways:
  - To connect to the standard 9-pin serial port on a computer, use an RJ45-to-DB-9 adapter cable.
  - (Stratix 5400, 5410, 5700, and ArmorStratix 5700 switches). Use a standard mini-USB cable to connect to the mini-USB port on a computer. If you use the USB cable, download the drivers from <http://www.rockwellautomation.com>.
2. Connect the other end of the cable to the console port on the switch.
3. Start a terminal-emulation program on the computer.
4. Configure the computer terminal emulation software for 9600 bps, eight data bits, no parity, one stop bit, and no flow control.

## Enable SSH or Telnet in Device Manager

SSH provides a secure, remote connection to the switch. SSH provides more security for remote connections than Telnet by providing strong encryption.

---

**IMPORTANT** For secure network access, we recommend that you do not use Telnet. For new switch configurations with IOS release 15.2(5)EA.fc4 and later, Telnet is disabled by default. For information about default settings after an upgrade, see [page 103](#).

---

1. From the Admin menu, choose Access Management.
2. To allow Secure Shell (SSH) sessions on the switch, check Enable SSH.
3. To allow Telnet sessions on the switch, check Enable Telnet.
4. Click Submit.

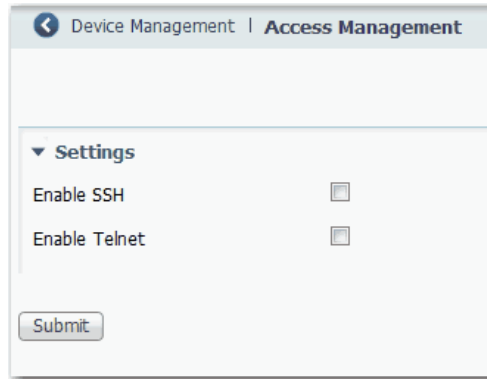

## Configure Switch Features

Topic	Page
Access Control Lists (ACLs)	76
Alarms	81
CIP Sync Time Synchronization (Precision Time Protocol)	86
Cryptographic IOS	103
Device Level Ring (DLR) Topology	104
Dynamic Host Configuration Protocol (DHCP) Persistence	131
Enhanced Interior Gateway Routing Protocol (EIGRP)	140
EtherChannels	146
Feature Mode	153
Global Navigation Satellite System (GNSS)	154
High-availability Seamless Redundancy (HSR)	156
Horizontal Stacking	157
Internet Group Management Protocol (IGMP) Snooping with Querier	159
Maximum Transmission Unit (MTU)	161
Motion Prioritized QoS Macros	162
NetFlow	163
Network Address Translation (NAT)	167
Network Time Protocol (NTP)	208
Open Shortest Path First (OSPF) Routing Protocol	212
Parallel Redundancy Protocol (PRP)	219
Port Mirroring	225
Port Security	227
Port Thresholds	233
Power over Ethernet (PoE)	238
PROFINET	249
Resilient Ethernet Protocol (REP)	255
Routing, Layer 3	260
Routing, Static and Connected	262
Simple Network Management Protocol (SNMP)	265
Smartports	268
Spanning Tree Protocol (STP)	278
Virtual Local Area Networks (VLANs)	283
VLAN 0 Priority Tagging	286

This chapter describes software features that you can configure via Device Manager, the Studio 5000 Logix Designer® application, or both. More software features are available. You can configure some features with the global macro or Smartports feature.

For information about how to configure features not available in Device Manager or the Logix Designer application, see the documentation available at <http://www.Cisco.com>.

Some features are available only on select switch models and firmware types. See [Stratix 5700 Lite Versus Full Firmware Features on page 15](#) and [Software Features on page 16](#).

## Access Control Lists (ACLs)

ACLs, also called access lists, filter traffic as it passes through the switch. ACLs permit or deny packets as they cross specified interfaces or VLANs. You configure ACLs on switches with Layer 2 or Layer 3 firmware to provide basic security for your network. If you do not configure ACLs, all packets that pass through the switch can be allowed onto all parts of the network. You can use ACLs to control which hosts can access different parts of a network or to decide which types of traffic are forwarded or blocked at router interfaces.

An ACL contains an ordered list of access control entries (ACEs). Each ACE specifies whether to permit or deny packets. An ACE also specifies a set of conditions a packet must satisfy to match the ACE. The meaning of permit or deny depends on the context in which the ACL is used.

When a packet is received on a port, the switch compares the fields in the packet against any ACLs applied to the port. Based on the criteria in the ACL, the switch determines whether the packet has the required conditions to be forwarded. One by one, it tests packets against the conditions in an ACL. The first match decides whether the switch accepts or rejects the packets. Because the switch stops testing after the first match, the order of conditions in the list is critical. If no conditions match, the switch rejects the packet. If there are no restrictions, the switch forwards the packet. Otherwise, the switch drops the packet.

## Configure ACLs via Device Manager

The ACL page shows the standard and extended ACLs defined on the switch. Once you add an ACL to the ACL List tab, you can apply it to a port and specify a direction on the Apply ACL tab.

To configure an ACL, from the Configure menu, choose ACL.

ACL Name/Number	Description	Type	Interface/Direction	Number of Statements
<input type="checkbox"/> 10		Standard IP		3
<input type="checkbox"/> AllTraffic		Standard IP		1
<input type="checkbox"/> DenyTraffic		Standard IP		1

### Create an ACL

1. From the ACL page, click the ACL List tab.
2. Click Add and complete the fields in the header area.

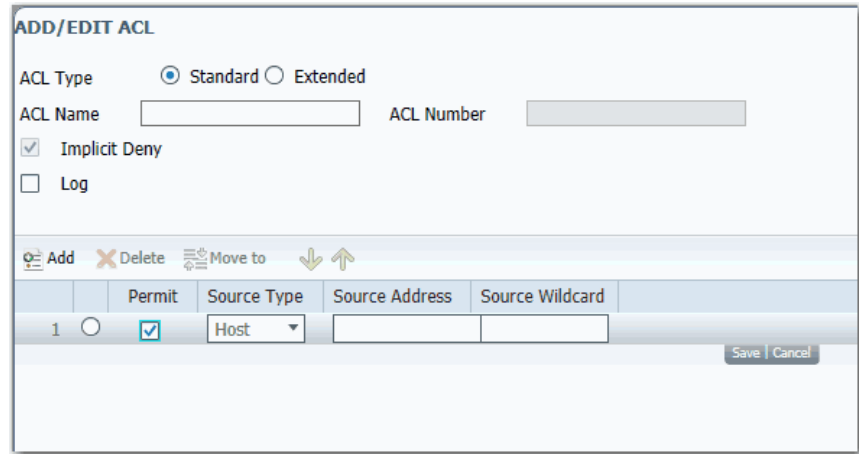

Field	Description
ACL Type	Click Standard or Extended: <ul style="list-style-type: none"> <li>Standard (default)—Uses source addresses.</li> <li>Extended—Uses source and destination addresses and optional protocol type information.</li> </ul>
ACL Name	Type an alphanumeric name to identify the ACL. Named access lists are more convenient than numbered access lists because you can specify a meaningful name that is easier to remember and associate with a task. You can reorder statements in or add statements to a named access list.
ACL Number	The number of the ACL, which shows the type of access list: <ul style="list-style-type: none"> <li>1...99—IP standard access list.</li> <li>100...199—IP extended access list.</li> <li>1300...1999—IP standard access list (expanded range).</li> <li>2000...2699—IP extended access list (expanded range).</li> </ul>
Implicit Deny	(Not editable). By default, all ACLs have an implicit deny statement at the end. If a packet does not match any of the criteria that are specified in the ACL, it is denied.
Log	Check the checkbox to enable informational logging messages about packets that are permitted or denied by an ACL to be sent to the system log. To view the system log, from the Monitor menu, choose Syslog.

3. To define the ACL entry, click Add in the table area, and then complete the fields.

Field	Description
Permit	To permit traffic, check the checkbox. To deny traffic, clear the checkbox. An access list must contain at least one permit statement or all packets are denied entry into the network.
Protocol	(Extended ACL only). Type the following: <ul style="list-style-type: none"> <li>The name or number of an IP protocol (AHP, EIGRP, ESP, GRE, ICMP, IGMP, IGRP, IP, IPINIP, NOS, OSPF, PCP, PIM, TCP, or UDP)</li> <li>or</li> <li>An integer in the range of 0...255 representing an IP protocol number</li> </ul> To match any Internet Protocol, including ICMP, TCP, and UDP, type IP.
Source Type	Choose the source from which the packet is sent: <ul style="list-style-type: none"> <li>Host</li> <li>Any</li> <li>Network</li> </ul>
Source Address	Type the address of the network or host from which the packet is sent.
Source Wildcard	Type an ACL mask for the source.
Source Operator	(Extended ACL only). To compare the source, choose an operator from the pull-down menu.
Source Port	(Extended ACL only). Type the source port number to compare. Valid values: 0...65535

Destination Type	(Extended ACL only). Choose the type of the destination to which the packet is sent: <ul style="list-style-type: none"> <li>• Host</li> <li>• Any</li> <li>• Network</li> </ul>
Dest Address	(Extended ACL only). Type the network or host number to which the packet is sent.
Dest Wildcard	(Extended ACL only). Type an ACL mask for the destination.
Dest Operator	(Extended ACL only). To compare the destination, choose an operator from the pull-down menu.
Dest Port	(Extended ACL only). Type the destination port number to compare. Valid values: 0...65535

4. Click Save.
5. Repeat Steps 3 and 4 to create as many conditions as needed.
6. To order the conditions in the list, use the Move buttons

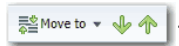

**IMPORTANT** The order of the conditions is critical to whether a packet is forwarded. The first condition in the list that matches a packet allows the packet to be forwarded. After the first match, the switch stops testing.

7. Click Submit.

*Apply an ACL to a Port*

You can apply inbound and outbound ACLs to ports:

- Inbound ACLs can be applied to any port.
- Outbound ACLs can be applied to only routed ports or ports assigned to an Access VLAN. You can configure these port settings in the Administrative Mode field on the Edit Physical Port page. For more information about configuring port settings, see [page 59](#).

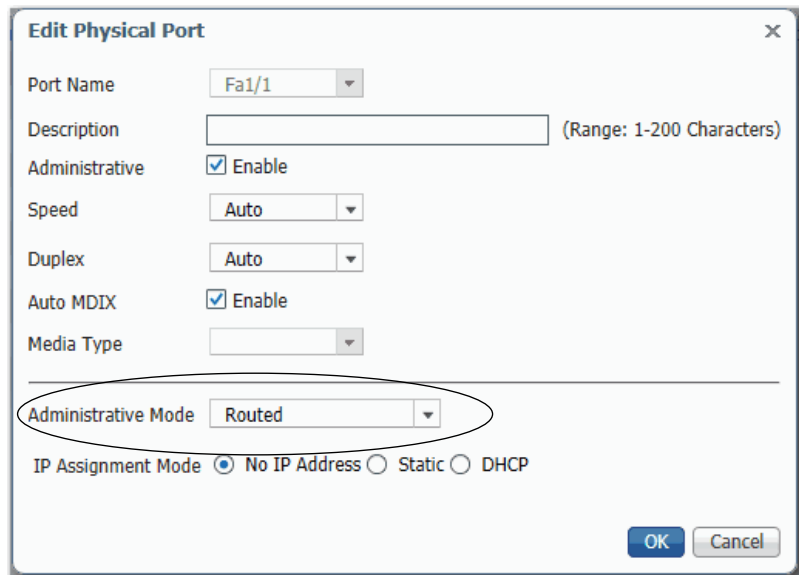

1. From the ACL page, click the Apply ACL tab.

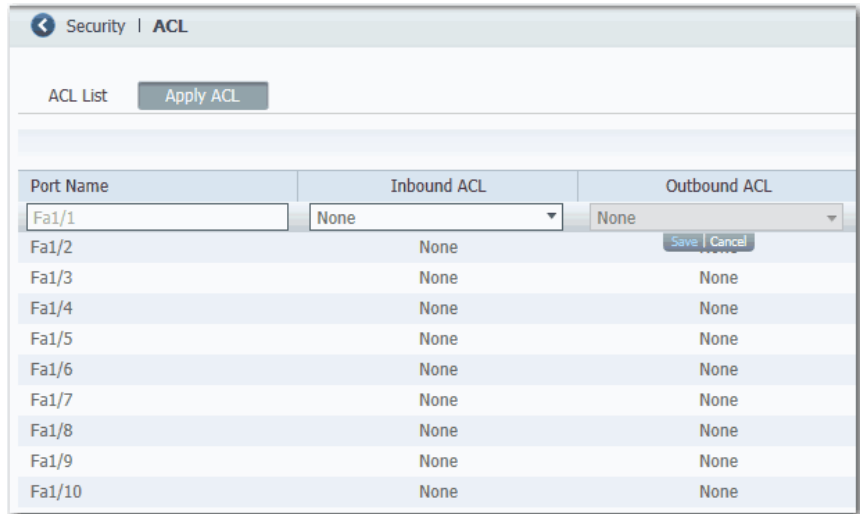

2. Click the row for a port name.
3. In the Inbound ACL column, choose the ACL from the list of configured ACLs.
4. In the Outbound ACL column, choose ACL from the list of configured ACLs.
5. Click Save.



## Alarms

Alarms vary by switch model.

Switch	Alarm Description
Stratix® 5400 switch	<p>The switch lets you connect two alarm inputs from external devices, such as a door or temperature gauge, to the alarm input port on the front panel of the switch.</p> <p>An over- or under-temperature alarm or a port not forwarding condition automatically triggers the default output. You can configure the output alarm relay as either normally energized or de-energized.</p>
Stratix 5410 switch	<p>The switch provides the following external alarms:</p> <ul style="list-style-type: none"> <li>• Four alarm inputs to sense whether the alarm setting is open or closed. The alarm input is a dry-contact alarm port. You can connect up to four alarm inputs from devices, such as a door, a temperature gauge, or a fire alarm to the alarm port. An alarm generates a system message and turns on an alarm status indicator.</li> <li>• One alarm output that you can configure as a minor or major alarm. Output alarms often control an external alarm, such as a bell or a light. To connect an external alarm device to the relay, you connect two relay contact wires to complete the electrical circuit.</li> </ul> <p>The front panel alarm port uses an RJ45 connector.</p>
Stratix 5700 switch	<p>The switch lets you connect two alarm inputs from external devices, such as a door or temperature gauge, to the alarm input port on the front panel of the switch.</p> <p>An over- or under-temperature alarm or a port not forwarding condition automatically triggers the default output. You can configure the output alarm relay as either normally energized or de-energized.</p>
ArmorStratix™ 5700 switch	<p>The switch provides the following external alarms:</p> <ul style="list-style-type: none"> <li>• One input alarm relay circuit to sense whether the alarm input is open or closed relative to the alarm input reference pin.</li> <li>• One output alarm relay circuit with one Form C (single-pole, double-throw) relay with one normally open (N.O.) and one normally closed (N.C.) contact. You can configure the output alarm as either normally energized or normally de-energized.</li> </ul>
Stratix 8000/8300 switch	<p>The switches provide the following on the front panel:</p> <ul style="list-style-type: none"> <li>• Major alarm relay—When closed, the major alarm relay indicates a dual-mode power supply or primary temperature alarm.</li> <li>• Minor alarm relay—When closed, the minor alarm relay indicates these alarm states: <ul style="list-style-type: none"> <li>– Link fault</li> <li>– Port not forwarding</li> <li>– Port not operating</li> <li>– Frame Check Sequence (FCS) bit error rate</li> </ul> </li> </ul>

## Configure Alarms via Device Manager

The switch software monitors conditions on a per port or a global basis. If a condition does not match its parameters, the switch triggers an alarm or system message. By default, the switch sends the system messages to the Syslog. You can configure the switch to send SNMP traps to an SNMP server. You can also configure the switch to trigger an external alarm device by using the two independent alarm relays.

### Alarm Relay Settings

You can configure the switch to trigger an external alarm device. The switch software is configured to detect faults that are used to energize the relay coil and change the state on both of the relay contacts. Normally open contacts close and normally closed contacts open.

To configure alarm relay settings, from the Configure menu, choose Alarm Settings.

On the Alarm Relay Setup tab, click one of these options for each type of alarm relay:

- Normally Opened—The normal condition is that no current flows through the contact. The alarm is generated when current flows.
- Normally Closed—The normal condition has current that flows through the contact. The alarm is generated when the current stops flowing.

	Global	Port
Output Relay	<input type="radio"/> Normally Opened	<input checked="" type="radio"/> Normally Closed
Input Relay1	<input type="radio"/> Normally Opened	<input checked="" type="radio"/> Normally Closed
Input Relay2	<input type="radio"/> Normally Opened	<input checked="" type="radio"/> Normally Closed

Submit

### Global Alarms

From the Configure menu, choose Alarm Settings and click the Global tab.

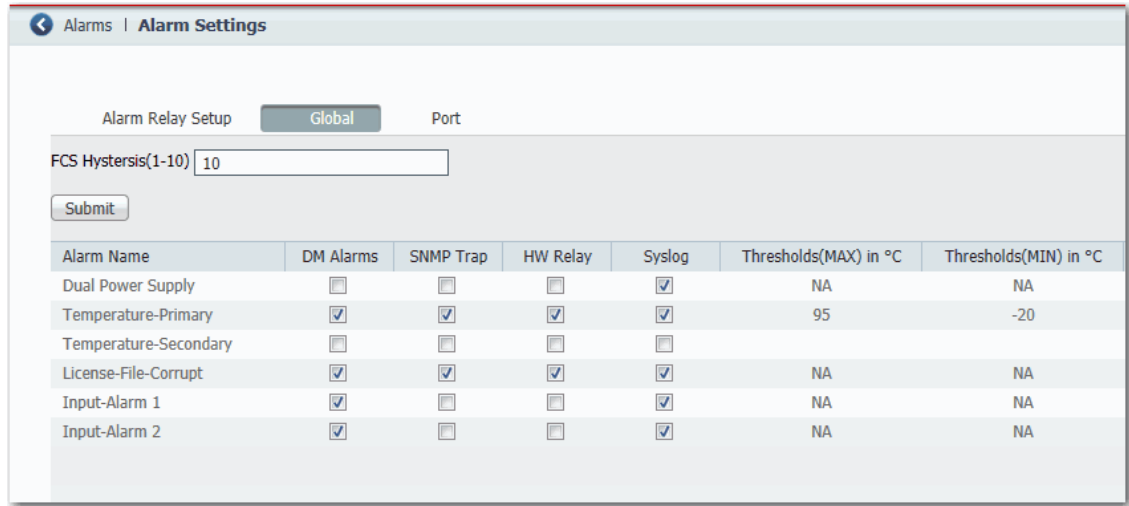

**Table 27 - Global Tab Fields**

Field	Description
FCS Hysteresis (1-10)	The frame check sequence (FCS) error hysteresis threshold determines when an alarm condition is cleared. This value is expressed as a percentage of fluctuation from the FCS bit error rate. The default global setting is 10 percent. You can adjust the percentage to help prevent toggling the alarm condition when the FCS bit error rate fluctuates near the configured bit error rate. Valid percentages for global settings are 1 . . . 10. This setting can also be configured on an individual port by clicking the Port tab.
Alarm Name	These types of alarms can be enabled or disabled on a global level: <ul style="list-style-type: none"> <li>• Dual Power Supply—The switch monitors DC power supply levels. If the system is configured to operate in a dual power mode, an alarm is triggered if a power supply fails or is missing. The alarm is automatically cleared when the power supplies are present or working. You can configure the power supply alarm to be connected to the hardware relays.</li> <li>• Temperature-Primary—An alarm is triggered when the system temperature is higher or lower than the configured thresholds. By default, the primary temperature alarm is associated with the major relay.</li> <li>• Temperature-Secondary— An alarm is triggered when the system temperature is higher or lower than the configured thresholds.</li> <li>• License-File-Corrupt—An alarm is triggered when the license file is corrupt.</li> <li>• Input-Alarm 1—An alarm is triggered based on an external input alarm.</li> <li>• Input-Alarm 2—An alarm is triggered based on an external input alarm.</li> </ul>
DM Alarms	Alarm information appears on the dashboard of Device Manager.
SNMP Trap	Alarm traps are sent to an SNMP server, if SNMP is enabled on the Configure > Security > SNMP page.
HW Relay	If the alarm relay is triggered, the switch sends a fault signal to a connected external alarm device, such as a bell, light, or other signaling device.
Syslog	Alarm traps are recorded in the syslog. You can view the syslog on the Monitor > Syslog page.
Thresholds (MAX) in °C	The maximum temperature threshold for the corresponding Temperature-Primary or Temperature-Secondary alarm, if enabled.
Thresholds (MIN) in °C	The minimum temperature threshold for the corresponding Temperature-Primary or Temperature-Secondary alarm, if enabled.

### Port Alarms

From the Configure menu, choose Alarm Settings and click the Port tab.

Port Name	Alarm Profile	FCS Threshold(6-11)
Fa1/1	defaultPort	8
Fa1/2	defaultPort	8
Fa1/3	defaultPort	8
Fa1/4	defaultPort	8
Fa1/5	defaultPort	8
Fa1/6	defaultPort	8
Fa1/7	defaultPort	8

For each port, choose an Alarm Profile and set the FCS threshold. The frame check sequence (FCS) error hysteresis threshold is expressed as a percentage of fluctuation from the FCS bit error rate. The default port setting is 8 percent. You can adjust the percentage to help prevent toggling the alarm condition when the FCS bit error rate fluctuates near the configured bit error rate. Valid percentages for port settings are 6...11.

### Alarm Profiles

You can use alarm profiles to apply a group of alarm settings to multiple interfaces. These alarm profiles are created for you:

- defaultPort
- ab-alarm (created during Express Setup)

From the Configure menu, choose Alarm Profiles.

Profile Name
<input type="checkbox"/> defaultPort

On the Add/Edit Profile Instance page, you can configure the alarms and actions for an alarm profile.

**Table 28 - Add/Edit Profile Instance Fields**

Field	Description
Name	A unique name for the alarm profile.
Alarm Name	The alarm profile can include these alarms: <ul style="list-style-type: none"> <li>• Link Fault—The switch generates a Link Fault alarm when problems with the physical layer of a port cause unreliable data transmission. A typical Link Fault condition is loss of signal or clock. The Link Fault alarm is cleared automatically when the condition is cleared.</li> <li>• Port Not Forwarding—The switch generates a Port Not Forwarding alarm when a port is not forwarding packets. This alarm is cleared automatically when the port begins to forward packets.</li> <li>• Port Not Operating—The switch generates a Port Not Operating alarm when a port fails during the startup self-test. When triggered, the Port Not Operating alarm is only cleared when the switch is restarted and the port is operational.</li> <li>• Fcs Bit Error Rate—The switch generates an FCS Bit Error Rate alarm when the actual FCS bit error-rate is close to the configured rate.</li> </ul>
DM Alarms	Alarm information appears on the dashboard of Device Manager.
SNMP Trap	Alarm traps are sent to an SNMP server, if SNMP is enabled on the Configure > Security > SNMP page.
HW Relay	If the alarm relay is triggered, the switch sends a fault signal to a connected external alarm device, such as a bell, light, or other signaling device.
Syslog	Alarm traps are recorded in the Syslog. You can view the Syslog on the Monitor > Syslog page.

## CIP Sync Time Synchronization (Precision Time Protocol)

CIP Sync time synchronization refers to the IEEE 1588 standard for Precision Time Protocol (PTP). The protocol enables precise synchronization of clocks in measurement and control systems. Clocks are synchronized with nanosecond accuracy over the EtherNet/IP communication network. PTP enables systems that include clocks of various precisions, resolution, and stability to synchronize. PTP generates a master-slave relationship among the clocks in the system. All clocks ultimately derive their time from a clock that is selected as the Grandmaster clock.

By default, PTP is disabled on all Fast Ethernet and Gigabit Ethernet ports. You can enable or disable PTP on a per-port basis. For a list of switches that support PTP, see [page 16](#).

---

**IMPORTANT** To use PTP, be sure that the switch is using the PTP feature application profile as described on [page 153](#).

---

To configure PTP, you choose one of these clock modes:

- Boundary mode
- End to End Transparent mode
- Forward mode (default)
- NTP-PTP Clock mode

---

**IMPORTANT** In a PRP system, each switch configured as a RedBox must be in Boundary mode. Each infrastructure switch in LAN A and LAN B must be in End to End Transparent mode.

---

For more information about these modes, refer to the Converged Plantwide Ethernet Design and Implementation Guide, publication [ENET-TD001](#).

## Boundary Mode

In Boundary mode, the switch participates in selecting the best master clock. If the switch does not detect a better clock, the switch becomes the Grandmaster clock on the network and the parent clock to all connected devices. If the best master is determined to be a clock connected to the switch, the switch synchronizes to that clock as a child to the clock, and then acts as a parent clock to devices connected to other ports.

After initial synchronization, the switch and the connected devices exchange timing messages to correct time skew caused by clock offsets and network delays. This mode can reduce the effects of latency fluctuations. Because jitter and errors can accumulate in cascaded topologies, choose this mode only for networks with fewer than four layers of cascaded devices.

The clock selection process is determined in part by the relative priority of the switches in the network. You can define the priorities of switches in the Priority 1 and Priority 2 fields in either Device Manager or the Logix Designer application.

In Boundary mode, one or more switch ports can be PTP-enabled.

## End to End Transparent Mode

---

**IMPORTANT** End to End Transparent mode does not work with redundant gateways in a Device Level Ring (DLR) topology. For more information about redundant gateways, see [page 108](#).

---

In End to End Transparent mode, the switch transparently synchronizes all clocks with the master clock connected to it. All ports are enabled by default. This device corrects the delay incurred by every packet passing through it (referred to as residence time). This mode causes less jitter and error accumulation than Boundary mode.

In End to End Transparent mode, all switch ports are PTP-enabled by default.

## Forward Mode

In Forward mode, the switch passes PTP packets as normal multicast traffic. All switch ports are PTP-enabled by default. Forward mode is the default mode.

## NTP-PTP Clock Mode

NTP-PTP Clock mode is available in Stratix 5400 and 5410 switches. In NTP-PTP Clock mode, the switch functions as the Grandmaster clock and boundary clock:

- As Grandmaster, it uses PTP while deriving the time source from Network Time Protocol (NTP).
- If configured as a secondary Grandmaster, the switch functions as a boundary clock to forward time, making sure that all devices on the PTP network remain synchronized in a failover scenario.

---

**IMPORTANT** When changing PTP timing message settings, remember that the system does not operate properly unless all devices in the system have the same values.

---

NTP-PTP Clock mode enables tightly-controlled PTP zones, such as motion applications, to maintain time relative to other devices outside the PTP zone that use NTP. In this scenario, NTP-PTP clock time is beneficial for logging and event tracking.

Before you configure a switch to use NTP-PTP clock mode, do the following:

- Configure NTP as described on [page 208](#). While NTP-PTP Clock mode requires only one NTP time source, as a best practice, we recommend you configure two or more NTP time sources.
- Make sure the NTP clock is stable.
- Know the priority settings assigned to other PTP devices, so that you can set up the switch as the Grandmaster.



## Configure Time Synchronization via Device Manager

1. From the Configure menu, choose PTP.
2. From the Mode pull-down menu, choose a mode.

The modes and fields shown in the following figure vary based on the switch model and mode setting.

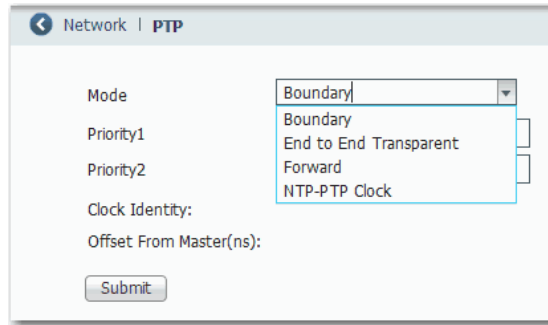

3. Complete the following fields, and then click Submit.

Field	Description
Priority 1	(Boundary or NTP-PTP Clock mode). Type a value to override the default criteria (clock quality, clock class, and so on) for the best master clock selection. A lower value takes precedence. Valid values: 0...255 Default: 128
Priority 2	(Boundary or NTP-PTP Clock mode). Type a value to use as a tie-breaker between two devices that are otherwise equally matched in the default criteria. For example, you can give a specific switch priority over other identical switches. A lower value takes precedence. Valid values: 0...255 Default: 128
Clock Identity	Displays a unique identifier for the clock.
Offset From Master (ns)	Displays the time offset in nanoseconds between the slave and master clocks.
Passthrough (Stratix 8000/8300 switches)	(Boundary or End to End Transparent mode). Check the checkbox to enable PTP pass-through processing. After PTP pass-through is enabled, all PTP messages are passed to and from the expansion module ports in the VLAN on which the packets are received. The PTP pass-through feature is not compatible with the virtual routing and forwarding (VRF), policy-based routing (PBR), and private virtual local area network (PVALN) features.

4. To complete the remaining fields, refer to the figure and table that corresponds to your mode.

Mode	Page
Boundary	90
End to End	92
Forward	94
NTP-PTP Clock	95

Figure 1 - Boundary Mode

Mode:

Priority1:

Priority2:

Clock Identity: 0xF4:54:33:FF:FE:0:8F:0

Offset From Master(ns): 0

---

**PTP Clock Settings**

PTP Device Type: Boundary clock

Number of PTP ports: 16

**Clock Quality:**

Class: 248

Accuracy: Unknown

Offset (log variance): N/A

Steps Removed: 0

Local clock time: 15:42:39 UTC Feb 10 2016

---

**PTP Time Property**

Current UTC offset valid: FALSE

Current UTC offset: 0

Time Source: Internal Oscillator

Time Property Persistence: 300 seconds

---

**Device Clock Details**

Device Time Source: hardware calendar

Device Clock Time: 15:42:38.843 UTC Wed Feb 10 2016

Port Name	State	Enable	Delay Request Interval	Announce Timeout	Announce Interval	Sync Interval	Sync Fault Limit	Vlan Id
Gi1/1	MASTER	<input checked="" type="checkbox"/>	5	3	1	0	500000000	100

Table 29 - Boundary Mode Fields

Field	Description
<b>PTP Clock Settings</b>	
PTP Device Type	Displays the PTP clock type of the switch, as determined by the Mode setting.
Number of PTP ports	Displays the number of ports assigned to the PTP clock.
Clock Quality	Displays a summary of the quality of the Grandmaster clock: <ul style="list-style-type: none"> <li>Class—Time and frequency traceability of the Grandmaster clock.</li> <li>Accuracy—Expected accuracy of the Grandmaster clock when the Best Master Clock algorithm is in use.</li> <li>Offset (log variance)— Offset between the local clock and an ideal reference clock.</li> </ul>
Steps Removed	Displays the number of hops from the local clock to the Grandmaster clock.
Local clock time	Displays the time stamp of the local clock.
<b>PTP Time Property</b>	
Current UTC offset valid	Indicates whether the current Coordinated Universal Time (UTC) offset is valid.
Current UTC offset	Displays the offset between the International Atomic Time (TAI) and UTC in seconds.

**Table 29 - Boundary Mode Fields (Continued)**

Field	Description
Time Source	Displays the time source used by the Grandmaster clock.
Time Property Persistence	Displays the number of seconds that time properties are preserved after a primary Grandmaster clock fails and a secondary Grandmaster clock takes over.
<b>Device Clock Details</b>	
Device Time Source	Displays the time source used by the switch.
Device Clock Time	Displays the time on the switch, obtained from the time source.
<b>Per Port Settings</b>	
Port Name	Displays the port type and port number: <ul style="list-style-type: none"> <li>• Fa—Fast Ethernet</li> <li>• Gi—Gigabit Ethernet</li> <li>• Te—10 Gigabit Ethernet</li> </ul>
State	Displays the synchronization state of the switch port with the parent or Grandmaster clock: <ul style="list-style-type: none"> <li>• Initializing—The switch port is waiting while a parent or Grandmaster clock is selected.</li> <li>• Listening—The switch port is waiting while a parent or Grandmaster clock is selected.</li> <li>• Pre-master—The switch port is transitioning to change to Master state.</li> <li>• Master—The switch is acting as a parent clock to the devices connected to that switch port.</li> <li>• Passive—The switch has detected a redundant path to a parent or Grandmaster clock. For example, two different switch ports claim the same parent or Grandmaster clock. To help prevent a loop in the network, one of the ports changes to Passive state.</li> <li>• Uncalibrated—The switch port cannot synchronize with the parent or Grandmaster clock.</li> <li>• Slave—The switch port is connected to and synchronizing with the parent or Grandmaster clock.</li> <li>• Faulty—Either PTP is not operating properly on the switch port or nothing is connected to the port.</li> <li>• Disabled—PTP is not enabled on the switch port.</li> </ul>
Enable	Check the checkbox for each port on which to enable PTP. You can enable one or more switch ports. By default, PTP is enabled on all the Fast Ethernet and Gigabit Ethernet ports. For Stratix 8000/8300 switches, only the ports on the base switch module are PTP-capable. The switch expansion modules do not support PTP. When at least one switch port is PTP-enabled, the End to End Transparent mode is selected by default.
Delay Request Interval	The logarithmic mean interval in seconds Type the recommended to connected devices to send delay request messages when the switch port is in the master state. Valid values: <ul style="list-style-type: none"> <li>• -1—half second</li> <li>• 0—1 second</li> <li>• 1—2 seconds</li> <li>• 2—4 seconds</li> <li>• 3—8 seconds</li> <li>• 4—16 seconds</li> <li>• 5—32 seconds</li> <li>• 6—64 seconds</li> </ul> Default: 5 (32 seconds)
Announce Timeout	Type the number of announce intervals, specified as the logarithmic mean in seconds, that must pass without receipt of an announce message from the parent or Grandmaster clock before the switch selects a new parent or Grandmaster clock. Valid values: 2...10 Default: 3 (8 seconds)
Announce Interval	Type the time interval, specified as the logarithmic mean in seconds, for sending announce messages. Valid values: <ul style="list-style-type: none"> <li>• 0—1 second</li> <li>• 1—2 seconds</li> <li>• 2—4 seconds</li> <li>• 3—8 seconds</li> <li>• 4—16 seconds</li> </ul> Default: 1 (2 seconds)

**Table 29 - Boundary Mode Fields (Continued)**

Field	Description
Sync Interval	Type the time interval, specified as the logarithmic mean in seconds, for sending synchronization messages. Valid values: <ul style="list-style-type: none"> <li>-1—half second</li> <li>0—1 second</li> <li>1—2 seconds</li> </ul> Default: 0 (1 second)
Sync Fault Limit	Type the maximum clock offset before PTP attempts to reacquire synchronization. Valid values: 50...500000000 nanoseconds Default: 50000 nanoseconds <b>IMPORTANT:</b> We recommend against setting the sync limit below the default (50000 nanoseconds). Use values below 50000 nanoseconds only in networks with a very high-precision Grandmaster clock. These networks have a critical need to keep very sensitive devices synchronized.
VLAN Id (Not available on Stratix 8000/8300 switches)	To configure PTP on a VLAN of a trunk port, type the VLAN ID. Only PTP packets in the VLAN you specify are processed. PTP packets from other VLANs are dropped. You can only enable PTP on one VLAN on a trunk port. Valid values: 1...4094 The default is the native VLAN of the trunk port.

**Figure 2 - End to End Transparent Mode**

Port Name	State	Enable	Delay Request Interval	Announce Timeout	Announce Interval	Sync Interval	Sync Fault Limit	Vlan Id
Gi1/1	MASTER	<input checked="" type="checkbox"/>	5	3	1	0	500000000	100
Gi1/2	FAULTY	<input checked="" type="checkbox"/>	5	3	1	0	500000000	N/A
Gi1/3	MASTER	<input checked="" type="checkbox"/>	5	3	1	0	500000000	200
Gi1/4	MASTER	<input checked="" type="checkbox"/>	5	3	1	0	500000000	200
Gi1/5	FAULTY	<input checked="" type="checkbox"/>	5	3	1	0	500000000	N/A
Gi1/6	FAULTY	<input checked="" type="checkbox"/>	5	3	1	0	500000000	N/A

**Table 30 - End to End Transparent Mode Fields**

Field	Description
PTP Device Type	Displays the PTP clock type of the switch, as determined by the Mode setting.
Number of PTP ports	Displays the number of ports assigned to the PTP clock.
Local clock time	Displays the time stamp of the local clock.
Device Time Source	Displays the time source used by the switch.
Device Clock Time	Displays the time on the switch, obtained from the time source.
<b>Per Port Settings</b>	
Port Name	Displays the port type and port number: <ul style="list-style-type: none"> <li>Fa—Fast Ethernet</li> <li>Gi—Gigabit Ethernet</li> <li>Te—10 Gigabit Ethernet</li> </ul>

**Table 30 - End to End Transparent Mode Fields (Continued)**

Field	Description
State (Not available on Stratix 8000/8300 switches)	<p>Displays the synchronization state of the switch port with the parent or Grandmaster clock:</p> <ul style="list-style-type: none"> <li>• Initializing—The switch port is waiting while a parent or Grandmaster clock is selected.</li> <li>• Listening—The switch port is waiting while a parent or Grandmaster clock is selected.</li> <li>• Pre-master—The switch port is transitioning to change to Master state.</li> <li>• Master—The switch is acting as a parent clock to the devices connected to that switch port.</li> <li>• Passive—The switch has detected a redundant path to a parent or Grandmaster clock. For example, two different switch ports claim the same parent or Grandmaster clock. To help prevent a loop in the network, one of the ports changes to Passive state.</li> <li>• Uncalibrated—The switch port cannot synchronize with the parent or Grandmaster clock.</li> <li>• Slave—The switch port is connected to and synchronizing with the parent or Grandmaster clock.</li> <li>• Faulty—Either PTP is not operating properly on the switch port or nothing is connected to the port.</li> <li>• Disabled—PTP is not enabled on the switch port.</li> </ul>
Enable	<p>Check the checkbox for each port on which to enable PTP. You can enable one or more switch ports.</p> <p>By default, PTP is enabled on all the Fast Ethernet and Gigabit Ethernet ports.</p> <p>For Stratix 8000/8300 switches, only the ports on the base switch module are PTP-capable. The switch expansion modules do not support PTP. When at least one switch port is PTP-enabled, the End to End Transparent mode is selected by default.</p>
Delay Request Interval (Not available on Stratix 8000/8300 switches)	<p>The logarithmic mean interval in seconds</p> <p>Type the recommended to connected devices to send delay request messages when the switch port is in the master state.</p> <p>Valid values:</p> <ul style="list-style-type: none"> <li>• -1—half second</li> <li>• 0—1 second</li> <li>• 1—2 seconds</li> <li>• 2—4 seconds</li> <li>• 3—8 seconds</li> <li>• 4—16 seconds</li> <li>• 5—32 seconds</li> <li>• 6—64 seconds</li> </ul> <p>Default: 5 (32 seconds)</p>
Announce Timeout (Not available on Stratix 8000/8300 switches)	<p>Type the number of announce intervals, specified as the logarithmic mean in seconds, that must pass without receipt of an announce message from the parent or Grandmaster clock before the switch selects a new parent or Grandmaster clock.</p> <p>Valid values: 2 . . . 10</p> <p>Default: 3 (8 seconds)</p>
Announce Interval (Not available on Stratix 8000/8300 switches)	<p>Type the time interval, specified as the logarithmic mean in seconds, for sending announce messages.</p> <p>Valid values:</p> <ul style="list-style-type: none"> <li>• 0—1 second</li> <li>• 1—2 seconds</li> <li>• 2— 4 seconds</li> <li>• 3— 8 seconds</li> <li>• 4—16 seconds</li> </ul> <p>Default: 1 (2 seconds)</p>
Sync Interval (Not available on Stratix 8000/8300 switches)	<p>Type the time interval, specified as the logarithmic mean in seconds, for sending synchronization messages.</p> <p>Valid values:</p> <ul style="list-style-type: none"> <li>• -1—half second</li> <li>• 0—1 second</li> <li>• 1— 2 seconds</li> </ul> <p>Default: 0 (1 second)</p>
Sync Fault Limit (Not available on Stratix 8000/8300 switches)	<p>Type the maximum clock offset before PTP attempts to reacquire synchronization.</p> <p>Valid values: 50 . . . 500000000 nanoseconds</p> <p>Default: 50000 nanoseconds</p> <p><b>IMPORTANT:</b> We recommend against setting the sync limit below the default (50000 nanoseconds). Use values below 50000 nanoseconds only in networks with a very high-precision Grandmaster clock. These networks have a critical need to keep very sensitive devices synchronized.</p>
VLAN Id (Not available on Stratix 8000/8300 switches)	<p>Stratix To configure PTP on a VLAN of a trunk port, type the VLAN ID. Only PTP packets in the VLAN you specify are processed. PTP packets from other VLANs are dropped. You can only enable PTP on one VLAN on a trunk port.</p> <p>Valid values: 1 . . . 4094</p> <p>The default is the native VLAN of the trunk port.</p>

Figure 3 - Forward Mode

Mode: Forward

Submit

Device Time Source: user configuration

Device Clock Time: 02:24:48.032 UTC Tue Feb 2 2016

Table 31 - Forward Mode Fields

Field	Description
Device Time Source	Displays the time source used by the switch.
Device Clock Time	Displays the time on the switch, obtained from the time source.

Figure 4 - NTP-PTP Clock Mode

Mode: NTP-PTP Clock

Priority1: 128

Priority2: 128

Clock Identity: 0xF4:54:33:FF:FE:0:8F:0

Offset From Master(ns): 0

Submit

**PTP Clock Settings**

PTP Device Type: Grand Master clock - Boundary clock

Number of PTP ports: 16

**Clock Quality:**

Class: 248

Accuracy: Unknown

Offset (log variance): N/A

Steps Removed: 0

Local clock time: 15:47:11 UTC Feb 10 2016

**PTP Time Property**

Current UTC offset valid: FALSE

Current UTC offset: 0

Time Source: Internal Oscillator

**Device Clock Details**

Device Time Source: hardware calendar

Device Clock Time: 15:47:11.217 UTC Wed Feb 10 2016

Port Name	State	Enable	Delay Request Interval	Announce Timeout	Announce Interval	Sync Interval	Sync Fault Limit	Vlan Id
Gi1/1	MASTER	<input checked="" type="checkbox"/>	5	3	1	0	500000000	100

**Table 32 - NTP-PTP Clock Mode Fields**

Field	Description
<b>PTP Clock Settings</b>	
PTP Device Type	Displays the PTP clock type of the switch, as determined by the Mode setting.
Number of PTP ports	Displays the number of ports assigned to the PTP clock.
Clock Quality	Displays a summary of the quality of the Grandmaster clock: <ul style="list-style-type: none"> <li>• Class—Time and frequency traceability of the Grandmaster clock.</li> <li>• Accuracy—Expected accuracy of the Grandmaster clock when the Best Master Clock algorithm is in use.</li> <li>• Offset (log variance)—Offset between the local clock and an ideal reference clock.</li> </ul>
Steps Removed	Displays the number of hops from the local clock to the Grandmaster clock.
Local clock time	Displays the time stamp of the local clock.
<b>PTP Time Property</b>	
Current UTC offset valid	Indicates whether the current Coordinated Universal Time (UTC) offset is valid.
Current UTC offset	Displays the offset between the International Atomic Time (TAI) and UTC in seconds.
Time Source	Displays the time source used by the Grandmaster clock.
<b>Device Clock Details</b>	
Device Time Source	Displays the time source used by the switch.
Device Clock Time	Displays the time on the switch, obtained from the time source.
<b>Per Port Settings</b>	
Port Name	Displays the port type and port number: <ul style="list-style-type: none"> <li>• Fa—Fast Ethernet</li> <li>• Gi—Gigabit Ethernet</li> <li>• Te—10 Gigabit Ethernet</li> </ul>
State	Displays the synchronization state on the switch port with the parent or Grandmaster clock: <ul style="list-style-type: none"> <li>• Initializing—The switch port is waiting while a parent or Grandmaster clock is selected.</li> <li>• Listening—The switch port is waiting while a parent or Grandmaster clock is selected.</li> <li>• Pre-master—The switch port is transitioning to change to Master state.</li> <li>• Master—The switch is acting as a parent clock to the devices connected to that switch port.</li> <li>• Passive—The switch has detected a redundant path to a parent or Grandmaster clock. For example, two different switch ports claim the same parent or Grandmaster clock. To help prevent a loop in the network, one of the ports changes to Passive state.</li> <li>• Uncalibrated—The switch port cannot synchronize with the parent or Grandmaster clock.</li> <li>• Slave—The switch port is connected to and synchronizing with the parent or Grandmaster clock.</li> <li>• Faulty—Either PTP is not operating properly on that switch port or nothing is connected to the port.</li> <li>• Disabled—PTP is not enabled on the switch port.</li> </ul>
Enable	Check the checkbox for each port on which to enable PTP. You can enable one or more switch ports. By default, PTP is enabled on all the Fast Ethernet and Gigabit Ethernet ports. For Stratix 8000/8300 switches, only the ports on the base switch module are PTP-capable. The switch expansion modules do not support PTP. When at least one switch port is PTP-enabled, the End to End Transparent mode is selected by default.
Delay Request Interval	Type the recommended to connected devices to send delay request messages when the switch port is in the master state. Valid values: <ul style="list-style-type: none"> <li>• -1—half second</li> <li>• 0—1 second</li> <li>• 1—2 seconds</li> <li>• 2—4 seconds</li> <li>• 3—8 seconds</li> <li>• 4—16 seconds</li> <li>• 5—32 seconds</li> <li>• 6—64 seconds</li> </ul> Default: 5 (32 seconds)

**Table 32 - NTP-PTP Clock Mode Fields (Continued)**

Field	Description
Announce Timeout	Type the number of announce intervals, specified as the logarithmic mean in seconds, that must pass without receipt of an announce message from the parent or Grandmaster clock before the switch selects a new parent or Grandmaster clock. Valid values: 2 . . . 10 Default: 3 (8 seconds)
Announce Interval	Type the time interval, specified as the logarithmic mean in seconds, for sending announce messages. Valid values: <ul style="list-style-type: none"> <li>• 0—1 second</li> <li>• 1—2 seconds</li> <li>• 2—4 seconds</li> <li>• 3—8 seconds</li> <li>• 4—16 seconds</li> </ul> Default: 1 (2 seconds)
Sync Interval	Type the time interval, specified as the logarithmic mean in seconds, for sending synchronization messages. Valid values: <ul style="list-style-type: none"> <li>• -1—half second</li> <li>• 0—1 second</li> <li>• 1—2 seconds</li> </ul> Default: 0 (1 second)
Sync Fault Limit	Type the maximum clock offset before PTP attempts to reacquire synchronization. Valid values: 50 . . . 500000000 nanoseconds Default: 50000 nanoseconds <b>IMPORTANT:</b> We recommend against setting the sync limit below the default (50000 nanoseconds). Use values below 50000 nanoseconds only in networks with a very high-precision Grandmaster clock. These networks have a critical need to keep very sensitive devices synchronized.
VLAN Id	To configure PTP on a VLAN of a trunk port, type the VLAN ID. Only PTP packets in the VLAN you specify are processed. PTP packets from other VLANs are dropped. You can only enable PTP on one VLAN on a trunk port. Valid values: 1 . . . 4094 The default is the native VLAN of the trunk port.

## Configure Time Synchronization via the Logix Designer Application

To configure time synchronization, follow these steps.

1. In the navigation pane, click Time Sync Configuration.
2. From the Clock Type pull-down menu, choose a mode.  
The available modes vary based on the switch model.
3. To complete the remaining fields, refer to the figure and table that corresponds to your mode.

Mode	Page
Boundary	97
End to End	99
Forward	99
NTP-PTP Clock	100



**Figure 5 - Boundary Mode**

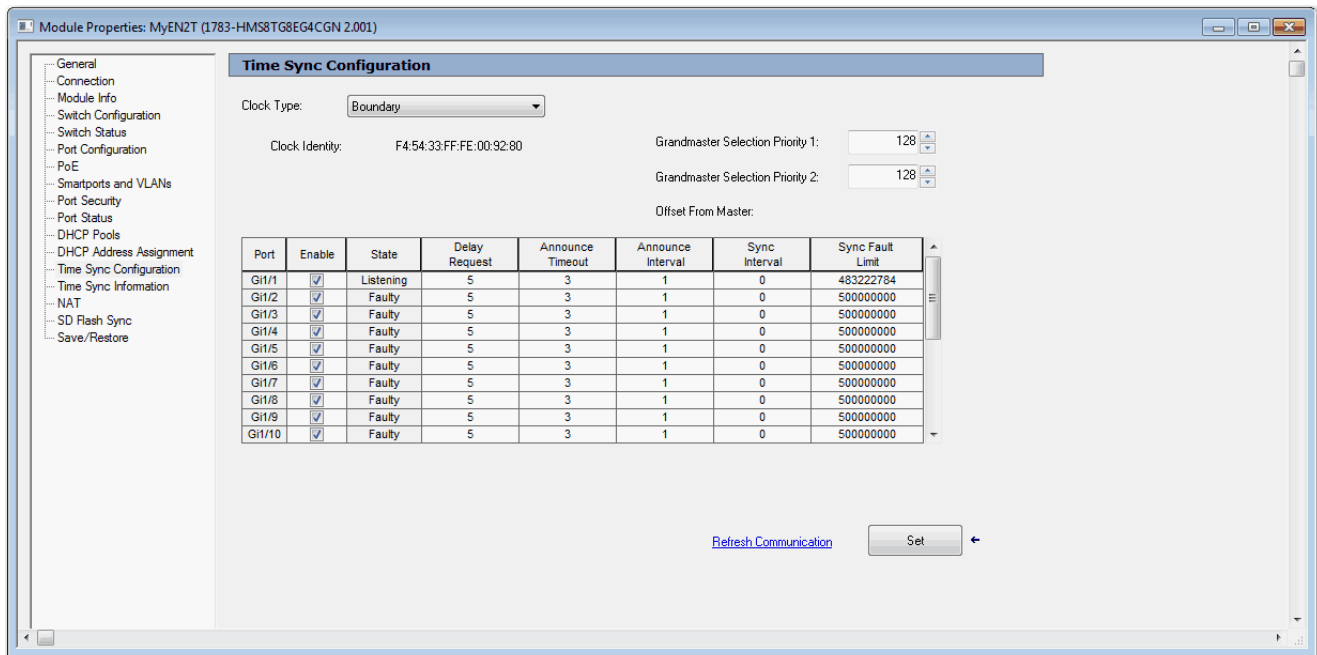

**Table 33 - Boundary Mode**

Field	Description
Clock Identity	Displays a unique identifier for the clock.
Grandmaster Selection Priority 1	Type a value to override the default criteria (clock quality, clock class, and so on) for the best master clock selection. A lower value takes precedence. Valid values: 0...255 Default: 128
Grandmaster Selection Priority 2	Type a value to use as a tie-breaker between two devices that are otherwise equally matched in the default criteria. For example, you can give a specific switch priority over other identical switches. A lower value takes precedence. Valid values: 0...255 Default: 128
Offset from Master	Displays the time offset in nanoseconds between the slave and master clocks.
Port	Displays the port type and port number: <ul style="list-style-type: none"> <li>Fa—Fast Ethernet</li> <li>Gi—Gigabit Ethernet</li> <li>Te—10 Gigabit Ethernet</li> </ul>
Enable	Check the checkbox for each port on which to enable PTP. You can enable one or more switch ports. By default, PTP is enabled on all the Fast Ethernet and Gigabit Ethernet ports. For Stratix 8000/8300 switches, only the ports on the base switch module are PTP-capable. The switch expansion modules do not support PTP.
State	Displays the synchronization state of the switch port with the parent or Grandmaster clock: <ul style="list-style-type: none"> <li>Initializing—The switch port is waiting while a parent or Grandmaster clock is selected.</li> <li>Listening—The switch port is waiting while a parent or Grandmaster clock is selected.</li> <li>Pre-master—The switch port is transitioning to change to Master state.</li> <li>Master—The switch is acting as a parent clock to the devices connected to that switch port.</li> <li>Passive—The switch has detected a redundant path to a parent or Grandmaster clock. For example, two different switch ports claim the same parent or Grandmaster clock. To help prevent a loop in the network, one of the ports changes to Passive state.</li> <li>Uncalibrated—The switch port cannot synchronize with the parent or Grandmaster clock.</li> <li>Slave—The switch port is connected to and synchronizing with the parent or Grandmaster clock.</li> <li>Faulty—Either PTP is not operating properly on the switch port or nothing is connected to the port.</li> <li>Disabled—PTP is not enabled on the switch port.</li> </ul>

**Table 33 - Boundary Mode (Continued)**

Field	Description
Delay Request	<p>The logarithmic mean interval in seconds.                      Type the recommended to connected devices to send delay request messages when the switch port is in the master state.                      Valid values:</p> <ul style="list-style-type: none"> <li>• -1—half second</li> <li>• 0—1 second</li> <li>• 1—2 seconds</li> <li>• 2—4 seconds</li> <li>• 3—8 seconds</li> <li>• 4—16 seconds</li> <li>• 5—32 seconds</li> <li>• 6—64 seconds</li> </ul> <p>Default: 5 (32 seconds)</p>
Announce Timeout	<p>Type the number of announce intervals, specified as the logarithmic mean in seconds, that must pass without receipt of an announce message from the parent or Grandmaster clock before the switch selects a new parent or Grandmaster clock.                      Valid values: 2 . . . 10                      Default: 3 (8 seconds)</p>
Announce Interval	<p>Type the time interval, specified as the logarithmic mean in seconds, for sending announce messages.                      Valid values:</p> <ul style="list-style-type: none"> <li>• 0—1 second</li> <li>• 1—2 seconds</li> <li>• 2—4 seconds</li> <li>• 3—8 seconds</li> <li>• 4—16 seconds</li> </ul> <p>Default: 1 (2 seconds)</p>
Sync Interval	<p>Type the time interval, specified as the logarithmic mean in seconds, for sending synchronization messages.                      Valid values:</p> <ul style="list-style-type: none"> <li>• -1—half second</li> <li>• 0—1 second</li> <li>• 1—2 seconds</li> </ul> <p>Default: 0 (1 second)</p>
Sync Fault Limit	<p>Type the maximum clock offset before PTP attempts to reacquire synchronization.                      Valid values: 50 . . . 500000000 nanoseconds                      Default: 50000 nanoseconds</p> <p><b>IMPORTANT:</b> We recommend against setting the sync limit below the default (50000 nanoseconds). Use values below 50000 nanoseconds only in networks with a very high-precision Grandmaster clock. These networks have a critical need to keep very sensitive devices synchronized.</p>

**Figure 6 - End-to-End Transparent Mode**

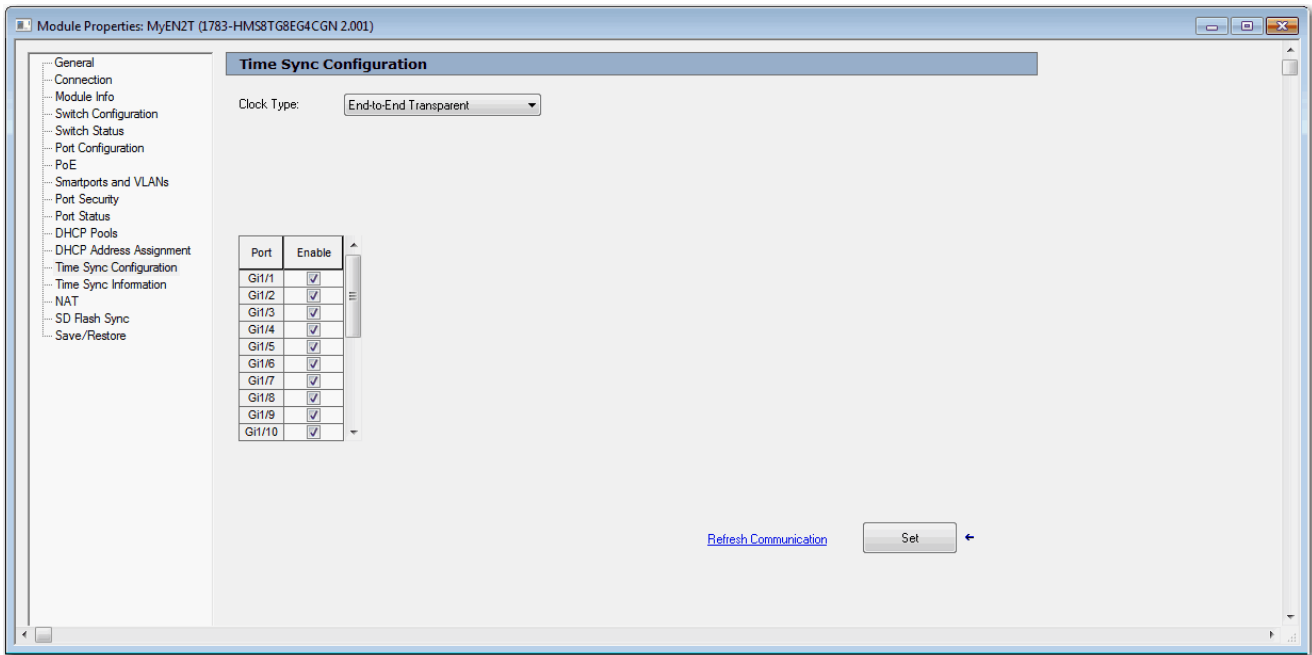

**Table 34 - End to End Transparent Mode Fields**

Field	Description
Port	Displays the port type and port number: <ul style="list-style-type: none"> <li>• Fa—Fast Ethernet</li> <li>• Gi—Gigabit Ethernet</li> <li>• Te—10 Gigabit Ethernet</li> </ul>
Enable	Check the checkbox for each port on which to enable PTP. You can enable one or more switch ports. By default, PTP is enabled on all the Fast Ethernet and Gigabit Ethernet ports. For Stratix 8000/8300 switches, only the ports on the base switch module are PTP-capable. The switch expansion modules do not support PTP. When at least one switch port is PTP-enabled, the End to End Transparent mode is selected by default.

**Figure 7 - Forward Mode**

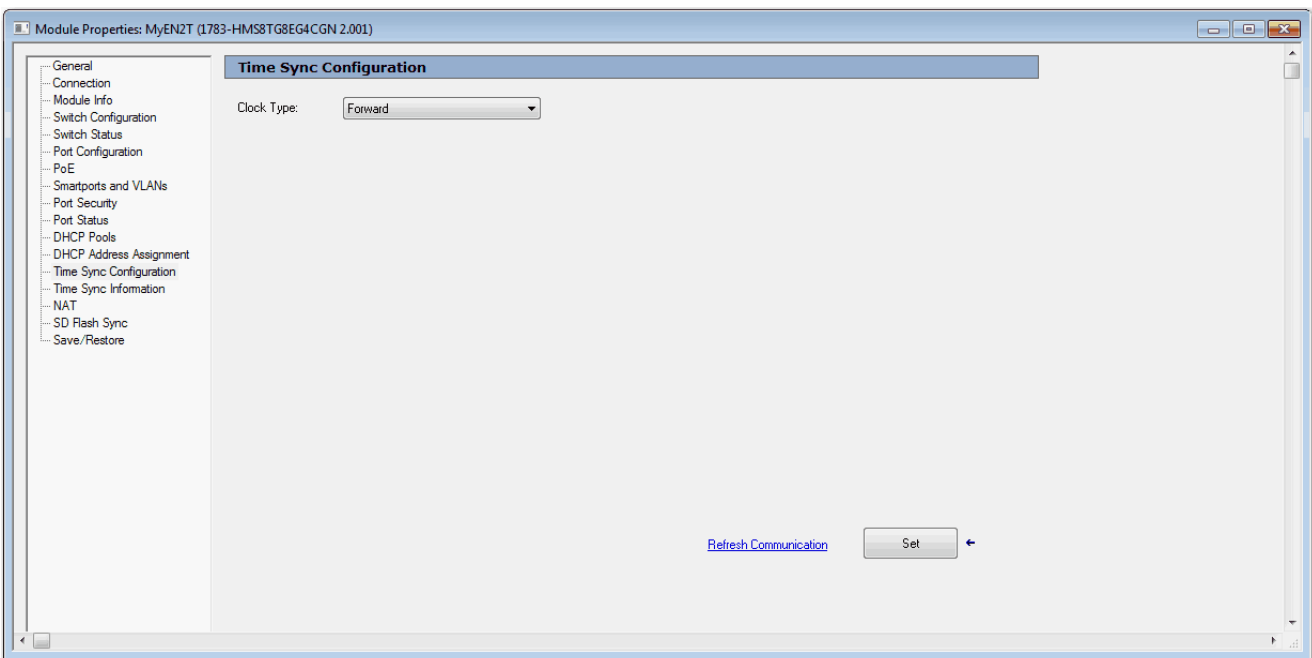

Figure 8 - NTP-PTP Mode

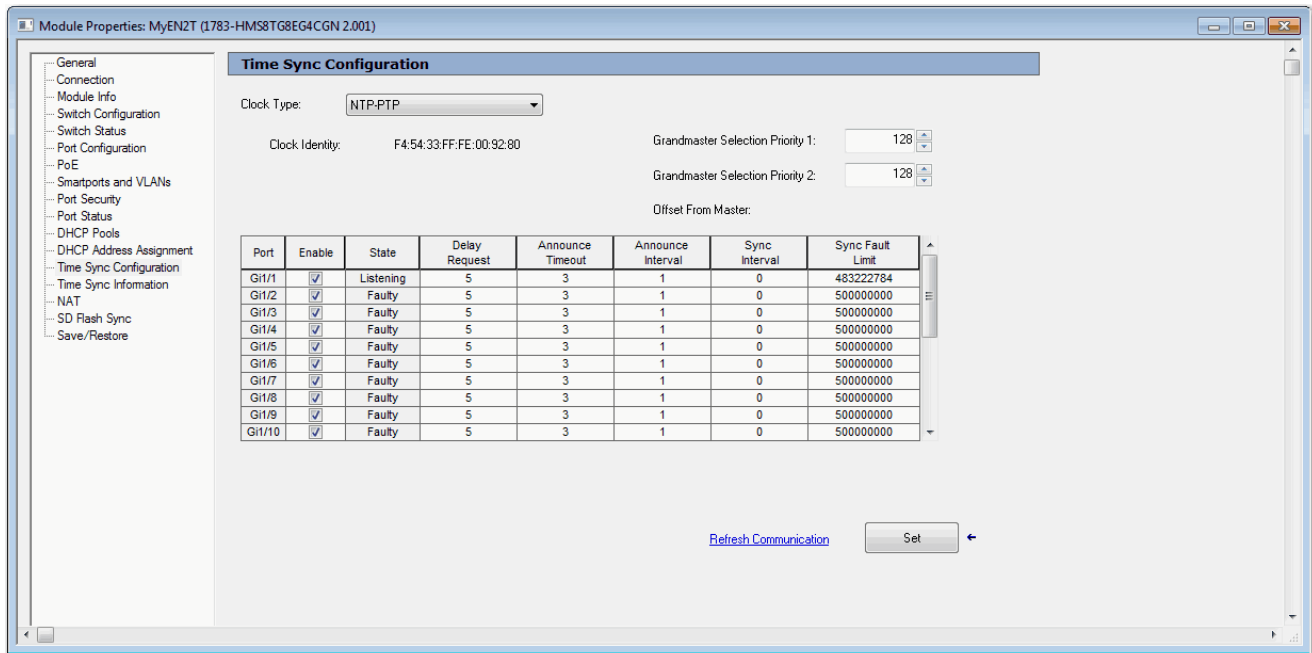

Table 35 - NTP-PTP Mode Fields

Field	Description
Clock Identity	Displays a unique identifier for the clock.
Grandmaster Selection Priority1	Type a value to override the default criteria (clock quality, clock class, and so on) for the best master clock selection. A lower value takes precedence. Valid values: 0...255 Default: 128
Grandmaster Selection Priority 2	Type a value to use as a tie-breaker between two devices that are otherwise equally matched in the default criteria. For example, you can give a specific switch priority over other identical switches. A lower value takes precedence. Valid values: 0...255 Default: 128
Offset from Master	Displays the time offset in nanoseconds between the slave and master clocks.
Port	Displays the port type and port number: <ul style="list-style-type: none"> <li>Fa—Fast Ethernet</li> <li>Gi—Gigabit Ethernet</li> <li>Te—10 Gigabit Ethernet</li> </ul>
Enable	Check the checkbox for each port on which to enable PTP. You can enable one or more switch ports. By default, PTP is enabled on all the Fast Ethernet and Gigabit Ethernet ports. For Stratix 8000/8300 switches, only the ports on the base switch module are PTP-capable. The switch expansion modules do not support PTP.
State	Displays the synchronization state on the switch port with the parent or Grandmaster clock: <ul style="list-style-type: none"> <li>Initializing—The switch port is waiting while a parent or Grandmaster clock is selected.</li> <li>Listening—The switch port is waiting while a parent or Grandmaster clock is selected.</li> <li>Pre-master—The switch port is transitioning to change to Master state.</li> <li>Master—The switch is acting as a parent clock to the devices connected to that switch port.</li> <li>Passive—The switch has detected a redundant path to a parent or Grandmaster clock. For example, two different switch ports claim the same parent or Grandmaster clock. To help prevent a loop in the network, one of the ports changes to Passive state.</li> <li>Uncalibrated—The switch port cannot synchronize with the parent or Grandmaster clock.</li> <li>Slave—The switch port is connected to and synchronizing with the parent or Grandmaster clock.</li> <li>Faulty—Either PTP is not operating properly on that switch port or nothing is connected to the port.</li> <li>Disabled—PTP is not enabled on the switch port.</li> </ul>

**Table 35 - NTP-PTP Mode Fields (Continued)**

Field	Description
Delay Request Interval	Type the recommended to connected devices to send delay request messages when the switch port is in the master state. Valid values: <ul style="list-style-type: none"> <li>• -1—half second</li> <li>• 0—1 second</li> <li>• 1—2 seconds</li> <li>• 2—4 seconds</li> <li>• 3—8 seconds</li> <li>• 4—16 seconds</li> <li>• 5—32 seconds</li> <li>• 6—64 seconds</li> </ul> Default: 5 (32 seconds)
Announce Timeout	Type the number of announce intervals, specified as the logarithmic mean in seconds, that must pass without receipt of an announce message from the parent or Grandmaster clock before the switch selects a new parent or Grandmaster clock. Valid values: 2...10 Default: 3 (8 seconds)
Announce Interval	Type the time interval, specified as the logarithmic mean in seconds, for sending announce messages. Valid values: <ul style="list-style-type: none"> <li>• 0—1 second</li> <li>• 1—2 seconds</li> <li>• 2—4 seconds</li> <li>• 3—8 seconds</li> <li>• 4—16 seconds</li> </ul> Default: 1 (2 seconds)
Sync Interval	Type the time interval, specified as the logarithmic mean in seconds, for sending synchronization messages. Valid values: <ul style="list-style-type: none"> <li>• -1—half second</li> <li>• 0—1 second</li> <li>• 1—2 seconds</li> </ul> Default: 0 (1 second)
Sync Fault Limit	Type the maximum clock offset before PTP attempts to reacquire synchronization. Valid values: 50...500000000 nanoseconds Default: 50000 nanoseconds <b>IMPORTANT:</b> We recommend against setting the sync limit below the default (50000 nanoseconds). Use values below 50000 nanoseconds only in networks with a very high-precision Grandmaster clock. These networks have a critical need to keep very sensitive devices synchronized.

## View Time Sync Information in the Logix Designer Application

In the navigation pane, click Time Sync Information.

The Time Sync Information view shows current information about the real-time clocks in the network. The CIP™ Time Synchronization protocol provides a standard mechanism to synchronize clocks across a network of distributed devices.

The CIP Sync Time Synchronization feature supports both Boundary and End-to-End Transparent mode. End to End Transparent mode synchronizes all switch ports with the Grandmaster clock using the IEEE 1588 V 2 End to End Transparent clock mechanism, and is the preferred mode.

Figure 9 - Time Sync Information

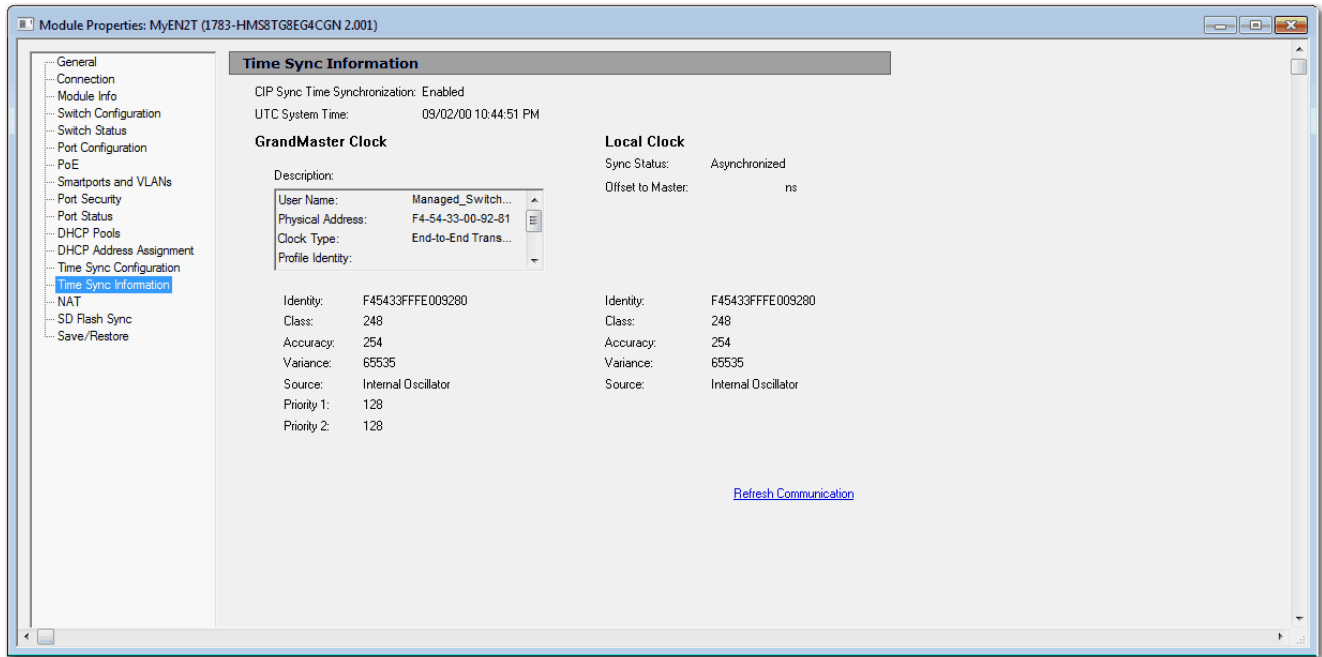

Table 36 - Time Sync Information Fields

Field	Description
CIP Sync Time Synchronization	Displays whether the Precision Time Protocol is enabled or disabled on the device.
UTC System Time	Displays the current system time in units of microseconds.
<b>Grandmaster Clock</b>	
Description	Displays information to identify the Grandmaster clock, including the configured the clock type.
Identity	Displays the unique identifier for the Grandmaster clock. The format depends on the network protocol.
Class	Displays a measure of the quality of the Grandmaster clock. Values are defined from 0...255 with 0 as the best clock.
Accuracy	Indicates the expected absolute accuracy of the Grandmaster clock relative to CIP Sync time synchronization epoch (31 December, 1969 23:59:51.99918 UTC). The accuracy is specified as a graduated scale starting at 25 ns and ending at greater than 10 seconds or unknown. For example, a GPS time source has an accuracy of approximately 250 ns. A hand-set clock typically has an accuracy less than 10 seconds. The lower the accuracy value, the better the clock.
Variance	Displays the measure of inherent stability properties of the Grandmaster clock. The value is in offset scaled log units. The lower the variance, the better the clock.
Source	Displays the clock time source: <ul style="list-style-type: none"> <li>• Atomic Clock</li> <li>• GPS</li> <li>• Terrestrial Radio</li> <li>• CIP Time Synchronization</li> <li>• NTP</li> <li>• HAND Set</li> <li>• Other</li> <li>• Internal Oscillator</li> </ul>
Priority 1	Displays the relative priority of the Grandmaster clock to other clocks in the system. The value is between 0...255. The highest priority is 0.
Priority 2	
<b>Local Clock</b>	
Sync Status	Displays whether the local clock is synchronized or asynchronized with the Grandmaster clock.
Offset to Master	Displays the offset value between the local clock and the master clock.
Identity	Displays the unique identifier for the local clock. The format depends on the network protocol. <ul style="list-style-type: none"> <li>• The Ethernet protocol encodes the MAC ID into the identifier.</li> <li>• The DeviceNet and ControlNet protocols encode the Vendor ID and serial number into the identifier.</li> </ul>

**Table 36 - Time Sync Information Fields (Continued)**

Field	Description
Class	Displays a measure of the quality of the local clock. Values are defined from 0 . . . 255 with 0 as the best clock.
Accuracy	Indicates the expected absolute accuracy of the local clock relative to CIP Sync time synchronization epoch (31 December, 1969 23:59:51.99918 UTC). The accuracy is specified as a graduated scale starting at 25 ns and ending at greater than 10 seconds or unknown. For example, a GPS time source has an accuracy of approximately 250 ns. A hand-set clock typically has an accuracy less than 10 seconds. The lower the accuracy value, the better the clock.
Variance	Displays the measure of inherent stability properties of the local clock. The value is in offset scaled log units. The lower the variance, the better the clock.
Source	Displays the clock time source: <ul style="list-style-type: none"> <li>• Atomic Clock</li> <li>• GPS</li> <li>• Terrestrial Radio</li> <li>• CIP Time Synchronization</li> <li>• NTP</li> <li>• HAND Set</li> <li>• Other</li> <li>• Internal Oscillator</li> </ul>

## Cryptographic IOS

With IOS release 15.2(5)EA.fc4 and later, the default firmware that ships from manufacturing is the cryptographic IOS. The cryptographic IOS provides increased network security by encrypting administrator traffic during SNMP sessions. The cryptographic IOS supports all features of the standard IOS and these protocols:

- Secure Shell (SSH) Protocol v2
- SNMPv3
- Https

With the cryptographic IOS, https is the default protocol for accessing Device Manager. For instructions on accessing Device Manager via secure connection, see [Access Device Manager on page 48](#).

Non-cryptographic IOS software is available to download from the Product Compatibility and Download Center on <http://www.ab.com>.

If you upgrade an existing configuration from IOS 15.2(4)EA3 or earlier to IOS 15.2(5)EA.fc4 or later, the default switch settings are as follows:

- If you upgrade the switch to the cryptographic IOS, Telnet remains enabled, SSH remains disabled, but http becomes the default protocol for Device Manager.
- If you upgrade the switch to the non-cryptographic IOS, Telnet remains enabled, SSH remains disabled, and http remains the default protocol for Device Manager.

## Device Level Ring (DLR) Topology

You can configure a DLR topology on Stratix 5400 switches and some models of Stratix 5700 and ArmorStratix 5700 switches. For a list of switches that support a DLR topology, see [page 16](#).

---

**IMPORTANT** To configure DLR, be sure that the switch is using the DLR feature application profile as described on [page 153](#).

---

This section covers the following topics:

- [Overview](#)
- [DLR Port Choices](#)
- [DLR Considerations](#)
- [Redundant Gateways](#)
- [DHCP for Ring Devices](#)
- [Multiple Rings](#)
- [Configure DLR via Device Manager](#)
- [Configure DLR via the Logix Designer Application](#)

### Overview

A DLR topology is a single-fault-tolerant ring network that is intended for the interconnection of automation devices without the need for more switches. The ring topology offers these advantages:

- Media redundancy
- Fast-network fault detection and reconfiguration
- Resiliency of a single-fault-tolerant network
- Easy implementation without more hardware requirements

---

**IMPORTANT** This section summarizes a DLR topology. To plan, configure, and monitor DLR topologies, see EtherNet/IP Embedded Switch Technology Application Guide, publication [ENET-AP005](#).

---

One DLR topology can support as many as 50 nodes. A DLR topology supports copper connections (maximum of 100 m), fiber-optic connections (maximum of 2 km), or a mix of copper and fiber.



**Figure 10 - Example Device Level Ring Topology**

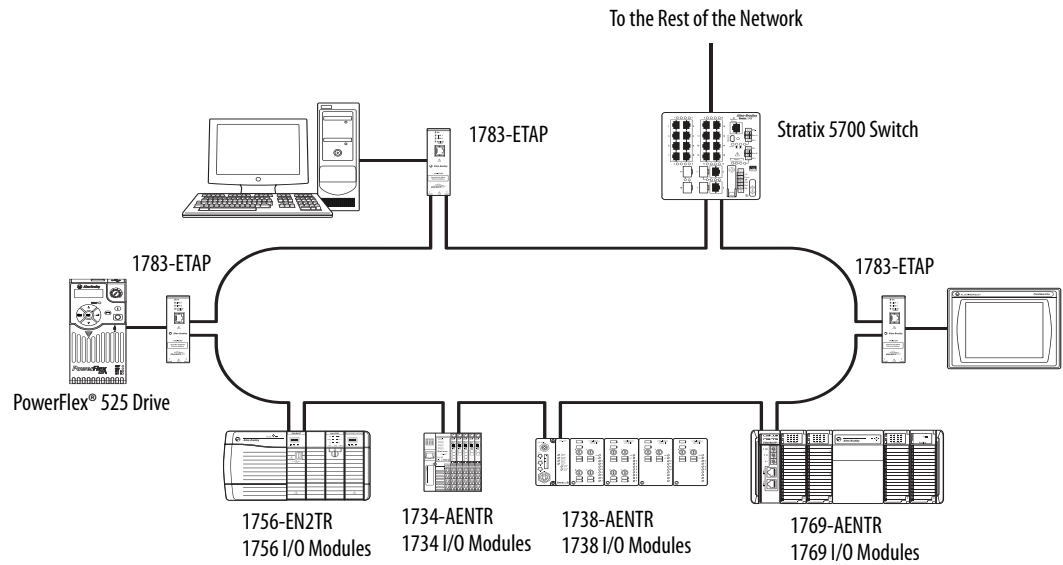

**IMPORTANT** Stratix 5700 and ArmorStratix 5700 switches support only one ring per switch. Stratix 5400 switches support as many as three rings per switch. The rings can share the same VLAN, or each ring can be on its own VLAN.

A DLR topology includes the following nodes.

Node	Description
Supervisor node	<p>A DLR network requires at least one node to be configured as ring supervisor.</p> <p><b>IMPORTANT:</b> By default, the supervisor function is disabled on supervisor-capable devices, so they are ready to participate in a linear network or as a ring node on a DLR network.</p> <p>In a DLR network, you must configure at least one of the supervisor-capable devices as the ring supervisor before physically connecting the ring. If you do not, the DLR network does not work.</p> <p>The ring supervisor provides these main functions:</p> <ul style="list-style-type: none"> <li>• Manages traffic on the DLR network</li> <li>• Collects diagnostic information for the network</li> </ul> <p>We recommend that you do the following:</p> <ul style="list-style-type: none"> <li>• Configure at least one back-up supervisor.</li> <li>• Configure the desired active ring supervisor with a numerically higher precedence value as compared to the back-up supervisors.</li> <li>• Track the supervisor-precedence values for all supervisor-enabled nodes in the DLR network.</li> </ul>
Ring node	<p>A ring node is any node that operates on the network to process data that is transmitted over the network. A ring node can also pass on the data to the next node on the network. When a fault occurs on the DLR network, the ring nodes reconfigure themselves and relearn the network topology. Additionally, ring nodes can report fault locations to the active ring supervisor.</p>

## DLR Port Choices

[Table 37](#) and [Table 38](#) show which ports you can configure for DLR:

- Stratix 5700 and ArmorStratix 5700 switches support one ring and two DLR-enabled ports per switch.
- Stratix 5400 switches support as many as three rings and six DLR-enabled ports per switch.

We recommend that you use the Multiport Automation Device Smartport role on ports you configure for DLR.

**Table 37 - DLR Port Choices for Stratix 5400 Switches**

Switch	Ring 1		Ring 2		Ring 3	
	Port 1	Port 2	Port 1	Port 2	Port 1	Port 2
1783-HMS4C4CGN	1, 5	2, 6	3, 7	4, 8	7	8
1783-HMS8T4CGN	1, 5	2, 6	3, 7	4, 8	9	10
1783-HMS8S4CGN	1, 5	2, 6	3, 7	4, 8	9	10
1783-HMS4T4E4CGN	1, 9	2, 10	3, 11	4, 12	7	8
1783-HMS16T4CGN	1, 5	2, 6	3, 7	4, 8	9	10
1783-HMS4S8E4CGN	1, 5, 9	2, 6, 10	3, 7, 11	4, 8, 12	1, 7, 13	2, 8, 14
1783-HMS8TG4CGN	1, 5	2, 6	3, 7	4, 8	9	10
1783-HMS8TG4CGR						
1783-HMS8SG4CGN	1, 5	2, 6	3, 7	4, 8	9	10
1783-HMS8SG4CGR						
1783-HMS4EG8CGN	1, 5, 9	2, 6, 10	3, 7, 11	4, 8, 12	1, 7, 9	2, 8, 10
1783-HMS4EG8CGR						
1783-HMS16TG4CGN	1, 5	2, 6	3, 7	4, 8	9	10
1783-HMS16TG4CGR						
1783-HMS8TG8EG4CGN	1, 5	2, 6	3, 7	4, 8	9	10
1783-HMS8TG8EG4CGR						
1783-HMS4SG8EG4CGN	1, 5, 9	2, 6, 10	3, 7, 11	4, 8, 12	1, 7, 13	2, 8, 14
1783-HMS4SG8EG4CGR						

**Table 38 - DLR Port Choices for Stratix 5700 and ArmorStratix 5700 Switches**

Switch	Port							
1783-BMS10CGP	Fa 1/7	Fa 1/8	Gi 1/1	Gi 1/2				
1783-BMS10CGN	Fa 1/7	Fa 1/8	Gi 1/1	Gi 1/2				
1783-BMS12T4E2CGL	Fa 1/15	Fa 1/16	Gi 1/1	Gi 1/2				
1783-BMS12T4E2CGP	Fa 1/15	Fa 1/16	Gi 1/1	Gi 1/2				
1783-BMS12T4E2CGNK	Fa 1/15	Fa 1/16	Gi 1/1	Gi 1/2				
1783-BMS20CL	Fa 1/15	Fa 1/16			Fa 1/17	Fa 1/18	Fa 1/19	Fa 1/20
1783-BMS20CA	Fa 1/15	Fa 1/16			Fa 1/17	Fa 1/18	Fa 1/19	Fa 1/20

**Table 38 - DLR Port Choices for Stratix 5700 and ArmorStratix 5700 Switches**

Switch	Port							
	Fa 1/15	Fa 1/16	Gi 1/1	Gi 1/2	Fa 1/17	Fa 1/18		
1783-BMS20CGL	Fa 1/15	Fa 1/16	Gi 1/1	Gi 1/2	Fa 1/17	Fa 1/18		
1783-BMS20CGP	Fa 1/15	Fa 1/16	Gi 1/1	Gi 1/2	Fa 1/17	Fa 1/18		
1783-BMS20CGN	Fa 1/15	Fa 1/16	Gi 1/1	Gi 1/2	Fa 1/17	Fa 1/18		
1783-BMS20CGPK	Fa 1/15	Fa 1/16	Gi 1/1	Gi 1/2	Fa 1/17	Fa 1/18		
1783-ZMS4T4E2TGP	Fa 1/7	Fa 1/8	Gi 1/1	Gi 1/2				
1783-ZMS8T8E2TGP	Fa 1/15	Fa 1/16	Gi 1/1	Gi 1/2				
1783-ZMS4T4E2TGN	Fa 1/7	Fa 1/8	Gi 1/1	Gi 1/2				
1783-ZMS8E82TGN	Fa 1/15	Fa 1/16	Gi 1/1	Gi 1/2				

## DLR Considerations

---

**IMPORTANT** Depending on your network architecture, DLR topology limitations can exist. Be sure to validate your DLR topology within the larger network before production use.

---

Some switch capabilities are not supported on DLR-enabled ports. Unsupported capabilities include, but are not limited to, the following:

- EtherChannels
- NAT
- REP
- MST/PVST/RPVST
- FlexLinks
- 802.1x Security
- Multiple VLANs
- Smartport roles, except for Multiport Automation Device or None

DLR ports function only as access ports and not trunk ports.

## Redundant Gateways

Stratix 5400, Stratix 5700, ArmorStratix 5700 switches that support DLR also support redundant gateways.

---

**IMPORTANT** Redundant gateways do not work with End to End Transparent mode for Precision Time Protocol. For more information about End to End Transparent mode, see [page 87](#).

---

The redundant gateway feature provides redundant paths from a DLR network to the outside network. You can configure multiple gateways and assign each gateway a precedence value. Only one gateway can be active at any given time. A backup gateway uses the configuration of the active gateway if the active gateway becomes inactive. The network can switch from the active gateway to a backup gateway within 14 ms...6.1 seconds, depending on the uplink network redundancy protocol.

Typically, the redundant gateway feature is configured on trunk ports independent of the DLR configuration of the access ports.

---

**IMPORTANT** The redundant gateway feature requires all devices on the ring to be compatible with redundant gateway. Connections to devices wired to or through a DLR network can be lost upon a gateway changeover if all DLR network devices are not compatible with redundant gateway. For more information about redundant gateway compatibility, see answer ID 731689 in the Technical Support Center:  
[https://rockwellautomation.custhelp.com/app/answers/detail/a\\_id/731689](https://rockwellautomation.custhelp.com/app/answers/detail/a_id/731689)

---

Figure shows an example of a switch configured for redundant gateway. All ports are assigned to VLAN 1.

**Figure 11 - Redundant Gateway Switch Ports**

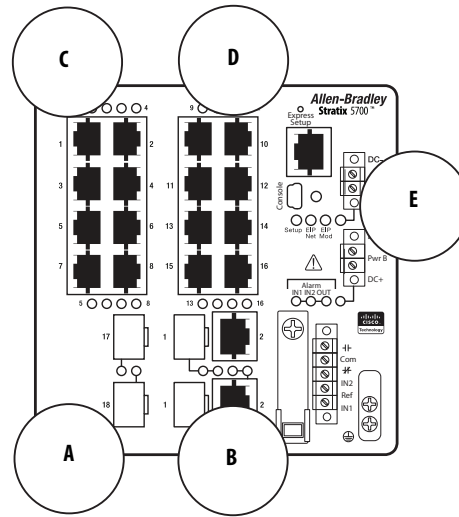

Port	Configuration
A	DLR access port
B	DLR access port
C	Redundant gateway uplink port
D	Redundant gateway uplink port
E	Non-DLR port

When the switch acts as the **active** redundant gateway, traffic on the switch that is assigned to VLAN 1 can flow between ports A, B, C, D, and E.

When the switch acts a **backup** redundant gateway, traffic on the switch that is assigned to VLAN 1 can flow as follows:

- Between only Ports A and B
- Between only Ports C, D, and E
- To join the ring, traffic on Ports C, D, and E must flow through the non-DLR port, through devices connected to the backup redundant gateway, and then through the active redundant gateway (see [Figure 12](#)).

---

**IMPORTANT** Traffic flow restrictions from the backup gateway to the ring include CIP and Device Manager traffic. As a result, all traffic flowing from a ring device to the backup gateway must use this path:

- Exit the ring through the active gateway
  - Flow through the outside network above the ring
  - Enter the backup gateway through the uplink port.
- 

- If the backup gateway subsequently becomes the active gateway, traffic then begins to flow between all ports.

Figure 12 - Traffic from Backup Gateway to Ring

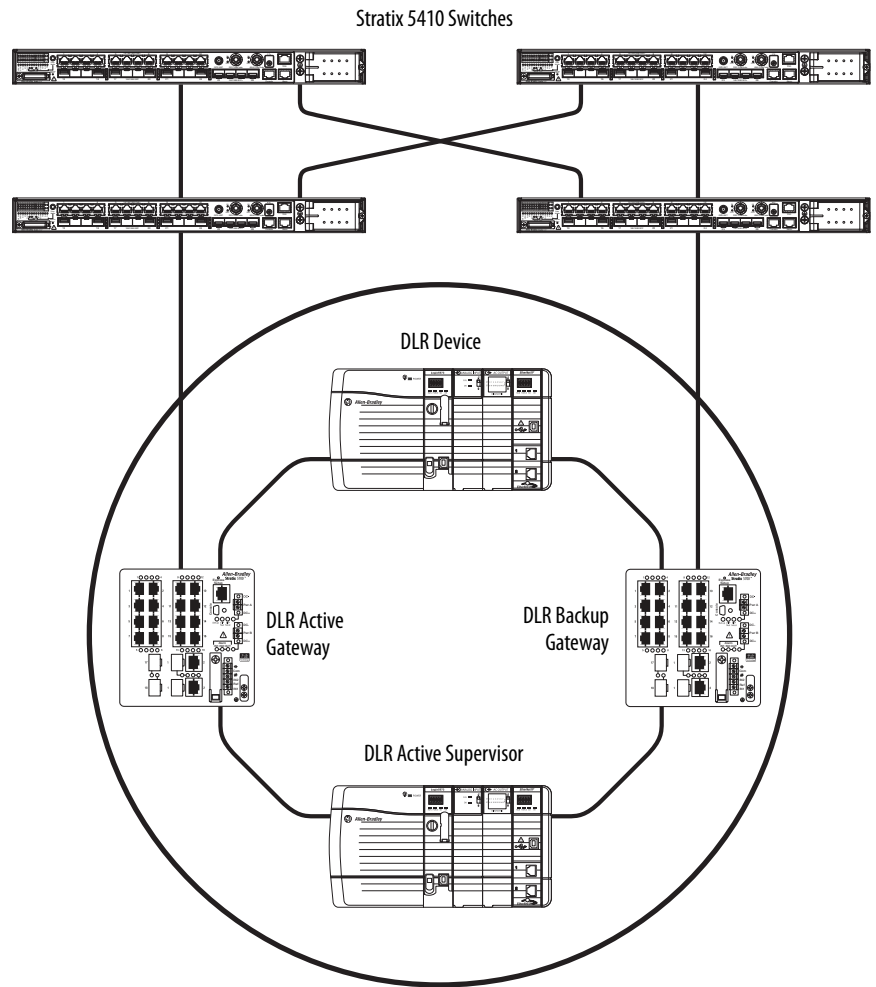

You can configure redundant gateways on switches that are either ring supervisors or ring nodes.

[Figure 13](#) shows two Stratix 5700 switches that are configured as ring supervisors with redundant gateway:

- One switch is configured as the active ring supervisor and also the active redundant gateway.
- The other switch is configured as a backup ring supervisor and the backup redundant gateway.

In this example, the switch acts as a ring supervisor. The switch also manages redundant gateway switchovers.

**Figure 13 - Ring Supervisor with Redundant Gateway**

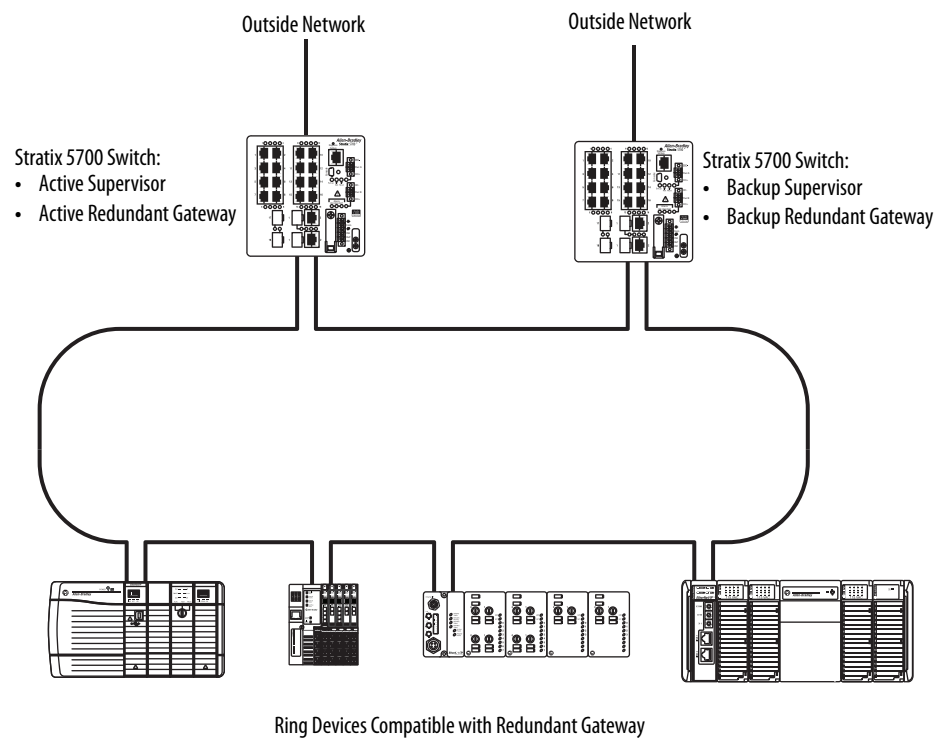
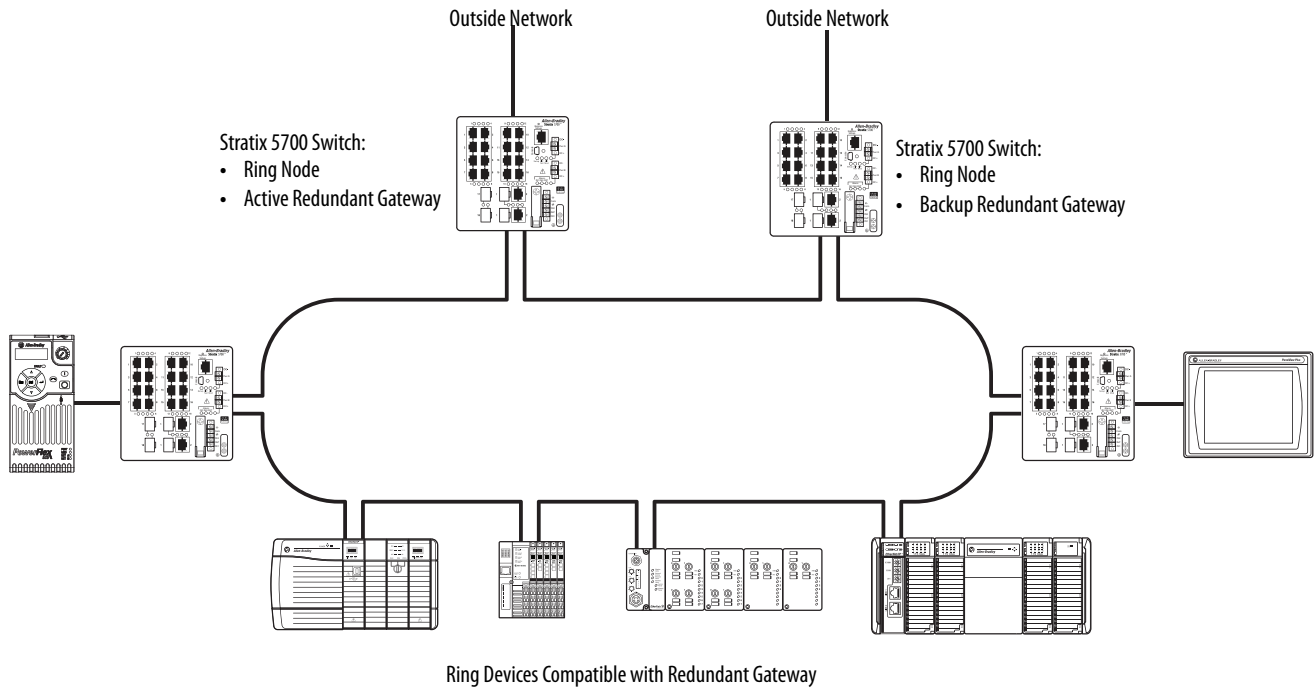

Figure 14 shows two Stratix 5700 switches that are configured as ring nodes with redundant gateway:

- One switch is a ring node and the active redundant gateway.
- The other switch is a ring node and the backup redundant gateway.

In this example, the switch provides redundant gateway functionality, so that all ring nodes have access to the outside network.

Figure 14 - Ring Node with Redundant Gateway





## DHCP for Ring Devices

Stratix 5400, Stratix 5700, and ArmorStratix 5700 switches that support DLR also support DHCP for ring devices.

---

**IMPORTANT** DHCP for ring devices does not work with DHCP persistence as described on [page 135](#). Configure only one of these features on your switch.

---

You can configure DHCP to assign IP addresses to devices connected to a ring based on their positions in the ring. This feature makes sure that a replaced device receives the expected IP address:

- A ring supervisor functions as the active ring DHCP server to assign IP addresses to the participating nodes through two DLR ports.
- If enabled, a backup ring DHCP server runs on the backup ring supervisor and obtains its reference table automatically from the active ring DHCP server on the active ring supervisor. There can be multiple backup ring DHCP servers in the ring.
- If the active ring DHCP server in the ring fails, the backup ring supervisor becomes the active supervisor. The backup ring DHCP server on the backup ring supervisor becomes the active ring DHCP server and takes over IP assignment and renewal for the ring until one of the following happens:
  - The original active ring DHCP server is restored.
  - A new active ring DHCP server is manually configured.

---

**IMPORTANT** To enable a ring to assign correct addresses by using DHCP, you must check both DHCP Snooping checkboxes on the DHCP page, as shown in [Figure 15](#).

---

**Figure 15 - DHCP Snooping Checkboxes**

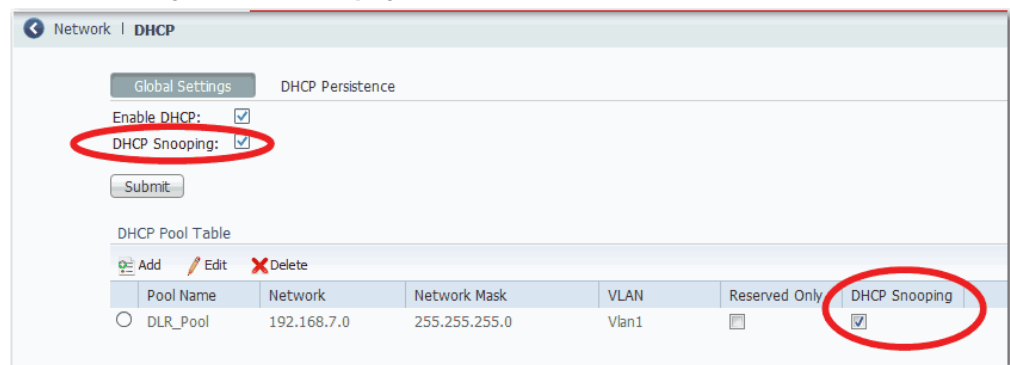

DHCP snooping for a ring can be enabled or disabled. By default, DHCP snooping for a ring is enabled:

- When enabled, DHCP snooping restricts DHCP address assignments from going beyond an active ring DHCP server and the devices within the ring. DHCP requests from another server cannot enter the ring, and DHCP requests from the active ring DHCP server cannot leave the ring.
- When disabled, DHCP snooping lets the active ring DHCP server forward DHCP requests outside of the ring. However, DHCP requests passed around the ring from a ring device are never passed to devices connected to the backup DHCP server. The requests are treated as ring traffic and stay in the ring.

[Figure 16 on page 115](#) shows two Stratix 5700 switches that are configured for DHCP in a ring:

- Ring device 1 is the active ring supervisor and ring DHCP server.
- Ring device 2 is the backup ring supervisor and ring DHCP server.
- Ring devices 2 and 5 have statically-assigned IP addresses and appear as blank entries in DHCP table ([Table 39](#)).
- Ring devices 3 and 6 are configured to receive IP addresses from BOOTP.
- Ring device 4 is configured to receive IP addresses from DHCP.

In this example, the active ring DHCP server recognizes IP address requests from ring devices 3, 4, and 6 and responds with the position-based IP address specified in the DHCP table (Table 39). The ring device index numbers in the DHCP table begin incrementing in order from the device connected to the lowest DLR port. For example, in Figure 16, the DLR ports are Gi1/1 and Gi1/2. The lowest DLR port is Gi1/1, so the device connected to Gi1/1 has an index number of 2.

**Figure 16 - DHCP for Ring Devices**

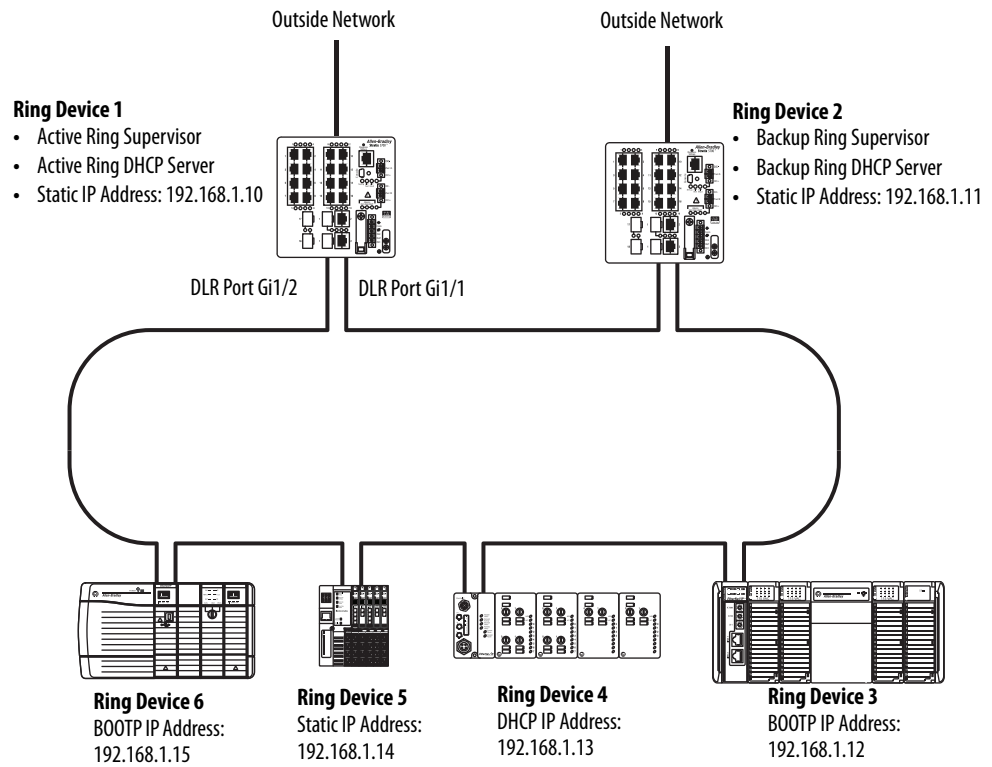

**Table 39 - Example DHCP Table for Ring Devices**

Ring Device Index <sup>(1)</sup>	IP Address	Host Name	DHCP Pool
2			
3	192.168.1.12	Rack 2	Pool 1
4	192.168.1.13	Rack 3	Pool 1
5			
6	192.168.1.15	Rack 5	Pool 1

(1) Index 1 represents the active ring DHCP server and is not configurable.



**ATTENTION:** Use caution with automatic IP address assignment when wiring DLR with symmetric devices. The controller cannot detect incorrect IP addresses of identical devices in the wrong position.

You can configure DHCP for ring devices on the Config DHCP tab in Device Manager, as shown on [page 121](#).

Once you configure DHCP for ring devices, the changes take effect when the ring converges after the loss of a network connection. However, if you assign a new IP address to a device currently in use, the new IP address does not take effect until the device's current address lease expires or until the device restarts.

A mismatch between the number of configured devices and the number of physical ring devices triggers an alarm. This mismatch can be a result of a topology change or a configuration change.

To configure a system with an active ring supervisor/active ring DHCP server and a backup ring supervisor/backup ring DHCP server, follow these steps.

1. On the switch to become the active ring supervisor/active ring DHCP server, complete these configurations:
  - Enable DHCP and DHCP snooping as shown in [Figure 15 on page 113](#).
  - Configure an IP address pool for ring devices as described on [page 131](#).
  - Configure the switch as a ring supervisor. Be sure to enable DLR Supervisor mode and set the role precedence to Primary.
  - Configure DHCP for ring devices. Be sure to enable the ring DHCP server, choose the Primary role, specify the number of ring devices, and add entries to the DLR DHCP configuration table.
  - Verify that the CIP VLAN is enabled on the switch and note the VLAN ID. You can enable the CIP VLAN in Express Setup.
2. On the switch to become the backup ring supervisor/backup ring DHCP server, complete these configurations:
  - Enable DHCP and DHCP snooping, as shown in [Figure 15 on page 113](#).

---

**IMPORTANT** To maintain proper operation of the switch upon a failover, do not create an IP address pool for the backup ring DHCP server. The backup ring DHCP server receives DHCP configuration from the active ring DHCP server.

---

- Configure the switch as a backup ring supervisor—be sure to enable DLR Supervisor mode with a role precedence of Backup 1.
  - Configure DHCP for ring devices—be sure to enable the ring DHCP server and choose the Backup role.
  - Verify that the CIP VLAN is enabled on the switch. You can enable this setting in the Advanced Settings under Express Setup.
3. Connect cables in the ring and verify that all ring devices are assigned the correct IP addresses.

## Multiple Rings

Stratix 5400 switches support as many as three rings with these configuration rules:

- Multiple rings cannot share the same ring ports. Valid ring ports are defined in [Table 37 on page 106](#).
- Ring ports function only as access ports.
- All ring ports within the same ring must be assigned to the same access VLAN.
- The same Stratix 5400 switch must serve as the active gateway for all rings.
- The same Stratix 5400 switch must serve as the backup gateway for all rings.

[Figure 17](#) shows an example of a Stratix 5400 switch configured for three rings and multiple VLANs. While this example illustrates the use of multiple VLANs, you can also use a single VLAN for all three rings.

**Figure 17 - Stratix 5400 Switch with Multiple Rings**

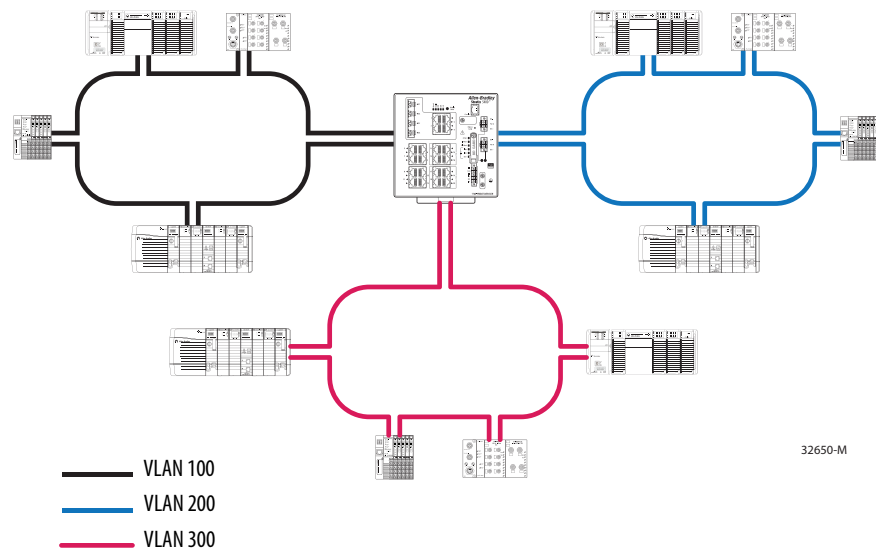

In a redundant gateway topology, you can also use multiple rings with Stratix 5400 switches, as shown in [Figure 18](#). While this example illustrates the use of multiple VLANs, you can also use a single VLAN for both rings.

**Figure 18 - Redundant Gateway Topology, Multiple Rings, Multiple or Single VLAN**

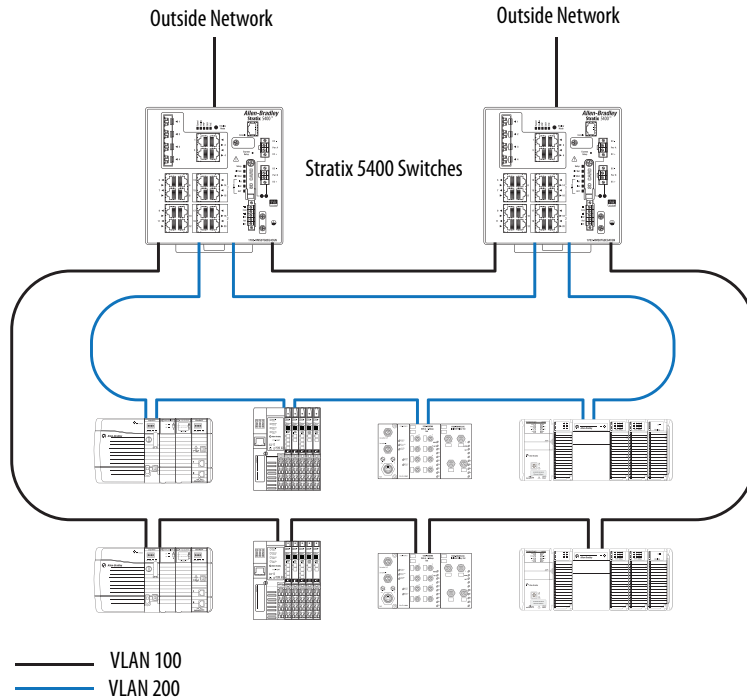

You can also use multiple rings with multiple Stratix 5400 switches in a non-redundant gateway topology, as shown in [Figure 19](#). However, the use of multiple Stratix 5400 switches in this topology requires each ring to be on a separate VLAN.

**Figure 19 - Non-redundant Gateway Topology, Multiple Rings, Multiple VLANs**

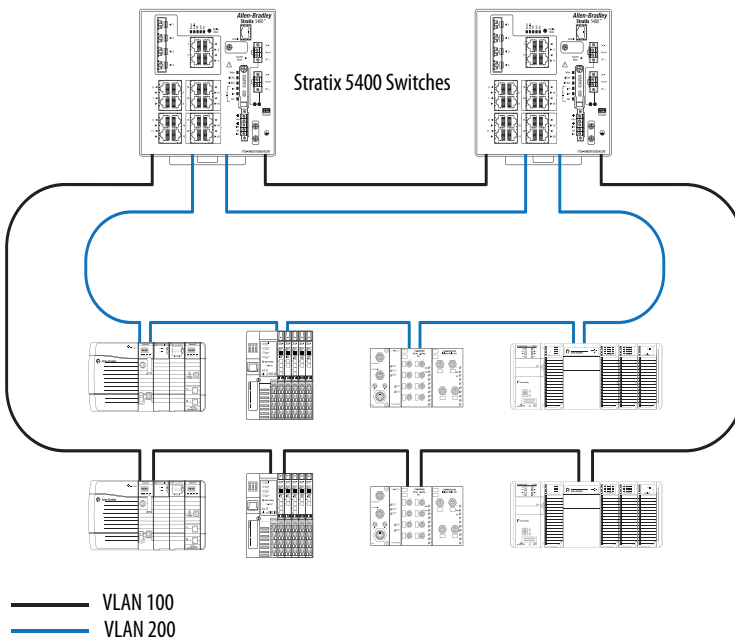

## Configure DLR via Device Manager

**IMPORTANT** Be sure to configure DLR on the switch prior to connecting ring ports. Connecting both ring ports on a switch that has not been configured for DLR can result in undesired behavior and limit the ability to configure the switch.

To configure DLR, follow these steps.

1. From the Configure menu, choose DLR.
2. (Stratix 5400 switches). From the DLR Ring ID pull-down menu, choose the ring to configure.
3. To configure the switch as a ring node or a ring supervisor, complete the fields on the Config DLR tab as described in [Table 40 on page 120](#).
4. To configure DHCP for ring devices, complete the fields on the Configure DHCP tab as described in [Table 41 on page 121](#) and click Submit.
  - To add an entry to the DLR DHCP configuration table, click Add Entry.
  - To add a range of entries, click Add Range.
  - To edit an existing entry, select it in the table and click Edit.
  - To delete an entry, select it and click Delete.

New rows are added to the end of the table. To change the position of a row (Index), select it and click Move to specify a different row number, or use the up and down arrows.

The screenshot displays the 'Network | DLR' configuration interface. At the top, there is a breadcrumb 'Network | DLR'. Below it, the 'DLR Ring ID' is set to 'Ring 1'. There are two tabs: 'Config DLR' (active) and 'Config DHCP'. Under 'Config DLR', the 'Mode' is set to 'Supervisor'. The 'Port1' is 'GigabitEthernet1/1' and 'Port2' is 'GigabitEthernet1/2'. A 'Supervisor Settings' section contains: 'Role(Precedence): None', 'Beacon Interval: 400 uSec', 'Beacon Timeout: 1960 uSec', and 'DLR Vlan Id: 0'. A 'Reset To Default Values' button is located at the bottom right of this section. At the bottom of the page, there is a checkbox for 'Enable Redundant Gateway' and a 'Submit' button.

**Table 40 - Config DLR Fields**

Field	Description
Mode	Choose one of these modes: <ul style="list-style-type: none"> <li>• Disabled—The DLR feature is disabled on the switch.</li> <li>• Node—The switch is a ring node.</li> <li>• Supervisor—The switch is a ring supervisor.</li> </ul> Default: Disabled
Port1	Choose a ring port. By default, if the switch is the ring supervisor, port 1 is node 1 on the ring, and port 2 is blocked.
Port2	Choose a ring port.
<b>Supervisor Settings</b>	
Role (Precedence)	Choose a role to assign to the ring supervisor that corresponds to a predefined precedence value. The switch transmits the precedence value in beacon frames and uses it to determine the active ring supervisor when multiple supervisors are configured. A higher value means higher precedence. When two DLR supervisors have the same precedence, the device with the numerically highest MAC ID becomes the active supervisor. Valid values: <ul style="list-style-type: none"> <li>• None—0</li> <li>• Primary—255</li> <li>• Backup 1—100</li> <li>• Backup 2—90</li> <li>• Backup 3—80</li> <li>• Custom—Type a value from 0 . . . 255</li> </ul>
Beacon Interval	Type an interval for the supervisor to transmit beacon frames. Valid values: 200 . . . 100,000 $\mu$ s Default: 400 $\mu$ s.
Beacon Timeout	Type the amount of time ring nodes wait before timing out in the absence of received beacon messages. Valid values: 200 . . . 500,000 $\mu$ s Default: 1960 $\mu$ s
DLR VLAN Id	Type the VLAN ID for sending DLR protocol management frames. Valid values: 0 . . . 4095 Default: 0 (no VLAN ID is used) <b>IMPORTANT:</b> DLR ports function only as access ports and not trunk ports.
<b>Redundant Gateway Settings</b>	
Enable Redundant Gateway	Check the checkbox to enable the configuration of redundant gateways. The configuration fields are available only after you enable the feature. Default: Disabled
Role (Precedence)	Choose a role to assign to the redundant gateway that corresponds to a predefined precedence value. The switch transmits the precedence value in advertise messages and is used to select the redundant gateway when multiple redundant gateways are configured. A higher value means higher precedence. When two DLR redundant gateways have the same precedence, the device with the numerically highest MAC ID becomes the redundant gateway. Valid values: <ul style="list-style-type: none"> <li>• None—0</li> <li>• Primary—255</li> <li>• Backup 1—100</li> <li>• Backup 2—90</li> <li>• Backup 3—80</li> <li>• Custom—Type a value from 0 . . . 255</li> </ul>
Advertise Interval	Type the time interval for the gateway to transmit advertise messages. Valid values: 200 . . . 100,000 $\mu$ s Default: 2000 $\mu$ s
Advertise Timeout	Type the duration of time for nodes to wait before timing out in the absence of received advertise messages. Valid values: 200 . . . 500,000 $\mu$ s Default: 5000 $\mu$ s
Learning Update	Check the checkbox to enable learning update messages. Default: Enabled
Uplink Ports	Check the checkbox for each uplink port on which to enable redundant gateway.



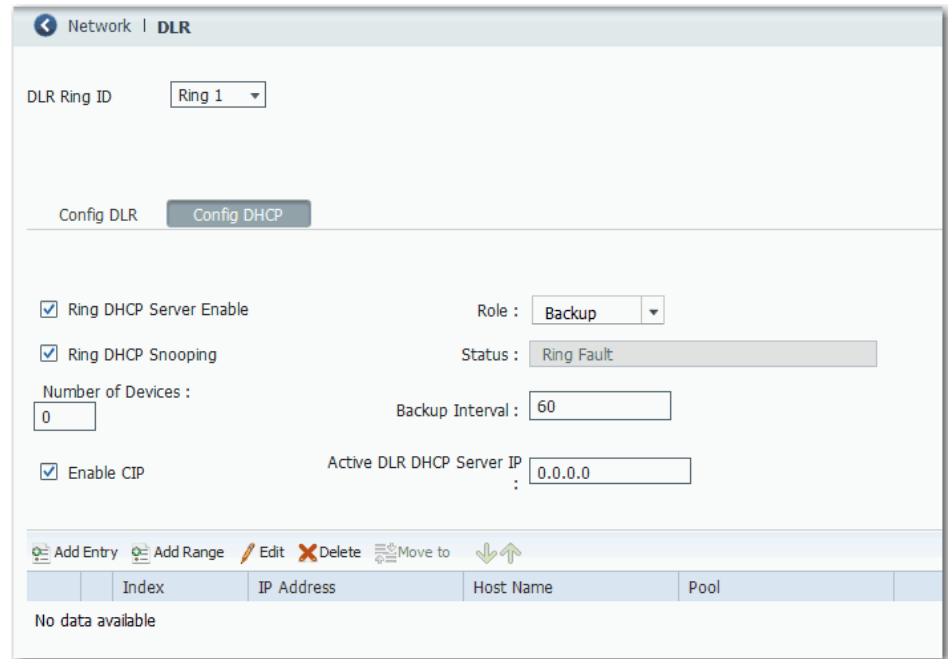

**Table 41 - Config DHCP Fields**

Field	Description
Ring DHCP Server Enable	Check the checkbox to enable the ring DHCP server on the DLR supervisor device.
Role	Choose a role to assign to the ring DHCP server. Valid values: <ul style="list-style-type: none"> <li>• None—The server is inactive.</li> <li>• Primary—The DLR supervisor functions as the active ring DHCP server.</li> <li>• Backup—The DLR supervisor functions as the backup ring DHCP server.</li> </ul>
Ring DHCP snooping	Check the checkbox to restrict the broadcast of DHCP requests from going beyond the ring. Only devices in the ring receive address assignments from the DHCP server. DHCP snooping is enabled by default. If you are not using DLR DHCP, you must disable Ring DHCP snooping to use DHCP server functionality outside of the ring.
Status	Displays the status of the ring. Valid values: <ul style="list-style-type: none"> <li>• Normal</li> <li>• Ring Fault</li> <li>• Unexpected Loop Detected</li> <li>• Partial Network Fault</li> <li>• Rapid Fault/Restore Cycle</li> </ul>
Number of Devices	Type the number of devices in the ring, including switches.
Backup Interval	Type the interval in seconds at which the backup ring DHCP server reads the reference table of the active ring DHCP server. Valid values: 1 . . . 65535 seconds Default: 60
Enable CIP	When the role of the ring DHCP server is Backup, check Enable CIP to enter the active ring DHCP server CIP IP address.
Active DLR DHCP Server IP	(Available only when Enable CIP is checked). Type the active ring DHCP server CIP IP address, which allows the backup ring DHCP server to sync information with the active ring DHCP server.
Index	Indicates the ring member location. Valid values: 2 . . . 255
IP Address	Indicates IP address of the ring member.
Host Name	Indicates host name associated with the IP address of the ring member.
Pool	Indicates the name of the pool of IP addresses available for DLR DHCP. The DHCP pool must be previously configured on the Global Settings tab on the DCHP page.

### Assign IP Addresses to Ring Devices

Use the table on the Config DHCP tab to assign IP addresses to devices based on their position in the ring.

To add IP addresses individually, click Add Entry.

Field	Description
Index	Type a value that indicates the location of the ring device. Valid values: 2 ...255
IP Address	Type the IP address for the entry.
Host Name	Type a host name to associate with the IP address for the entry.
DHCP Pool	Choose the name of the IP address pool to use for ring devices. This pool must be previously configured as described on <a href="#">page 134</a> . <b>IMPORTANT:</b> DHCP for ring devices does not work with DHCP persistence. Configure only one of these features on your switch.

To specify a range of IP addresses, click Add Range.

Field	Description
Starting Index	Type a value that indicates the starting location of the ring devices in the range. Valid values: 2 ...255
Starting IP Address	Type the starting IP address for the range of entries.
Number of Entries	Type the number of entries in the range.
DHCP Pool	Choose the name of the IP address pool to use for ring devices. This pool must be previously configured as described on <a href="#">page 131</a> . DHCP persistence and DHCP for ring devices can coexist, but cannot share the same pool.

## Configure DLR via the Logix Designer Application

Configuration parameters appear for the number of available rings:

- Stratix 5700 and ArmorStratix 5700 switches show one ring.
- Stratix 5400 switches show three rings.

Configure each ring:

- To enable DLR on specified ring ports and to view information about the DLR network, click Device Level Ring (DLR), and then complete the fields as described in [Table 42 on page 124](#).
- To configure a ring network, expand Device Level Ring (DLR), click Ring 1, Ring 2, or Ring 3, and then complete the fields as described in [Table 43 on page 125](#).
- To configure redundant gateways, expand Device Level Ring (DLR), expand Ring 1, Ring 2, or Ring 3, click Redundant Gateway Configuration, and then complete the fields as described in [Table 45 on page 127](#).
- To configure DHCP for ring devices, expand Device Level Ring (DLR), expand Ring 1, Ring 2, or Ring 3, click DHCP, and then complete the fields as described in [Table 46 on page 128](#).

To view the status and parameters that are configured for a ring, or to view the MAC and IP addresses of each device in the ring, see [Monitor DLR Status via the Logix Designer Application on page 325](#).

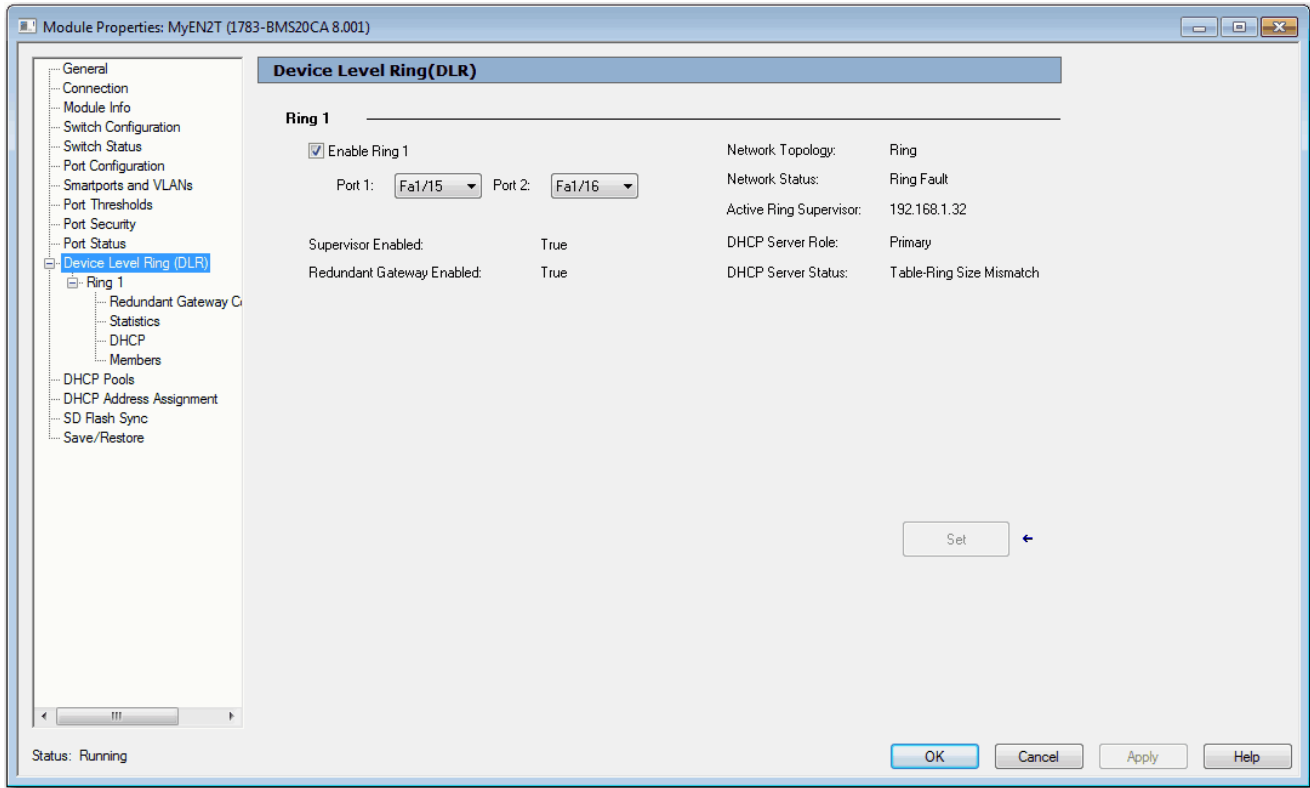
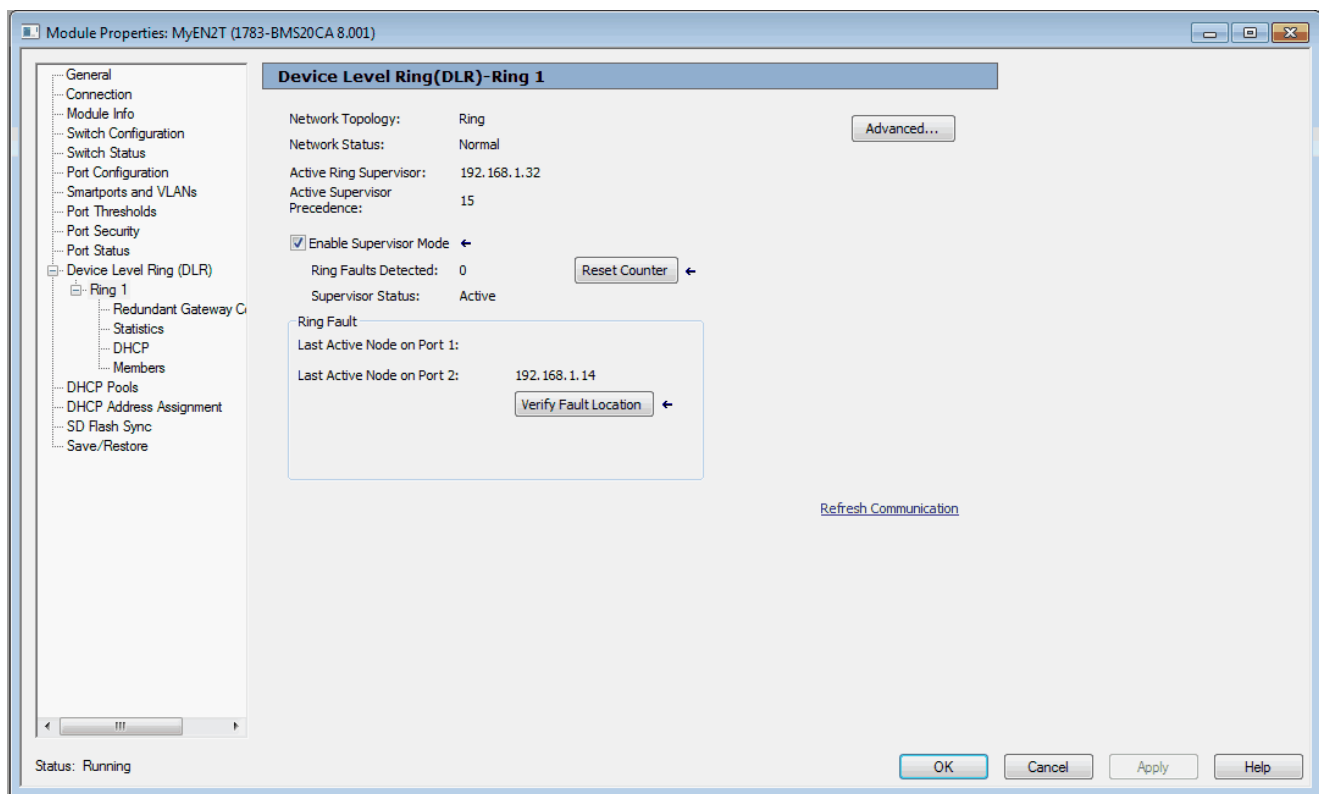

**Table 42 - Device Level Ring (DLR) Fields**

Field	Description
Enable Ring 1/Enable Ring 2/Enable Ring 3	Check to enable DLR on the ports that are specified in the associated Port 1 and Port 2 fields for the ring.
Port 1	Choose a ring port. The default value is None. This field is unavailable if the Enable Ring 1 checkbox is cleared.
Port 2	Choose a ring port. Port 1 and Port 2 cannot be the same port. The default value is None. This field is unavailable if the Enable Ring 1 checkbox is cleared.
Supervisor Enabled	Displays whether the switch is a ring supervisor. Valid values: <ul style="list-style-type: none"> <li>• True— The switch is a ring supervisor.</li> <li>• False—The switch is a ring node.</li> </ul>
Redundant Gateway Enabled	Displays whether redundant gateways are enabled for the ring.
Network Topology	Displays whether the switch is operating in a DLR or linear network. Valid values: <ul style="list-style-type: none"> <li>• Ring</li> <li>• Linear</li> </ul>
Network Status	Displays the status of the network. Valid values: <ul style="list-style-type: none"> <li>• Normal</li> <li>• Ring Fault</li> <li>• Unexpected Loop Detected</li> <li>• Partial Network Fault</li> <li>• Rapid Fault/Restore Cycle</li> </ul>

**Table 42 - Device Level Ring (DLR) Fields (Continued)**

Field	Description
Active Ring Supervisor	Displays the IP address of the active ring supervisor.
DCHP Server Role	Displays the role of the ring DHCP server. Valid values: <ul style="list-style-type: none"> <li>• Disabled</li> <li>• Primary</li> <li>• Secondary</li> <li>• Backup</li> </ul>
DHCP Server Status	Displays the status of the DHCP server. Valid values: <ul style="list-style-type: none"> <li>• Normal operation</li> <li>• Table-ring size mismatch</li> <li>• Table-ring order mismatch</li> <li>• IP address conflict</li> </ul>

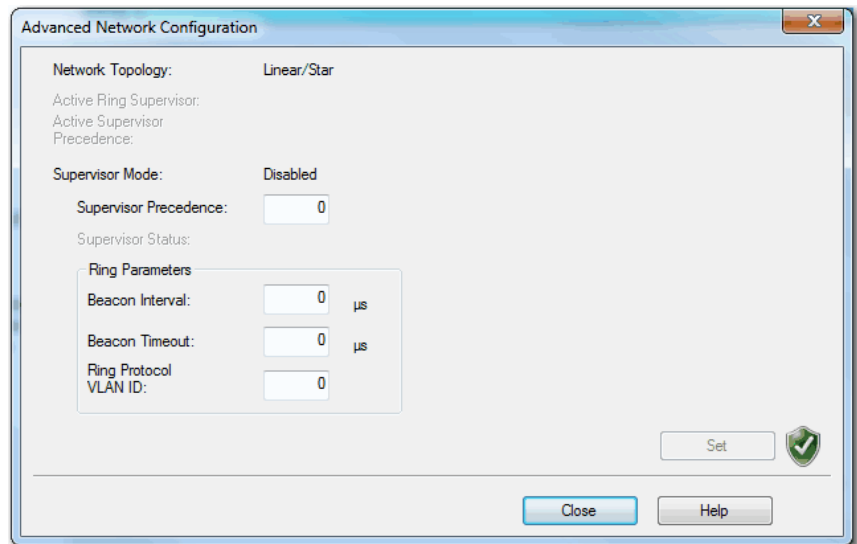

**Table 43 - Ring 1/Ring 2/Ring 3 Fields**

Field	Description
Network Topology	Displays whether the switch is operating in a DLR or linear network. Valid values: <ul style="list-style-type: none"> <li>• Ring</li> <li>• Linear</li> </ul>
Network Status	Displays the status of the network. Valid values: <ul style="list-style-type: none"> <li>• Normal</li> <li>• Ring Fault</li> <li>• Unexpected Loop Detected</li> <li>• Partial Network Fault</li> <li>• Rapid Fault/Restore Cycle</li> </ul>
Active Ring Supervisor	Displays the IP address of the active ring supervisor.

**Table 43 - Ring 1/Ring 2/Ring 3 Fields (Continued)**

Field	Description
Active Supervisor Precedence	Displays the precedence that is assigned to the ring supervisor. You assign the precedence value on the Advanced Network Configuration dialog box. See <a href="#">Table 44</a> .
Enable Supervisor Mode	Check to make the switch a ring supervisor. The configuration takes effect immediately.
Ring Faults Detected	Displays the number of faults that are currently detected in the ring. When a DLR network is powered-up, the supervisor can detect ring faults as a result of powering up before other devices on the network. You can use an MSG instruction to clear the faults.
Supervisor Status	Displays whether the switch is operating as the active ring supervisor or back-up ring supervisor. Valid values: <ul style="list-style-type: none"> <li>Active</li> <li>Backup</li> </ul>
Last Active Node on Port 1	Displays the IP address of the last active node on DLR port 1.
Last Active Node on Port 2	Displays the IP address of the last active node on DLR port 2.

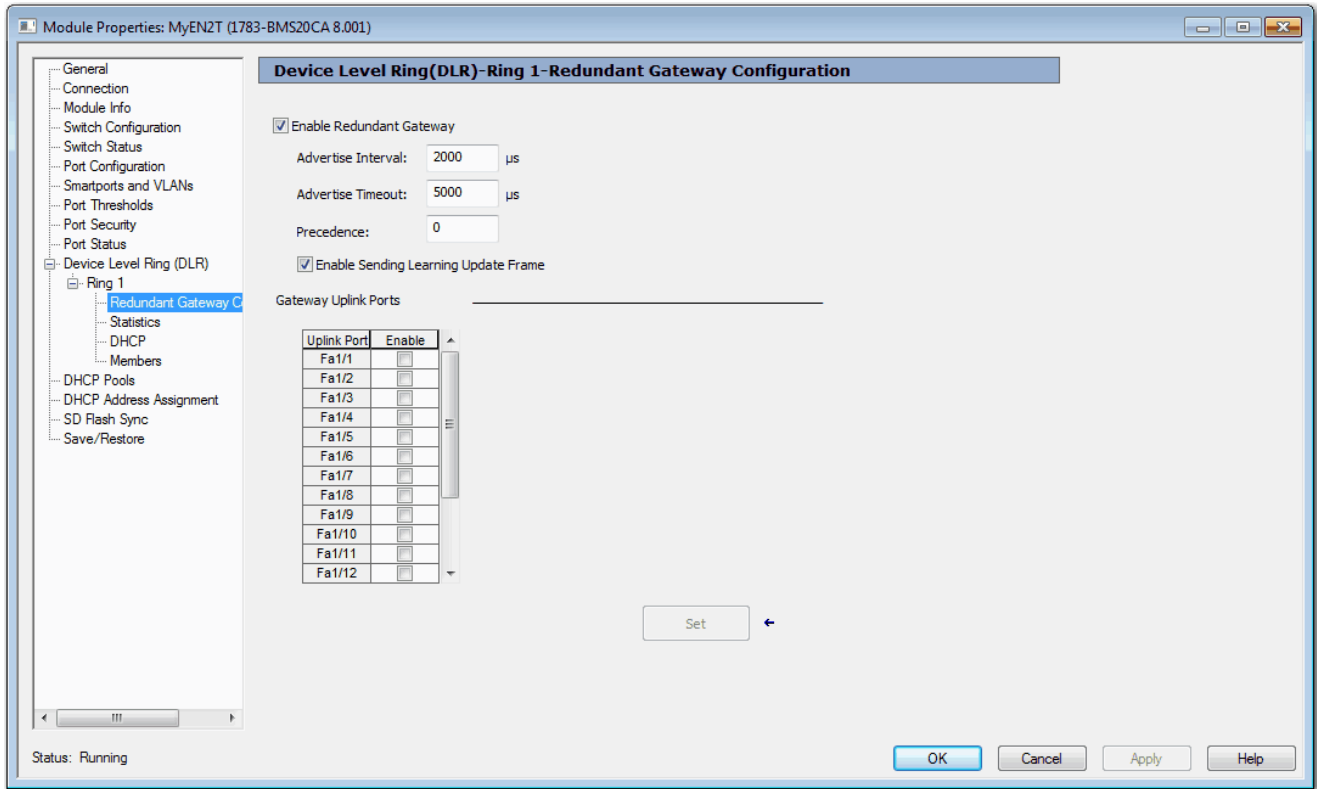

**Table 44 - Advanced Network Configuration Fields**

Field	Description
Network Topology	Displays whether the switch is operating in a DLR or linear network. Valid values: <ul style="list-style-type: none"> <li>Ring</li> <li>Linear</li> </ul>
Active Ring Supervisor	Displays the IP address of the active ring supervisor.
Active Supervisor Precedence	Displays the precedence that is currently assigned to the active ring supervisor.
Supervisor Mode	Displays the status of Supervisor mode. You can enable Supervisor mode on the Ring 1, Ring 2, or Ring 2 view. See <a href="#">Table 43</a> . Valid values: <ul style="list-style-type: none"> <li>Enabled</li> <li>Disabled (default)</li> </ul>
Supervisor Precedence	Type a precedence value to assign to the ring supervisor. When multiple supervisors are configured, the precedence value determines the active ring supervisor. Only one supervisor can be active at one time. The precedence is transmitted in beacon frames. When two supervisors have the same precedence, the device with the numerically highest MAC ID becomes the active supervisor. Valid values: 0...255. The default precedence is 0. The highest precedence is 255.

**Table 44 - Advanced Network Configuration Fields**

Field	Description
Beacon Interval	Type an interval for the supervisor to transmit beacon frames. Valid values: 200 . . . 100,000 $\mu$ s The default interval is 400 $\mu$ s.
Beacon Timeout	Type the amount of time ring nodes wait before timing out in the absence of received beacon messages. Valid values: 400 . . . 500,000 $\mu$ s The default timeout is 1960 $\mu$ s.
Ring Protocol VLAN ID	Reserved for future use.

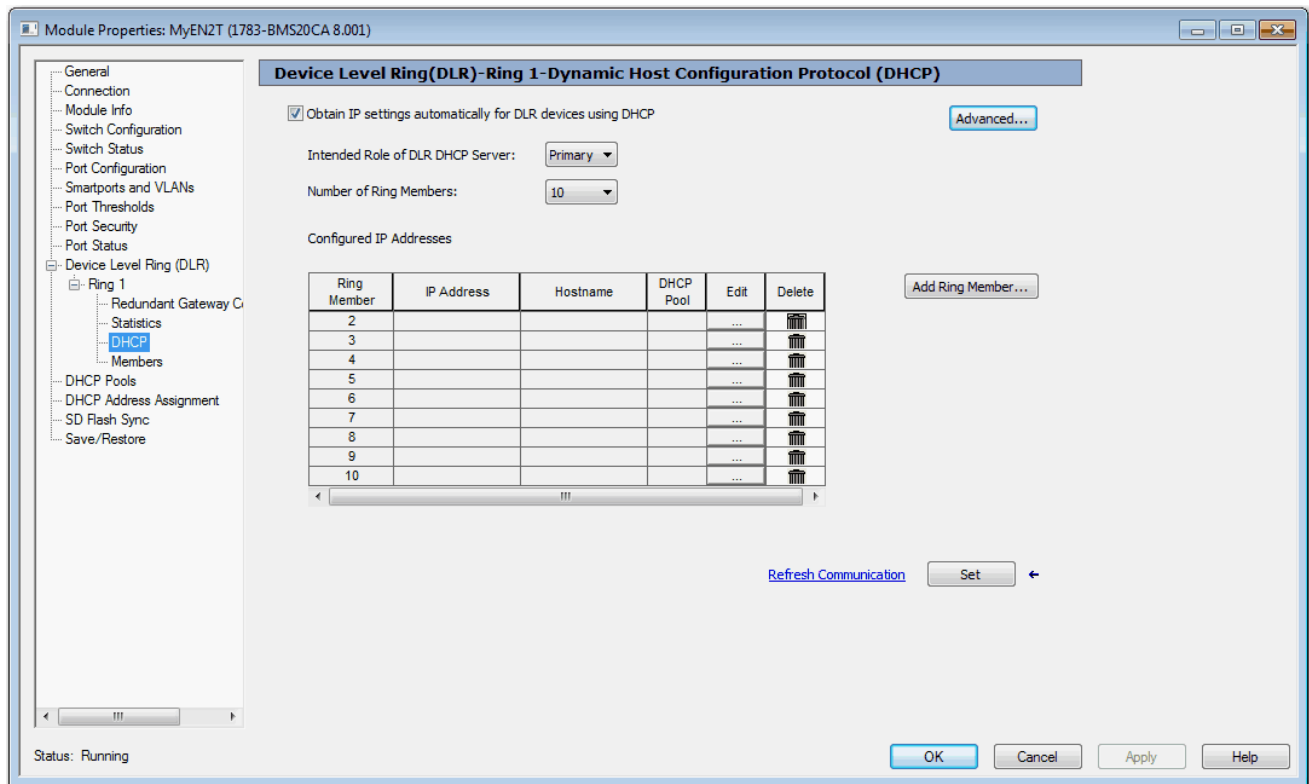

**Table 45 - Redundant Gateway Configuration Fields**

Field	Description
Enable Redundant Gateway	Check the checkbox to enable the configuration of redundant gateways. The configuration fields are available only after you enable the feature. Default: Disabled
Advertise Interval	Type the time interval for the gateway to transmit advertise messages. Valid values: 200 . . . 100,000 $\mu$ s Default: 2000 $\mu$ s
Advertise Timeout	Type the duration of time for nodes to wait before timing out in the absence of received advertise messages. Valid values: 200 . . . 500,000 $\mu$ s Default: 5000 $\mu$ s

**Table 45 - Redundant Gateway Configuration Fields (Continued)**

Field	Description
Precedence	Choose a role to assign to the redundant gateway that corresponds to a predefined precedence value. The switch transmits the precedence value is advertise messages and is used to select the redundant gateway when multiple redundant gateways are configured. A higher value means higher precedence. When two DLR redundant gateways have the same precedence, the device with the numerically highest MAC ID becomes the redundant gateway. Valid values: <ul style="list-style-type: none"> <li>• None—0</li> <li>• Primary—255</li> <li>• Backup 1—100</li> <li>• Backup 2—90</li> <li>• Backup 3—80</li> <li>• Custom—Type a value from 0...255</li> </ul>
Enable Sending Learning Update Frame	Check the checkbox to enable learning update messages. Default: Enabled
Gateway Uplink Ports	Check the Enable checkbox for each uplink port on which to enable redundant gateway.



**Table 46 - DHCP Fields**

Field	Description
Obtain IP settings automatically for DLR devices using DHCP	Check the checkbox to enable the ring DHCP server on the DLR supervisor device.
Intended Role of DHCP Server	Choose the role to assign to the DHCP server: <ul style="list-style-type: none"> <li>• Primary—The DLR supervisor functions as the active ring DHCP server.</li> <li>• Backup—The DLR supervisor functions as the backup ring DHCP server.</li> </ul>
Number of Ring Members	Choose the number of devices in the ring, including switches.
Ring Member	Displays the order of devices in the ring when the switch is the ring supervisor. The switch is always ring member 1.



**Table 46 - DHCP Fields**

Field	Description
IP Address	Displays the IP address of the ring member. The IP address is reserved for the selected port and is not available for normal DHCP assignment. The IP address must be an address from the pool specified in DHCP IP address pool. To assign IP addresses to ring members, see Refer to <a href="#">Assign IP Addresses to Ring Members on page 130</a> .
Hostname	Displays the name for the host associated with the ring member.
DHCP Pool	Displays the name of the DHCP IP address pool configured on the switch.

### *Enable Ring DHCP Snooping*

To enable DHCP snooping within the ring, click Advanced and check the Enable DLR DHCP Snooping checkbox.

Ring DHCP snooping restricts the broadcast of DHCP requests from going beyond the ring. Only devices in the ring receive address assignments from the DHCP server.

DHCP snooping is enabled by default. If you are not using DLR DHCP, you must disable Ring DHCP snooping to use DHCP server functionality outside of the ring.

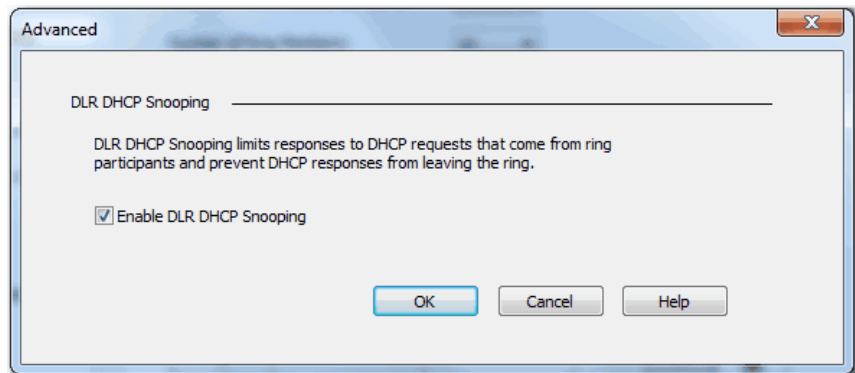

### Assign IP Addresses to Ring Members

1. Click Add Ring Member to display the Add Ring Member dialog box.

2. From the DHCP Pool field, choose the name of the IP address pool to use for ring devices.  
This pool must be previously configured as described on [page 136](#).  
DHCP persistence and DHCP for ring devices can coexist, but cannot share the same pool.
3. To assign an IP address to a single ring member, click Add a Single Ring Member into Table, and then complete these fields:
  - Ring Member—Type a value between 2 ...255 to indicate the location of the ring device. The switch is always ring member 1.
  - Hostname—Type a host name to associate with the IP address for the ring member.
  - IP Address—Type the IP address for the ring member.
4. To assign IP addresses to multiple ring members, click Add Multiple Ring Members into Table, and then complete these fields:
  - Ring Member...To—Type values between 2 ...255 to indicate the starting and ending locations of the ring members.
  - IP Address...To—Type the starting and ending IP addresses for the ring members.
5. Click OK.

## Dynamic Host Configuration Protocol (DHCP) Persistence

Every device in an IP-based network must have a unique IP address. DHCP assigns IP address information from a pool of available addresses to newly connected devices (DHCP clients) in the network. If a device leaves and then rejoins the network, the device receives the next available IP address, which is not necessarily the same address that it had before.

The switch can be set to operate as a DHCP server to provide DHCP persistence. With DHCP persistence, you can assign a specific IP address to each port to make sure that a device that is attached to a specific port receives the same IP address. This feature works with only one device that is connected to each port configured for DHCP persistence. The DHCP server also serves addresses to BOOTP clients.

---

**IMPORTANT** To make sure DHCP persistence works correctly, follow the application rules.

---

---

**IMPORTANT** DHCP persistence does not work with DHCP for ring devices as described on [page 113](#). Configure only one of these features on your switch.

---

You can assign an IP address from the IP address pool to a specific switch port. A device that is connected to that switch port always receives the address that you assigned to the port regardless of its MAC ID.

DHCP persistence is useful in networks that you configure in advance, where dependencies on the exact IP addresses of some devices exist. Use DHCP persistence when the attached device has a specific role to play and when other devices know its IP address. If the device is replaced, the replacement device is assigned the same IP address, and the other devices in the network require no reconfiguration.

When the DHCP persistence feature is enabled, the switch acts as a DHCP server for other devices on the same subnet, including devices that are connected to other switches. If the switch receives a DHCP request, it responds with any unassigned IP addresses in its pool. To keep the switch from responding when it receives a request, check the Reserve Only box on the DHCP page.

When DHCP persistence is enabled and a DHCP request is made from a connected device on that port, the switch assigns the IP address for that port. It also broadcasts the DHCP request to the remainder of the network. If another DHCP server with available addresses is on the network and receives this request, it can try to respond. The response can override the initial IP address the switch assigns depending on how the end device behaves (takes first IP address response or the last). To keep the IP address from being overridden, enable DHCP snooping on the appropriate VLAN. Enabling DHCP snooping blocks the broadcast of this DHCP request, so that no other server, including another Stratix switch with DHCP persistence enabled, responds.

If you are using DHCP persistence, we recommend that you initially assign static IP addresses to end devices. If an end device fails and is replaced, the DHCP persistence feature assigns an IP address from the DHCP persistence table. The device functions properly with this IP address, but we recommend that you reassign a static IP address to the replaced devices.

The following figure and table illustrate DHCP persistence behavior.

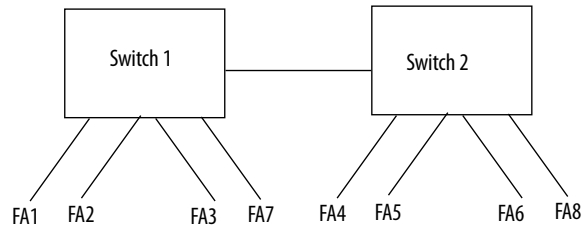

**Table 47 - DHCP Persistence Behavior**

If	Then
<ul style="list-style-type: none"> <li>• Switch 1 has ports FA1...FA3 in its persistence table</li> <li>• Switch 2 has ports FA4, FA5, FA6, and FA8 in its persistence table</li> <li>• Reserve Only is not selected and DHCP snooping is off</li> </ul>	A new device that is connected to switch 1 FA1 receives an IP address from the switch 1 persistence table. A broadcast request is also sent across the network. Switch 2 responds if there is an unassigned address in its pool. The response can override the assignment that is made by switch 1.
<ul style="list-style-type: none"> <li>• Switch 1 has ports FA1...FA3 in its persistence table</li> <li>• Switch 2 has ports FA4, FA5, FA6, and FA8 in its persistence table</li> <li>• Reserve Only is selected in both switches and DHCP snooping is off</li> </ul>	A new device that is connected to switch 1 FA1 receives an IP address from the switch 1 persistence table. A broadcast request is also sent across the network. Switch 2 does not respond to the request. If the device is connected to FA7 of switch 1, it does not receive an IP address from the switch pool because it is not defined in the persistence table. Also, unused addresses in the pool are blocked.
<ul style="list-style-type: none"> <li>• Switch 1 has ports FA1...FA3 in its persistence table</li> <li>• Switch 2 has ports FA4, FA5, FA6, and FA8 in its persistence table</li> <li>• Reserve Only is selected in switch 1 and DHCP snooping is off, but not switch 2 when DHCP snooping is off</li> </ul>	A new device is connected to FA1 receives an IP address from the persistence table. A broadcast request is also sent across the network. Switch 2 does not respond to the request. In addition, a device that is connected to FA4 receives an IP address from the switch 2 persistence table. A broadcast request is sent out, and switch 1 responds with an unused IP address from its pool. The response can override the assigned port.
<ul style="list-style-type: none"> <li>• Switch 1 has ports FA1...FA3 in its persistence table</li> <li>• Switch 2 has ports FA4, FA5, FA6, and FA8 in its persistence table</li> <li>• DHCP Snooping is selected</li> <li>• Reserved Only is checked</li> </ul>	A new device that is connected to switch 1 FA1 receives an IP address from the Switch 1 persistence table. A broadcast request is not sent across the network, so Switch 2 does not respond. If a device is connected to FA7 of Switch 1, it does not receive an IP address from the switch pool because it is not defined in the persistence table. Also, unused addresses in the pool are blocked.
<ul style="list-style-type: none"> <li>• Switch 1 has ports FA1...FA3 in its persistence table</li> <li>• Switch 2 has ports FA4, FA5, FA6, and FA8 in its persistence table</li> <li>• DHCP Snooping is selected</li> <li>• Reserved Only is not checked</li> </ul>	A new device that is connected to switch 1 FA1 receives an IP address from the Switch 1 persistence table. A broadcast request is not sent across the network, therefore Switch 2 does not respond. If a device is connected to FA7 (not defined in the DHCP persistence table) of Switch 1, it receives an unassigned IP address from the switch 1 pool.

## Configure DHCP Persistence via Device Manager

To configure DHCP persistence, complete this process.

1. Configure the DHCP server.
2. Configure the IP address pool.
3. Assign an IP address to a switch port.

*Configure the DHCP Server.*

1. From the Configure menu, choose DHCP.

Network | DHCP

Global Settings | DHCP Persistence

Enable DHCP:

DHCP Snooping:

Submit

DHCP Pool Table

Add Edit Delete

Pool Name	Network	Network Mask	VLAN	Reserved Only	DHCP Snooping
No data available					

2. Check the Enable DHCP checkbox.
3. To enable DHCP snooping, check the DHCP Snooping checkbox.

DHCP snooping restricts the broadcast of DHCP requests beyond the connected switch. As a result, devices receive address assignments from only the connected switch. This option is available only on ports assigned to a VLAN. To enable DHCP snooping on a specific VLAN, check the DHCP Snooping checkbox for the specific VLAN in the DHCP pool table.

4. To reserve an address pool for only the devices that are specified in the DHCP persistence table, check the Reserved Only checkbox in the DHCP pool table.

DHCP requests from ports not in the persistence table or from another switch are ignored. By default, this option is disabled and the Reserved Only checkbox is cleared.

5. Click Submit.

### Configure the DHCP IP Address Pool

Once DHCP is enabled, you can create the DHCP address pool.

**IMPORTANT** If you are setting up DHCP for ring devices, to avoid switch failure upon a switchover, do not create an IP address pool for the backup ring DHCP server. The backup ring DHCP server receives IP addresses from the active ring DHCP server.

1. From the Configure menu, choose DHCP.
2. Click Add.

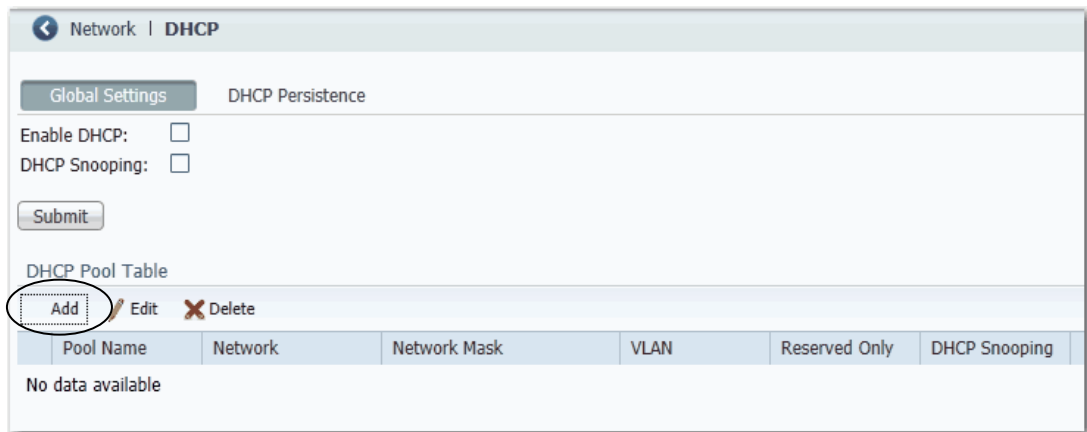

3. Complete the fields and click OK.

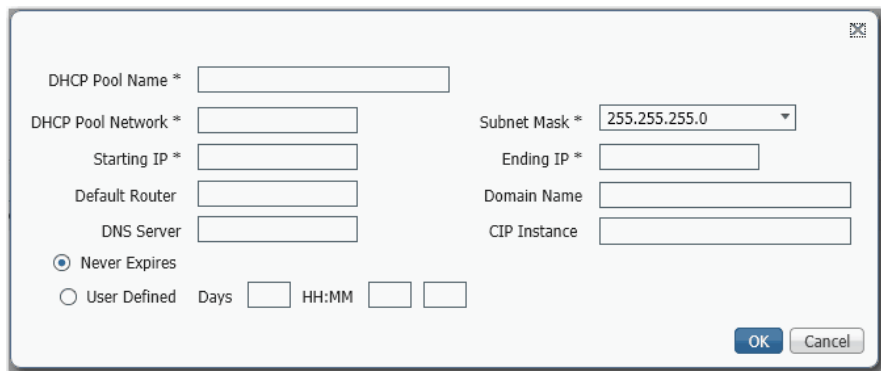

Field	Description
DHCP Pool Name	The name of the DHCP IP address pool that is configured on the switch. The name can have up to 31 alphanumeric characters. The name cannot contain a ? or a tab. This field is required. A DHCP IP address pool is a range (or pool) of available IP addresses that the switch can assign to connected devices.
DHCP Pool Network	The subnetwork IP address of the DHCP IP address pool. The format is a 32-bit numeric address that is written as four numbers that are separated by periods. Each number can be from 0...255. This field is required.
Subnet Mask	The network address that identifies the subnetwork (subnet) of the DHCP IP address pool. Subnets segment the devices in a network into smaller groups. The default is 255.255.255.0. This field is required.
Starting IP	The starting IP address that defines the range of addresses in the DHCP IP address pool. The format is a 32-bit numeric address that is written as four numbers that are separated by periods. Each number can be from 0...255. Be sure that none of the IP addresses that you assign are being used by another device in your network. This field is required.

Field	Description
Ending IP	The ending IP address that defines the range of addresses in the DHCP IP address pool. The format is a 32-bit numeric address that is written as four numbers that are separated by periods. Each number can be from 0 . . . 255. Make sure that none of the IP address you assign are being used by other devices in your network. This field is required.
Default Router	The default router IP address for the DHCP client that uses this server. The format is a 32-bit numeric address that is written as four numbers that are separated by periods. Each number can be from 0 . . . 255.
Domain Name	The domain name for the DHCP client. The name can have up to 31 alphanumeric characters. The name cannot contain a ? or a tab.
DNS Server	The IP addresses of the domain name system (DNS) IP servers available to a DHCP client. The format is a 32-bit numeric address that is written as four numbers that are separated by periods. Each number can be from 0 . . . 255.
CIP Instance	A number from 1 . . . 15 to identify the address pool.
[Lease Length]	The duration of the lease for an IP address that is assigned to a DHCP client. Click one of the following: <ul style="list-style-type: none"> <li>Never Expires</li> <li>User Defined</li> </ul> If you click User Defined, enter the duration of the lease in the numbers of days, hours, and minutes. This lease length is used for all assignments.

### Assign an IP Address to a Switch Port

To manage switch port IP addresses, click the DHCP Persistence tab.

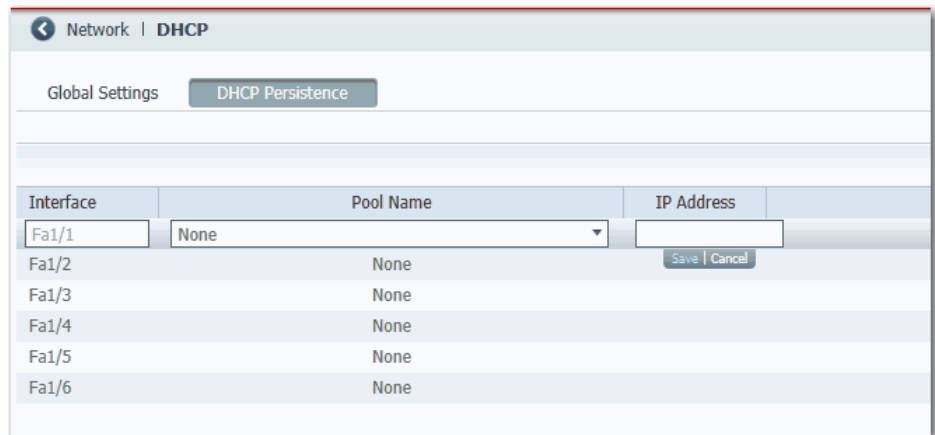

**Table 48 - DHCP Persistence Fields**

Field	Description
Interface	The number of the switch port, including port type (such as Fa for Fast Ethernet and Gi for Gigabit Ethernet), and the specific port number. For example, Fa1/1 is Fast Ethernet port 1 on the switch.
Pool Name	The name of the DHCP IP address pool that is configured on the switch.
IP Address	The IP address that is assigned to the switch port. The IP address that you assign is reserved for the selected port and is not available for normal DHCP dynamic assignment. The IP address must be an address from the pool that is specified in the DHCP Pool Name field.

## Configure DHCP Persistence via the Logix Designer Application

To configure DHCP persistence, complete this process.

1. Configure the DHCP server.
2. Configure the IP address pool.
3. Assign an IP address to a switch port.

### Configure the DHCP Server

1. In the navigation pane, click DHCP Pools.

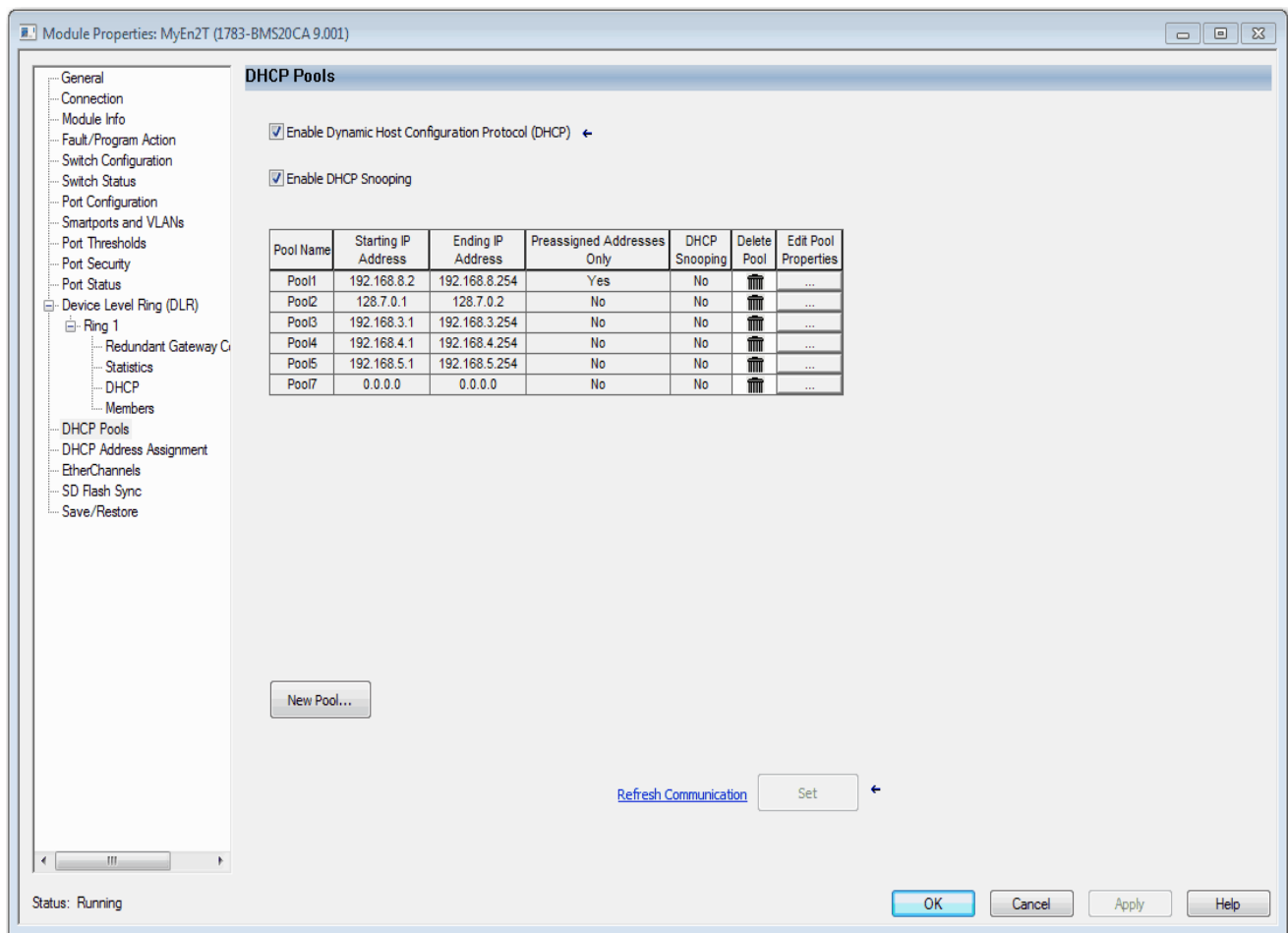

2. Check Enable Dynamic Host Configuration Protocol (DHCP).
3. To enable DHCP snooping, check Enable DHCP Snooping.

DHCP snooping restricts the broadcast of DHCP requests beyond the connected switch. As a result, devices receive address assignments from only the connected switch. This option is available only on ports assigned to a VLAN. To enable DHCP snooping on a specific VLAN, check the DHCP Snooping checkbox for the specific VLAN in the DHCP pool table.



### Configure the DHCP IP Address Pool

Once DHCP is enabled, you can create the DHCP address pool.

1. In the navigation pane, click DHCP Pools.
2. Click New Pool.

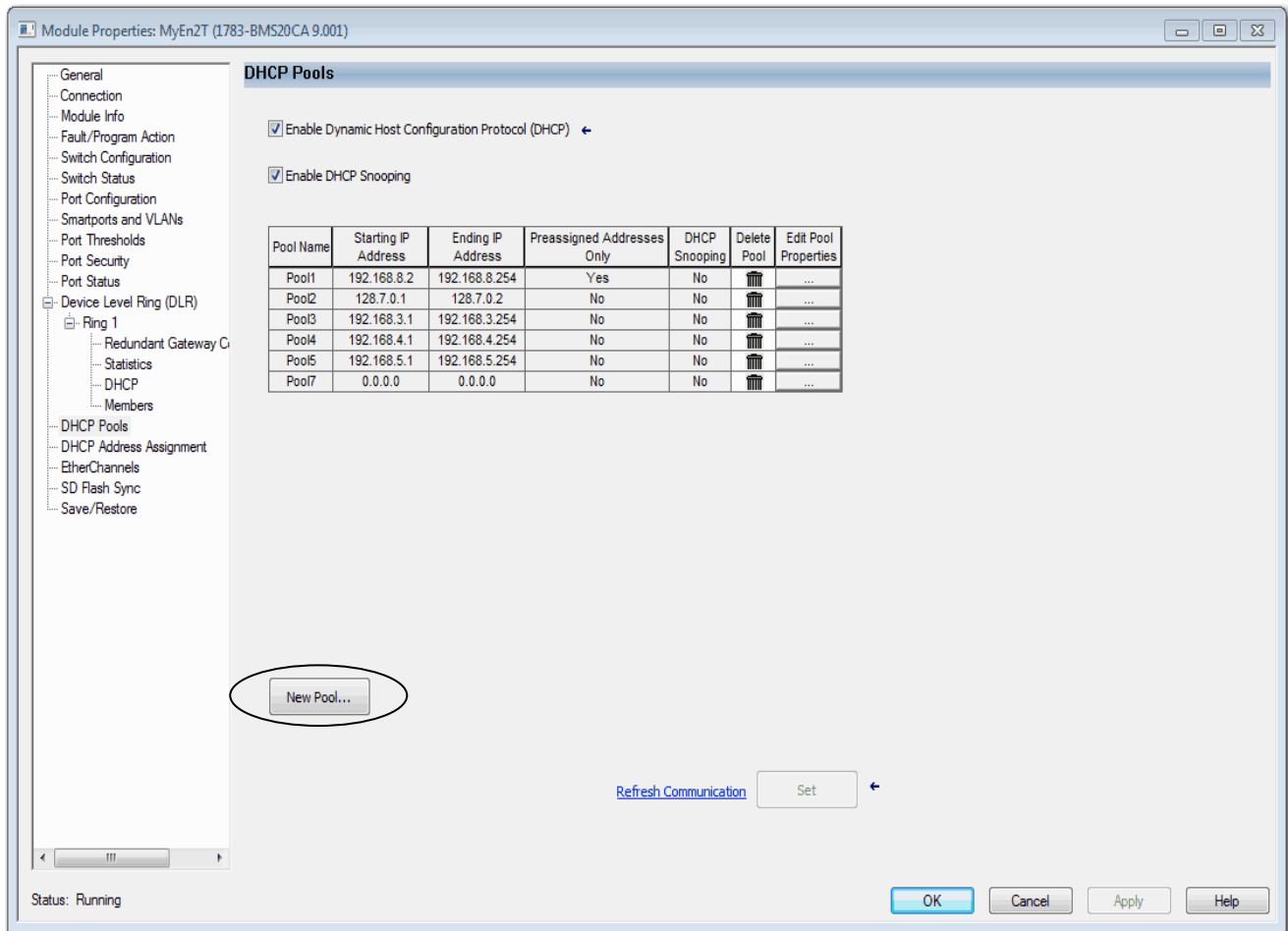

3. Complete the fields and click Close.

**Table 49 - Add/Edit DHCP Pool Definition Fields**

Field	Description
DHCP Pool Name	The name of the DHCP IP address pool that is configured on the switch. A DHCP IP address pool is a range (or pool) of available IP addresses that the switch can assign to connected devices.
DHCP Pool Network	The subnetwork IP address of the DHCP IP address pool. The format is a 32-bit numeric address that is written as four numbers that are separated by periods. Each number can be from 0 . . . 255. This field is required.
Subnet Mask	The network address that identifies the subnetwork (subnet) of the DHCP IP address pool. Subnets segment the devices in a network into smaller groups. The default is 255.255.255.0. This field is required.
Default Gateway	The default gateway IP address for the DHCP client. The format is a 32-bit numeric address written as four numbers separated by periods (for example, 255.255.255.255). Each number can be from 0 . . . 255.
Domain Name	The domain name for the DHCP client.
Starting IP Address	The starting IP address that defines the range of addresses in the DHCP IP address pool. The format is a 32-bit numeric address that is written as four numbers that are separated by periods. Each number can be from 0 . . . 255. Be sure that none of the IP addresses that you assign are being used by another device in your network. This field is required.
Ending IP Address	The ending IP address that defines the range of addresses in the DHCP IP address pool. The format is a 32-bit numeric address that is written as four numbers that are separated by periods. Each number can be from 0 . . . 255. Make sure that none of the IP address you assign are being used by other devices in your network. This field is required.
Use Preassigned Addresses Only	If checked, IP addresses are assigned only when configured for specific ports on the DHCP Address Assignment or DLR DHCP views.
Enable DHCP Snooping for this Pool	If checked, devices only receive address assignments from the connected switch.
Never Expires or Custom	The duration of the lease for an IP address that is assigned to a DHCP client. Click one of the following: <ul style="list-style-type: none"> <li>Never Expires</li> <li>Custom</li> </ul> If you click Custom, enter the duration of the lease in the numbers of days, hours, and minutes. This lease length is used for all assignments.

**Table 49 - Add/Edit DHCP Pool Definition Fields (Continued)**

Field	Description
Primary DNS Address	The IP addresses of the primary domain name system (DNS) IP servers available to a DHCP client.
Secondary DNS Address	The IP addresses of the secondary domain name system (DNS) IP servers available to a DHCP client.
Primary WINS Address	The IP address of the primary Microsoft NetBIOS name server (WINS server) available to a DHCP client.
Secondary WINS Address	The IP address of the secondary Microsoft NetBIOS name server (WINS server) available to a DHCP client.

*Assign an IP Address to a Switch Port*

In the navigation pane, click DHCP Address Assignment.

You can assign a specific IP address to each port, so that the device attached to a given port receives the same IP address.

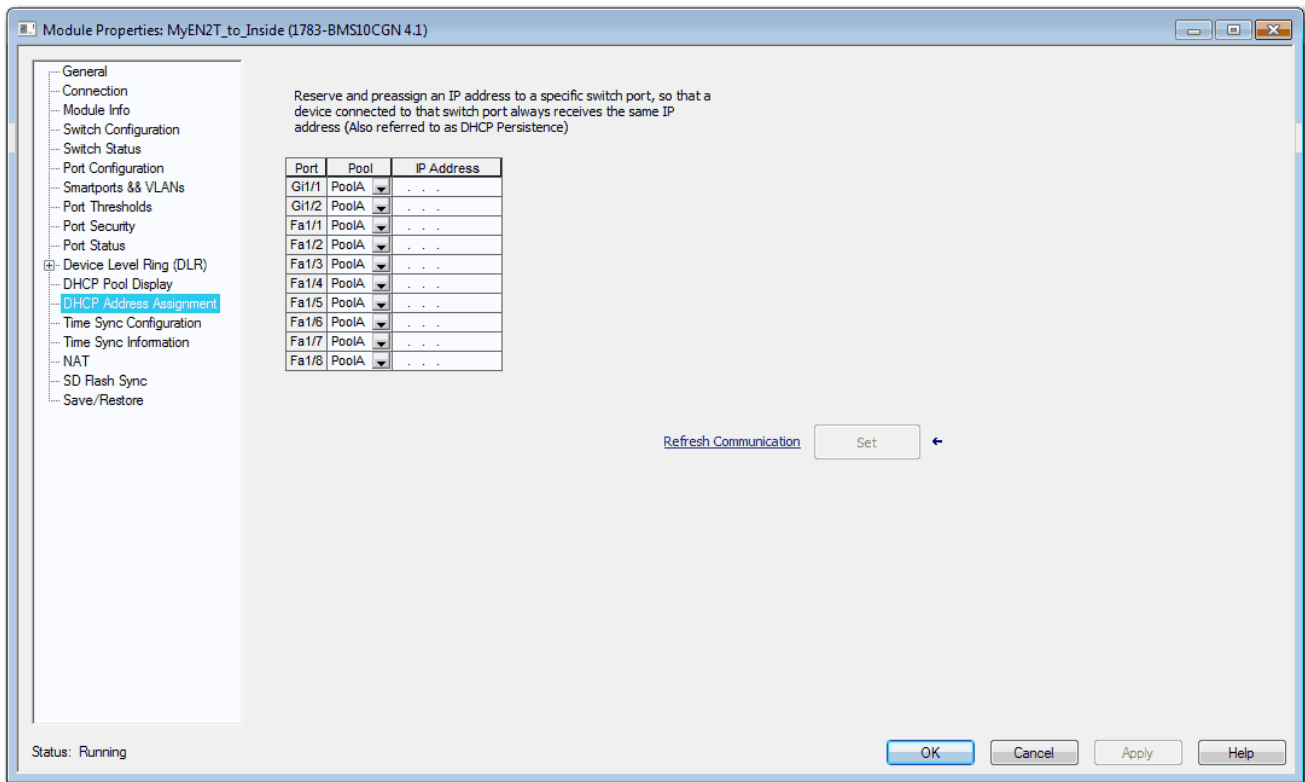

**Table 50 - DHCP Address Assignment Fields**

Field	Description
Unit (Stratix 8000/8300 switches)	Displays the unit on which the selected port resides: <ul style="list-style-type: none"> <li>• 6 Port Base</li> <li>• 10 Port Base</li> <li>• Expansion 1</li> <li>• Expansion 2</li> </ul>
Port	Displays the ports available for the configuration. The port number includes the port type (Fa for Fast Ethernet and Gi for Gigabit Ethernet), the base or expansion module number (1, 2, or 3), and the port number: <ul style="list-style-type: none"> <li>• Gi1/1 is Gigabit Ethernet port 1 on the base.</li> <li>• Fa1/1 is Fast Ethernet port 1 on the base.</li> <li>• Fa2/1 is Fast Ethernet port 1 on the first expansion module.</li> <li>• Fa3/1 is Fast Ethernet port 1 on the second expansion module.</li> </ul>
Pool	Displays the pool names from the DHCP IP address pool that corresponds to the instances available in the switch. If you delete all rows that contain pools on the DHCP Pool Display tab and click Refresh, the Pool field is blank.
IP Address	Displays the IP address that is assigned to the switch port. The format is a 32-bit numeric address that is written as four numbers that are separated by periods (for example, 255.255.255.255). Each number can be from 0...255. The IP address that you assign is reserved for the selected port and is not available for normal DHCP dynamic assignment. The IP address must be an address from the pool that is specified in the DHCP Pool Name field.

## Enhanced Interior Gateway Routing Protocol (EIGRP)

EIGRP is available on the following switches:

- Stratix 5400 with Layer 3 firmware
- Stratix 5410 with Layer 3 firmware
- Stratix 8300 base units

EIGRP is a Cisco proprietary, distance-vector-routing protocol. Key capabilities that distinguish EIGRP from other routing protocols include fast convergence, support for variable-length subnet mask, support for partial updates, and support for multiple network layer protocols.

A router that runs EIGRP stores all neighbor routing tables so that it can quickly adapt to alternate routes. If no appropriate route exists, EIGRP queries its neighbors to discover an alternate route. These queries propagate until an alternate route is found. Its support for variable-length subnet masks permits routes to be automatically summarized on a network number boundary. In addition, EIGRP can be configured to summarize on any bit boundary at any interface. EIGRP does not make periodic updates. Instead, it sends partial updates only when the metric for a route changes. Propagation of partial updates is automatically bounded so that only those routers that need the information are updated.

Neighbor discovery is the process that the EIGRP router uses to learn dynamically of other routers on directly attached networks. EIGRP routers send out multicast hello packets to announce their presence on the network. You can also define static neighbors, which receive unicast packets. When the router receives a hello packet from a new neighbor, it sends its topology table to the neighbor with an initialization bit set. When the neighbor receives the topology update with the initialization bit set, the neighbor sends its topology table back to the EIGRP router. Once this neighbor relationship is established, routing updates are not exchanged unless there is a change in the network topology.

EIGRP uses the Diffusing Update Algorithm (DUAL), which provides loop-free operation at every instance throughout a route computation. DUAL allows all devices that are involved in a topology change to synchronize simultaneously. Routers that are not affected by topology changes are not involved in recomputations.

To configure EIGRP, create an EIGRP instance and associate networks. EIGRP sends updates to the interfaces in the specified networks. If you do not specify an interface network, it is not advertised in any EIGRP update.

## Configure EIGRP via Device Manager

From the Configure menu, choose EIGRP.

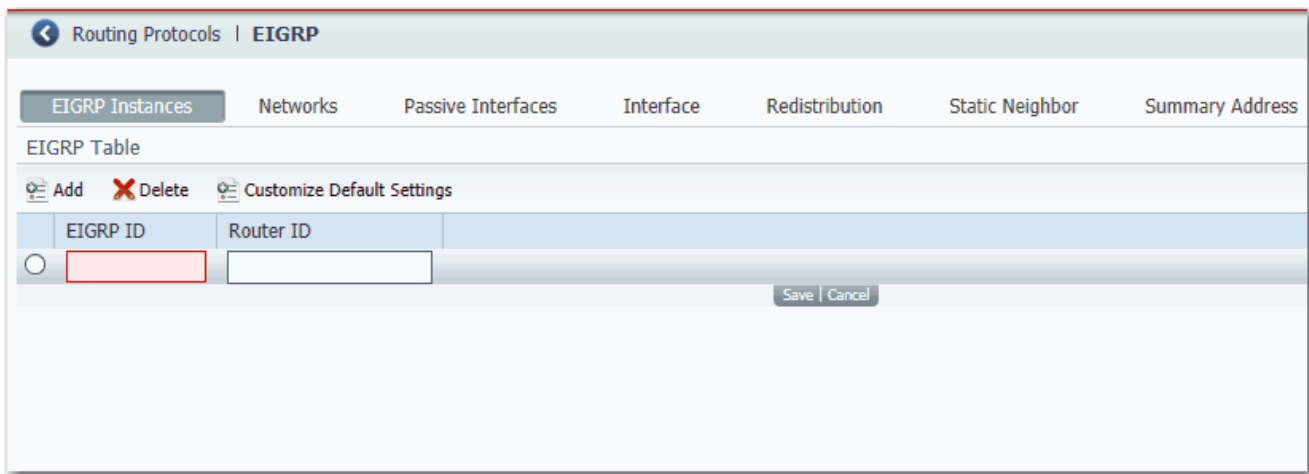

**Table 51 - EIGRP Fields**

Field	Description
<b>EIGRP Instances</b> —Add EIGRP instances to the EIGRP table. To customize the default settings for an instance, see <a href="#">page 144</a> .	
EIGRP ID	Type the Autonomous System (AS) number of the EIGRP routing process. Valid values: 1...65535.
Router ID	Type the IP address of the router that is associated with the EIGRP instance.
<b>Networks</b> —Add EIGRP networks to the Network table.	
EIGRP ID	Choose the Autonomous System (AS) number of the EIGRP routing process.
Network Address	Type the address of the network that is associated with an EIGRP routing process. EIGRP sends updates to the interfaces in the specified networks.
Wildcard Mask	Choose a wildcard mask. A wildcard mask indicates a subnetwork, bitwise complement of the subnet mask.
<b>Passive Interfaces</b> —Add passive interfaces to help prevent other routers on a local network from dynamically learning about routes.	
EIGRP ID	Choose an EIGRP ID.
Suppress routing updating on all interfaces	Check the checkbox to suppress routing update messages from being sent through all interfaces.
Interface	Choose a Layer 3 interface to suppress sending routing updates through.
Passive	Check the checkbox to suppress routing update messages from being sent through the corresponding interface.
<b>Interface</b> —Add EIGRAP interface instances.	
EIGRP ID	Choose the Autonomous System (AS) number of the EIGRP routing process.

Table 51 - EIGRP Fields (Continued)

Field	Description
Interface	Choose a Layer 3 interface that is associated with the EIGRP ID.
Hello Interval	Type the hello interval for the EIGRP interface instance. Valid values: 1 . . 65535 Default: 60 seconds for low-speed nonbroadcast multiaccess (NBMA) networks and 5 seconds for all other networks
Hold Time	Type the hold time interval for an EIGRP routing process. The hello packet advertises the hold time. The hold time indicates to EIGRP neighbors the length of time for the neighbor to consider the router reachable. Valid values: 1 . . 65535 seconds Default: 180 seconds for low-speed NBMA networks and 15 seconds for all other networks
Enable Split Horizon	Check the checkbox to enable split horizon on the interface. Split horizon controls the sending of EIGRP update and query packets. When split horizon is enabled on an interface, update and query packets are not sent to destinations for which this interface is the next hop. Controlling update and query packets in this manner reduces the possibility of routing loops. By default, split horizon is enabled on all interfaces. In general, we recommend that you not change the default state of split horizon unless you are certain that your application requires the change to properly advertise routes.
Delay	Type the delay value in tens of microseconds for the interface. The interface delay value to use in EIGRP distance calculations. Type the value in tens of microseconds for the interface.
<b>Authentication</b>	
Enable MD5 Authentication	Check the checkbox to enable message digest algorithm 5 (MD5) authentication in EIGRP packets. EIGRP route authentication provides MD5 authentication of routing updates from the EIGRP routing protocol. The MD5 keyed digest in each EIGRP packet helps prevent the introduction of unauthorized or false routing messages from unapproved sources. All EIGRP neighbors on interfaces that are configured for EIGRP message authentication must be configured with the same authentication mode and key for adjacencies to be established.
Key Chain Name	Choose an authentication key chain for EIGRP.
<b>MD5 Keys and IDs</b>	
Key Chain Name	Type a name for the authentication key chain for EIGRP authentication.
MD5 Key ID	Type an identification number for an authentication key on the key chain. The range of keys is from 0 . . 2147483647. The key identification numbers do not need to be consecutive.
MD5 Key	Type an authentication string that must be sent and received in the EIGRP packets being authenticated. The string can contain from 1 . . 80 uppercase and lowercase alphanumeric characters.
<b>Redistribution</b> —Redistribute routes that are discovered by RIP and OSPF into the EIGRP routing process. You can also redistribute static and connected routes into the EIGRP routing process. If connected routes fall within the range of a network statement in the EIGRP configuration, you do not need to redistribute the routes.	
EIGRP ID	Choose the Autonomous System (AS) number of the EIGRP routing process.
Protocol	Click the route type for redistribution into the EIGRP routing process: <ul style="list-style-type: none"> <li>• Static—Redistributes static routes into the EIGRP routing process.</li> <li>• Connected—Redistributes connected routes into the EIGRP routing process.</li> <li>• OSPF—Redistributes routes from an OSPF routing process into the EIGRP routing process.</li> <li>• RIP—Redistributes routes from an RIP routing process into the EIGRP routing process.</li> </ul>
Match	(Optional). Match and set properties of routes that are imported from OSPF: <ul style="list-style-type: none"> <li>• Internal—Matches internal OSPF routes.</li> <li>• External 1—Matches Type 1 external routes.</li> <li>• External 2—Matches Type 2 external routes.</li> <li>• NSSA External 1—Matches Type 1 NSSA routes.</li> <li>• NSSA External 2—Matches Type 2 NSSA routes.</li> </ul>
Bandwidth	Type the minimum bandwidth of the route in kilobits per second. Valid values: 1 . . 4294967295
Delay	Type the route delay in tens of microseconds. Valid values: 1 or any positive number that is a multiple of 39.1 nanoseconds
Reliability	Type a number from 0 through 255 that represents likelihood of successful packet transmission. Valid values: 0 . . 255 where 255 means 100 percent reliability; 0 means no reliability

**Table 51 - EIGRP Fields (Continued)**

Field	Description
Loading	Type a number that represents the effective bandwidth of the route. Valid values: 1...255 where 255 is 100 percent loading
MTU	Type the smallest allowed value for the maximum transmission unit (MTU) in bytes. Valid values: 1...65535
<b>Static Neighbor</b> —EIGRP hello packets are sent as multicast packets. If an EIGRP neighbor is located across a nonbroadcast network, such as a tunnel, you must manually define that neighbor. When you manually define an EIGRP neighbor, hello packets are sent to that neighbor as unicast messages.	
EIGRP ID	Choose the Autonomous System (AS) number of the EIGRP routing process.
Neighbor	Type the IP address of the neighbor.
Interface	Choose the interface through which the neighbor is available.
<b>Summary Address</b> —Define summary addresses in either of these scenarios: <ul style="list-style-type: none"> <li>• If you want to create summary addresses that do not occur at a network number boundary</li> <li>• If you want to use summary addresses on a router with automatic route summarization disabled.</li> </ul> If any more specific routes are in the routing table, EIGRP advertises the summary address out the interface with a metric equal to the minimum of all more specific routes.	
EIGRP ID	Choose the Autonomous System (AS) number of the EIGRP routing process.
Network Address	Type the IP address of the summary address.
Net Mask	Choose the network mask of the summary address.
Administrative Distance	Type the distance value of the summary address. Default: 5

To change the default settings after adding an EIGRP instance, on the EIGRP Instances tab, click the button in the row to customize, and then click Customize Default Settings.

---

**IMPORTANT** Setting metrics is complex and is not recommended without guidance from an experienced network designer.

---

**Table 52 - Customize EIGRP Parameters**

Field	Description
EIGRP ID	(Not editable). Displays the Autonomous System (AS) number of the EIGRP routing process.
Auto-Summary	Check the checkbox to allow the automatic summarization of subnet routes into network-level routes. This feature is disabled by default (the software sends subprefix routing information across classful network boundaries). EIGRP summary routes are given an administrative distance value of 5. You cannot configure this value.
<b>Administrative Distance</b>	
Internal Distance	Type an administrative distance for EIGRP internal routes. Internal routes are routes that are learned from another entity within the same autonomous system. Valid values: 1...255 Default: 90
External Distance	Type an administrative distance for EIGRP external routes. External routes are routes for which the best path is learned from a neighbor external to the autonomous system. Valid values: 1...255 Default: 170
<b>Metrics</b>	
Bandwidth	Type the minimum bandwidth of the route in kilobits per second. Valid values: 1...4294967295
Loading	Type a number that represents the effective bandwidth of the route. Valid values: 1...255 where 255 is 100 percent loading
Reliability	Type a number that represents likelihood of successful packet transmission. Valid values: 0...255 where 255 means 100 percent reliability; 0 means no reliability



**Table 52 - Customize EIGRP Parameters (Continued)**

<b>Field</b>	<b>Description</b>
Delay	Type a route delay in tens of microseconds. Valid values: 1 or any positive number that is a multiple of 39.1 nanoseconds
MTU	Type the smallest allowed value for the maximum transmission unit (MTU), in bytes. Valid values: 1...65535
<b>Adjacency Changes</b>	
Log Neighbor Changes	Enables the logging of syslog messages when a neighbor state changes. Default: Disabled (no adjacency changes are logged)
Log Neighbor Warnings	Enables the logging of neighbor warning messages. Default: Disabled (no adjacency changes are logged)
<b>Stub</b>	
Receive Only	Check the checkbox to restrict the router from sharing any of its routes with any other router in the EIGRP autonomous system. When you enable this parameter, you cannot specify any other Stub parameters because it helps prevent any type of route from being advertised. Default: Disabled
Connected	Check the checkbox to permit EIGRP stub routing to send connected routes. If the connected routes are not covered by a network statement, they can be redistributed using the Redistributed parameter. Default: Disabled
Redistributed	Check the checkbox to permit EIGRP stub routing to advertise other routing protocols and autonomous systems. If this parameter is not enabled, EIGRP does not advertise redistributed routes. Default: Disabled
Static	Check the checkbox to permit EIGRP stub routing to advertise static routes. If you do not select this option, EIGRP does not send any static routes, including internal static routes that normally would be automatically redistributed. It is still necessary to redistribute static routes with the Redistributed parameter. Default: Disabled
Summary	Check the checkbox to permit EIGRP stub routing to advertise summary routes. You can manually create summary routes on the Summary Address page or automatically at a major network border router by enabling the Auto-Summary feature. Default: Disabled

## EtherChannels

An EtherChannel, or port group, is a group of two or more Fast Ethernet or Gigabit Ethernet switch ports that are bundled into a logical link. The group creates a higher bandwidth link between two switches. For example, four 10/100 switch ports can be assigned to an EtherChannel to provide full-duplex bandwidth of up to 800 Mb/s. If one of the ports in the EtherChannel becomes unavailable, traffic is carried over the remaining ports within the EtherChannel.

All ports in an EtherChannel must have the same characteristics:

- All are applied with the Smartports IE Switch port role and belong to the same VLAN.
- All are either 10/100 ports, or all are 10/100/1000 ports. You cannot group a mix of 10/100 and 10/100/1000 ports in an EtherChannel.
- All are enabled. A disabled port in an EtherChannel is treated as a link failure, and its traffic is transferred to one of the remaining ports in the EtherChannel.

---

**IMPORTANT** Do not enable Layer 3 addresses on the physical EtherChannel interfaces.

---

[Table 53](#) shows the maximum number of EtherChannels available per switch. Each EtherChannel can consist of up to eight compatible, configured Ethernet ports.

**Table 53 - EtherChannels by Switch**

Switch	EtherChannels, max
Stratix 5400	10
Stratix 5410	10
Stratix 5700 <sup>(1)</sup>	6
ArmorStratix 5700	6
Stratix 8000/8300	6

(1) EtherChannels are available only on switches with Full firmware.

Figure 20 shows two EtherChannels. Two full-duplex 10/100/1000-Mbps ports on Switches A and C create an EtherChannel with a bandwidth of up to 4 Gbps between both switches. Similarly, two full-duplex 10/100 ports on Switches B and D create an EtherChannel with a bandwidth of up to 400 Mbps between both switches.

If one of the ports in the EtherChannel becomes unavailable, traffic is sent through the remaining ports within the EtherChannel.

**Figure 20 - EtherChannel Example**

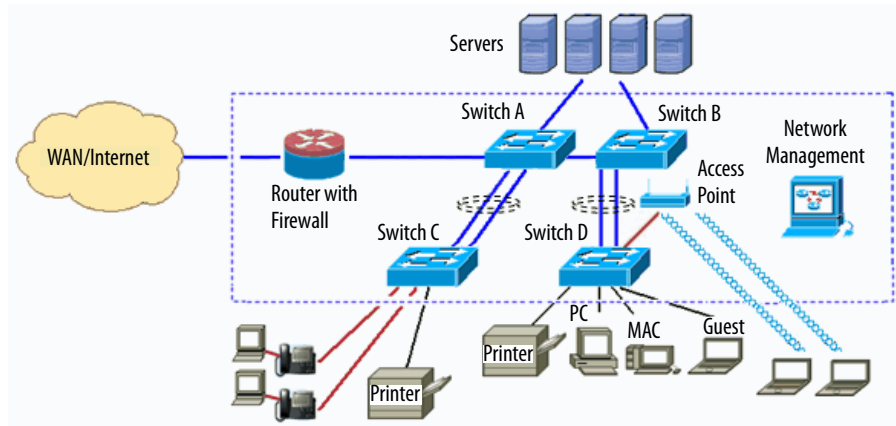

Table 54 describes the modes you can assign to an EtherChannel:

**Table 54 - EtherChannel Modes**

Mode	Description
Static	All ports join the EtherChannel, without negotiations. This mode can be useful if the remote device does not support the protocols that other modes require. The switches at both ends of the link must be configured in Static mode.
Port Aggregation Control Protocol (PAgP)	A Cisco-proprietary protocol. The port responds to requests to create EtherChannels but does not initiate such negotiations. This silent mode is recommended when a port is connected to a device, such as a file server or a packet analyzer that is unlikely to send PAgP packets. A port in the PAgP mode can form an EtherChannel with another port in the PAgP Desirable mode.
Port Aggregation Control Protocol (PAgP) (non-silent)	This mode is the same as PAgP mode but is recommended when the port is connected to a device that is expected to be active in initiating EtherChannels. A port in PAgP mode can form an EtherChannel with another port in the PAgP Desirable mode.
Port Aggregation Control Protocol (PAgP) Desirable	This mode enables PAgP. The port initiates negotiations to form EtherChannels by sending PAgP packets to other ports. This silent mode is recommended when a port is connected to a device, such as a file server or a packet analyzer that is unlikely to send PAgP packets. A port in the Desirable mode can form an EtherChannel with another port that is in PAgP or PAgP Desirable mode.
Port Aggregation Control Protocol (PAgP) Desirable (non-silent)	This mode is the same as PAgP Desirable mode but is recommended when the port is connected to a device that initiates EtherChannels.
Link Aggregation Control Protocol (LACP) (active)	This mode enables LACP unconditionally. The port sends LACP packets to other ports to initiate negotiations to create EtherChannels. A port in active LACP mode can form an EtherChannel with another port that is in active or passive LACP mode. The ports must be configured for full-duplex.
Link Aggregation Control Protocol (LACP) (passive)	This mode enables LACP only if an LACP device is detected at the other end of the link. The port responds to requests to create EtherChannels but does not initiate such negotiations. The ports must be configured for full-duplex.

Configure both ends of the EtherChannel in the same mode:

- When you configure one end of an EtherChannel in PAgP or LACP mode, the system negotiates with the other end of the channel to determine the ports to become active. Incompatible ports are suspended. Instead of a suspended state, the local port is put into an independent state and continues to carry data traffic as any other single link. The port configuration does not change, but the port does not participate in the EtherChannel.
- When you configure an EtherChannel in Static mode, no negotiations take place. The switch forces all compatible ports to become active in the EtherChannel. The other end of the channel (on the other switch) must also be configured in the Static mode; otherwise, packet loss can occur.

If a link within an EtherChannel fails, traffic previously carried over that failed link moves to the remaining links within the EtherChannel. If traps are enabled on the switch, a trap is sent for a failure that identifies the switch, the EtherChannel, and the failed link. Inbound broadcast and multicast packets on one link in an EtherChannel are blocked from returning on any other link of the EtherChannel.

### Configure EtherChannels via Device Manager

From the Configure menu, choose EtherChannels.

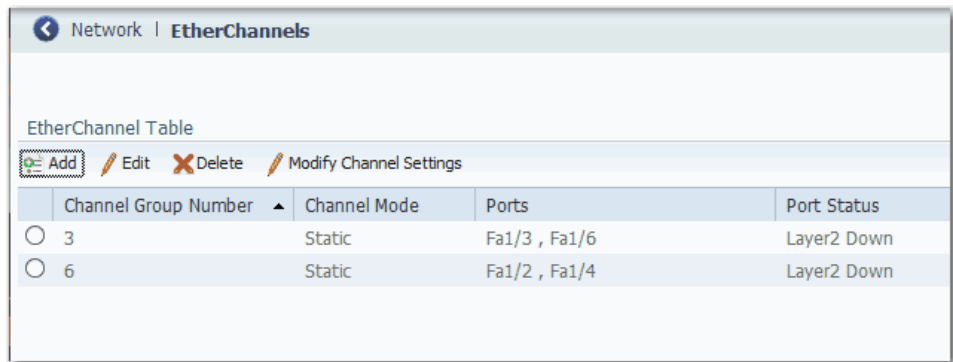
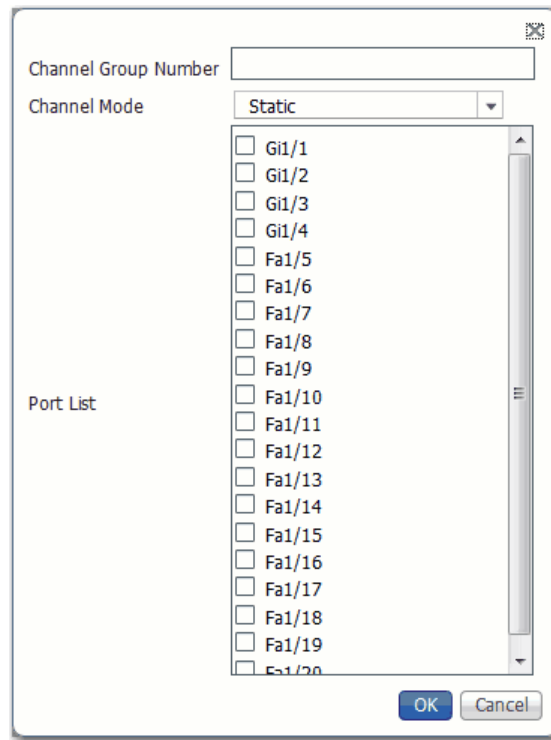

Table 55 - EtherChannel Fields

Field	Description
Channel Group Number	A number to identify the EtherChannel. See <a href="#">Table 53</a> for the maximum number of EtherChannels available per switch.
Channel Mode	Determines how ports become active. With all modes except Static, negotiations occur to determine which ports become active. Incompatible ports are put into an independent state and continue to carry data traffic, but do not participate in the EtherChannel. <b>IMPORTANT:</b> Be sure that all ports in an EtherChannel are configured with the same speed and duplex mode. See <a href="#">Table 54</a> for a description of EtherChannel modes.
Ports	The ports that can participate in the EtherChannel.
Port Status	The status of the group.

You can add, edit, or delete an EtherChannel:

- To add an EtherChannel, click Add. Complete the fields described in [Table 56](#) and click OK.
- To edit an EtherChannel, click the radio button next to the EtherChannel and click Edit. Complete the fields described in [Table 56](#) and click OK.
- To modify EtherChannel settings, such as speed, duplex mode, and VLAN assignments, click the radio button next to the EtherChannel and click Modify Channel Settings. Complete the fields described in [Table 57](#) and click OK.
- To delete an EtherChannel, click the radio button next to the EtherChannel and click Delete.



**Table 56 - Add/Edit EtherChannel Dialog Box**

Field	Description
Channel Group Number	Type a number to identify the EtherChannel.
Channel Mode	Choose a mode to assign to the EtherChannel. For a description of each mode, see <a href="#">Table 54 on page 147</a> .
Port List	Check the checkbox next to each port to assign to the EtherChannel.

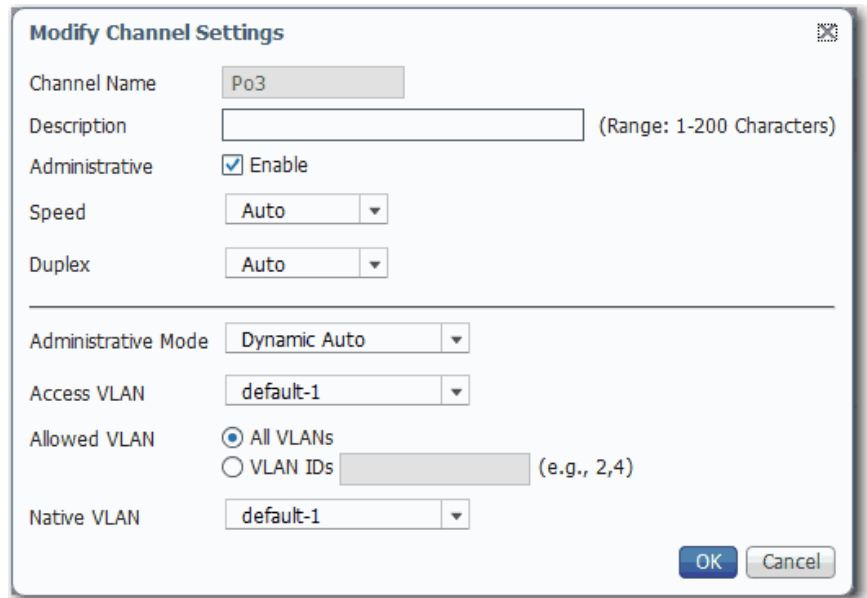

**Table 57 - Modify Channel Settings Dialog Box**

Field	Description
Channel Name	Displays the name assigned to the channel.
Description	Type a description of the channel.
Administrative	Check Enable to make the channel active. Clear Enable to make the channel inactive.
Speed	Choose the operating speed of the channel. If the connected device can negotiate the link speed with the channel, choose Auto (autonegotiation). Default: Auto
Duplex	Choose the duplex mode of the channel: <ul style="list-style-type: none"> <li>Auto—(Autonegotiation). The connected device can negotiate the duplex mode with the channel. If the channel is not connected or has not completed negotiation, the status is Auto.</li> <li>Half—(Half-duplex mode). The connected device must alternate sending or receiving data.</li> <li>Full—(Full-duplex mode). Both devices can send data at the same time.</li> </ul> Default: Auto
Administrative Mode	Choose one of the following administrative modes: <ul style="list-style-type: none"> <li>Access—The channel is in permanent nontrunking mode and negotiates to convert the neighboring link into a nontrunk link even if the neighboring interface is a trunk interface. If you choose this option, also choose an Access VLAN. An access port belongs to and carries the traffic of only one VLAN (unless it is configured as a voice VLAN port).</li> <li>Trunk—The channel is in permanent trunking mode and negotiates to convert the neighboring link into a trunk link even if the neighboring interface is not a trunk interface. If you choose this option, also choose whether to allow All VLANs or specified VLAN IDs.</li> <li>Dynamic Auto—The channel converts the link to a trunk link if the neighboring interface is set to trunk or desirable mode. This mode is the default setting. If you choose this option, specify an Access VLAN to use when the link is in access mode. Also specify whether to allow All VLANs or specified VLAN IDs when the link is in trunk mode.</li> <li>Dynamic Desirable—If the neighboring interface is set to Trunk, Dynamic Desirable, or Auto mode, the channel converts the link to a trunk link. If you choose this option, specify an Access VLAN to use when the link is in access mode. Also choose whether to allow All VLANs or specified VLAN IDs when the link is in Trunk mode.</li> <li>Routed—The channel acts like a port on a router but does not have to be connected to a router. A routed port is not associated with a particular VLAN, as is an access port. A routed port behaves like a regular router interface, except that it does not support VLAN subinterfaces. Routed ports can be configured with a Layer 3 routing protocol. A routed port is a Layer 3 interface only and does not support Layer 2 protocols, such as DTP and STP. Routed ports are supported only on switches running the IP base or IP services image.</li> </ul> Default: Dynamic Auto
Access VLAN	Choose the VLAN that the channel belongs to and carries traffic for when the channel is configured as or is acting as a nontrunking interface.
Allowed VLAN	Choose the VLANs for which this channel handles traffic when the channel is configured as or is dynamically acting as a trunking interface: <ul style="list-style-type: none"> <li>To allow traffic on all available VLANs, click All VLANs.</li> <li>To limit traffic to specific VLANs, click VLAN IDs and enter the VLAN numbers.</li> </ul>
Native VLAN	Choose the VLAN that transports untagged packets.

## Configure EtherChannels via the Logix Designer Application

In the navigation pane, click EtherChannels.

You can add, edit, and delete EtherChannel members.

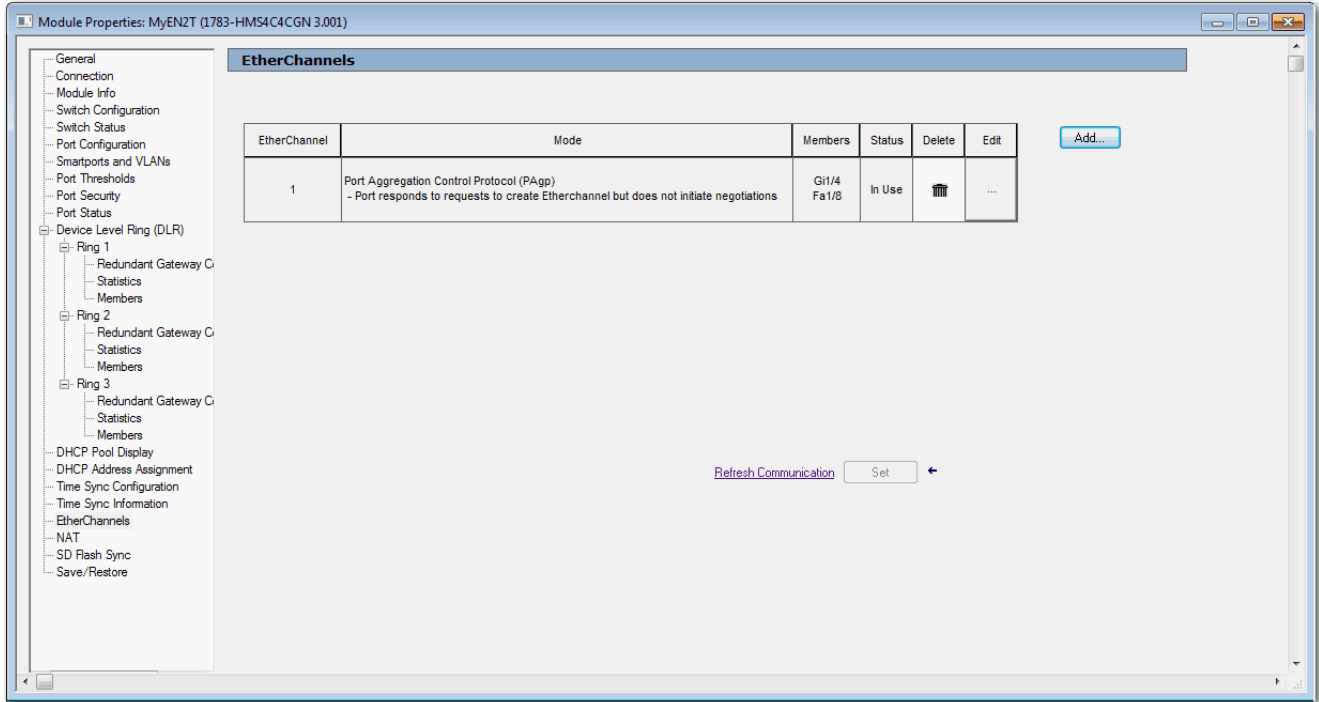
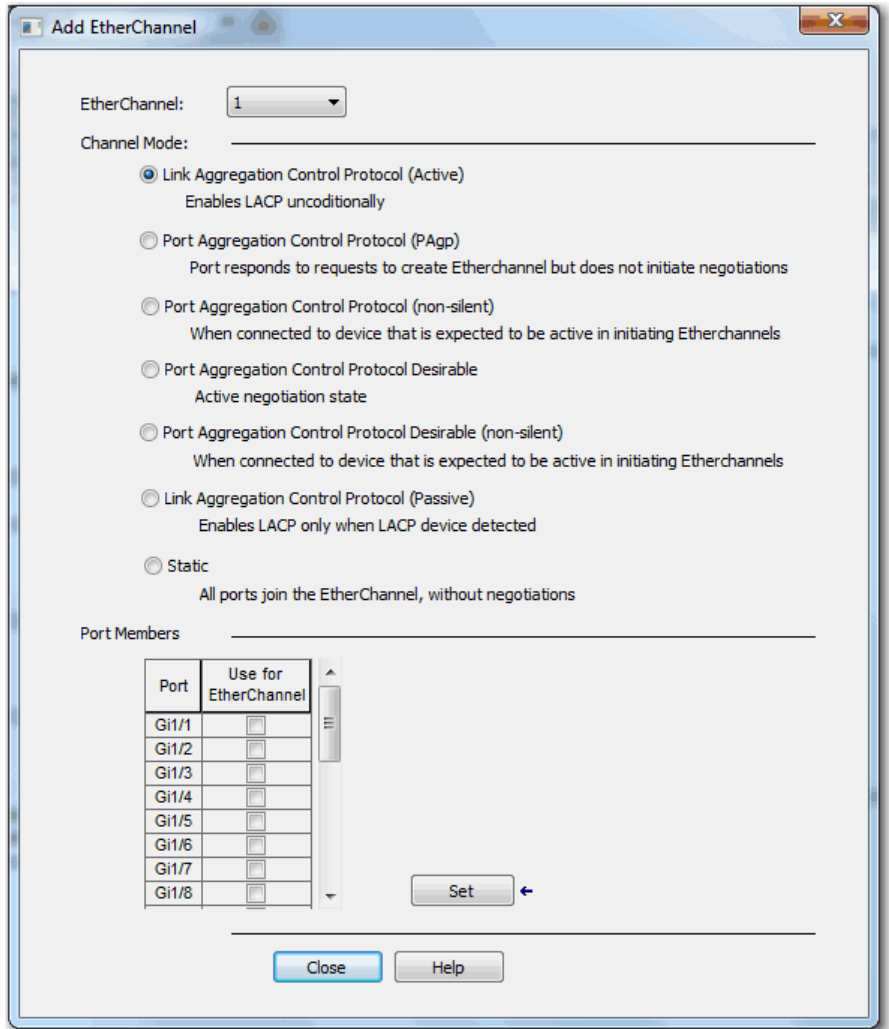

**Table 58 - EtherChannels Fields**

Field	Description
EtherChannel	A number to identify the EtherChannel. See <a href="#">Table 53</a> for the maximum number of EtherChannels available per switch.
Mode	Determines how ports become active. With all modes except Static, negotiations occur to determine which ports become active. Incompatible ports are put into an independent state and continue to carry data traffic, but do not participate in the EtherChannel. <b>IMPORTANT:</b> Make sure that all ports in an EtherChannel are configured with the same speed and duplex mode. See <a href="#">Table 54</a> for a description of EtherChannel modes.
Members	The ports that can participate in the EtherChannel.
Status	The status of the group.

### Add an EtherChannel

1. On the EtherChannels view, click Add.
2. Choose a number to assign to the EtherChannel.
3. Click a mode to assign to the EtherChannel.  
See [Table 54](#) for a description of each mode.
4. In the use for EtherChannel column, check the checkbox next to each port to participate in the EtherChannel.
5. Click Close.





## Feature Mode

Feature mode is available on Stratix 5400 switches. Feature mode provides efficient allocation of resources on the switch to support the operation of multiple, time-sensitive features. There are two modes, each with a profile customized for certain features, as shown in [Table 59](#). The switch is configured to use DLR as the default mode. In a running system, if you deactivate the current active Feature mode, the default mode is applied.

**Table 59 - Feature Modes**

Mode	Features Enabled
DLR (default)	<ul style="list-style-type: none"> <li>• PTP</li> <li>• NAT</li> <li>• DLR</li> <li>• PRP</li> </ul>
HSR	<ul style="list-style-type: none"> <li>• PTP</li> <li>• NAT</li> <li>• PRP</li> <li>• HSR</li> </ul>

**IMPORTANT** Before changing the Feature mode, we recommend removing any configurations related to the current active Feature mode because those configurations are not valid for the new mode.

To apply a feature mode, follow these steps.

1. From the Admin menu, choose Feature Mode.
2. From the pull-down menu, choose a mode and click Submit.

3. When prompted to restart the switch, click OK.

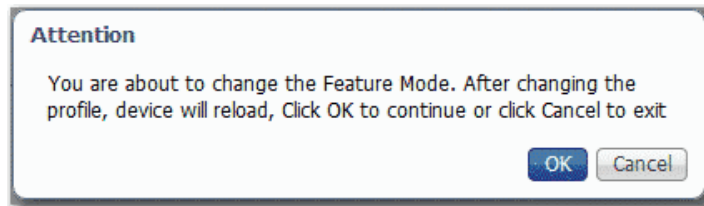

The Status area of the page displays the status of the mode change and reload operation. After the restart, the status message prompts you to log out and log in again for the new mode to take effect.

## Global Navigation Satellite System (GNSS)

---

**IMPORTANT** GNSS is supported only on Stratix 5410 series B switches with IOS release 15.2(6)E0a and later.

To use the GNSS software feature on the switch, you must obtain an external GPS antenna from a third-party manufacturer.

---

The built-in GNSS receiver enables a Stratix 5410 switch to determine its own location and get an accurate time from a satellite constellation. The switch can then become the Grandmaster clock for time distribution in the network.

### GNSS Hardware

The switch uses a GNSS receiver with precise frequency and phase outputs for the host system. When connected to an external GNSS antenna, the receiver can acquire GNSS satellite signals, track as many as 32 GNSS satellites, and compute location, speed, heading, and time. It provides an accurate one pulse-per-second (PPS) and stable 10 MHz frequency output. For more information, see [GNSS Signaling on page 155](#).

GNSS hardware supports the following frequency bands:

- GPS/NAVSTAR—Global Positioning System (USA: L1)
- GLONASS—Global'naya Navigatsionnaya Sputnikovaya Sistema (Russia: L1/G1)
- BeiDou—China (including B1-2)

---

**IMPORTANT** The Galileo satellite system is not available in the current release.

---

### GNSS Software

As of IOS release 15.2(6)E0a and later, the GNSS software feature performs the following functions:

- Configures the GNSS receiver.
- After the receiver gains lock, the software performs the following functions once per second:
  - Reads the new time and date.
  - Reads the corresponding pulse-per-second (PPS) time stamp from the hardware.
  - Feeds the time and date and PPS time stamp into the Time Services SW Virtual Clock/Servo for GNSS. The GNSS SW Virtual Clock time can then be used to drive Precision Time Protocol (PTP) output.

## GNSS Signaling

There are two stages in the process for the GNSS receiver to acquire satellites and provide timing signals to the host system:

- **Self-survey mode**—On reset, the GNSS receiver comes up in Self-survey mode and attempts to lock on to a minimum of four different satellites to obtain a 3-D fix on its current position. It computes nearly 2000 different positions for these satellites, which takes about 35 minutes. Also during this stage, the GNSS receiver is able to generate accurate timing signals and achieve normal (locked to GPS) state. Because the timing signal obtained during Self-survey mode can be off by 20 seconds, the software collects PPS data only during Over-determined (OD) Clock mode.

After the self-survey process is complete, the results are saved to the internal memory of the GNSS receiver, which speeds up the transition to OD mode the next time the self-survey process runs. You can manually restart the self-survey process by using the command-line interface (CLI). After the self-survey process completes again, the software updates the results in the internal memory of the GNSS receiver.

- **Over-determined (OD) Clock mode**—The device transitions to OD mode when self-survey process is complete and the position information is stored in memory on the switch. In OD mode, the GNSS receiver outputs timing information based on satellite positions obtained during Self-survey mode.

The GNSS receiver remains in OD mode until there is a reason to leave it, such as the following reasons:

- Detection of a position relocation of the antenna of more than 100 m, which triggers an automatic restart of the self-survey process.
- Manual restart of the self-survey process via the CLI.

After the GNSS receiver locks on to a satellite system, it sends a 10 ms-wide PPS pulse and the current time and date according to the satellite system to the time service.

## GNSS Considerations

Consider these guidelines and limitations when configuring GNSS:

- GNSS is available as a timing source for PTP only.
- GNSS is available as a timing source for PTP only when PTP is in NTP-PTP Clock mode.
- Syslog messages are sent when the following GNSS events occur:
  - GNSS is in Self-survey mode.
  - GNSS reaches OD mode.
  - GNSS firmware update is in progress, complete, or failed.
- If the switch is the PTP Grandmaster clock and it loses the antenna signal, the clock quality can degrade, resulting in a Grandmaster clock switchover.
- The GPS antenna alarm does not trigger an external relay alarm.

## Configure GNSS

You can configure GNSS as a time source for PTP by using the CLI. For instructions on how to configure GNSS via the CLI, refer to documentation available at <http://www.Cisco.com>.

By default, GNSS is disabled. The following table lists other default settings.

Parameter	Default
Cable delay—The amount of time to compensate for cable delay in nanoseconds.	0
Antenna power—Antenna power input voltage.	5
Constellation—The satellite constellation that GNSS detects and locks to.	GPS
Anti-jam—The number of satellites required for a valid timing fix: <ul style="list-style-type: none"> <li>• Enabled—A minimum of two satellites is required for a fix in Over-determined (OD) Clock mode, and three satellites are required for the first fix in Self-survey mode.</li> <li>• Disabled—Only one satellite is required for a valid timing fix.</li> </ul>	Enabled

## High-availability Seamless Redundancy (HSR)

HSR is available on Stratix 5400 switches. HSR is defined in International Standard IEC 62439-3-2016 clause 5.

For instructions on how to configure HSR via the CLI, refer to documentation available at <http://www.Cisco.com>.

---

**IMPORTANT** To use HSR, be sure that the switch is using the HSR feature application profile as described on [page 153](#).

---

## Horizontal Stacking

Horizontal stacking lets you manage as many as four Stratix 5410 switches as one logical device. To stack multiple switches, you connect the switches via as many as two uplink Ethernet ports per switch. You use the CLI to configure network ports as designated stack ports. Once you configure a network port as a stack port, you cannot apply any network configuration to that port.

**Figure 21 - Switch Stack**

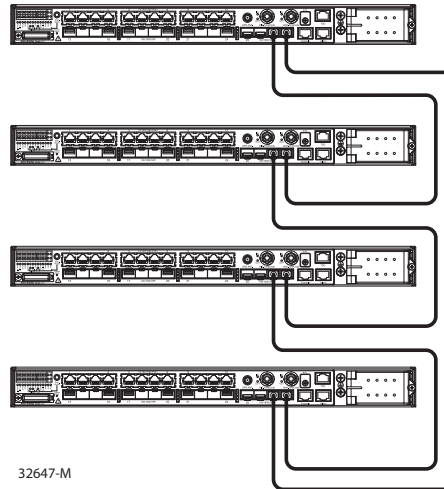

Within a horizontal stack, one switch acts as the master switch and the others as slaves. For instructions on how to configure and monitor a switch stack via the CLI, refer to documentation available at <http://www.Cisco.com>.

If communication fails between devices in a stack, the convergence time is more than one second.

The following table lists the switch catalog numbers and ports that support horizontal stacking.

Stratix 5410 Switch (four switches per stack, max)	Stack Ports (two ports per switch, max)
1783-IMS28NAC	Te1/25
1783-IMS28RAC	Te1/26
1783-IMS28NDC	Te1/27
1783-IMS28RDC	Te1/28

**IMPORTANT** A stack of switches must meet these minimum requirements:

- All switches must use the same firmware model
- All switches must use the same SDM template

If the SDM template of a switch is different than that of the master switch, apply the matching SDM template separately before you connect the switch to the stack.

You can configure a stack in either a Device Level Ring topology ([Figure 22](#)) or a Linear topology ([Figure 23](#)).

Figure 22 - Switch Stack in a Ring Topology

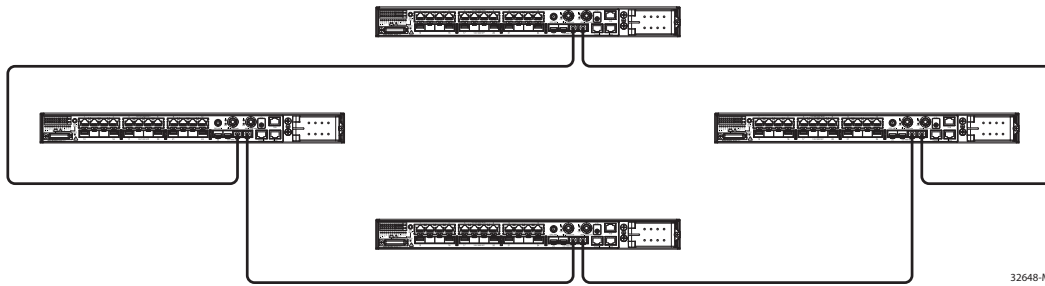

Figure 23 - Switch Stack in a Linear Topology



[Table 60](#) lists the supported features for horizontal stacking.

**Table 60 - Supported Features**

Feature Type	Support
Layer 2 features	<ul style="list-style-type: none"> <li>• Link status detection, speed, duplex</li> <li>• Layer 2 learning and forwarding</li> <li>• STP, MSTP, RSTP, BPDU Guard</li> <li>• VLAN, VTP, DTP, VLAN Table</li> <li>• CDP, LLDP</li> <li>• UDLD</li> <li>• EtherChannel (LACP and PAgP)</li> <li>• Flex links</li> <li>• IGMP snooping</li> <li>• ARP</li> <li>• REP ring convergence</li> </ul>
Layer 3 features	<ul style="list-style-type: none"> <li>• ARP</li> <li>• Static routes</li> <li>• Layer 3 host configuration</li> </ul>
Power over Ethernet (PoE)	PoE is supported in Stack mode.
Traffic types	<ul style="list-style-type: none"> <li>• Layer 2 unicast</li> <li>• Layer 2 multicast and broadcast</li> <li>• Layer 3 unicast traffic</li> <li>• Layer 3 multicast and broadcast</li> </ul>

Features that are not listed in [Table 60](#) are not supported. Unsupported features include, but are not limited to, Device Manager, CIP, Layer 2 NAT, PRP, and PTP.

## Internet Group Management Protocol (IGMP) Snooping with Querier

Layer 2 switches can use IGMP snooping to constrain the flooding of multicast traffic. IGMP snooping dynamically configures Layer 2 interfaces so that multicast traffic is forwarded to only those interfaces that are associated with IP multicast devices. IGMP snooping requires the LAN switch to snoop on the IGMP transmissions between the host and the router and track multicast groups and member ports. When the switch receives an IGMP report from a host for a particular multicast group, it adds the host port number to the forwarding table entry. When the switch receives an IGMP Leave Group message from a host, it removes the host port from the table entry. It also periodically deletes entries if it does not receive IGMP membership reports from the multicast clients.

The multicast router sends out periodic general queries to all VLANs. All hosts that are interested in this multicast traffic send join requests and are added to the forwarding table entry. The switch creates one entry per VLAN in the IGMP snooping IP multicast forwarding table for each group from which it receives an IGMP join request.

The switch supports IP multicast group-based bridging, rather than MAC-addressed based groups. With multicast MAC address-based groups, if an IP address being configured translates (aliases) to a previously configured MAC ID or to any reserved multicast MAC IDs (in the range 224.0.0.xxx), the command fails. Because the switch uses IP multicast groups, there are no address alias issues.

[Table 61](#) defines the default number of supported multicast groups. You can modify the number of multicast groups that are supported by using the Command-line interface.

**Table 61 - Default Supported Multicast Groups**

Switch	Default Multicast Groups
Stratix 5400 and Stratix 5410 switches	1024
Stratix 5700 and ArmorStratix 5700 switches	256 If you exceed 180 multicast groups, we recommend that you switch to the routing SDM template via Device Manager.
Stratix 8000 switches	256 If you exceed 180 multicast groups, we recommend that you modify the number of multicast groups by changing the SDM template to the Lanbase Routing template via Device Manager.
Stratix 8300 switches	1024

The IP multicast groups that are learned through IGMP snooping are dynamic. If you specify group membership for a multicast group address statically, your setting supersedes any automatic manipulation by IGMP snooping. Multicast group membership lists can consist of both user-defined and IGMP snooping-learned settings. The switch learns multicast IP addresses that are used by the EtherNet/IP network for I/O traffic.

IGMP implementation in the switch is IGMP V2. This version is backward-compatible with switches running IGMP V1. The switch has a built-in querier function, and the global macro enables on IGMP snooping and the querier.

## Configure IGMP Snooping with Querier via Device Manager

- IMPORTANT** In a PRP system, follow these guidelines:
- To enable multicast traffic filtering on both LANs, configure IGMP querier on a RedBox.
  - To avoid a single point of failure with the loss of a querier, configure at least two queriers in the PRP network.
  - Disable IGMP querier on each LAN A and LAN B infrastructure switch.

From the Configure menu, choose IGMP Snooping.

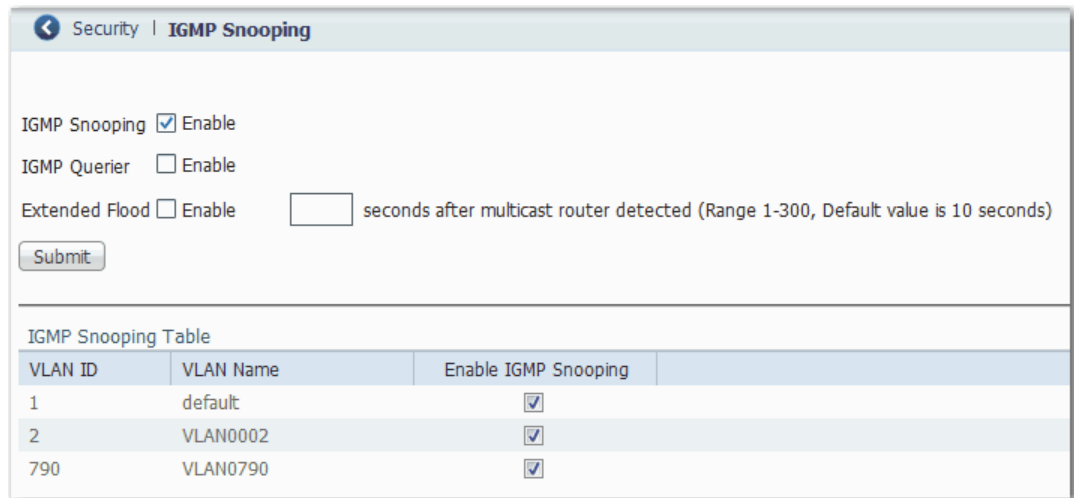

**Table 62 - IGMP Snooping Fields**

Field	Description
IGMP Snooping	Check Enable to enable IGMP snooping for all VLAN IDs.
IGMP Querier	Check Enable to enable IGMP querier for all VLAN IDs.
Extended Flood	Check Enable to help prevent the loss of multicast traffic when the IGMP snooping querier is disconnected and then reconnected. Enter the number of seconds after a multicast router is detected to continue flooding multicast traffic. After that period, multicast flooding stops. Valid values: 1 . . . 300 seconds Default: 10 seconds
<b>IGMP Snooping Table</b>	
VLAN ID	The VLAN ID and name on which to enable or disable IGMP snooping.
VLAN Name	
Enable IGMP Snooping	Check Enable IGMP Snooping to enable IGMP snooping on all ports assigned to the corresponding VLAN. Clear Enable IGMP Snooping to disable IGMP snooping on all ports assigned to the corresponding VLAN.



## Maximum Transmission Unit (MTU)

The MTU defines the largest size of frames that an interface can send or receive in a single network transaction.

In Device Manager, you can change the following MTU settings on the switch:

- System MTU—Applies to all interfaces.
- Jumbo MTU—Overrides the system MTU on all Gigabit Ethernet and 10-Gigabit Ethernet interfaces.

---

**IMPORTANT** In a PRP system, you must set the jumbo MTU size to at least 1506 on all switches in LAN A and LAN B. This size enables the switch to pass a full-sized packet with the PRP trailer attached. This MTU value is not required for a switch configured as a RedBox. For more information about PRP and frame size requirements, see the EtherNet/IP Parallel Redundancy Protocol Application Technique, publication [ENET-AT006](#).

---

### Configure the MTU via Device Manager

To configure the MTU, follow these steps.

1. From the Admin menu, choose MTU.
2. Complete the fields as described in [Table 63](#) and click Submit.

Device Management | MTU

System MTU :  (Sets the MTU value for all interfaces. Range: 1500-1998 bytes.)

Jumbo MTU :  (Overrides System MTU on GigabitEthernet and TenGigabitEthernet Interfaces. Range 1500-9000 bytes.)

Status:

**Table 63 - MTU Fields**

Field	Description
System MTU	Sets the MTU value for all interfaces. Valid values: 1500 . . . 1918 bytes
Jumbo MTU	Overrides the system MTU on all Gigabit Ethernet and 10-Gigabit Ethernet interfaces. Valid values: 1500 . . . 9000 bytes

3. When the following message appears, click OK and restart the switch.

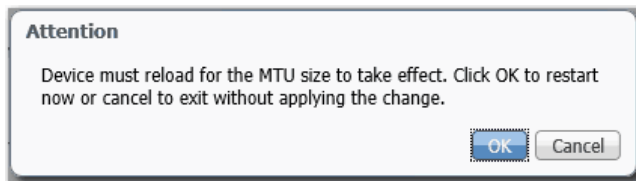

## Motion Prioritized QoS Macros

During Express Setup, the switch applies QoS settings optimized for most applications. The default QoS settings assign equal priority to traffic for CIP and traffic for integrated motion on the EtherNet/IP network. However, you can assign the highest priority to traffic for integrated motion on the EtherNet/IP network by applying the following QoS macros in Device Manager.

**Table 64 - Motion Prioritized QoS Macros**

Switch	Macro
Stratix 5400	Motion Prioritized QoS
Stratix 5410	
Stratix 5700	Motion Prioritized QoS Step 1 Motion Prioritized QoS Step 2
ArmorStratix 5700	
Stratix 8000	

These macros move motion traffic to the highest level queue with time sync. After you apply the macros, motion traffic takes priority over CIP traffic.

### Configure Motion Prioritized QoS Macros via Device Manager

From the Configure menu, choose Global Macros:

- To apply a macro, check the checkbox for the macro and click Save.
- To remove a macro, clear the checkbox for the macro and click Save.

Once you click Save, the changes take effect immediately.

---

**IMPORTANT** For Stratix 5700 and 8000 switches, you must apply both Motion Prioritized QoS Step 1 and Motion Prioritized QoS Step 2 macros. If you enable only one macro, the QoS settings applied during Express Setup remain active.

---

**Stratix 5700, ArmorStratix 5700, and Stratix 8000 Switches**

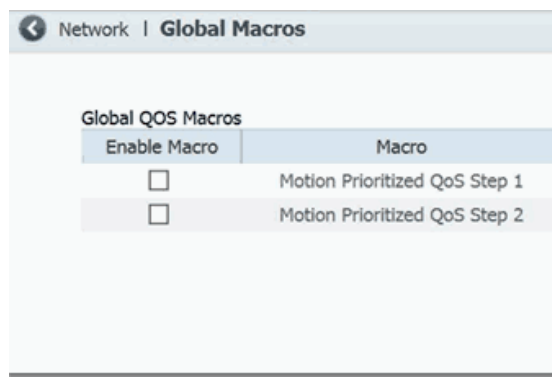

**Stratix 5400 and 5410 Switches**



## NetFlow

NetFlow is available on Stratix 5400 and 5410 switches. NetFlow provides traffic flow monitoring services, including network traffic accounting, usage-based network billing, network planning, security, denial-of-service monitoring capabilities, and network monitoring. NetFlow provides valuable information about network users and applications, peak usage times, and traffic routing.

A flow is a unidirectional stream of packets that have the same flow key values. NetFlow consists of these components:

- **Flow Record**—A flow record defines the unique keys that are used to identify packets in the flow, and other fields that NetFlow gathers for the flow. Device Manager provides predefined flow record templates that you can use to configure NetFlow and begin monitoring network traffic.
- **Flow Monitor**—Flow monitors are applied to ports to perform network traffic monitoring. Flow data is collected from the network traffic and added to the flow monitor cache during the monitoring process based on the key and nonkey fields in the flow record. You define the size of the data that you want to collect for a flow by using a monitor.
- **Flow Sampler**—Flow samplers are used to reduce the load on the switch that is running NetFlow by limiting the number of packets that are selected for analysis. Samplers use random sampling techniques.

Flow sampling exchanges monitoring accuracy for router performance. When you apply a sampler to a flow monitor, the overhead load on the switch running the flow monitor is reduced because the monitor must analyze fewer packets. The reduction in packets causes a corresponding reduction in the accuracy of the information that is stored in the cache of the flow monitor.

- **Flow Exporter**—You can export the data that NetFlow gathers for your flow by using an exporter. Flow exporters export the data in the flow monitor cache to a remote system, such as a server running NetFlow collector, for analysis and storage.

There can be one record per monitor and one monitor per port. You can have multiple exporters per monitor. The flow records, flow monitor, flow exporter, and sampler cannot be modified once applied to a port.

There are two primary methods to access NetFlow data:

- **The command-line interface (CLI)**—Use show commands to view data and troubleshoot.
- **An application reporting tool**—Export flows to a reporting server, which is known as a NetFlow collector. The NetFlow collector uses the flows to produce reports for traffic and security analysis.

For more information about NetFlow, see [Cisco IOS Flexible NetFlow](#).

## NetFlow Templates

[Table 65](#) describes the predefined flow record templates.

**Table 65 - NetFlow Templates**

Template	Record	Description
Application Traffic	match ipv4 protocol match ipv4 source address match ipv4 destination address match transport source-port match transport destination-port collect transport tcp flags collect counter packets long collect timestamp sys-uptime first collect timestamp sys-uptime last	Monitors application traffic.
Security	match ipv4 tos match ipv4 protocol match ipv4 source address match ipv4 destination address match transport source-port match transport destination-port collect transport icmp ipv4 type collect transport icmp ipv4 code collect transport tcp flags collect counter packets long collect timestamp sys-uptime first collect timestamp sys-uptime last	Monitors packets for network security.
Capacity Planning	match ipv6 protocol match ipv6 source address match ipv6 destination address match transport source-port match transport destination-port collect interface input collect interface output collect counter packets long	Monitors packets to analyze network capacity and usage.
StealthWatch	match datalink mac source address input match datalink mac destination address input match ipv4 tos match ipv4 protocol match ipv4 source address match ipv4 destination address match transport source-port match transport destination-port collect transport tcp flags collect interface input collect interface output collect counter bytes long collect timestamp sys-uptime first collect timestamp sys-uptime last	Monitors packets to detect threats and security vulnerabilities.

## Configure NetFlow via Device Manager

Adding a NetFlow configuration creates the monitor and associated exporter and sampler.

To add a NetFlow configuration, follow these steps.

1. From the Configure menu, choose NetFlow.
2. On the Configure NetFlow tab, click Add.
3. Complete the fields as described in [Table 66](#) and click OK.

**Table 66 - Add NetFlow Configuration Fields**

Field	Configuration
NetFlow Configuration Name	Enter a name for the NetFlow configuration.
NetFlow Template	Choose a predefined flow record template from the pull-down menu. <ul style="list-style-type: none"> <li>• APPLICATION_TRAFFIC—Monitors application traffic.</li> <li>• SECURITY—Monitors packets for network security.</li> <li>• CAPACITY_PLANNING—Monitors packets to analyze network capacity and usage.</li> <li>• STEATH_WATCH—Monitors packets to detect threats and security vulnerabilities.</li> </ul>
Collector IP Address	Enter the IP address of the collector device (flow analyzer) where records are sent.
Switch Source/Export Address	Choose the switch IP address to be used for connecting with the collector device.
Sampling Mode	Choose the mode to use for selecting network traffic: <ul style="list-style-type: none"> <li>• deterministic—Enables deterministic mode sampling for the sampler. This mode selects every nth packet for NetFlow processing, as specified by Sampling Rate. For example, if you set the sampling rate to 1 out of 100 packets, then NetFlow samples the 1st, 101st, 201st, 301st, and so on packets.</li> <li>• random—Enables random mode sampling for the sampler. In this mode, incoming packets are randomly selected so that one out of each n sequential packets is selected on average for NetFlow processing at the rate specified in Sampling Rate. For example, if you set the sampling rate to 1 out of 100 packets, then NetFlow might sample the 5th packet and then the 120th, 199th, 302nd, and so on. This sample configuration provides NetFlow data on 1 percent of total traffic.</li> <li>• full netflow—All packets arriving on the interface are sampled. When this mode is selected, the Sampling Rate option is not available.</li> </ul>
Sampling Rate	Enter the rate (one out of every n packets) at which packets are selected for NetFlow processing. For n, you can specify 32...1022 packets. The default is 32.

## Apply a NetFlow Configuration via Device Manager

When you apply a NetFlow configuration (flow monitor with a sampler) to a port, the sampled packets are analyzed at the rate specified by the sampler and compared with the flow record associated with the flow monitor. If the analyzed packets meet the criteria specified by the flow record, they are added to the flow monitor cache.

---

**IMPORTANT** When you apply a NetFlow configuration to a port, IP Device Tracking (IPDT) is enabled on the port. IPDT can cause duplicate IP address detection on some EtherNet/IP modules. For more information, see the Rockwell Automation Knowledgebase answer ID 568750.

---

To apply a NetFlow configuration to ports, follow these steps.

1. From the Configure menu, choose NetFlow.
2. Click the Apply NetFlow tab.
3. To select a port, click the port name and click Edit.

You can select multiple ports and apply the same NetFlow configuration to them at one time.

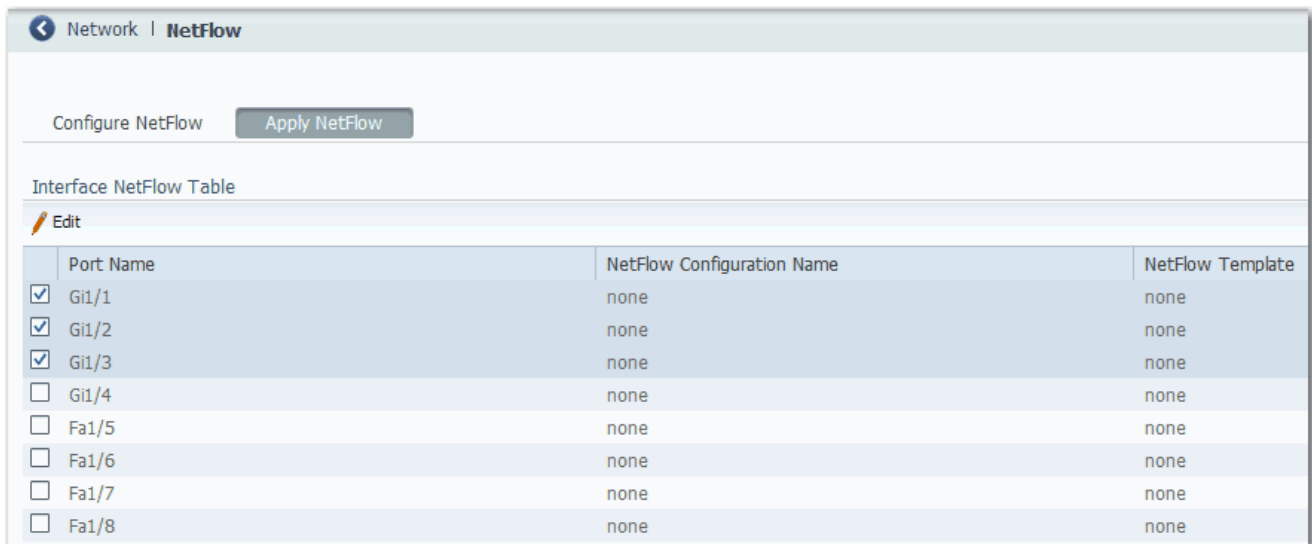

4. On the Apply NetFlow Configuration dialog box, choose the NetFlow configuration to apply to the port and click OK.

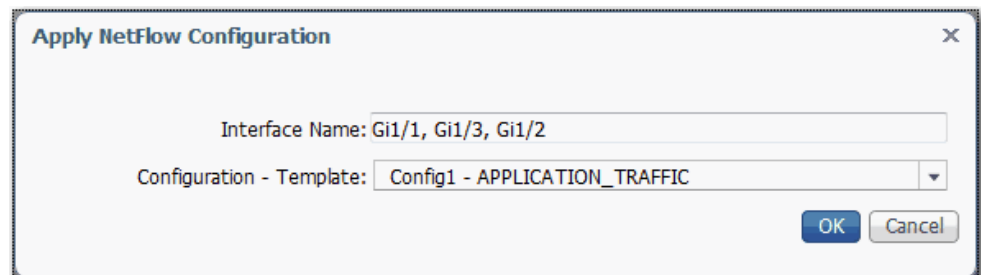

## Network Address Translation (NAT)

For a list of switches that support NAT, see [page 16](#).

NAT is a service that translates one IP address to another IP address via a NAT-configured switch. The switch translates the source and destination addresses within data packets as traffic passes between subnets.

This service is useful if you reuse IP addresses throughout a network. NAT enables devices that share one IP address on a private subnet to be segmented into multiple identical private subnets while maintaining unique identities on the public subnet.<sup>(1)</sup>

The implementation of NAT in Stratix switches is distinct in these ways:

- One-to-one NAT—The switch uses one-to-one NAT, rather than one-to-many NAT. One-to-one NAT requires that each source address translates to one unique destination address. Unlike one-to-many NAT, multiple source addresses cannot share a destination address.
- Layer 2 implementation—The implementation of NAT operates at the Layer 2 level. At this level, the switch can replace only IP addresses and does not act as a router.

See also the Stratix 5700 NAT Whitepaper, publication [ENET-WP032](#).

## Configuration Overview

To configure NAT, you create one or more unique NAT instances. A NAT instance contains entries that define each address translation and other configuration parameters.

---

**IMPORTANT** Before you create NAT instances, configure all Smartport roles and VLANs.

---

The translations that you define depend on whether traffic is routed through a Layer 3 switch or router or a Layer 2 switch.

---

**IMPORTANT** As a best practice, we recommend you route traffic through a Layer 3 switch or router.

---

If traffic is routed through a Layer 3 switch or router ([Figure 24](#) and [Figure 25](#)), you define the following:

- A private-to-public translation for each device on the private subnet that communicates on the public subnet.<sup>(2)</sup>
- A gateway translation for the Layer 3 switch or router.

(1) The terms private and public differentiate the two networks on either side of the NAT device. The terms do not mean that the public network must be Internet routable.

(2) Machines that communicate with each other within the same VLAN and subnet across a NAT boundary also require public-to-private translations.

You do not need to configure NAT for all devices on the private subnet. For example, you can choose to omit some devices from NAT to increase security, decrease traffic, or conserve public address space. By default, untranslated packets are dropped at the NAT boundary.

Figure 24 - Layer 3 Example with NAT in Stratix 5700 Switch

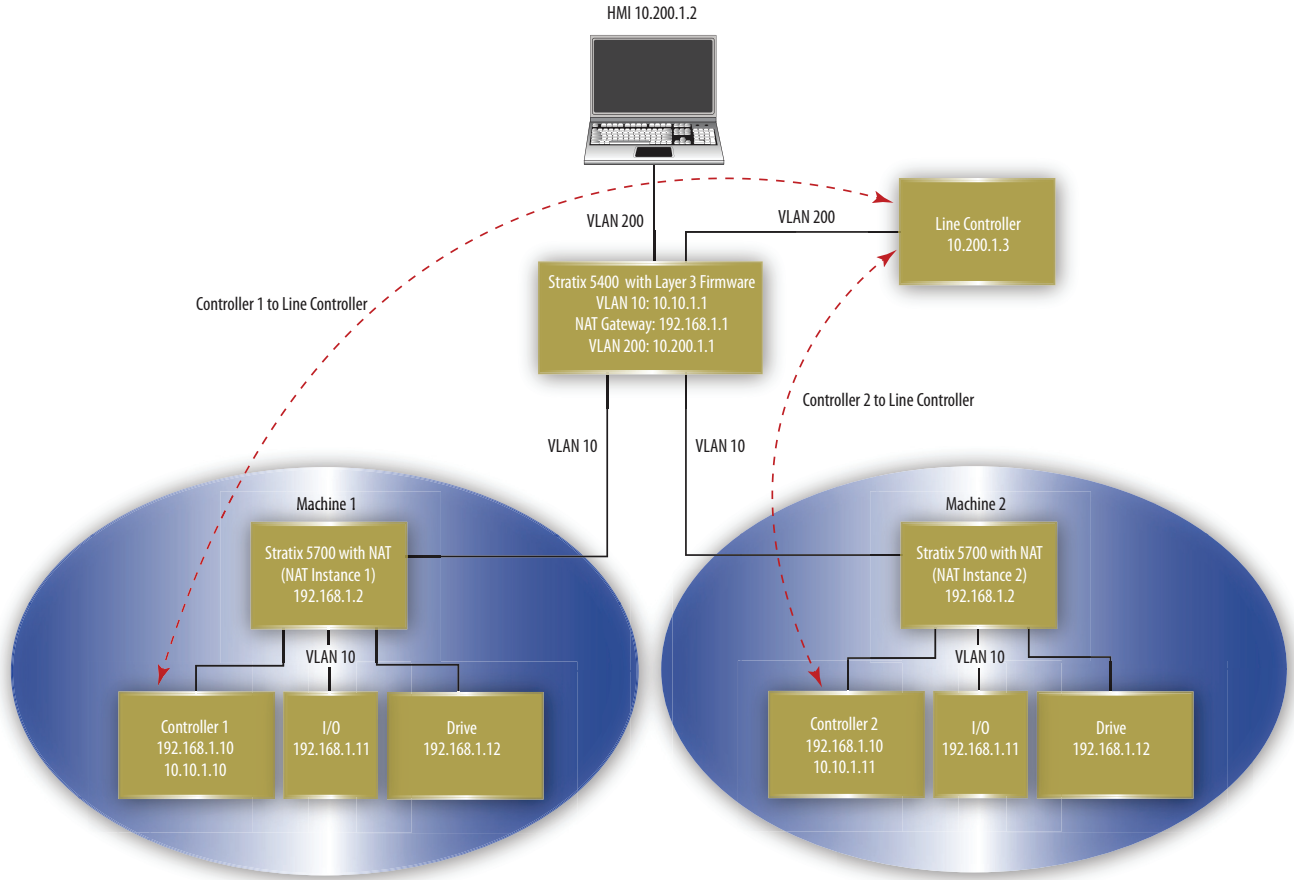



**Figure 25 - Layer 3 Example with NAT in Stratix 5410 Layer 3 Firmware Model**

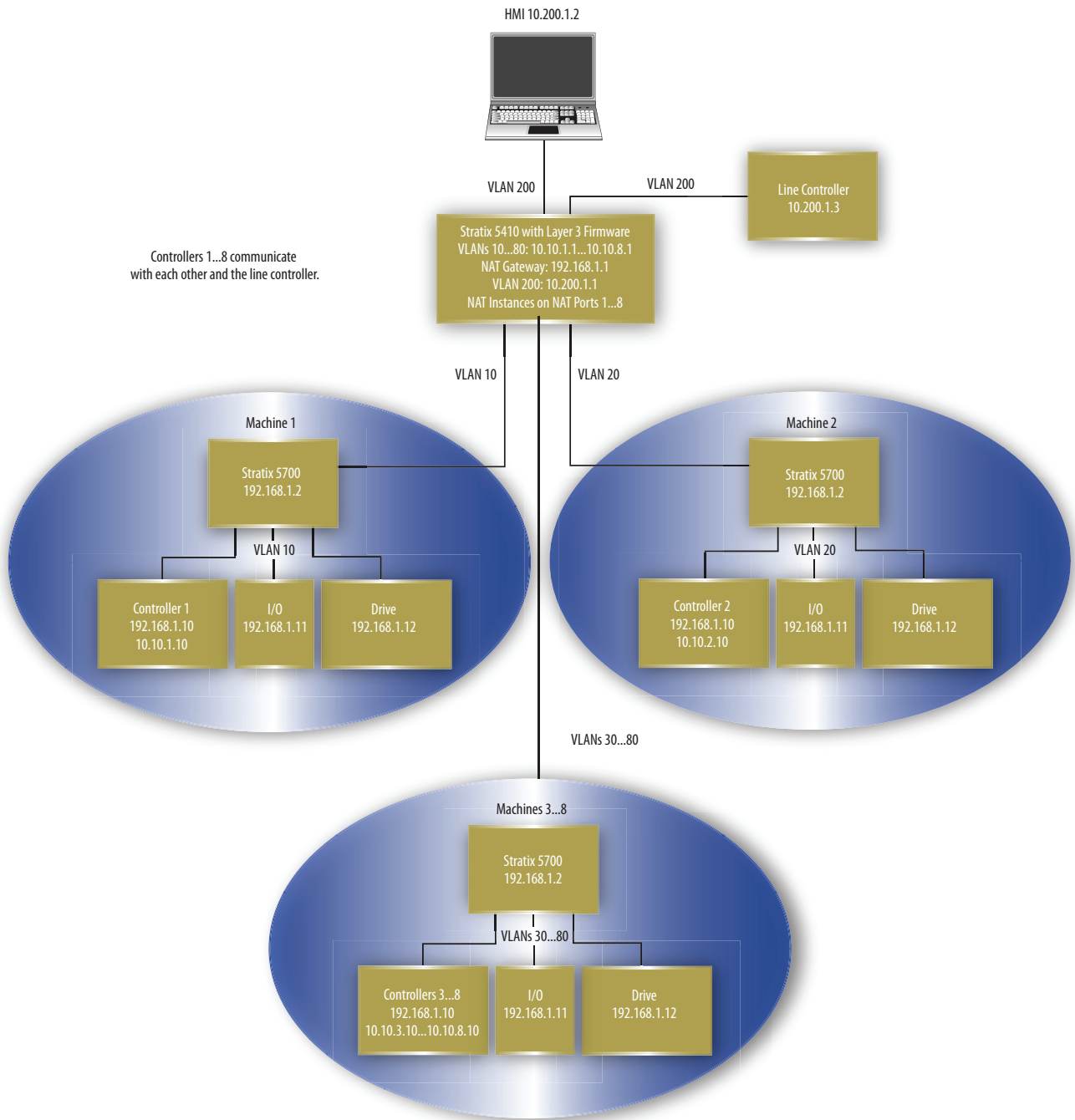

If traffic is routed through a Layer 2 switch (Figure 26 and Figure 27), you define the following.

- A private-to-public translation for each device on the private subnet that communicates on the public subnet.
- A public-to-private translation for each device on the public subnet that communicates on the private subnet.

Figure 26 - Layer 2 Example with NAT in Stratix 5700 Switch

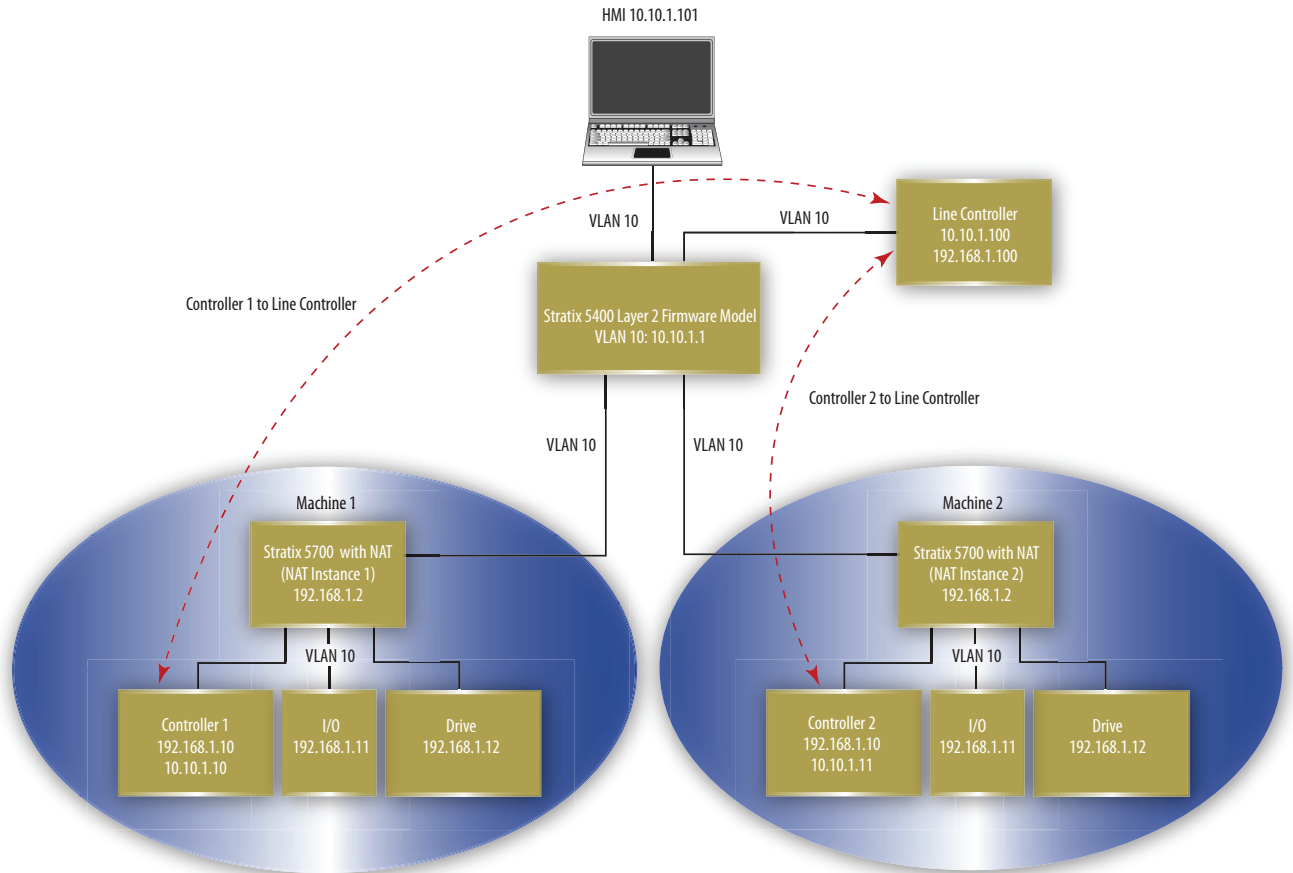

**Figure 27 - Layer 2 Example with NAT in Stratix 5410 Layer 2 Firmware Model**

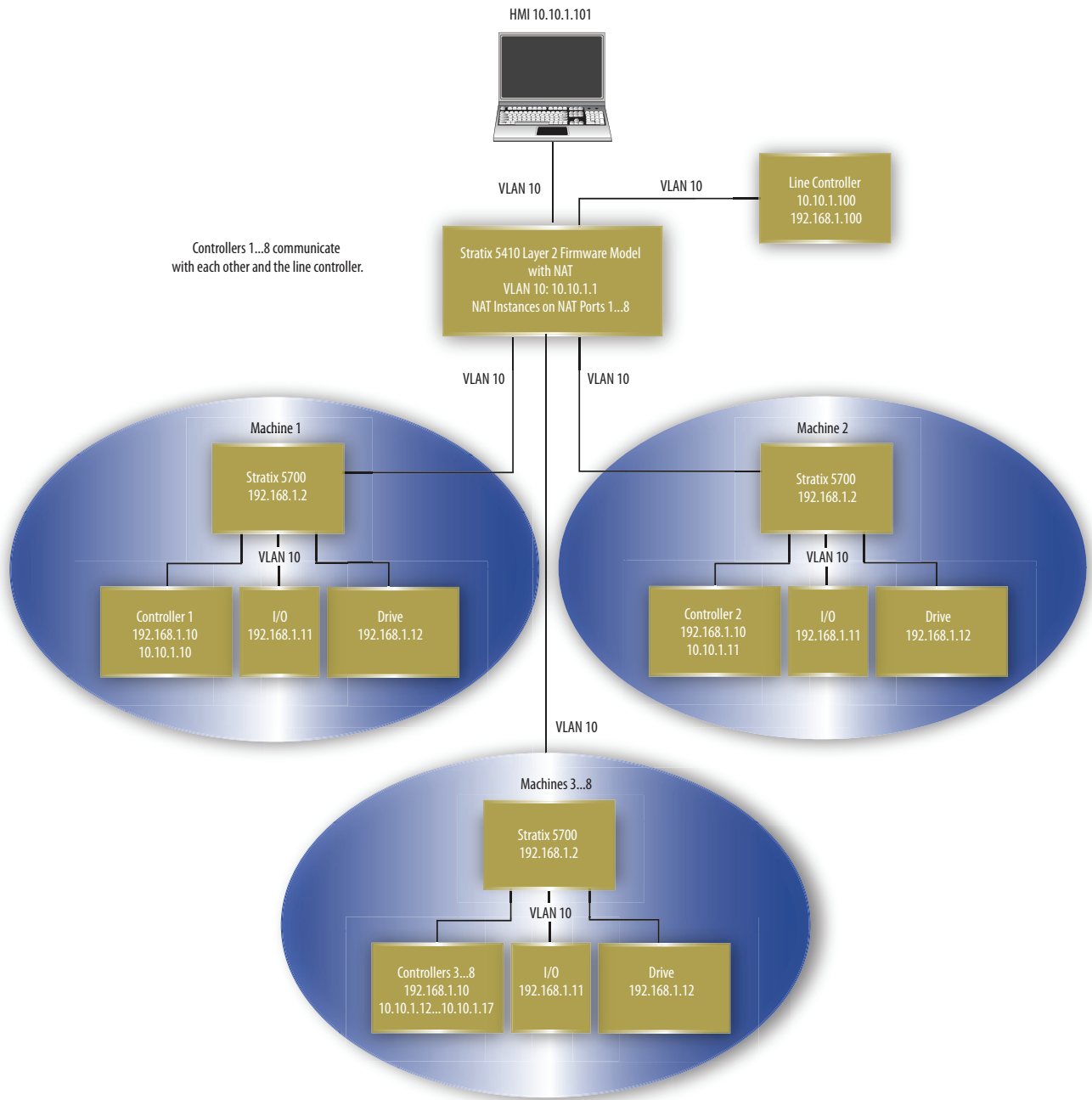

An address translation can be one of three types. The type of translation determines the number of translation entries as shown in [Table 67](#).

**Table 67 - Number of Translation Entries by Translation Type**

Translation Type	Translation Entries	Description
Single	1	Translates one IP address. Consists of the following: <ul style="list-style-type: none"> <li>• One private IP address</li> <li>• One public IP address</li> </ul>
Range	Multiple	Translates a range of IP addresses. Consists of the following: <ul style="list-style-type: none"> <li>• One starting private IP address</li> <li>• One starting public IP address</li> <li>• Multiple entries that are based on the range you specify</li> </ul>
Subnet	1	Translates all IP addresses within a subnet or portion of a subnet. Consists of the following: <ul style="list-style-type: none"> <li>• One starting private IP address</li> <li>• One starting public IP address that is aligned on valid subnet boundaries</li> <li>• Subnet mask</li> </ul>

**EXAMPLE** The following translation types count as 10 translation entries:

- Single translation for one device
- Range translation for eight devices
- Subnet translation for all devices on the subnet

Single and range translation types have a one-to-one relationship between translations entries and addresses to be translated. However, subnet translations have a one-to-many relationship allowing one translation entry for many addresses.

[Table 68](#) defines the maximum number of translation entries that are allowed per switch.

**Table 68 - Maximum Translation Entries**

Switch	Maximum Translation Entries
Stratix 5400 and Stratix 5700	128 across all NAT ports.
Stratix 5410	128 across NAT ports 1...6 and 13...18. and 128 across NAT ports 7...12, 19...24, and 25...28.

## VLAN Assignments

When configuring NAT, you can assign one or more VLANs to a NAT instance. When you assign a VLAN to a NAT instance, the traffic that is associated with that VLAN is subject to the configuration parameters of the NAT instance. Configuration parameters include whether traffic is translated, fixed up, blocked, or passed through.

---

**IMPORTANT** Changes to the native VLAN on a port assigned to a NAT instance can break existing NAT configurations. If you change the VLAN assigned to a port associated with a NAT instance, you must reassign VLANs to that NAT instance.

Make sure all VLANs and Smartport roles are configured prior to NAT configuration.

---

When assigning VLANs to a NAT instance, consider the following:

- NAT supports both trunk ports and access ports.
- NAT does not change VLAN tags.
- You can assign a maximum of 128 VLANs to one or more instances.
- You can assign the same VLAN to multiple instances as long as the VLAN is associated with different ports. For example, you can assign VLAN 1 to both instance A and instance B. However, VLAN 1 must be associated with port Gi1/1 on instance A and port Gi1/2 on instance B.
- By default, each instance is assigned to all VLANs on port Gi1/1 and no instances on port Gi1/2.

VLANs associated with a trunk port can or cannot be assigned to a NAT instance:

- If a VLAN is assigned to a NAT instance, its traffic is subject to the configuration parameters of the NAT instance.
- If a VLAN is unassigned to a NAT instance, its traffic remains untranslated and is always permitted to pass through the trunk port.

### Management Interface and VLANs

The management interface can be associated with a VLAN that is or is not assigned to a NAT instance:

- If its associated VLAN is assigned to a NAT instance, the management interface resides on the private subnet by default. To manage the switch from the private subnet, no additional configuration is required. To manage the switch from the public subnet, you must configure a private-to-public translation.
- If its associated VLAN is not assigned to a NAT instance, the traffic of the management interface remains untranslated and is always permitted to pass through the port.

### Configuration Considerations

Consider these guidelines and limitations when configuring NAT:

- All switches can translate only IPv4 addresses.
- All switches can have a maximum of 128 NAT instances.
- Switch-specific features are shown in the following table.

Feature	Stratix 5700 Switch	Stratix 5400 Switch	Stratix 5410 Switch
Uplink Ports	2	4	4 <sup>(2)</sup>
Downlink Ports	0	0	8 <sup>(2)</sup>
Translation Entries <sup>(1)</sup>	128	128	256 <sup>(3)</sup>

(1) A subnet translation counts as only one translation entry, but includes translations for many devices

(2) Both uplink and downlink ports can be configured for as many as 8 NAT ports.

(3) 128 entries across ports 1...6 and 13...18, plus 128 entries across ports 7...12, 19...24, and 25...28 for a total of 256 entries.

---

**IMPORTANT** Some NAT configurations can result in greater-than-expected traffic loads on both private and public subnets. Also, unintended traffic can be visible. NAT is not a substitute for a firewall. Make sure that your configuration is performance qualified before use in a production environment.

---

Ports that are configured for NAT do **not** support the following across the NAT boundary due to embedded IP addresses that are not fixed up, encrypted IP addresses, or reliance on multicast traffic:

- Traffic encryption and integrity checking protocols incompatible with NAT, including IPsec Transport mode (1756-EN2TSC module)
- Applications that use dynamic session initiations, such as NetMeeting
- File Transfer Protocol (FTP)
- Microsoft Distributed Component Object Model (DCOM), which is used in Open Platform Communications (OPC)
- Multicast traffic, including applications that use multicast, such as CIP Sync (IEEE1588) and ControlLogix redundancy

## Traffic Permits and Fixups

While a NAT-configured port can translate many types of traffic, only unicast and broadcast traffic are supported. You can choose to block or pass through the following unsupported traffic types:

- Untranslated unicast traffic
- Multicast traffic
- IGMP traffic

By default, all preceding traffic types are blocked.

Some traffic types must be fixed up to work properly with NAT because their packets contain embedded IP addresses. The switch supports fixups for these traffic types:

- Address Resolution Protocol (ARP)
- Internet Control Message Protocol (ICMP)

By default, fixups are enabled for both ARP and ICMP.

## Configure NAT via Device Manager

To configure NAT, follow one of these procedures that are based on your application:

- [Create NAT Instances for Traffic Routed through a Layer 3 Switch or Router](#)

For an example of this application, see [Figure 24](#) and [Figure 27](#).

- [Create NAT Instances for Traffic Routed through a Layer 2 Switch](#)

For an example of this application, see [Figure 26](#) and [Figure 27](#).

---

**IMPORTANT** Configure all Smartport roles and VLANs before creating NAT instances. If you change a Smartport role or the native VLAN for a port that is associated with a NAT instance, you must reassign VLANs to the NAT instance.

---

---

**IMPORTANT** As a result of Layer 2 forwarding, current traffic sessions remain established until manually disconnected. If you change an existing translation, you must manually disconnect all associated traffic sessions before the new translation can take effect.

---

*Create NAT Instances for Traffic Routed through a Layer 3 Switch or Router*

1. From the Configure menu, choose NAT to display the NAT page.

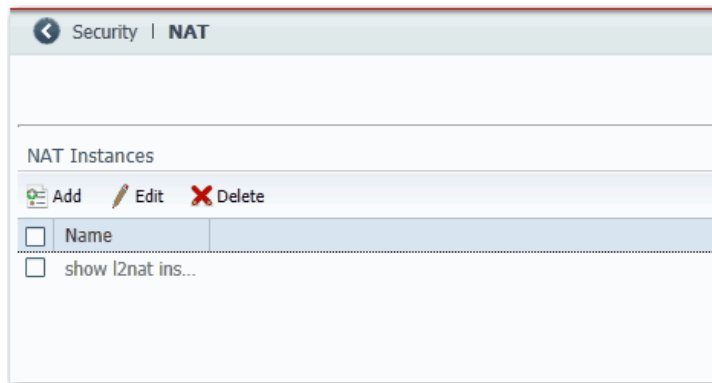

2. Click Add to display the General tab of the Add/Edit NAT Instance page.



VLAN Selection for Stratix 5700 and 5400 Switches

**ADD / Edit Nat Instance**

Name :

General Public to Private Advanced

Private to Public

Private  Public  Type  Range  Subnet Mask

Private	Public	Type	Range	Subnet Mask
<input checked="" type="checkbox"/>	10.10.10.1	20.20.20.1	Single	1

Save | Cancel

Gateway Translation

Public  Private

No data available

Submit Cancel

**Gi1/1 Vlan**

1(native vlan)

2

500

**Gi1/2 Vlan**

1(native vlan)

2

500

VLAN Selection for Stratix 5410 Switches

**Add NAT Instance**

Name :

General Public to Private Advanced

Private to Public

Private  Public  Type  Range  Subnet Mask

Private	Public	Type	Range	Subnet Mask
<input checked="" type="checkbox"/>	10.10.10.1	20.20.20.1	Single	1

Save | Cancel

Gateway Translation

Public  Private

No data available

Submit Cancel

**NAT Port 1: Gi1/1**

Port :

1

533(native vlan)

NAT Port 2: None

NAT Port 3: None

NAT Port 4: None

NAT Port 5: None

NAT Port 6: None

NAT Port 7: None

NAT Port 8: None

3. In the Name field, type a unique name to identify the instance.

The instance name cannot include spaces or exceed 32 characters.

4. Complete VLAN assignments:

- (Stratix 5700 and 5400 switches) For each uplink port on the right, select each VLAN to assign to the instance.
- (Stratix 5410 switches) For each NAT port, choose an uplink or downlink port, and then select each VLAN to assign to the instance. The pull-down menu includes all ports (Gi1/1...Gi1/24 and Te1/25 ...Te1/28) and the default option None. When choosing ports, these rules apply:
  - You can configure as many as four NAT ports from Gi1/1...Gi1/6 and Gi1/13...Gi1/18.
  - You can configure as many as four NAT ports from Gi1/7...Gi1/12, Gi1/19...Gi1/24, and Te1/25...Te1/28.
  - If four ports from Gi 1/1...Gi 1/6 and Gi 1/13...Gi 1/18 are already in use, all other ports in that range are unavailable in subsequent port selection lists.
  - If you choose a downlink port, all uplink ports become unavailable, and if you choose an uplink port, all downlink ports become unavailable.

For more information about VLAN assignments, see [page 173](#).

5. In the Private to Public area, click Add Row, complete the fields, and click Save.

Field	Description
Private IP Address	Type a private IP address: <ul style="list-style-type: none"> <li>• To translate one address, type the existing address for the device on the private subnet.</li> <li>• To translate a range of addresses, type the first address in the range of sequential addresses.</li> <li>• To translate addresses in a subnet, type the existing starting address for a device on the private subnet. This address must correspond to the size of the subnet mask to translate.</li> </ul>
<b>Subnet Mask</b>	<b>Starting Private Subnet Address</b>
255.255.0.0	The last two octets must end in 0. <b>EXAMPLE:</b> 192.168.0.0
255.255.255.0	The last octet must end in 0. <b>EXAMPLE:</b> 192.168.1.0
255.255.255.128	The last octet must end in 0 or 128. <b>EXAMPLE:</b> 192.168.1.0 or 192.168.1.128
255.255.255.192	The last octet must end in one of the following: 0, 64, 128, 192. <b>EXAMPLE:</b> 192.168.1.64
255.255.255.224	The last octet must end in one of the following: 0, 32, 64, 96, 128, 160, 192, 224. <b>EXAMPLE:</b> 192.168.1.32
255.255.255.240	The last octet must end in one of the following: 0, 16, 32, 48, 64, 80, 96, 112, 128, 144, 160, 176, 192, 208, 224, 240. <b>EXAMPLE:</b> 192.168.1.16

Field	Description														
Public IP Address	Type a public IP address: <ul style="list-style-type: none"> <li>To translate one address, type a unique public address to represent the device.</li> <li>To translate a range of addresses, type the first address in the range of sequential addresses.</li> <li>To translate addresses in a subnet, type a unique, starting public address to represent the devices. This address must correspond to the size of the subnet mask to translate.</li> </ul>														
	<table border="1"> <thead> <tr> <th>Subnet Mask</th> <th>Starting Public Subnet Address</th> </tr> </thead> <tbody> <tr> <td>255.255.0.0</td> <td>The last two octets must end in 0. <b>EXAMPLE:</b> 10.200.0.0</td> </tr> <tr> <td>255.255.255.0</td> <td>The last octet must end in 0. <b>EXAMPLE:</b> 10.200.1.0.</td> </tr> <tr> <td>255.255.255.128</td> <td>The last octet must end in 0 or 128. <b>EXAMPLE:</b> 10.200.1.0 or 10.200.1.128</td> </tr> <tr> <td>255.255.255.192</td> <td>The last octet must end in one of the following: 0, 64, 128, 192. <b>EXAMPLE:</b> 10.200.1.64</td> </tr> <tr> <td>255.255.255.224</td> <td>The last octet must end in one of the following: 0, 32, 64, 96, 128, 160, 192, 224. <b>EXAMPLE:</b> 10.200.1.32</td> </tr> <tr> <td>255.255.255.240</td> <td>The last octet must end in one of the following: 0, 16, 32, 48, 64, 80, 96, 112, 128, 144, 160, 176, 192, 208, 224, 240. <b>EXAMPLE:</b> 10.200.1.16</td> </tr> </tbody> </table>	Subnet Mask	Starting Public Subnet Address	255.255.0.0	The last two octets must end in 0. <b>EXAMPLE:</b> 10.200.0.0	255.255.255.0	The last octet must end in 0. <b>EXAMPLE:</b> 10.200.1.0.	255.255.255.128	The last octet must end in 0 or 128. <b>EXAMPLE:</b> 10.200.1.0 or 10.200.1.128	255.255.255.192	The last octet must end in one of the following: 0, 64, 128, 192. <b>EXAMPLE:</b> 10.200.1.64	255.255.255.224	The last octet must end in one of the following: 0, 32, 64, 96, 128, 160, 192, 224. <b>EXAMPLE:</b> 10.200.1.32	255.255.255.240	The last octet must end in one of the following: 0, 16, 32, 48, 64, 80, 96, 112, 128, 144, 160, 176, 192, 208, 224, 240. <b>EXAMPLE:</b> 10.200.1.16
Subnet Mask	Starting Public Subnet Address														
255.255.0.0	The last two octets must end in 0. <b>EXAMPLE:</b> 10.200.0.0														
255.255.255.0	The last octet must end in 0. <b>EXAMPLE:</b> 10.200.1.0.														
255.255.255.128	The last octet must end in 0 or 128. <b>EXAMPLE:</b> 10.200.1.0 or 10.200.1.128														
255.255.255.192	The last octet must end in one of the following: 0, 64, 128, 192. <b>EXAMPLE:</b> 10.200.1.64														
255.255.255.224	The last octet must end in one of the following: 0, 32, 64, 96, 128, 160, 192, 224. <b>EXAMPLE:</b> 10.200.1.32														
255.255.255.240	The last octet must end in one of the following: 0, 16, 32, 48, 64, 80, 96, 112, 128, 144, 160, 176, 192, 208, 224, 240. <b>EXAMPLE:</b> 10.200.1.16														
Type	Choose one of these values: <ul style="list-style-type: none"> <li>Single—Translate one address.</li> <li>Range—Translate a range of addresses.</li> <li>Subnet—Translate all addresses in the private subnet or a portion of the private subnet.</li> </ul>														
Range	Type the number of addresses to translate. This field is available only if you choose Range in the Type field. Valid values: 2...128 Default value = 1 <b>IMPORTANT:</b> Each address in the range counts as one translation entry. The switch supports a maximum of 128 translation entries.														
Subnet Mask	Type the subnet mask for the addresses to translate. Valid values: <ul style="list-style-type: none"> <li>Class B: 255.255.0.0</li> <li>Class C: 255.255.255.0</li> <li>Portion of Class C: <ul style="list-style-type: none"> <li>255.255.255.128 (provides 128 addresses per translation entry)</li> <li>255.255.255.192 (provides 64 addresses per translation entry)</li> <li>255.255.255.224 (provides 32 addresses per translation entry)</li> <li>255.255.255.240 (provides 16 addresses per translation entry)</li> </ul> </li> </ul>														

- In the Gateway Translation area, click Add Row, complete the fields, and click Save.

The gateway translation enables devices on the public subnet to communicate with devices on the private subnet.

Field	Description
Public	Type the default gateway address of the Layer 3 switch or router that is connected to the uplink port of the switch.
Private	Type a unique IP address to represent the Layer 3 switch or router on the private network.

- (Optional). To configure traffic permits and packet fixups, see [Configure Traffic Permits and Fixups on page 186](#).
- Click Submit.

### Create NAT Instances for Traffic Routed through a Layer 2 Switch

1. From the Configure menu, choose NAT to display the NAT page.

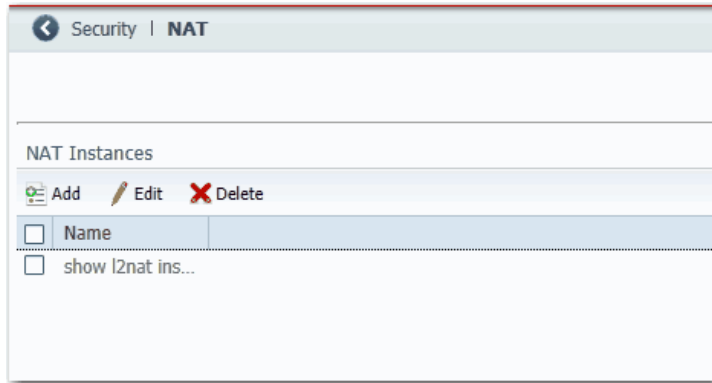

2. Click Add to display the General tab of the Add/Edit NAT Instance page.

VLAN Selection for Stratix 5700 and 5400 Switches

**ADD / Edit Nat Instance**

Name :

General Public to Private Advanced

Private to Public

Private	Public	Type	Range	Subnet Mask
<input checked="" type="checkbox"/>	10.10.10.1	20.20.20.1	Single	1

Save | Cancel

Gateway Translation

No data available

**Gi1/1 Vlans**

- 1(native vlan)
- 2
- 500

**Gi1/2 Vlans**

- 1(native vlan)
- 2
- 500

Submit Cancel

**Add NAT Instance**

Name :

General Public to Private Advanced

Private to Public

Private	Public	Type	Range	Subnet Mask
<input checked="" type="checkbox"/>	10.10.10.1	20.20.20.1	Single	1

Save | Cancel

Gateway Translation

No data available

**NAT Port 1: Gi1/1**

Port :

- 1
- 533(native vlan)

NAT Port 2: None

NAT Port 3: None

NAT Port 4: None

NAT Port 5: None

NAT Port 6: None

NAT Port 7: None

NAT Port 8: None

Submit Cancel

3. In the Name field, type a unique name to identify the instance.

The instance name cannot include spaces or exceed 32 characters.

4. Complete VLAN assignments:

- (Stratix 5700 and 5400 switches) For each uplink port on the right, select each VLAN to assign to the instance.
- (Stratix 5410 switches) For each NAT port, choose an uplink or downlink port, and then select each VLAN to assign to the instance. The pull-down menu list includes all ports (Gi1/1...Gi1/24 and Te1/25 ...Te1/28) and the default option None. When choosing ports, these rules apply:
  - You can configure up to four NAT ports from Gi1/1...Gi1/6 and Gi1/13...Gi1/18.
  - You can configure up to four NAT ports from Gi1/7...Gi1/12, Gi1/19...Gi1/24, and Te1/25...Te1/28.
  - If four ports from Gi 1/1...Gi 1/6 and Gi 1/13...Gi 1/18 are already in use, all other ports in that range are unavailable in subsequent port selection lists.
  - If you choose a downlink port, all uplink ports become unavailable, and if you choose an uplink port, all downlink ports become unavailable.

For more information about VLAN assignments, see [page 173](#).

5. In the Private to Public area, click Add Row, complete the fields, and click Save.

Field	Description														
Private IP Address	Type a private IP address: <ul style="list-style-type: none"> <li>• To translate one address, type the existing address for the device on the private subnet.</li> <li>• To translate a range of addresses, type the first address in the range of sequential addresses.</li> <li>• To translate addresses in a subnet, type the existing starting address for a device on the private subnet. This address must correspond to the size of the subnet mask to translate.</li> </ul>														
	<table border="1"> <thead> <tr> <th>Subnet Mask</th> <th>Starting Private Subnet Address</th> </tr> </thead> <tbody> <tr> <td>255.255.0.0</td> <td>The last two octets must end in 0. <b>EXAMPLE:</b> 192.168.0.0</td> </tr> <tr> <td>255.255.255.0</td> <td>The last octet must end in 0. <b>EXAMPLE:</b> 192.168.1.0</td> </tr> <tr> <td>255.255.255.128</td> <td>The last octet must end in 0 or 128. <b>EXAMPLE:</b> 192.168.1.0 or 192.168.1.128</td> </tr> <tr> <td>255.255.255.192</td> <td>The last octet must end in one of the following: 0, 64, 128, 192. <b>EXAMPLE:</b> 192.168.1.64</td> </tr> <tr> <td>255.255.255.224</td> <td>The last octet must end in one of the following: 0, 32, 64, 96, 128, 160, 192, 224. <b>EXAMPLE:</b> 192.168.1.32</td> </tr> <tr> <td>255.255.255.240</td> <td>The last octet must end in one of the following: 0, 16, 32, 48, 64, 80, 96, 112, 128, 144, 160, 176, 192, 208, 224, 240. <b>EXAMPLE:</b> 192.168.1.16</td> </tr> </tbody> </table>	Subnet Mask	Starting Private Subnet Address	255.255.0.0	The last two octets must end in 0. <b>EXAMPLE:</b> 192.168.0.0	255.255.255.0	The last octet must end in 0. <b>EXAMPLE:</b> 192.168.1.0	255.255.255.128	The last octet must end in 0 or 128. <b>EXAMPLE:</b> 192.168.1.0 or 192.168.1.128	255.255.255.192	The last octet must end in one of the following: 0, 64, 128, 192. <b>EXAMPLE:</b> 192.168.1.64	255.255.255.224	The last octet must end in one of the following: 0, 32, 64, 96, 128, 160, 192, 224. <b>EXAMPLE:</b> 192.168.1.32	255.255.255.240	The last octet must end in one of the following: 0, 16, 32, 48, 64, 80, 96, 112, 128, 144, 160, 176, 192, 208, 224, 240. <b>EXAMPLE:</b> 192.168.1.16
Subnet Mask	Starting Private Subnet Address														
255.255.0.0	The last two octets must end in 0. <b>EXAMPLE:</b> 192.168.0.0														
255.255.255.0	The last octet must end in 0. <b>EXAMPLE:</b> 192.168.1.0														
255.255.255.128	The last octet must end in 0 or 128. <b>EXAMPLE:</b> 192.168.1.0 or 192.168.1.128														
255.255.255.192	The last octet must end in one of the following: 0, 64, 128, 192. <b>EXAMPLE:</b> 192.168.1.64														
255.255.255.224	The last octet must end in one of the following: 0, 32, 64, 96, 128, 160, 192, 224. <b>EXAMPLE:</b> 192.168.1.32														
255.255.255.240	The last octet must end in one of the following: 0, 16, 32, 48, 64, 80, 96, 112, 128, 144, 160, 176, 192, 208, 224, 240. <b>EXAMPLE:</b> 192.168.1.16														

Field	Description	
Public IP Address	Type a public IP address: <ul style="list-style-type: none"> <li>To translate one address, type a unique public address to represent the device.</li> <li>To translate a range of addresses, type the first address in the range of sequential addresses.</li> <li>To translate addresses in a subnet, type a unique, starting public address to represent the devices. This address must correspond to the size of the subnet mask to translate.</li> </ul>	
	<b>Subnet Mask</b>	<b>Starting Public Subnet Address</b>
	255.255.0.0	The last two octets must end in 0. <b>EXAMPLE:</b> 10.200.0.0
	255.255.255.0	The last octet must end in 0. <b>EXAMPLE:</b> 10.200.1.0.
	255.255.255.128	The last octet must end in 0 or 128. <b>EXAMPLE:</b> 10.200.1.0 or 10.200.1.128
	255.255.255.192	The last octet must end in one of the following: 0, 64, 128, 192. <b>EXAMPLE:</b> 10.200.1.64
	255.255.255.224	The last octet must end in one of the following: 0, 32, 64, 96, 128, 160, 192, 224. <b>EXAMPLE:</b> 10.200.1.32
255.255.255.240	The last octet must end in one of the following: 0, 16, 32, 48, 64, 80, 96, 112, 128, 144, 160, 176, 192, 208, 224, 240. <b>EXAMPLE:</b> 10.200.1.16	
Type	Choose one of these values: <ul style="list-style-type: none"> <li>Single—Translate one address.</li> <li>Range—Translate a range of addresses.</li> <li>Subnet—Translate all addresses in the private subnet or a portion of the private subnet.</li> </ul>	
Range	Type the number of addresses to translate. This field is available only if you choose Range in the Type field. Valid values: 2...128 Default value = 1 <b>IMPORTANT:</b> Each address in the range counts as one translation entry. The switch supports a maximum of 128 translation entries.	
Subnet Mask	Type the subnet mask for the addresses to translate. Valid values: <ul style="list-style-type: none"> <li>Class B: 255.255.0.0</li> <li>Class C: 255.255.255.0</li> <li>Portion of Class C: <ul style="list-style-type: none"> <li>– 255.255.255.128 (provides 128 addresses per translation entry)</li> <li>– 255.255.255.192 (provides 64 addresses per translation entry)</li> <li>– 255.255.255.224 (provides 32 addresses per translation entry)</li> <li>– 255.255.255.240 (provides 16 addresses per translation entry)</li> </ul> </li> </ul>	

6. Click the Public to Private tab.

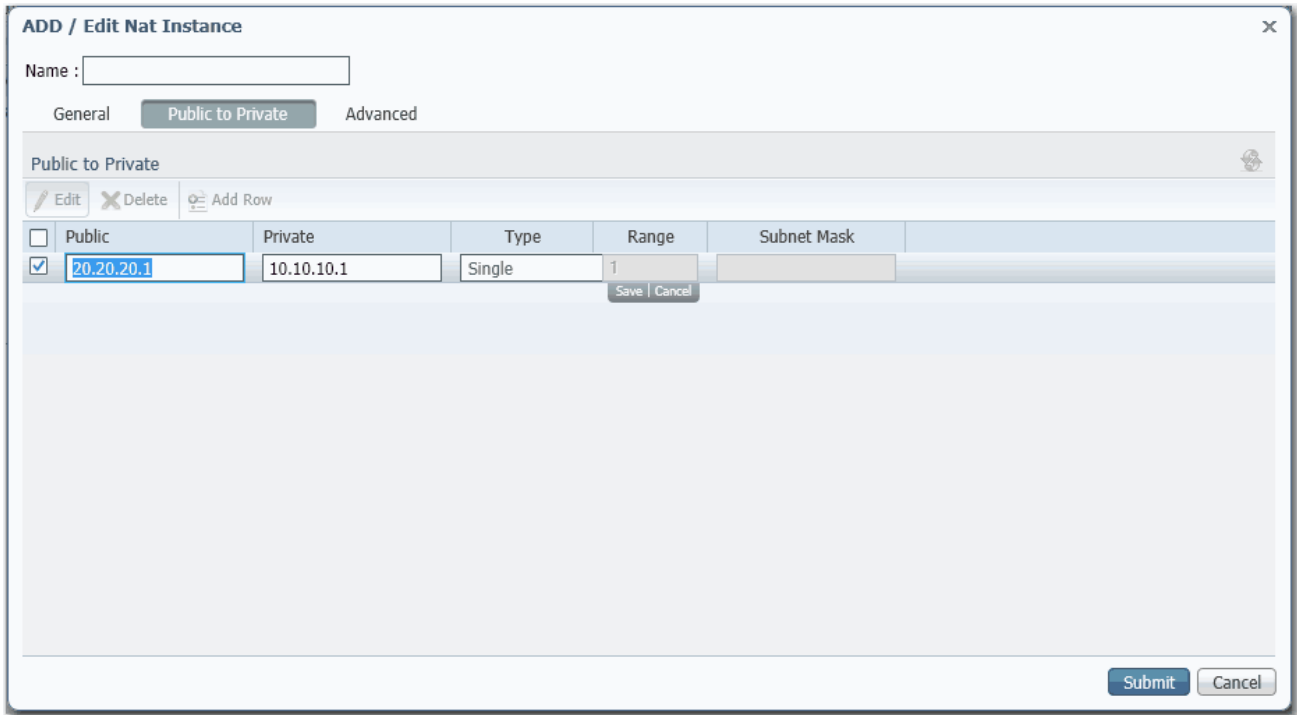

7. Click Add Row, complete the fields, and click Save.

Field	Description														
Public IP Address	<p>Type a public IP address:</p> <ul style="list-style-type: none"> <li>To translate one address, type the existing address for the device on the public subnet.</li> <li>To translate a range of addresses, type the first address in the range of sequential addresses.</li> <li>To translate addresses in a subnet, type the existing starting address for the range of devices on the public subnet. This address must correspond to the size of the subnet mask to translate.</li> </ul>														
	<table border="1"> <thead> <tr> <th>Subnet Mask</th> <th>Starting Public Subnet Address</th> </tr> </thead> <tbody> <tr> <td>255.255.0.0</td> <td>The last two octets must end in 0. <b>EXAMPLE:</b> 10.200.0.0</td> </tr> <tr> <td>255.255.255.0</td> <td>The last octet must end in 0. <b>EXAMPLE:</b> 10.200.1.0.</td> </tr> <tr> <td>255.255.255.128</td> <td>The last octet must end in 0 or 128. <b>EXAMPLE:</b> 10.200.1.0 or 10.200.1.128</td> </tr> <tr> <td>255.255.255.192</td> <td>The last octet must end in one of the following: 0, 64, 128, 192. <b>EXAMPLE:</b> 10.200.1.64</td> </tr> <tr> <td>255.255.255.224</td> <td>The last octet must end in one of the following: 0, 32, 64, 96, 128, 160, 192, 224. <b>EXAMPLE:</b> 10.200.1.32</td> </tr> <tr> <td>255.255.255.240</td> <td>The last octet must end in one of the following: 0, 16, 32, 48, 64, 80, 96, 112, 128, 144, 160, 176, 192, 208, 224, 240. <b>EXAMPLE:</b> 10.200.1.16</td> </tr> </tbody> </table>	Subnet Mask	Starting Public Subnet Address	255.255.0.0	The last two octets must end in 0. <b>EXAMPLE:</b> 10.200.0.0	255.255.255.0	The last octet must end in 0. <b>EXAMPLE:</b> 10.200.1.0.	255.255.255.128	The last octet must end in 0 or 128. <b>EXAMPLE:</b> 10.200.1.0 or 10.200.1.128	255.255.255.192	The last octet must end in one of the following: 0, 64, 128, 192. <b>EXAMPLE:</b> 10.200.1.64	255.255.255.224	The last octet must end in one of the following: 0, 32, 64, 96, 128, 160, 192, 224. <b>EXAMPLE:</b> 10.200.1.32	255.255.255.240	The last octet must end in one of the following: 0, 16, 32, 48, 64, 80, 96, 112, 128, 144, 160, 176, 192, 208, 224, 240. <b>EXAMPLE:</b> 10.200.1.16
Subnet Mask	Starting Public Subnet Address														
255.255.0.0	The last two octets must end in 0. <b>EXAMPLE:</b> 10.200.0.0														
255.255.255.0	The last octet must end in 0. <b>EXAMPLE:</b> 10.200.1.0.														
255.255.255.128	The last octet must end in 0 or 128. <b>EXAMPLE:</b> 10.200.1.0 or 10.200.1.128														
255.255.255.192	The last octet must end in one of the following: 0, 64, 128, 192. <b>EXAMPLE:</b> 10.200.1.64														
255.255.255.224	The last octet must end in one of the following: 0, 32, 64, 96, 128, 160, 192, 224. <b>EXAMPLE:</b> 10.200.1.32														
255.255.255.240	The last octet must end in one of the following: 0, 16, 32, 48, 64, 80, 96, 112, 128, 144, 160, 176, 192, 208, 224, 240. <b>EXAMPLE:</b> 10.200.1.16														



Field	Description	
Private IP Address	Type a private IP address: <ul style="list-style-type: none"> <li>To translate one address, type a unique private address to represent the device.</li> <li>To translate a range of addresses, type the first address in the range of sequential addresses.</li> <li>To translate addresses in a subnet, type a unique, starting private address to represent the devices. This address must correspond to the size of the subnet mask to translate.</li> </ul>	
	<b>Subnet Mask</b>	<b>Starting Private Subnet Address</b>
	255.255.0.0	The last two octets must end in 0. <b>EXAMPLE:</b> 192.168.0.0
	255.255.255.0	The last octet must end in 0. <b>EXAMPLE:</b> 192.168.1.0
	255.255.255.128	The last octet must end in 0 or 128. <b>EXAMPLE:</b> 192.168.1.0 or 192.168.1.128
	255.255.255.192	The last octet must end in one of the following: 0, 64, 128, 192. <b>EXAMPLE:</b> 192.168.1.64
	255.255.255.224	The last octet must end in one of the following: 0, 32, 64, 96, 128, 160, 192, 224. <b>EXAMPLE:</b> 192.168.1.32
255.255.255.240	The last octet must end in one of the following: 0, 16, 32, 48, 64, 80, 96, 112, 128, 144, 160, 176, 192, 208, 224, 240. <b>EXAMPLE:</b> 10.200.1.16	
Type	Choose one of these values: <ul style="list-style-type: none"> <li>Single—Translate one address.</li> <li>Range—Translate a range of addresses.</li> <li>Subnet—Translate all addresses in the public subnet or a portion of the public subnet.</li> </ul>	
Range	Type the number of addresses to translate. This field is available only if you choose Range in the Type field. Valid values: 2...128 Default value = 1 <b>IMPORTANT:</b> Each address in the range counts as one translation entry. The switch supports a maximum of 128 translation entries.	
Subnet Mask	Type the subnet mask for the addresses to translate. Valid values: <ul style="list-style-type: none"> <li>Class B: 255.255.0.0</li> <li>Class C: 255.255.255.0</li> <li>Portion of Class C: <ul style="list-style-type: none"> <li>255.255.255.128 (provides 128 addresses per translation entry)</li> <li>255.255.255.192 (provides 64 addresses per translation entry)</li> <li>255.255.255.224 (provides 32 addresses per translation entry)</li> <li>255.255.255.240 (provides 16 addresses per translation entry)</li> </ul> </li> </ul>	

8. (Optional). To configure traffic permits and packet fixups, see [Configure Traffic Permits and Fixups](#).

9. On the NAT page, click Submit.

### Configure Traffic Permits and Fixups

Use caution when you configure traffic permits and fixups. We recommend that you use the default values.

1. Click the Advanced tab.

The screenshot shows the 'ADD / Edit Nat Instance' configuration window. At the top, there is a 'Name' input field. Below it are three tabs: 'General', 'Public to Private', and 'Advanced'. The 'Advanced' tab is selected. Underneath the tabs is a table for 'Traffic Permits' with columns for 'Incoming' and 'Outgoing'. Below the table is a 'Fix up Packets' section with two checked checkboxes: 'ARP' and 'ICMP'. At the bottom right, there are 'Submit' and 'Cancel' buttons.

Traffic Permits	Incoming	Outgoing
Non-Translated	blocked	blocked
Multicast	blocked	blocked
IGMP	blocked	blocked

**Fix up Packets**

ARP

ICMP

2. Choose one of these options for incoming and outgoing packets that are not handled by NAT:
  - Pass-through—Permit the packets to pass across the NAT boundary.
  - Blocked—Drop the packets.
3. In the Fix up Packets area, check or clear the checkboxes to enable or disable fixups for ARP and ICMP.
 

By default, fixups are enabled for both ARP and ICMP.
4. Click Submit.

## Configure NAT via the Logix Designer Application

For Stratix 5410 switches, see [page 199](#).

In the navigation pane, click NAT.

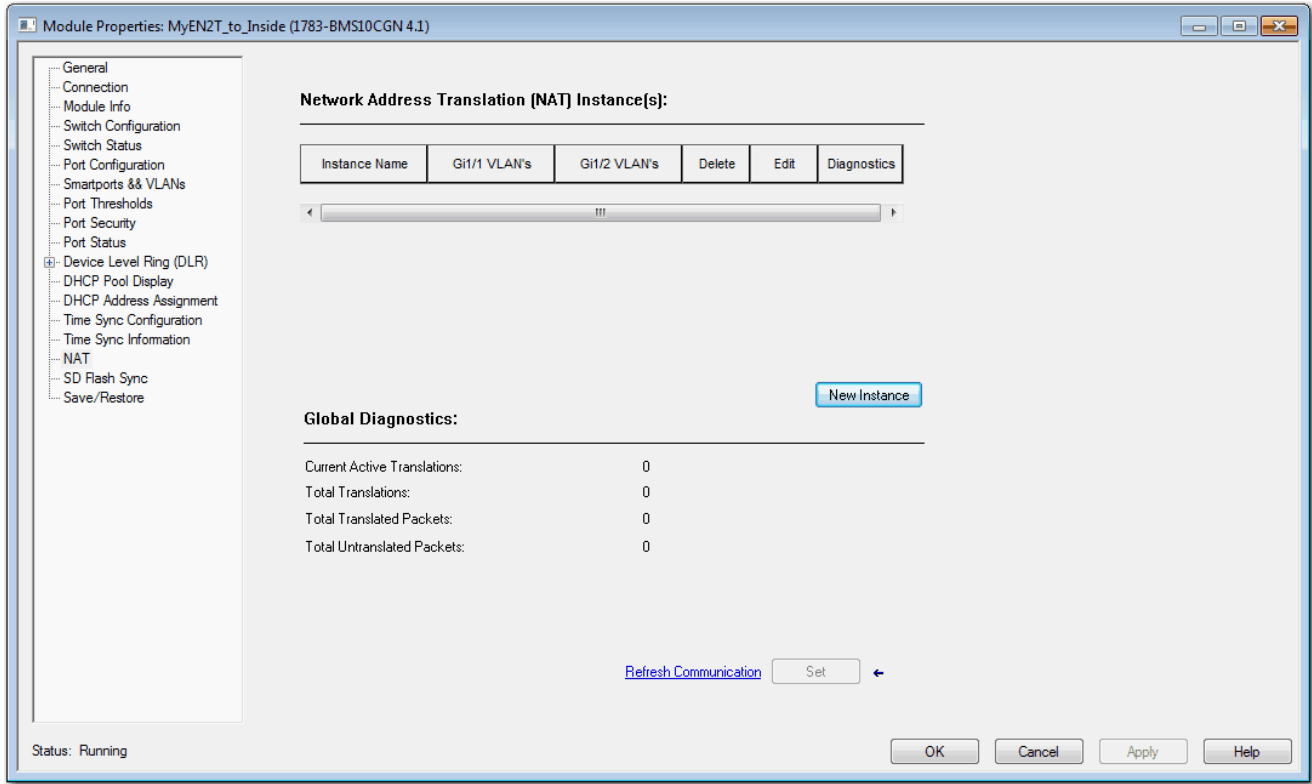

**Table 69 - NAT Fields**

Field	Description
Instance Name	Displays the unique name of the NAT instance.
Gi1/1 VLANs	Displays the VLANs assigned to each NAT instance on port Gi1/1.
Gi1/2 VLANs	Displays the VLANs assigned to each NAT instance on port Gi1/2.
Delete	Click to delete a NAT instance permanently. The switch deletes the instance when you click Set.
Edit	Click to modify the configuration of a NAT instance.
Diagnostics	Click to view translation diagnostics for an instance. See <a href="#">Monitor NAT Statistics via the Logix Designer Application on page 316</a> .
<b>Global Diagnostics</b>	
Current Active Translations	Displays the total number of translations that occurred within the last 90 seconds across all NAT instances.
Total Translations	Displays the total number of translations across all NAT instances.
Total Translated Packets	Displays the total number of translated packets across all NAT instances.
Total Untranslated Packets	Displays the total number of packets that have been bypassed across all NAT instances.

To configure NAT, follow one of these procedures that are based on your application:

- [Create NAT Instances for Traffic Routed through a Layer 3 Switch or Router](#)

For an example of this application, see [Figure 25 on page 169](#).

- [Create NAT Instances for Traffic Routed through a Layer 2 Switch](#)

For an example of this application, see [Figure 26 on page 170](#).

---

**IMPORTANT** Configure all Smartport roles and VLANs before creating NAT instances. If you change a Smartport role or the native VLAN for a port that is associated with a NAT instance, you must reassign VLANs to the NAT instance.

---



---

**IMPORTANT** As a result of Layer 2 forwarding, current traffic sessions remain established until manually disconnected. If you change an existing translation, you must manually disconnect all associated traffic sessions before the new translation can take effect.

---

### Create NAT Instances for Traffic Routed through a Layer 3 Switch or Router

1. From the NAT view, click New Instance to display the General tab.

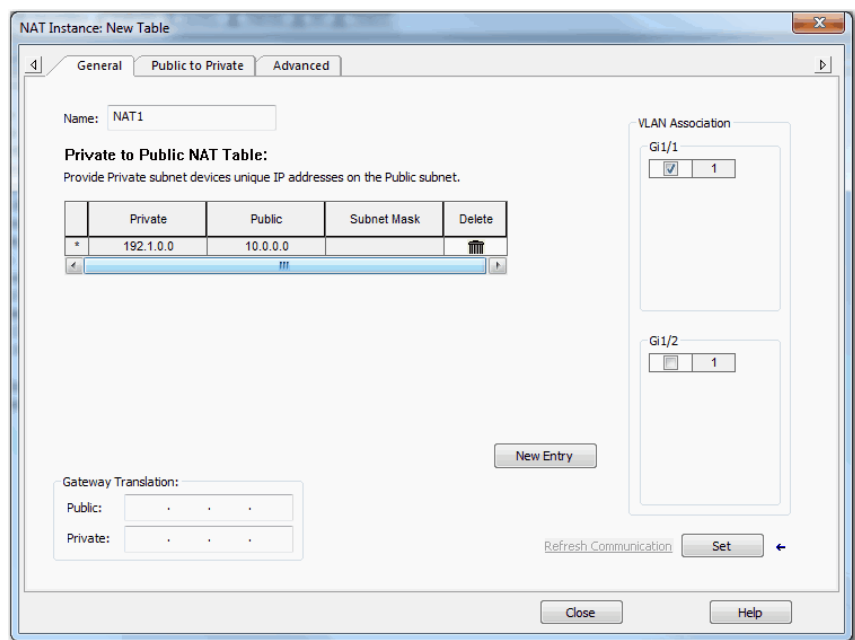

2. In the Name field, type a unique name to identify the instance.  
The instance name cannot include spaces or exceed 32 characters.
3. In the VLAN Association area, check the checkbox next to each VLAN to assign to the instance.

For more information about VLAN assignments, see [page 173](#).

4. Click New Entry to display the New Entry dialog box.

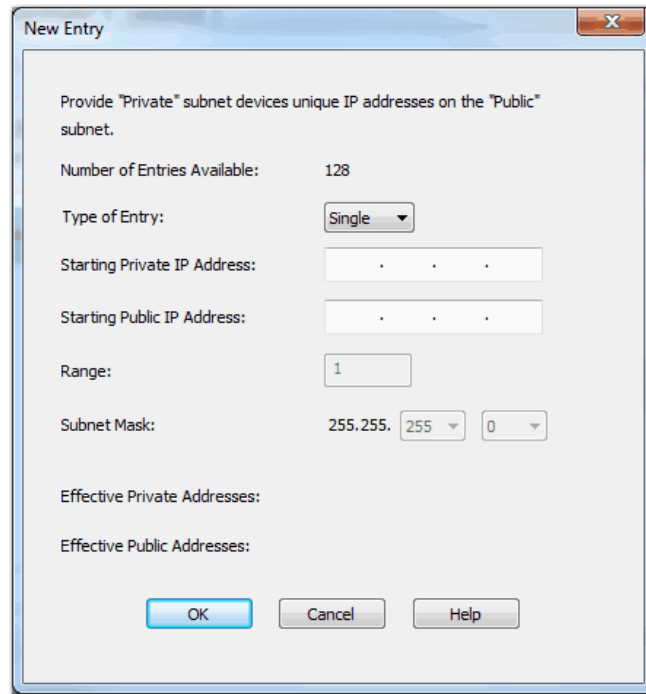

5. Do one of the following:
  - To translate one address for a device on the private subnet that communicates on the public subnet, see [Table 70](#).
  - To translate a range of addresses for devices on the private subnet that communicates on the public subnet, see [Table 71](#).
  - To translate all addresses in the private subnet or a portion of the private subnet, see [Table 72](#).

**Table 70 - Single Translation**

Field	Description
Type of Entry	Choose Single. Single is the default value.
Starting Private IP Address	Type the existing address for the device on the private subnet.
Starting Public IP Address	Type a unique public address to represent the device.
Effective Private Addresses	Displays the existing address for the device on the private subnet that is configured for translation. If blank, verify that the values in the preceding fields are valid.
Effective Public Addresses	Displays the unique public address to represent the device. If blank, verify that the values in the preceding fields are valid.

**Table 71 - Range Translation**

Field	Description
Type of Entry	Choose Range.
Starting Private IP Address	Type the existing starting address for the device on the private subnet.
Starting Public IP Address	Type a unique, starting public address to represent the device.
Range	Type the number of addresses to include in the range. Valid values: 2 . . . 128 Default value = 1 <b>IMPORTANT:</b> Each address in the range counts as one translation entry. The switch supports a maximum of 128 translation entries.
Effective Private Addresses	Displays the range of existing addresses for devices on the private subnet that are configured for translation. If blank, verify that the values in the preceding fields are valid.
Effective Public Addresses	Displays the range of unique public addresses to represent the devices. If blank, verify that the values in the preceding fields are valid.

**Table 72 - Subnet Translation**

Field	Description														
Type of Entry	Choose Subnet.														
Starting Private IP Address	Type the existing starting address for a device on the private subnet. This address must correspond to the size of the subnet mask to translate.														
	<table border="1"> <thead> <tr> <th>Subnet Mask</th> <th>Starting Private Subnet Address</th> </tr> </thead> <tbody> <tr> <td>255.255.0.0</td> <td>The last two octets must end in 0. <b>EXAMPLE:</b> 192.168.0.0</td> </tr> <tr> <td>255.255.255.0</td> <td>The last octet must end in 0. <b>EXAMPLE:</b> 192.168.1.0</td> </tr> <tr> <td>255.255.255.128</td> <td>The last octet must end in 0 or 128. <b>EXAMPLE:</b> 192.168.1.0 or 192.168.1.128</td> </tr> <tr> <td>255.255.255.192</td> <td>The last octet must end in one of the following: 0, 64, 128, 192. <b>EXAMPLE:</b> 192.168.1.64</td> </tr> <tr> <td>255.255.255.224</td> <td>The last octet must end in one of the following: 0, 32, 64, 96, 128, 160, 192, 224. <b>EXAMPLE:</b> 192.168.1.32</td> </tr> <tr> <td>255.255.255.240</td> <td>The last octet must end in one of the following: 0, 16, 32, 48, 64, 80, 96, 112, 128, 144, 160, 176, 192, 208, 224, 240. <b>EXAMPLE:</b> 192.168.1.16</td> </tr> </tbody> </table>	Subnet Mask	Starting Private Subnet Address	255.255.0.0	The last two octets must end in 0. <b>EXAMPLE:</b> 192.168.0.0	255.255.255.0	The last octet must end in 0. <b>EXAMPLE:</b> 192.168.1.0	255.255.255.128	The last octet must end in 0 or 128. <b>EXAMPLE:</b> 192.168.1.0 or 192.168.1.128	255.255.255.192	The last octet must end in one of the following: 0, 64, 128, 192. <b>EXAMPLE:</b> 192.168.1.64	255.255.255.224	The last octet must end in one of the following: 0, 32, 64, 96, 128, 160, 192, 224. <b>EXAMPLE:</b> 192.168.1.32	255.255.255.240	The last octet must end in one of the following: 0, 16, 32, 48, 64, 80, 96, 112, 128, 144, 160, 176, 192, 208, 224, 240. <b>EXAMPLE:</b> 192.168.1.16
	Subnet Mask	Starting Private Subnet Address													
	255.255.0.0	The last two octets must end in 0. <b>EXAMPLE:</b> 192.168.0.0													
	255.255.255.0	The last octet must end in 0. <b>EXAMPLE:</b> 192.168.1.0													
	255.255.255.128	The last octet must end in 0 or 128. <b>EXAMPLE:</b> 192.168.1.0 or 192.168.1.128													
	255.255.255.192	The last octet must end in one of the following: 0, 64, 128, 192. <b>EXAMPLE:</b> 192.168.1.64													
255.255.255.224	The last octet must end in one of the following: 0, 32, 64, 96, 128, 160, 192, 224. <b>EXAMPLE:</b> 192.168.1.32														
255.255.255.240	The last octet must end in one of the following: 0, 16, 32, 48, 64, 80, 96, 112, 128, 144, 160, 176, 192, 208, 224, 240. <b>EXAMPLE:</b> 192.168.1.16														
Starting Public IP Address	Type a unique, starting public address to represent the devices. This address must correspond to the size of the subnet mask to translate.														
Starting Public IP Address	<table border="1"> <thead> <tr> <th>Subnet Mask</th> <th>Starting Public Subnet Address</th> </tr> </thead> <tbody> <tr> <td>255.255.0.0</td> <td>The last two octets must end in 0. <b>EXAMPLE:</b> 10.200.0.0</td> </tr> <tr> <td>255.255.255.0</td> <td>The last octet must end in 0. <b>EXAMPLE:</b> 10.200.1.0</td> </tr> <tr> <td>255.255.255.128</td> <td>The last octet must end in 0 or 128. <b>EXAMPLE:</b> 10.200.1.0 or 10.200.1.128</td> </tr> <tr> <td>255.255.255.192</td> <td>The last octet must end in one of the following: 0, 64, 128, 192. <b>EXAMPLE:</b> 10.200.1.64</td> </tr> <tr> <td>255.255.255.224</td> <td>The last octet must end in one of the following: 0, 32, 64, 96, 128, 160, 192, 224. <b>EXAMPLE:</b> 10.200.1.32</td> </tr> </tbody> </table>	Subnet Mask	Starting Public Subnet Address	255.255.0.0	The last two octets must end in 0. <b>EXAMPLE:</b> 10.200.0.0	255.255.255.0	The last octet must end in 0. <b>EXAMPLE:</b> 10.200.1.0	255.255.255.128	The last octet must end in 0 or 128. <b>EXAMPLE:</b> 10.200.1.0 or 10.200.1.128	255.255.255.192	The last octet must end in one of the following: 0, 64, 128, 192. <b>EXAMPLE:</b> 10.200.1.64	255.255.255.224	The last octet must end in one of the following: 0, 32, 64, 96, 128, 160, 192, 224. <b>EXAMPLE:</b> 10.200.1.32		
	Subnet Mask	Starting Public Subnet Address													
	255.255.0.0	The last two octets must end in 0. <b>EXAMPLE:</b> 10.200.0.0													
	255.255.255.0	The last octet must end in 0. <b>EXAMPLE:</b> 10.200.1.0													
	255.255.255.128	The last octet must end in 0 or 128. <b>EXAMPLE:</b> 10.200.1.0 or 10.200.1.128													
	255.255.255.192	The last octet must end in one of the following: 0, 64, 128, 192. <b>EXAMPLE:</b> 10.200.1.64													
255.255.255.224	The last octet must end in one of the following: 0, 32, 64, 96, 128, 160, 192, 224. <b>EXAMPLE:</b> 10.200.1.32														
Starting Public IP Address	Type a unique, starting public address to represent the devices. This address must correspond to the size of the subnet mask to translate.														
Starting Public IP Address	<table border="1"> <thead> <tr> <th>Subnet Mask</th> <th>Starting Public Subnet Address</th> </tr> </thead> <tbody> <tr> <td>255.255.255.0</td> <td>The last octet must end in 0. <b>EXAMPLE:</b> 10.200.1.0</td> </tr> <tr> <td>255.255.255.128</td> <td>The last octet must end in 0 or 128. <b>EXAMPLE:</b> 10.200.1.0 or 10.200.1.128</td> </tr> <tr> <td>255.255.255.192</td> <td>The last octet must end in one of the following: 0, 64, 128, 192. <b>EXAMPLE:</b> 10.200.1.64</td> </tr> <tr> <td>255.255.255.224</td> <td>The last octet must end in one of the following: 0, 32, 64, 96, 128, 160, 192, 224. <b>EXAMPLE:</b> 10.200.1.32</td> </tr> </tbody> </table>	Subnet Mask	Starting Public Subnet Address	255.255.255.0	The last octet must end in 0. <b>EXAMPLE:</b> 10.200.1.0	255.255.255.128	The last octet must end in 0 or 128. <b>EXAMPLE:</b> 10.200.1.0 or 10.200.1.128	255.255.255.192	The last octet must end in one of the following: 0, 64, 128, 192. <b>EXAMPLE:</b> 10.200.1.64	255.255.255.224	The last octet must end in one of the following: 0, 32, 64, 96, 128, 160, 192, 224. <b>EXAMPLE:</b> 10.200.1.32				
	Subnet Mask	Starting Public Subnet Address													
	255.255.255.0	The last octet must end in 0. <b>EXAMPLE:</b> 10.200.1.0													
	255.255.255.128	The last octet must end in 0 or 128. <b>EXAMPLE:</b> 10.200.1.0 or 10.200.1.128													
	255.255.255.192	The last octet must end in one of the following: 0, 64, 128, 192. <b>EXAMPLE:</b> 10.200.1.64													
255.255.255.224	The last octet must end in one of the following: 0, 32, 64, 96, 128, 160, 192, 224. <b>EXAMPLE:</b> 10.200.1.32														
Starting Public IP Address	Type a unique, starting public address to represent the devices. This address must correspond to the size of the subnet mask to translate.														
Starting Public IP Address	<table border="1"> <thead> <tr> <th>Subnet Mask</th> <th>Starting Public Subnet Address</th> </tr> </thead> <tbody> <tr> <td>255.255.255.240</td> <td>The last octet must end in one of the following: 0, 16, 32, 48, 64, 80, 96, 112, 128, 144, 160, 176, 192, 208, 224, 240. <b>EXAMPLE:</b> 10.200.1.16</td> </tr> </tbody> </table>	Subnet Mask	Starting Public Subnet Address	255.255.255.240	The last octet must end in one of the following: 0, 16, 32, 48, 64, 80, 96, 112, 128, 144, 160, 176, 192, 208, 224, 240. <b>EXAMPLE:</b> 10.200.1.16										
	Subnet Mask	Starting Public Subnet Address													
	255.255.255.240	The last octet must end in one of the following: 0, 16, 32, 48, 64, 80, 96, 112, 128, 144, 160, 176, 192, 208, 224, 240. <b>EXAMPLE:</b> 10.200.1.16													

**Table 72 - Subnet Translation (Continued)**

Field	Description
Subnet Mask	Choose the subnet mask for the addresses to translate. Valid values: <ul style="list-style-type: none"> <li>• Class B: 255.255.0.0</li> <li>• Class C: 255.255.255.0</li> <li>• Portion of Class C: <ul style="list-style-type: none"> <li>– 255.255.255.128 (provides 128 addresses per translation entry)</li> <li>– 255.255.255.192 (provides 64 addresses per translation entry)</li> <li>– 255.255.255.224 (provides 32 addresses per translation entry)</li> <li>– 255.255.255.240 (provides 16 addresses per translation entry)</li> </ul> </li> </ul>
Effective Private Addresses	Displays the range of existing addresses for devices on the private subnet that are configured for translation. If blank, verify that the values in the preceding fields are valid.
Effective Public Addresses	Displays the range of unique public addresses to represent the devices. If blank, verify that the values in the preceding fields are valid.

6. Click OK.
7. Complete the Gateway Translation fields to enable devices on the public subnet to communicate with devices on the private subnet:
  - Public—Type the default gateway address of the Layer 3 switch or router that is connected to the uplink port of the switch.
  - Private—Type a unique IP address to represent the Layer 3 switch or router on the private network.
8. To configure traffic permits and packet fixups, see [Configure Traffic Permits and Fixups on page 186](#).
9. Click Set.

### Create NAT Instances for Traffic Routed through a Layer 2 Switch

1. From the NAT view, click New Instance to display the General tab.

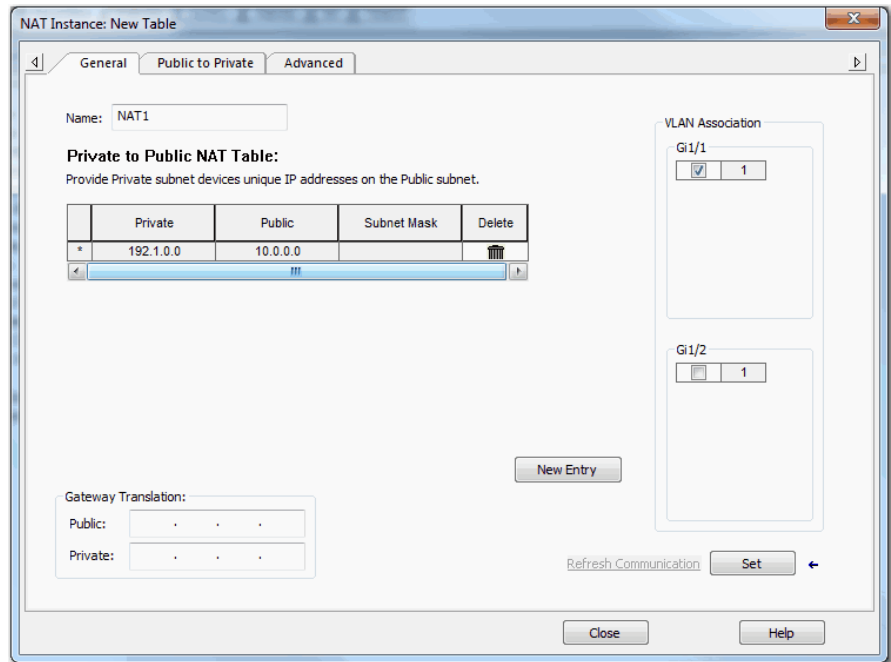

2. In the Name field, type a unique name to identify the instance.  
The instance name cannot include spaces or exceed 32 characters.
3. In the VLAN Association area, check the checkbox next to each VLAN to assign to the instance.  
For more information about VLAN assignments, see [page 173](#).
4. Click New Entry to display the New Entry dialog box.

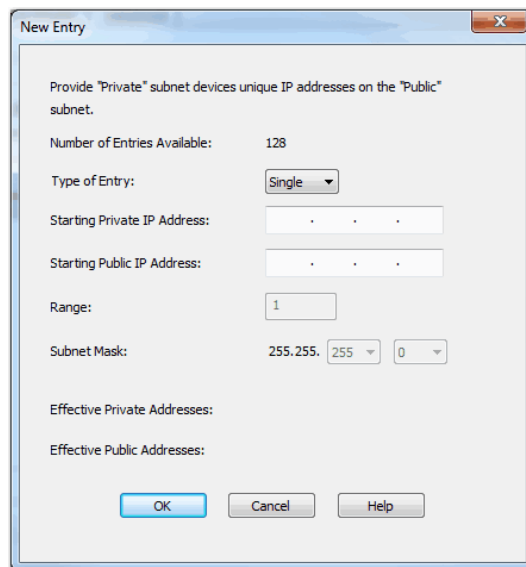

5. Do one of the following:



- To translate one address for a device on the private subnet that communicates on the public subnet, see [Table 73](#).
- To translate a range of addresses for devices on the private subnet that communicates on the public subnet, see [Table 74](#)
- To translate all addresses in the private subnet or a portion of the private subnet, see [Table 75](#).

**Table 73 - Single Translation**

Field	Description
Type of Entry	Choose Single. Single is the default value.
Starting Private IP Address	Type the existing address for the device on the private subnet.
Starting Public IP Address	Type a unique public address to represent the device.
Effective Private Addresses	Displays the existing address for the device on the private subnet that is configured for translation. If blank, verify that the values in the preceding fields are valid.
Effective Public Addresses	Displays the unique public address to represent the device. If blank, verify that the values in the preceding fields are valid.

**Table 74 - Range Translation**

Field	Description
Type of Entry	Choose Range.
Starting Private IP Address	Type the existing starting address for the device on the private subnet.
Starting Public IP Address	Type a unique, starting public address to represent the devices.
Range	Type the number of addresses to include in the range. Valid values: 2 . . 128 Default value = 1 <b>IMPORTANT:</b> Each address in the range counts as one translation entry. The switch supports a maximum of 128 translation entries.
Effective Private Addresses	Displays the range of existing addresses for devices on the private subnet that are configured for translation. If blank, verify that the values in the preceding fields are valid.
Effective Public Addresses	Displays the range of unique public addresses to represent the devices. If blank, verify that the values in the preceding fields are valid.

**Table 75 - Subnet Translation**

Field	Description														
Type of Entry	Choose Subnet.														
Starting Private IP Address	Type the existing starting address for a device on the private subnet. This address must correspond to the size of the subnet mask to translate.														
	<table border="1"> <thead> <tr> <th>Subnet Mask</th> <th>Starting Private Subnet Address</th> </tr> </thead> <tbody> <tr> <td>255.255.0.0</td> <td>The last two octets must end in 0. <b>EXAMPLE:</b> 192.168.0.0</td> </tr> <tr> <td>255.255.255.0</td> <td>The last octet must end in 0. <b>EXAMPLE:</b> 192.168.1.0</td> </tr> <tr> <td>255.255.255.128</td> <td>The last octet must end in 0 or 128. <b>EXAMPLE:</b> 192.168.1.0 or 192.168.1.128</td> </tr> <tr> <td>255.255.255.192</td> <td>The last octet must end in one of the following: 0, 64, 128, 192. <b>EXAMPLE:</b> 192.168.1.64</td> </tr> <tr> <td>255.255.255.224</td> <td>The last octet must end in one of the following: 0, 32, 64, 96, 128, 160, 192, 224. <b>EXAMPLE:</b> 192.168.1.32</td> </tr> <tr> <td>255.255.255.240</td> <td>The last octet must end in one of the following: 0, 16, 32, 48, 64, 80, 96, 112, 128, 144, 160, 176, 192, 208, 224, 240. <b>EXAMPLE:</b> 192.168.1.16</td> </tr> </tbody> </table>	Subnet Mask	Starting Private Subnet Address	255.255.0.0	The last two octets must end in 0. <b>EXAMPLE:</b> 192.168.0.0	255.255.255.0	The last octet must end in 0. <b>EXAMPLE:</b> 192.168.1.0	255.255.255.128	The last octet must end in 0 or 128. <b>EXAMPLE:</b> 192.168.1.0 or 192.168.1.128	255.255.255.192	The last octet must end in one of the following: 0, 64, 128, 192. <b>EXAMPLE:</b> 192.168.1.64	255.255.255.224	The last octet must end in one of the following: 0, 32, 64, 96, 128, 160, 192, 224. <b>EXAMPLE:</b> 192.168.1.32	255.255.255.240	The last octet must end in one of the following: 0, 16, 32, 48, 64, 80, 96, 112, 128, 144, 160, 176, 192, 208, 224, 240. <b>EXAMPLE:</b> 192.168.1.16
	Subnet Mask	Starting Private Subnet Address													
	255.255.0.0	The last two octets must end in 0. <b>EXAMPLE:</b> 192.168.0.0													
	255.255.255.0	The last octet must end in 0. <b>EXAMPLE:</b> 192.168.1.0													
	255.255.255.128	The last octet must end in 0 or 128. <b>EXAMPLE:</b> 192.168.1.0 or 192.168.1.128													
	255.255.255.192	The last octet must end in one of the following: 0, 64, 128, 192. <b>EXAMPLE:</b> 192.168.1.64													
	255.255.255.224	The last octet must end in one of the following: 0, 32, 64, 96, 128, 160, 192, 224. <b>EXAMPLE:</b> 192.168.1.32													
255.255.255.240	The last octet must end in one of the following: 0, 16, 32, 48, 64, 80, 96, 112, 128, 144, 160, 176, 192, 208, 224, 240. <b>EXAMPLE:</b> 192.168.1.16														
255.255.0.0	The last two octets must end in 0. <b>EXAMPLE:</b> 192.168.0.0														
255.255.255.0	The last octet must end in 0. <b>EXAMPLE:</b> 192.168.1.0														
255.255.255.128	The last octet must end in 0 or 128. <b>EXAMPLE:</b> 192.168.1.0 or 192.168.1.128														
255.255.255.192	The last octet must end in one of the following: 0, 64, 128, 192. <b>EXAMPLE:</b> 192.168.1.64														
255.255.255.224	The last octet must end in one of the following: 0, 32, 64, 96, 128, 160, 192, 224. <b>EXAMPLE:</b> 192.168.1.32														
255.255.255.240	The last octet must end in one of the following: 0, 16, 32, 48, 64, 80, 96, 112, 128, 144, 160, 176, 192, 208, 224, 240. <b>EXAMPLE:</b> 192.168.1.16														
Starting Public IP Address	Type a unique, starting public address to represent the devices. This address must correspond to the size of the subnet mask to translate.														
	<table border="1"> <thead> <tr> <th>Subnet Mask</th> <th>Starting Public Subnet Address</th> </tr> </thead> <tbody> <tr> <td>255.255.0.0</td> <td>The last two octets must end in 0. <b>EXAMPLE:</b> 10.200.0.0</td> </tr> <tr> <td>255.255.255.0</td> <td>The last octet must end in 0. <b>EXAMPLE:</b> 10.200.1.0</td> </tr> <tr> <td>255.255.255.128</td> <td>The last octet must end in 0 or 128. <b>EXAMPLE:</b> 10.200.1.0 or 10.200.1.128</td> </tr> <tr> <td>255.255.255.192</td> <td>The last octet must end in one of the following: 0, 64, 128, 192. <b>EXAMPLE:</b> 10.200.1.64</td> </tr> <tr> <td>255.255.255.224</td> <td>The last octet must end in one of the following: 0, 32, 64, 96, 128, 160, 192, 224. <b>EXAMPLE:</b> 10.200.1.32</td> </tr> <tr> <td>255.255.255.240</td> <td>The last octet must end in one of the following: 0, 16, 32, 48, 64, 80, 96, 112, 128, 144, 160, 176, 192, 208, 224, 240. <b>EXAMPLE:</b> 10.200.1.16</td> </tr> </tbody> </table>	Subnet Mask	Starting Public Subnet Address	255.255.0.0	The last two octets must end in 0. <b>EXAMPLE:</b> 10.200.0.0	255.255.255.0	The last octet must end in 0. <b>EXAMPLE:</b> 10.200.1.0	255.255.255.128	The last octet must end in 0 or 128. <b>EXAMPLE:</b> 10.200.1.0 or 10.200.1.128	255.255.255.192	The last octet must end in one of the following: 0, 64, 128, 192. <b>EXAMPLE:</b> 10.200.1.64	255.255.255.224	The last octet must end in one of the following: 0, 32, 64, 96, 128, 160, 192, 224. <b>EXAMPLE:</b> 10.200.1.32	255.255.255.240	The last octet must end in one of the following: 0, 16, 32, 48, 64, 80, 96, 112, 128, 144, 160, 176, 192, 208, 224, 240. <b>EXAMPLE:</b> 10.200.1.16
	Subnet Mask	Starting Public Subnet Address													
	255.255.0.0	The last two octets must end in 0. <b>EXAMPLE:</b> 10.200.0.0													
	255.255.255.0	The last octet must end in 0. <b>EXAMPLE:</b> 10.200.1.0													
	255.255.255.128	The last octet must end in 0 or 128. <b>EXAMPLE:</b> 10.200.1.0 or 10.200.1.128													
	255.255.255.192	The last octet must end in one of the following: 0, 64, 128, 192. <b>EXAMPLE:</b> 10.200.1.64													
	255.255.255.224	The last octet must end in one of the following: 0, 32, 64, 96, 128, 160, 192, 224. <b>EXAMPLE:</b> 10.200.1.32													
255.255.255.240	The last octet must end in one of the following: 0, 16, 32, 48, 64, 80, 96, 112, 128, 144, 160, 176, 192, 208, 224, 240. <b>EXAMPLE:</b> 10.200.1.16														
255.255.0.0	The last two octets must end in 0. <b>EXAMPLE:</b> 10.200.0.0														
255.255.255.0	The last octet must end in 0. <b>EXAMPLE:</b> 10.200.1.0														
255.255.255.128	The last octet must end in 0 or 128. <b>EXAMPLE:</b> 10.200.1.0 or 10.200.1.128														
255.255.255.192	The last octet must end in one of the following: 0, 64, 128, 192. <b>EXAMPLE:</b> 10.200.1.64														
255.255.255.224	The last octet must end in one of the following: 0, 32, 64, 96, 128, 160, 192, 224. <b>EXAMPLE:</b> 10.200.1.32														
255.255.255.240	The last octet must end in one of the following: 0, 16, 32, 48, 64, 80, 96, 112, 128, 144, 160, 176, 192, 208, 224, 240. <b>EXAMPLE:</b> 10.200.1.16														
Subnet Mask	Choose the subnet mask for the addresses to translate. Valid values: <ul style="list-style-type: none"> <li>• Class B: 255.255.0.0</li> <li>• Class C: 255.255.255.0</li> <li>• Portion of Class C: <ul style="list-style-type: none"> <li>– 255.255.255.128 (provides 128 addresses per translation entry)</li> <li>– 255.255.255.192 (provides 64 addresses per translation entry)</li> <li>– 255.255.255.224 (provides 32 addresses per translation entry)</li> <li>– 255.255.255.240 (provides 16 addresses per translation entry)</li> </ul> </li> </ul>														
Effective Private Addresses	Displays the range of existing addresses for devices on the private subnet that are configured for translation. If blank, verify that the values in the preceding fields are valid.														
Effective Public Addresses	Displays the range of unique public addresses to represent the devices. If blank, verify that the values in the preceding fields are valid.														

6. Click OK.
7. Click the Public to Private tab.

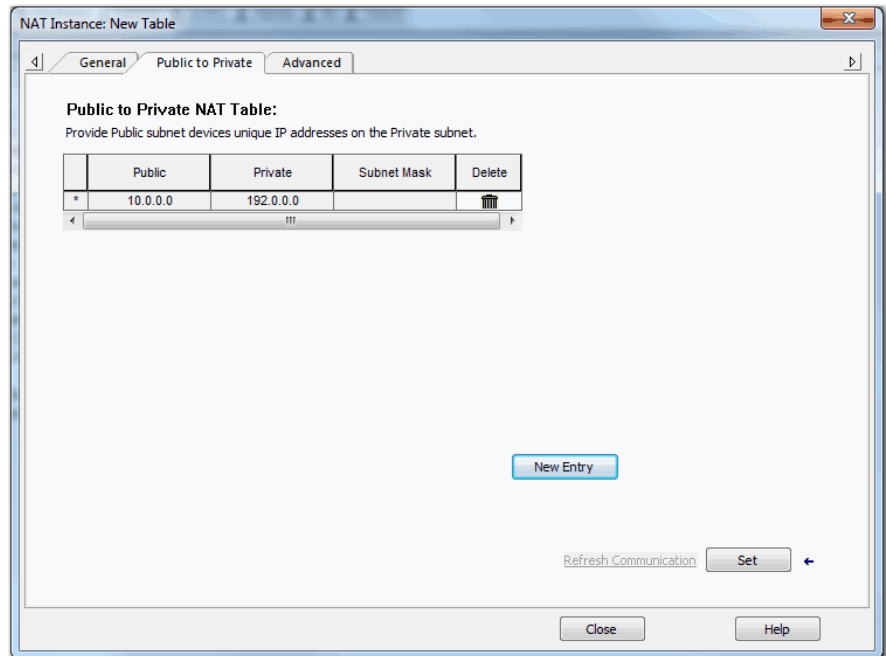

8. Click New Entry to display the New Entry dialog box.

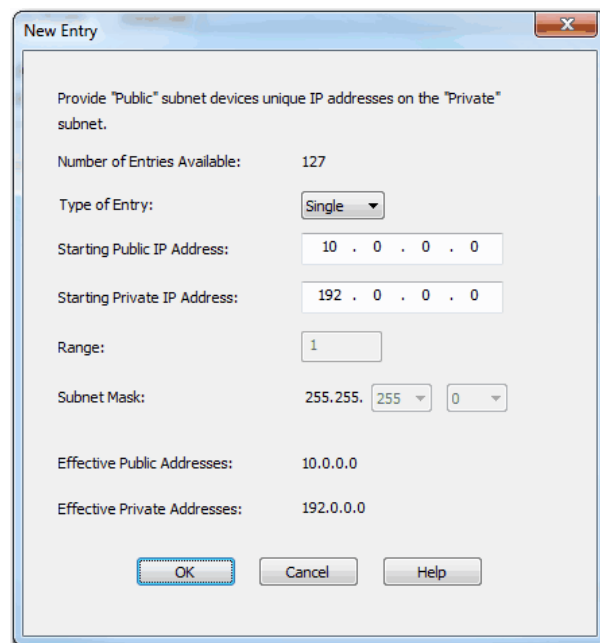

9. Do one of the following:
  - To translate one address for a device on the public subnet that communicates on the private subnet, see [Table 76](#).
  - To translate a range of addresses for devices on the public subnet that communicates on the private subnet, see [Table 77](#).
  - To translate a range of addresses for devices on the public subnet that communicates on the private subnet, see [Table 78](#).

**Table 76 - Single Translation**

Field	Description
Type of Entry	Choose Single. Single is the default value.
Starting Public IP Address	Type the existing address for the device on the public subnet.
Starting Private IP Address	Type a unique private address to represent the device.
Effective Public Addresses	Displays the existing address for the device on the public subnet that is configured for translation. If blank, verify that the values in the preceding fields are valid.
Effective Private Addresses	Displays the unique private address to represent the device. If blank, verify that the values in the preceding fields are valid.

**Table 77 - Range Translation**

Field	Description
Type of Entry	Choose Range.
Starting Public IP Address	Type the existing starting address for the device on the public subnet.
Starting Private IP Address	Type a unique, starting private address to represent the devices.
Range	Type the number of addresses to include in the range. Valid values: 2 . . 128 Default value = 1 <b>IMPORTANT:</b> Each address in the range counts as one translation entry. The switch supports a maximum of 128 translation entries.
Effective Public Addresses	Displays the range of existing addresses for devices on the public subnet that are configured for translation. If blank, verify that the values in the preceding fields are valid.
Effective Private Addresses	Displays the range of unique private addresses to represent the devices. If blank, verify that the values in the preceding fields are valid.

**Table 78 - Subnet Translation**

Field	Description	
Type of Entry	Choose Subnet.	
Starting Public IP Address	Type the existing starting address for a device on the public subnet. This address must correspond to the size of the subnet mask to translate.	
	<b>Subnet Mask</b>	<b>Starting Public Subnet Address</b>
	255.255.0.0	The last two octets must end in 0. <b>EXAMPLE:</b> 10.200.0.0
	255.255.255.0	The last octet must end in 0. <b>EXAMPLE:</b> 10.200.1.0
	255.255.255.128	The last octet must end in 0 or 128. <b>EXAMPLE:</b> 10.200.1.0 or 10.200.1.128
	255.255.255.192	The last octet must end in one of the following: 0, 64, 128, 192. <b>EXAMPLE:</b> 10.200.1.64
	255.255.255.224	The last octet must end in one of the following: 0, 32, 64, 96, 128, 160, 192, 224. <b>EXAMPLE:</b> 10.200.1.32
255.255.255.240	The last octet must end in one of the following: 0, 16, 32, 48, 64, 80, 96, 112, 128, 144, 160, 176, 192, 208, 224, 240. <b>EXAMPLE:</b> 10.200.1.16	

**Table 78 - Subnet Translation (Continued)**

Field	Description														
Starting Private IP Address	Type a unique, starting private address to represent the devices. This address must correspond to the size of the subnet mask to translate.														
	<table border="1"> <thead> <tr> <th>Subnet Mask</th> <th>Starting Private Subnet Address</th> </tr> </thead> <tbody> <tr> <td>255.255.0.0</td> <td>The last two octets must end in 0. <b>EXAMPLE:</b> 192.168.0.0</td> </tr> <tr> <td>255.255.255.0</td> <td>The last octet must end in 0. <b>EXAMPLE:</b> 192.168.1.0</td> </tr> <tr> <td>255.255.255.128</td> <td>The last octet must end in 0 or 128. <b>EXAMPLE:</b> 192.168.1.0 or 192.168.1.128</td> </tr> <tr> <td>255.255.255.192</td> <td>The last octet must end in one of the following: 0, 64, 128, 192. <b>EXAMPLE:</b> 192.168.1.64</td> </tr> <tr> <td>255.255.255.224</td> <td>The last octet must end in one of the following: 0, 32, 64, 96, 128, 160, 192, 224. <b>EXAMPLE:</b> 192.168.1.32</td> </tr> <tr> <td>255.255.255.240</td> <td>The last octet must end in one of the following: 0, 16, 32, 48, 64, 80, 96, 112, 128, 144, 160, 176, 192, 208, 224, 240. <b>EXAMPLE:</b> 192.168.1.16</td> </tr> </tbody> </table>	Subnet Mask	Starting Private Subnet Address	255.255.0.0	The last two octets must end in 0. <b>EXAMPLE:</b> 192.168.0.0	255.255.255.0	The last octet must end in 0. <b>EXAMPLE:</b> 192.168.1.0	255.255.255.128	The last octet must end in 0 or 128. <b>EXAMPLE:</b> 192.168.1.0 or 192.168.1.128	255.255.255.192	The last octet must end in one of the following: 0, 64, 128, 192. <b>EXAMPLE:</b> 192.168.1.64	255.255.255.224	The last octet must end in one of the following: 0, 32, 64, 96, 128, 160, 192, 224. <b>EXAMPLE:</b> 192.168.1.32	255.255.255.240	The last octet must end in one of the following: 0, 16, 32, 48, 64, 80, 96, 112, 128, 144, 160, 176, 192, 208, 224, 240. <b>EXAMPLE:</b> 192.168.1.16
	Subnet Mask	Starting Private Subnet Address													
	255.255.0.0	The last two octets must end in 0. <b>EXAMPLE:</b> 192.168.0.0													
	255.255.255.0	The last octet must end in 0. <b>EXAMPLE:</b> 192.168.1.0													
	255.255.255.128	The last octet must end in 0 or 128. <b>EXAMPLE:</b> 192.168.1.0 or 192.168.1.128													
	255.255.255.192	The last octet must end in one of the following: 0, 64, 128, 192. <b>EXAMPLE:</b> 192.168.1.64													
	255.255.255.224	The last octet must end in one of the following: 0, 32, 64, 96, 128, 160, 192, 224. <b>EXAMPLE:</b> 192.168.1.32													
255.255.255.240	The last octet must end in one of the following: 0, 16, 32, 48, 64, 80, 96, 112, 128, 144, 160, 176, 192, 208, 224, 240. <b>EXAMPLE:</b> 192.168.1.16														
255.255.0.0	The last two octets must end in 0. <b>EXAMPLE:</b> 192.168.0.0														
255.255.255.0	The last octet must end in 0. <b>EXAMPLE:</b> 192.168.1.0														
255.255.255.128	The last octet must end in 0 or 128. <b>EXAMPLE:</b> 192.168.1.0 or 192.168.1.128														
255.255.255.192	The last octet must end in one of the following: 0, 64, 128, 192. <b>EXAMPLE:</b> 192.168.1.64														
255.255.255.224	The last octet must end in one of the following: 0, 32, 64, 96, 128, 160, 192, 224. <b>EXAMPLE:</b> 192.168.1.32														
255.255.255.240	The last octet must end in one of the following: 0, 16, 32, 48, 64, 80, 96, 112, 128, 144, 160, 176, 192, 208, 224, 240. <b>EXAMPLE:</b> 192.168.1.16														
Subnet Mask	Choose the subnet mask for the addresses to translate. Valid values: <ul style="list-style-type: none"> <li>• Class B: 255.255.0.0</li> <li>• Class C: 255.255.255.0</li> <li>• Portion of Class C: <ul style="list-style-type: none"> <li>– 255.255.255.128 (provides 128 addresses per translation entry)</li> <li>– 255.255.255.192 (provides 64 addresses per translation entry)</li> <li>– 255.255.255.224 (provides 32 addresses per translation entry)</li> <li>– 255.255.255.240 (provides 16 addresses per translation entry)</li> </ul> </li> </ul>														
Effective Public Addresses	Displays the range of existing addresses for devices on the public subnet that are configured for translation. If blank, verify that the values in the preceding fields are valid.														
Effective Private Addresses	Displays the range of unique private addresses to represent the devices. If blank, verify that the values in the preceding fields are valid.														

10. Click OK.

11. (Optional). To configure traffic permits and packet fixups, see [Configure Traffic Permits and Fixups on page 186](#).

12. Click Set.

### Configure Traffic Permits and Fixups

Use caution when you configure traffic permits and fixups. We recommend that you use the default values.

1. Click the Advanced tab.

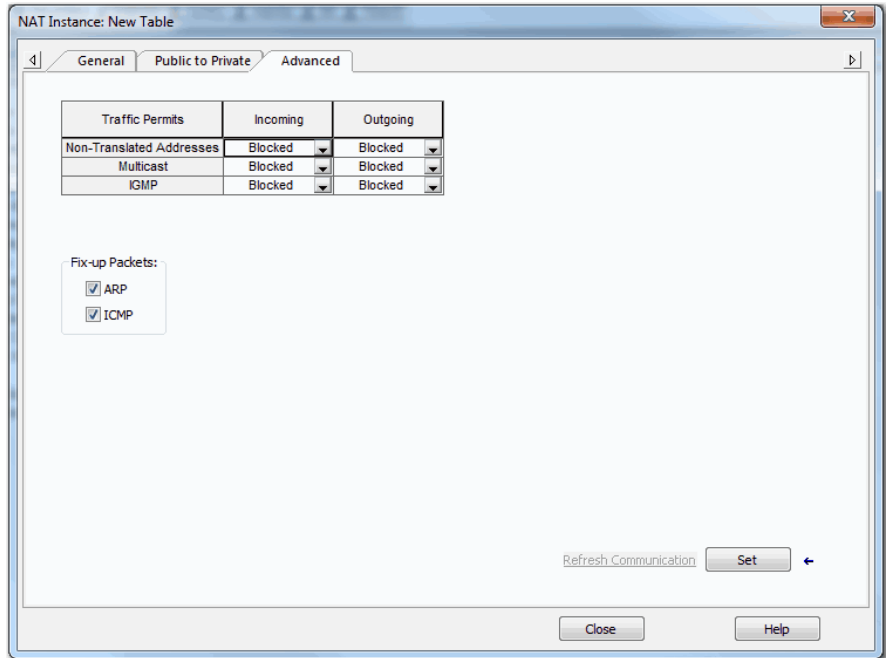

2. In the Traffic Permits table, choose one of these options for unsupported incoming and outgoing packets:
  - Pass-Through—Permit the packets to pass across the NAT boundary.
  - Blocked—Drop the packets.
3. In the Fix-up Packets area, check or clear the checkboxes to enable or disable protocol fixups for ARP and ICMP.

By default, fixups are enabled for both ARP and ICMP.

## Configure NAT via the Logix Designer Application (Stratix 5410 Switches)

In the navigation pane, click NAT.

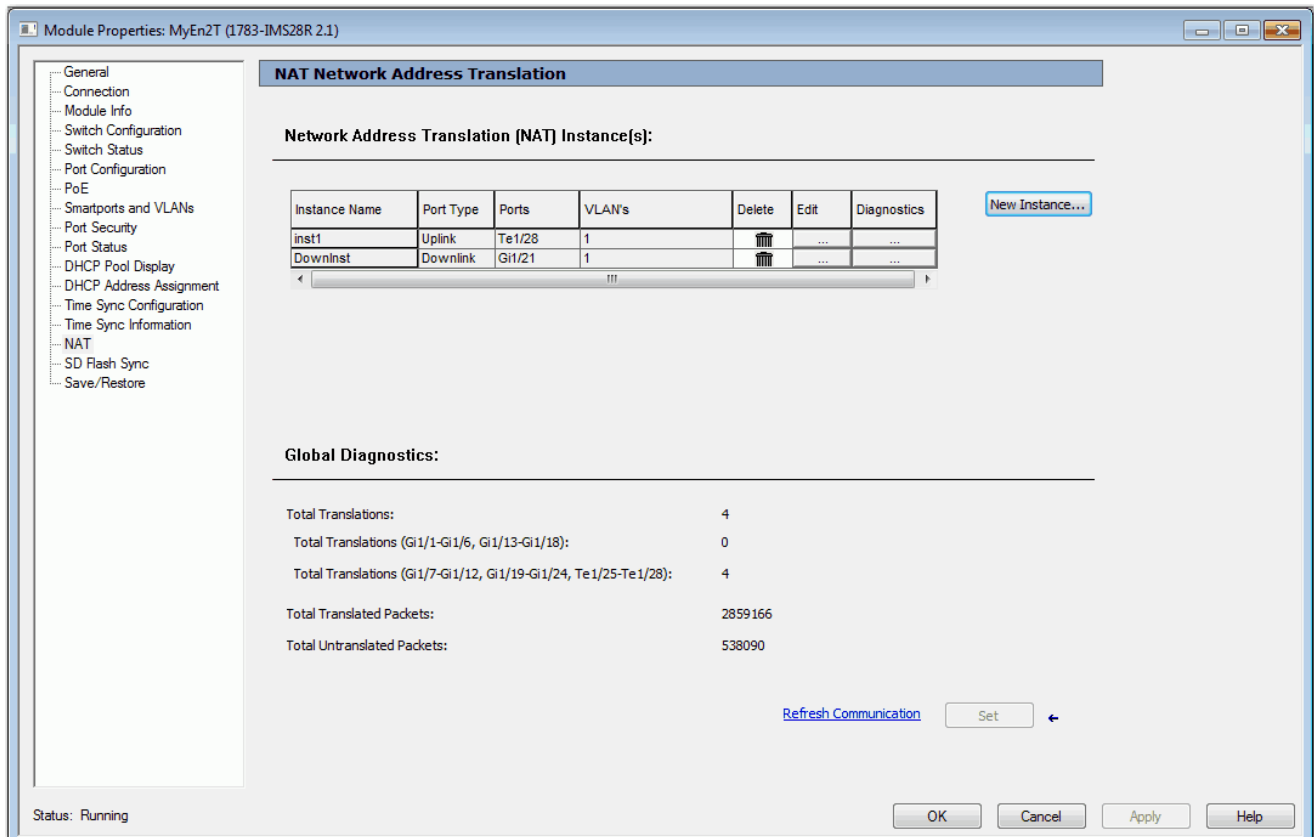

**Table 79 - NAT Fields**

Field	Description
Instance Name	Displays the unique name of the NAT instance.
Port Type	Identifies the port type as either uplink or downlink: <ul style="list-style-type: none"> <li>• Ports 1...24 are downlink ports.</li> <li>• Ports 25...28 are uplink ports.</li> </ul>
Ports	Identifies the port numbers that are assigned to each NAT instance.
VLANs	Displays the VLANs assigned to each NAT instance on port listed in the Port column.
Delete	Click to delete a NAT instance permanently. The switch deletes the instance when you click Set.
Edit	Click to modify the configuration of a NAT instance.
Diagnostics	Click to view translation diagnostics for an instance. See <a href="#">Monitor NAT Statistics via the Logix Designer Application on page 316</a> .
<b>Global Diagnostics</b>	
Total Translations	Displays the total number of translations across all NAT instances.
Total Translations (Gi1/1-Gi1/6, Gi1/13-Gi1/18)	Displays the total number of translations across port ranges Gi1/1...Gi1/6 and Gi1/13...Gi1/18. These ranges can include a combined maximum of 128 translations.
Total Translations (Gi1/7-Gi1/12, Gi1/19-Gi1/24, Te1/25-Te1/28)	Displays the total number of translations across port ranges Gi1/7...Gi1/12, Gi1/19...Gi1/24 and Te1/25...Te1/28. These ranges can include a combined maximum of 128 translations.
Total Translated Packets	Displays the total number of translated packets across all NAT instances.
Total Untranslated Packets	Displays the total number of packets that have passed through all NAT instances without being translated.

To create a NAT instance, follow these steps.

**IMPORTANT** Configure all Smartport roles and VLANs before creating NAT instances. If you change a Smartport role or the native VLAN for a port that is associated with a NAT instance, you must reassign VLANs to the NAT instance.

**IMPORTANT** As a result of Layer 2 forwarding, current traffic sessions remain established until manually disconnected. If you change an existing translation, you must manually disconnect all associated traffic sessions before the new translation can take effect.

1. From the NAT view, click New Instance to display the Ports view.

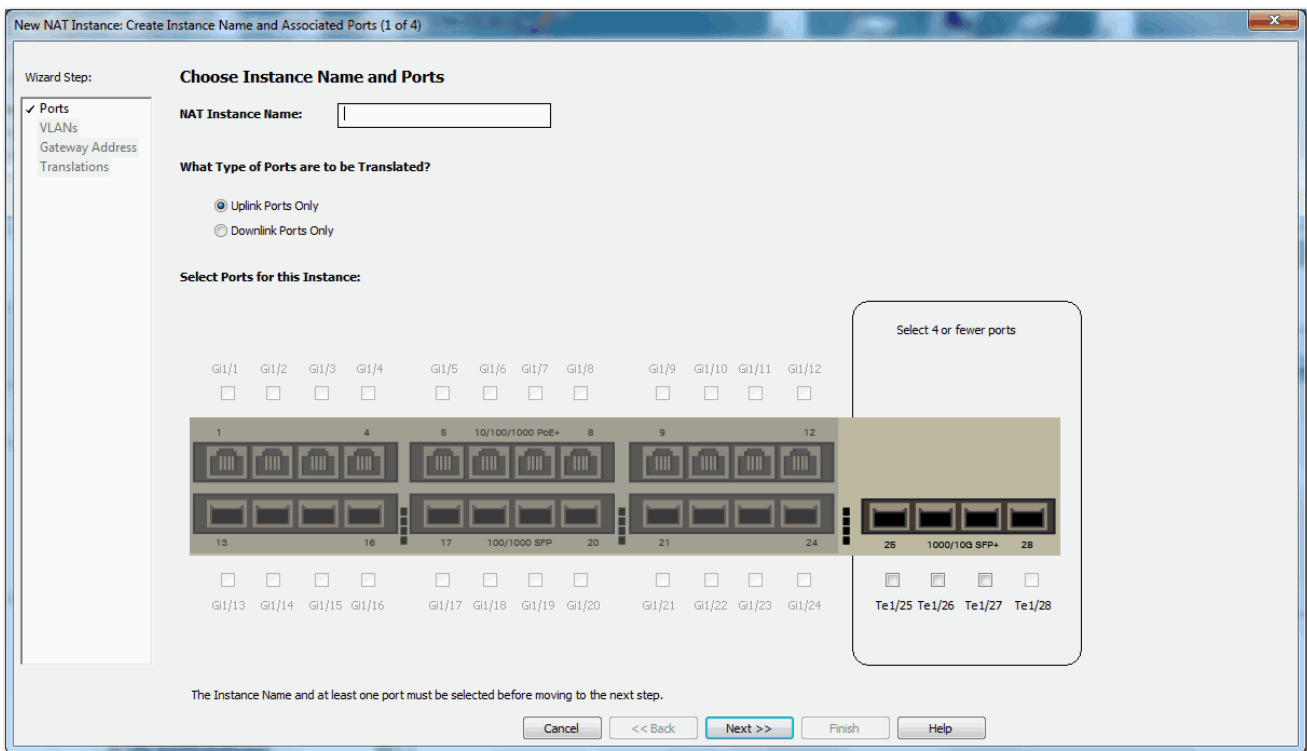



2. Configure the ports to assign to the instance.
  - a. In the NAT Instance Name field, type a unique name to identify the instance.
  - b. Click the type of ports to assign to the NAT instance:
    - Uplink Ports Only (Te1/25...Te1/28)
    - (Default) Downlink Ports Only (Gi1/1...Gi1/24)
  - c. Select the ports to assign to the NAT instance.

Port Type	Valid Port Ranges
Downlink	Select as many as eight downlink ports. Select four or fewer ports from these ranges: <ul style="list-style-type: none"> <li>• Gi1/1...Gi1/6</li> <li>• Gi1/13...Gi1/18</li> </ul> Select four or fewer ports from these ranges: <ul style="list-style-type: none"> <li>• Gi1/7...Gi1/12</li> <li>• Gi1/19...Gi1/24</li> </ul>
<b>or</b>	
Uplink	Select four or fewer ports from this range: Te1/25...Te1/28

3. Click Next to display the VLANs view.

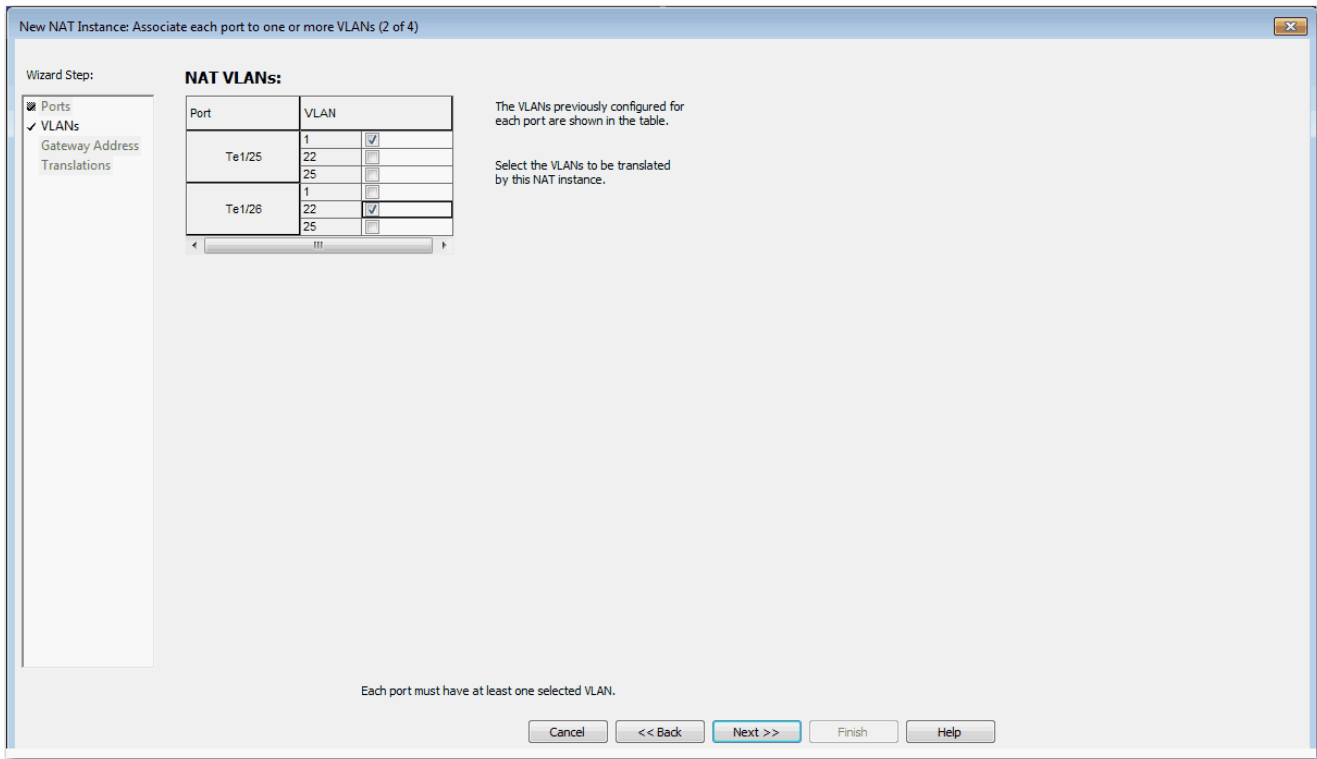

4. For each port, select one or more VLANs to assign to the NAT instance.

The VLANs available for selection are VLANs previously assigned to the port. You can select the same VLAN for multiple ports. VLANs assigned to another NAT instance are unavailable for selection.

5. Click Next to display the Gateway Address view.

If you assigned only one VLAN to the NAT instance and use a Layer 3 gateway, specify the following addresses:

- Public Gateway Address—Type the default gateway address of the Layer 3 switch or router for this subnet.
- Private Gateway Translation Address—Type a unique IP address to represent the Layer 3 switch or router on the private network.

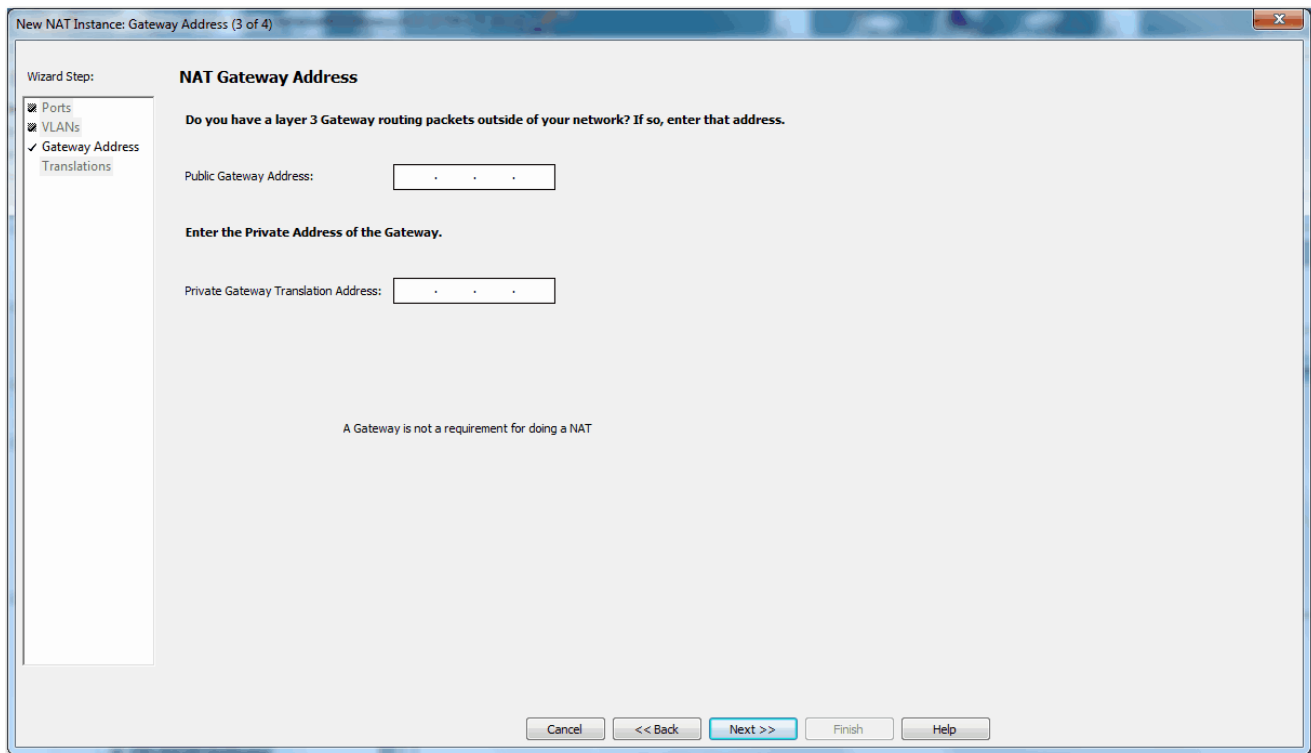

If you assigned multiple VLANs to the NAT instance, no gateway configuration is necessary.

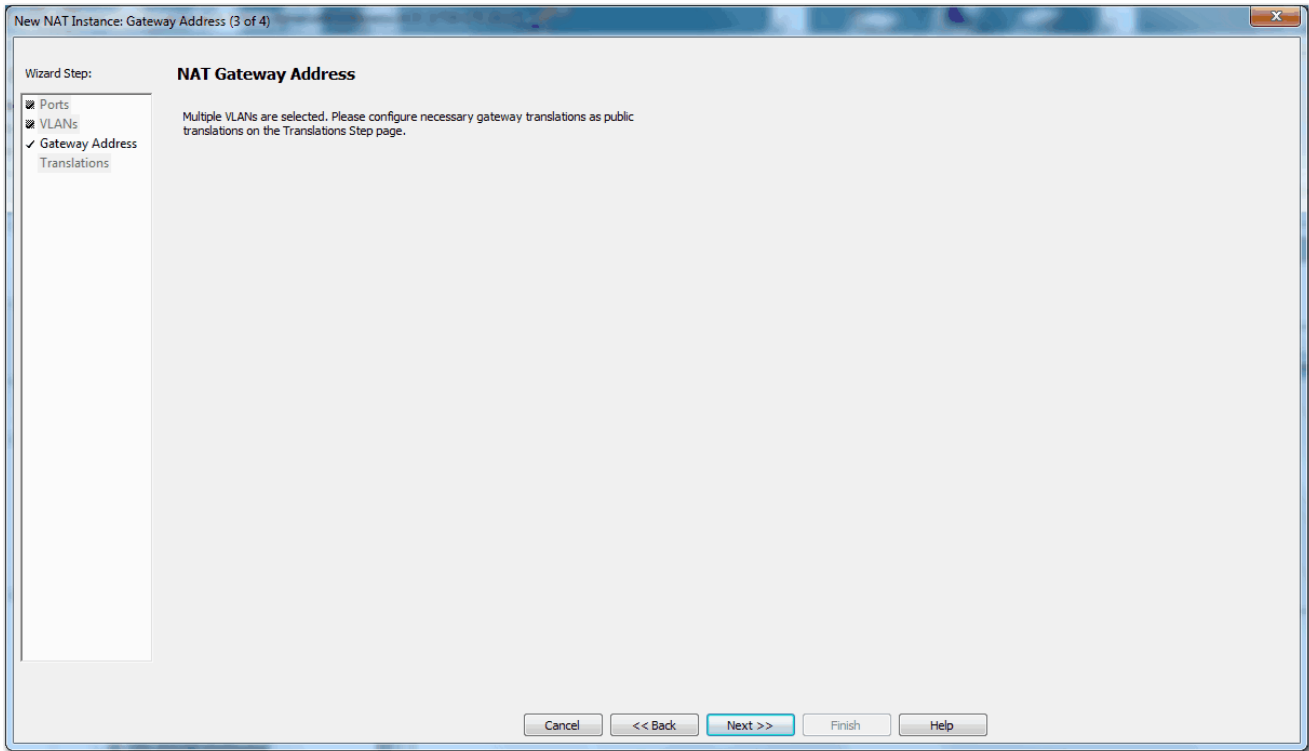

6. Click Next to display the Translations view.

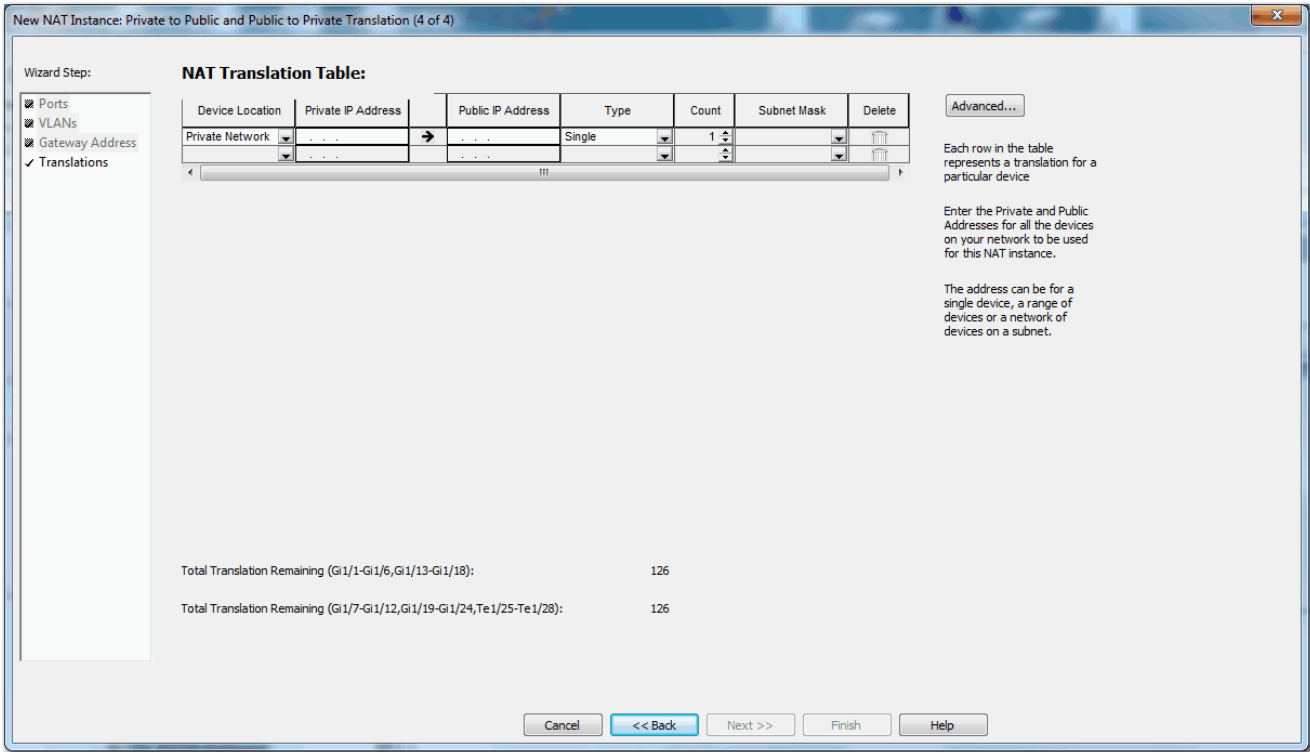

## 7. Configure translations for one device, a range of devices, or all devices on a subnet.

Field	Description
Device Location	Choose the type of network on which the device resides: <ul style="list-style-type: none"> <li>• Private Network</li> <li>• Public Network</li> </ul>
Private IP Address	Specify a private IP address. Single translations: <ul style="list-style-type: none"> <li>• If the device is on a private network, type the existing address for the device.</li> <li>• If the device is on a public network, type a unique address to represent the device on the private network.</li> </ul> Range translations: <ul style="list-style-type: none"> <li>• If the devices are on a private network, type the existing starting address for the devices.</li> <li>• If the devices are on a public network, type a unique starting address to represent the devices on the private network.</li> </ul> Subnet translations: <ul style="list-style-type: none"> <li>• If the devices are on a private subnet, type the existing starting address for the devices.</li> <li>• If the devices are on a public subnet, type a unique starting address to represent the devices on the private subnet.</li> </ul> Subnet addresses must correspond to the size of the subnet mask to translate. See <a href="#">Table 80 on page 206</a> .
Public IP Address	Specify a public IP address. Single translations: <ul style="list-style-type: none"> <li>• If the device is on a private network, type a unique address to represent the device on the public network.</li> <li>• If the device is on a public network, type the existing address for the device.</li> </ul> Range translations: <ul style="list-style-type: none"> <li>• If the devices are on a private network, type a unique starting address to represent the devices on the public subnet.</li> <li>• If the devices are on a public network, type the existing starting address for the devices on the public subnet.</li> </ul> Subnet translations: <ul style="list-style-type: none"> <li>• If the devices are on a private subnet, type a unique starting address to represent the devices on the private network.</li> <li>• If the devices are on a public subnet, type the existing starting address for the devices.</li> </ul> Subnet addresses must correspond to the size of the subnet mask to translate. See <a href="#">Table 80 on page 206</a> .
Type	Choose a translation type: <ul style="list-style-type: none"> <li>• Single—Translates one address.</li> <li>• Range—Translates a range of addresses.</li> <li>• Subnet—Translates all or a portion of addresses on a subnet.</li> </ul>
Count	(Range translation types only). Choose the number of addresses to include in the range. Valid values: 2...128 <b>IMPORTANT:</b> Each address in a range counts as one translation entry: <ul style="list-style-type: none"> <li>• Port ranges Gi1/1...Gi1/6 and Gi1/13...Gi1/18 can include a combined maximum of 128 translation entries.</li> <li>• Port ranges Gi1/7...Gi1/12, Gi1/19...Gi1/24, and Te1/25...Te1/28 can include a combined maximum of 128 translation entries.</li> </ul>
Subnet Mask	(Subnet translation types only). Choose the subnet mask for the addresses to translate. Valid values: <ul style="list-style-type: none"> <li>• Class B: 255.255.0.0</li> <li>• Class C: 255.255.255.0</li> <li>• Portion of Class C: <ul style="list-style-type: none"> <li>– 255.255.255.128 (provides 128 addresses per translation entry)</li> <li>– 255.255.255.192 (provides 64 addresses per translation entry)</li> <li>– 255.255.255.224 (provides 32 addresses per translation entry)</li> <li>– 255.255.255.240 (provides 16 addresses per translation entry)</li> </ul> </li> </ul> <b>IMPORTANT:</b> Each subnet mask counts as one translation entry: <ul style="list-style-type: none"> <li>• Port ranges Gi1/1...Gi1/6 and Gi1/13...Gi1/18 can include a combined maximum of 128 translation entries.</li> <li>• Port ranges Gi1/7...Gi1/12, Gi1/19...Gi1/24, and Te1/25...Te1/28 can include a combined maximum of 128 translation entries.</li> </ul>
Delete	Click to delete the translation entry.

**Table 80 - Valid Subnet Addresses**

Subnet Mask	Subnet Address
255.255.0.0	The last two octets of the address must end in 0. <b>EXAMPLE:</b> Private address: 192.168.0.0 Public address: 10.200.0.0
255.255.255.0	The last octet of the address must end in 0. <b>EXAMPLE:</b> Private address: 192.168.1.0 Public address: 10.200.1.0
255.255.255.128	The last octet of the address must end in 0 or 128. <b>EXAMPLE:</b> Private address: 192.168.1.0 or 192.168.1.128 Public address: 10.200.1.0 or 10.200.1.128
255.255.255.192	The last octet of the address must end in one of the following: 0, 64, 128, 192. <b>EXAMPLE:</b> Private address: 192.168.1.64 Public address: 10.200.1.64
255.255.255.224	The last octet of the address must end in one of the following: 0, 32, 64, 96, 128, 160, 192, 224. <b>EXAMPLE:</b> Private address: 192.168.1.32 Public address: 10.200.1.32
255.255.255.240	The last octet of the address must end in one of the following: 0, 16, 32, 48, 64, 80, 96, 112, 128, 144, 160, 176, 192, 208, 224, 240. <b>EXAMPLE:</b> Private address: 192.168.1.16 Public address: 10.200.1.16

8. To configure traffic permits and fixups, click Advanced to display the Advanced view.

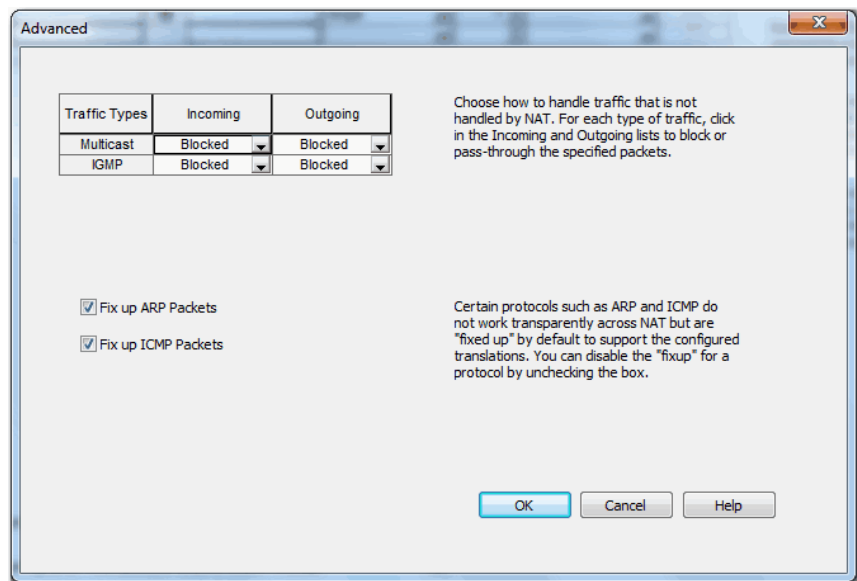

9. In the Incoming and Outgoing fields for each type of traffic, choose one of these options:
  - Pass-Through—Permit unsupported packets to pass across the NAT boundary.
  - Blocked—Drop unsupported packets.
10. To disable protocol fixups for ARP, clear the Fix up ARP checkbox.
11. To disable protocol fixups for ICMP, clear the Fix up ARP checkbox.  
By default, fixups are enabled for both ARP and ICMP.
12. Click OK to return to the Translations view.
13. On the Translations view, click Finish.

## View Address Translations in Linx-based Software

The Ethernet driver in Linx-based software supports devices with address translations. If an address of a device is configured for translation, the public subnet address appears on the main dialog box of Linx-based software. However, its private subnet address appears in the configuration properties of the device.

**Figure 28 - Public and Private Subnet Addresses in Linx-based Software**

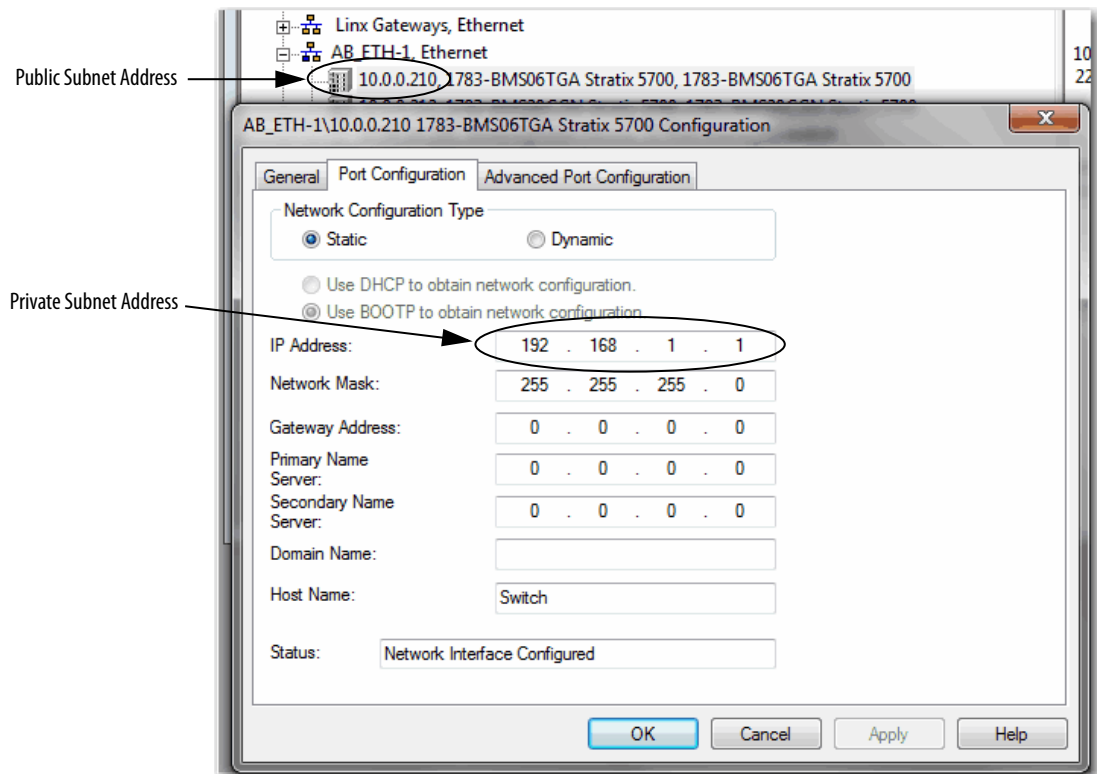

## Network Time Protocol (NTP)

Network Time Protocol (NTP), defined in RFC 1305, is the traditional method of synchronizing clocks across packet-based networks. NTP uses a two-way time transfer mechanism between a master and a slave.

NTP is capable of synchronizing devices in a tightly-controlled network. The switch can use NTP as a time source for PTP, which lets you correlate data generated in the PTP network with data in the enterprise data center running NTP. For information about configuring NTP to PTP time conversion, see [page 88](#).

Use the configuration software for the switch to view NTP status and to configure the NTP associations. An NTP association can be one of these types:

- Peer association—The switch can either synchronize to another device or allow the other device to synchronize to the switch.
- Server association—Only the switch synchronizes to another device. The other device cannot synchronize to the switch.

### Configure NTP in Device Manager

From the Configure menu, choose NTP.

The screenshot shows the NTP configuration page in Device Manager. The top section displays the following NTP status information:

- Clock Status: Clock is synchronized
- Stratum: 5
- Reference: 10.89.0.3
- NTP UP Time: 1357500 (1/100 of seconds)
- Resolution: 8403
- Reference Time: DA5B8A06.038403F3 (15:03:18.013 EST Tue Feb 2 2016)
- Clock Offset: -2.5820 msec
- Root Delay: .20 msec
- Root Dispersion: 83.81 msec
- Peer Dispersion: 4.81 msec
- System Poll Interval: 256
- Last Update: 274 sec ago.

Below the status information is a table of NTP associations. The table has columns for Status, Configured, IP Address, Prefer, Ref Clock, Stratum, When, Poll, Delay, and Off S.

Status	Configured	IP Address	Prefer	Ref Clock	Stratum	When	Poll	Delay	Off S
<input type="radio"/>	Yes	10.89.0.3	<input checked="" type="checkbox"/>	10.80.1.41	4	5	256	2.834	-2.58



**Table 81 - NTP Fields**

<b>Field</b>	<b>Description</b>
Clock Status	Displays the current status of NTP clock synchronization: <ul style="list-style-type: none"> <li>• Synchronized</li> <li>• Unsynchronized</li> </ul>
Stratum	Displays the NTP stratum of this system. The stratum indicates how many NTP hops away a device is from an authoritative time source.
Reference	Displays the address of the peer that the system is synchronized with.
NTP Up Time	Displays the uptime of the NTP entity.
Resolution	Displays the time resolution of the underlying operating system in milliseconds.
Reference Time	Displays the reference time stamp.
Clock Offset	Displays the offset of the system clock to the synchronized peer in milliseconds.
Root Delay	Displays the total delay along the path to the root clock in milliseconds.
Root Dispersion	Displays the number that indicates the maximum error relative to the primary reference source at the root of the synchronization subnet in milliseconds.
Peer Dispersion	Displays the number that indicates the maximum error relative to the synchronized peer (in milliseconds).
System Poll Interval	Displays the poll interval of the peer.
Last Update	Displays the time the system last updated its NTP information.
<b>NTP Association Settings</b>	
Status	Displays a symbol to indicate the status of the NTP peer association. * sys.peer # selected + candidate - outlyer
Configured	Displays the status of the NTP peer association.
IP Address	Displays the specified IP address for the association: <ul style="list-style-type: none"> <li>• For a peer association, the IP address identifies the peer providing, or being provided, the clock synchronization.</li> <li>• For a server association, the IP address identifies the time server providing the clock synchronization.</li> </ul>
Prefer	If checked, the peer or server is the preferred one that provides synchronization.
Ref Clock	Displays a 32-bit code or Internet address that identifies the reference clock of the peer.
Stratum	Displays the stratum of the peer.
When	Displays the time in seconds since the last NTP packet was received from the peer.
Poll	Displays the polling interval in seconds.
Delay	Displays the round-trip delay to the peer in milliseconds.
Offset	Displays the relative time of the peer clock to the local clock in milliseconds.

You can add, edit, and delete NTP associations in the table area on the NTP page. You can add multiple NTP servers.

To add an association, follow these steps.

1. Click Add.

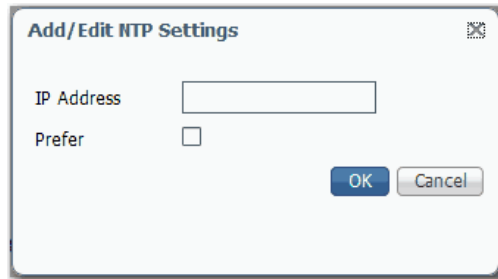

2. In the IP Address field, specify one of the following:
  - For a peer association, type the IP address of the peer providing, or being provided, the clock synchronization.
  - For a server association, type the IP address of the time server providing the clock synchronization.
3. To make the peer or server the preferred one that provides synchronization, check the Prefer checkbox.
4. Click OK.

## Configure NTP via the Logix Designer Application

In the navigation pane, click NTP.

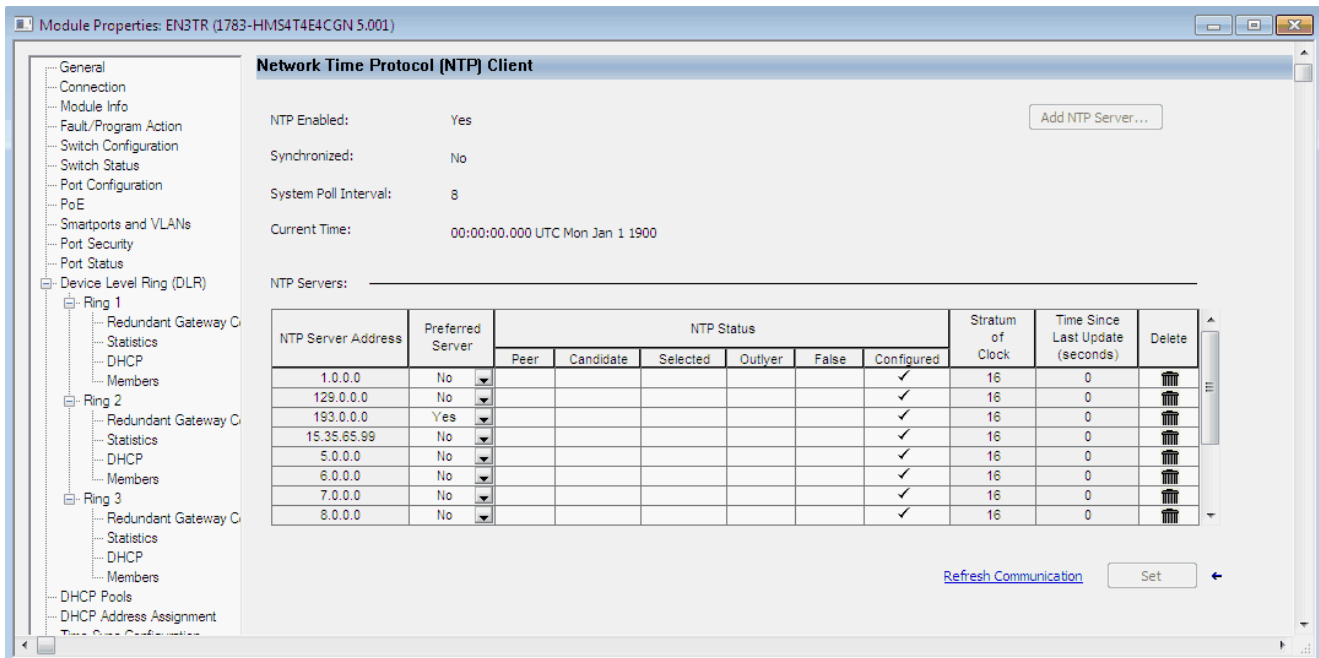

**Table 82 - Network Time Protocol (NTP) Client Fields**

Field	Description
NTP Enabled	Displays whether NTP is enabled or disabled.
Synchronized	Displays the status of NTP clock synchronization: <ul style="list-style-type: none"> <li>Synchronized</li> <li>Unsynchronized</li> </ul>
System Poll Interval	Displays the poll interval of the peer.
Current Time	Displays the reference time stamp.
NTP Server Address	Displays the specified IP address for the association: <ul style="list-style-type: none"> <li>For a peer association, the IP address identifies the peer providing, or being provided, the clock synchronization.</li> <li>For a server association, the IP address identifies the time server providing the clock synchronization.</li> </ul>
Preferred Server	Choose whether the peer or server is the preferred one that provides synchronization.
NTP Status	Displays the status of the NTP peer association.
Stratum of Clock	Displays the stratum of the peer.
Time Since Last Update (seconds)	Displays the time the system last updated its NTP information.

You can add, edit, and delete NTP associations on the Network Time Protocol (NTP) Client view. You can add multiple NTP servers.

To add an association, follow these steps.

1. Click Add NTP Server.

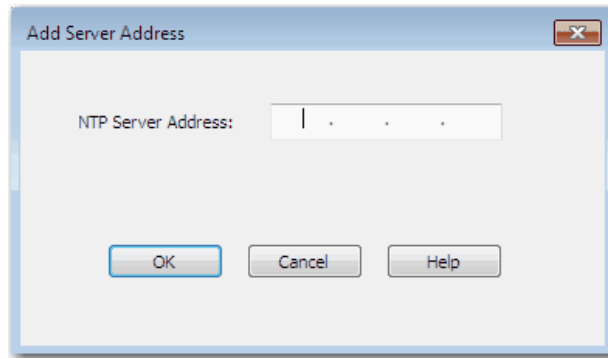

2. In the NTP Server Address field, specify one of the following and click OK:
  - For a peer association, type the IP address of the peer providing, or being provided, the clock synchronization.
  - For a server association, type the IP address of the time server providing the clock synchronization.

The IP address you specify appears in the NTP Servers table.

3. To make the peer or server the preferred one that provides synchronization, choose Yes in the Preferred Server column.

## Open Shortest Path First (OSPF) Routing Protocol

OSPF is available on the following switches:

- Stratix 5400 with Layer 3 firmware
- Stratix 5410 with Layer 3 firmware
- Stratix 8300 base units

OSPF is an interior gateway routing protocol that uses link states rather than distance vectors for path selection. OSPF propagates link-state advertisements (LSAs) rather than routing table updates. Because only LSAs are exchanged instead of the entire routing tables, OSPF networks converge more quickly than Routing Information Protocol (RIP) networks.

OSPF uses a link-state algorithm to build and calculate the shortest path to all known destinations. Each router in an OSPF area contains an identical link-state database, which is a list of each of the router usable interfaces and reachable neighbors. Routing decisions are based on cost, which is an indication of the overhead that is required to send packets across a certain interface. The router calculates the cost of an interface that is based on link bandwidth rather than the number of hops to the destination. The cost can be configured to specify preferred paths.

The OSPF implementation on the switch conforms to the OSPF Version 2 specifications with support for these key features:

- Definition of stub areas.
- Routes that are learned through any IP routing protocol can be redistributed into another IP routing protocol. At the intradomain level, OSPF can import routes that are learned through EIGRP and RIP. OSPF routes can also be exported into RIP.
- Plain text and message digest algorithm 5 (MD5) authentication among neighboring routers within an area.
- Virtual links.
- Not-so-stubby-areas (NSSAs) per RFC 1587.

To enable OSPF, complete these steps.

1. Create an OSPF routing process.
2. Specify the range of IP addresses to be associated with the routing process.
3. Assign area IDs to be associated with that range.

OSPF typically requires coordination among many internal routers, area border routers (ABRs) connected to multiple areas, and autonomous system boundary routers (ASBRs). The minimum configuration uses all default parameter values, no authentication, and interfaces assigned to areas. If you customize your environment, make sure all routers have a coordinated configuration.

## Configure OSPF via Device Manager

From the Configure menu, choose OSPF.

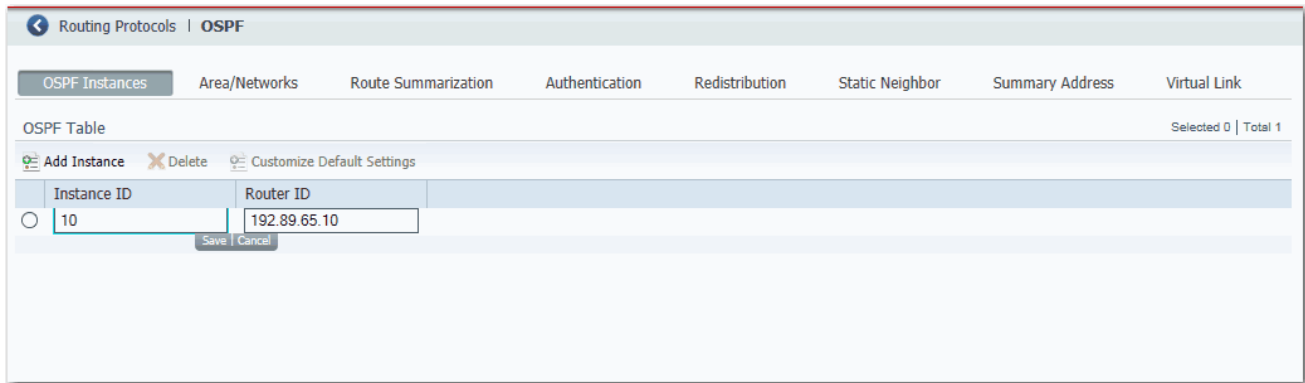

**Table 83 - OSPF Fields**

Field	Description
<b>OSPF Instances</b> —Add OSPF instances to the OSPF table. To customize the default settings for an instance, see <a href="#">page 217</a> .	
Instance ID	Type a unique value to identify internally the OSPF routing process. Valid values: 1...65535
Router ID	Type the IP address of the router that is associated with the OSPF instance.
<b>Area/Networks</b> —Configure the area properties and networks for the OSPF instance.	
OSPF ID	Choose the OSPF routing process ID.
Area ID	Type an identifier of the area to associate with the OSPF address range. You can use either a decimal value or an IP address. If you intend to associate areas with IP subnets, you can specify a subnet address as the value.
Area Type	Click an area type and specify related parameters: <ul style="list-style-type: none"> <li>• Normal—Normal areas can be either standard areas or transit (backbone) areas. Standard areas can accept intra-area, inter-area, and external routes. The backbone area is the central area to which all other areas in OSPF connect.</li> <li>• Stub—Stub areas do not receive information about external routes.                             <ul style="list-style-type: none"> <li>– Summary—Allows sending link-state advertisements (LSAs) into the stub network.</li> </ul> </li> <li>• NSSA—Not-so-stubby-areas are an extension of OSPF stub areas. However, an NSSA can import external routes into the OSPF routing domain. Every router within the same area must agree that the area is an NSSA.                             <ul style="list-style-type: none"> <li>– Redistribution—Allows routes redistribution.</li> <li>– Summary—Allows sending LSAs into an NSSA network.</li> <li>– Default Information Originate—Enable on an area border router (ABR) to allow the importing of type 7 LSAs into an NSSA network.</li> </ul> </li> </ul>
Network Address	Type one or multiple interfaces to be associated with a specific OSPF area. <b>IMPORTANT:</b> Any individual interface can be attached to only one area. If the address ranges specified for different areas overlap, the system adopts the first area in the network list and ignore the subsequent overlapping portions. In general, we recommend that you configure address ranges that do not overlap to avoid inadvertent conflicts.
Network Mask	Choose an IP-address-type mask.
Authentication	Click the authentication type for the area: <ul style="list-style-type: none"> <li>• No Authentication</li> <li>• Password</li> <li>• MD5</li> </ul> The authentication type must be the same for all routers and access servers in an area.
Default Cost	Type a value to specify the cost of sending a packet on an interface. Valid values: 1...65535 Default: 1

**Table 83 - OSPF Fields (Continued)**

Field	Description
<b>Route Summarization</b> —Route summarization consolidates and summarizes addresses for an area and is used only with area border routers (ABRs). In OSPF, an ABR advertises networks in one area into another area. If the network numbers in an area are contiguous, you can configure the ABR to advertise a summary route that covers all individual networks within the area that are in the specified range. Routing information is condensed at area boundaries. External to the area, one route is advertised for each address range.	
OSPF ID	Choose an OSPF routing process ID.
Area ID	Type the area ID for the routes to be summarized.
IP Address	Type the IP address of the summary route.
Netmask	Choose a netmask for the summary route.
Advertise Routes	Check the checkbox to set the address range status to advertise and generate a Type 3 summary link-state advertisement (LSA).
<b>Authentication</b> —OSPF supports MD5 and clear text neighbor authentication. Use authentication with all routing protocols when possible because route redistribution between OSPF and other protocols (like RIP) can potentially be used by attackers to subvert routing information.	
Interface Name	Indicates the name of the OSPF interface.
Authentication	Click the authentication type for an interface: <ul style="list-style-type: none"> <li>No Authentication</li> <li>Password</li> <li>MD5</li> </ul> The authentication type must be the same for all routers and access servers in an area.
Authentication Password	Type a shared password to be used by neighboring OSPF routers on a network segment that is using the OSPF simple password authentication. The password can be any string of keyboard-entered characters up to 8 bytes in length. All neighboring routers on the same network must have the same password to exchange OSPF information.
MD5 Key ID	Type an identifier. Valid values: 1 . . . 255.
MD5 Key	Type an alphanumeric password of up to 16 bytes.
<b>Redistribution</b> —Redistributing routes into OSPF from other routing protocols or from static routes causes these routes to become OSPF external routes.	
OSPF ID	Choose an OSPF routing process ID.
Protocol	Click the route type for redistribution into the OSPF routing process: <ul style="list-style-type: none"> <li>Static—Redistributes static routes into the OSPF routing process.</li> <li>Connected—Redistributes connected routes into the OSPF routing process.</li> <li>OSPF—Redistributes routes from an OSPF routing process into another OSPF routing process.</li> <li>RIP—Redistributes routes from an RIP routing process into the OSPF routing process.</li> <li>EIGRP—Redistributes routes from an EIGRP routing process into the OSPF routing process.</li> </ul>
Match	(Optional). Match and set properties of routes that are imported from OSPF: <ul style="list-style-type: none"> <li>Internal—Matches internal OSPF routes.</li> <li>External 1—Matches Type 1 external routes.</li> <li>External 2—Matches Type 2 external routes.</li> <li>NSSA External 1—Matches Type 1 NSSA routes.</li> <li>NSSA External 2—Matches Type 2 NSSA routes.</li> </ul>
Metric Value	Matches routes with the specified OSPF metric cost value.
Metric Type	Matches External Type 1 or 2 routes.
Tag Value	Matches routes with the specified name.
Subnets	Check the checkbox to include subnetted routes in the redistribution.
<b>Static Neighbor</b> —Define static OSPF neighbors to advertise OSPF routes over a point-to-point, non-broadcast network.	
OSPF ID	Choose an OSPF routing process ID.
Neighbor	Type the IP address of the OSPF neighbor.

Table 83 - OSPF Fields (Continued)

Field	Description
<b>Summary Address</b> —An OSPF ASBR uses a summary address to advertise one external route as an aggregate for all redistributed routes that are covered by the address.	
OSPF ID	Choose an OSPF routing process ID.
IP Address	Type the summary address that is designated for a range of addresses.
Net Mask	Choose the IP subnet mask to use for the summary route.
<b>Virtual Link</b> —In OSPF, all areas must be connected to a backbone area. You can establish a virtual link if there is a backbone-continuity break by configuring two Area Border Routers as Endpoints of a virtual link. Configuration information includes the identity of the other virtual Endpoint (the other ABR) and the nonbackbone link that the two routers have in common (the transit area). Virtual links cannot be configured through a stub area.	
OSPF ID	Choose an OSPF routing process ID.
Area ID	Choose the area ID for the area that is assigned to the OSPF virtual link.
Peer Router ID	Type the router ID associated with the virtual link neighbor.
Authentication	Choose the authentication type for the virtual link: <ul style="list-style-type: none"> <li>No Authentication</li> <li>Password</li> <li>MD5</li> </ul> The authentication type must be the same for all routers and access servers in an area.
Authentication Password	Type a shared password to be used by neighboring OSPF routers on a network segment that is using the OSPF simple password authentication. The password can be any string of keyboard-entered characters up to 8 bytes in length. All neighboring routers on the same network must have the same password to exchange OSPF information.
MD5 Key ID	Type an identifier. Valid values: 1c255.
MD5 Key	Type an alphanumeric password of up to 16 bytes.
Hello	Type the time (in seconds) between the hello packets that the software sends on an interface. The hello interval is an unsigned integer value to be advertised in the hello packets. The value must be the same for all routers and access servers that are attached to a common network. Valid values: 1 . . . 8192 Default: 10
Transmit Delay	Type the estimated time (in seconds) required to send a link-state update packet on the interface. The integer value that must be greater than zero. LSAs in the update packet have their age that is incremented by this amount before transmission. Valid values: 1 . . . 8192 Default: 1
Retransmit	Type the time (in seconds) between link-state advertisement (LSA) retransmissions for adjacencies belonging to the interface. The retransmit interval is the expected round-trip delay between any two routers on the attached network. The value must be greater than the expected round-trip delay. Valid values: 1 . . . 8192 Default: 5
Dead Interval	Type the time (in seconds) that hello packets are not seen before a neighbor declares the router down. The dead interval is an unsigned integer value. The default is four times the hello interval, or 40 seconds. As with the hello interval, this value must be the same for all routers and access servers that are attached to a common network.



To change the default settings after adding an EIGRP instance, on the EIGRP Instances tab, click the button in the row to customize, and then click Customize Default Settings.

**IMPORTANT** Setting metrics is complex and is not recommended without guidance from an experienced network designer.

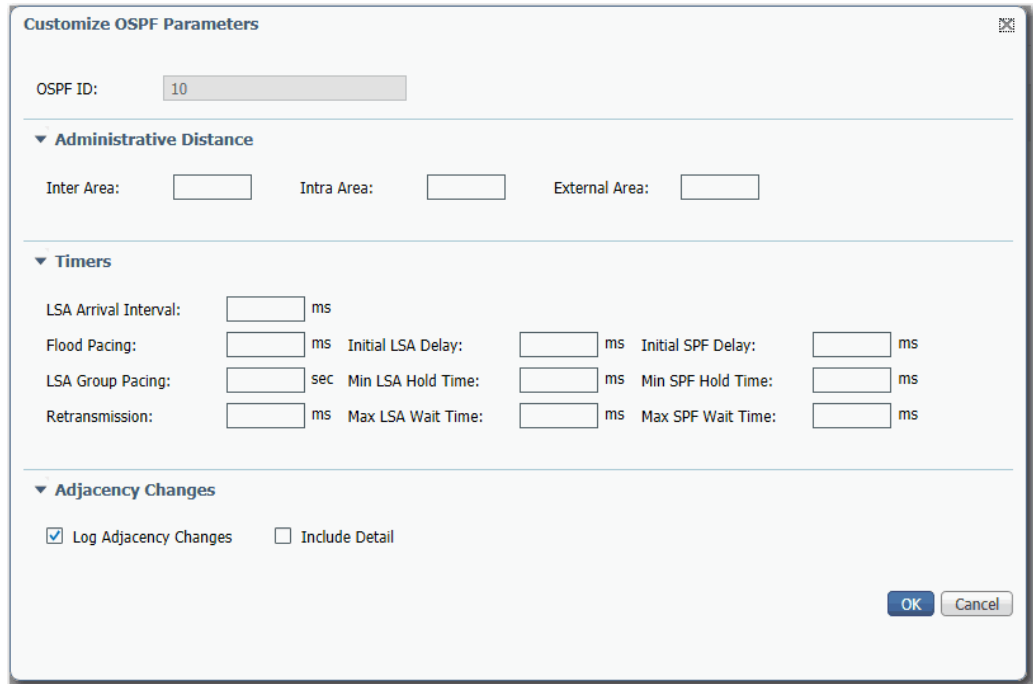

**Table 84 - Customize OSPF Parameters**

Field	Description
OSPF ID	(Not editable). Displays the OSPF routing process ID.
<b>Administrative Distance</b>	
Inter Area	Type an administrative distance for routes within an area. Valid values: 1...255 Default: 200
Intra Area	Type an administrative distance for routes to another area. Valid values: 1...255 Default: 200
External Area	Type an administrative distance for routes from another routing domain that is learned through redistribution. Valid values: 1...255 Default: 20
<b>Timers</b>	
LSA Arrival Interval	Type the minimum delay in milliseconds that must pass between acceptance of the same LSA arriving from neighbors. The same LSA is an LSA instance that contains the same LSA ID number, LSA type, and advertising router ID. If an instance of the same LSA arrives sooner than the interval that is set, the LSA is dropped. Valid values: 0...600,000 ms Default: 1000 ms

**Table 84 - Customize OSPF Parameters (Continued)**

Field	Description
Flood Pacing	Type the time at which LSAs in the flooding queue are paced between updates. Valid values: 5 . . . 100 ms Default: 33 ms The default settings for OSPF packet pacing timers are suitable for most OSPF deployments. Do not change the packet pacing timers unless all other options to meet OSPF packet flooding requirements have been exhausted. Specifically, we recommend that network operators use summarization, stub area usage, queue tuning, and buffer tuning before changing the default flood timers. There are no guidelines for changing timer values; each OSPF deployment is unique and must be considered on a case-by-case basis.
LSA Group Pacing	Type the number of seconds in the interval at which LSAs are grouped and refreshed, checksummed, or aged. OSPF LSA group pacing allows the router to group OSPF LSAs and pace the refreshing, check-summing, and aging functions for more efficient router use. The optimum group pacing interval is inversely proportional to the number of LSAs the router is refreshing, check-summing, and aging. For example, if you have approximately 10,000 LSAs in the database, decreasing the pacing interval is beneficial. If you have a small database (40 . . . 100 LSAs), increasing the pacing interval to 10 . . . 20 minutes can benefit you slightly. Valid values: 10 . . . 1800 s Default: 240 s
Retransmission	Type the time in milliseconds at which LSAs in the retransmission queue are paced. Valid values: 5 . . . 200 ms Default: 66 ms.
Initial LSA Delay	Type the delay in milliseconds to generate the first occurrence of the LSA. Default: 0 ms
Min LSA Hold Time	Type the minimum delay in milliseconds to originate the same LSA. Default: 5000 ms
Max LSA Wait Time	Type the maximum delay in milliseconds to originate the same LSA. Default: 5000 ms
Initial SPF Delay	Type the time in milliseconds between when OSPF receives a topology change and when the SPF calculation starts. Valid values: 0 . . . 60,0000 ms
Min SPF Hold Time	Type the hold time in milliseconds between consecutive SPF calculations. Valid values: 0 . . . 60,0000 ms
Max SPF Wait Time	Type the maximum wait time between two consecutive SPF calculations. Valid values: 0 . . . 60,0000 ms
<b>Adjacency Changes</b>	
Log Neighbor Changes	Enables the logging of syslog messages when a neighbor state changes. Default: Disabled (no adjacency changes are logged)
Include Detail	Enables the logging of syslog messages whenever any state change occurs, not just when a neighbor goes up or down. Default: Disabled

## Parallel Redundancy Protocol (PRP)

Parallel Redundancy Protocol (PRP) is defined in international standard IEC 62439-3 and provides high-availability in Ethernet networks. PRP technology creates seamless redundancy by sending duplicate frames to two independent network infrastructures, which are known as LAN A and LAN B.

A PRP network includes the following components.

Component	Description
LAN A and LAN B	Redundant, active Ethernet networks that operate in parallel.
Double attached node (DAN)	An end device with PRP technology that connects to both LAN A and LAN B.
Single attached node (SAN)	An end device without PRP technology that connects to either LAN A or LAN B. A SAN does not have PRP redundancy.
Redundancy box (RedBox)	A switch with PRP technology that connects devices without PRP technology to both LAN A and LAN B.
Virtual double attached node (VDAN)	An end device without PRP technology that connects to both LAN A and LAN B through a RedBox. A VDAN has PRP redundancy and appears to other nodes in the network as a DAN.
Infrastructure switch	A switch that connects to either LAN A or LAN B and is not configured as a RedBox.

For more information about PRP topologies and configuration guidelines, see the EtherNet/IP Parallel Redundancy Protocol Application Technique, publication [ENET-AT006](#).

You can configure either a Stratix 5400 or 5410 switch as a RedBox. [Figure 29](#) illustrates the Stratix 5400 switch as RedBox.

---

**IMPORTANT** Before connecting cables between devices in a PRP system, complete the configuration of the devices.

---

Figure 29 - PRP Topology with Stratix 5400 Switch as RedBox

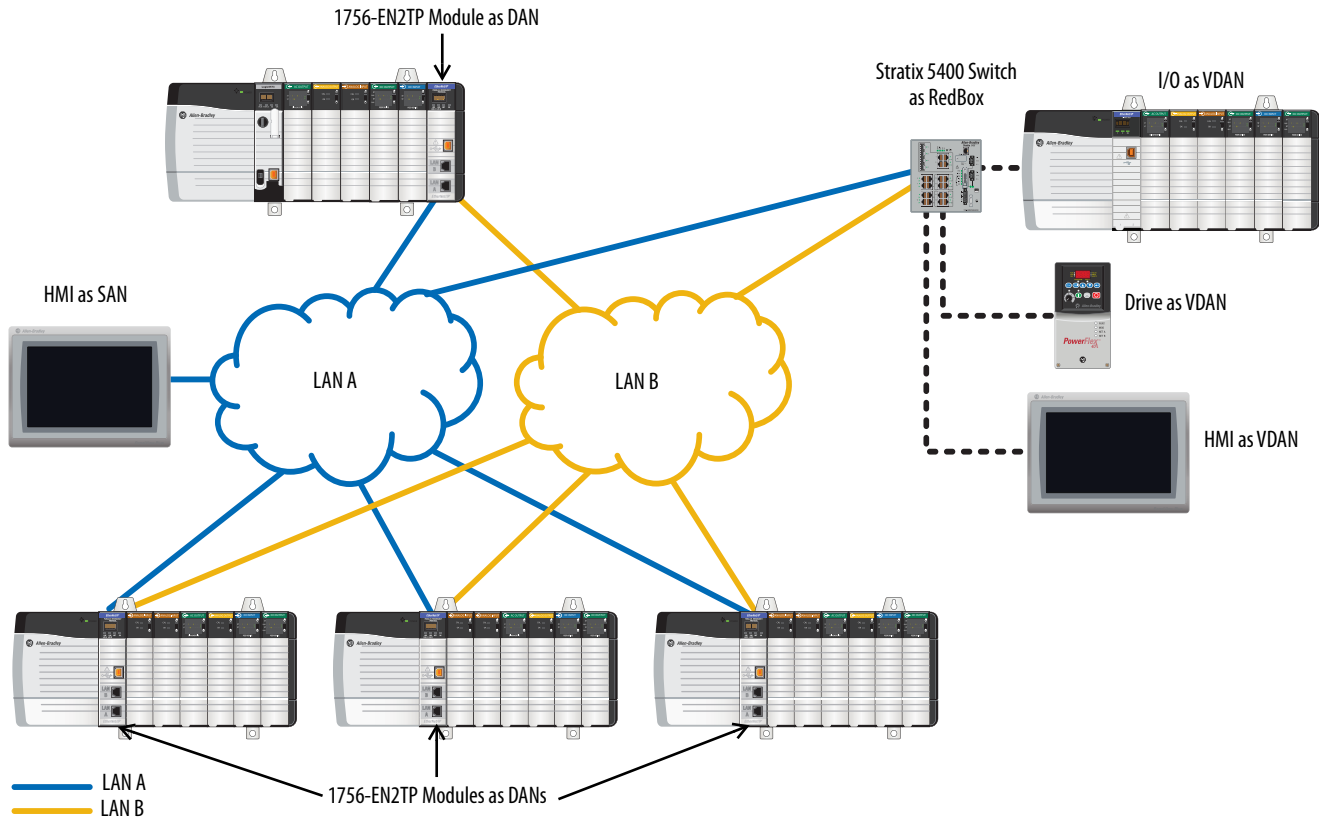

### RedBox PRP Channel Groups

For RedBox functionality, Stratix 5400 and 5410 switches have designated ports for PRP channel groups. A PRP channel group is a logical interface that aggregates two Gigabit Ethernet physical ports into a single link. In the channel group, the lower numbered Gigabit Ethernet member port is the primary port that connects to LAN A. The higher numbered port is the secondary port that connects to LAN B. The PRP channel remains up as long as at least one of these member ports remains up and sends traffic. When both member ports are down, the channel is down.

The following table shows the available PRP channel group ports for switches configured as a RedBox.

Switch	Channel Group	Member Ports
Stratix 5400	1	Gi1/1 and Gi1/2
Stratix 5410	1	Gi1/17 and Gi1/18
	2	Gi1/19 and Gi1/20

## Traffic and Supervisory Frames

Traffic egressing the RedBox PRP channel group can be destined to either SANs connected only on either LAN A or LAN B or to DANs. To avoid duplication of packets for SANs, the switch learns source MAC IDs from supervisory frames for DAN entries and non-PRP frames for SAN entries. Learned MAC IDs are maintained in the Node table. When forwarding packets out of the PRP channel to SAN MAC IDs, the switch looks up the entry and determines which LAN to send to rather than duplicating the packet.

A RedBox with VDANs needs to send supervisory frames on behalf of those VDANs. For traffic coming in on all other ports and going out PRP channel ports, the switch learns source MAC IDs, adds them to the VDAN table, and starts sending supervisory frames for these addresses. Learned VDAN entries are subject to aging.

All Allen-Bradley products with PRP technology support supervisory frames. If your PRP system includes a device that does not support supervisory frames, the switch identifies the device as a DAN, even if it is a SAN or VDAN. In this scenario, we recommend that you manually add the device to the Node or VDAN table, so the switch can correctly identify the device as a DAN, SAN, or VDAN and manage traffic appropriately.

## Node and VDAN Limitations

When configuring nodes and VDANs, be aware of the following limitations:

- The switch supports a maximum of 512 SAN and DAN entries in the Node table.
- Hash collisions can limit the number of MAC IDs. If the Node table is out of resources for learning a MAC ID from a node, the switch defaults to treating that node as a DAN.
- After restarting and before any MAC ID is learned, the switch temporarily treats an unlearned node as a DAN and duplicates the egress packets until an ingress packet or supervisory frame is received from the node to populate an entry into the Node table.
- The switch supports a maximum of 512 VDAN entries in the VDAN table. If the VDAN table is full, the switch cannot send supervisory frames for new VDANs.

## Configuration Considerations

A PRP network has specific requirements and considerations for the following:

- Device IP addresses
- Frame sizes
- Spanning Tree Protocol (STP)
- Multicast traffic and IGMP querier
- CIP Sync time synchronization (Precision Time Protocol)

For requirements related to these features, see the EtherNet/IP Parallel Redundancy Protocol Application Technique, publication [ENET-AT006](#).

## Configure a RedBox via Device Manager

---

**IMPORTANT** You are only required to add nodes to the VDAN or Node table if you are using a PRP device that does not support supervisory frames. All Allen-Bradley products with PRP technology support supervisory frames. For more information, see [Traffic and Supervisory Frames on page 221](#).

---

To configure a Stratix 5400 or 5410 switch as a RedBox, follow these steps.

1. From the Configure menu, choose PRP.

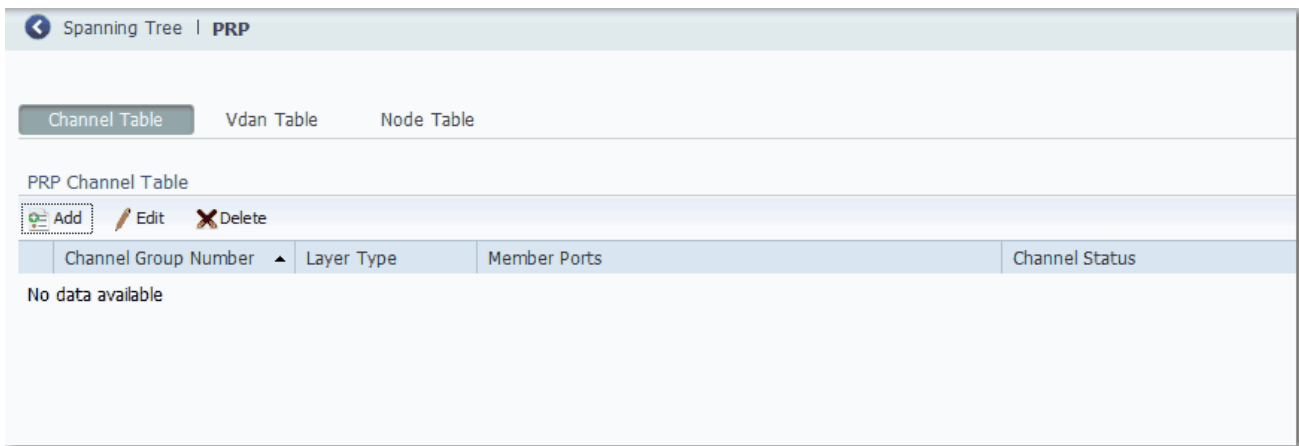

2. Add PRP channel groups.
  - a. Click the Channel Table tab.
  - b. Click Add.
  - c. Complete the fields described in [Table 85](#) and click OK.

**Table 85 - Add PRP Channel Fields**

Field	Description
Channel Group Number	Choose a channel group number: <ul style="list-style-type: none"> <li>Stratix 5400 switches provide 1 channel group</li> <li>Stratix 5410 switches provide 2 channel groups</li> </ul>
Port 1	Choose a port to be a member of the channel group.
Port 2	Choose a port to be a member of the channel group.
Administrative	Check Enable to activate the switch ports. By default, the ports are enabled. Clear the Enable checkbox to disable the switch ports.
Administrative Mode	Choose one of the following modes for PRP channel group: <ul style="list-style-type: none"> <li>Access (default)—The channel group carries traffic for a single VLAN.</li> <li>Trunk—The channel group carries traffic for multiple VLANs.</li> <li>Routed—Layer 3</li> </ul>
Description	Type a description for the PRP channel. The description can contain a maximum of 200 characters.
Access VLAN	(Access mode only). Choose the VLAN to which the PRP channel group belongs. The default value is <b>default-1</b> .
Allowed VLAN	(Trunk mode only). Click one of these options to specify the VLANs to transmit traffic from this channel group in tagged format: <ul style="list-style-type: none"> <li>All VLANs (default)—Click to allow all VLANs to transmit traffic from this channel group.</li> <li>VLAN IDs—Click to allow only the VLANs you specify to transmit traffic from this channel group. Type each VLAN ID separated by a comma or use a dash for ranges, such as 1,5,7–12,17.</li> </ul>
Native VLAN	(Trunk mode only). Choose the VLAN to send and receive untagged traffic on the trunk port. The default value is <b>default-1</b> .
IP Assignment Mode	(Routed mode only). Click one of these options to specify the IP address of this PRP channel group: <ul style="list-style-type: none"> <li>No IP Address—Do not assign an IP address.</li> <li>Static—Manually assign a static IP address. Type the IP address and the subnet mask.</li> <li>DHCP—Allow a DHCP server to automatically assign an IP address.</li> </ul>

3. To add a VDAN to the VDAN table, do the following.
  - a. Click the VDAN Table tab
  - b. Complete the fields in [Table 86](#) and click OK.

**Table 86 - Add PRP VDAN Fields**

Field	Description
Channel Group Number	Choose a channel group number: <ul style="list-style-type: none"> <li>• Stratix 5400 switches provide 1 channel group</li> <li>• Stratix 5410 switches provide 2 channel groups</li> </ul>
VDAN MAC Address	Type the MAC ID of the VDAN.
VLAN ID	(Access mode only). Choose the VLAN associated with the PRP channel group. The default value is <b>default-1</b> .

4. To add a DAN or SAN to the Node table, do the following.
  - a. Click the Node Table tab.
  - b. Click Add, complete the fields as described in [Table 87](#) and click OK.

**Table 87 - Add PRP Node Fields**

Field	Description
Channel Group Number	Choose a channel group number: <ul style="list-style-type: none"> <li>• Stratix 5400 switches provide 1 channel group</li> <li>• Stratix 5410 switches provide 2 channel groups</li> </ul>
Node Table MAC Address	Type the MAC ID of the DAN or SAN.
Node	Choose the type of PRP node: <ul style="list-style-type: none"> <li>• DAN (default)—Double attached node</li> <li>• SAN-A—Single attached node on LAN A</li> <li>• SAN-B—Single attached nnode on LAN B</li> </ul>



## Troubleshoot PRP

If you encounter problems accessing Device Manager, web browsing, or using remote desktop on a switch, verify the MTU size for frames. The jumbo MTU size must be set to 1506 for all switches in LAN A and LAN B.

If you cannot access Device Manager, use one of following methods to access the switch:

- Use the CLI as described on [page 73](#).
- Use a computer-to-switch connection with a straight-through or crossover Category 5 Ethernet cable.

For more diagnostic methods, see the EtherNet/IP Parallel Redundancy Protocol Application Technique, publication [ENET-AT006](#).

## Port Mirroring

Port mirroring is for advanced users with experience in troubleshooting traffic and protocol issues on networks. Port mirroring copies, or mirrors, traffic on one port to a monitoring port where a network protocol analyzer tool can capture the packet. Use port mirroring as a diagnostic tool or debugging feature.

Port mirroring does not affect the switching of network traffic on the monitored port. You must dedicate a monitoring port for port mirroring use. Except for traffic that is being copied for the port mirroring session, the monitoring port does not receive or forward traffic.

You can configure port mirroring by assigning the Port Mirroring Smartport role on a switch port via Device Manager.

---

**IMPORTANT** You can configure port mirroring on only one port via Device Manager. However, you can configure multiple ports via the CLI.

---

---

**IMPORTANT** Port mirroring is a tool for analyzing end node traffic. Because the switch can filter certain network control traffic, we recommend that you do not use port mirroring when you require an exact copy of all network traffic.

---

---

**IMPORTANT** Port mirroring does not work on PRP channel ports.

---

## Configure Port Mirroring in Device Manager

To configure port mirroring, follow these steps.

1. From the Configure menu, choose Smartports.
2. Select the checkbox next to the port to do the monitoring, and then click Edit.

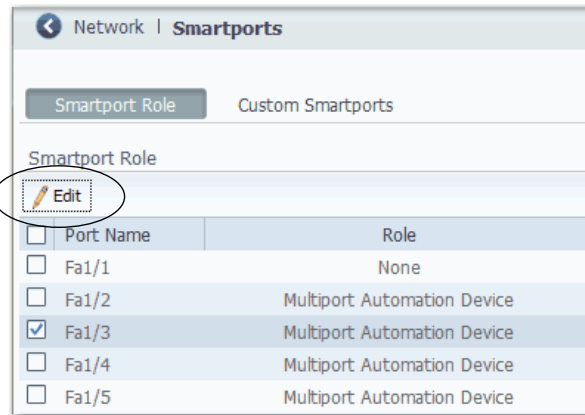

3. Complete the fields, and then click Submit.

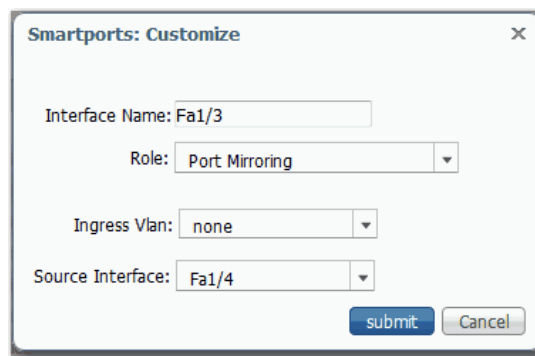

Field	Description
Interface Name	Displays the port you selected to do the monitoring.
Role	Choose Port Mirroring.
Ingress VLAN	(Optional). Choose a VLAN to monitor.
Source Interface	Choose the port to monitor. The port you assigned to the Port Mirroring role monitors traffic that passes through this port.

4. Verify that the Port Mirroring role is assigned to the port.

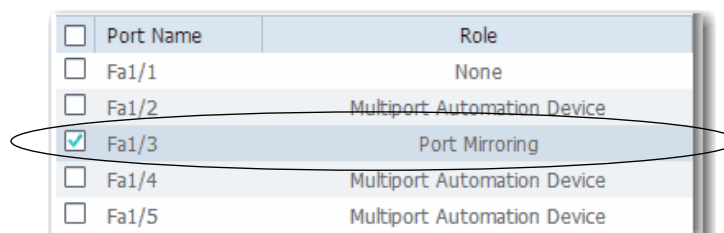

## Port Security

Stratix managed switches implement MAC ID-based port security. A MAC ID is a unique address that is assigned to each Ethernet-capable device. Switches can enforce communication either dynamically or statically per MAC ID.

With dynamic port security, a switch port communicates with some number of devices. The port tracks only the number of devices rather than the MAC IDs of those devices. Static port security adds devices to the port security table on a per MAC ID basis. With static dynamic port security, only devices with the MAC IDs in the security table are able to communicate on that port.

Port Security is not available on Stratix 5700 switches with lite firmware.

### Dynamic Secure MAC ID

Many Smartport roles have a maximum number of MAC IDs that can use that port. For example, the Smartport role 'Automation Device' configures the port for a maximum of one MAC ID. The MAC ID is dynamic, meaning the switch learns the first source MAC ID to use the port. Attempts by any other MAC ID to access the port are denied.

If the link becomes inactive, the switch dynamically relearns the MAC ID to be secured.

The default number of MAC IDs can be changed on the Port Security tab within Device Manager or the Logix Designer application.

The following table shows the Smartport role and the maximum number of supported MAC IDs.

**Table 88 - Maximum Number of MAC IDs per Smartport Role**

Smartport Role	Number of MAC IDs (max)
Automation Device	1
Desktop for Automation	1
Switch for Automation	Not restricted
Router for Automation	Not restricted
Phone for Automation	3
Wireless for Automation	Not restricted
Multipoint Automation Devices	Not restricted
Virtual Desktop for Automation	2
Port Mirroring	Not restricted
None	Not restricted

## Static Secure MAC ID

The other method of limiting MAC IDs is to configure statically one or more MAC IDs for a port by defining them via port security with Device Manager. These addresses become part of the saved configuration of the switch. This method provides strong security. However, if you replace any devices that are connected to the port, you must reconfigure the MAC IDs because the new devices have different MAC IDs than the previous devices.

For Stratix 8000/8300 switches, you can configure the static secure method only with the Logix Designer application. Configuration for this method is not available with Device Manager.

## Security Violations

It is a security violation when one of these situations occurs:

- The maximum number of secure MAC IDs that have been configured for a port are in the address table. A station whose MAC ID is not in the address table attempts to access the interface.
- An address that is learned or configured on one secure interface is seen on another secure interface in the same VLAN.

When a violation occurs, the port goes into the Restrict mode. In this mode, packets with unknown source addresses are dropped and you are notified that a security violation has occurred. An SNMP trap is sent, a syslog message is logged, and the violation counter increments.

## Configure Port Security via Device Manager

From the Configure menu, choose Port Security.

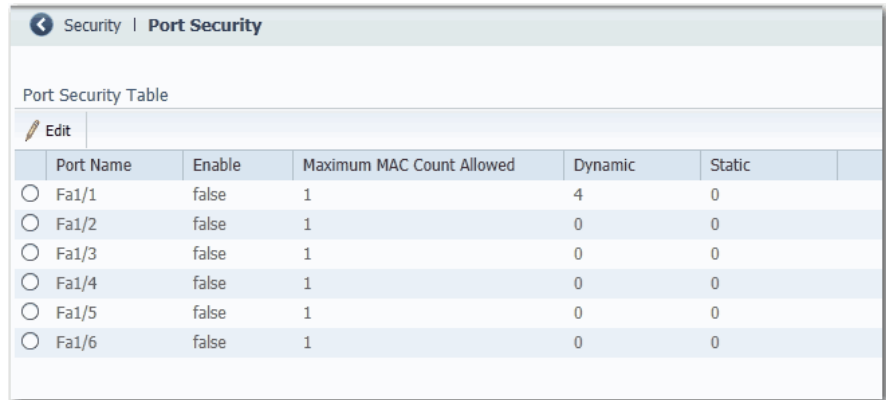

Security   Port Security					
Port Security Table					
Edit					
Port Name	Enable	Maximum MAC Count Allowed	Dynamic	Static	
<input type="radio"/> Fa1/1	false	1	4	0	
<input type="radio"/> Fa1/2	false	1	0	0	
<input type="radio"/> Fa1/3	false	1	0	0	
<input type="radio"/> Fa1/4	false	1	0	0	
<input type="radio"/> Fa1/5	false	1	0	0	
<input type="radio"/> Fa1/6	false	1	0	0	

Port security limits and identifies the MAC IDs of devices that can send traffic through the switch port. The switch port does not forward traffic from devices outside the defined group of devices. A security violation occurs when any of the following conditions occur:

- A device, which has a MAC ID different from any identified secure MAC IDs, attempts to access the switch port.
- The number of MAC IDs on the port exceeds the maximum number that is supported on the port.

Port security supports multiple security levels:

- The ability to define the number of devices that are connected to a given port. Devices are assigned on a first-come, first-served basis and time out after a certain period of inactivity.
- The ability to store the existing MAC ID configuration by selecting Add Learned MAC Addresses on the Static MAC Address Table.
- The ability to add and remove manually MAC IDs on a per port basis.

To change the static MAC IDs table for a port, follow these steps.

1. Click the radio button next to the port to configure.
2. Click Edit.
3. Clear or check the Enable checkbox.
4. Configure MAC IDs as follows:
  - To add the existing MAC IDs of devices that are currently connected to a port, click Add Learned MAC Addresses.
  - To add a specific MAC ID to the table, type a MAC ID in the format fields and click Add.
  - To remove a MAC ID from the table, select the MAC ID and click Remove.
  - To clear the table, click Remove All.

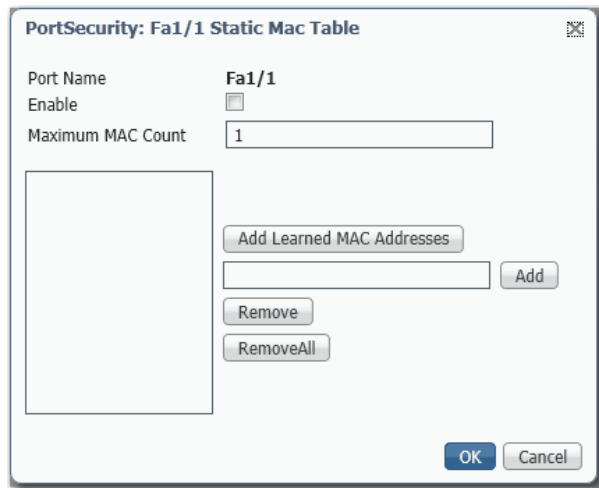

5. Click OK.

## Configure Port Security via the Logix Designer Application

In the navigation pane, click Port Security.

For Stratix 8000/8300 switches, use Advanced Port Configuration as described on [page 232](#).

**Figure 30 - Port Security**

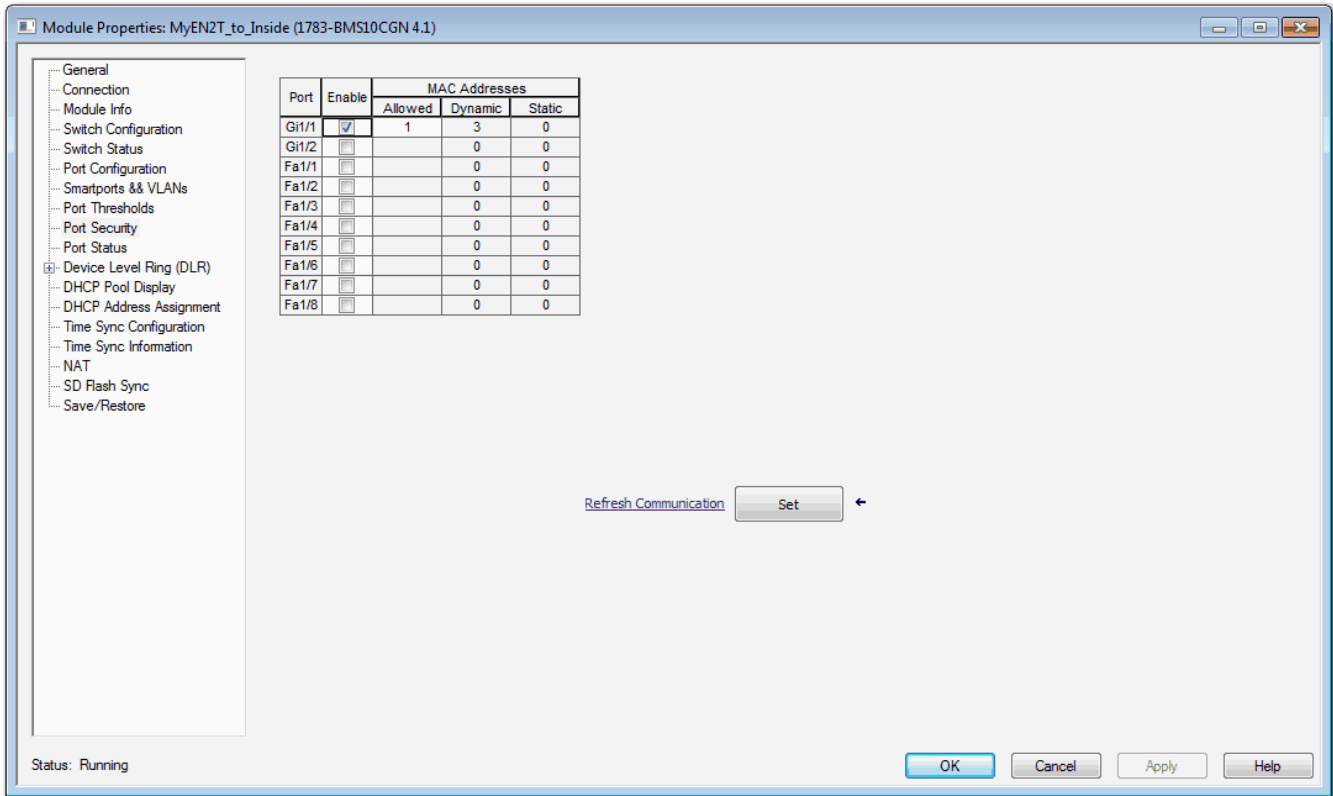

**Table 89 - Port Security Fields**

Field	Description
Port	The port on which you want to enable or disable security.
Enable	Check the checkbox to enable port security.
MAC Addresses	<p>The number of supported dynamic or static MAC IDs.</p> <ul style="list-style-type: none"> <li>Allowed—1...80.</li> <li>Dynamic—The number of MAC IDs (devices) currently connected to the port that is not manually (statically) defined.</li> <li>Static—The number of MAC IDs (devices) statically defined by using Device Manager.</li> </ul> <p>This number must be greater than the sum of the static + dynamic for a given port. If you wish to set the number to less, disconnect the appropriate devices and let their entries in the port security table time out.</p>

For Stratix 8000/8300 switches, in the navigation pane, click Advanced Port Configuration.

Figure 31 - Advanced Port Configuration for Stratix 8000/8300 Switches

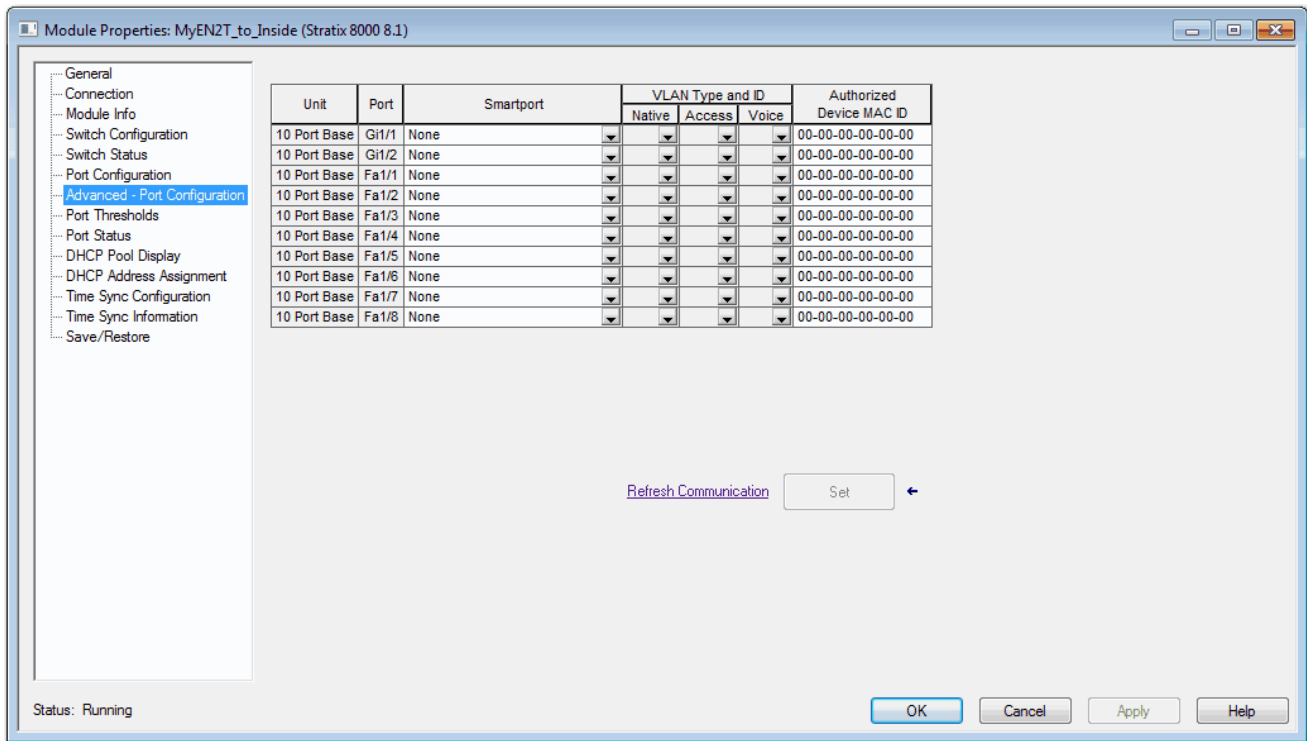

Table 90 - Advanced Port Configuration Fields for Stratix 8000/8300 Switches

Field	Description
Unit	Indicates where the port resides: <ul style="list-style-type: none"> <li>• Base (for example, 1783-MS10T).</li> <li>• Expansion module (for example, 1783-MX08T).</li> </ul>
Port	Indicates the port that is selected for configuration. The port number includes the port type (Fa for Fast Ethernet and Gi for Gigabit Ethernet), the base or expansion module number (1, 2, or 3), and the specific port number, such as in the following examples: <ul style="list-style-type: none"> <li>• Gi1/1 is Gigabit Ethernet port 1 on the base.</li> <li>• Fa2/1 is Fast Ethernet port 1 on the first expansion module.</li> </ul>
Smartport	See <a href="#">Assign Smartports and VLANs via the Logix Designer Application on page 276</a> .
VLAN Type and ID	
Authorized Device MAC ID	To authorize a specific MAC ID to communicate on the port, type the MAC ID of the device that is connected to the port. You can authorize only one MAC ID to communicate on the port. If other MAC IDs communicate on the port, they are blocked. This feature must not be set for ports that are connected to other switches or routers.  The MAC ID is also known as MAC ID, physical address, or hardware address. Each node on the network has a unique MAC ID. The MAC ID is six hexadecimal numbers, such as 00-00-BC-22-A0-D8.



## Port Thresholds

Port thresholds help prevent traffic on a LAN from being disrupted by a broadcast, multicast, or unicast storm on one of the physical interfaces. Port thresholds do not apply to switches with lite firmware.

A LAN storm occurs when packets flood the LAN, creating excessive traffic and degrading network performance. Errors in the protocol-stack implementation, mistakes in network configurations, or users issuing denial-of-service attacks can cause a storm.

### Incoming (storm control)

Incoming port thresholds (or traffic suppression) monitor packets passing from an interface to the switching bus and determines if the packet is unicast, multicast, or broadcast. The switch counts the number of packets of a specified type that is received within the 1-second time interval and compares the measurement with a predefined suppression-level threshold.

Port thresholds use one of these methods to measure traffic activity:

- Bandwidth as a percentage of the total available bandwidth of the port that can be used by the broadcast, multicast, or unicast traffic.
- Traffic rate in packets per second at which broadcast, multicast, or unicast packets are received.
- Traffic rate in bits per second at which broadcast, multicast, or unicast packets are received.

With each method, the port blocks traffic when the rising threshold is reached. The port remains blocked until the traffic rate drops below the falling threshold and then resumes normal forwarding. In general, the higher the level, the less effective the protection against broadcast storms.

---

**IMPORTANT** When the port threshold for multicast traffic is reached, all multicast traffic is blocked. An exception is management traffic, such as bridge protocol data unit (BDPU) and Cisco Discovery Protocol (CDP) frames.

---

The graph shows broadcast traffic patterns on an interface over a given time. The example can also be applied to multicast and unicast traffic. In this example, the broadcast traffic being forwarded exceeded the configured threshold between time intervals T1 and T2 and between T4 and T5. When the amount of specified traffic exceeds the threshold, all traffic of that kind is dropped for the next time period. Therefore, broadcast traffic is blocked during the intervals following T2 and T5. At the next time interval (for example, T3), if broadcast traffic does not exceed the threshold, it is again forwarded.

Figure 32 - Port Thresholds Example

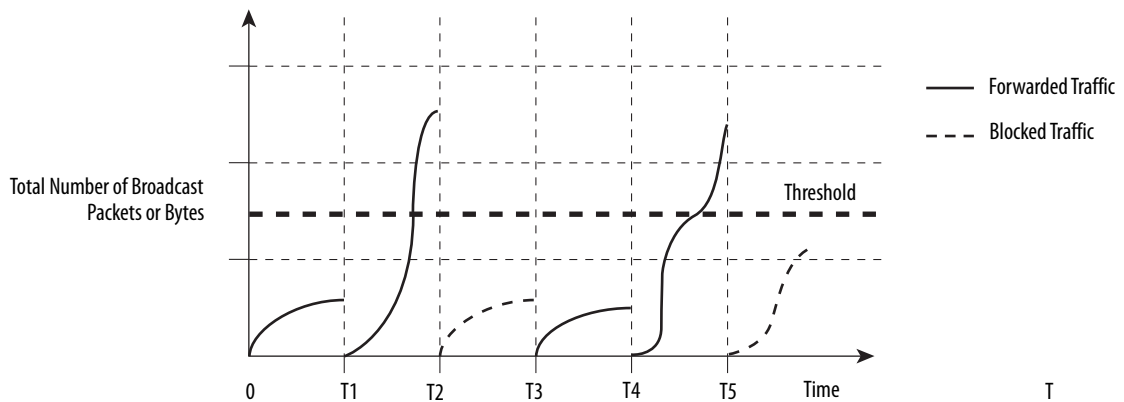

The combination of the storm-control suppression level and the 1-second time interval controls the way the port thresholds algorithm works. A higher threshold enables more packets to pass through. A threshold value of 100% means that no limit is placed on the traffic. A value of 0.0 means that all broadcast, multicast, or unicast traffic on that port is blocked.

---

**IMPORTANT** Because packets do not arrive at uniform intervals, the 1-second time interval during which traffic activity is measured can affect the behavior of port thresholds.

---

### Outgoing (rate limiting)

Outgoing port thresholds limit the rate at which the switch communicates with a client device as a percentage of wire speed. Limiting bandwidth to specific users and ports helps control network congestion, enable high performance, create efficient networks, and prevent a few devices from monopolizing network bandwidth. It can also improve reliability by limiting maximum bandwidth to end devices that are not capable of handling large amounts of traffic. From Device Manager or the Logix Designer application, you can enable or disable rate limiting on a per port basis.

### Default Port Thresholds Configuration

By default, incoming unicast, broadcast, and multicast port thresholds are disabled. Outgoing port thresholds are also disabled.

## Configure Port Thresholds via Device Manager

From the Configure menu, choose Port Thresholds.

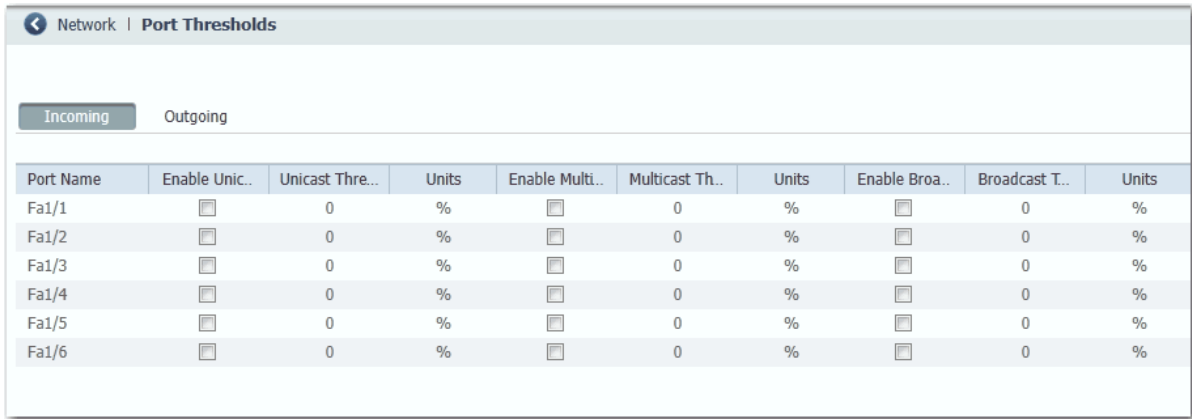

**Table 91 - Port Threshold Fields**

Field	Description
<b>Incoming</b>	
Unicast	For each port, do the following: 1. Check or clear the Enable checkbox. 2. Type the threshold value. 3. Choose one of these units: – PPS (0...10 billion) – BPS (0...10 billion) – % (0...100)
Multicast	
Broadcast	
<b>Outgoing</b>	
All Traffic	For each port, do the following: 1. Check or clear the Enable checkbox. 2. Type the threshold value. 3. Click Save.

## Configure Port Thresholds via the Logix Designer Application

You can configure threshold limits for broadcast, unicast, and multicast traffic for each active port. This feature is available only with Full firmware. The number of packets being sent is compared against the threshold value. These limits help to prevent a single device from sending too much traffic.

Figure 33 - Port Thresholds for Stratix 5400, Stratix 5410, Stratix 5700, and ArmorStratix 5700 Switches

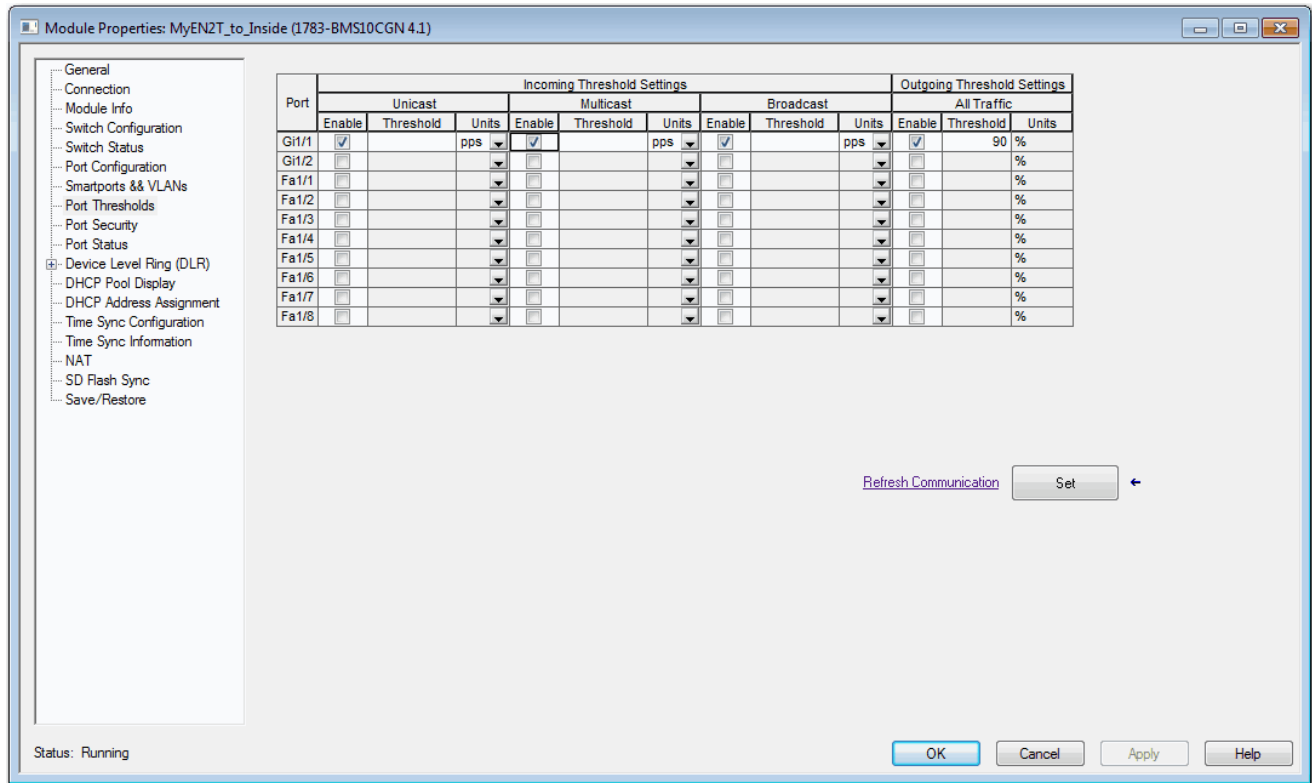
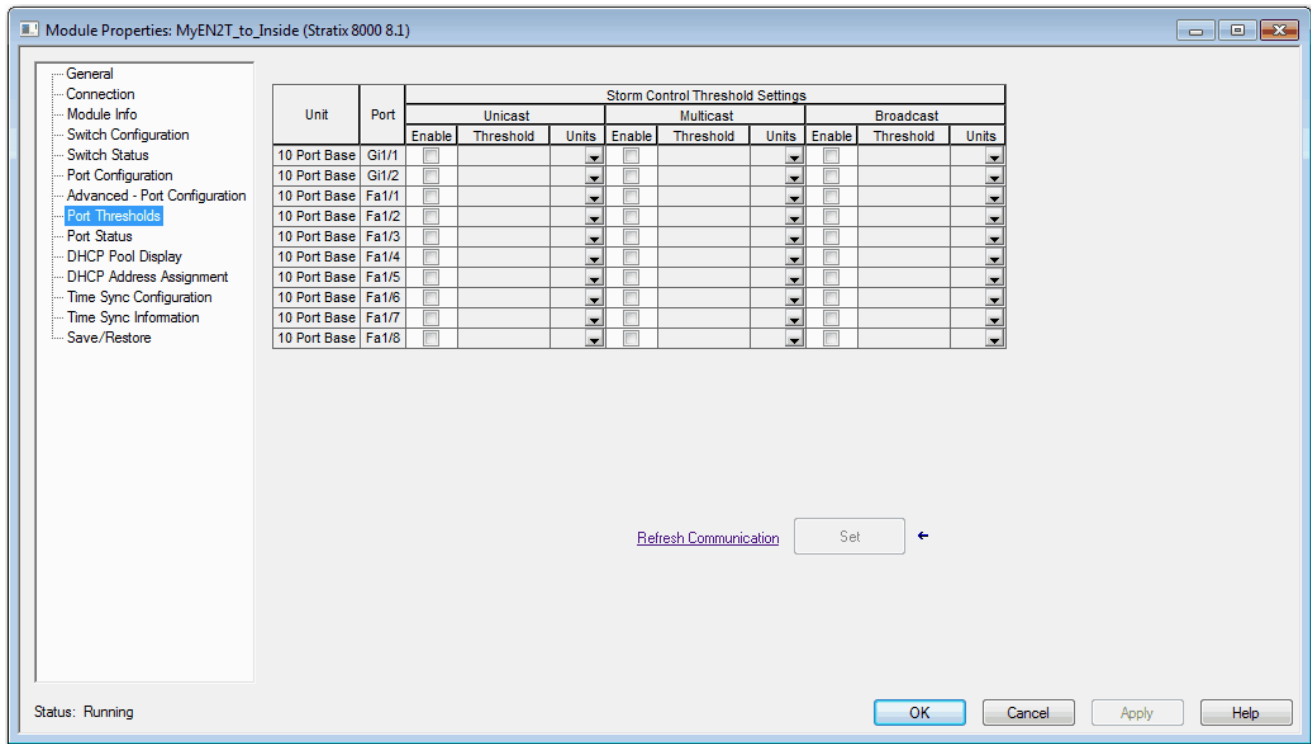

Table 92 - Port Threshold Fields for Stratix 5400, Stratix 5410, Stratix 5700, and ArmorStratix 5700 Switches

Field	Description
Port	The port selected for configuration. The port number includes the port type (Fa for Fast Ethernet and Gi for Gigabit Ethernet), and the specific port number. <b>EXAMPLE:</b> Gi1/1 is Gigabit Ethernet port 1.
Incoming Threshold Settings	Enable incoming thresholds and set the threshold values for the unicast, multicast, and broadcast traffic for each port. Valid values for units: <ul style="list-style-type: none"> <li>• Packets per second (pps)</li> <li>• Percentage of total bandwidth (%)</li> <li>• Bits per second (bps)</li> </ul>
Outgoing Threshold Settings	Enable outgoing thresholds and set the threshold values for the traffic for each port. Units % = Percentage of total bandwidth

**Figure 34 - Port Thresholds for Stratix 8000/8300 Switches**



**Table 93 - Port Threshold Fields for Stratix 8000/8300 Switches**

Field	Description
Unit	Indicates where the port resides: <ul style="list-style-type: none"> <li>• Base (for example, 1783-MS10T)</li> <li>• Expansion module (for example, 1783-MX08T)</li> </ul>
Port	Indicates the port that is selected for configuration. The port number includes the port type (Fa for Fast Ethernet and Gi for Gigabit Ethernet), the base or expansion module number (1, 2, or 3), and the specific port number. For example: <ul style="list-style-type: none"> <li>• Gi1/1 is Gigabit Ethernet port 1 on the base.</li> <li>• Fa2/1 is Fast Ethernet port 1 on the first expansion module.</li> </ul>
Storm Control Threshold Settings	Set the threshold values for the broadcast, unicast, and multicast traffic for each port. The number of packets being sent is compared against the threshold value. If an undesirable network event occurs and the threshold value has been exceeded, a Yes value appears on the Port Status view and in the Traffic Threshold Exceeded on Any Port field on the Switch Status view. Network traffic of the type that exceeded threshold (broadcast, unicast, or multicast) is dropped until it falls below the falling threshold. The falling threshold is automatically set to 5% less than the entered threshold value.
Broadcast, Unicast and Multicast	Complete these fields for each traffic type: <ul style="list-style-type: none"> <li>• Enable—Check to enable the storm control on the selected port. The respective threshold value and units are applied to the selected port when you click Set. Clear the checkbox to disable the storm control for the selected port. Zero is applied to the threshold value and units attributes when you click Set.</li> <li>• Threshold—Type the value for the threshold after you choose the unit of measurement:                             <ul style="list-style-type: none"> <li>– If Units is set to pps or bps, type a value between 0 . . . 10000000000.</li> <li>– If Units is set to %, type a value between 0 . . . 100.</li> </ul> </li> <li>• Units—Choose the unit of measurement for the threshold:                             <ul style="list-style-type: none"> <li>– pps (packets per second)</li> <li>– bps (bits per second)</li> <li>– %</li> </ul> </li> </ul>

## Power over Ethernet (PoE)

Switches and expansion modules with PoE ports are software-configurable and provide these features:

- Support for IEEE 802.3af (PoE)-compliant devices.
- Support for IEEE 802.3at Type 2 (PoE+), which increases the available power that can be drawn by powered devices from 15.4...30 W per port.
- Automatic detection and power budgeting. The switch maintains a power budget, monitors and tracks requests for power, and grants power only when it is available.
- Power to connected Cisco pre-standard and IEEE 802.3af-compliant powered devices if the switch detects that there is no power on the circuit.
- Support for Cisco Discovery Protocol (CDP) with power consumption. CDP applies only when using switches with Cisco end devices. The powered Cisco end device notifies the switch of the amount of power it is consuming. The switch can supply or remove power from the PoE port.
- Support for Cisco intelligent power management. A powered Cisco end device and the switch negotiate through power-negotiation CDP messages for an agreed power-consumption level. The negotiation allows a high-powered device consuming more than 7 W to operate at its highest power mode. The powered device first starts up in Low-power mode, consumes less than 7 W, and negotiates to obtain enough power to operate in High-power mode. The device changes to High-power mode only when it receives confirmation from the switch.

Cisco intelligent power management is backward-compatible with CDP with power consumption. The module responds according to the CDP message that it receives. CDP is not supported on third-party powered devices, so the module uses the IEEE classification to determine the power usage of the device.

- (Stratix 5410 switches) Support for high and low priority PoE/PoE+ ports. When two power-supply modules are installed, the system has enough power to support all ports as PoE/PoE+ ports. If one power-supply module fails, the system drops power to the low priority ports. Power to the high priority ports remains uninterrupted. If there is not enough power for one supply to support all high priority ports, ports are dropped by port number from highest to lowest port number.

PoE and PoE+ features are supported on switches and expansion modules with PoE ports when a correct power supply is connected to the switch.

Configuration options include the following:

- Limit the total power supported.
- Configure mode and power settings for individual ports.

For most applications, the default configuration (Auto mode) is sufficient and no further configuration is required. However, you can customize the settings to meet your needs. For example, be sure that power is pre-allocated to a specific port, set the port mode to Static. As another example, to disallow high-power devices on a port, set the mode to Auto and specify a maximum power limit.

---

**IMPORTANT** When you make PoE configuration changes to a port, the port drops power. Whether the port powers up again depends on the new configuration, the state of the other PoE ports, and the state of the power budget.

For example, if port 1 is in Auto mode and the On state, and you configure it for Static mode, the switch removes power from port 1, detects the powered device, and repowers the port.

If port 1 is in Auto mode and the On state and you configure it with a maximum wattage of 10 W, the switch removes power from the port and then redetects the powered device. The switch repowers the port only if the powered device is a Class 1, Class 2, or a Cisco-only powered device.

---

## Powered Device Detection and Initial Power Allocation

A switch or expansion module detects a powered device when a port with PoE capability is active, PoE is enabled (the default), and the connected device is not powered by another power source.

After device detection, the switch determines the device power requirements that are based on its type:

- The switch classifies the detected 802.3 af/at compliant IEEE device within a power consumption class. Based on the available power in the power budget, the switch determines if a PoE port can be powered. [Table 94](#) lists these levels.

**Table 94 - IEEE Power Classifications**

Class	Power Supplied per Port, Max
0 (class status unknown)	15.4 W
1	4 W
2	7 W
3	15.4 W
4	30 W PoE+ devices only

- A Cisco pre-standard powered device does not provide its power requirement when the switch detects it. A port that is not configured for PoE+ allocates 15.4 W as the initial allocation for power budgeting. A port that is configured for a PoE+ switch allocates 30 W.

The initial power allocation is the maximum amount of power that a powered device requires. The switch initially allocates this amount of power when it detects and powers the powered device. As the powered device negotiates power levels with the module through CDP power-negotiation messages, the initial power allocation can be adjusted.

The switch monitors and tracks requests for power and grants power only when it is available. The switch tracks its power budget, which is the amount of power available on each PoE port. The switch performs power-accounting calculations when a port is granted or denied power to keep the power budget up to date.

After power is applied to a PoE port, the switch uses CDP (if CDP is supported by the powered Cisco end device) to determine the actual power consumption requirement of the connected powered devices. The switch adjusts the power budget accordingly. The switch processes a request and either grants or denies power. If the request is granted, the switch updates the power budget. If the request is denied, the switch verifies that power to the port is turned off, generates a syslog message, and updates the status indicators. Powered devices can also negotiate with the module for more power.

If the switch detects a fault that is caused by an undervoltage, overvoltage, overtemperature, oscillator-fault, or short-circuit condition, it does the following:

- Turns off power to the port
- Generates a syslog message
- Updates the power budget and status indicators

## Power Management Modes

PoE ports support these modes:

- Auto (default)—The port automatically detects if the connected device requires power. If the port discovers a connected powered device and the module has enough power, the port does the following:
  - Grants power
  - Updates the power budget
  - Turns on power to the port on a first-come, first-served basis
  - Updates the status indicators



If enough power is available for all powered devices that are connected to the switch, power is turned on to all devices. If there is not enough power to accommodate all connected devices and if a device is reconnected while other devices are waiting for power, it cannot be determined which devices are granted or are denied power.

If granting power exceeds the system power budget, the switch denies power, verifies that power to the port is turned off, generates a syslog message, and updates the status indicators. After power has been denied, the switch periodically rechecks the power budget and continues to attempt to grant the request for power.

If a device being powered by the switch is then connected to wall power, the switch can continue to power the device. The switch can continue to report that it is still powering the device whether the device is being powered by the switch or receiving power from an AC power source.

If a powered device is removed, the switch automatically detects the disconnect and removes power from the port. You can connect a nonpowered device without damaging it.

You can specify the maximum wattage that is allowed on the port. If the IEEE-class maximum wattage of the powered device is greater than the configured maximum value, the switch does not provide power to the port. If the switch powers a Cisco end device, but the device later requests through CDP messages more than the configured maximum value, the switch removes power to the port. The power that was allocated to the powered device is reclaimed into the global power budget. If you do not specify a wattage, the switch delivers the maximum value.

- **Static**—The switch pre-allocates power to the port even when no powered device is connected and makes sure that power is available for the port. The switch allocates the port-configured maximum wattage, and the amount is never adjusted through the IEEE class or by CDP messages from a powered Cisco end device. Because power is pre-allocated, any powered device that uses less than or equal to the maximum wattage is guaranteed to be powered when it is connected to the static port. The port no longer participates in the first-come, first-served model.

However, if the powered-device IEEE class is greater than the maximum wattage, the switch does not supply power to it. If the switch learns through CDP messages that a powered Cisco end device needs more than the maximum wattage, the powered device is shut down.

If you do not specify a wattage, the switch pre-allocates the maximum value. The switch powers the port only if it discovers a powered device. Use the static setting on a high-priority interface.

- **Off**—The switch disables powered-device detection and never powers the PoE port, even if an unpowered device is connected. Use this mode only when you want to be sure that power is never applied to a PoE port, making the port a data-only port.

### *Maximum Power Allocation (Cutoff Power) on a PoE Port*

The switch determines the cutoff power on a PoE port in this order.

1. Manually when you configure the power level to budget for the port
2. Manually when you configure the power level that limits the power that is allocated to the port
3. Automatically when the switch sets the power usage of the device by using the IEEE classification and LLDP power negotiation or CDP power negotiation

If you do not manually configure the cutoff-power value, the switch can automatically determine the value by using CDP power negotiation when connected to a Cisco end device. If the switch cannot determine the value by using one of these methods, it uses the default value of 15.4 W.

With PoE+, if you do not manually configure the cutoff-power value, the switch determines it by using one of the following:

- The device IEEE classification and LLDP power negotiation
- CDP power negotiation with a Cisco end device

If CDP or LLDP is not enabled, the default value of 30 W is applied. However, without CDP or LLDP, the switch does not allow devices to consume more than 15.4 W of power. Values from 15,400...30,000 mW are allocated based on only CDP or LLDP requests. If a powered device consumes more than 15.4 W without CDP or LLDP negotiation, the device can be in violation of the maximum current limitation. The device can experience a fault for drawing more current than the maximum. The port remains in the fault state for a time before attempting to power on again. If the port continuously draws more than 15.4 W, the cycle repeats.

### *Power Consumption Values*

You can configure the initial power allocation and the maximum power allocation on a port. However, these values are only the configured values that determine when the switch turns on or turns off power on the PoE port. The maximum power allocation is not the same as the actual power consumption of the powered device. When you manually set the maximum power allocation, you must consider the power loss over the cable from the port to the powered device. The cutoff power is the sum of the rated power consumption of the powered device and the worst-case power loss over the cable.

The actual amount of power that is consumed by a powered device on a PoE port is the cutoff-power value plus a calibration factor of 500 mW (0.5 W). The actual cutoff value is approximate and varies from the configured value by a percentage of the configured value. For example, if the configured cutoff power is 12 W, the actual cutoff-value is 11.4 W, which is 0.05% less than the configured value.

Because the switch supports external removable power supplies for PoE/PoE+ and can configure the budget per the power supply that is used, the total amount of power available varies depending on the power supply configuration:

- If a power supply is removed and replaced by a new power supply with less power and there is insufficient power for the powered devices, power is denied to PoE ports that are in Auto mode. If there is still insufficient power, power is denied to PoE ports in Static mode. In both cases, power is denied in descending order of the port numbers.
- If the new power supply supports more power than the previous one, and more power is available, power is granted to the PoE ports in Static mode. If power is still available, the power is granted to PoE ports in Auto mode. In both cases, power is granted in ascending order of the port numbers.

---

**IMPORTANT** For power to be assigned accurately, the total wattage of the power supply must be manually configured via Device Manager or CIP.

---

## Configure PoE Ports via Device Manager

From the Configure menu, choose Power Management.

**Figure 35 - PoE Configuration for Stratix 5410 Switches**

Interface	Mode	Status	Power(Watts)	Max Power(Watts)	Override Power(Watts)	Device	Class	Power Priority
Gi1/1	Auto	Off	0.0	30.0	N/A	N/A	N/A	Low
Gi1/2	Auto	Off	0.0	30.0	N/A	N/A	N/A	Low
Gi1/3	Auto	Off	0.0	30.0	N/A	N/A	N/A	Low
Gi1/4	Auto	Off	0.0	30.0	N/A	N/A	N/A	Low
Gi1/5	Auto	Off	0.0	30.0	N/A	N/A	N/A	Low
Gi1/6	Auto	Off	0.0	30.0	N/A	N/A	N/A	Low
Gi1/7	Auto	Off	0.0	30.0	N/A	N/A	N/A	Low

Figure 36 - PoE Configuration for Stratix 5400, Stratix 5700, and ArmorStratix 5700 Switches

Network | Power Management

Total Power Supported:  (Watts)

Total Power Used: 0.0 (Watts)

Total Power Available: 65.0 (Watts)

Interface	Mode	Status	Power(Watts)	Max Power(Watts)	Override Power(Watts)	Device	Class
Fa1/1	Auto	Off	0.0	30.0	N/A	N/A	N/A
Fa1/3	Auto	Off	0.0	30.0	N/A	N/A	N/A
Fa1/5	Auto	Off	0.0	30.0	N/A	N/A	N/A
Fa1/7	Auto	Off	0.0	30.0	N/A	N/A	N/A

Figure 37 - PoE Configuration for Stratix 8000/8300 Switches

Network | Power Management

Selected Module:

Total Power Supported:  (Watts)

Total Power Used: 0.0 (Watts)

Total Power Available: 00.0 (Watts)

PoE Interface Table

Edit

Interface	Mode	Status	Power(Watts)	Max Power(Watts)	Override Power(Watts)	Device	Class
<input type="radio"/> Fa3/1	Auto	Off	0.0	30.0	N/A	N/A	N/A
<input type="radio"/> Fa3/2	Auto	Off	0.0	30.0	N/A	N/A	N/A
<input type="radio"/> Fa3/3	Auto	Off	0.0	30.0	N/A	N/A	N/A
<input type="radio"/> Fa3/4	Auto	Off	0.0	30.0	N/A	N/A	N/A

Table 95 - Power Management Fields

Field	Description
Selected Module (Stratix 8000/8300 switches)	Choose a connected PoE module for which to view status information: <ul style="list-style-type: none"> <li>• 2—Module in the left position</li> <li>• 3—Module in the right position</li> </ul>
Total Power Supported	To limit the total PoE power budget, type an appropriate value that is based on the power source: <ul style="list-style-type: none"> <li>• A 48V power source supports a maximum of 65 W.</li> <li>• A 54V power source supports a maximum of 130 W.</li> </ul> When you save this setting, it changes the total PoE power budget and resets the powered devices to meet the new budget. <p><b>IMPORTANT:</b> A mismatch between the total power that is supported and the power supply can cause damage to the switch. Take care not to oversubscribe the power supply:</p> <ul style="list-style-type: none"> <li>• If you intend to connect to a power supply that allows more wattage than configured, change the power supply and then specify the total power supported.</li> <li>• If you intend to connect to a power supply that allows less wattage than configured, change the total power that is supported to an appropriate value and then change the power supply.</li> </ul>
Total Power Used	Displays the amount of power the module is using.
Total Power Available	Displays the amount of unused power available to the module.
Interface	Displays the port number.

**Table 95 - Power Management Fields (Continued)**

Field	Description
Mode	<p>Displays the Power Management mode of the port:</p> <ul style="list-style-type: none"> <li>• Auto—(Default) Enables the detection of powered devices and automatically allocates power to the PoE port if a device is connected. To limit the power that is used by this port, adjust the Max Power setting.</li> <li>• Static—Reserves power for this port even when no device is connected to make sure that power is provided upon device detection. You can also choose Static mode to pre-allocate power to a specific port. The switch allocates power to Static mode ports before it allocates power to Auto mode ports.</li> <li>• Off—PoE is disabled.</li> </ul> <p>For more information, see <a href="#">Power Management Modes on page 240</a>.</p>
Status	Displays whether PoE is enabled (on) or disabled (off) on the port.
Power (Watts)	Displays the amount of power that is allocated to the port.
Max Power (Watts)	<p>Displays the maximum amount of power available to the port:</p> <p>PoE ports: 4 . . . 15.4 W</p> <p>PoE+ ports: 4 . . . 30 W</p>
Override Power (Watts)	<p>Indicates the power override configured for the port. This configuration overrides both the IEEE classification that is shown in the Class column and power negotiation. If no override is configured, the field displays N/A.</p> <p>You can configure a power override only by using the Command-line interface (CLI). For more information, see the Cisco IE-3000 Software Configuration Guide.</p> <p><b>EXAMPLE:</b> An administrator can choose to configure an override when the power requirement of a connected device is known and is less than the maximum value for the class. For instance, if a device requires only 5 W but is in Class 0, which allows a maximum of 15.4 W, configuring an override allows more power to other devices.</p>
Device	Displays the device that is connected to the port. If no device is connected to the port, the field displays N/A.
Class	<p>Displays the power classification of the powered device (PD).</p> <p>For power classification descriptions, see <a href="#">Table 94 on page 239</a>.</p>
Power Priority (Stratix 5410 switches)	<p>Choose a power priority to assign to the port if there is a reduced power budget, such as a power supply failure. The system selectively removes PoE power and shuts down lower priority ports to keep higher priority ports active. When multiple ports have the same priority level, ports are shut down from highest port number to lowest port number. The system removes power from only the number of ports necessary to maintain system operation without power cycling or other such disruptive results.</p> <ul style="list-style-type: none"> <li>• Low (default)</li> <li>• High</li> </ul>

## Configure PoE via the Logix Designer Application

In the navigation pane, click PoE.

Figure 38 - PoE Configuration for Stratix 5410 Switches

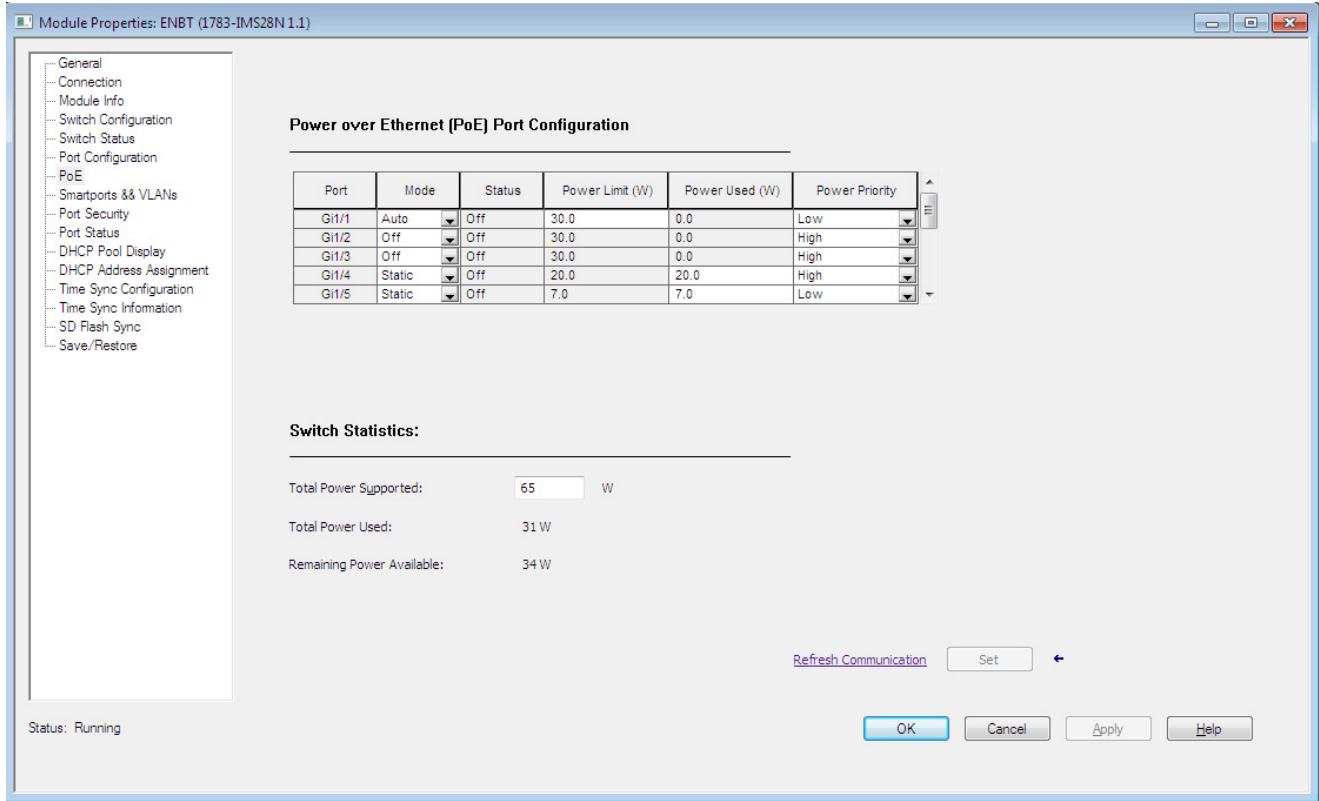

**Figure 39 - PoE Configuration for Stratix 5400, Stratix 5700, and ArmorStratix 5700 Switches**

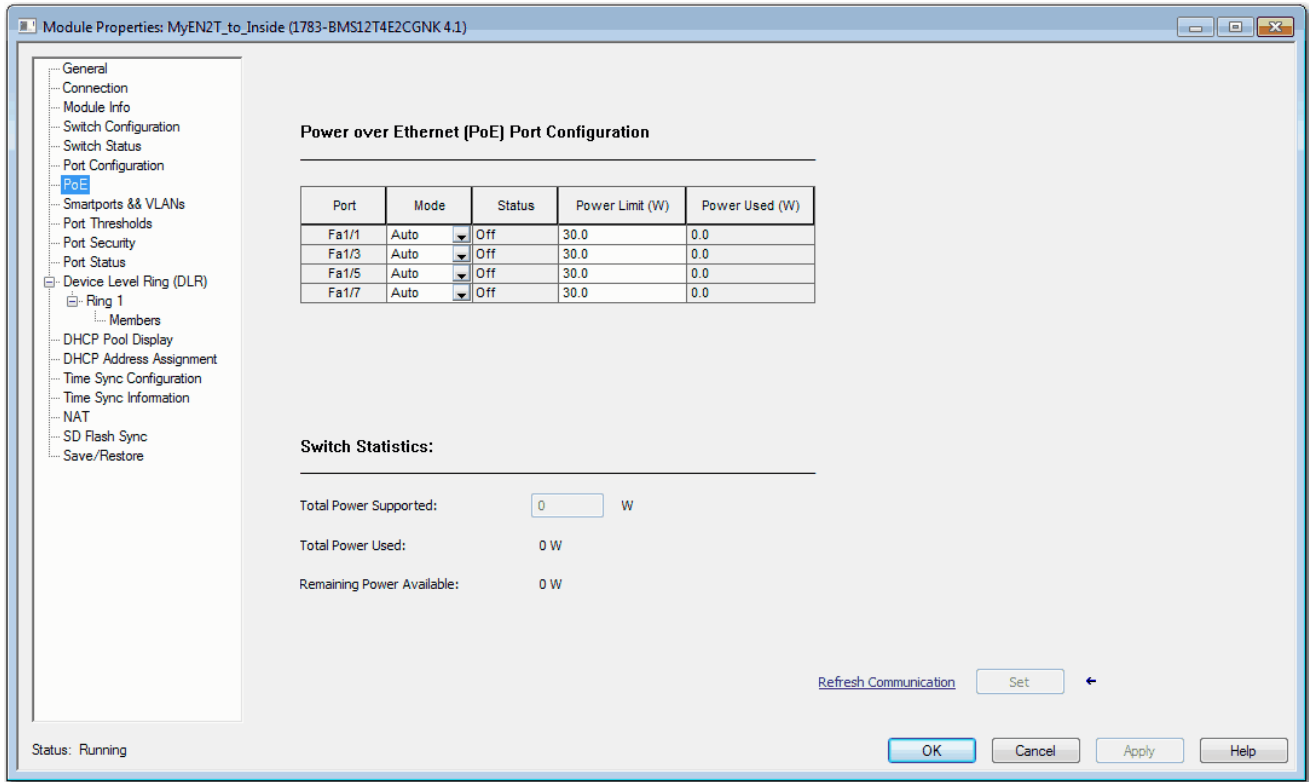

**Figure 40 - PoE Configuration for Stratix 8000/8300 Switches**

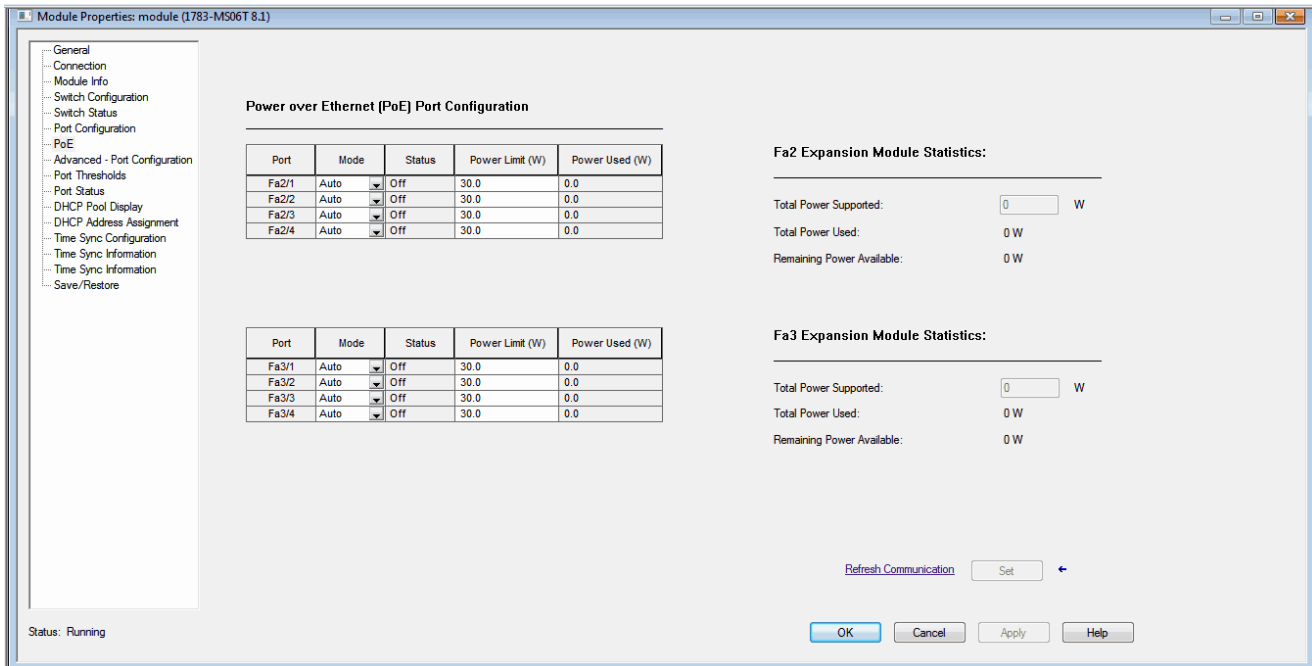

Table 96 - PoE Fields

Field	Description
<b>Power over Ethernet (PoE) Port Configuration</b>	
Port	Displays the port number.
Mode	<p>Displays the Power Management mode of the port:</p> <ul style="list-style-type: none"> <li>• Auto—Enables the detection of powered devices and automatically allocates power to the PoE port if a device is connected. This setting is selected by default. To limit the power that is used by this port, adjust the value Power Limit field.</li> <li>• Static—Reserves power for this port even when no device is connected to make sure that power is provided upon device detection. You can also choose Static mode to pre-allocate power to a specific port. The device allocates power to Static mode ports before it allocates power to Auto mode ports.</li> <li>• Off—PoE is disabled.</li> </ul> <p>For more information, see <a href="#">Power Management Modes on page 240</a>.</p>
Status	<p>Displays the status of the port:</p> <ul style="list-style-type: none"> <li>• 0—The status is unknown.</li> <li>• 1—PoE is enabled. Power is supplied to the port with no errors.</li> <li>• 2—PoE is not enabled. Power is not supplied to the port.</li> <li>• 3—PoE is enabled, but the device denied power to the port.</li> <li>• 4—PoE is enabled, but a system fault occurred while power was supplied to the port.</li> <li>• 5—PoE is enabled, but the port overdraw power.</li> </ul>
Power Limit (W)	<p>Displays the maximum amount of power available to the port:</p> <p>PoE ports: 4 . . . 15.4 W                      PoE+ ports: 4 . . . 30 W</p> <p>If the port is in Auto mode, you can enter a value. The default value is 15.4 W.</p>
Power Used (W)	<p>Displays the amount of power currently in use by the port.</p> <p>If the port is in Auto mode, the default value is 15.4 W.</p> <p>If the port is in Static mode, you can enter a value to reserve power for the port.</p>
Power Priority (Stratix 5410 switches)	<p>Choose a power priority to assign to the port if there is a reduced power budget, such as a power supply failure. The system selectively removes PoE power and shuts down lower priority ports to keep higher priority ports active. When multiple ports have the same priority level, ports are shut down from highest port number to lowest port number. The system removes power from only the number of ports necessary to maintain system operation without power cycling or other such disruptive results.</p> <ul style="list-style-type: none"> <li>• Low (default)</li> <li>• High</li> </ul>
<b>Switch/Expansion Module Statistics</b>	
Total Power Supported	<p>To limit the total PoE power budget, type an appropriate value that is based on the power source:</p> <ul style="list-style-type: none"> <li>• A 48V power source supports a maximum of 65 W.</li> <li>• A 54V power source supports a maximum of 130 W.</li> </ul> <p>For Stratix 5410 switches use the following values:</p> <ul style="list-style-type: none"> <li>• One power supply supports a maximum of 65 W.</li> <li>• Two power supplies support a maximum of 185 W.</li> </ul> <p>When you save this setting, it changes the total PoE power budget and resets the powered devices to meet the new budget.</p> <p><b>IMPORTANT:</b> A mismatch between the total power that is supported and the power supply can cause damage to the device. Take care not to oversubscribe the power supply:</p> <ul style="list-style-type: none"> <li>• If you intend to connect to a power supply that allows more wattage than configured, change the power supply and then specify the total power supported.</li> <li>• If you intend to connect to a power supply that allows less wattage than configured, change the total power that is supported to an appropriate value. Then change the power supply.</li> </ul>
Total Power Used	Displays the amount of power in watts the device is using.
Remaining Power Available	Displays the amount of unused power in watts available to the device.



## PROFINET

PROFINET is the PROFIBUS International (PI) open Industrial Ethernet Standard that uses TCP/IP and IT standards for automation control.

Stratix switches support the following PROFINET features:

- All switches support the forwarding of these PROFINET traffic types:
  - TCP/IP
  - Real-Time (RT)

Stratix switches do not support the forwarding of Isochronous Real-Time (IRT) traffic.

- Stratix 5700 and ArmorStratix 5700 switches support PROFINET management via General Station Description (GSD).

PROFINET conformance classes define the capabilities of a device. All Stratix switches are Conformance Class B certified.

### Configure PROFINET Traffic Forwarding

PROFINET traffic forwarding requires that the switch is configured for VLAN 0 priority tagging:

- In IOS Release 15.2(6)E0a and later, PROFINET traffic is configured for VLAN 0 tagging by default and no configuration is required. You can change the default configuration on the Edit Physical Port page in Device Manager. See [page 51](#).
- In IOS Release 15.2(5)EA.fc4 and earlier, use the CLI to configure VLAN 0 priority tagging for PROFINET support. By default, VLAN 0 is disabled.

For more information about VLAN 0 priority tagging, see [page 286](#).

To configure VLAN 0 priority tagging to support PROFINET in IOS 15.2(5)EA.fc4 and earlier, follow these steps.

1. Start a CLI session.

For more information about using the CLI, see [page 73](#).

2. At the prompt, connect to the switch by entering the switch user name and password.
3. Enter privileged EXEC mode: Type **enable**, and then press Enter.

In privileged EXEC mode, the CLI prompt ends with a pound sign as follows: Switch#

4. Enter global configuration mode: Type **configure terminal**, and then press Enter.

5. To configure VLAN 0 priority tagging on an access port, type the commands in [Table 97](#).

or

To configure VLAN 0 priority tagging on a trunk port, type the commands in [Table 98](#).

For a tagging on a trunk port, be sure that the switch uses the IEEE 802.1Q (DOT1Q) standard.

Press Enter to execute each command.

**Table 97 - CLI Commands for VLAN 0 Priority Tagging—Access Ports**

	Command	Description
Step 1	interface [interface id]	Identifies the port on which to forward PROFINET traffic.
Step 2	switchport mode access	Configures the port as an access port.
Step 3	switchport voice vlan [vlan id]	Configures the voice VLAN as the PROFINET VLAN.
Step 4	spanning-tree portfast	Enables PortFast on the port.
Example	<pre>Switch(config)#interface fa1/3 Switch(config-if)#switchport mode access Switch(config-if)#switchport voice vlan 10 Switch(config-if)#spanning-tree portfast</pre>	

**Table 98 - CLI Commands for VLAN 0 Priority Tagging—Trunk Ports**

	Command	Description
Step 1	interface [interface id]	Identifies the port on which to forward PROFINET traffic.
Step 2	switchport trunk native [vlan id]	Configures the native VLAN as the PROFINET VLAN.
Step 3	switchport mode trunk	Configures the port as a trunk port.
Step 4	spanning-tree portfast	Enables PortFast on the port.
Example	<pre>Switch(config)#interface fa1/5 Switch(config-if)#switchport trunk native vlan 2 Switch(config-if)#switchport mode trunk Switch(config-if)#spanning-tree portfast</pre>	

## Configure a Stratix 5700 or ArmorStratix 5700 Switch for PROFINET Management

Stratix 5700 and ArmorStratix 5700 switches contain a PROFINET GSD (General Station Description) file that contains basic information about the switch for data exchange between the I/O controller, the I/O supervisor, and the I/O devices, including the switch. Each PROFINET I/O device must have an associated GSD file that describes the properties of the device and contains all this information required for configuration:

- Device identification information (device ID, vendor ID and name, product family, and number of ports)
- Number and types of connected modules
- Error text for diagnostic information
- Communication parameters for I/O devices, including the minimum cycle time, the reduction ratio, and the watch dog time
- Configuration data for the I/O modules, including speed, duplex, VLAN, port security information, alarms, and broadcast-rate-limiting thresholds
- Parameters configured for I/O modules

---

**IMPORTANT** You must use the GSD file that is associated with the IOS release on the switch to manage your PROFINET network. To verify that the GSD file on the switch matches the GSD file in your controller configuration software, see [Verify the GSD File on page 254](#).

---

The GSD file name includes the last modification date and represents the version of the file, for example GSDML\_V2.32-Rockwell-S5700-xxxxxx where xxxxx is the modification date. The date is updated when changes are made to the GSD file with each IOS release.

Stratix 5700 and ArmorStratix 5700 switches store the GSD file and image files of the switch models in a file named Rockwell\_S5700\_GSD.zip. The file is located in the IOS folder on the switch.

To configure a Stratix 5700 or ArmorStratix 5700 switch for PROFINET management, use this process. By default, PROFINET is disabled.

1. Download the GSD file from the switch.
  - a. In the IOS folder on the switch, locate the Rockwell\_S5700\_GSD.zip file.
  - b. Extract the GSD file in .xml format and the associated image files in .bmp format.

2. Install the GSD file to your controller configuration software.

A single GSD file adds all Stratix 5700 and ArmorStratix 5700 catalog numbers to the hardware catalog in your controller configuration software.

3. Add the Stratix switch to use for PROFINET management to your controller project.
4. In the device configuration of your controller project, enter a PROFINET device name.

---

**IMPORTANT** To enable PROFINET, you need to know the PROFINET device name exactly as it appears in your controller project.

---

5. To use combo ports on the switch for PROFINET, add the ports to the device configuration in your controller project.
6. Start a CLI session.

For more information about using the CLI, see [page 73](#).
7. At the prompt, connect to the switch by entering the switch user name and password.
8. Enter privileged EXEC mode: Type **enable**, and then press Enter.

In privileged EXEC mode, the CLI prompt ends with a pound sign as follows: Switch#
9. Enter global configuration mode: Type **configure terminal**, and then press Enter.
10. To enable PROFINET on the switch, type the commands in [Table 99](#). Press Enter to execute each command.

**Table 99 - CLI Commands to Enable PROFINET**

	Command	Description
Step 1	profinet	Enables PROFINET on the switch.
Step 2	profinet id [PROFINET device name]	Sets the PROFINET device identifier (ID). <b>IMPORTANT:</b> This ID must match the PROFINET device name you specified for the switch in your controller project. The maximum length is 240 characters. The only special characters allowed are the period (.) and hyphen (-), and they are allowed only in specific positions within the ID string. It can have multiple labels within the string. Each label can be from 1 to 63 characters, and labels must be separated by a period (.). The final character in the string must not be zero (0). For more details about configuring the PROFINET ID, see the PROFINET specification, document number TC2-06-0007a, filename PN-AL-protocol_2722_V22_Oct07, available from <a href="#">PROFIBUS</a> .
Step 3	profinet vlan [vlan id]	(Optional). Changes the VLAN number. The default VLAN number is 1. The VLAN ID range is 1 . . . 4094.
Step 4	end	Returns to privileged EXEC mode.
Step 5	show running-config	Verifies your entries.
Step 6	copy running-config startup-config	(Optional). Saves your entries in the configuration file.
Example	<pre>Switch(config)#profinet Switch(config)#profinet id my10cgn Switch(config)#end Switch#show running-config</pre>	

## Verify the GSD File

To verify that the GSD file for the switch matches the GSD file in the controller configuration software, do the following.

1. Establish a connection between the switch and the I/O controller.
2. Start a CLI session.
3. Enter the following command in the CLI and press Enter:

**show profinet status**

As shown in the following example, the GSD version line shows whether the GSD file is a match or mismatch.

```
Switch1#show profinet stat
Profinet                : Enabled
Connection Status      : Connected
Vlan                    : 1
Profinet ID             : my10cgn
GSD version             : Match
Reduct Ratio           : 128
Switch1#
```

## Monitor and Maintain PROFINET

Use the following commands in the CLI to display the PROFINET configuration.

Command	Purpose
show profinet sessions	Displays the currently connected PROFINET sessions.
show profinet status	Displays the status of the PROFINET subsystem.
show lldp neighbor interface x/x detail	Displays information about the adjacent interface.

## Resilient Ethernet Protocol (REP)

REP provides an alternative to Spanning Tree Protocol (STP) to control network rings and loops, handle link failures, and improve convergence time. REP controls a group of ports that are connected in a segment, makes sure that the segment does not create any bridging loops, and responds to link failures within the segment. REP provides a basis for constructing more complex networks and supports VLAN load balancing.

REP is a segment protocol. One REP segment is a chain of ports that are connected to each other and configured with a segment ID. Each segment consists of standard (transit) segment ports and two user-configured edge ports. A switch can have no more than two ports that belong to the same segment, and each segment port can have only one external neighbor. A segment can go through a shared medium; however, on any link, only two ports can belong to the same segment. REP is supported only on Layer 2 trunk interfaces. Selecting the Switch for Automation Smartport enables Layer 2 trunking. REP is supported on EtherChannels, but not on an individual port that belongs to an EtherChannel.

You can construct almost any type of network that is based on REP segments. REP also supports VLAN load-balancing, controlled by the primary edge port but occurring at any port in the segment.

These types of REP ports are selectable in Device Manager:

- **Primary**—This port is a primary edge port. This port always participates in VLAN load balancing in the REP segment.
- **Edge**—This port is a secondary edge port. It also participates in VLAN load balancing in the REP segment.

Edge ports are termination points of an REP segment. You must configure two edge ports, including one primary edge port, for each REP segment. Entering edge without primary configures the port as a secondary edge port. Primary and secondary edge ports must be configured even if support of VLAN balancing is not required.

- **Transit**—This port is a non-edge port in the REP segment.
- **No-Neighbor Primary**—This port is a primary edge port connected a non-REP switch.
- **No-Neighbor**—This port is a secondary edge port that is connected to a non-REP switch.

The no-neighbor edge ports contain all properties of regular edge ports. These ports enable the construction of a REP ring containing a switch that does not support REP protocol.

- **None**—This port is not part of the REP segment.

REP and STP can coexist on the same switch, but not on the same port. REP does not interact with STP. For example, if a port is configured as an REP port, STP is disabled on that port. STP bridge protocol data units (BPDUs) are not accepted on or sent from REP ports. However, adjacent REP and STP rings or domains can share a common link. This common link can be used for passing REP and STP data plane traffic, or for the STP control plane traffic.

Figure 41 shows an example of a segment consisting of six ports that are spread across four switches. Ports E1 and E2 are configured as edge ports. When all ports are operational (as in the segment on the left), one port is blocked, shown by the diagonal line. When there is a failure in the network, as shown in the diagram on the right, the blocked port returns to the forwarding state to minimize network disruption.

### REP Open Segment

The segment that is shown in Figure 41 is an open segment. There is no connectivity between the two edge ports. The REP segment cannot cause a bridging loop and you can connect the segment edges to any network. All hosts that are connected to switches inside the segment have two possible connections to the rest of the network through the edge ports. However, only one connection is accessible at any time. If a failure causes a host to be unable to access its usual gateway, REP unblocks all ports to make sure that connectivity is available through the other gateway.

In the following example, E1 or E2 can be configured as the primary edge port.

Figure 41 - Open Segment Example

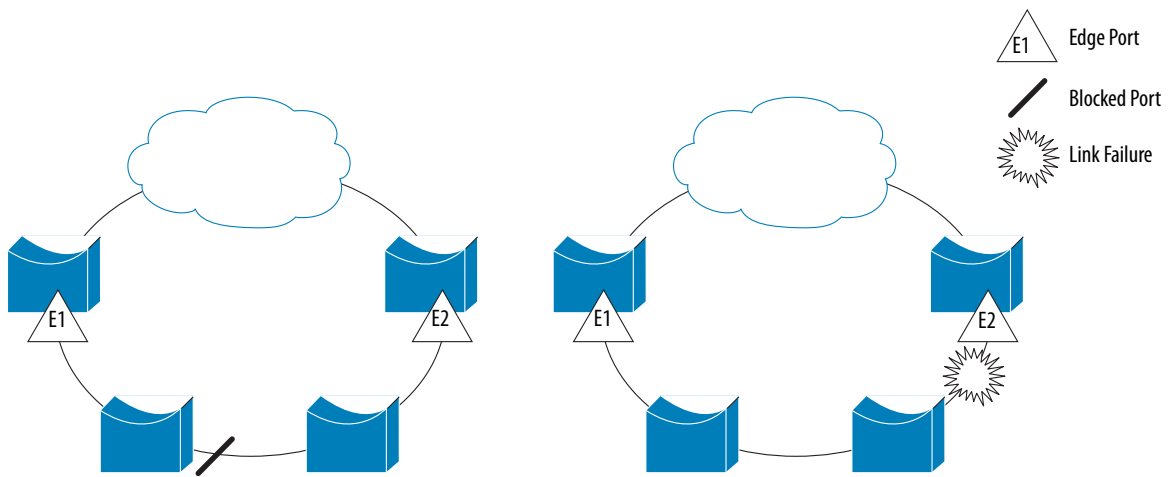

201888



## REP Ring Segment

The segment that is shown in [Figure 42](#), with both edge ports on the same switch, is a ring segment. In this configuration, there is connectivity between the edge ports through the segment. With this configuration, you can create a redundant connection between any two switches in the segment.

In the following figure, E1 or E2 can be configured as the primary edge port.

**Figure 42 - Ring Segment Example**

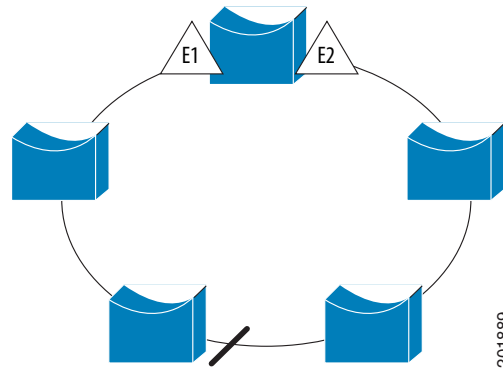

REP segments have these characteristics:

- If all ports in the segment are operational, one port (referred to as the alternate port) is in the blocked state for each VLAN.
- If VLAN load balancing is configured, two ports in the segment control the blocked state of VLANs.
- If one or more ports in a segment is not operational, causing a link failure, all ports forward traffic on all VLANs to support ongoing connectivity.
- In case of a link failure, the alternate ports are unblocked as quickly as possible. When the failed link comes back up, a logically blocked port per VLAN is selected with minimal disruption to the network.

## Access Ring Topologies

In access ring topologies, the neighboring switch cannot support REP, as shown in [Figure 43](#). In this case, you can configure the non-REP facing ports (E1 and E2) as edge no-neighbor ports. These ports inherit all properties of edge ports. You can configure them the same as any edge port, including configuring them to send STP or REP topology change notices to the aggregation switch. In this case, the STP topology change notice (TCN) that is sent is a multiple spanning-tree (MST) STP message.

In the example that is shown in [Figure 43](#), E1 or E2 can be configured as the primary no-neighbor port.

**Figure 43 - Ring Topology Example**

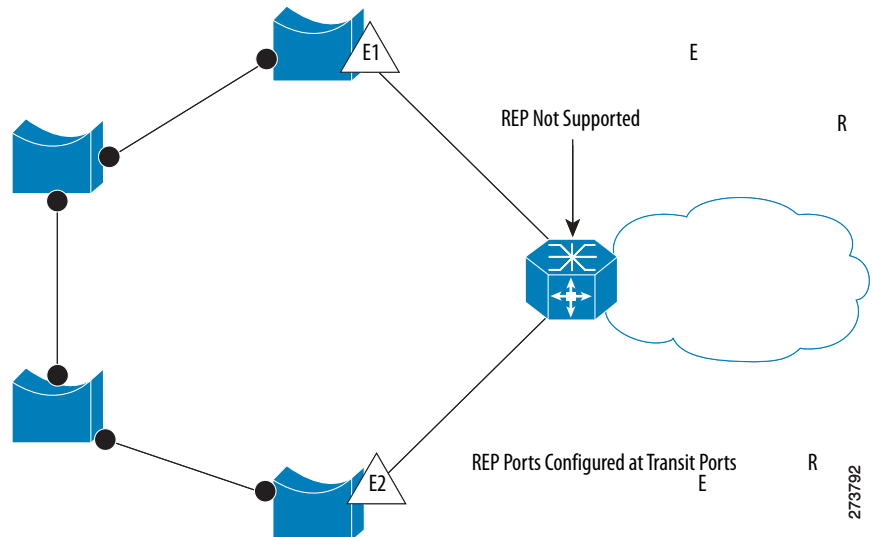

REP has these limitations:

- You must configure each segment port; an incorrect configuration can cause forwarding loops in the networks.
- REP can manage only one failed port within the segment; multiple port failures within the REP segment cause loss of network connectivity.

Configure REP in networks only with redundancy. Configuring REP in a network without redundancy causes loss of connectivity.

## Link Integrity

REP does not use an end-to-end polling mechanism between edge ports to verify link integrity. It implements local link failure detection. The REP Link Status Layer (LSL) detects its REP-aware neighbor and establishes connectivity within the segment. All VLANs are blocked on an interface until it detects the neighbor. After the neighbor is identified, REP determines the neighbor port to become the alternate port and which ports forward traffic.

Each port in a segment has a unique port ID. The port ID format is similar to the format used by the spanning tree algorithm: a port number (unique on the bridge), associated to a MAC ID (unique in the network). When a segment port is coming up, its LSL starts sending packets that include the segment ID and the port ID. The port is declared as operational after it performs a three-way handshake with a neighbor in the same segment.

## Configure REP via Device Manager

From the Configure menu, choose REP.

To create a REP segment, set a segment ID and port type for a switch port.

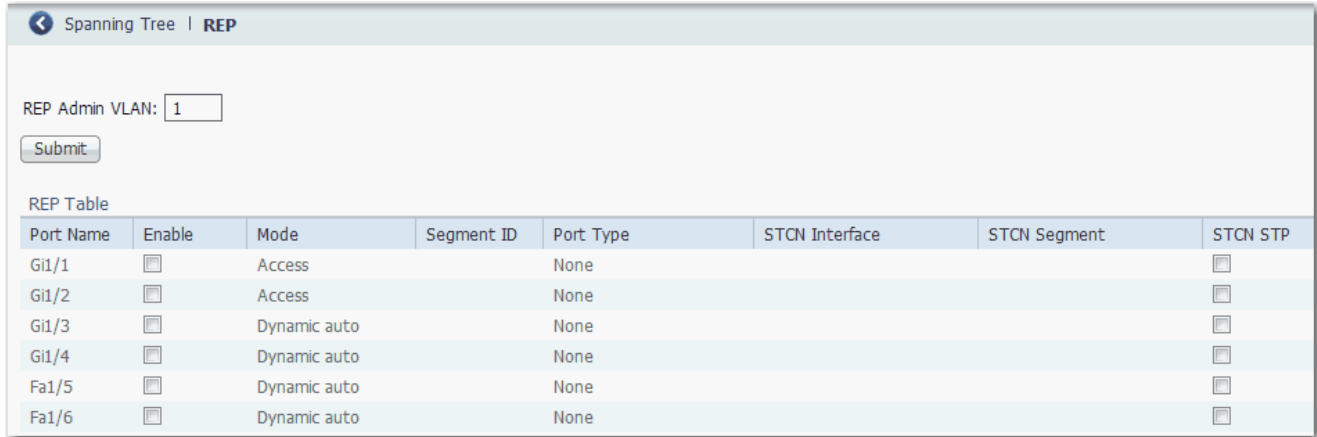

**Table 100 - REP Fields**

Field	Description
REP Admin VLAN	The administrative VLAN. The range is 2 . . . 4094. The default is VLAN 1. REP ports are assigned to the same REP Admin VLAN. If the REP Admin VLAN changes, all REP ports are automatically assigned to the new REP Admin VLAN.
Port Name	The number of the switch port, including port type (such as Fa for Fast Ethernet and Gi for Gigabit Ethernet).
Enable	If Enable is checked, REP is enabled on the port.
Mode	The administrative mode. To set this mode, from the Configure menu, choose Port Settings.
Segment ID	The ID of the segment. The segment ID range is from 1 . . . 1024. If no segment ID is set, REP is disabled.
Port Type	Each REP segment must have exactly two primary edge ports and can have secondary ports to use when a primary port fails. You can specify preferred primary and secondary ports. Configuring a port as preferred does not mean that it becomes the alternate port but gives it a slight edge among equal contenders. You can indicate that a port connects to switches that do not support REP. Choose one of these port types: <ul style="list-style-type: none"> <li>• Edge—A secondary edge port that participates in VLAN load balancing.</li> <li>• Edge no-neighbor—A secondary edge port that is connected to a non-REP switch.</li> <li>• Edge no-neighbor preferred—A secondary edge port that is connected to a non-REP switch and is the preferred alternate port for VLAN load balancing.</li> <li>• Edge no-neighbor primary—A secondary edge port that always participates in VLAN load balancing in this REP segment and is connected to a non-REP switch.</li> <li>• Edge no-neighbor primary preferred—An edge port that always participates in VLAN load balancing in this REP segment, is connected to a non-REP switch, and is the preferred port for VLAN load balancing.</li> <li>• Edge preferred—A secondary edge port that is the preferred alternate port for VLAN load balancing.</li> <li>• Edge primary—An edge port that always participates in VLAN load balancing in this REP segment.</li> <li>• Edge primary preferred—An edge port that always participates in VLAN load balancing in this REP segment and is the preferred port for VLAN load balancing.</li> <li>• None—This port is not part of the REP segment. The default is None.</li> <li>• Preferred—A secondary edge port that is the preferred alternate port for VLAN load balancing.</li> </ul>

**Table 100 - REP Fields (Continued)**

Field	Description
STCN Interface	Optionally, configure the port to send Segment Topology Change Notices (STCNs) when the topology changes. If you configure this option, also specify the segment ID that receives the STCNs from this port. The default is None. TCNs are used within the segment to notify REP neighbors of topology changes. At the edge of the segment, REP can propagate the notification to the STP or to the other REP segments.
STCN Segment	Configure STCNs to a segment ID. The valid range is 1 . . . 1024. You can also configure a sequence of segments.
STCN STP	Check STCN STP to send STCNs to STP networks. Be sure that the connection is at the segment edge. An STP connection that is not at the edge could cause a bridging loop because STP does not run on REP segments. All STP BPDUs are dropped at REP interfaces. By default, the checkbox is cleared.

## Routing, Layer 3

Layer 3 routing is available on the following switches:

- Stratix 5400 with Layer 3 firmware
- Stratix 5410 with Layer 3 firmware
- Stratix 8300 base units

Layer 3 routing uses IP address information to map subnetworks to an individual VLAN. In some network environments, VLANs are associated with individual networks or subnets. In an IP network, each subnet is mapped to an individual VLAN. Configuring VLANs helps control the size of the broadcast domain and keeps local traffic local. However, network devices in different VLANs cannot communicate with one another without a Layer 3 device to route traffic between the VLAN, referred to as inter-VLAN routing. You configure one or more Layer 3 capable switches to route traffic to the appropriate destination VLAN.

[Figure 44](#) shows a basic routing topology.

**Figure 44 - Example of Routing Topology**

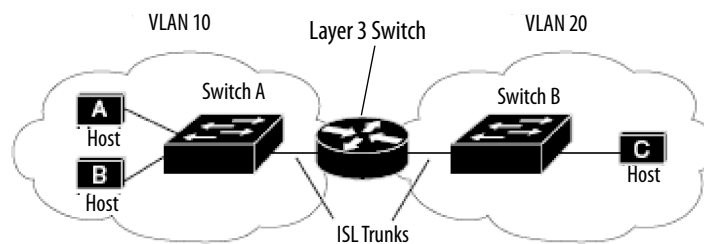

Switch A is in VLAN 10, and Switch B is in VLAN 20. The Layer 3 switch has an interface in each VLAN.

When Host A in VLAN 10 communicates with Host B in VLAN 10, it sends a packet that is addressed to that host. Switch A forwards the packet directly to Host B, without sending it to the Layer 3 switch.

When Host A sends a packet to Host C in VLAN 20, Switch A forwards the packet to the Layer 3 switch, which receives the traffic on the VLAN 10 interface. The Layer 3 switch checks the routing table, finds the correct outgoing interface, and forwards the packet on the VLAN 20 interface to Switch B. Switch B receives the packet and forwards it to Host C.

Stratix switches that support Layer 3 routing can route packets by using these methods.

**Table 101 - Routing Methods**

Feature	Description
EIGRP	See <a href="#">Enhanced Interior Gateway Routing Protocol (EIGRP) on page 140</a> .
OSPF	See <a href="#">Open Shortest Path First (OSPF) Routing Protocol on page 212</a> .
Static and connected routing	See <a href="#">Routing, Static and Connected on page 262</a> .
Dynamic routing	<p>Dynamic routing protocols are used by Layer 3 switches to calculate dynamically the best route for forwarding traffic. There are two types of dynamic routing protocols:</p> <ul style="list-style-type: none"> <li>Distance-vector protocols</li> <li>Link-state protocols</li> </ul> <p>Layer 3 switches using distance-vector protocols maintain routing tables with distance values of networked resources, and periodically pass these tables to their neighbors. Distance-vector protocols use one or a series of metrics for calculating the best routes. These protocols are easy to configure and use.</p> <p>The switch supports these distance-vector protocols:</p> <ul style="list-style-type: none"> <li>Routing Information Protocol (RIP), which uses a distance metric (cost) to determine the best path</li> <li>Border Gateway Protocol (BGP), which adds a path vector mechanism</li> </ul> <p>The switch also supports the Open Shortest Path First (OSPF) link-state protocol and Enhanced IGRP (EIGRP). The features add link-state routing features to traditional Interior Gateway Routing Protocol (IGRP) to improve efficiency.</p> <p>Routers that use link-state protocols maintain a complex database of network topology, which is based on the exchange of link-state advertisements (LSAs) between routers. An event in the network triggers LSAs, which speed up the convergence time or time that is required to respond to these changes. Link-state protocols respond quickly to topology changes, but require greater bandwidth and more resources than distance-vector protocols</p>
Unicast routing	Unicast routing is used for all network processes where a private or unique resource is requested.
Multicast routing	In multicast routing, routers create optimal distribution paths for data that is sent to a multicast destination address spanning tree in real time. Multicast routing protocols that are supported are PIM (SM, SM, SDM), DVMRP tunneling.
Redundant routing	Redundant routing localizes the effects of route failures, and reduces control traffic overhead and route reconfiguration time by providing a redundant network path. Redundant routing protocols that are supported are HSRP (Hot Standby Router Protocol) and CEF (Cisco Express Forwarding).
IPv6 routing	IPv6 network segments, also known as links or subnets, are connected by IPv6 routers, which are devices that pass IPv6 packets from one network segment to another. EIGRP is the supported protocol.
VRF Lite	Virtual routing and forwarding (VRF) lets multiple instances of a routing table to coexist within the same router simultaneously. Because the routing instances are independent, the same or overlapping IP addresses can be used without conflicting with each other. The simplest form of VRF implementation is VRF Lite. In this implementation, each router within the network participates in the virtual routing environment in a peer-based fashion.

See the following manuals:

- For more information about routing features and how to modify them, see the Cisco IE3000 Switch Software Configuration Manual, available from <http://www.Cisco.com>.
- For information about using the CLI to configure routing, see the Cisco IE3000 Switch Command-Line Interface Manual, available from <http://www.Cisco.com>.

## Routing, Static and Connected

Static and connected routing is available on the following switches:

- Stratix 5400
- Stratix 5410
- Stratix 5700 switches with Full firmware
- ArmorStratix 5700
- Stratix 8000 and 8300

Static routing defines explicit paths between two devices (routers and switches). You must manually define the route information, including the destination IP address, destination subnet mask, and next hop router IP address.

Connected routing enables all devices on any VLAN that use the switch to communicate with each other if they use the switch as their default gateway. Connected routing is automatically enabled if you enable static routing. To disable connected routing and help prevent inter-VLAN communication, you must configure access control lists (ACLs) by using the CLI.

To enable routing, follow these steps in Device Manager.

1. Reallocate switch memory for routing by changing the Switch Database Management (SDM) template from the default template to the Lanbase Routing template.

---

**IMPORTANT** Step 1 is not required on Stratix 8300 switches.

---

2. Enable connected routing only.

or

Enable and configure static routing, which also enables connected routing by default.

## Reallocate Switch Memory for Routing via Device Manager

Switch Management Database (SDM) templates optimize how switch memory is allocated for specific features, such as routing. To enable routing, you must change the default SDM template to the Lanbase Routing template.

To apply an SDM template, follow these steps.

1. From the Admin menu, choose SDM-Template.
2. From the pull-down menu, choose a template:
  - Default—Gives balance to all Layer 2 functions
  - Lanbase Routing—Maximizes system resources for IPv4 unicast routing, which is required to enable routing
  - Unknown—User-configured from the CLI

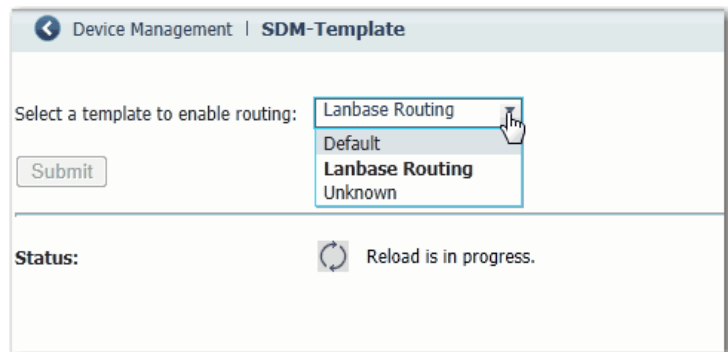

3. Click Submit.
4. When a message appears prompting you to continue, click OK.

---

**IMPORTANT** The process of changing the template causes the switch to restart.

---

A message appears once the process is complete.

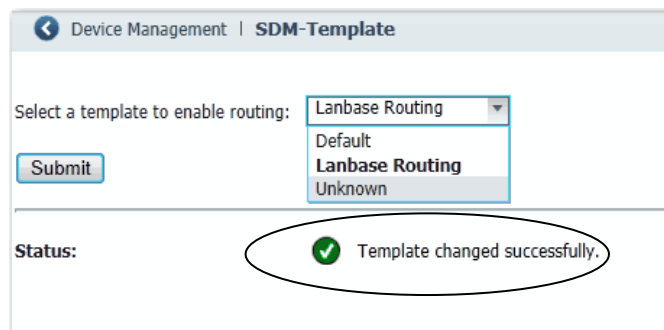

## Enable and Configure Routing via Device Manager

Before you can enable routing, you must reallocate switch memory for routing as described on [page 263](#).

From the Configure menu, choose Routing.

The screenshot shows the 'Network | Routing' configuration page. At the top, there is a 'Network | Routing' breadcrumb. Below it, the 'Enable Routing' checkbox is checked. The 'Gateway' field is set to '0.0.0.0'. A 'Submit' button is visible. Below this, there is a section for 'Static Routes' with 'Add', 'Edit', and 'Delete' icons. A table with three columns: 'Destination Network', 'Destination Mask', and 'Next Hop Router' is shown. The first row has checkboxes and values '0.0.0.0', '0.0.0.0', and '10.208.60.3'. The second row has checkboxes and values '0.0.0.0', '0.0.0.0', and '0.0.0.0'. A 'Save | Cancel' button is at the bottom right of the table.

From the Routing page, you can enable connected routing only or both static and connected routing. When static routing is enabled, connected routing is enabled by default. For more information about these routing types, refer to [Routing, Layer 3 on page 260](#).

### *Enable Connected Routing Only*

To enable connected routing only, check Enable Routing and click Submit.

No further configuration is required for connected routing.

### *Enable Both Static and Connected Routing*

1. Check Enable Routing and click Submit.
2. Configure static route information.

Field	Description
Destination Network	The IP address of the destination.
Destination Mask	The subnet mask of the destination.
Next Hop Router	The IP address of the router where this device sends the packets for the specified destination.



## Simple Network Management Protocol (SNMP)

The switch supports SNMP versions 1, 2C, and 3. SNMP enables the switch to be remotely managed through other network management software. This feature is disabled by default.

SNMP is based on three concepts:

- SNMP managers (client software)
- SNMP agents (network devices)
- Management Information Base (MIB)

[Refer to Supported MIBs on page 266](#) for the MIBs supported on the switch.

The SNMP manager runs SNMP management software. Network devices to be managed, such as bridges, routers, servers, and workstations, have an agent software module. The agent provides access to a local MIB of objects that reflects the resources and activity of the device. The agent also responds to manager commands to retrieve values from the MIB and to set values in the MIB. The agent and the MIB are on the switch. To configure SNMP on the switch, you define the relationship between the manager and the agent.

Both SNMPv1 and v2C use a community-based form of security. SNMP managers can access the agent MIB through passwords referred to as community strings. SNMPv1 and v2C are used for network monitoring without network control.

SNMPv3 provides network monitoring and control. It provides secure access to devices by a combination of authenticating and encrypting packets over the network. The security model that is used by SNMPv3 is an authentication strategy that is set up for a user and user group. A security level is the permitted level of security within a security model. A combination of a security model and a security level determines which security mechanism is used for an SNMP packet.

The following are guidelines for SNMPv3 objects:

---

**IMPORTANT** SNMPv3 is available only in cryptographic switch firmware.

---

- Each user belongs to a group.
- A group defines the access policy for a set of users.
- An access policy defines which SNMP objects can be accessed for reading, writing, and creating.
- A group determines the list of notifications that its users can receive.
- A group also defines the security model and security level for its users.
- An SNMP view is a list of MIBs that a group can access.
- Data can be securely collected from SNMP devices without fear of the data being tampered with or corrupted.
- Confidential information, for example, SNMP Set command packets that change a router configuration, can be encrypted to help prevent the contents from being exposed on the network.

## Supported MIBs

Stratix managed switches support the following MIBs.

**Table 102 - Supported MIBs**

MIB Name		
BRIDGE-MIB	CISCO-MAC-NOTIFICATION-MI	IP-FORWARD-MIB
CALISTA-DPA-MIB	CISCO-MEMORY-POOL-MIB	IP-MIB
CISCO-ACCESS-ENVMON-MIB	CISCO-PAE-MIB	LLDP-EXT-MED-MIB
CISCO-ADMISSION-POLICY-MIB	CISCO-PAGP-MIB	LLDP-MIB
CISCO-AUTH-FRAMEWORK-MIB	CISCO-PING-MIB	NETRANGER
CISCO-BRIDGE-EXT-MIB	CISCO-PORT-QOS-MIB	NOTIFICATION-LOG-MIB
CISCO-BULK-FILE-MIB	CISCO-PORT-SECURITY-MIB	OLD-CISCO-CHASSIS-MIB
CISCO-CABLE-DIAG-MIB	CISCO-PORT-STORM-CONTROL-MIB	OLD-CISCO-CPU-MIB
CISCO-CALLHOME-MIB	CISCO-PRIVATE-VLAN-MIB	OLD-CISCO-FLASH-MIB
CISCO-CAR-MIB	CISCO-PROCESS-MIB	OLD-CISCO-INTERFACES-MIB
CISCO-CDP-MIB	CISCO-PRODUCTS-MIB	OLD-CISCO-IP-MIB
CISCO-CIRCUIT-INTERFACE-MIB	CISCO-RESILIENT-ETHERNET-PROTOCOL-MIB	OLD-CISCO-MEMORY-MIB
CISCO-CLUSTER-MIB	CISCO-RTTMON-ICMP-MIB	OLD-CISCO-SYS-MIB
CISCO-CONFIG-COPY-MIB	CISCO-RTTMON-IP-EXT-MIB	OLD-CISCO-SYSTEM-MIB
CISCO-CONFIG-MAN-MIB	CISCO-RTTMON-MIB	OLD-CISCO-TCP-MIB
CISCO-DATA-COLLECTION-MIB	CISCO-RTTMON-RTP-MIB	OLD-CISCO-TS-MIB
CISCO-DHCP-SNOOPING-MIB	CISCO-SNMP-TARGET-EXT-MIB	RMON-MIB
CISCO-EMBEDDED-EVENT-MGR-MIB	CISCO-STACK-MIB	RMON2-MIB
CISCO-ENTITY-ALARM-MIB	CISCO-STACKMAKER-MIB	SMON-MIB
CISCO-ENTITY-SENSOR-MIB	CISCO-STP-EXTENSIONS-MIB	SNMP-COMMUNITY-MIB
CISCO-ENTITY-VENDORTYPE-OID-MIB	CISCO-SYSLOG-MIB	IP-MIB
CISCO-ENVMON-MIB	CISCO-TCP-MIB	SNMP-FRAMEWORK-MIB
CISCO-ERR-DISABLE-MIB	CISCO-UDLDP-MIB	SNMP-MPD-MIB
CISCO-FLASH-MIB	CISCO-VLAN-IFTABLE-RELATIONSHIP-MIB	SNMP-NOTIFICATION-MIB
CISCO-FTP-CLIENT-MIB	CISCO-VLAN-MEMBERSHIP-MIB	SNMP-PROXY-MIB
CISCO-IF-EXTENSION-MIB	CISCO-VTP-MIB	SNMP-TARGET-MIB
CISCO-IGMP-FILTER-MIB	ENTITY-MIB	SNMP-USM-MIB
CISCO-IMAGE-MIB	ETHERLIKE-MIB	SNMP-VIEW-BASED-ACM-MIB
CISCO-IP-STAT-MIB	HC-RMON-MIB	SNMPv2-MIB
CISCO-LAG-MIB	IEEE8021-PAE-MIB	TCP-MIB
CISCO-LICENSE-MGMT-MIB	IEEE8023-LAG-MIB	UDP-MIB
CISCO-MAC-AUTH-BYPASS-MIB	IF-MIB	

## Configure SNMP via Device Manager

From the Configure menu, choose SNMP.

Security | **SNMP**

Enable SNMP

Submit

System Options | Community Strings | Traps | View | Group | Users

System Location:

System Contact:

Submit

SNMP Host

Add Edit Delete

IP	Community	Port	Version	Type
No data available				

Community strings are passwords to the switch Management Information Base (MIB). You can create community strings that provide a remote manager read-only or read-write access to the switch.

To create, modify, and delete, click the Community Strings tab.

Security | **SNMP**

Enable SNMP

Submit

System Options | **Community Strings** | Traps | View | Group | Users

Add Edit Delete

Community	RWRO
<input type="radio"/> Read-only	ro
<input type="radio"/> Read-write	rw

A read-only community string enables the switch to validate Get (read-only) requests from a network management station. If you set the SNMP read community, users can access MIB objects, but cannot change them.

A read-write community string enables the switch to validate Set (read-write) requests from a network management station.

## Use SNMP Management Applications

You can use SNMP management applications such as IntraVue or HP OpenView to configure and manage the switch. [Refer to Simple Network Management Protocol \(SNMP\) on page 265](#) for more information.

## Smartports

Smartports are recommended configurations for switch ports. These configurations, referred to as port roles, optimize the switch connections and provide security, transmission quality, and reliability for traffic from the switch ports. Port roles also help to prevent port misconfigurations.

Use Smartport roles immediately after the initial setup of the switch to configure the switch ports before they connect to devices.

Follow these guidelines when using Smartport roles:

- Before using Smartport roles, decide which switch port is connected to which device type.
- Before attaching a device to the port or reconnecting devices that have been moved, verify which Smartport role is applied to a port.

---

**IMPORTANT** We recommend that you do not change port settings after enabling a Smartport role on a port. Any port setting changes can alter the effectiveness of the Smartport role.

---

- You cannot configure port roles on routed ports.

The port roles that are described in [Table 103](#) are based on the type of devices to be connected to the switch ports. For example, the Desktop for Automation port role is specifically for switch ports to be connected to desktop and laptop computers.

**Table 103 - Smartport Roles**

Port Role	Description
Automation Device	Apply this role to ports to be connected to EtherNet/IP (Ethernet Industrial Protocol) devices. It can be used for industrial automation devices, such as logic controllers and I/O: <ul style="list-style-type: none"> <li>• Port is set to Access mode.</li> <li>• Port security supports only one MAC ID.</li> <li>• Optimize queue management for CIP traffic.</li> </ul>
Multiport Automation Device	Apply this role to DLR-enabled ports and ports connected to multiport EtherNet/IP devices. Devices include multiport EtherNet/IP devices arranged in a linear or daisy chain topology, the 1783-ETAP module (for connection to only the device port), unmanaged switches, such as the Stratix 2000, and managed switches with Remote Spanning Tree Protocol (RSTP) disabled: <ul style="list-style-type: none"> <li>• Port is set to Access mode.</li> <li>• No port security.</li> <li>• Optimized queue management for CIP traffic.</li> </ul>
Desktop for Automation	Apply this role to ports to be connected to desktop devices, such as desktop computers, workstations, notebook computers, and other client-based hosts: <ul style="list-style-type: none"> <li>• Port is set to Access mode.</li> <li>• PortFast enabled.</li> <li>• Port security supports only one MAC ID.</li> </ul> Do not apply to ports to be connected to switches, routers, or access points.

**Table 103 - Smartport Roles (Continued)**

Port Role	Description
Virtual Desktop for Automation	Apply this role to ports connected to computer running virtualization software. This can be used with devices running up to two MAC IDs: <ul style="list-style-type: none"> <li>• Port is set to Access mode.</li> <li>• PortFast is enabled.</li> <li>• Port security supports two MAC IDs.</li> </ul> <b>IMPORTANT:</b> Do not apply the Virtual Desktop for Automation role to ports that are connected to switches, routers, or access points.
Switch for Automation	Apply this role to ports to be connected to other switches with Spanning Tree enabled. Port is set to Trunk mode.
Router for Automation	Apply this role to ports to be connected to routers or Layer 3 switches with routing services enabled.
Phone for Automation	Apply this role to ports to be connected to IP phones. A desktop device, such as a computer, can be connected to the IP phone. Both the IP phone and the connected computer have network access through the port: <ul style="list-style-type: none"> <li>• Port is set to Trunk mode.</li> <li>• Port security supports three MAC IDs to this port.</li> </ul> This role prioritizes voice traffic over general data traffic to provide clear voice reception on the IP phones.
Wireless for Automation	Apply this role to ports to be connected to wireless access points. The access point can provide network access to as many as 30 wireless users.
Wireless for Automation (Single VLAN)	Apply this role to ports to be connected to wireless access points that use a single VLAN.
Wireless for Automation (Multi VLAN)	Apply this role to ports to be connected to wireless access points that use multiple VLANs.
Port Mirroring	Apply this role to ports monitored by a network analyzer. For more information about port mirroring, see <a href="#">page 225</a> .
None	Apply this role to ports if you do not want a specialized Smartport role on the port. This role can be used on connections to any device, including devices with other Smartport roles.
CS1...CS10	Custom Smartport roles. You can create a customized port role with a user-defined name. See <a href="#">page 269</a> .

## Custom Smartport Roles

You can create and modify as many as 10 custom Smartport roles for a variety of custom applications. By default, the switch ports are set to the None port role. This feature is not available on Stratix 8000/8300 switches.

## Avoid Smartport Mismatches

A Smartport mismatch occurs when an attached device does not match the Smartport role that is applied to the switch port. Mismatches can have adverse effects on devices and your network.

Mismatches can result in the following conditions:

- Affect the behavior of the attached device
- Lower network performance (reduce the level of Quality of Service [QoS]) on CIP, voice, wireless, switch, and router traffic
- Reduce restrictions on guest access to the network
- Reduce protection from denial-of-service (DoS) attacks on the network
- Disable or shut down the port

We recommend that you always verify which Smartport role is applied to a port before attaching a device to the port or reconnecting devices.

## Configure Smartports via Device Manager

**IMPORTANT** When you change the Smartport role for a port, the switch sets the VLAN assigned to the port back to the default VLAN 1. You must reassign VLANs to a port after changing its Smartport role.

From the Configure menu, choose Smartports.

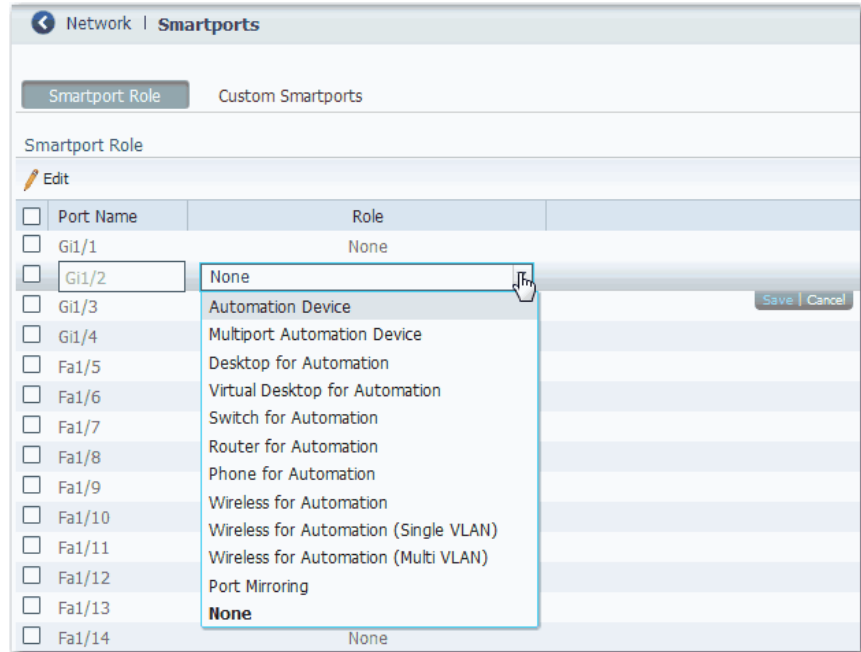

### Apply a Smartport Role

1. From the Configure menu, choose Smartports.
2. Select a port.
3. From the pull-down menu in the Role column, choose a Smartport role.
4. Click Save.

### Assign a Port to a VLAN

Before changing virtual local area network (VLAN) assignments, understand what a VLAN is, its purpose, and how to create a VLAN. See [page 283](#) for more information about VLANs.

1. From the Configure menu, choose Smartports.
2. Check the checkbox next to the port for which to change the VLAN.
3. Click Edit.

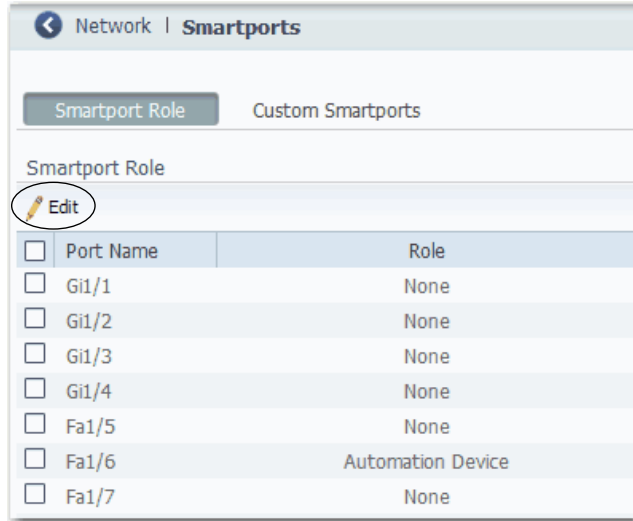

4. Modify the VLAN assignments and click OK.

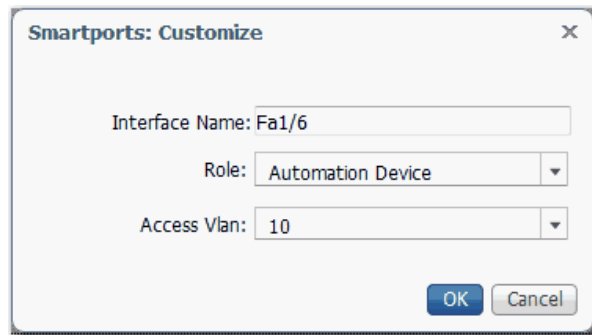

### *Manage Custom Smartport Macros*

Custom Smartports macros are not available on Stratix 8000/8300 switches.

1. Click the Custom Smartports tab.
2. Click Add.
3. Enter the name for the macro.

Macro names are case-sensitive. The string can be up to 31 alphanumeric characters. The string cannot contain a ?, a space, or a tab.

4. Choose a macro icon (CS1 to CS10).
5. Enter a macro definition.

The definition can contain up to 3000 characters. Enter the macro commands with one command per line. Use the # character at the beginning of a line to enter comment text within the macro.

Available parameters for the macro are \$native\_vlan, \$access\_vlan, and \$voice\_vlan.

6. Enter an antimacro definition.

The antimacro definition is the portion of the applied macro that removes the macro when you do the following:

- Change it to another macro.
- Remove it with the None Smartport role.

Before the macro definition can be applied to the port, the antimacro must first be defined with the proper commands to set the port back to its original state.

The definition can contain up to 3000 characters. Enter the antimacro commands with one command per line. Use the @ character to end the macro. Use the # character at the beginning of a line to enter comment text within the macro.

7. Click Submit.
8. To discard any unsaved changes, click Cancel.



*Modify the Definition of a Custom Smartports Macro*

You cannot modify a custom Smartports macro that is currently in use.

1. From the Configure menu, choose Smartports.
2. Click the Custom Smartports tab.

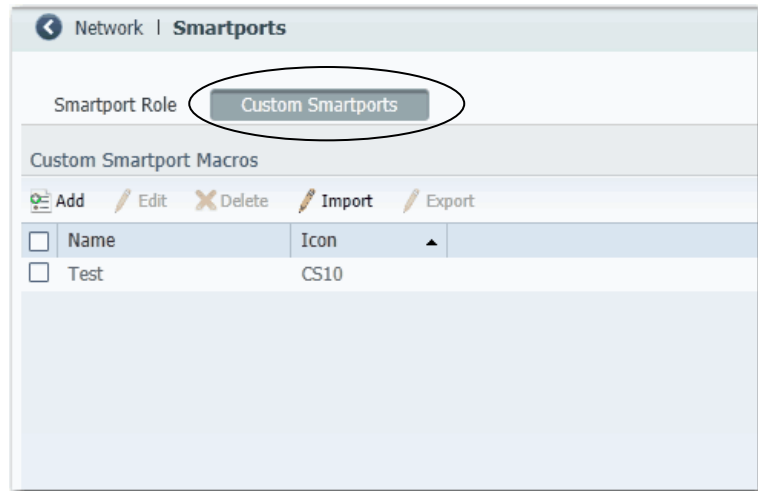

3. Check the checkbox next to the macro to modify.
4. Click Edit.

**ADD / Edit Custom Smartport Macro**

Name:

Icon:

Available Parameters: **\$native\_vlan, \$access\_vlan, \$voice\_vlan**

Macro Definition:

```
switchport mode access
switchport access vlan $access_vlan
switchport voice vlan $voice_vlan
switchport trunk native vlan $native_vlan
```

Anti Macro Definition:

```
no switchport mode access
no switchport access vlan $access_vlan
no switchport voice vlan $voice_vlan
no switchport trunk native vlan $native_vlan
no macro description
```

5. Change the definitions as needed.
6. Click Submit.

### Delete a Custom Smartports Macro

You cannot delete a custom Smartports macro that is currently in use.

1. From the Configure menu, choose Smartports.
2. Click the Custom Smartports tab.
3. Check the checkbox next to the macro to delete.

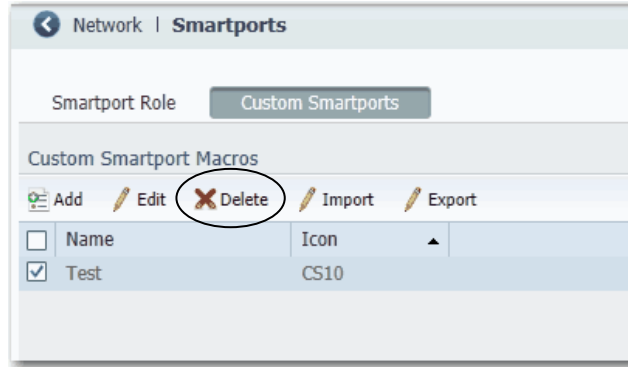

4. Click Delete.

### Import a Custom Smartports Macro

1. From the Configure menu, choose Smartports.
2. Click the Custom Smartports tab.
3. Click Import.

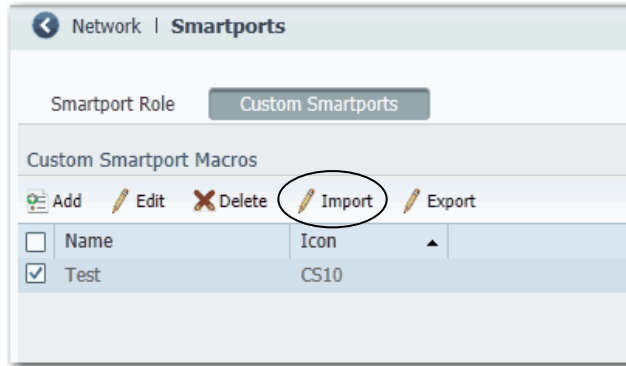

4. Click Browse.

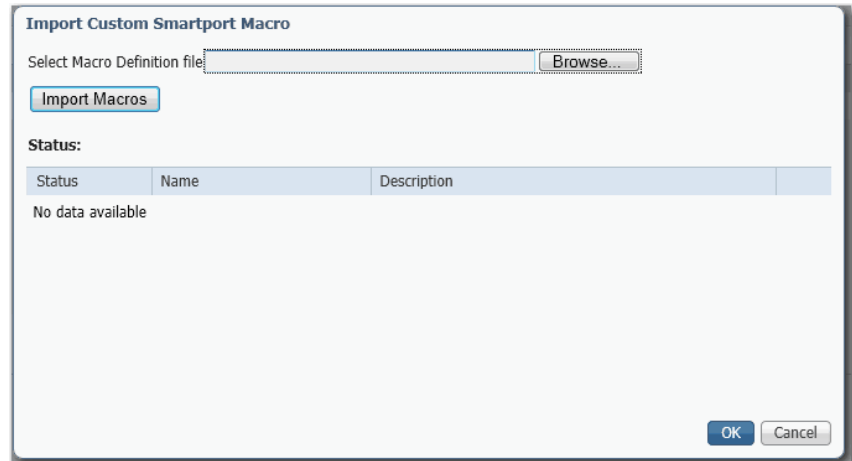

5. Select the macro file on your computer or network drive.  
The file must be an appropriately formatted .xml file.
6. Click Import Macros.
7. Click OK.

#### *Export a Custom Smartports Macro*

1. From the Configure menu, choose Smartports.
2. Click the Custom Smartports tab.
3. Check the checkbox next to the macro to export.
4. Click Export.

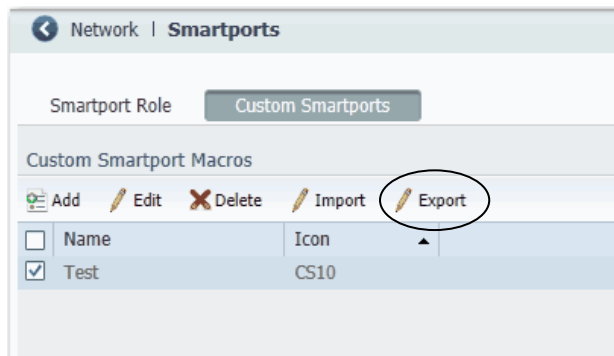

5. Save the resulting file.

## Assign Smartports and VLANs via the Logix Designer Application

In the navigation pane, click Smartports & VLANs.

For Stratix 8000/8300 switches, use Advanced Port Configuration as described on [page 277](#).

Figure 45 - Smartport & VLAN Assignment

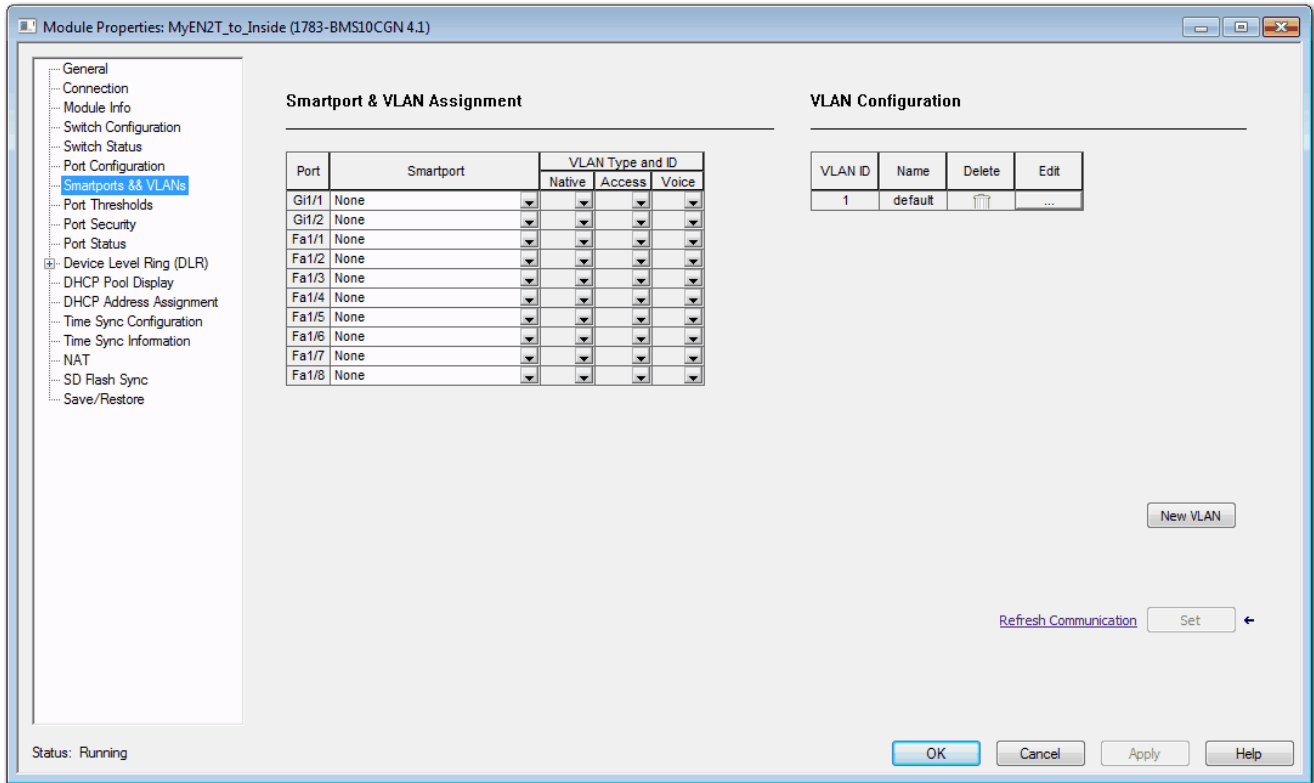

For Stratix 8000/8300 switches, in the navigation pane, click Advanced Port Configuration.

Figure 46 - Advanced Port Configuration for Stratix 8000/8300 Switches

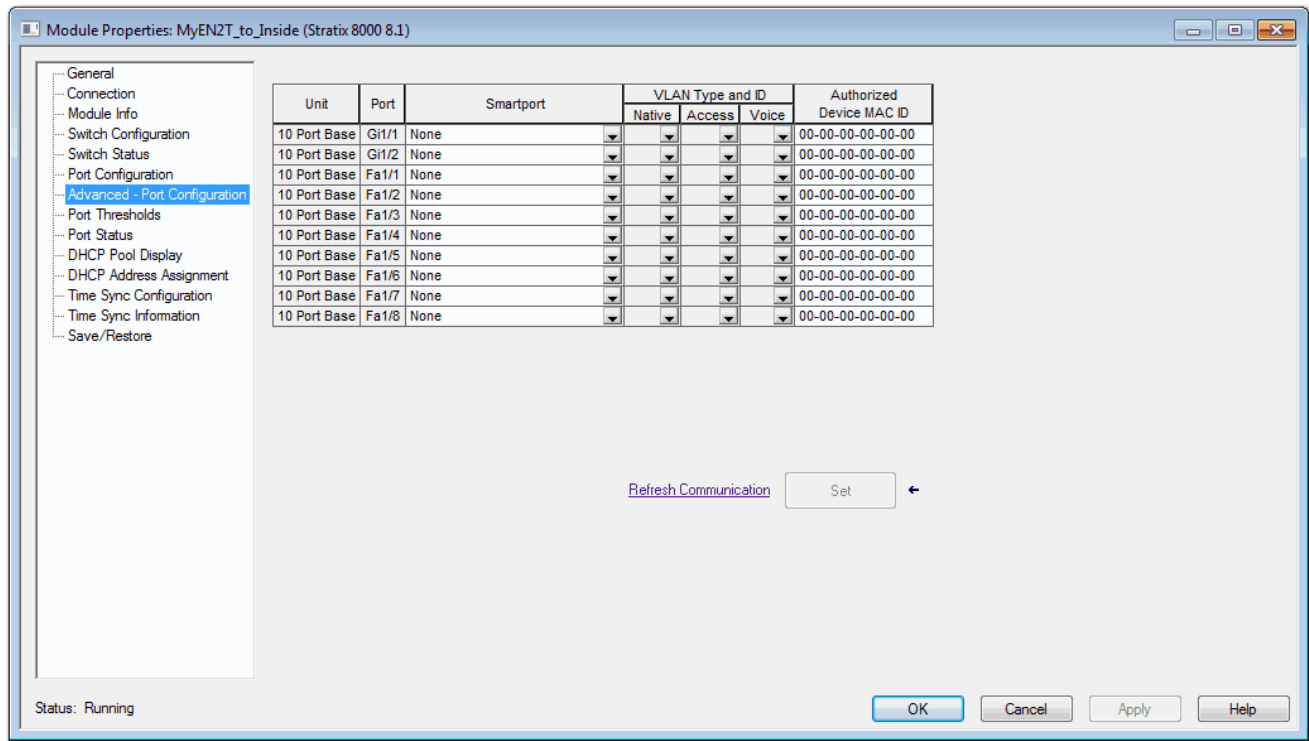

Table 104 - Smartport and VLAN Assignment Fields

Field	Description
Unit (Stratix 8000/8300 switches)	Indicates where the port resides: <ul style="list-style-type: none"> <li>• Base (for example, 1783-MS10T).</li> <li>• Expansion module (for example, 1783-MX08T).</li> </ul>
Port	The port number includes the port type (Fa for Fast Ethernet and Gi for Gigabit Ethernet), the base or expansion module number (1, 2, or 3), and the specific port number, such as in the following examples: <ul style="list-style-type: none"> <li>• Gi1/1 is Gigabit Ethernet port 1 on the base.</li> <li>• Fa2/1 is Fast Ethernet port 1 on the first expansion module.</li> </ul>
Smartport	Choose the Smartport role to apply to the connected port. For descriptions of each role, see <a href="#">Table 103 on page 268</a> . The Smartport roles are recommended configurations for the ports. These configurations are referred to as port roles. They optimize the switch connections and help verify security, transmission quality, and reliability to traffic from the switch ports. These configurations also help to prevent problems that are caused by port misconfigurations. The port roles are based on the type of device that is connected to the switch port. Be sure that you decide which port to connect to which type of device before you choose a Smartport role.
VLAN Type and ID	Choose a VLAN to assign to the port. Only the first 128 VLANs are listed: <ul style="list-style-type: none"> <li>• Native—Represents the valid Native VLAN ID for ports set to the Router for Automation and Switch for Automation role. A native VLAN is for ports that can belong to a VLAN trunk (a port belonging to more than one VLAN). The Native VLAN feature is blank when the Smartport role is set to any value other than Switch for Automation and Router for Automation.</li> <li>• Access—Represents the valid Access VLAN ID for ports set to Automation Device, Desktop for Automation, Phone for Automation, Wireless, and Automation Device with QoS role. An access VLAN is for ports that can belong to only one VLAN. The Access VLAN feature is blank when the Smartport role is set to Switch for Automation and Router for Automation.</li> <li>• Voice—Represents the valid Voice VLAN ID for ports set to the Phone for Automation role. The voice VLAN helps to make sure that all voice traffic has better Quality of Service and is not mixed with data traffic. The Voice VLAN feature is blank when the Smartport role is set to any value other than Phone for Automation.</li> </ul>
Authorized Device MAC ID	See <a href="#">Configure Port Security via the Logix Designer Application on page 231</a> .

## Spanning Tree Protocol (STP)

STP, the IEEE 802.1D bridge protocol, is a Layer 2 link management protocol that provides path redundancy and helps to prevent loops in the network. The switch supports the following STP versions:

- Multiple Spanning Tree Protocol (MSTP) based on the IEEE 802.1s standard.

MSTP uses Rapid Spanning Tree Protocol (RSTP) for rapid convergence. This mode maps a group of VLANs into a single spanning tree instance, with each instance having a spanning tree topology independent of other spanning tree instances. This architecture provides multiple forwarding paths for data traffic, enables load balancing, and reduces the number of spanning tree instances required to support a large number of VLANs. MSTP is the default STP mode.

- Per VLAN Spanning Tree Plus (PVST+) protocol based on the IEEE 802.1D standard.

PVST+ runs on each VLAN on the switch up to the maximum supported, to help create a loop-free path through the network. PVST+ provides Layer 2 load balancing for the VLAN on which it runs. You can create different logical topologies by using the VLANs on your network to make sure that all of your links are used but that no one link is oversubscribed. Each instance of PVST+ on a VLAN has a single root switch. This root switch propagates the spanning-tree information associated with that VLAN to all other switches in the network. Because each switch has the same information about the network, this process maintains the network topology.

- Rapid per VLAN Spanning Tree Plus (Rapid PVST+) protocol based on the IEEE 802.1w standard.

RPVST+ is the same as PVST+ except that it uses a rapid convergence based on the IEEE 802.1w standard. To provide rapid convergence, the rapid PVST+ immediately deletes dynamically learned MAC ID entries on a per-port basis upon receiving a topology change. By contrast, PVST+ uses a short aging time for dynamically learned MAC ID entries. Only one version can be active on the switch at any time. For example, all VLANs run PVST+, all VLANs run rapid PVST+, or all VLANs run MSTP.

In MSTP mode, the switch supports a maximum of 65 MST instances. The number of VLANs that can be mapped to a particular MST instance is unlimited.

In PVST+ or rapid-PVST+ mode, the switch supports a maximum of 128 spanning tree instances.

We recommend that you leave STP enabled to help prevent network loops and provide a redundant path if the active path becomes unavailable.

---

**IMPORTANT** Disabling STP can affect connectivity to the network.

---

## Configure STP via Device Manager

From the Configure menu, choose STP Settings.

### Global Settings

On the Global tab, you can choose an STP mode and configure spanning tree instances.

For each VLAN or VLAN group, the switch with the highest switch priority (the lowest numerical priority value) is elected as the root switch. If all switches are configured with the default priority (32768), the switch with the lowest MAC ID in the VLAN becomes the root switch:

- For MST mode, you can choose a priority value when adding or editing an MST instance.

The screenshot shows a dialog box titled "ADD / Edit MST Instance". It contains three input fields: "Instance", "VLANs", and "Priority". The "Priority" field is a dropdown menu currently showing "32768", which is circled in red. At the bottom right of the dialog are "OK" and "Cancel" buttons.

- For PVST+ or Rapid PVST+ modes, you can choose a priority value for each VLAN in the Spanning Tree Instances table.

The screenshot shows the "Spanning Tree | STP Settings" configuration page. At the top, there are tabs for "Global" and "Port Fast". The "Spanning Tree Mode" is set to "PVST+" via a dropdown menu. Below this is a "Submit" button. The main section is titled "Spanning Tree Instances" and contains a table with the following data:

VLAN ID	VLAN Name	Enable Spanning Tree	Priority
1	default	<input checked="" type="checkbox"/>	32768
3680	WoS_VLAN	<input checked="" type="checkbox"/>	4096

The "Priority" dropdown for the first row is circled in red.

For PVST+ or Rapid PVST+ modes, you can enable or disable STP on each VLAN.

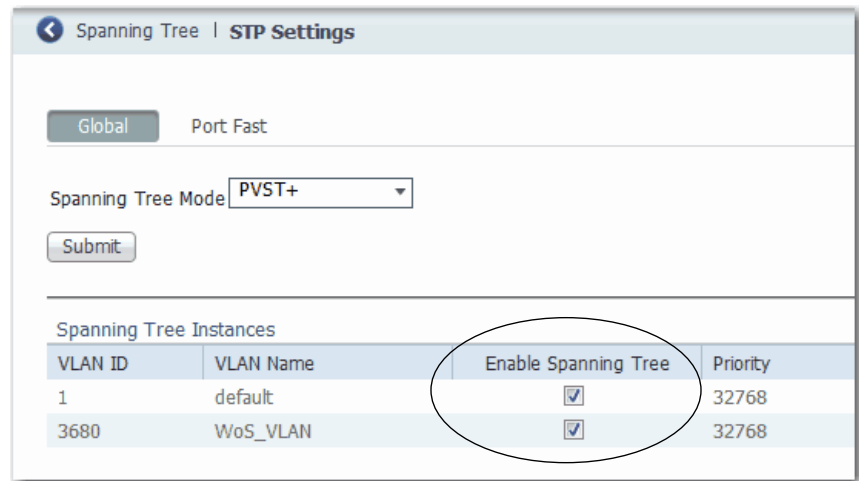

### PortFast Settings

On the PortFast tab, you can change the way that STP is implemented on individual ports.

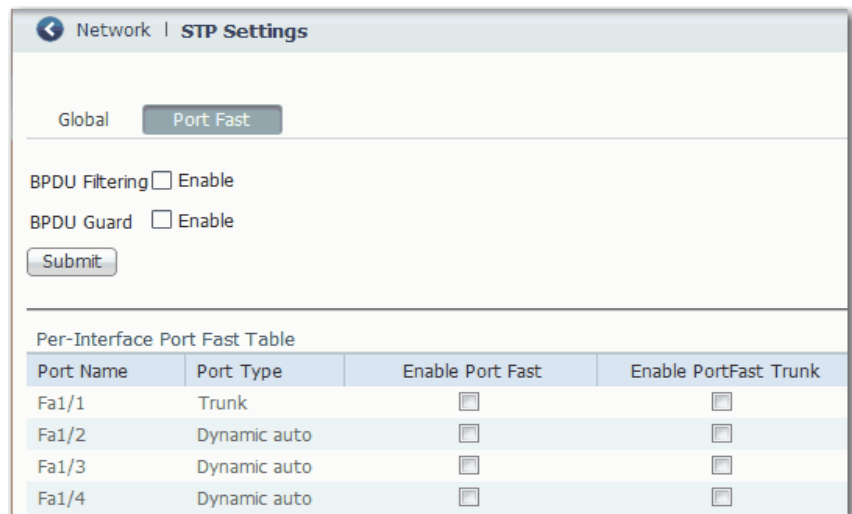

PortFast features are typically enabled on only access ports. Access ports connect to devices such as personal computers, access points, and servers that are not expected to send bridge protocol data units (BPDUs). These features are typically not enabled on ports that connect to switches because spanning tree loops can occur.

---

**IMPORTANT** In a PRP system, PortFast must be enabled on downlink ports for infrastructure switches in LAN A, LAN B, and the RedBox. BPDU Filtering must be enabled on the RedBox.

---



### *BPDU Features*

Switches exchange special frames that are called BPDUs to communicate network information, to track changes, and to create the STP topology. Because transmitted BPDUs reveal network information and received BPDUs can influence your STP topology, consider enabling BPDU Filtering and BPDU Guard on your access ports. These features help prevent a rogue device from interfering with your STP topology. However, we recommend you use these features with caution:

- **BPDU Filtering**—This PortFast feature blocks all sending and receiving of BPDUs through all ports. This feature effectively disables STP on these ports and loops can result. If a BPDU is received, PortFast is disabled on the port and the global STP settings apply.
- **BPDU Guard**—This PortFast feature shuts down a port if it receives a BPDU.

If you enable both of these features, BPDU Guard has no effect because BPDU Filtering helps prevent the port from receiving any BPDUs.

### *Per Interface PortFast Table*

Spanning tree requires a port to progress through the listening and learning states, to exchange information, and establish a loop-free path before it can forward frames. On ports that connect to devices such as workstations and servers, you can allow an immediate connection. PortFast immediately transitions the port into STP Forwarding mode upon connection.

To enable PortFast and apply the selected BPDU features to a port, select the port and do one of the following:

- If the Administrative mode for the port is Access, check Enable Port Fast.
- If the Administrative mode for the port is Trunk or Dynamic Auto, check Enable PortFast Trunk.

For more information about the Administrative mode for ports, see [Configure Port Settings on page 51](#).

When applied to a port, these Smartport roles automatically enable PortFast:

- Automation Device
- Multiport Automation Device
- Desktop for Automation
- Virtual Desktop for Automation
- Router for Automation
- Phone for Automation

## Configure STP via the Logix Designer Application

STP configuration via the Logix Designer application is available for only Stratix 5400, Stratix 5410, Stratix 5700, and ArmorStratix 5700 switches.

In the navigation pane, click Switch Configuration.

In the Administration area, you can choose an STP mode. MST/RSTP is the default mode. For more information about each mode, see [page 278](#).

**Figure 47 - Switch Configuration for Stratix 5400, Stratix 5410, Stratix 5700, and ArmorStratix 5700 Switches**

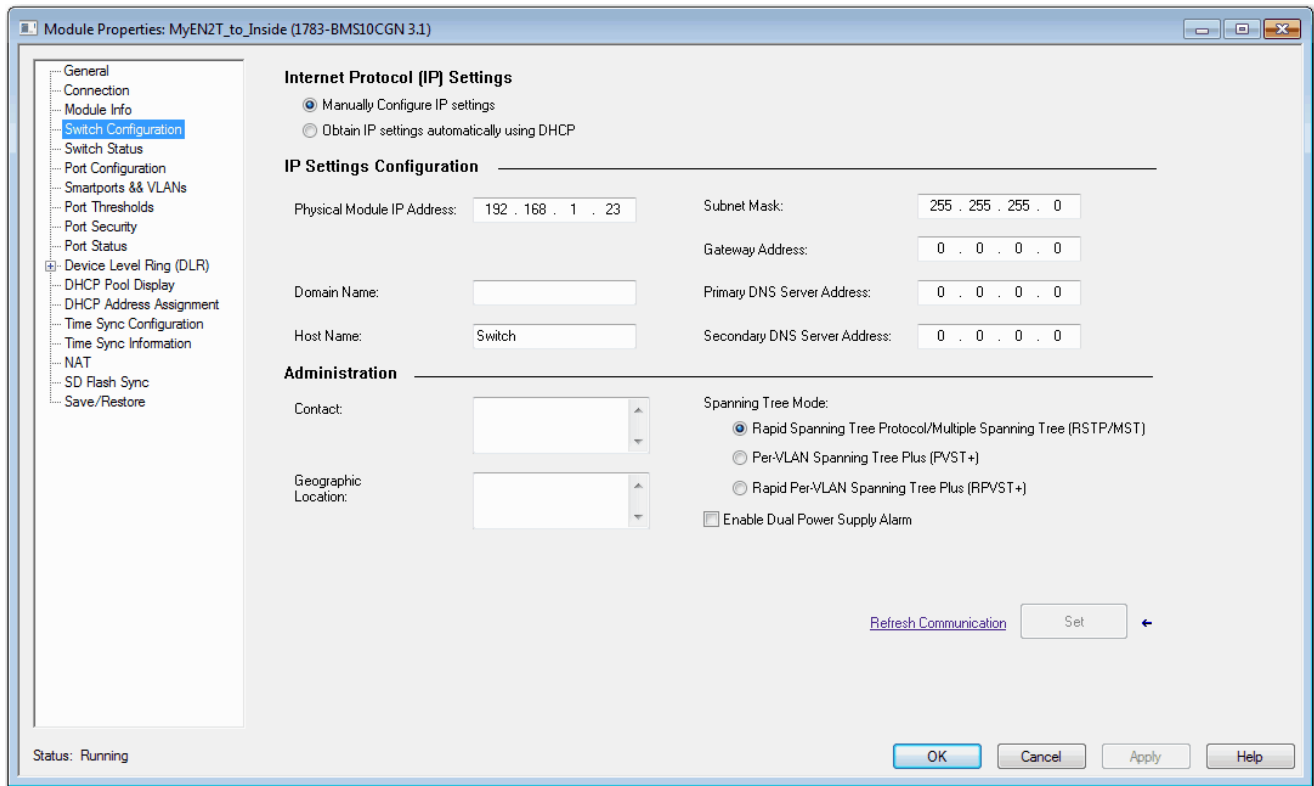

## Virtual Local Area Networks (VLANs)

A VLAN is a logical segment of the network that isolates traffic types and helps prevent collisions among data packets. Isolating different types of traffic helps to preserve the quality of the transmission and to minimize excess traffic among the logical segments. VLANs also reduce the amount of administrative effort that is required to examine requests to network resources.

You can assign each switch port to a VLAN as described on [page 270](#):

- Devices that are attached to switch ports with the same VLAN can communicate only with each other and can share data.
- Devices that are attached to switch ports with different VLANs cannot communicate with each other through the switch, unless the switch is configured for routing.
- All ports are initially assigned to the default VLAN, which is VLAN 1.

---

**IMPORTANT** A Layer 3 switch or router must be configured to enable routing across multiple VLANs and additional security policies must be set.

---

---

**IMPORTANT** Changes to VLAN assignments on a port with Network Address Translation (NAT) can break existing NAT configurations. Review your NAT configurations to make sure that VLAN assignments are correct.

---

---

**IMPORTANT** If your network uses a DHCP server, be sure that the server can access all devices in all VLANs.

---

We recommend that you first determine your VLAN needs before creating VLANs. For more information about VLANs, refer to these publications:

- Converged Plantwide Ethernet (CPwE) Design and Implementation Guide, publication [ENET-TD001](#)
- Ethernet Design Considerations, publication [ENET-RM002](#)

The switch supports a maximum of 255 VLANs, including the default VLAN. Each VLAN has a name and ID number. The ID can be from 1...1001 and 1005...4094.

With custom Smartport roles, you can specify the type of VLAN you want to implement on a port. For more information about custom Smartport roles, see [page 269](#).

## Management VLAN

VLAN 1 is the default VLAN and also the management VLAN. After the initial setup, you can create VLANs and designate any VLAN on the switch as the management VLAN. The management VLAN provides administrative access to the switch. You must assign one of the switch ports to the management VLAN. Otherwise, you do not have administrative access to the switch. You can assign a management VLAN on the Express Setup page in either Device Manager or the Logix Designer application.

## Configure VLANs via Device Manager

From the Configure menu, choose VLAN Management.

You can add, edit, and delete VLANs.

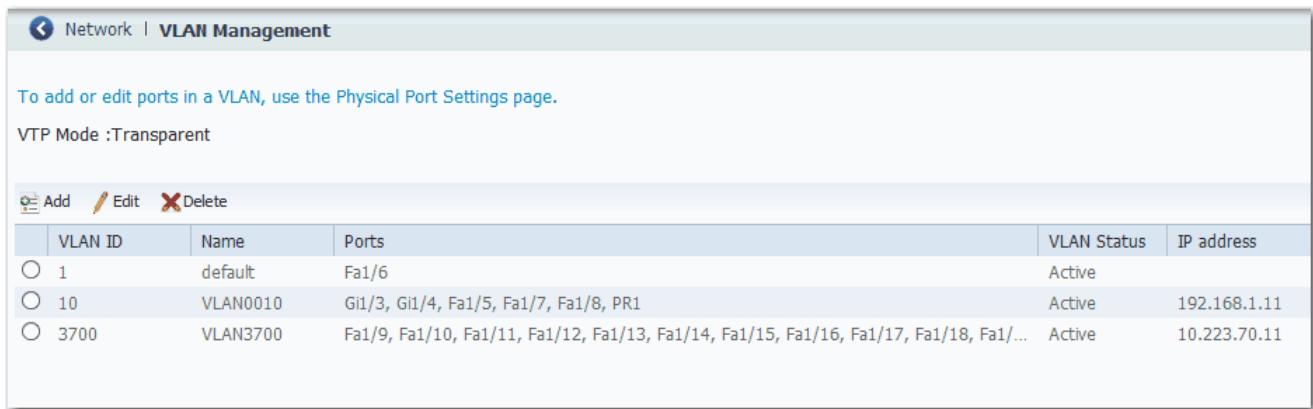

To assign a VLAN to a port when applying a Smartport role, see [page 270](#).

To assign a VLAN to a port from the Port Settings page, see [page 51](#).

## Configure VLANs via the Logix Designer Application

VLAN configuration via the Logix Designer application is available for only Stratix 5400, Stratix 5410, Stratix 5700, and ArmorStratix 5700 switches.

In the navigation pane, click Smartports & VLANs.

In the VLAN Configuration area, you can add, edit, and delete VLANs.

**Figure 48 - VLAN Configuration for Stratix 5400, Stratix 5410, Stratix 5700, and ArmorStratix 5700 Switches**

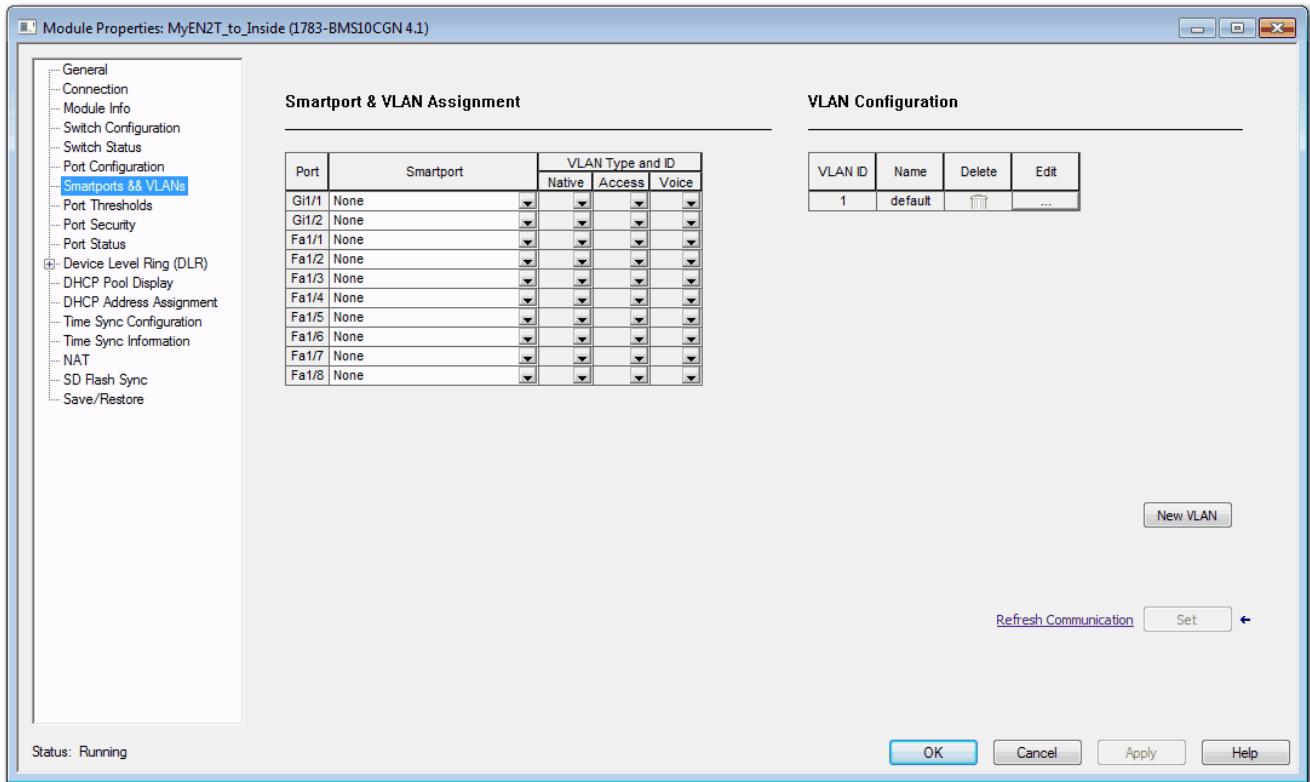

To assign ports to VLANs, see [Assign Smartports and VLANs via the Logix Designer Application on page 276](#).

## VLAN 0 Priority Tagging

VLAN 0 priority tagging enables 802.1Q Ethernet frames to be transmitted with the VLAN ID set to zero. For example, you can use this feature to forward PROFINET traffic through the switch. These frames are called priority tagged frames. Setting the VLAN ID tag to zero allows the VLAN ID tag to be ignored and the Ethernet frame to be processed according to the priority configured in the 802.1P bits of the 802.1Q Ethernet frame header.

### 802.1Q Tagging

The 802.1Q standard defines a system of VLAN tagging for Ethernet frames and also contains a provision for a Quality of Service (QoS) prioritization scheme known as 802.1P, which indicates the priority level of the frame. The 802.1Q standard adds this information to the Ethernet header, as shown in the figure below. The priority level values range from zero (best effort) to seven (highest). These values can be used to prioritize different classes of traffic. The VLAN ID tag specifies the VLAN to which the frame belongs. The priority bits define the priority with which the frames are processed.

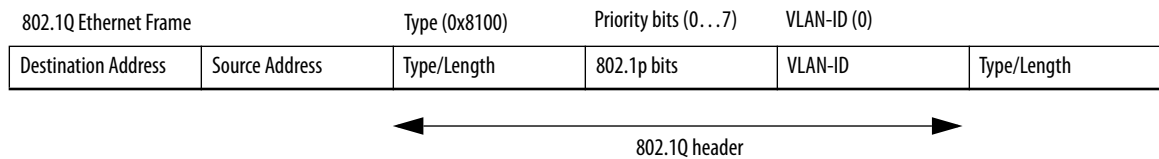

### Native VLANs

When a particular VLAN ID is assigned as a native VLAN on an Ethernet interface, frames in the native VLAN transmitted from the Ethernet interface are not tagged. Similarly, any untagged frames received on the Ethernet interface are associated with the native VLAN on that interface. The Ethernet interface can still receive both tagged and untagged frames. The tagged frames are associated with the VLAN ID in the 802.1Q header (see above). Untagged frames do not contain priority bits in the Ethernet frame header and are treated as best effort. On ingress, Ethernet packets tagged with VLAN 0 are associated with the native VLAN of the interface.

## VLAN 0 Priority Tagging and Priority Values

When VLAN 0 priority tagging is configured on the interface, the 802.1P priority bits are retained on ingress for the VLAN 0 tagged Ethernet frames. To retain the 802.1P priority bits of the VLAN 0 Ethernet packets on egress, the egress interface must be in trunk mode, and the native VLAN should not be the same native VLAN as the ingress interface. When these frames are received at the destination, the header is stripped off and the frame is processed as per the configuration of the 802.1P priority bits. If the VLAN ID has a nonzero value, the header is retained and the frame is transmitted to the specified VLAN. High priority frames are sent ahead of low priority frames.

## Configure VLAN 0 Priority Tagging

All switches support VLAN 0 priority tagging:

- In IOS Release 15.2(6)E0a and later, you can enable or disable VLAN 0 on the Edit Physical Port page in Device Manager as described on [page 51](#). By default, VLAN 0 is enabled.

The screenshot shows the 'Edit Physical Port' configuration window. The 'VLAN-0' checkbox is checked and circled in red. The window contains the following settings:

- Port Name: Fa1/6
- Description: (empty) (Range: 1-200 Characters)
- Administrative:  Enable
- Speed: Auto
- Duplex: Auto
- Auto MDIX:  Enable
- Media Type: (empty)
- VLAN-0:  Enable
- Administrative Mode: Dynamic Auto
- Access VLAN: default-1
- Allowed VLAN:  All VLANs,  VLAN IDs
- Native VLAN: VLAN0010-10

- In IOS Release 15.2(5)EA.fc4 and earlier, you must use the CLI to enable VLAN 0 priority tagging. By default, VLAN 0 is disabled.

To configure VLAN 0 tagging for PROFINET traffic via the CLI, see [page 249](#).

## Notes:



---

## Monitor the Switch

<b>Topic</b>	<b>Page</b>
Switch Status via Device Manager	290
Switch Status via the Logix Designer Application	305
System Log Messages	309
Trends	310
Port Statistics	312
NAT Statistics	313
NetFlow	319
REP Status	320
CIP Status	320
DHCP Clients	322
DLR Status	323
PRP Status	327
STP Status	329
Port Diagnostics	331
Neighbors	334
Cable Diagnostics	335

## Switch Status via Device Manager

The Dashboard page in Device Manager lets you monitor switch status and performance.

The Dashboard page is similar to the Monitor > Trends page. The Dashboard page displays the instantaneous status while the Trends page displays the historical status. By using them together, you can gather the detailed conditions of the switch and its ports. For information about the Trends page, see [page 310](#).

The Front Panel has four areas to monitor the status of the switch:

- Front Panel as described on [page 291](#)
- Switch Information as described on [page 302](#)
- Switch Health as described on [page 303](#)
- Port Utilization as described on [page 304](#)

Figure 49 - Dashboard Window

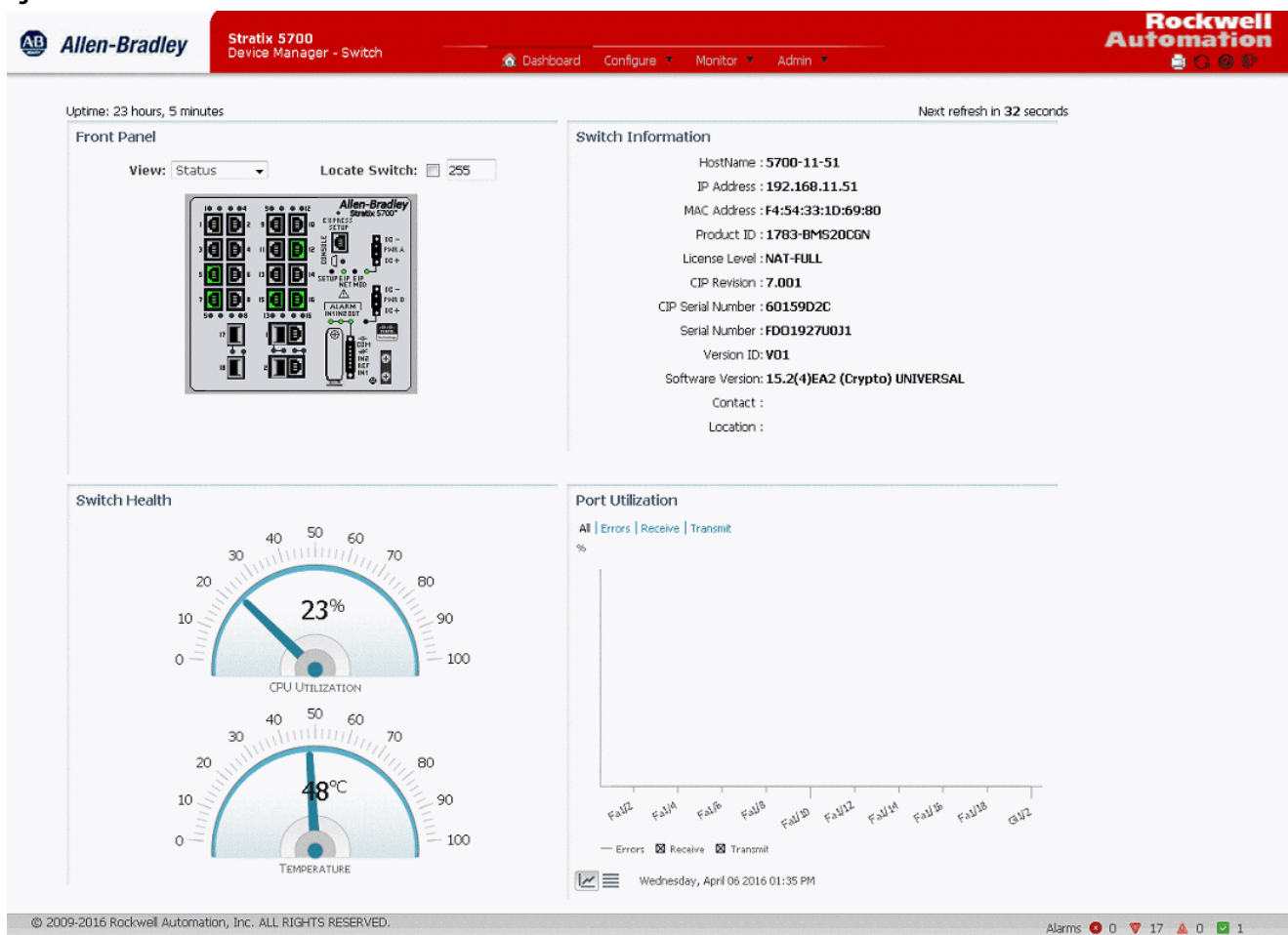

## Front Panel

The Front Panel view on the dashboard is a graphical display of the switch front panel, with color-coded switch components that indicate status. The status indicators on the view in Device Manager match the status indicators on the physical switch:

- System status indicators let you monitor the status of the switch, network status, power, and alarms.
- Port status indicators let you monitor the status of each port. Each combo port has two indicators: one for the SFP module and one for the RJ45 connector. You can change the behavior of the port status indicators by choosing a view mode from the View pull-down on the front panel view. Stratix® 5400 and Stratix 5410 switches also have a Mode button on the physical switch that affects the behavior of the port status indicators.

**Figure 50 - Front Panel View Menu**

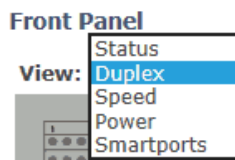

To display specific information about the port and its status, hover your mouse pointer over a port image. When you choose Smartports from the View pull-down menu, the hover text for a port image shows the Smartport role and VLAN assigned to the port.

**Figure 51 - Port Hover Text**

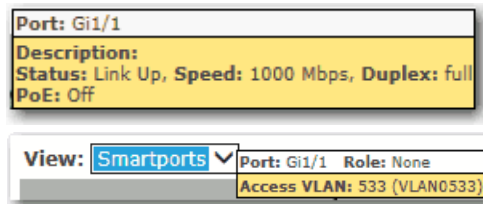

You can identify the physical switch in the group of similar devices by checking the Locate Switch checkbox on the Front Panel view.

Figure 52 - Locate Switch Checkbox

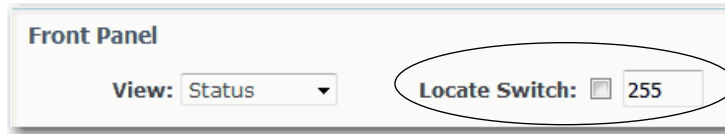

When you check the Locate Switch checkbox, the system status indicators on the physical switch (Setup, EIP NET, EIP Mod, Alarm) flash green to indicate that the feature is enabled. The status indicators continue to flash green for the length of time you specify in the adjacent field. Valid values are 9...255 seconds.

*Stratix 5700 and ArmorStratix Front Panels*

Stratix 5700 View

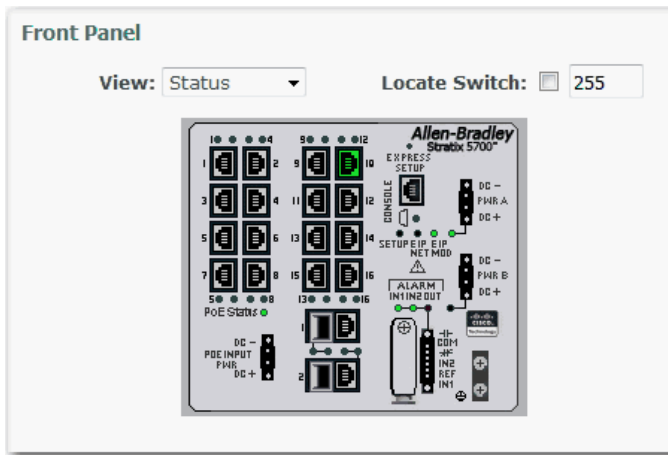

ArmorStratix 5700 View

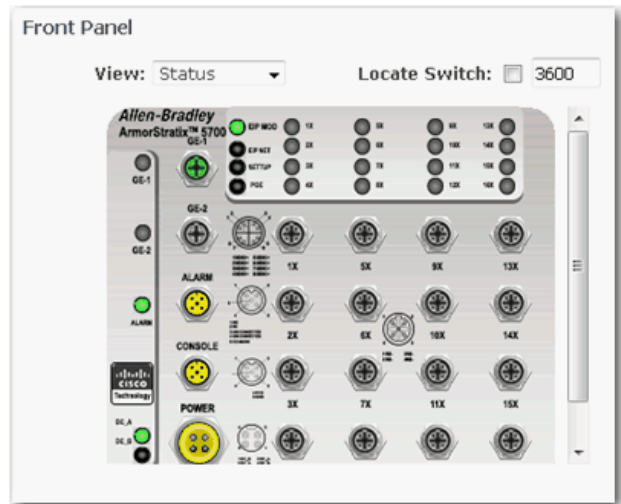
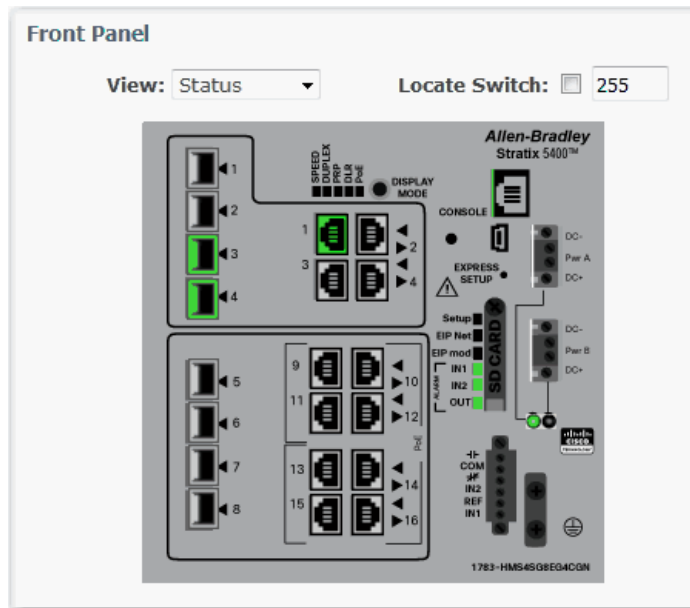

**Table 105 - Stratix 5700 and ArmorStratix 5700 System Status Indicators**

Indicator	Status	Description
Setup	The Setup status indicator shows the status of the initial setup of the switch. The behavior of the Setup status indicator varies depending on whether you run single-mode or multi-mode Express Setup. In multi-mode Express Setup, the behavior varies based on whether you run Short Press, Medium Press, or Long Press mode. For details about the Setup status indicator behavior during Express Setup, refer to <a href="#">Chapter 2, Get Started</a> .	
EIP Net	The EIP Net status indicator shows the network status of the switch.	
	Off	Power to the switch is off or is not properly connected.
	Solid green	The switch has an established CIP connection to one or more attached devices.
	Flashing green	The switch has an IP address but the switch does not have an established connection to one or more attached devices.
	Flashing red	One or more connections to attached devices have timed out.
	Solid Red	The switch has detected that its IP address is already in use by another device in the network.
	Flashing green and red	The switch is running its power-on self-test (POST).
EIP Mod	The EIP Mod status indicator shows the status of the switch.	
	Off	Power to the switch is off or is not properly connected.
	Solid green	The switch is operating properly.
	Flashing green	The switch is not configured. For example, the switch does not have an IP address configured.
	Flashing red	The switch has detected a recoverable system fault.
	Solid red	The switch has detected a nonrecoverable system fault.
	Flashing green and red	The switch is running its power-on self-test (POST).
DC_A/PWR A DC_B/PWR B	The power status indicators show the status of power to the switch.	
	Off	Power to the switch is off or is not properly connected.
	Solid green	Power is present on the associated circuit.
	Solid red	Power is not present on the associated circuit, and the switch is configured for dual-input power.
Alarm IN1 Alarm IN2	The alarm input status indicators show the status of the alarm inputs.	
	Off	Alarm input is not configured.
	Solid green	Alarm input is configured; no alarm is detected.
	Flashing red	Major alarm is detected.
	Solid red	Minor alarm is detected.
Alarm Out	The alarm out status indicators show the status of the alarm output.	
	Off	Alarm Out is not configured, or the switch is off.
	Solid green	Alarm Out is configured; no alarm is detected.
	Flashing red	The switch has detected a major alarm.

**Table 106 - Stratix 5700 and ArmorStratix 5700 Port Status Indicators**

Mode	Status	Description
Status	In Status mode, the port status indicators show the connection and activity status of the port. Status mode is the default mode.	
	Off	No link is present on the port.
	Solid green	Port link; no activity.
	Flashing green and off	Link is active and healthy.
	Alternating green and amber	There is a fault or error on the link.
	Solid amber	The port is disabled.
Duplex	In Duplex mode, the port status indicators show the Duplex mode (Full-duplex or Half-duplex) of the ports. The 10/100/1000 ports operate only in Full-duplex mode.	
	Off	The port is not operating.
	Solid amber	The port is operating in Half-duplex mode.
	Solid green	The port is operating in Full-duplex mode.
Speed	In Speed mode, the port status indicators show the operating speed of the ports.	
	Off	The port is not operating.
	Solid amber	The port is operating at 10 Mbps.
	Solid green	The port is operating at 100 Mbps.
	Flashing green	The port is operating at 1000 Mbps.
Power	In Power mode, the port status indicators show the status of PoE on switch models with PoE capability.	
	Off	PoE is disabled on the port.
	Solid green	PoE is enabled on the port. The switch port is providing power.
	Flashing green and amber	PoE is denied because it exceeds the power capacity of the switch.
	Flashing amber	PoE is denied because it exceeds the configured power limit for the switch port.

*Stratix 5400 Front Panel*

Along with the View modes on the Dashboard page, the Stratix 5400 switch has a Display Mode button on the physical switch. The Display Mode button changes the behavior of the port status indicators. Select a mode by pressing the Display Mode button on the physical switch. Each time that you press the switch, the active mode moves from the default Status mode to Speed, Duplex, PRP, and PoE respectively, and then back to Status mode. For a description of the modes, see [Table 108](#).

When a mode is active, its mode status indicator turns on. When a mode is inactive, its mode status indicator turns off. When all status indicators for Speed, Duplex, PRP, DLR, and PoE are off, the switch is in the default Status mode.

**Figure 53 - Stratix 5400 Display Modes**

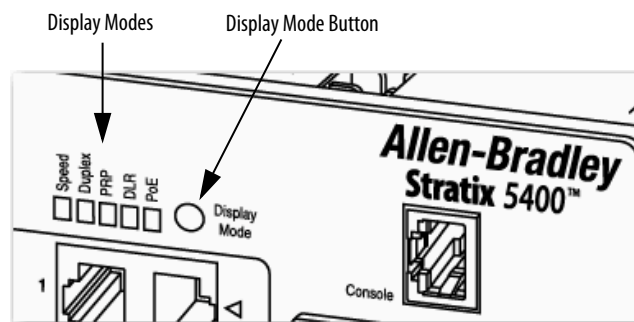

**Table 107 - Stratix 5400 System Status Indicators**

Indicator	Status	Description
Setup	The Setup status indicator shows the status of the initial setup of the switch. The Setup status indicator shows the status of the initial setup of the switch. The behavior of the Setup status indicator varies depending on whether you run single-mode or multi-mode Express Setup. In multi-mode Express Setup, the behavior varies based on whether you run Short Press, Medium Press, or Long Press mode. For details about the Setup status indicator behavior during Express Setup, refer to <a href="#">Chapter 2, Get Started</a> .	
EIP Net	The EIP Net status indicator shows the network status of the switch.	
	Off	Power to the switch is off or is not properly connected.
	Solid green	The switch has an established CIP connection to one or more attached devices.
	Flashing green	The switch has an IP address but the switch does not have an established connection to one or more attached devices.
	Flashing red	One or more connections to attached devices have timed out.
	Solid Red	The switch has detected that its IP address is already in use by another device in the network.
	Flashing green and red	The switch is running its power-on self-test (POST).
EIP Mod	The EIP Mod status indicator shows the status of the switch.	
	Off	Power to the switch is off or is not properly connected.
	Solid green	The switch is operating properly.
	Flashing green	The switch is not configured. For example, the switch does not have an IP address configured.
	Flashing red	The switch has detected a recoverable system fault.
	Solid red	The switch has detected a nonrecoverable system fault.
	Flashing green and red	The switch is running its power-on self-test (POST).
Pwr A Pwr B	The power status indicators show the status of power to the switch.	
	Off	Power to the switch is off or is not properly connected.
	Solid green	Power is present on the associated circuit.
	Solid red	Power is not present on the associated circuit, and the switch is configured for dual-input power.
Alarm IN1 Alarm IN2	The alarm input status indicators show the status of the alarm inputs.	
	Off	Alarm input is not configured.
	Solid green	Alarm input is configured; no alarm is detected.
	Flashing red	Major alarm is detected.
	Solid red	Minor alarm is detected.
Alarm Out	The alarm out status indicator shows the status of the alarm output.	
	Off	Alarm Out is not configured, or the switch is off.
	Solid green	Alarm Out is configured; no alarm is detected.
	Flashing red	The switch has detected a major alarm.



**Table 108 - Stratix 5400 Port Status Indicators**

Mode	Status	Description
Status	In Status mode, the port status indicators show the connection and activity status of the port. Status mode is the default mode. You can choose Status mode via the View pull-down menu in Device Manager. You can also choose Status mode by pressing the Disp. Mode button on the physical switch until all mode status indicators on the switch turn off.	
	Off	No link is present on the port.
	Solid green	Port link; no activity.
	Flashing green and off	Link is active and healthy.
	Alternating green and amber	There is a fault or error on the link.
	Solid amber	The port is disabled.
Duplex	In Duplex mode, the port status indicators show the Duplex mode (Full-duplex or Half-duplex) of the ports. The 10/100/1000 ports operate only in Full-duplex mode.	
	Off	The port is not operating.
	Solid amber	The port is operating in Half-duplex mode.
	Solid green	The port is operating in Full-duplex mode.
Speed	In Speed mode, the port status indicators show the operating speed of the ports.	
	Off	The port is not operating.
	Solid amber	The port is operating at 10 Mbps.
	Solid green	The port is operating at 100 Mbps.
	Flashing green	The port is operating at 1000 Mbps.
PRP	In PRP mode, the port status indicators show the status of Parallel Redundancy Protocol (PRP). To configure PRP, see <a href="#">page 219</a> .	
	Off	PRP is disabled or not in use on the port.
	Solid green	PRP is active on the port.
DLR—Not functional as of the current release.		
Power/PoE	In Power or PoE mode, the port status indicators show the status of PoE on switch models with PoE capability. The Power mode available via the View pull-down menu in Device Manager is the same as the PoE mode available via the Disp. Mode button on the physical switch.	
	Off	PoE is disabled on the port.
	Solid green	PoE is enabled on the port. The switch port is providing power.
	Flashing green and amber	PoE is denied because it exceeds the power capacity of the switch.
	Flashing amber	PoE is denied because it exceeds the configured power limit for the switch port.

Stratix 5410 Front Panel

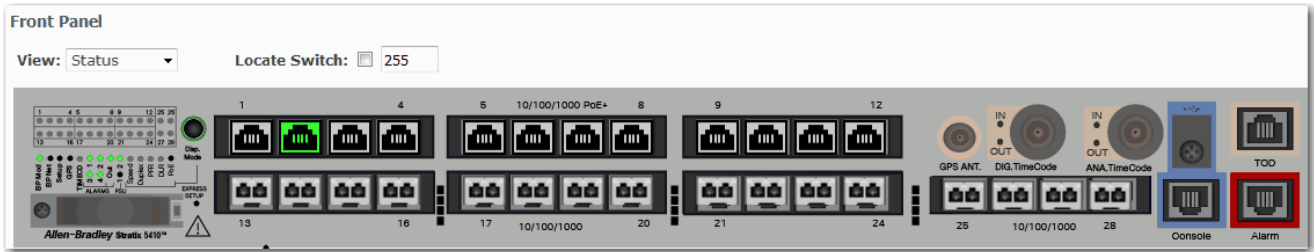

In addition to the View modes on the Dashboard page, the Stratix 5410 switch has a Disp. Mode button on the physical switch that changes the behavior of the port status indicators based on the selected mode. Select a mode by pressing the Disp. Mode button on the physical switch. Each time that you press the switch, the active mode moves from the default Status mode to Speed, Duplex, PRP, and PoE respectively, and then back to Status mode. For a description of the modes, see [Table 110](#).

When a mode is active, its mode status indicator turns on. When a mode is inactive, its mode status indicator turns off. When all status indicators for Speed, Duplex, PRP, DLR, and PoE are off, the switch is in the default Status mode.

Figure 54 - Stratix 5410 Display Modes

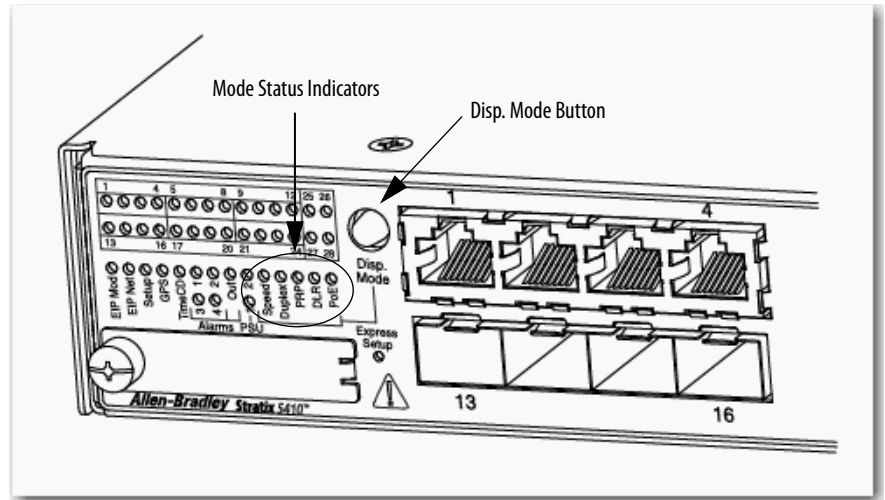

**Table 109 - Stratix 5410 System Status Indicators**

Indicator	Status	Description
EIP Mod	The EIP Mod status indicator shows the status of the switch.	
	Off	Power to the switch is off or is not properly connected.
	Solid green	The switch is operating properly.
	Flashing green	The switch is not configured. For example, the switch does not have an IP address configured.
	Flashing red	The switch has detected a recoverable system fault.
	Solid red	The switch has detected a nonrecoverable system fault.
	Flashing green and red	The switch is running its power-on self-test (POST).
EIP Net	The EIP Net status indicator shows the network status of the switch.	
	Off	Power to the switch is off or is not properly connected.
	Solid green	The switch has an established CIP connection to one or more attached devices.
	Flashing green	The switch has an IP address but the switch does not have an established connection to one or more attached devices.
	Flashing red	One or more connections to attached devices have timed out.
	Solid Red	The switch has detected that its IP address is already in use by another device in the network.
	Flashing green and red	The switch is running its power-on self-test (POST).
Setup	The Setup status indicator shows the status of the initial setup of the switch. The behavior of the Setup status indicator varies depending on whether you run single-mode or multi-mode Express Setup. In multi-mode Express Setup, the behavior varies based on whether you run Short Press, Medium Press, or Long Press mode. For details about the Setup status indicator behavior during Express Setup, refer to <a href="#">Chapter 2, Get Started</a> .	
GPS	Supported only on Stratix 5410 series B switches with IOS Release 15.2(6)E0a and later. Indicates the status of the global navigation satellite system (GNSS).	
	Off	GNSS is not operational.
	Solid green	<ul style="list-style-type: none"> <li>GNSS is in a normal state and Self-survey mode is complete.</li> <li>GNSS has a valid signal.</li> </ul>
	Flashing green	<ul style="list-style-type: none"> <li>GNSS is in Self-survey mode.</li> <li>The signal is lost.</li> </ul>
	Solid amber	<ul style="list-style-type: none"> <li>GNSS receiver firmware update is in process. After the GNSS receiver firmware update is complete, GNSS is reset and the status indicator flashes green as the self-survey process starts after reset.</li> <li>A GNSS error occurred, such as antenna open, antenna shorted, or no tracking satellite.</li> </ul>
TimeCD	Not available in the current release.	
Alarms 1 . . . 4	The alarm input status indicators show the status of the alarm inputs.	
	Off	Alarm input is not configured.
	Solid green	Alarm input is configured; no alarm is detected.
	Solid red	Minor alarm is detected.
	Flashing red	Major alarm is detected.
	Alternating green and red	Critical alarm is detected.
Alarm Out	The alarm input status indicator shows the status of the alarm output.	
	Off	Alarm Out is not configured.
	Solid green	Alarm Out is configured; no alarm is detected.
	Solid red	Alarm is detected.
PSU 1 PSU 2	The power status indicators show the status of power to the switch.	

**Table 109 - Stratix 5410 System Status Indicators (Continued)**

Indicator	Status	Description
	Off	Power is not present on the circuit, or the system is not powered up.
	Solid green	Power output is good.
	Flashing red	Power supply is installed, but power input is bad.
	Solid red	Power output is bad.

**Table 110 - Stratix 5410 Port Status Indicators**

Mode	Status	Description
Status	In Status mode, the port status indicators show the connection and activity status of the port. Status mode is the default mode. You can choose Status mode via the View pull-down menu in Device Manager. You can also choose Status mode by pressing the Disp. Mode button on the physical switch until all mode status indicators on the switch turn off.	
	Off	No link is present on the port.
	Solid green	Port link; no activity.
	Flashing green and off	Link is active and healthy.
	Alternating green and amber	There is a fault or error on the link.
	Solid amber	The port is disabled.
Speed	In Speed mode, the port status indicators show the operating speed of the ports.	
Ports 1 . . . 24	Off	The port is not operating.
	Solid amber	The port is operating at 10 Mbps.
	Solid green	The port is operating at 100 Mbps.
	Flashing green	The port is operating at 1000 Mbps.
Ports 25 . . . 28	Off	The port is not operating.
	Solid green	The port is operating at 1000 Mbps
	Flashing green	The port is operating at 10 Gbps.
Duplex	In Duplex mode, the port status indicators show the Duplex mode (Full-duplex or Half-duplex) of the ports. The 10/100/1000 ports operate only in Full-duplex mode.	
	Off	The port is not operating.
	Solid amber	The port is operating in Half-duplex mode.
	Solid green	The port is operating in Full-duplex mode.
PRP	In PRP mode, the port status indicators show the status of Parallel Redundancy Protocol (PRP). To configure PRP, see <a href="#">page 219</a> .	
	Off	PRP is disabled or not in use on the port.
	Solid green	PRP is configured and active on the port.
	Solid amber	PRP is configured on the port and has a redundancy fault.
DLR—Not functional as of the current release.		
Power or PoE	In Power or PoE mode, the port status indicators show the status of PoE. The Power mode available via the View pull-down menu in Device Manager is the same as the PoE mode available via the Disp. Mode button on the physical switch.	
	Off	PoE is not enabled on the port.
	Solid green	PoE is enabled on the port and is functioning properly.
	Alternating green and amber	PoE is enabled on the port, but power is disconnected or failing on this low priority port.
	Flashing amber	PoE is enabled on the port, but power is disconnected or is failing on this high priority port.
	Solid amber	PoE is enabled on the port, but has failures.

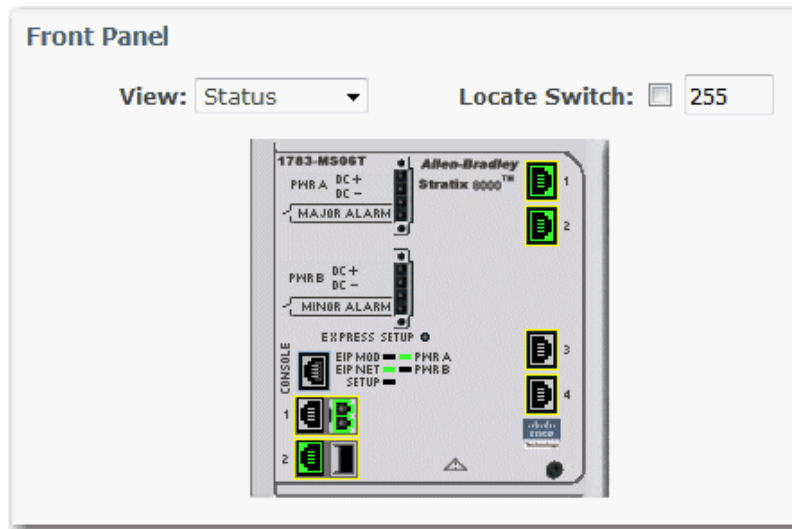
*Stratix 8000/8300 Front Panel***Table 111 - Stratix 8000/8300 System Status Indicators**

Indicator	Status	Description	
EIP Mod		The EIP Mod status indicator shows the status of the switch.	
	Off	Power to the switch is off or is not properly connected.	
	Solid green	The switch is operating properly.	
	Flashing green	The switch is not configured. For example, the switch does not have an IP address configured.	
	Flashing red	The switch has detected a recoverable system fault. Use the system log to see more details about the problem. See <a href="#">System Log Messages on page 309</a> .	
	Solid red	The switch has detected a nonrecoverable system. Use the system log to see more details about the problem. See <a href="#">System Log Messages on page 309</a> .	
EIP Net	Flashing green and red	The switch is running its power-on self-test (POST).	
		The EIP Net status indicator shows the network status of the switch.	
	Off	Power to the switch is off or is not properly connected.	
	Solid green	The switch has an established CIP connection to one or more attached devices.	
	Flashing green	The switch has an IP address but the switch does not have an established connection to one or more attached devices.	
	Flashing red	One or more connections to attached devices have timed out.	
Setup	Solid red	The switch has detected that its IP address is already in use by another device in the network.	
	Flashing green and red	The switch is running its power-on self-test (POST).	
		The Setup status indicator shows the status of the initial setup of the switch.	
		The behavior of the Setup status indicator varies depending on whether you run single-mode or multi-mode Express Setup. In multi-mode Express Setup, the behavior varies based on whether you run Short Press, Medium Press, or Long Press mode. For details about the Setup status indicator behavior during Express Setup, refer to <a href="#">Chapter 2, Get Started</a> .	
	Pwr A and Pwr B		The Pwr status indicators show the DC power status.
		Off	Power to the switch is off or is not properly connected.
Solid green		Power is present.	
	Solid red	Power to the switch is not present and the power alarm is on.	

**Table 112 - Stratix 8000/8300 Port Status Indicators**

Mode	Status	Description
Status	In Status mode, the port status indicators show the status of the ports. Status is the default mode.	
	Off	No link
	Solid green	No activity on link.
	Flashing green	Link activity.
	Solid brown	Port has been disabled.
	Yellow	An error has disabled the port.
	Flashing green and amber	Faulty link.
	Flashing amber	Smartports configuration mismatch on port.
	Solid amber	Port is faulty, disabled due to an error, or is in an STP-blocked state.
Duplex	In Duplex mode, the port status indicators show the Duplex mode (Full-duplex or Half-duplex) of the ports. The 10/100/1000 ports operate only in Full-duplex mode.	
	Off	No link.
	Solid light blue	Port is in Half-duplex mode.
	Solid green	Port is in Full-duplex mode.
Speed	In Speed mode, the port status indicators show the operating speed of the ports.	
	Off	No link.
	Solid light blue	10 Mbps
	Solid green	100 Mbps
	Flashing green	1000 Mbps

## Switch Information

The Switch Information area on the Dashboard displays information about the switch.

**Table 113 - Switch Information Fields**

Field	Description
Host Name	A descriptive name for this switch. The default name is Switch. You can set this parameter on the Admin > Express Setup page.
IP Address	The IP address of this switch. You can configure this setting on the Admin > Express Setup page.
MAC Address	The MAC address of this switch. This information cannot be changed.
Product ID	The model of this switch. This information cannot be changed.
License Level	The type of firmware on the switch: Full or Lite. This information cannot be changed.
CIP Revision	The version of Common Industrial Protocol (CIP) that is supported on this switch. This information cannot be changed.
CIP Serial Number	The CIP serial number. This information cannot be changed.
Serial Number	The serial number of this switch. This information cannot be changed.
Version ID	The hardware version. This information cannot be changed.
Software	The version of IOS that this switch is running. This information is updated when you upgrade the switch firmware.
Contact	The person who is the administrative contact for this switch. You can set this parameter on the Configure > SNMP page.
Location	The physical location of this switch. You can set this parameter on the Configure > SNMP page.

## Switch Health

You can use the health gauges to monitor CPU utilization and temperature.

The CPU Utilization gauge shows the percentage of CPU processing power that is in use on the switch. Data is collected at each 60-second system refresh. The gauge changes as the switch experiences the network activity from devices sending data through the network. As network activity increases, so does contention between devices to send data through the network.

As you monitor utilization on the switch, note whether the percentage of usage is what you expect during that given time of network activity. If utilization is high when you expect it to be low, perhaps a problem exists. As you monitor the switch, note if the bandwidth utilization is consistently high, which can indicate congestion in the network. If the switch reaches its maximum bandwidth (above 90% utilization) and its buffers become full, it begins to discard the data packets that it receives. Some packet loss in the network is not considered unusual, and the switch is configured to help recover lost packets, such as by signaling to other devices to resend data. However, excessive packet loss can create packet errors, which can degrade overall network performance.

To reduce congestion, consider segmenting the network into subnetworks that are connected by other switches or routers. Look for other causes, such as faulty devices or connections, which can also increase bandwidth utilization on the switch.

The Temperature gauge shows the internal temperature of the switch. For information about the switch temperature range and the operating environment guidelines, see the Stratix Ethernet Device Specifications Technical Data, publication [1783-TD001](#).

## Port Utilization

You can choose which types of network traffic to display and in what format:

- Types of traffic—By default, all traffic is displayed for all interfaces. Click the links above the display area to display all traffic, errors, received traffic, or transmitted traffic.
- Formats—Click the buttons below the display area to view the data in Chart Mode or Grid Mode.
- Chart details—When displaying a chart, position your mouse pointer over a bar or a point on the chart to view the data.

As you monitor the usage on the ports, note whether the percentage is what you expect during that given time of network activity. If usage is high when you expect it to be low, a problem can exist. Bandwidth allocation can also be based on whether the connection is operating in Half-duplex or Full-duplex mode.

Reasons for errors that are received on or sent from the switch ports include the following:

- Bad cable connection
- Defective ports
- Software problems
- Driver problems

Data is collected at each 60-second system refresh.

See [Trends on page 310](#) for a graph to view per-port patterns over incremental instances in time (by 60 seconds, 1 hour, 1 day, or 1 week).

See [Port Statistics on page 312](#) for details on the specific port errors that are detected on each port.



## Switch Status via the Logix Designer Application

The Switch Status view in the Studio 5000 Logix Designer® application lets you view status parameters for the switch.

In the navigation pane, click Switch Status.

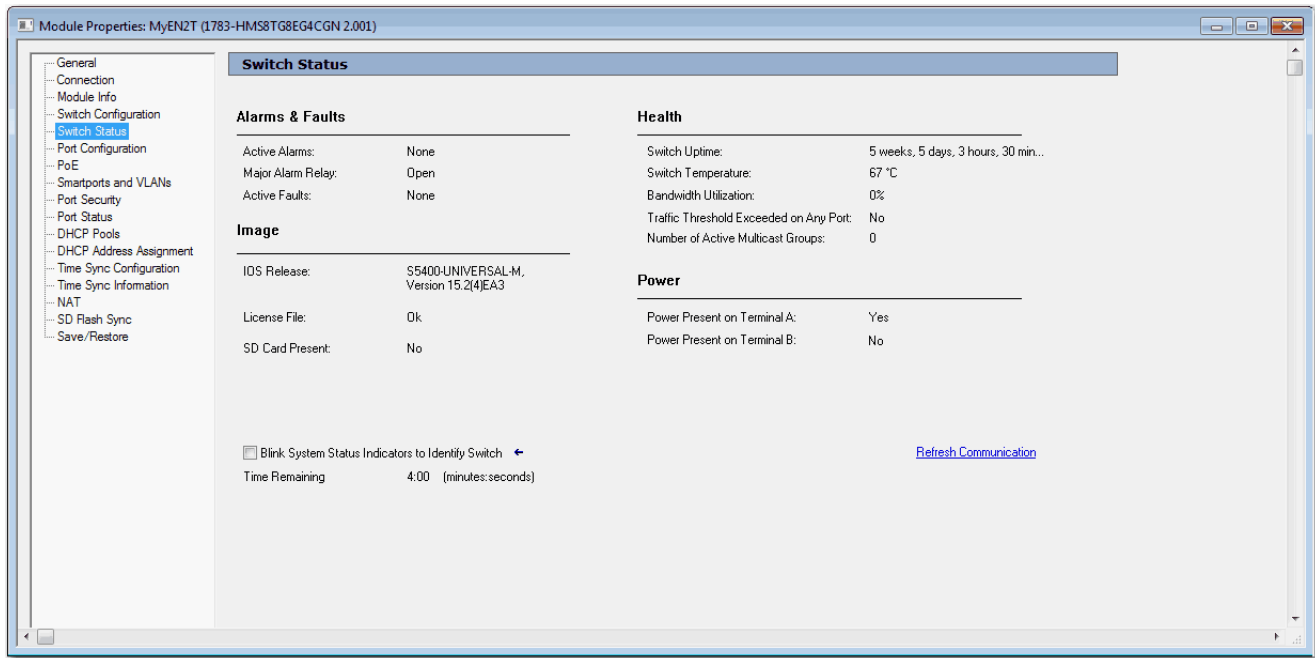

**Table 114 - Switch Status Fields**

Field	Description
<b>Alarms &amp; Faults</b>	
Active Alarms	Displays one of these values: <ul style="list-style-type: none"> <li>None</li> <li>Port alarm</li> <li>Dual Mode Power Supply alarm</li> <li>Primary Temperature alarm</li> </ul>
Major Alarm Relay	Displays one of these values: <ul style="list-style-type: none"> <li>Open</li> <li>Closed</li> </ul>
Active Faults	Displays one of these values: <ul style="list-style-type: none"> <li>None</li> <li>Port fault</li> <li>Hardware fault</li> </ul> If the port and hardware faults are active, the Hardware fault status appears.
<b>Health</b>	
Switch Uptime	Displays the days, hours, and minutes that the switch has been functioning since the last restart.
Switch Temperature	Displays the current internal temperature (in degree Celsius) of the switch.
Bandwidth Utilization	Displays the total percentage of the switch bandwidth being used.
Traffic Threshold Exceeded on Any Port	Displays Yes or No to indicate whether the current unicast, multicast, and broadcast thresholds have been exceeded on any port.
Number of Active Multicast Groups	Displays the number of active multicast groups.
<b>Image</b>	
IOS Release	Displays the current version of the switch operating system.
License File	Displays whether the license file is valid.

**Table 114 - Switch Status Fields (Continued)**

Field	Description
SD Card Present	Displays whether the SD card is installed.
<b>Power</b>	
Power Present on Terminal A	Displays Yes or No to indicate whether power is present on Terminal A.
Power Present on Terminal B	Displays Yes or No to indicate whether power is present on Terminal B.
Power Supply Unit 1 (Stratix 5410 switches)	Displays the type of power supply installed in the PSU1 slot. If a fault exists with a power supply, the field displays either AC_Fault or DC_Fault. Valid values: <ul style="list-style-type: none"> <li>• AC</li> <li>• AC_Fault</li> <li>• DC</li> <li>• DC_Fault</li> <li>• None</li> </ul>
Power Supply Unit 2 (Stratix 5410 switches)	Displays the type of power supply installed in the PSU2 slot. If a fault exists with a power supply, the field displays either AC_Fault or DC_Fault. Valid values: <ul style="list-style-type: none"> <li>• AC</li> <li>• AC_Fault</li> <li>• DC</li> <li>• DC_Fault</li> <li>• None</li> </ul>
<b>Locate Switch Feature</b>	
Blink System Status Indicators to Identify Switch	If you connect or disconnect ports or move a switch in a group of similar devices, you can identify the switch in the group by checking this checkbox. When you check the checkbox, the system status indicators on the physical switch (Setup, EIP NET, EIP Mod, Alarm) flash green for 4 minutes or until you clear this checkbox.
Time Remaining	Displays the amount of time that remains for the system status indicators to continue flashing while the Blink EIP LED checkbox is checked.

You can also monitor the switch status on the Module Info view.

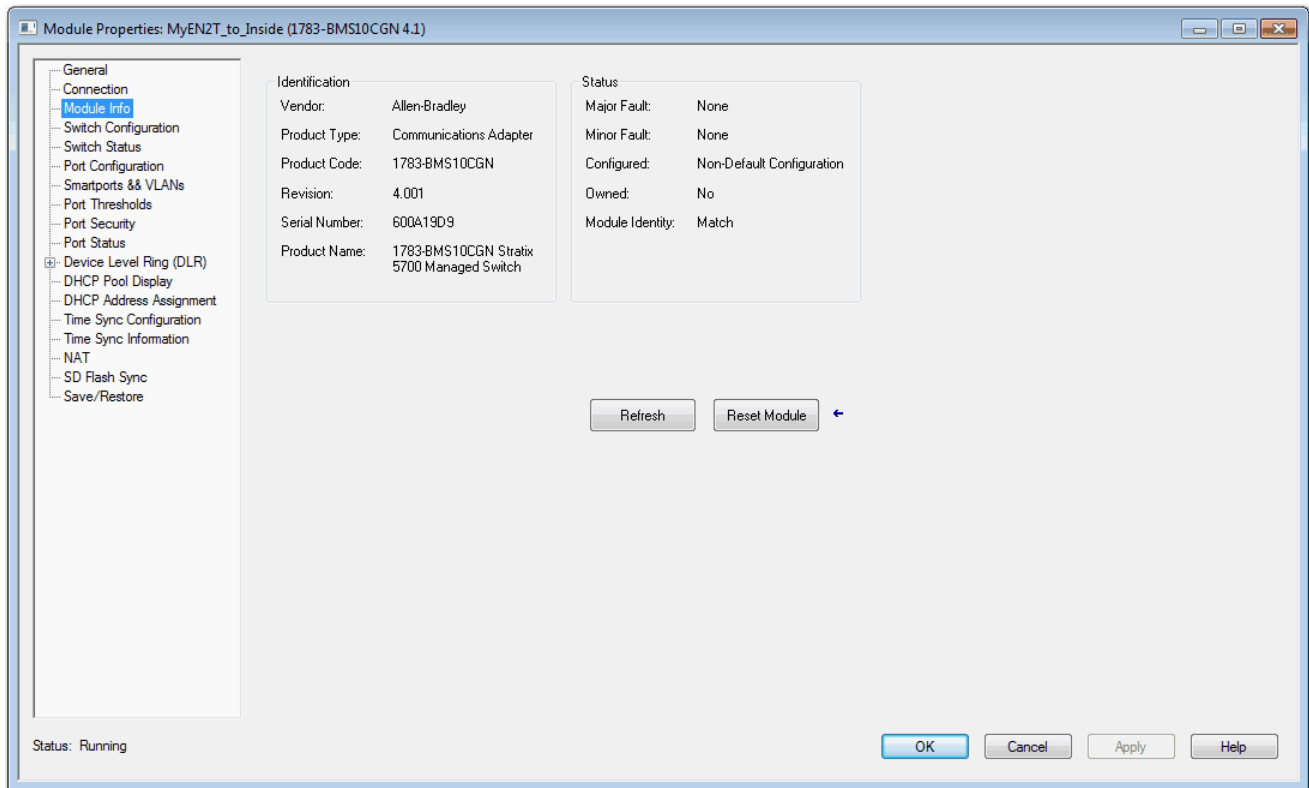

**Table 115 - Module Info Fields**

Field	Description
Identification	<p>Displays the following switch information:</p> <ul style="list-style-type: none"> <li>• Vendor</li> <li>• Product type</li> <li>• Product code</li> <li>• Revision</li> <li>• Serial number</li> <li>• Product name</li> </ul>
Status	<p>Displays the following status information:</p> <ul style="list-style-type: none"> <li>• Major/minor fault status                             <ul style="list-style-type: none"> <li>– None</li> <li>– Recoverable</li> <li>– Nonrecoverable</li> </ul> </li> <li>• Configuration                             <ul style="list-style-type: none"> <li>– Non-default configuration</li> <li>– Default configuration</li> </ul> </li> <li>• Owned                             <ul style="list-style-type: none"> <li>– Yes. There is an I/O connection.</li> <li>– No. There is not an I/O connection.</li> </ul> </li> <li>• Module identity                             <ul style="list-style-type: none"> <li>– Match. Agrees with what is specified on the General view. In order for the Match condition to exist, the vendor, product type, product code, and major revision must agree.</li> <li>– Mismatch. Does not agree with what is specified on the General view.</li> </ul> </li> </ul> <p>The Module Identity field does not consider the Electronic Keying or Minor Revision selections for the switch that were specified on the General view.</p>

## Port Status

In the navigation pane, click Port Status.

You can monitor alarms, statuses, thresholds, and bandwidth utilization for each switch port. You can also access port and cable diagnostics.

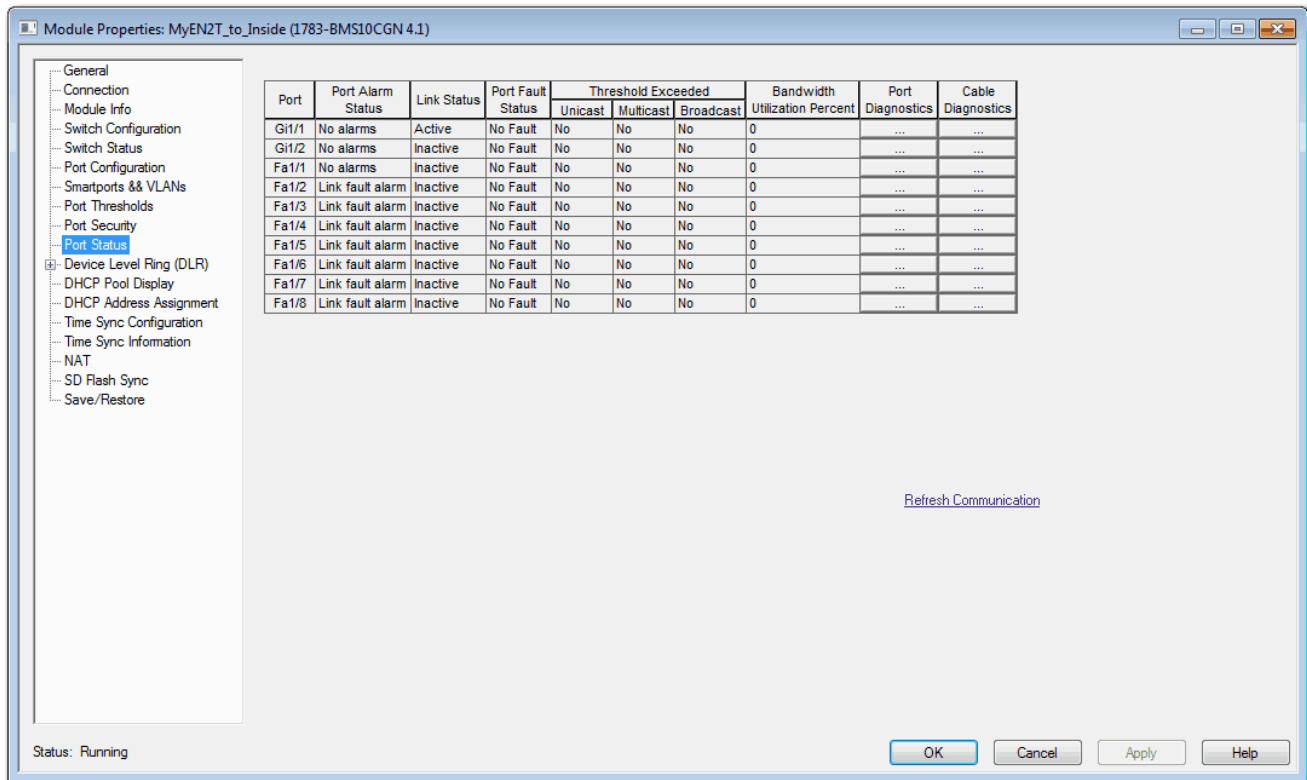

Table 116 - Port Status Fields

Field	Description
Unit (Stratix 8000/8300 switches)	Indicates where the port resides: <ul style="list-style-type: none"> <li>• Base (for example, 1783-MS10T).</li> <li>• Expansion module (for example, 1783-MX08T).</li> </ul>
Port	Displays the selected port. The port number includes the port type (Fa for Fast Ethernet and Gi for Gigabit Ethernet) and the specific port number. <b>EXAMPLE:</b> Gi1/1 is Gigabit Ethernet port 1.
Port Alarm Status	Displays the status of the port alarm. Valid values: <ul style="list-style-type: none"> <li>• Link fault alarm</li> <li>• Port not forwarding alarm</li> <li>• Port not operating alarm</li> <li>• High bit error rate alarm</li> <li>• No alarms</li> </ul>
Link Status	Displays whether the link is active or inactive.
Port Fault Status	Displays the status of the port alarm. Valid values: <ul style="list-style-type: none"> <li>• Error - Disable event</li> <li>• SFP error - Disabled</li> <li>• CDP native VLAN mismatch</li> <li>• MAC address flap</li> <li>• Port security violation</li> <li>• No fault</li> </ul>

**Table 116 - Port Status Fields (Continued)**

Field	Description
Threshold Exceeded	Displays unusual changes for these types of network traffic: <ul style="list-style-type: none"> <li>• Unicast—Displays Yes or No to indicate whether the current unicast traffic has exceeded the threshold value.</li> <li>• Multicast—Displays Yes or No to indicate whether the current multicast traffic has exceeded the threshold value.</li> <li>• Broadcast—Displays Yes or No to indicate whether the current broadcast traffic has exceeded the threshold value.</li> </ul>
Bandwidth Utilization Percent	Displays the percentage of the bandwidth being used. Note whether the percentage of usage is what you expect during the given time of network activity. If usage is higher than expected, an issue can exist.
Port Diagnostics	Click to display information to diagnose a network performance issue for the corresponding port. See <a href="#">page 329</a> .
Cable Diagnostics	Click to display information to diagnose a cable issue for the corresponding port. See <a href="#">page 334</a> .

## System Log Messages

In Device Manager, the system log displays events that occur on the switch and its ports. The events are based on the Alarm Settings you configure on the Configure > Alarm Settings page.

From the Monitor menu, choose Syslog.

Time Stamp	Severity	Description
Mar 1 00:00:18	debugging	Read env variable - LICENSE_BOOT_LEVEL =
Mar 30 01:27:41	informational	%IOS_LICENSE_IMAGE_APPLICATION-6-LICENSE_LEVEL: Module name = ie2k Next reboot level = lanlite and Lice...
Mar 30 01:27:49	notifications	%LINEPROTO-5-UPDOWN: Line protocol on Interface Vlan1, changed state to down
Mar 30 01:27:50	notifications	%SPANTREE-5-EXTENDED_SYSID: Extended SysId enabled for type vlan
Mar 30 01:27:55	notifications	%LINEPROTO-5-UPDOWN: Line protocol on Interface Vlan500, changed state to down
Mar 30 01:27:56	notifications	%SYS-5-CONFIG_I: Configured from memory by console
Mar 30 01:27:57	notifications	%LINK-5-CHANGED: Interface Vlan1, changed state to administratively down
Mar 30 01:27:58	notifications	%SYS-5-RESTART: System restarted --
Mar 30 01:27:58	errors	%LINK-3-UPDOWN: Interface FastEthernet1/1, changed state to up
Mar 30 01:28:01	informational	%USB_CONSOLE-6-MEDIA_RJ45: Console media-type is RJ45.
Mar 30 01:28:01	notifications	%LINEPROTO-5-UPDOWN: Line protocol on Interface Vlan500, changed state to up
Mar 30 01:28:02	notifications	%LINEPROTO-5-UPDOWN: Line protocol on Interface FastEthernet1/1, changed state to up
Mar 30 01:28:02	debugging	CDP-EV: RCV DDP packet on FastEthernet1/1 with len (1)
Mar 30 01:28:02	debugging	CDP Packet Process DONE
Jan 29 15:12:05	informational	%SYS-6-CLOCKUPDATE: System clock has been updated from 01:28:30 UTC Wed Mar 30 2011 to 15:12:05 UTC W...
Jan 31 20:30:29	notifications	%LINEPROTO-5-UPDOWN: Line protocol on Interface Vlan500, changed state to down
Jan 31 20:30:31	notifications	%LINEPROTO-5-UPDOWN: Line protocol on Interface Vlan500, changed state to up

To filter historical events, choose a severity filter or type filter:

- Debugging—Debug messages.
- Informational—Informational messages.
- Notifications—The switch is operating normally but has a significant condition.
- Warnings—The switch has a warning condition.
- Errors—The switch has an error condition.
- Critical—The switch has a critical condition.
- Alerts—The switch requires immediate action.
- Emergencies—The switch is unusable.

Click Clear Log to acknowledge that you have read the alerts. The Clear Log button does not resolve the issue.

**Table 117 - Syslog Fields**

Field	Description
Time Stamp	The date and time the event occurred. Use the Express Setup page to connect the device to an NTP server. Time settings are lost if the switch loses power.
Severity Level	The type and severity of the event.
Description	The description of the problem, including the port on which the problem was detected.

## Trends

In Device Manager, you can view historical data to help you to analyze traffic patterns and to identify problems. Data can be displayed in increments of seconds, minutes, hours, or days.

To view the data in a table, click the Grid Mode button below the area. To display a chart, click the Chart Mode button. Use the 60 s, 1 h, 1 d, and 1 w links to display the data in increments of 60 seconds, 1 hour, 1 day, or 1 week.

From the Monitor menu, choose Trends.

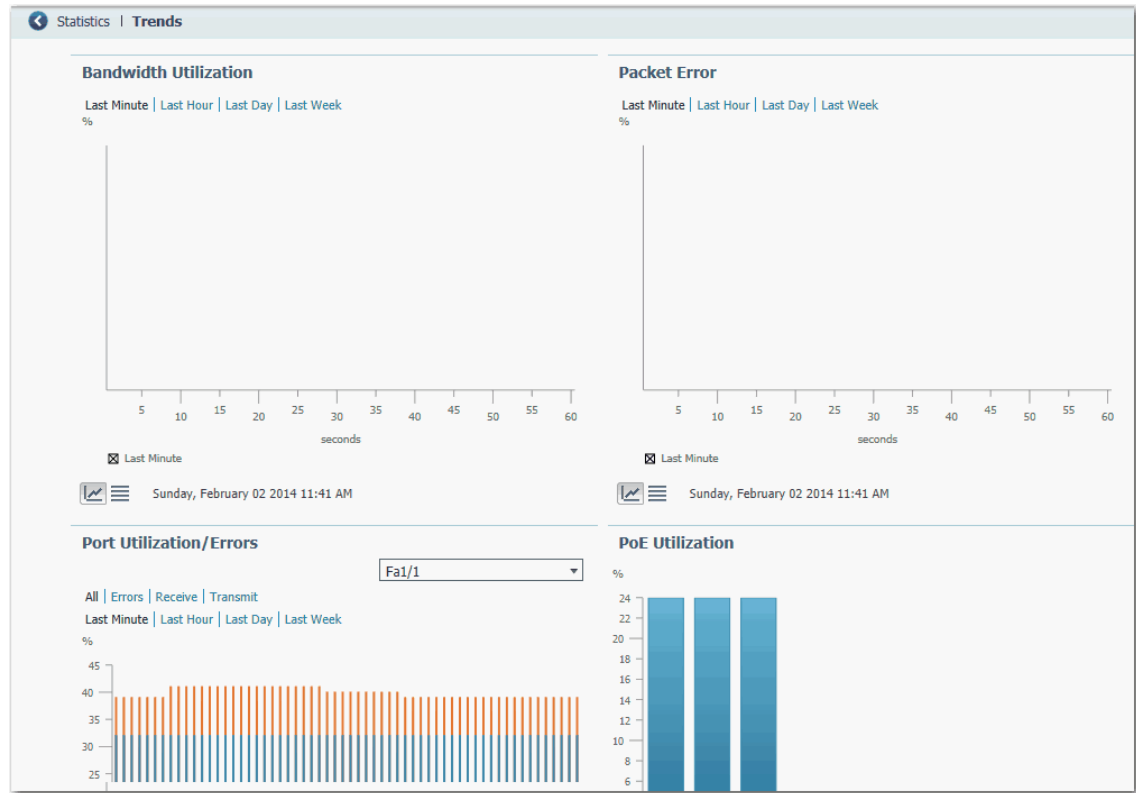

**Table 118 - Trends Graphs**

Graph	Description
Bandwidth Utilization	The Bandwidth Utilization graph indicates the percentage of the available bandwidth that was used. The graph can show the bandwidth usage patterns over incremental instances in time (by 60 seconds, 60 minutes, 24 hours, or 14 days). This graph also marks the highest peak reached. The default is 60 seconds. You can use this data to determine when network usage is high or low.
Packet Error	The Packet Error graph shows the percentage of packet errors that are collected over incremental instances in time (by 60 seconds, 60 minutes, 24 hours, or 14 days). The default is 60 seconds. Use this graph to audit the effect that connected devices have on the switch performance or the network. For example, if you suspect that a connected device is sending error packets, you can verify if the data on the graph changes when you disconnect and reconnect the device.
Port Utilization/Errors	The Port Utilization/Errors graph shows the usage patterns of a specific port over incremental instances in time by 60 seconds, 60 minutes, 24 hours, or 14 days. The default is 60 seconds. To display the trends for a specific port, choose a port from the Port list. Use these graphs to observe the performance of a specific port. For example, if a network user is having intermittent network connectivity, use the Port Utilization graph to observe the traffic patterns on the port to which the computer is connected. You can also use the Port Errors graph to see if the port is receiving or sending error packets.
PoE Utilization	For PoE switches, the PoE Utilization graph shows the power that is allocated to the connected devices.

## Port Statistics

In Device Manager, you can view statistics for data that passes through the switch ports. If you use Parallel Redundancy Protocol (PRP), ports that belong to a PRP channel configured on a RedBox are marked with an asterisk (\*). For more information about configuring PRP channels, see [page 222](#).

From the Monitor menu, choose Port Statistics.

Port	Transmitted	Total Transmitted(pack...)	Received	Total Received(pack...)	Total Transmit Error...	Total Receive Errors(pa...	Last Counter Reset
Fa1/1	33764761	96559	44484571	439844	0	0	never
Fa1/2	0	0	0	0	0	0	never
Fa1/3	0	0	0	0	0	0	never
Fa1/4	0	0	0	0	0	0	never
Fa1/5	0	0	0	0	0	0	never
Fa1/6	30140537	255358	7529823	71567	0	0	never

**Table 119 - Port Statistics**

Tab	Description
Overview	Displays the number of error packets that is received and sent from the port. This level of detail is not available from the Dashboard graphs. The number of error packets can mean a duplex mismatch, incompatibilities with the port and its attached device, or faulty cables or attached devices. Any of these problems can cause slow network performance, data loss, or lack of connectivity.
Transmit Detail	Use this tab to troubleshoot unusual changes in network traffic. This tab displays these statistics: <ul style="list-style-type: none"> <li>• Unicast, multicast, and broadcast packets that are sent from each port</li> <li>• Detailed statistics of errors that are sent to each port</li> </ul> If a port is sending an unusually high amount of traffic, such as multicast or broadcast packets, monitor the connected device to see whether the traffic pattern is normal.
Receive Detail	Use this tab to troubleshoot unusual changes in network traffic. This tab displays these statistics: <ul style="list-style-type: none"> <li>• Unicast, multicast, and broadcast packets that are received on each port</li> <li>• Detailed statistics of errors that are received on each port</li> </ul> If a port is receiving an unusually high amount of traffic, such as multicast or broadcast packets, monitor the connected device to see whether the traffic pattern is normal.



## NAT Statistics

You can monitor NAT statistics in both Device Manager and the Logix Designer application.

### Monitor NAT Statistics via Device Manager

You can monitor these types of NAT statistics:

- Global statistics for all instances
- Statistics per instance
- Detailed private translations per instance
- Detailed public translations per instance

From the Monitor menu, choose NAT Statistics.

**Figure 55 - NAT Statistics for Stratix 5400 and 5700 Switches**

Statistics | NAT Statistics

▼ Global Statistics

Current Active Translations

Total Translations

Total NAT Translated Packets

Total Dropped Packets

▼ Instance Statistics

Selected NAT Instance:

Current Active Translations

Total NAT Translation Packets

Total Dropped Packets

Total Private to Public Translations

Total Public to Private Translations

Total Translations

ARP Fixup

ICMP Fixup

Total Fixups

Non-Translated Unicast Traffic

Multicast Traffic

IGMP Traffic

Figure 56 - NAT Statistics for Stratix 5410

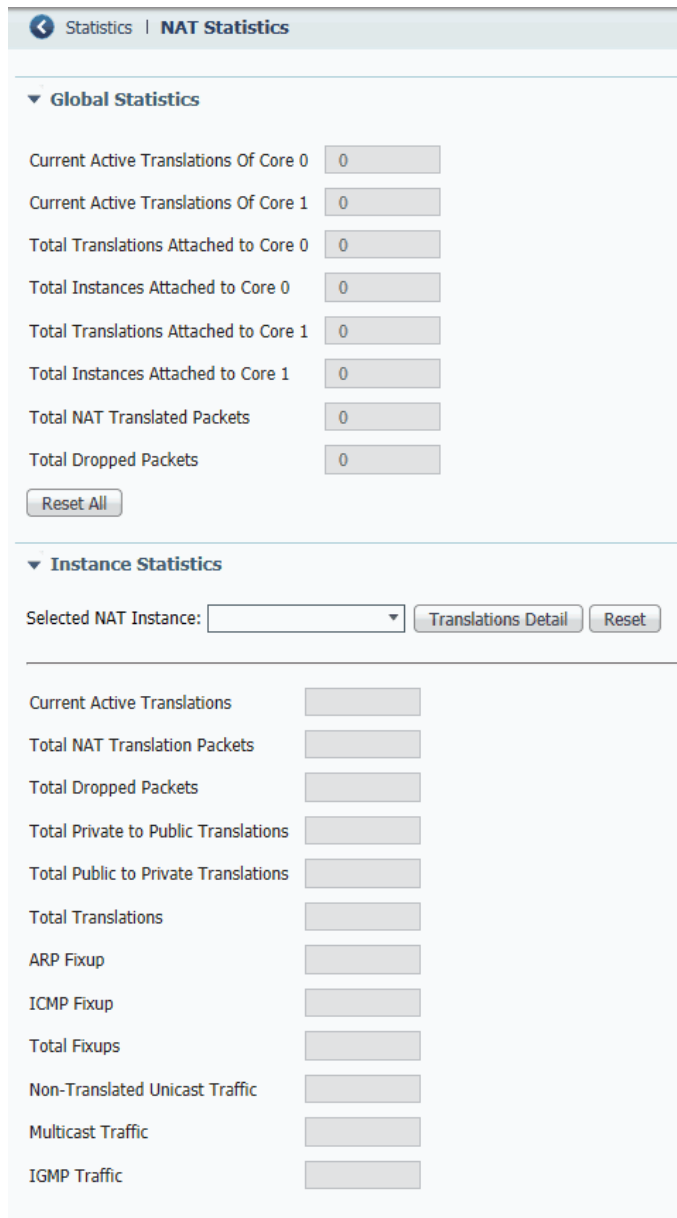

Table 120 - NAT Statistics

Field	Description
<b>Global Statistics for Stratix 5400 and 5700 Switches</b>	
Current Active Translations	The number of IP addresses that have been translated within the last 90 seconds across all NAT instances.
Total Translations	The total number of translations across all NAT instances.
Total NAT Translated Packets	The total number of packets across all NAT instances.
Total Dropped Packets	The total number of packets that have been dropped across all NAT instances.
<b>Global Statistics for Stratix 5410 Switches</b>	
Current Active Translations of Core 0	The number of IP addresses that have been translated within the last 90 seconds across all NAT instances for ports 1...6 and 13...18.
Current Active Translations of Core 1	The number of IP addresses that have been translated within the last 90 seconds across all NAT instances for ports 7...12, 19...24, and 25...28.

**Table 120 - NAT Statistics (Continued)**

<b>Field</b>	<b>Description</b>
Total Translations Attached to Core 0	The total number of translations across all NAT instances for ports 1...6 and 13...18.
Total Instances Attached to Core 0	The total number of NAT instances across ports 1...6 and 13...18.
Total Translations Attached to Core 1	The total number translations across all NAT instances for ports 7...12, 19...24, and 25...28.
Total Instances Attached to Core 1	The total number of NAT instances across ports 7...12, 19...24, and 25...28.
Total NAT Translated Packets	The total number of packets across all NAT instances for all ports.
Total Dropped Packets	The total number of packets that have been dropped across all NAT instances for all ports.
<b>Instance Statistics</b>	
Selected Instance	From the pull-down menu, choose the instance for which to view statistics.
Current Active Translations	The number of translations that have occurred within the last 90 seconds for the instance.
Total NAT Translated Packets	The total number of packets that have been translated for the instance.
Total Dropped Packets	The total number of packets that have been dropped for the instance.
Total Private to Public Address Translations	The total number of translations that are configured for devices on the private subnet.
Total Public to Private Address Translations	The total number of translations that are configured for devices on the public subnet.
Total Translations	The total number of translations that are configured for the instance.
ARP Fixup	The number of ARP packets that have been fixed up for the instance.
ICMP Fixup	The number of ICMP packets that have been fixed up for the instance.
Total Fixups	The total number of ARP and ICMP packets that have been fixed up for the instance.
Non-Translated Unicast Traffic	The number of packets with untranslated unicast traffic for the instance.
Multicast Traffic	The number of packets with multicast traffic for the instance.
IGMP Traffic	The number of packets with IGMP traffic for the instance.

## Monitor NAT Statistics via the Logix Designer Application

For each NAT instance, you can monitor these diagnostics:

- Diagnostics for both private and public translations
- Diagnostics for only private translations
- Diagnostics for only public translations

In the navigation pane, click NAT, and then click the ellipse in the Diagnostics column.

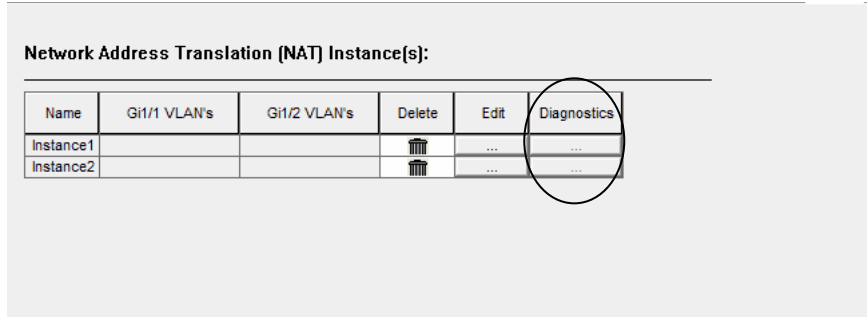

The NAT Diagnostics dialog box displays diagnostics for the selected instance.

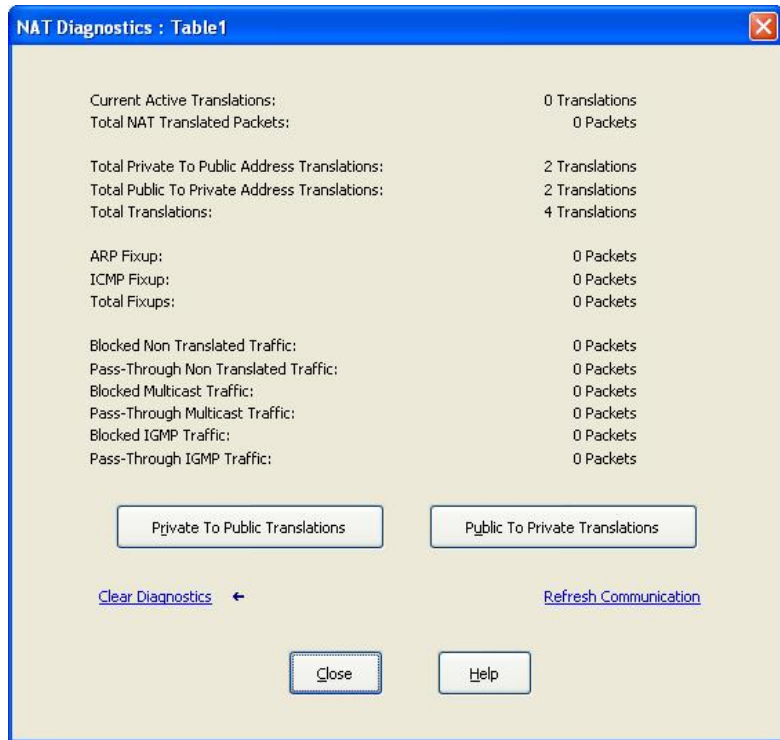

**Table 121 - NAT Diagnostics per Instance**

Field	Description
Current Active Translations	Displays the number of translations that have occurred within the last 90 seconds across all NAT instances.
Total NAT Translated Packets	Displays the total number of packets that have been translated for this instance.
Total Private to Public Address Translations	Displays the total number of private-to-public translations for this instance.
Total Public to Private Address Translations	Displays the total number of public-to-private translations for this instance.
ARP Fixup	Displays the number of ARP packets that have been fixed up for this instance.
ICMP Fixup	Displays the number of ICMP packets that have been fixed up for this instance.
Total Fixups	Displays the number of ARP and ICMP packets that have been fixed up for this instance.
Incoming Non Translated Traffic (Pass-Through)	Displays the number of incoming packets with untranslated traffic that NAT passed through for this instance.
Outgoing Non Translated Traffic (Blocked)	Displays the number of outgoing packets with untranslated traffic that NAT blocked for this instance.
Incoming Multicast Traffic (Blocked)	Displays the number of incoming packets with multicast traffic that NAT blocked for this instance.
Outgoing Multicast Traffic (Pass-Through)	Displays the number of outgoing packets of multicast traffic that NAT passed through for this instance.
Incoming IGMP Traffic (Blocked)	Displays the number of incoming packets with IGMP traffic that NAT blocked for this instance.
Outgoing IGMP Traffic (Blocked)	Displays the number of outgoing packets with IGMP traffic that NAT blocked for this instance.
Private to Public Translations	Click to view private-to-public translation diagnostics for the instance. See <a href="#">Table 122</a> .
Public to Private Translations	Click to view public-to-private translation diagnostics for the instance. See <a href="#">Table 123</a> .

From the Private to Public Translations dialog box for an instance, you can view a list of IP addresses that have been changed by NAT within the last 90 seconds.

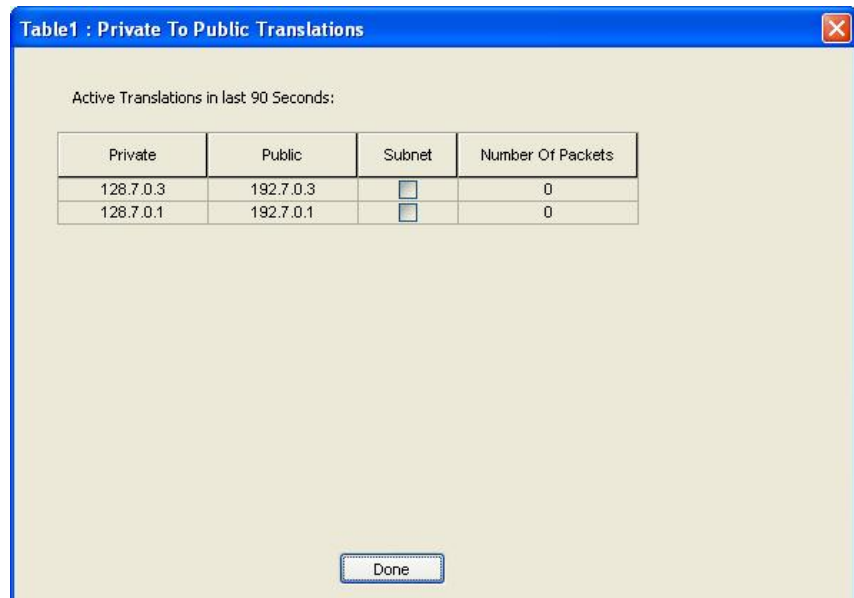
**Table 122 - Private-to-Public Translation Diagnostics**

Field	Description
Private	Displays the existing address for a device on the private subnet.
Public	Displays a unique public address that represents the corresponding device on the private subnet.
Subnet	Indicates whether the translation is part of a Subnet entry type.
Number of Packets	Displays the number of packets that contain the translation.

From the Public to Private Translations dialog box for an instance, you can view a list of IP addresses that have been changed by NAT within the last 90 seconds.

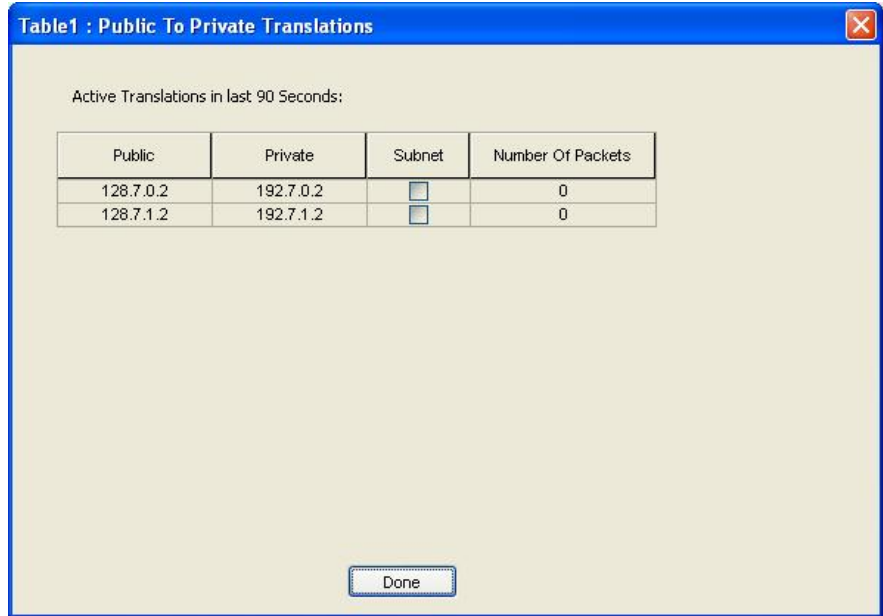

**Table 123 - Public-to-Private Translation Diagnostics**

Field	Description
Public	Displays the unique IP address on the public subnet that represents the corresponding IP address on the private subnet.
Private	Displays the IP address on the private subnet that was changed to a unique IP address on the public subnet.
Subnet	Indicates whether the translation is part of a Subnet entry type.
Number of Packets	Displays the number of packets that contain the translation.

## NetFlow

In Device Manager, you can view NetFlow exporter and monitor cache statistics. The key components of NetFlow are the cache that stores IP flow information, and the export mechanism that sends NetFlow data to a network management collector, such as the NetFlow Collection Engine. NetFlow operates by creating a NetFlow cache entry (a flow record) for each active flow. NetFlow maintains a flow record within the cache for each active flow. Each flow record in the NetFlow cache contains fields that can later be exported to a collection device, such as the NetFlow Collection Engine.

From the Monitor menu, choose NetFlow:

- On the Exporter tab, choose a flow exporter from the pull-down menu or choose ALL to display statistics for all flow exporters that are configured on the switch. Click Show to display statistics. Click Clear to clear the statistics.

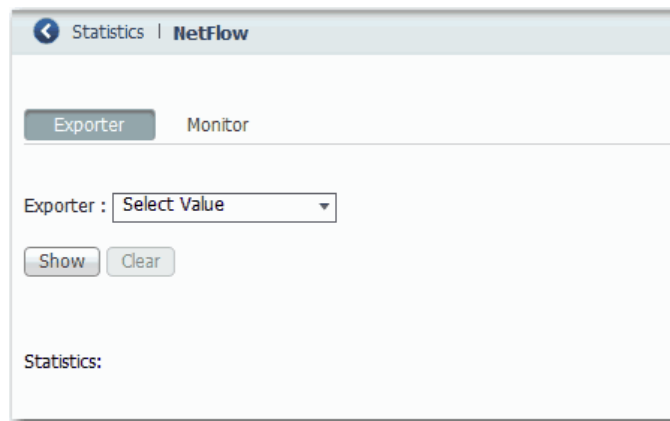

- On the Monitor tab, choose a flow monitor from the pull-down menu. Click Show to display statistics. Click Clear to clear the statistics.

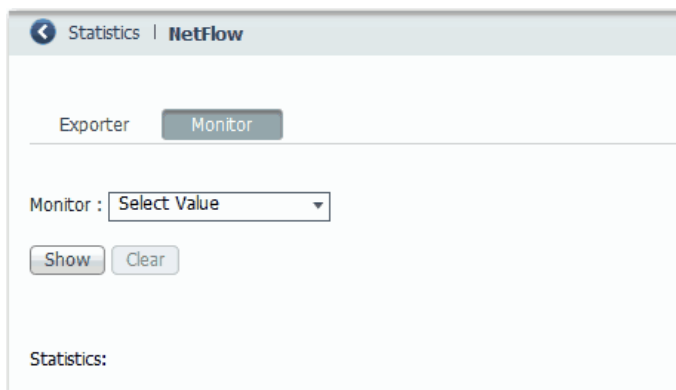

## REP Status

In Device Manager, you can review the status of the REP topology for one or all network segments.

From the Monitor menu, choose REP.

To display an archived REP topology, click the Archived Topology tab and then select the segment ID.

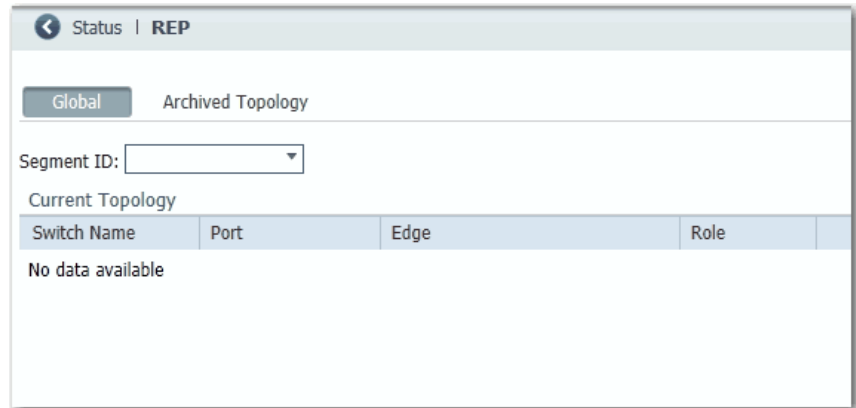

## CIP Status

In Device Manager, you can monitor Common Industrial Protocol (CIP) status. CIP is an application layer messaging protocol that is used by various industrial automation and control devices to communicate as part of a control system. CIP is the application layer for the EtherNet/IP network. Stratix switches contain an EtherNet/IP server that enables the switch to be part of the industrial automation and control system for basic management and monitoring.

The CIP Status page displays information about CIP status (Overview field) and statistics (Request Details field) for the following:

- When the switch was last powered on or restarted
- When the counters were last reset

To troubleshoot an issue, reset the CIP counters, and see if the counters show that the issue still exists.

---

**IMPORTANT** Except for Active Multicast Groups, all other categories are related to the CIP server in the switch. The categories pertain to CIP traffic directed to the switch as a CIP target device. The categories do not refer to CIP (EtherNet/IP) traffic that flows through the switch among these devices:

- Various CIP controllers
  - HMI devices
  - Configuration tools
  - Other CIP target devices, such as drives, I/O modules, motor starters, sensors, and valves
-



From the Monitor menu, choose CIP Status.

Overview			
State:	Disabled	Vlan:	
CIP I/O Connection Owner:	None	CIP Config Session Owner:	0.0.0.0
Management CPU Utilization:	4	Active Explicit Msg Connections:	0
Active I/O Connections:	0	Active Multicast Groups:	0

Connection Details			
Open Requests:	0	Close Requests:	0
Open Format Rejects:	0	Close Format Rejects::	0
Open Resource Rejects:	0	Close Other Rejects:	0
Open Other Rejects:	0	Connection Timeouts:	0

[Reset Counters](#)

**Table 124 - CIP Status Fields**

Field	Description
<b>Overview</b>	
State	The state of the CIP connection (Enabled or Disabled).
VLAN	The VLAN ID.
CIP I/O Connection Owner	The IP address of the device to and from which application-specific I/O output data is sent and received.
CIP Config Session Owner	The IP address of the device controlling the CIP configuration session.
Management CPU Utilization (%)	Percentage of the Management CPU used for management functions. Switch functions have dedicated ASICs. Management functions do not impact the ASICs.
Active Explicit Msg Connections	The number of active, explicit messaging connections to the switch as a target.
Active I/O Connections	The number of active I/O connections with the switch as a target.
Active Multicast Groups	The number of multicast groups, including CIP multicast groups that flow through the switch.
<b>Connection Details</b>	
Open Requests	The number of Forward Open requests received by the switch to establish a connection with the switch.
Close Requests	The number of Forward Close requests received by the switch after a connection was successfully established with the switch.
Open Format Rejects	The number of Forward Open requests directed to the switch that failed because the request is not in the proper format.
Close Format Rejects	The number of Forward Close requests directed to the switch that failed because the request is not in the proper format.
Open Resource Rejects	The number of Forward Open requests that failed to establish a new connection for reasons such as insufficient memory.
Close Other Rejects	The number of Forward Close requests that failed for reasons such as incompatible electronic keying.
Open Other Rejects	The number of Forward Open requests that failed for reasons such as incompatible electronic keying.
Connection Timeouts	The number of CIP connections that timed out due to inactivity.

## DHCP Clients

In Device Manager, you can view information about devices connected to a switch with DHCP snooping enabled. These devices are known as DHCP clients. The DHCP snooping feature dynamically builds and maintains entries in the DHCP Clients table shown below. For example, the feature removes an entry once its leased IP address expires.

---

**IMPORTANT** Information in the DHCP Clients table does not include DHCP devices in a Device Level Ring. For information about DHCP devices in a ring, see [DLR Status on page 323](#).

---

The table contains an entry for each device that meets this criteria:

- The device received its IP address from the switch via DHCP, and the IP address lease is active.
- A VLAN is assigned to the DHCP client port that connects to the switch, and DHCP snooping is enabled for that VLAN.

From the Monitor menu, choose DHCP Clients.

MacAddress	IPAddress	Lease(sec)	Type	VLAN	Interface
00:00:BC:38:07:98	10.89.240.128	infinite	dhcp-snooping	240	FastEthernet1/3

**Table 125 - DHCP Clients Table Fields**

Field	Description
MAC Address	The MAC ID of the DHCP client.
IP Address	The IP address the switch has assigned to the DHCP client.
Lease (sec)	The IP address lease time in seconds.
Type	Whether the IP address of the DHCP client was dynamically assigned from a pool of IP addresses or a statically configured to one or more specific IP addresses.
VLAN	The VLAN on which the DHCP address was assigned.
Interface	The port that connects to the DHCP client.

## DLR Status

You can monitor Device Level Ring (DLR) status in both Device Manager and the Logix Designer application.

Configuration parameters appear for the number of available rings:

- Stratix 5700 and ArmorStratix™ 5700 switches show one ring.
- Stratix 5400 switches show three rings.

For more information about DLR troubleshooting, see Troubleshoot EtherNet/IP Networks, publication [ENET-AT003](#).

### Monitor DLR Status via Device Manager

From the Monitor menu, choose DLR:

- The Overview tab shows the status and parameters that are configured for the switch, redundant gateway, ring DHCP server, and the active ring supervisor.

You can also clear these faults:

- Partial gateway faults that can occur when traffic is lost in only one direction. The active ring supervisor detects a partial fault by monitoring the loss of beacon frames on a port.
- Rapid faults that can occur after five intentional disconnections and reconnections of a node from the network within 30 seconds.

When the active ring supervisor detects either type of fault, it blocks traffic on the port, which results in network segmentation. To resolve this condition, you must manually clear the faults.

- The Ring Faults tab shows the number, time, and location of faults in a ring.
- The Ring Members tab lists the MAC and IP addresses of each device in a ring.

**Stratix 5400 Solution Device Manager - Switch**

Dashboard Configure Monitor Admin

Ring1 Ring2 Ring3

Overview **Faults** Members

**Switch DLR Status**

Topology	Ring
Status	Normal
Mode	Active Supervisor
Redundant GW	Active Gateway
MAC Address	F4:54:33:16:BC:85
IP Address	10.208.105.10
Port 1	GigabitEthernet1/5, vlan 533, UP
Port 2	GigabitEthernet1/6, vlan 533, UP

**DHCP Server Status**

Current Role	Backup
Status	Not in Active or Standby state.

**Redundant Gateway**

Status	Active Gateway
Advertise Interval	2000
Advertise Timeout	5000
GW Precedence	200
Learning Enabled	yes
Uplink Port(s)	GigabitEthernet1/1 GigabitEthernet1/2

**Active Ring Supervisor**

Supervisor MAC	F4:54:33:16:BC:85
Supervisor IP	10.208.105.10
Beacon Interval	400
Beacon Timeout	1960
Supervisor Precedence	200
VLAN ID	0

Clear Partial Gateway Fault Clear Rapid Faults

**Stratix 5400 Solution Device Manager - Switch**

Dashboard Configure Monitor Admin

Ring1 Ring2 Ring3

Overview **Faults** Members

Ring Faults since power up 93 Clear Ring Faults

Time of Last Fault 15:05:08 EDT Wed Aug 3 2016

Ring Fault Location	MAC Address	IP Address
Last Active Node on Port 1	F4:54:33:5D:50:81	10.208.105.16
Last Active Node on Port 2	F4:54:33:16:BC:85	10.208.105.10

The screenshot shows the Stratix 5400 Solution Device Manager - Switch interface. The top navigation bar includes Dashboard, Configure, Monitor, and Admin. Below the navigation bar, there are tabs for Ring1, Ring2, and Ring3. Under Ring1, there are sub-tabs for Overview, Faults, and Members. The Members tab is active, displaying a table with 17 rows of node information.

Node	MAC Address	IP Address
1	F4:54:33:16:BC:85	10.208.105.10
2	F4:54:33:15:B0:81	10.208.105.14
3	F4:54:33:94:57:4B	10.208.105.140
4	F4:54:33:94:58:1B	10.208.105.139
5	F4:54:33:94:57:45	10.208.105.138
6	F4:54:33:94:58:0B	10.208.105.137
7	F4:54:33:16:52:05	10.208.105.13
8	F4:54:33:94:57:ED	10.208.105.109
9	F4:54:33:94:57:AB	10.208.105.108
10	F4:54:33:94:57:A1	10.208.105.107
11	F4:54:33:94:58:29	10.208.105.106
12	F4:54:33:94:57:CB	10.208.105.105
13	F4:54:33:94:57:FF	10.208.105.104
14	F4:54:33:94:57:C3	10.208.105.103
15	F4:54:33:94:57:5B	10.208.105.102
16	F4:54:33:94:56:B5	10.208.105.101
17	F4:54:33:94:57:E7	10.208.105.110

## Monitor DLR Status via the Logix Designer Application

From the navigation pane, expand Device Level Ring (DLR), expand Ring 1, Ring 2, or Ring 3, and then click one of the following:

- To view the status and parameters that are configured for the switch, the redundant gateway, and the active ring supervisor, click Statistics.
- To view the MAC and IP addresses of each device in the ring, click Members.

To obtain network diagnostic information via MSG instructions, see the EtherNet/IP Embedded Switch Technology Application Guide, publication [ENET-AP005](#).

**Device Level Ring(DLR)-Ring 1-Statistics**

Switch DLR Status		Active Ring Supervisor	
Network Topology:	Ring	Mode:	True
Network Status:	Ring Fault	Status:	Active
Supervisor Mode:	Active	MAC Address:	E4:90:69:97:88:0F
MAC Address:	00:00:00:00:00:00	IP Address:	192.168.1.32
IP Address:	0.0.0.0	Beacon Interval:	20000
Precedence:	15	Beacon Timeout:	40000
Port 1:	Fa1/15	Precedence:	15
Port 2:	Fa1/16	Ring Protocol VLAN ID:	0

Switch Redundant Gateway		Active Redundant	
Redundant Gateway:	Enabled	MAC Address:	00:00:00:00:00:00
Status:	Gateway Fault	IP Address:	0.0.0.0
Advertise Interval:	2000	Precedence:	0
Advertise Timeout:	5000		
Precedence:	0		
Send Learning Frame:	Enabled		
Uplink Port 1:	Fa1/13		
Uplink Port 2:	Fa1/14		

Status: Running

**Device Level Ring(DLR)-Ring 1-Members**

Ring Member	IP Address	MAC Address
1	192.168.1.32	E4:90:69:97:88:0F
2	192.168.1.14	00:00:BC:D1:2E:1F

Status: Running

## PRP Status

In Device Manager, you can view statistics for configured and learned Virtual DAN (VDAN) and node entries. The VDAN table shows the number of MAC IDs and the number of static nodes for each PRP channel group, as well as table entries. The Node table shows the total number of MAC IDs and MAC IDs of each node type for each PRP channel group, as well as table entries.

For more information about PRP, see the following:

- [Parallel Redundancy Protocol \(PRP\) on page 219.](#)
- [Stratix 5400 Display Modes on page 295](#)
- [Stratix 5410 Display Modes on page 298](#)

From the Monitor menu, choose PRP.

Channel Group	MAC Address	TTL	Dynamic
1	0062.6E52.E217	42	Y
1	F454.3327.8482	44	Y
1	F454.3315.D300	31	Y
1	E490.6998.B901	60	Y
1	F454.3315.D344	58	Y
1	F454.3337.5A86	34	Y
1	001D.9CC6.D7D1	56	Y

**Table 126 - VDAN Table Fields**

Field	Description
Channel Group 1, 2	The number of the PRP channel group.
MAC Count	The number of static and dynamic MAC IDs for the channel group.
Static	The number of static entries for the channel group.
<b>Grid Fields</b>	
Channel Group	The channel group of the associated entry.
MAC Count	The MAC ID of the VDAN.
TTL	The amount of time before the learned MAC ID expires.
Dynamic	Whether or not (Y or N) the entry was added as a learned MAC ID.

The screenshot shows the 'PRP Node Table' section of the device manager. It includes a summary table with the following data:

Channel Group:	1	Channel Group:	2
MAC Count:	11	MAC Count:	0
DAN Count:	9	DAN Count:	0
SAN-A Count:	1	SAN-A Count:	0
SAN-B Count:	1	SAN-B Count:	0

Below the summary is a detailed table with the following columns: Channel Group, MAC Address, TTL, Node, Packets Recd A, Packets Recd B, Wrong Packets A, and Wrong Packets B. The data rows are as follows:

Channel Group	MAC Address	TTL	Node	Packets Recd A	Packets Recd B	Wrong Packets A	Wrong Packets B
1	0062.6E52.E217	60	dan	36	47	0	0
1	F454.3327.8482	60	dan	26	31	0	0
1	34C0.F910.C483	45	lan-b	0	21	0	0
1	F454.3315.D300	60	dan	26	32	0	0
1	F454.3304.9708	54	dan	21	27	0	0
1	E490.6998.B901	60	dan	27	31	0	0
1	F454.3315.D344	60	dan	34	41	0	0

Table 127 - Node Table Fields

Field	Description
Channel Group 1, 2	The number of the PRP channel group.
MAC Count	The number of static and dynamic MAC IDs for the channel group.
DAN	The number of dual attached node (DAN) MAC IDs for the channel group.
SAN-A	The number of single attached nodes (SANs) on LAN A.
SAN-B	The number of single attached nodes (SANs) on LAN B.
<b>Grid Fields</b>	
Channel Group	The channel group of the associated entry.
MAC Address	The MAC ID of the DAN or SAN.
TTL	The amount of time before the learned MAC ID expires.
Node	The type of PRP node: <ul style="list-style-type: none"> <li>• DAN—Dual attached node</li> <li>• SAN-A—Single attached node on LAN A</li> <li>• SAN-B—Single attached node on LAN B</li> </ul>
Packets Recd A	The number of packets received on LAN A.
Packets Recd B	The number of packets received on LAN B.
Wrong Packets A	The number of packets received on LAN A having the wrong LAN A destination.
Wrong Packets B	The number of packets received on LAN B having the wrong LAN B destination.



## STP Status

In Device Manager, you can view spanning tree information for Multiple Spanning Tree (MST) or Rapid Spanning Tree Protocol (RSTP).

From the Monitor menu, choose STP.

On the RSTP tab, choose a VLAN ID to monitor and click Submit.

Interface	Role	Sts	Cost	Priority	Type
Gi1/1	Root	FWD	19	128.1	P2p

**Table 128 - RSTP Tab Fields**

Field	Description
<b>Root</b>	
Priority	The priority indicator.
Address	The MAC ID of the port.
Cost	The cost associated with the port.
Port	The identifier of the named port.
Hello	The amount of time, in seconds, that the bridge sends bridge protocol data units (BPDUs).
Max Age	The amount of time, in seconds, that a bridge protocol data unit (BPDU) packet should be considered valid.
Forward Delay	The amount of time, in seconds, that the port spends in listening or learning mode.
<b>Bridge</b>	
Priority	The priority indicator.
Address	The MAC ID of the port.
Hello	The amount of time, in seconds, that the bridge sends bridge protocol data units (BPDUs).
Max Age	The amount of time, in seconds, that a BPDU packet should be considered valid.
Forward Delay	The amount of time, in seconds, that the port spends in listening or learning mode.
<b>Port Statistics</b>	
Interface	The interface type and number of the port.

**Table 128 - RSTP Tab Fields (Continued)**

Field	Description
Role	Current 802.1w role: <ul style="list-style-type: none"> <li>• Boun—Boundary</li> <li>• Desg—Designated</li> <li>• Root</li> <li>• Altn—Alternate</li> <li>• Back—Backup</li> </ul>
Sts	Spanning-tree states: <ul style="list-style-type: none"> <li>• BLK—Blocked: The port is still sending and listening to BPDU packets but is not forwarding traffic.</li> <li>• DIS—Disabled: The port is not sending or listening to BPDU packets and is not forwarding traffic.</li> <li>• FWD—Forwarding: The port is sending and listening to BPDU packets and forwarding traffic.</li> <li>• LBK—Loopback: The port receives its own BPDU packet back.</li> <li>• LIS—Listening: The port spanning tree initially starts to listen for BPDU packets for the root bridge.</li> <li>• LRN—Learning: The port sets the proposal bit on the BPDU packets it sends out.</li> </ul>
Cost	The STP path cost associated with the port.
Priority	The priority indicator.
Type	The link type of the port: <ul style="list-style-type: none"> <li>• P2p—Point to point: The interface is a point-to-point link.</li> <li>• Shr—Shared: The interface is a shared medium.</li> </ul>

On the MST tab, choose an MST instance ID to monitor and click Submit.

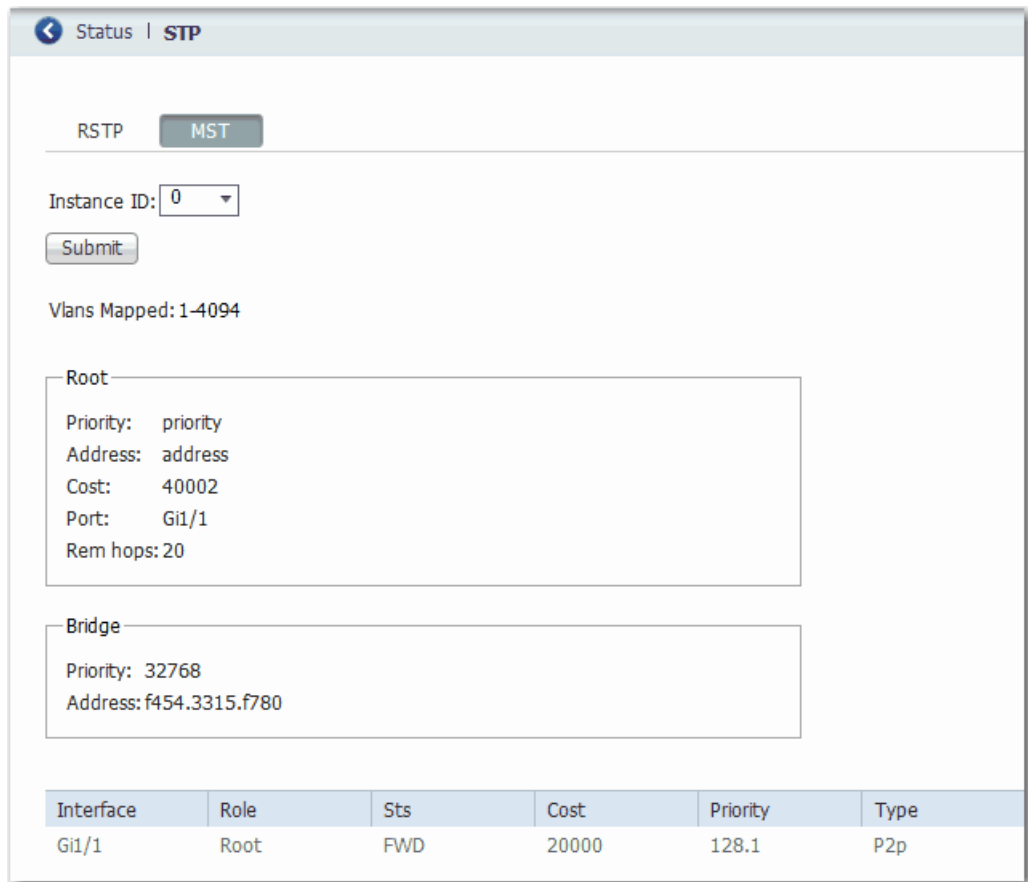

**Table 129 - MST Tab Fields**

Field	Description
Vlans Mapped	The VLANs mapped to the selected instance.
<b>Root</b>	
Priority	The priority indicator.
Address	The MAC ID of the port.
Cost	The root path cost.
Port	The root port ID.
Rem hops	The number of hops remaining of the maximum hop count after each downstream switch decrements the hop count.
<b>Bridge</b>	
Priority	The priority indicator.
Address	The MAC ID of the port.
<b>Port Statistics</b>	
Interface	The interface type and number of the port.
Role	The current 802.1w role: <ul style="list-style-type: none"> <li>• Boun—Boundary</li> <li>• Desg—Designated</li> <li>• Root</li> <li>• Altn—Alternate</li> <li>• Back—Backup</li> </ul>
Sts	Spanning-tree states: <ul style="list-style-type: none"> <li>• BLK—Blocked: The port is still sending and listening to BPDU packets but is not forwarding traffic.</li> <li>• DIS—Disabled: The port is not sending or listening to BPDU packets and is not forwarding traffic.</li> <li>• FWD—Forwarding: The port is sending and listening to BPDU packets and forwarding traffic.</li> <li>• LBK—Loopback: The port receives its own BPDU packet back.</li> <li>• LIS—Listening: The port spanning tree initially starts to listen for BPDU packets for the root bridge.</li> <li>• LRN—Learning: The port sets the proposal bit on the BPDU packets it sends out.</li> </ul>
Cost	The path cost of the port.
Priority	The port priority.
Type	Link type of the port: <ul style="list-style-type: none"> <li>• P2p—Point to point: The interface is a point-to-point link.</li> <li>• Shr—Shared: The interface is a shared medium.</li> </ul>

## Port Diagnostics

The Port Diagnostics feature in the Logix Designer application lets you view the status of the link performance:

- View octet and packet counters
- View collisions on the link
- View errors on the link

You can also reset and clear all status counters.

In the navigation pane, click Port Status, and then click the button in the Port Diagnostics column for the corresponding port.

Port	Port Alarm Status	Link Status	Port Fault Status	Threshold Exceeded			Bandwidth Utilization Percent	Port Diagnostics	Cable Diagnostics
				Unicast	Multicast	Broadcast			
Gi1/1	No alarms	Active	No Fault	No	No	No	0	...	...
Gi1/2	No alarms	Inactive	No Fault	No	No	No	0	...	...
Fa1/1	No alarms	Inactive	No Fault	No	No	No	0	...	...
Fa1/2	Link fault alarm	Inactive	No Fault	No	No	No	0	...	...
Fa1/3	Link fault alarm	Inactive	No Fault	No	No	No	0	...	...
Fa1/4	Link fault alarm	Inactive	No Fault	No	No	No	0	...	...
Fa1/5	Link fault alarm	Inactive	No Fault	No	No	No	0	...	...
Fa1/6	Link fault alarm	Inactive	No Fault	No	No	No	0	...	...
Fa1/7	Link fault alarm	Inactive	No Fault	No	No	No	0	...	...
Fa1/8	Link fault alarm	Inactive	No Fault	No	No	No	0	...	...

**Port Diagnostics** X

Port: Gi1/1

<b>Interface Counters</b>		<b>Media Counters</b>	
Octets In:	322151029	Alignment Errors:	0
Octets Out:	32178733	FCS Errors:	0
Ucast Packets In:	802970	Single Collisions:	0
Ucast Packets Out:	700714	Multiple Collisions:	0
NUcast Packets In:	1983187	SQE Test Errors:	0
NUcast Packets Out:	65265	Deferred Transmissions:	0
Discards In:	0	Late Collisions:	0
Discards Out:	0	Excessive Collisions:	0
Errors In:	0	MAC Xmit Errors:	0
Errors Out:	0	MAC Recv Errors:	0
% Error Rate:	0	Carrier Sense:	0
Unknown Protos In:	0	Frame Too Long:	0

Refresh
Reset Counters
Close
Help

Table 130 - Port Diagnostics Fields

Field	Description
Unit (Stratix 8000/8300 switches)	Indicates where the port resides: <ul style="list-style-type: none"> <li>• Base (for example, 1783-MS10T).</li> <li>• Expansion module (for example, 1783-MX08T).</li> </ul>
Port	The port that is selected for configuration. The port number includes the port type (Fa for Fast Ethernet and Gi for Gigabit Ethernet), the base or expansion module for Stratix 8000/8300 switches, and the specific port number. <b>EXAMPLE:</b> <ul style="list-style-type: none"> <li>• Gi1/1 is Gigabit Ethernet port 1 on the base.</li> <li>• Fa2/1 is Fast Ethernet port 1 on the first expansion module.</li> </ul>
Interface Counters	These counters let you view status of octets received and sent, and packets received and sent: <ul style="list-style-type: none"> <li>• Octets In—The number of octets that are received by the port.</li> <li>• Octets Out—The number of octets that are sent by the port.</li> <li>• Ucast Packets In—The number of unicast packets that are received by the port.</li> <li>• Ucast Packets Out—The number of unicast packets that are sent by the port.</li> <li>• NUcast packets In—The number of multicast packets that are received by the port.</li> <li>• NUcast packets Out—The number of multicast packets that are sent by the port.</li> <li>• Discards In—The number of inbound packets that have been discarded.</li> <li>• Discards Out—The number of outbound packets that have been discarded.</li> <li>• Errors In—The number of inbound packets that contain errors.</li> <li>• Errors Out—The number of outbound packets that contain errors.</li> <li>• Unknown Protos (Protocols) In —The number of inbound packets with unknown protocols.</li> </ul>
Media Counters	These counters let you view the number of collisions on a link: Collision counters: <ul style="list-style-type: none"> <li>• Single—The number of single collisions.</li> <li>• Multiple—The number of multiple collisions.</li> <li>• Late —The number of late collisions.</li> <li>• Excessive—The number of frames for which transmission fails due to excessive collisions.</li> </ul> Error counters: <ul style="list-style-type: none"> <li>• Alignment—The number of frames received that are not an integral number of octets in length.</li> <li>• FCS (Frame Check Sequence)—The number of frames received that do not pass the FCS check.</li> <li>• SQE Test Errors —The number of times that the SQE TEST ERROR message is generated.</li> <li>• Deferred Transmissions—The count of transmissions that are deferred by busy network.</li> <li>• MAC Xmit Errors—The number of frames that failed to transmit due to an internal MAC sublayer transmit error.</li> <li>• MAC Recv Errors—The number of frames that failed to be received due to an internal MAC sublayer receive error.</li> <li>• Carrier Sense—The number of times the carrier sense condition was lost or never asserted when attempting to transmit a frame.</li> <li>• Frame Too Long —The number of frames received that exceed the maximum permitted frame size.</li> </ul>

## Neighbors

Cisco Discovery Protocol (CDP) and Link Layer Discovery Protocol (LLDP) are neighbor discovery protocols. To enable, disable, and configure CDP and LLDP, use the command-line interface (CLI).

You can use the protocols together or separately:

- CDP is enabled by default.
- LLDP is disabled by default.

In Device Manager, you can view the neighbor information from each device to determine complete network topology. To view this information in Device Manager, the following is required:

- The neighboring device must support CDP or LLDP.
- CDP or LLDP must be enabled on a device to make the device discoverable.
- CDP or LLDP must be enabled on the switch.

When applied to a port, the following Smartport roles disable CDP:

- Automation Device
- Multiple Automation Device

From the Monitor menu, choose Neighbors. To display the neighbor information, click the CDP or LLDP tab.

The screenshot shows the 'Neighbors' tab in Device Manager. It has a navigation bar with 'Status | Neighbors' and a back arrow. Below the navigation bar are two tabs: 'CDP' (selected) and 'LLDP'. A table displays the following neighbor information:

Neighbor Device	Port ID	Local Interface	Hold-Time	Capability	Platform
DevSwitch1	Gig1/5	Fas1/1	173	S I	1783-HMS4

**Table 131 - Neighbor Fields**

Field	Description
Neighbor Device	The name of the neighboring device.
Port ID	The port type and port number of the neighboring device.
Local Interface	The local interface through which the neighbor is connected.
Hold-Time	The remaining amount of time in seconds that the current device holds the CDP or LLDP advertisement from a transmitting device before discarding it.
Capability	The device type of the neighbor, indicated by the capability code discovered on the device. A device can have multiple capability codes. Valid values: <ul style="list-style-type: none"> <li>• R—Router</li> <li>• T—Transparent bridge</li> <li>• B—Source-routing bridge</li> <li>• S—Switch</li> <li>• H—Host</li> <li>• I—IGMP device</li> <li>• r—Repeater</li> </ul>
Platform	(CDP only). The catalog number of the device.

## Cable Diagnostics

The Cable Diagnostics feature lets you run a test on each switch port to determine the integrity of the cable that is connected to the RJ45 (copper) ports. The test determines the distance to the break from the switch for each cable with a plus or minus error value individually listed. This feature is not available for fiber ports.

### Diagnose Cables via Device Manager

Use the Diagnostics page to run the Broken Wire Detection test, which uses Time Domain Reflectometry (TDR) detection to identify, diagnose, and resolve cable problems. TDR detection is supported on copper Ethernet 10/100 and 10/100/1000 ports. TDR is not supported on SFP module ports.

The link test can interrupt traffic between the port and the connected device. Only run the test on a port that has a suspected problem. Before running the link test, use the Front Panel view, the Port Status, and the Port Statistics pages to gather information about a potential problem.

---

**IMPORTANT** To run a valid test on gigabit ports, you must first configure the gigabit port as an RJ45 media type as described in [Configure Port Settings on page 51](#).

---

From the Monitor menu, choose Diagnostics.

To run a test, select a port and then click Start.

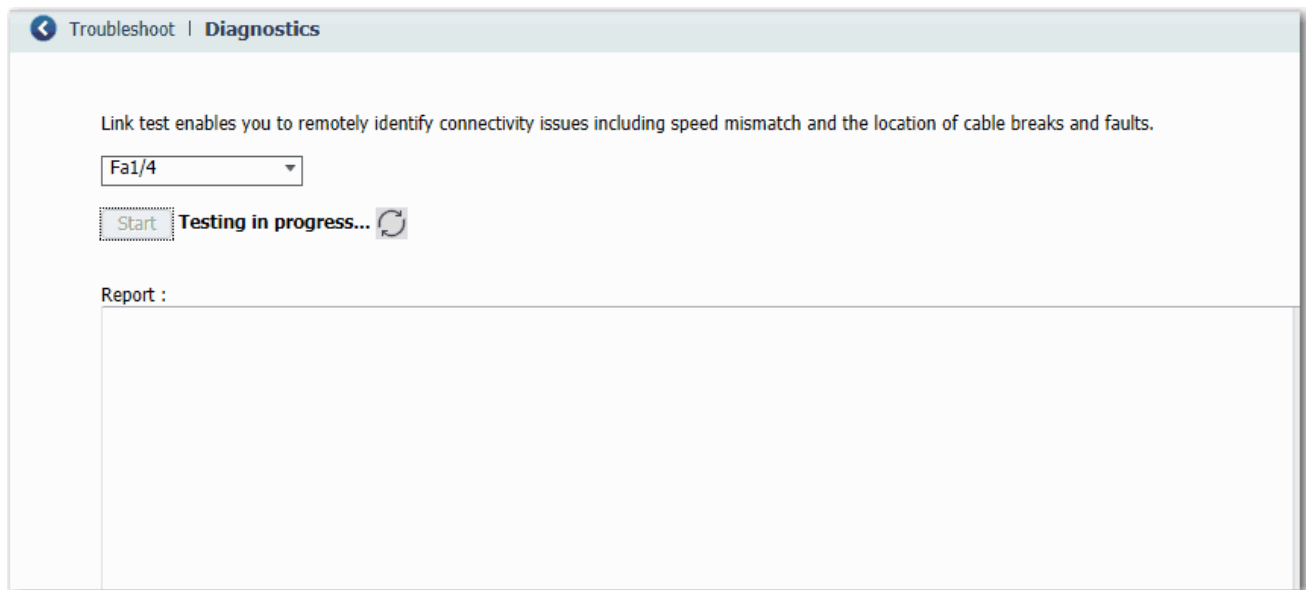

## Diagnose Cables via the Logix Designer Application

In the navigation pane, click Port Status, and then click the button in the Cable Diagnostics column for the corresponding port.

Port	Port Alarm Status	Link Status	Port Fault Status	Threshold Exceeded			Bandwidth Utilization Percent	Port Diagnostics	Cable Diagnostics
				Unicast	Multicast	Broadcast			
Gi1/1	No alarms	Active	No Fault	No	No	No	0	...	...
Gi1/2	No alarms	Inactive	No Fault	No	No	No	0	...	...
Fa1/1	No alarms	Inactive	No Fault	No	No	No	0	...	...
Fa1/2	Link fault alarm	Inactive	No Fault	No	No	No	0	...	...
Fa1/3	Link fault alarm	Inactive	No Fault	No	No	No	0	...	...
Fa1/4	Link fault alarm	Inactive	No Fault	No	No	No	0	...	...
Fa1/5	Link fault alarm	Inactive	No Fault	No	No	No	0	...	...
Fa1/6	Link fault alarm	Inactive	No Fault	No	No	No	0	...	...
Fa1/7	Link fault alarm	Inactive	No Fault	No	No	No	0	...	...
Fa1/8	Link fault alarm	Inactive	No Fault	No	No	No	0	...	...

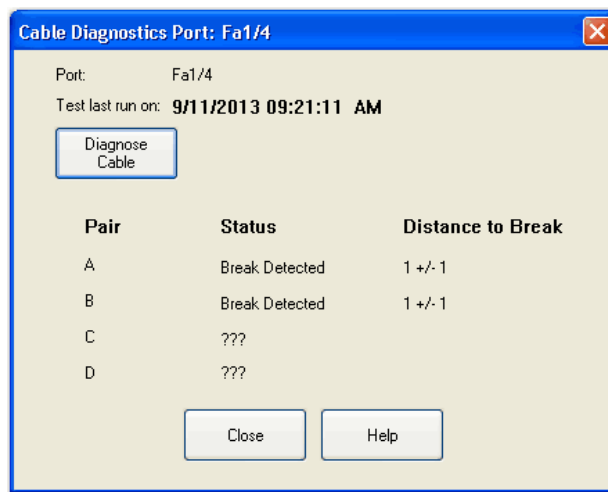

Table 132 - Cable Diagnostics Fields

Field	Description
Port	The port that is selected for configuration. The port number includes the port type (Fa for Fast Ethernet and Gi for Gigabit Ethernet), and the specific port number. <b>EXAMPLE:</b> Gi1/1 is Gigabit Ethernet port 1.
Test last run on	The time the test was last executed. The date time format is mm/dd/yy hh:mm:ss tt. If the test has never been run, the time and all distance and status information is blank.
Pair	Each pair of cables in the network individually listed. If pair does not exist or test has never beeto indicate run, this field is blank.
Status	Specifies the link state the last time the test was executed. If pair does not exist or test has never run, status is blank. For distance, if the pair is Normal status, 'No Break Detected' is shown. No distance is displayed.
Distance to Break	The distance to the break from the switch for each estimated pair with a plus or minus error value individually listed. A value is displayed only when the status of an existing pair is not Normal. This field is blank if the test was never run before. If a pair does not exist, '???' appears.
Diagnose Cable	Click to run the Diagnose Cable test. A connection interruption warning appears: <ul style="list-style-type: none"> <li>• If you are sure that you want to continue with the test, click Yes. Be prepared to enter a valid password to run the test.</li> <li>• If you do not want to run the test, click No or close the page.</li> </ul> <b>IMPORTANT:</b> To run a valid test on gigabit ports, you must first configure the gigabit port as an RJ45 media type in Device Manager as described in <a href="#">Configure Port Settings on page 51</a> . <b>IMPORTANT:</b> This test can interrupt connections to the module and to any other modules connected through this module. Also, the connection between workstation and controller can be interrupted. You must have the correct privilege to run this test.



---

## Troubleshoot the Switch

<b>Topic</b>	<b>Page</b>
Troubleshoot the Installation	338
Verify Boot Fast	341
Troubleshoot IP Addresses	341
Troubleshoot Device Manager	341
Troubleshoot Switch Performance	342
Restart or Reset the Switch	343
Troubleshoot a Firmware Update	344
Collect System and Configuration Information for Technical Support	345

This chapter helps you resolve issues that are related to Stratix® switches and perform common functions, such as reset the switch.

For more troubleshooting, see the following:

- [STP Status on page 329](#)
- [Neighbors on page 334](#)
- [System Log Messages on page 309](#)

See also Troubleshoot EtherNet/IP Networks, publication [ENET-AT003](#).

## Troubleshoot the Installation

The status indicators on the front panel provide troubleshooting information about the switch. They show power-on self-test (POST) failures, port connectivity problems, and overall switch performance. You can also get statistics from the browser interface, the command-line interface (CLI), or a Simple Network Management Protocol (SNMP) workstation.

### Switch POST Results

As power is applied to the switch, it begins the POST, a series of tests that runs automatically to help ensure that the switch functions properly. It can take several minutes for the switch to complete POST.

POST starts with status indicator tests that cycle once through the EIP Mod, EIP Net, Setup, Pwr A, and Pwr B status indicators. While POST proceeds, the EIP Mod status indicator blinks green, and all other status indicators remain off.

If POST completes successfully, the Setup status indicator changes to solid green, and the other status indicators display their normal operating status. If the switch fails POST, the Setup status indicator turns red.



**ATTENTION:** POST failures are fatal to the switch. Contact your Rockwell Automation technical support representative if your switch does not pass POST.

---

### POST Results with a Terminal

If you have a terminal that is connected to the console port, you can also view POST status and test results on the terminal. If the terminal displays unclear characters, try resetting the terminal-emulation software to 9600 bits per second.

## Bad or Damaged Cable

Always make sure that the cable does not have marginal damage or failure. Even if a cable can connect at the physical layer, subtle damage to the wiring or connectors can corrupt packets.

This situation is likely when the port has many packet errors or the port constantly loses and regains the link. To troubleshoot, try the following:

- Swap the copper or fiber-optic cable with a known, undamaged cable.
- Look for broken, bent, or missing pins on cable connectors.
- Rule out any bad patch panel connections or media convertors between the source and destination.

If possible, bypass the patch panel, or eliminate faulty media convertors (fiber-optic-to-copper).

- Try the cable in another port or interface to determine if the problem follows the cable.

## Ethernet and Fiber Cables

Make sure that you have the correct cable type for the connection:

- Use Category 3 copper cable for 10-Mb/s UTP connections.
- You can use Category 5, 5e, or 6 UTP or STP cable for 10/100-Mbps connections.
- For 1000 Mbps (1 gigabit per second) connections, use Category 5e or Category 6 UTP or STP cable.
- For fiber-optic connectors, verify that you have the correct cable for the distance and the port type.
- Make sure that the connected device ports both match and use the same type of encoding, optical frequency, and fiber type.

## Link Status

Verify that both sides have a network link. A broken wire or one shut down port can cause one side to show a link, but not the other side. A Link status indicator does not indicate that the cable is fully functional. The cable can encounter physical stress that causes it to function at a marginal level. If the Link status indicator for the port is not lit, do the following:

- Connect the cable from the switch to a known good device.
- Make sure that both ends of the cable are connected to the correct ports.
- Verify that both devices have power.
- Verify that you are using the correct cable type.
- Rule out loose connections. Sometimes a cable appears to be seated, but is not. Disconnect the cable, and then reconnect it.

## SFP Module Issues

Use only Rockwell Automation SFP modules on the switch. Each SFP module has an internal serial EEPROM that is encoded with security information. This encoding identifies and validates that the module meets the requirements for the switch.

Check these items:

- Verify that the SFP module is valid and functional. Exchange a suspect module with a known good module. Verify that the module is supported on this platform.
- Use the CLI `show interfaces` command or the CLI `show int status` command to verify the error-disabled or shutdown status of the port or module. Re-enable the port if needed.
- Make sure that all fiber connections are properly cleaned and securely connected.

## Port and Interface Settings

A cause of port connectivity failure can be a disabled port. Verify that the port or interface is not disabled or powered down for some reason. If a port or interface is manually shut down on one side of the link or the other side, the link does not come up until you re-enable the port. Use the CLI `show interfaces` privileged EXEC command to verify the port or interface error-disabled, disabled, or shutdown status on both sides of the connection. If needed, re-enable the port or the interface.

## Verify Boot Fast

Boot Fast failures are potentially fatal to the switch. Contact your Rockwell Automation representative if your switch does not successfully complete Boot Fast. You can disable Boot Fast and run a power-on self-test (POST) by using the CLI.

## Troubleshoot IP Addresses

The following table includes basic troubleshooting for issues that are related to the switch IP address.

Issue	Resolution
The switch does not receive an IP address from the DHCP server	If the switch does not receive an IP address from an upstream device operating as a DHCP server, make sure that the device is operating as a DHCP server. Repeat Express Setup.
The switch has the wrong IP address	If the switch is installed in your network but you cannot access the switch because it has the wrong IP address, assign a new switch IP address and update the switch IP address in Express Setup.

## Troubleshoot Device Manager

The following table includes basic troubleshooting for issues that are related to Device Manager.

Issue	Resolution
Device Manager does not appear	If you cannot display Device Manager from your computer, make sure that you entered the correct switch IP address in the browser. If you entered the correct switch IP address in the browser, make sure that the switch and your computer are in the same network or subnetwork: <ul style="list-style-type: none"> <li>– For example, if your switch IP address is 172.20.20.85 and your computer address is 172.20.20.84, both devices are in the same network.</li> <li>– For example, if your switch IP address is 172.20.20.85 and your computer IP address is 10.0.0.2, the devices are in different networks and cannot directly communicate without a router. You must either change the switch IP address or change the computer IP address.</li> </ul>
Device Manager does not operate properly	Open Device Manager in a new browser window by using a private browsing mode: <ul style="list-style-type: none"> <li>• In Internet Explorer, choose Safety &gt; InPrivate Browsing.</li> <li>• In Firefox, choose New Private Window.</li> </ul>

## Troubleshoot Switch Performance

The following table includes basic troubleshooting for issues that are related to switch performance.

Issue	Resolution
Speed, duplex, and autonegotiation	<p>Port statistics that show a large amount of alignment errors, frame check sequence (FCS), or late-collisions errors can indicate a speed or duplex mismatch.</p> <p>Common speed and duplex issues occur when duplex settings are mismatched between two switches, between a switch and a router, or between the switch and a computer. These issues can occur from manually setting the speed and duplex or from autonegotiation issues between the two devices. A mismatch occurs under these circumstances:</p> <ul style="list-style-type: none"> <li>• A manually set speed or duplex parameter differs from the manually set speed or duplex parameter on the connected port.</li> <li>• A port is set to autonegotiate, and the connected port is set to full-duplex with no autonegotiation.</li> </ul> <p>To maximize switch performance and be sure of a link, follow one of these guidelines when changing the settings for duplex and speed:</p> <ul style="list-style-type: none"> <li>• Let both ports autonegotiate both speed and duplex.</li> <li>• Manually set the same speed and duplex parameters for the ports on both ends of the connection to the same values.</li> <li>• If a remote device does not autonegotiate, configure the duplex settings on the two ports to the same values. The speed parameter can adjust itself even if the connected port does not autonegotiate.</li> </ul>
Autonegotiation and network interface cards (NICs)	<p>Issues sometimes occur between the switch and third-party network interface cards (NICs). By default, the switch ports and interfaces are set to autonegotiate. It is common for devices like laptops or other devices to be set to autonegotiate as well, yet sometimes autonegotiation issues occur.</p> <p>To troubleshoot autonegotiation issues, try manually setting both sides of the connection. If the issues persist, try upgrading the NIC driver to the latest firmware or software.</p>
Cable distance	<p>If the port statistics show excessive FCS, late-collision, or alignment errors, verify that the cable distance from the switch to the connected device meets the recommended guidelines.</p>

## Restart or Reset the Switch

If you cannot solve an issue by reconfiguring a feature, you can restart or reset the switch to solve the issue. If the issue exists after you reset the switch to its default settings, it is unlikely that the switch is causing the issue.



**ATTENTION:** Resetting the switch deletes all customized switch settings, including the IP address, and returns the switch to its factory default. The same software image is retained. To manage the switch or display Device Manager, you must reconfigure switch settings, as described in [Chapter 2](#), and use the new IP address.

**IMPORTANT** When you restart or reset the switch, connectivity of your devices to the network is interrupted.

Option	Method	Description
Restart	<ul style="list-style-type: none"> <li>Device Manager</li> <li>Logix Designer application</li> </ul>	This option restarts the switch without turning off power. The switch retains its saved configuration settings during the restart process. However, Device Manager is unavailable during the process. When the process completes, the switch displays Device Manager.
Reset the switch to factory defaults	<ul style="list-style-type: none"> <li>Device Manager</li> <li>Express Setup button</li> </ul>	This option resets the switch, deletes the current configuration settings, returns to the factory default settings, and then restarts the switch.

## Restart or Reset the Switch from Device Manager

From the Admin menu, choose Restart/Reset.

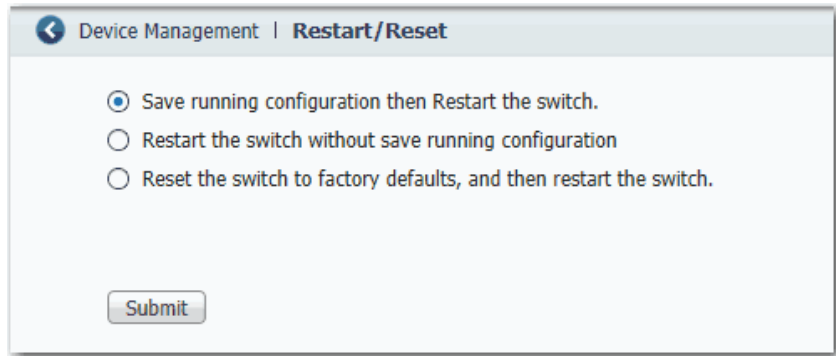

**Table 133 - Restart/Reset Fields**

Field	Description
Save running configuration and then restart the switch	Saves any changes in the running configuration before the switch restarts.
Restart the switch without saving running configuration	Restarts the switch with its previously saved configuration settings.
Reset the switch to factory defaults, and then restart the switch	Resets the device to the factory default settings, which deletes the current configuration settings, and then restarts the device. You lose connectivity with the device and must run Express Setup to reconfigure the device.

## Reset the Switch via the Express Setup Button

IOS Release	Switch	Reset Procedure
15.2(4)EA3 or later	All	Press and hold the Express Setup button until the Setup status indicator flashes alternating green and red during seconds 16...20, and then release. See also <a href="#">Run Multi-mode Express Setup in Long Press Mode on page 35</a> .
15.2(4)EA or earlier	Stratix 5400, 5410, 5700, or ArmorStratix™ 5700	Follow these steps. 1. Make sure that the switch is fully powered up. 2. Press and hold the Express Setup button for 10 seconds until the EIP Mod status indicator turns red, and then immediately release the Express Setup button. <b>IMPORTANT:</b> If you hold the Express Setup button too long (approximately 20 seconds), the EIP Net and EIP Mod status indicators turn red and the switch begins the power-on sequence. If this scenario occurs, power off and restart the switch to return to the factory default settings.
	Stratix 8000 or 8300	Follow these steps. 1. Remove power from the switch. 2. Reapply power to the switch. 3. While the switch is powering up, press and hold the Express Setup button. 4. When the EIP Mod, EIP Net and Setup status indicators turn red, release the Express Setup button.

## Restart the Switch from the Logix Designer Application

From Module Properties dialog box within the Studio 5000 Logix Designer® application, do the following.

1. In the navigation pane, click Module Info.
2. To restart the switch and maintain the current configurations, click Reset Module.  
A password prompt appears.
3. Enter your password and click Enter.

## Troubleshoot a Firmware Update

If you attempted to update the switch firmware but received a message that the update failed, make sure that you still have access to the switch. If you still have switch access, follow these steps.

1. Make sure that you downloaded the correct .tar file.
2. If you downloaded the correct .tar file, refresh the browser session for Device Manager to verify connectivity between the switch and your computer or network drive.
  - If you have connectivity to the switch and Device Manager, retry the update.
  - If you do not have connectivity to the switch and Device Manager, [Restart or Reset the Switch on page 343](#).



## Collect System and Configuration Information for Technical Support

The Device Manager online Help provides a link that you can use to collect system and configuration information about the switch. When you click the link, the switch runs the **show tech-support** command via the command-line interface (CLI). This command generates information about the switch that can be useful to Technical Support when you report a problem.

To collect system and configuration information for Technical Support, follow these steps.

1. Click the Help icon in the upper-right corner of the Device Manager window.



2. In the Contents pane, click Support, and then click Information commonly needed by field service.

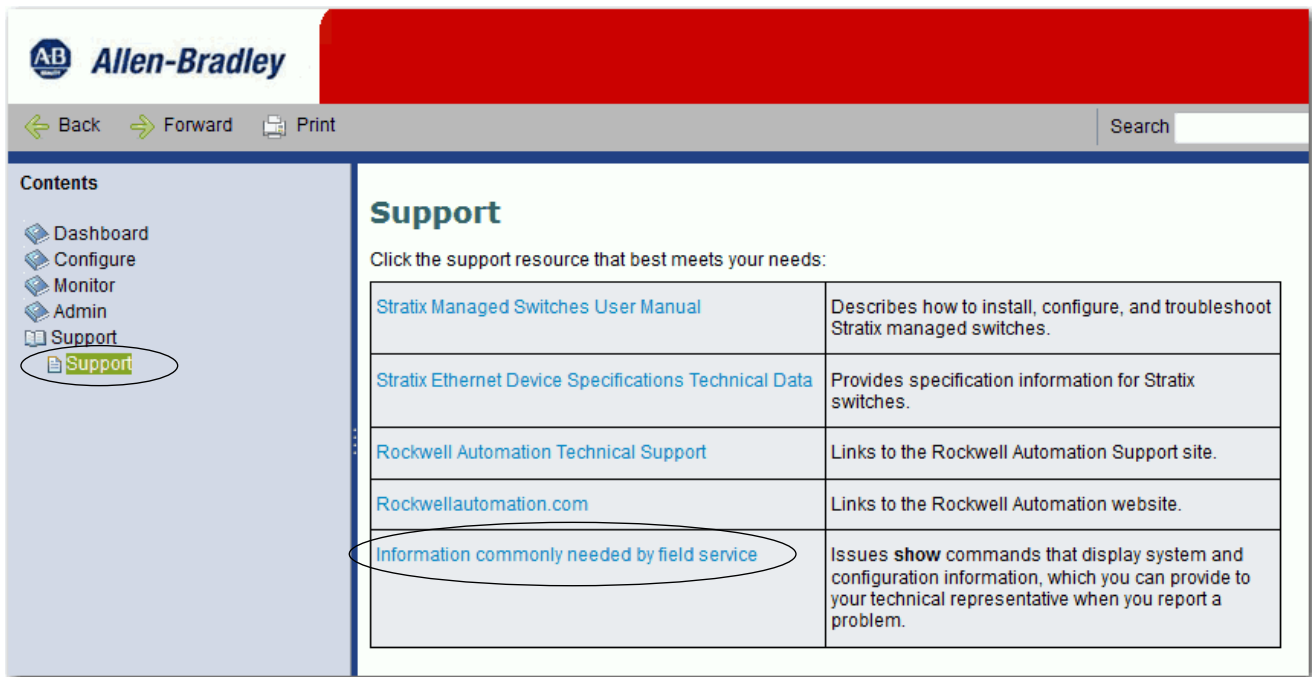

The switch runs the **show-tech support** command and displays system and configuration information in your browser window.

**Notes:**

---

## Data Types

<b>Topic</b>	<b>Page</b>
Stratix 5400 Data Types	348
Stratix 5410 Data Types	367
Stratix 5700 and ArmorStratix 5700 Data Types	372
Stratix 8000 and 8300 Data Types	399

In the Studio 5000 Logix Designer® application, predefined tags for Input and Output data types have a structure that corresponds to the switch selected when it was added to the I/O tree. Its members are named in accordance with the port names.

You can disable a switch port by setting the corresponding bit in the output tag. The output bits are applied every time that the switch receives the output data from the controller when the controller is in Run mode. When the controller is in Program mode, the output bits are not applied.

The port is enabled if the corresponding output bit is 0. If you enable or disable a port by using Device Manager or the CLI, the port setting can be overridden by the output bits the next time they are applied. The output bits always take precedence, regardless of whether Device Manager or the CLI is used to enable or disable the port.

## Stratix 5400 Data Types

The following tables list module-defined data types for Stratix® 5400 switches. The tables include information for input (I) and output (O).

### 8-port Switches

Catalog number 1783-HMS4C4CGN

**Table 134 - Input Data Types (8-port switches)**

<b>AB:STRATIX_5400_8PORT_MANAGED:I:0</b>			
<b>Member Name</b>	<b>Type</b>	<b>Default Display Style</b>	<b>Valid Values</b>
Fault	DINT	Binary	
AnyPortConnected	BOOL	Decimal	LinkStatus:0
PortGi1_1Connected	BOOL	Decimal	LinkStatus:1
PortGi1_2Connected	BOOL	Decimal	LinkStatus:2
PortGi1_3Connected	BOOL	Decimal	LinkStatus:3
PortGi1_4Connected	BOOL	Decimal	LinkStatus:4
PortFa1_5Connected	BOOL	Decimal	LinkStatus:5
PortFa1_6Connected	BOOL	Decimal	LinkStatus:6
PortFa1_7Connected	BOOL	Decimal	LinkStatus:7
PortFa1_8Connected	BOOL	Decimal	LinkStatus:8
AnyPortUnauthorizedDevice	BOOL	Decimal	UnauthorizedDevice:0
PortGi1_1UnauthorizedDevice	BOOL	Decimal	UnauthorizedDevice:1
PortGi1_2UnauthorizedDevice	BOOL	Decimal	UnauthorizedDevice:2
PortGi1_3UnauthorizedDevice	BOOL	Decimal	UnauthorizedDevice:3
PortGi1_4UnauthorizedDevice	BOOL	Decimal	UnauthorizedDevice:4
PortFa1_5UnauthorizedDevice	BOOL	Decimal	UnauthorizedDevice:5
PortFa1_6UnauthorizedDevice	BOOL	Decimal	UnauthorizedDevice:6
PortFa1_7UnauthorizedDevice	BOOL	Decimal	UnauthorizedDevice:7
PortFa1_8UnauthorizedDevice	BOOL	Decimal	UnauthorizedDevice:8
AnyPortThreshold	BOOL	Decimal	ThresholdExceeded:0
PortGi1_1Threshold	BOOL	Decimal	ThresholdExceeded:1
PortGi1_2Threshold	BOOL	Decimal	ThresholdExceeded:2
PortGi1_3Threshold	BOOL	Decimal	ThresholdExceeded:3
PortGi1_4Threshold	BOOL	Decimal	ThresholdExceeded:4
PortFa1_5Threshold	BOOL	Decimal	ThresholdExceeded:5
PortFa1_6Threshold	BOOL	Decimal	ThresholdExceeded:6
PortFa1_7Threshold	BOOL	Decimal	ThresholdExceeded:7
PortFa1_8Threshold	BOOL	Decimal	ThresholdExceeded:8
AllPortsUtilization	SINT	Decimal	
PortGi1_1Utilization	SINT	Decimal	
PortGi1_2Utilization	SINT	Decimal	

**Table 134 - Input Data Types (8-port switches) (Continued)**

<b>AB:STRATIX_5400_8PORT_MANAGED:I:0</b>			
<b>Member Name</b>	<b>Type</b>	<b>Default Display Style</b>	<b>Valid Values</b>
PortGi1_3Utilization	SINT	Decimal	
PortGi1_4Utilization	SINT	Decimal	
PortFa1_5Utilization	SINT	Decimal	
PortFa1_6Utilization	SINT	Decimal	
PortFa1_7Utilization	SINT	Decimal	
PortFa1_8Utilization	SINT	Decimal	
MajorAlarmRelay	BOOL	Decimal	AlarmRelay:0
MinorAlarmRelay	BOOL	Decimal	AlarmRelay:1
MulticastGroupActive	DINT	Binary	

**Table 135 - Output Data Types (8-port switches)**

<b>AB:STRATIX_5400_8PORT_MANAGED:O:0</b>			
<b>Member Name</b>	<b>Type</b>	<b>Default Display Style</b>	<b>Valid Values</b>
AllPortsDisabled	BOOL	Decimal	DisablePort:0
PortGi1_1Disable	BOOL	Decimal	DisablePort:1
PortGi1_2Disable	BOOL	Decimal	DisablePort:2
PortGi1_3Disable	BOOL	Decimal	DisablePort:3
PortGi1_4Disable	BOOL	Decimal	DisablePort:4
PortFa1_5Disable	BOOL	Decimal	DisablePort:5
PortFa1_6Disable	BOOL	Decimal	DisablePort:6
PortFa1_7Disable	BOOL	Decimal	DisablePort:7
PortFa1_8Disable	BOOL	Decimal	DisablePort:8

## 12-port Switches

Catalog numbers 1783-HMS8T4CGN,1783-HMS8S4CGN,  
1783-HMS4T4E4CGN

**Table 136 - Input Data Types (12-port switches)**

AB:STRATIX_5400_12PORT_MANAGED:I:0			
Member Name	Type	Default Display Style	Valid Values
Fault	DINT	Binary	
AnyPortConnected	BOOL	Decimal	LinkStatus:0
PortGi1_1Connected	BOOL	Decimal	LinkStatus:1
PortGi1_2Connected	BOOL	Decimal	LinkStatus:2
PortGi1_3Connected	BOOL	Decimal	LinkStatus:3
PortGi1_4Connected	BOOL	Decimal	LinkStatus:4
PortFa1_5Connected	BOOL	Decimal	LinkStatus:5
PortFa1_6Connected	BOOL	Decimal	LinkStatus:6
PortFa1_7Connected	BOOL	Decimal	LinkStatus:7
PortFa1_8Connected	BOOL	Decimal	LinkStatus:8
PortFa1_9Connected	BOOL	Decimal	LinkStatus:9
PortFa1_10Connected	BOOL	Decimal	LinkStatus:10
PortFa1_11Connected	BOOL	Decimal	LinkStatus:11
PortFa1_12Connected	BOOL	Decimal	LinkStatus:12
AnyPortUnauthorizedDevice	BOOL	Decimal	UnauthorizedDevice:0
PortGi1_1UnauthorizedDevice	BOOL	Decimal	UnauthorizedDevice:1
PortGi1_2UnauthorizedDevice	BOOL	Decimal	UnauthorizedDevice:2
PortGi1_3UnauthorizedDevice	BOOL	Decimal	UnauthorizedDevice:3
PortGi1_4UnauthorizedDevice	BOOL	Decimal	UnauthorizedDevice:4
PortFa1_5UnauthorizedDevice	BOOL	Decimal	UnauthorizedDevice:5
PortFa1_6UnauthorizedDevice	BOOL	Decimal	UnauthorizedDevice:6
PortFa1_7UnauthorizedDevice	BOOL	Decimal	UnauthorizedDevice:7
PortFa1_8UnauthorizedDevice	BOOL	Decimal	UnauthorizedDevice:8
PortFa1_9UnauthorizedDevice	BOOL	Decimal	UnauthorizedDevice:9
PortFa1_10UnauthorizedDevice	BOOL	Decimal	UnauthorizedDevice:10
PortFa1_11UnauthorizedDevice	BOOL	Decimal	UnauthorizedDevice:11
PortFa1_12UnauthorizedDevice	BOOL	Decimal	UnauthorizedDevice:12
AnyPortThreshold	BOOL	Decimal	ThresholdExceeded:0
PortGi1_1Threshold	BOOL	Decimal	ThresholdExceeded:1
PortGi1_2Threshold	BOOL	Decimal	ThresholdExceeded:2
PortGi1_3Threshold	BOOL	Decimal	ThresholdExceeded:3
PortGi1_4Threshold	BOOL	Decimal	ThresholdExceeded:4
PortFa1_5Threshold	BOOL	Decimal	ThresholdExceeded:5
PortFa1_6Threshold	BOOL	Decimal	ThresholdExceeded:6

**Table 136 - Input Data Types (12-port switches) (Continued)**

<b>AB:STRATIX_5400_12PORT_MANAGED:I:0</b>			
<b>Member Name</b>	<b>Type</b>	<b>Default Display Style</b>	<b>Valid Values</b>
PortFa1_7Threshold	BOOL	Decimal	ThresholdExceeded:7
PortFa1_8Threshold	BOOL	Decimal	ThresholdExceeded:8
PortFa1_9Threshold	BOOL	Decimal	ThresholdExceeded:9
PortFa1_10Threshold	BOOL	Decimal	ThresholdExceeded:10
PortFa1_11Threshold	BOOL	Decimal	ThresholdExceeded:11
PortFa1_12Threshold	BOOL	Decimal	ThresholdExceeded:12
AllPortsUtilization	SINT	Decimal	
PortGi1_1Utilization	SINT	Decimal	
PortGi1_2Utilization	SINT	Decimal	
PortGi1_3Utilization	SINT	Decimal	
PortGi1_4Utilization	SINT	Decimal	
PortFa1_5Utilization	SINT	Decimal	
PortFa1_6Utilization	SINT	Decimal	
PortFa1_7Utilization	SINT	Decimal	
PortFa1_8Utilization	SINT	Decimal	
PortFa1_9Utilization	SINT	Decimal	
PortFa1_10Utilization	SINT	Decimal	
PortFa1_11Utilization	SINT	Decimal	
PortFa1_12Utilization	SINT	Decimal	
MajorAlarmRelay	BOOL	Decimal	AlarmRelay:0
MinorAlarmRelay	BOOL	Decimal	AlarmRelay:1
MulticastGroupActive	DINT	Binary	

**Table 137 - Output Data Type (12-port switches)**

<b>AB:STRATIX_5400_12PORT_MANAGED:O:0</b>			
<b>Member Name</b>	<b>Type</b>	<b>Default Display Style</b>	<b>Valid Values</b>
AllPortsDisabled	BOOL	Decimal	DisablePort:0
PortGi1_1Disable	BOOL	Decimal	DisablePort:1
PortGi1_2Disable	BOOL	Decimal	DisablePort:2
PortGi1_3Disable	BOOL	Decimal	DisablePort:3
PortGi1_4Disable	BOOL	Decimal	DisablePort:4
PortFa1_5Disable	BOOL	Decimal	DisablePort:5
PortFa1_6Disable	BOOL	Decimal	DisablePort:6
PortFa1_7Disable	BOOL	Decimal	DisablePort:7
PortFa1_8Disable	BOOL	Decimal	DisablePort:8
PortFa1_9Disable	BOOL	Decimal	DisablePort:9

**Table 137 - Output Data Type (12-port switches) (Continued)**

AB:STRATIX_5400_12PORT_MANAGED:0:0			
Member Name	Type	Default Display Style	Valid Values
PortFa1_10Disable	BOOL	Decimal	DisablePort:10
PortFa1_11Disable	BOOL	Decimal	DisablePort:11
PortFa1_12Disable	BOOL	Decimal	DisablePort:12

## 12-port Gigabit Switches

Catalog numbers 1783-HMS8TG4CGN, 1783-HMS8SG4CGN, 1783-HMS4EG8CGN, 1783-HMS8TG4CGR, 1783-HMS8SG4CGR, 1783-HMS4EG8CGR

**Table 138 - Input Data Types (12-port Gb switches)**

AB:STRATIX_5400_12PORT_GB_MANAGED:i:0			
Member Name	Type	Default Display Style	Valid Values
Fault	DINT	Binary	
AnyPortConnected	BOOL	Decimal	LinkStatus:0
PortGi1_1Connected	BOOL	Decimal	LinkStatus:1
PortGi1_2Connected	BOOL	Decimal	LinkStatus:2
PortGi1_3Connected	BOOL	Decimal	LinkStatus:3
PortGi1_4Connected	BOOL	Decimal	LinkStatus:4
PortGi1_5Connected	BOOL	Decimal	LinkStatus:5
PortGi1_6Connected	BOOL	Decimal	LinkStatus:6
PortGi1_7Connected	BOOL	Decimal	LinkStatus:7
PortGi1_8Connected	BOOL	Decimal	LinkStatus:8
PortGi1_9Connected	BOOL	Decimal	LinkStatus:9
PortGi1_10Connected	BOOL	Decimal	LinkStatus:10
PortGi1_11Connected	BOOL	Decimal	LinkStatus:11
PortGi1_12Connected	BOOL	Decimal	LinkStatus:12
AnyPortUnauthorizedDevice	BOOL	Decimal	UnauthorizedDevice:0
PortGi1_1UnauthorizedDevice	BOOL	Decimal	UnauthorizedDevice:1
PortGi1_2UnauthorizedDevice	BOOL	Decimal	UnauthorizedDevice:2
PortGi1_3UnauthorizedDevice	BOOL	Decimal	UnauthorizedDevice:3
PortGi1_4UnauthorizedDevice	BOOL	Decimal	UnauthorizedDevice:4
PortGi1_5UnauthorizedDevice	BOOL	Decimal	UnauthorizedDevice:5
PortGi1_6UnauthorizedDevice	BOOL	Decimal	UnauthorizedDevice:6
PortGi1_7UnauthorizedDevice	BOOL	Decimal	UnauthorizedDevice:7
PortGi1_8UnauthorizedDevice	BOOL	Decimal	UnauthorizedDevice:8
PortGi1_9UnauthorizedDevice	BOOL	Decimal	UnauthorizedDevice:9
PortGi1_10UnauthorizedDevice	BOOL	Decimal	UnauthorizedDevice:10



**Table 138 - Input Data Types (12-port Gb switches) (Continued)**

<b>AB:STRATIX_5400_12PORT_GB_MANAGED:I:0</b>			
<b>Member Name</b>	<b>Type</b>	<b>Default Display Style</b>	<b>Valid Values</b>
PortGi1_11UnauthorizedDevice	BOOL	Decimal	UnauthorizedDevice:11
PortGi1_12UnauthorizedDevice	BOOL	Decimal	UnauthorizedDevice:12
AnyPortThreshold	BOOL	Decimal	ThresholdExceeded:0
PortGi1_1Threshold	BOOL	Decimal	ThresholdExceeded:1
PortGi1_2Threshold	BOOL	Decimal	ThresholdExceeded:2
PortGi1_3Threshold	BOOL	Decimal	ThresholdExceeded:3
PortGi1_4Threshold	BOOL	Decimal	ThresholdExceeded:4
PortGi1_5Threshold	BOOL	Decimal	ThresholdExceeded:5
PortGi1_6Threshold	BOOL	Decimal	ThresholdExceeded:6
PortGi1_7Threshold	BOOL	Decimal	ThresholdExceeded:7
PortGi1_8Threshold	BOOL	Decimal	ThresholdExceeded:8
PortGi1_9Threshold	BOOL	Decimal	ThresholdExceeded:9
PortGi1_10Threshold	BOOL	Decimal	ThresholdExceeded:10
PortGi1_11Threshold	BOOL	Decimal	ThresholdExceeded:11
PortGi1_12Threshold	BOOL	Decimal	ThresholdExceeded:12
AllPortsUtilization	SINT	Decimal	
PortGi1_1Utilization	SINT	Decimal	
PortGi1_2Utilization	SINT	Decimal	
PortGi1_3Utilization	SINT	Decimal	
PortGi1_4Utilization	SINT	Decimal	
PortGi1_5Utilization	SINT	Decimal	
PortGi1_6Utilization	SINT	Decimal	
PortGi1_7Utilization	SINT	Decimal	
PortGi1_8Utilization	SINT	Decimal	
PortGi1_9Utilization	SINT	Decimal	
PortGi1_10Utilization	SINT	Decimal	
PortGi1_11Utilization	SINT	Decimal	
PortGi1_12Utilization	SINT	Decimal	
MajorAlarmRelay	BOOL	Decimal	AlarmRelay:0
MinorAlarmRelay	BOOL	Decimal	AlarmRelay:1
MulticastGroupActive	DINT	Binary	

**Table 139 - Output Data Type (12-port Gb switches)**

<b>AB:STRATIX_5400_12PORT_GB_MANAGED:0:0</b>			
<b>Member Name</b>	<b>Type</b>	<b>Default Display Style</b>	<b>Valid Values</b>
AllPortsDisabled	BOOL	Decimal	DisablePort:0
PortGi1_1Disable	BOOL	Decimal	DisablePort:1
PortGi1_2Disable	BOOL	Decimal	DisablePort:2
PortGi1_3Disable	BOOL	Decimal	DisablePort:3
PortGi1_4Disable	BOOL	Decimal	DisablePort:4
PortGi1_5Disable	BOOL	Decimal	DisablePort:5
PortGi1_6Disable	BOOL	Decimal	DisablePort:6
PortGi1_7Disable	BOOL	Decimal	DisablePort:7
PortGi1_8Disable	BOOL	Decimal	DisablePort:8
PortGi1_9Disable	BOOL	Decimal	DisablePort:9
PortGi1_10Disable	BOOL	Decimal	DisablePort:10
PortGi1_11Disable	BOOL	Decimal	DisablePort:11
PortGi1_12Disable	BOOL	Decimal	DisablePort:12

## 16-port Switches

Catalog number 1783-HMS4S8E4CGN

**Table 140 - Input Data Type (16-port switches)**

<b>AB:STRATIX_5400_16PORT_MANAGED:I:0</b>			
<b>Member Name</b>	<b>Type</b>	<b>Default Display Style</b>	<b>Valid Values</b>
Fault	DINT	Binary	
AnyPortConnected	BOOL	Decimal	LinkStatus:0
PortGi1_1Connected	BOOL	Decimal	LinkStatus:1
PortGi1_2Connected	BOOL	Decimal	LinkStatus:2
PortGi1_3Connected	BOOL	Decimal	LinkStatus:3
PortGi1_4Connected	BOOL	Decimal	LinkStatus:4
PortFa1_5Connected	BOOL	Decimal	LinkStatus:5
PortFa1_6Connected	BOOL	Decimal	LinkStatus:6
PortFa1_7Connected	BOOL	Decimal	LinkStatus:7
PortFa1_8Connected	BOOL	Decimal	LinkStatus:8
PortFa1_9Connected	BOOL	Decimal	LinkStatus:9
PortFa1_10Connected	BOOL	Decimal	LinkStatus:10
PortFa1_11Connected	BOOL	Decimal	LinkStatus:11
PortFa1_12Connected	BOOL	Decimal	LinkStatus:12
PortFa1_13Connected	BOOL	Decimal	LinkStatus:13
PortFa1_14Connected	BOOL	Decimal	LinkStatus:14

**Table 140 - Input Data Type (16-port switches) (Continued)**

<b>AB:STRATIX_5400_16PORT_MANAGED:I:0</b>			
<b>Member Name</b>	<b>Type</b>	<b>Default Display Style</b>	<b>Valid Values</b>
PortFa1_15Connected	BOOL	Decimal	LinkStatus:15
PortFa1_16Connected	BOOL	Decimal	LinkStatus:16
AnyPortUnauthorizedDevice	BOOL	Decimal	UnauthorizedDevice:0
PortGi1_1UnauthorizedDevice	BOOL	Decimal	UnauthorizedDevice:1
PortGi1_2UnauthorizedDevice	BOOL	Decimal	UnauthorizedDevice:2
PortGi1_3UnauthorizedDevice	BOOL	Decimal	UnauthorizedDevice:3
PortGi1_4UnauthorizedDevice	BOOL	Decimal	UnauthorizedDevice:4
PortFa1_5UnauthorizedDevice	BOOL	Decimal	UnauthorizedDevice:5
PortFa1_6UnauthorizedDevice	BOOL	Decimal	UnauthorizedDevice:6
PortFa1_7UnauthorizedDevice	BOOL	Decimal	UnauthorizedDevice:7
PortFa1_8UnauthorizedDevice	BOOL	Decimal	UnauthorizedDevice:8
PortFa1_9UnauthorizedDevice	BOOL	Decimal	UnauthorizedDevice:9
PortFa1_10UnauthorizedDevice	BOOL	Decimal	UnauthorizedDevice:10
PortFa1_11UnauthorizedDevice	BOOL	Decimal	UnauthorizedDevice:11
PortFa1_12UnauthorizedDevice	BOOL	Decimal	UnauthorizedDevice:12
PortFa1_13UnauthorizedDevice	BOOL	Decimal	UnauthorizedDevice:13
PortFa1_14UnauthorizedDevice	BOOL	Decimal	UnauthorizedDevice:14
PortFa1_15UnauthorizedDevice	BOOL	Decimal	UnauthorizedDevice:15
PortFa1_16UnauthorizedDevice	BOOL	Decimal	UnauthorizedDevice:16
AnyPortThreshold	BOOL	Decimal	ThresholdExceeded:0
PortGi1_1Threshold	BOOL	Decimal	ThresholdExceeded:1
PortGi1_2Threshold	BOOL	Decimal	ThresholdExceeded:2
PortGi1_3Threshold	BOOL	Decimal	ThresholdExceeded:3
PortGi1_4Threshold	BOOL	Decimal	ThresholdExceeded:4
PortFa1_5Threshold	BOOL	Decimal	ThresholdExceeded:5
PortFa1_6Threshold	BOOL	Decimal	ThresholdExceeded:6
PortFa1_7Threshold	BOOL	Decimal	ThresholdExceeded:7
PortFa1_8Threshold	BOOL	Decimal	ThresholdExceeded:8
PortFa1_9Threshold	BOOL	Decimal	ThresholdExceeded:9
PortFa1_10Threshold	BOOL	Decimal	ThresholdExceeded:10
PortFa1_11Threshold	BOOL	Decimal	ThresholdExceeded:11
PortFa1_12Threshold	BOOL	Decimal	ThresholdExceeded:12
PortFa1_13Threshold	BOOL	Decimal	ThresholdExceeded:13
PortFa1_14Threshold	BOOL	Decimal	ThresholdExceeded:14
PortFa1_15Threshold	BOOL	Decimal	ThresholdExceeded:15
PortFa1_16Threshold	BOOL	Decimal	ThresholdExceeded:16
AllPortsUtilization	SINT	Decimal	
PortGi1_1Utilization	SINT	Decimal	

**Table 140 - Input Data Type (16-port switches) (Continued)**

<b>AB:STRATIX_5400_16PORT_MANAGED:I:0</b>			
<b>Member Name</b>	<b>Type</b>	<b>Default Display Style</b>	<b>Valid Values</b>
PortGi1_2Utilization	SINT	Decimal	
PortGi1_3Utilization	SINT	Decimal	
PortGi1_4Utilization	SINT	Decimal	
PortFa1_5Utilization	SINT	Decimal	
PortFa1_6Utilization	SINT	Decimal	
PortFa1_7Utilization	SINT	Decimal	
PortFa1_8Utilization	SINT	Decimal	
PortFa1_9Utilization	SINT	Decimal	
PortFa1_10Utilization	SINT	Decimal	
PortFa1_11Utilization	SINT	Decimal	
PortFa1_12Utilization	SINT	Decimal	
PortFa1_13Utilization	SINT	Decimal	
PortFa1_14Utilization	SINT	Decimal	
PortFa1_15Utilization	SINT	Decimal	
PortFa1_16Utilization	SINT	Decimal	
MajorAlarmRelay	BOOL	Decimal	AlarmRelay:0
MinorAlarmRelay	BOOL	Decimal	AlarmRelay:1
MulticastGroupActive	DINT	Binary	

**Table 141 - Output Data Type (16-port switches)**

<b>AB:STRATIX_5400_16PORT_MANAGED:O:0</b>			
<b>Member Name</b>	<b>Type</b>	<b>Default Display Style</b>	<b>Valid Values</b>
AllPortsDisabled	BOOL	Decimal	DisablePort:0
PortGi1_1Disable	BOOL	Decimal	DisablePort:1
PortGi1_2Disable	BOOL	Decimal	DisablePort:2
PortGi1_3Disable	BOOL	Decimal	DisablePort:3
PortGi1_4Disable	BOOL	Decimal	DisablePort:4
PortFa1_5Disable	BOOL	Decimal	DisablePort:5
PortFa1_6Disable	BOOL	Decimal	DisablePort:6
PortFa1_7Disable	BOOL	Decimal	DisablePort:7
PortFa1_8Disable	BOOL	Decimal	DisablePort:8
PortFa1_9Disable	BOOL	Decimal	DisablePort:9
PortFa1_10Disable	BOOL	Decimal	DisablePort:10
PortFa1_11Disable	BOOL	Decimal	DisablePort:11
PortFa1_12Disable	BOOL	Decimal	DisablePort:12
PortFa1_13Disable	BOOL	Decimal	DisablePort:13

**Table 141 - Output Data Type (16-port switches) (Continued)**

<b>AB:STRATIX_5400_16PORT_MANAGED:0:0</b>			
<b>Member Name</b>	<b>Type</b>	<b>Default Display Style</b>	<b>Valid Values</b>
PortFa1_14Disable	BOOL	Decimal	DisablePort:14
PortFa1_15Disable	BOOL	Decimal	DisablePort:15
PortFa1_16Disable	BOOL	Decimal	DisablePort:16

## 16-port Gigabit Switches

Catalog number 1783-HMS4SG8EG4CGN, 1783-HMS4SG8EG4CGR

**Table 142 - Input Data Type (16-port Gb switches)**

<b>AB:STRATIX_5400_16PORT_GB_MANAGED:I:0</b>			
<b>Member Name</b>	<b>Type</b>	<b>Default Display Style</b>	<b>Valid Values</b>
Fault	DINT	Binary	
AnyPortConnected	BOOL	Decimal	LinkStatus:0
PortGi1_1Connected	BOOL	Decimal	LinkStatus:1
PortGi1_2Connected	BOOL	Decimal	LinkStatus:2
PortGi1_3Connected	BOOL	Decimal	LinkStatus:3
PortGi1_4Connected	BOOL	Decimal	LinkStatus:4
PortGi1_5Connected	BOOL	Decimal	LinkStatus:5
PortGi1_6Connected	BOOL	Decimal	LinkStatus:6
PortGi1_7Connected	BOOL	Decimal	LinkStatus:7
PortGi1_8Connected	BOOL	Decimal	LinkStatus:8
PortGi1_9Connected	BOOL	Decimal	LinkStatus:9
PortGi1_10Connected	BOOL	Decimal	LinkStatus:10
PortGi1_11Connected	BOOL	Decimal	LinkStatus:11
PortGi1_12Connected	BOOL	Decimal	LinkStatus:12
PortGi1_13Connected	BOOL	Decimal	LinkStatus:13
PortGi1_14Connected	BOOL	Decimal	LinkStatus:14
PortGi1_15Connected	BOOL	Decimal	LinkStatus:15
PortGi1_16Connected	BOOL	Decimal	LinkStatus:16
AnyPortUnauthorizedDevice	BOOL	Decimal	UnauthorizedDevice:0
PortGi1_1UnauthorizedDevice	BOOL	Decimal	UnauthorizedDevice:1
PortGi1_2UnauthorizedDevice	BOOL	Decimal	UnauthorizedDevice:2
PortGi1_3UnauthorizedDevice	BOOL	Decimal	UnauthorizedDevice:3
PortGi1_4UnauthorizedDevice	BOOL	Decimal	UnauthorizedDevice:4
PortGi1_5UnauthorizedDevice	BOOL	Decimal	UnauthorizedDevice:5
PortGi1_6UnauthorizedDevice	BOOL	Decimal	UnauthorizedDevice:6
PortGi1_7UnauthorizedDevice	BOOL	Decimal	UnauthorizedDevice:7

**Table 142 - Input Data Type (16-port Gb switches) (Continued)**

<b>AB:STRATIX_5400_16PORT_GB_MANAGED:I:0</b>			
<b>Member Name</b>	<b>Type</b>	<b>Default Display Style</b>	<b>Valid Values</b>
PortGi1_8UnauthorizedDevice	BOOL	Decimal	UnauthorizedDevice:8
PortGi1_9UnauthorizedDevice	BOOL	Decimal	UnauthorizedDevice:9
PortGi1_10UnauthorizedDevice	BOOL	Decimal	UnauthorizedDevice:10
PortGi1_11UnauthorizedDevice	BOOL	Decimal	UnauthorizedDevice:11
PortGi1_12UnauthorizedDevice	BOOL	Decimal	UnauthorizedDevice:12
PortGi1_13UnauthorizedDevice	BOOL	Decimal	UnauthorizedDevice:13
PortGi1_14UnauthorizedDevice	BOOL	Decimal	UnauthorizedDevice:14
PortGi1_15UnauthorizedDevice	BOOL	Decimal	UnauthorizedDevice:15
PortGi1_16UnauthorizedDevice	BOOL	Decimal	UnauthorizedDevice:16
AnyPortThreshold	BOOL	Decimal	ThresholdExceeded:0
PortGi1_1Threshold	BOOL	Decimal	ThresholdExceeded:1
PortGi1_2Threshold	BOOL	Decimal	ThresholdExceeded:2
PortGi1_3Threshold	BOOL	Decimal	ThresholdExceeded:3
PortGi1_4Threshold	BOOL	Decimal	ThresholdExceeded:4
PortGi1_5Threshold	BOOL	Decimal	ThresholdExceeded:5
PortGi1_6Threshold	BOOL	Decimal	ThresholdExceeded:6
PortGi1_7Threshold	BOOL	Decimal	ThresholdExceeded:7
PortGi1_8Threshold	BOOL	Decimal	ThresholdExceeded:8
PortGi1_9Threshold	BOOL	Decimal	ThresholdExceeded:9
PortGi1_10Threshold	BOOL	Decimal	ThresholdExceeded:10
PortGi1_11Threshold	BOOL	Decimal	ThresholdExceeded:11
PortGi1_12Threshold	BOOL	Decimal	ThresholdExceeded:12
PortGi1_13Threshold	BOOL	Decimal	ThresholdExceeded:13
PortGi1_14Threshold	BOOL	Decimal	ThresholdExceeded:14
PortGi1_15Threshold	BOOL	Decimal	ThresholdExceeded:15
PortGi1_16Threshold	BOOL	Decimal	ThresholdExceeded:16
AllPortsUtilization	SINT	Decimal	
PortGi1_1Utilization	SINT	Decimal	
PortGi1_2Utilization	SINT	Decimal	
PortGi1_3Utilization	SINT	Decimal	
PortGi1_4Utilization	SINT	Decimal	
PortGi1_5Utilization	SINT	Decimal	
PortGi1_6Utilization	SINT	Decimal	
PortGi1_7Utilization	SINT	Decimal	
PortGi1_8Utilization	SINT	Decimal	
PortGi1_9Utilization	SINT	Decimal	
PortGi1_10Utilization	SINT	Decimal	
PortGi1_11Utilization	SINT	Decimal	

**Table 142 - Input Data Type (16-port Gb switches) (Continued)**

<b>AB:STRATIX_5400_16PORT_GB_MANAGED:I:0</b>			
<b>Member Name</b>	<b>Type</b>	<b>Default Display Style</b>	<b>Valid Values</b>
PortGi1_12Utilization	SINT	Decimal	
PortGi1_13Utilization	SINT	Decimal	
PortGi1_14Utilization	SINT	Decimal	
PortGi1_15Utilization	SINT	Decimal	
PortGi1_16Utilization	SINT	Decimal	
MajorAlarmRelay	BOOL	Decimal	AlarmRelay:0
MinorAlarmRelay	BOOL	Decimal	AlarmRelay:1
MulticastGroupActive	DINT	Binary	

**Table 143 - Output Data Type (16-port Gb switches)**

<b>AB:STRATIX_5400_16PORT_GB_MANAGED:O:0</b>			
<b>Member Name</b>	<b>Type</b>	<b>Default Display Style</b>	<b>Valid Values</b>
AllPortsDisabled	BOOL	Decimal	DisablePort:0
PortGi1_1Disable	BOOL	Decimal	DisablePort:1
PortGi1_2Disable	BOOL	Decimal	DisablePort:2
PortGi1_3Disable	BOOL	Decimal	DisablePort:3
PortGi1_4Disable	BOOL	Decimal	DisablePort:4
PortGi1_5Disable	BOOL	Decimal	DisablePort:5
PortGi1_6Disable	BOOL	Decimal	DisablePort:6
PortGi1_7Disable	BOOL	Decimal	DisablePort:7
PortGi1_8Disable	BOOL	Decimal	DisablePort:8
PortGi1_9Disable	BOOL	Decimal	DisablePort:9
PortGi1_10Disable	BOOL	Decimal	DisablePort:10
PortGi1_11Disable	BOOL	Decimal	DisablePort:11
PortGi1_12Disable	BOOL	Decimal	DisablePort:12
PortGi1_13Disable	BOOL	Decimal	DisablePort:13
PortGi1_14Disable	BOOL	Decimal	DisablePort:14
PortGi1_15Disable	BOOL	Decimal	DisablePort:15
PortGi1_16Disable	BOOL	Decimal	DisablePort:16

## 20-port Switches

Catalog number 1783-HMS16T4CGN

**Table 144 - Input Data Type (20-port switches)**

<b>AB:STRATIX_5400_20PORT_MANAGED:I:0</b>			
<b>Member Name</b>	<b>Type</b>	<b>Default Display Style</b>	<b>Valid Values</b>
Fault	DINT	Binary	
AnyPortConnected	BOOL	Decimal	LinkStatus:0
PortGi1_1Connected	BOOL	Decimal	LinkStatus:1
PortGi1_2Connected	BOOL	Decimal	LinkStatus:2
PortGi1_3Connected	BOOL	Decimal	LinkStatus:3
PortGi1_4Connected	BOOL	Decimal	LinkStatus:4
PortFa1_5Connected	BOOL	Decimal	LinkStatus:5
PortFa1_6Connected	BOOL	Decimal	LinkStatus:6
PortFa1_7Connected	BOOL	Decimal	LinkStatus:7
PortFa1_8Connected	BOOL	Decimal	LinkStatus:8
PortFa1_9Connected	BOOL	Decimal	LinkStatus:9
PortFa1_10Connected	BOOL	Decimal	LinkStatus:10
PortFa1_11Connected	BOOL	Decimal	LinkStatus:11
PortFa1_12Connected	BOOL	Decimal	LinkStatus:12
PortFa1_13Connected	BOOL	Decimal	LinkStatus:13
PortFa1_14Connected	BOOL	Decimal	LinkStatus:14
PortFa1_15Connected	BOOL	Decimal	LinkStatus:15
PortFa1_16Connected	BOOL	Decimal	LinkStatus:16
PortFa1_17Connected	BOOL	Decimal	LinkStatus:17
PortFa1_18Connected	BOOL	Decimal	LinkStatus:18
PortFa1_19Connected	BOOL	Decimal	LinkStatus:19
PortFa1_20Connected	BOOL	Decimal	LinkStatus:20
AnyPortUnauthorizedDevice	BOOL	Decimal	UnauthorizedDevice:0
PortGi1_1UnauthorizedDevice	BOOL	Decimal	UnauthorizedDevice:1
PortGi1_2UnauthorizedDevice	BOOL	Decimal	UnauthorizedDevice:2
PortGi1_3UnauthorizedDevice	BOOL	Decimal	UnauthorizedDevice:3
PortGi1_4UnauthorizedDevice	BOOL	Decimal	UnauthorizedDevice:4
PortFa1_5UnauthorizedDevice	BOOL	Decimal	UnauthorizedDevice:5
PortFa1_6UnauthorizedDevice	BOOL	Decimal	UnauthorizedDevice:6
PortFa1_7UnauthorizedDevice	BOOL	Decimal	UnauthorizedDevice:7
PortFa1_8UnauthorizedDevice	BOOL	Decimal	UnauthorizedDevice:8
PortFa1_9UnauthorizedDevice	BOOL	Decimal	UnauthorizedDevice:9
PortFa1_10UnauthorizedDevice	BOOL	Decimal	UnauthorizedDevice:10
PortFa1_11UnauthorizedDevice	BOOL	Decimal	UnauthorizedDevice:11
PortFa1_12UnauthorizedDevice	BOOL	Decimal	UnauthorizedDevice:12



**Table 144 - Input Data Type (20-port switches) (Continued)**

<b>AB:STRATIX_5400_20PORT_MANAGED:I:0</b>			
<b>Member Name</b>	<b>Type</b>	<b>Default Display Style</b>	<b>Valid Values</b>
PortFa1_13UnauthorizedDevice	BOOL	Decimal	UnauthorizedDevice:13
PortFa1_14UnauthorizedDevice	BOOL	Decimal	UnauthorizedDevice:14
PortFa1_15UnauthorizedDevice	BOOL	Decimal	UnauthorizedDevice:15
PortFa1_16UnauthorizedDevice	BOOL	Decimal	UnauthorizedDevice:16
PortFa1_17UnauthorizedDevice	BOOL	Decimal	UnauthorizedDevice:17
PortFa1_18UnauthorizedDevice	BOOL	Decimal	UnauthorizedDevice:18
PortFa1_19UnauthorizedDevice	BOOL	Decimal	UnauthorizedDevice:19
PortFa1_20UnauthorizedDevice	BOOL	Decimal	UnauthorizedDevice:20
AnyPortThreshold	BOOL	Decimal	ThresholdExceeded:0
PortGi1_1Threshold	BOOL	Decimal	ThresholdExceeded:1
PortGi1_2Threshold	BOOL	Decimal	ThresholdExceeded:2
PortGi1_3Threshold	BOOL	Decimal	ThresholdExceeded:3
PortGi1_4Threshold	BOOL	Decimal	ThresholdExceeded:4
PortFa1_5Threshold	BOOL	Decimal	ThresholdExceeded:5
PortFa1_6Threshold	BOOL	Decimal	ThresholdExceeded:6
PortFa1_7Threshold	BOOL	Decimal	ThresholdExceeded:7
PortFa1_8Threshold	BOOL	Decimal	ThresholdExceeded:8
PortFa1_9Threshold	BOOL	Decimal	ThresholdExceeded:9
PortFa1_10Threshold	BOOL	Decimal	ThresholdExceeded:10
PortFa1_11Threshold	BOOL	Decimal	ThresholdExceeded:11
PortFa1_12Threshold	BOOL	Decimal	ThresholdExceeded:12
PortFa1_13Threshold	BOOL	Decimal	ThresholdExceeded:13
PortFa1_14Threshold	BOOL	Decimal	ThresholdExceeded:14
PortFa1_15Threshold	BOOL	Decimal	ThresholdExceeded:15
PortFa1_16Threshold	BOOL	Decimal	ThresholdExceeded:16
PortFa1_17Threshold	BOOL	Decimal	ThresholdExceeded:17
PortFa1_18Threshold	BOOL	Decimal	ThresholdExceeded:18
PortFa1_19Threshold	BOOL	Decimal	ThresholdExceeded:19
PortFa1_20Threshold	BOOL	Decimal	ThresholdExceeded:20
AllPortsUtilization	SINT	Decimal	
PortGi1_1Utilization	SINT	Decimal	
PortGi1_2Utilization	SINT	Decimal	
PortGi1_3Utilization	SINT	Decimal	
PortGi1_4Utilization	SINT	Decimal	
PortFa1_5Utilization	SINT	Decimal	
PortFa1_6Utilization	SINT	Decimal	
PortFa1_7Utilization	SINT	Decimal	
PortFa1_8Utilization	SINT	Decimal	

**Table 144 - Input Data Type (20-port switches) (Continued)**

<b>AB:STRATIX_5400_20PORT_MANAGED:I:0</b>			
<b>Member Name</b>	<b>Type</b>	<b>Default Display Style</b>	<b>Valid Values</b>
PortFa1_9Utilization	SINT	Decimal	
PortFa1_10Utilization	SINT	Decimal	
PortFa1_11Utilization	SINT	Decimal	
PortFa1_12Utilization	SINT	Decimal	
PortFa1_13Utilization	SINT	Decimal	
PortFa1_14Utilization	SINT	Decimal	
PortFa1_15Utilization	SINT	Decimal	
PortFa1_16Utilization	SINT	Decimal	
PortFa1_17Utilization	SINT	Decimal	
PortFa1_18Utilization	SINT	Decimal	
PortFa1_19Utilization	SINT	Decimal	
PortFa1_20Utilization	SINT	Decimal	
MajorAlarmRelay	BOOL	Decimal	AlarmRelay:0
MinorAlarmRelay	BOOL	Decimal	AlarmRelay:1
MulticastGroupActive	DINT	Binary	

**Table 145 - Output Data Type (20-port switches)**

<b>AB:STRATIX_5400_20PORT_MANAGED:O:0</b>			
<b>Member Name</b>	<b>Type</b>	<b>Default Display Style</b>	<b>Valid Values</b>
AllPortsDisabled	BOOL	Decimal	DisablePort:0
PortGi1_1Disable	BOOL	Decimal	DisablePort:1
PortGi1_2Disable	BOOL	Decimal	DisablePort:2
PortGi1_3Disable	BOOL	Decimal	DisablePort:3
PortGi1_4Disable	BOOL	Decimal	DisablePort:4
PortFa1_5Disable	BOOL	Decimal	DisablePort:5
PortFa1_6Disable	BOOL	Decimal	DisablePort:6
PortFa1_7Disable	BOOL	Decimal	DisablePort:7
PortFa1_8Disable	BOOL	Decimal	DisablePort:8
PortFa1_9Disable	BOOL	Decimal	DisablePort:9
PortFa1_10Disable	BOOL	Decimal	DisablePort:10
PortFa1_11Disable	BOOL	Decimal	DisablePort:11
PortFa1_12Disable	BOOL	Decimal	DisablePort:12
PortFa1_13Disable	BOOL	Decimal	DisablePort:13
PortFa1_14Disable	BOOL	Decimal	DisablePort:14
PortFa1_15Disable	BOOL	Decimal	DisablePort:15
PortFa1_16Disable	BOOL	Decimal	DisablePort:16
PortFa1_17Disable	BOOL	Decimal	DisablePort:17

**Table 145 - Output Data Type (20-port switches) (Continued)**

<b>AB:STRATIX_5400_20PORT_MANAGED:0:0</b>			
<b>Member Name</b>	<b>Type</b>	<b>Default Display Style</b>	<b>Valid Values</b>
PortFa1_18Disable	BOOL	Decimal	DisablePort:18
PortFa1_19Disable	BOOL	Decimal	DisablePort:19
PortFa1_20Disable	BOOL	Decimal	DisablePort:20

## 20-port Gigabit Switches

Catalog numbers 1783-HMS16TG4CGN, 1783-HMS8TG8EG4CGN, 1783-HMS16TG4CGR, 1783-HMS8TG8EG4CGR

**Table 146 - Input Data Type (20-port Gb switches)**

<b>AB:STRATIX_5400_20PORT_GB_MANAGED:1:0</b>			
<b>Member Name</b>	<b>Type</b>	<b>Default Display Style</b>	<b>Valid Values</b>
Fault	DINT	Binary	
AnyPortConnected	BOOL	Decimal	LinkStatus:0
PortGi1_1Connected	BOOL	Decimal	LinkStatus:1
PortGi1_2Connected	BOOL	Decimal	LinkStatus:2
PortGi1_3Connected	BOOL	Decimal	LinkStatus:3
PortGi1_4Connected	BOOL	Decimal	LinkStatus:4
PortGi1_5Connected	BOOL	Decimal	LinkStatus:5
PortGi1_6Connected	BOOL	Decimal	LinkStatus:6
PortGi1_7Connected	BOOL	Decimal	LinkStatus:7
PortGi1_8Connected	BOOL	Decimal	LinkStatus:8
PortGi1_9Connected	BOOL	Decimal	LinkStatus:9
PortGi1_10Connected	BOOL	Decimal	LinkStatus:10
PortGi1_11Connected	BOOL	Decimal	LinkStatus:11
PortGi1_12Connected	BOOL	Decimal	LinkStatus:12
PortGi1_13Connected	BOOL	Decimal	LinkStatus:13
PortGi1_14Connected	BOOL	Decimal	LinkStatus:14
PortGi1_15Connected	BOOL	Decimal	LinkStatus:15
PortGi1_16Connected	BOOL	Decimal	LinkStatus:16
PortGi1_17Connected	BOOL	Decimal	LinkStatus:17
PortGi1_18Connected	BOOL	Decimal	LinkStatus:18
PortGi1_19Connected	BOOL	Decimal	LinkStatus:19
PortGi1_20Connected	BOOL	Decimal	LinkStatus:20
AnyPortUnauthorizedDevice	BOOL	Decimal	UnauthorizedDevice:0
PortGi1_1UnauthorizedDevice	BOOL	Decimal	UnauthorizedDevice:1
PortGi1_2UnauthorizedDevice	BOOL	Decimal	UnauthorizedDevice:2
PortGi1_3UnauthorizedDevice	BOOL	Decimal	UnauthorizedDevice:3

**Table 146 - Input Data Type (20-port Gb switches) (Continued)**

<b>AB:STRATIX_5400_20PORT_GB_MANAGED:I:0</b>			
<b>Member Name</b>	<b>Type</b>	<b>Default Display Style</b>	<b>Valid Values</b>
PortGi1_4UnauthorizedDevice	BOOL	Decimal	UnauthorizedDevice:4
PortGi1_5UnauthorizedDevice	BOOL	Decimal	UnauthorizedDevice:5
PortGi1_6UnauthorizedDevice	BOOL	Decimal	UnauthorizedDevice:6
PortGi1_7UnauthorizedDevice	BOOL	Decimal	UnauthorizedDevice:7
PortGi1_8UnauthorizedDevice	BOOL	Decimal	UnauthorizedDevice:8
PortGi1_9UnauthorizedDevice	BOOL	Decimal	UnauthorizedDevice:9
PortGi1_10UnauthorizedDevice	BOOL	Decimal	UnauthorizedDevice:10
PortGi1_11UnauthorizedDevice	BOOL	Decimal	UnauthorizedDevice:11
PortGi1_12UnauthorizedDevice	BOOL	Decimal	UnauthorizedDevice:12
PortGi1_13UnauthorizedDevice	BOOL	Decimal	UnauthorizedDevice:13
PortGi1_14UnauthorizedDevice	BOOL	Decimal	UnauthorizedDevice:14
PortGi1_15UnauthorizedDevice	BOOL	Decimal	UnauthorizedDevice:15
PortGi1_16UnauthorizedDevice	BOOL	Decimal	UnauthorizedDevice:16
PortGi1_17UnauthorizedDevice	BOOL	Decimal	UnauthorizedDevice:17
PortGi1_18UnauthorizedDevice	BOOL	Decimal	UnauthorizedDevice:18
PortGi1_19UnauthorizedDevice	BOOL	Decimal	UnauthorizedDevice:19
PortGi1_20UnauthorizedDevice	BOOL	Decimal	UnauthorizedDevice:20
AnyPortThreshold	BOOL	Decimal	ThresholdExceeded:0
PortGi1_1Threshold	BOOL	Decimal	ThresholdExceeded:1
PortGi1_2Threshold	BOOL	Decimal	ThresholdExceeded:2
PortGi1_3Threshold	BOOL	Decimal	ThresholdExceeded:3
PortGi1_4Threshold	BOOL	Decimal	ThresholdExceeded:4
PortGi1_5Threshold	BOOL	Decimal	ThresholdExceeded:5
PortGi1_6Threshold	BOOL	Decimal	ThresholdExceeded:6
PortGi1_7Threshold	BOOL	Decimal	ThresholdExceeded:7
PortGi1_8Threshold	BOOL	Decimal	ThresholdExceeded:8
PortGi1_9Threshold	BOOL	Decimal	ThresholdExceeded:9
PortGi1_10Threshold	BOOL	Decimal	ThresholdExceeded:10
PortGi1_11Threshold	BOOL	Decimal	ThresholdExceeded:11
PortGi1_12Threshold	BOOL	Decimal	ThresholdExceeded:12
PortGi1_13Threshold	BOOL	Decimal	ThresholdExceeded:13
PortGi1_14Threshold	BOOL	Decimal	ThresholdExceeded:14
PortGi1_15Threshold	BOOL	Decimal	ThresholdExceeded:15
PortGi1_16Threshold	BOOL	Decimal	ThresholdExceeded:16
PortGi1_17Threshold	BOOL	Decimal	ThresholdExceeded:17
PortGi1_18Threshold	BOOL	Decimal	ThresholdExceeded:18
PortGi1_19Threshold	BOOL	Decimal	ThresholdExceeded:19
PortGi1_20Threshold	BOOL	Decimal	ThresholdExceeded:20

**Table 146 - Input Data Type (20-port Gb switches) (Continued)**

<b>AB:STRATIX_5400_20PORT_GB_MANAGED:I:0</b>			
<b>Member Name</b>	<b>Type</b>	<b>Default Display Style</b>	<b>Valid Values</b>
AllPortsUtilization	SINT	Decimal	
PortGi1_1Utilization	SINT	Decimal	
PortGi1_2Utilization	SINT	Decimal	
PortGi1_3Utilization	SINT	Decimal	
PortGi1_4Utilization	SINT	Decimal	
PortGi1_5Utilization	SINT	Decimal	
PortGi1_6Utilization	SINT	Decimal	
PortGi1_7Utilization	SINT	Decimal	
PortGi1_8Utilization	SINT	Decimal	
PortGi1_9Utilization	SINT	Decimal	
PortGi1_10Utilization	SINT	Decimal	
PortGi1_11Utilization	SINT	Decimal	
PortGi1_12Utilization	SINT	Decimal	
PortGi1_13Utilization	SINT	Decimal	
PortGi1_14Utilization	SINT	Decimal	
PortGi1_15Utilization	SINT	Decimal	
PortGi1_16Utilization	SINT	Decimal	
PortGi1_17Utilization	SINT	Decimal	
PortGi1_18Utilization	SINT	Decimal	
PortGi1_19Utilization	SINT	Decimal	
PortGi1_20Utilization	SINT	Decimal	
MajorAlarmRelay	BOOL	Decimal	AlarmRelay:0
MinorAlarmRelay	BOOL	Decimal	AlarmRelay:1
MulticastGroupActive	DINT	Binary	

**Table 147 - Output Data Type (20-Gb port switches)**

<b>AB:STRATIX_5400_20PORT_GB_MANAGED:O:0</b>			
<b>Member Name</b>	<b>Type</b>	<b>Default Display Style</b>	<b>Valid Values</b>
AllPortsDisabled	BOOL	Decimal	DisablePort:0
PortGi1_1Disable	BOOL	Decimal	DisablePort:1
PortGi1_2Disable	BOOL	Decimal	DisablePort:2
PortGi1_3Disable	BOOL	Decimal	DisablePort:3
PortGi1_4Disable	BOOL	Decimal	DisablePort:4
PortGi1_5Disable	BOOL	Decimal	DisablePort:5
PortGi1_6Disable	BOOL	Decimal	DisablePort:6
PortGi1_7Disable	BOOL	Decimal	DisablePort:7
PortGi1_8Disable	BOOL	Decimal	DisablePort:8

**Table 147 - Output Data Type (20-Gb port switches) (Continued)**

<b>AB:STRATIX_5400_20PORT_GB_MANAGED:0:0</b>			
<b>Member Name</b>	<b>Type</b>	<b>Default Display Style</b>	<b>Valid Values</b>
PortGi1_9Disable	BOOL	Decimal	DisablePort:9
PortGi1_10Disable	BOOL	Decimal	DisablePort:10
PortGi1_11Disable	BOOL	Decimal	DisablePort:11
PortGi1_12Disable	BOOL	Decimal	DisablePort:12
PortGi1_13Disable	BOOL	Decimal	DisablePort:13
PortGi1_14Disable	BOOL	Decimal	DisablePort:14
PortGi1_15Disable	BOOL	Decimal	DisablePort:15
PortGi1_16Disable	BOOL	Decimal	DisablePort:16
PortGi1_17Disable	BOOL	Decimal	DisablePort:17
PortGi1_18Disable	BOOL	Decimal	DisablePort:18
PortGi1_19Disable	BOOL	Decimal	DisablePort:19
PortGi1_20Disable	BOOL	Decimal	DisablePort:20

## Stratix 5410 Data Types

The following tables list module-defined data types for Stratix 5410 switches. The tables include information for input (I) and output (O).

**Table 148 - Input Data Type**

<b>AB:STRATIX_5410_28PORT_GB_MANAGED:I:0</b>			
<b>Member Name</b>	<b>Type</b>	<b>Default Display Style</b>	<b>Valid Values</b>
Fault	DINT	Binary	
AnyPortConnected	BOOL	Decimal	LinkStatus:0
PortGi1_1Connected	BOOL	Decimal	LinkStatus:1
PortGi1_2Connected	BOOL	Decimal	LinkStatus:2
PortGi1_3Connected	BOOL	Decimal	LinkStatus:3
PortGi1_4Connected	BOOL	Decimal	LinkStatus:4
PortGi1_5Connected	BOOL	Decimal	LinkStatus:5
PortGi1_6Connected	BOOL	Decimal	LinkStatus:6
PortGi1_7Connected	BOOL	Decimal	LinkStatus:7
PortGi1_8Connected	BOOL	Decimal	LinkStatus:8
PortGi1_9Connected	BOOL	Decimal	LinkStatus:9
PortGi1_10Connected	BOOL	Decimal	LinkStatus:10
PortGi1_11Connected	BOOL	Decimal	LinkStatus:11
PortGi1_12Connected	BOOL	Decimal	LinkStatus:12
PortGi1_13Connected	BOOL	Decimal	LinkStatus:13
PortGi1_14Connected	BOOL	Decimal	LinkStatus:14
PortGi1_15Connected	BOOL	Decimal	LinkStatus:15
PortGi1_16Connected	BOOL	Decimal	LinkStatus:16
PortGi1_17Connected	BOOL	Decimal	LinkStatus:17
PortGi1_18Connected	BOOL	Decimal	LinkStatus:18
PortGi1_19Connected	BOOL	Decimal	LinkStatus:19
PortGi1_20Connected	BOOL	Decimal	LinkStatus:20
PortGi1_17Connected	BOOL	Decimal	LinkStatus:17
PortGi1_18Connected	BOOL	Decimal	LinkStatus:18
PortGi1_19Connected	BOOL	Decimal	LinkStatus:19
PortGi1_20Connected	BOOL	Decimal	LinkStatus:20
PortGi1_21Connected	BOOL	Decimal	LinkStatus:21
PortGi1_22Connected	BOOL	Decimal	LinkStatus:22
PortGi1_23Connected	BOOL	Decimal	LinkStatus:23
PortGi1_24Connected	BOOL	Decimal	LinkStatus:24
PortTe1_25Connected or PortGi1_25Connected	BOOL	Decimal	LinkStatus:25
PortTe1_26Connected or PortGi1_26Connected	BOOL	Decimal	LinkStatus:26

**Table 148 - Input Data Type (Continued)**

<b>AB:STRATIX_5410_28PORT_GB_MANAGED:I:0</b>			
<b>Member Name</b>	<b>Type</b>	<b>Default Display Style</b>	<b>Valid Values</b>
PortTe1_27Connected or PortGi1_27Connected	BOOL	Decimal	LinkStatus:27
PortTe1_28Connected or PortGi1_28Connected	BOOL	Decimal	LinkStatus:28
AnyPortUnauthorizedDevice	BOOL	Decimal	UnauthorizedDevice:0
PortGi1_1UnauthorizedDevice	BOOL	Decimal	UnauthorizedDevice:1
PortGi1_2UnauthorizedDevice	BOOL	Decimal	UnauthorizedDevice:2
PortGi1_3UnauthorizedDevice	BOOL	Decimal	UnauthorizedDevice:3
PortGi1_4UnauthorizedDevice	BOOL	Decimal	UnauthorizedDevice:4
PortGi1_5UnauthorizedDevice	BOOL	Decimal	UnauthorizedDevice:5
PortGi1_6UnauthorizedDevice	BOOL	Decimal	UnauthorizedDevice:6
PortGi1_7UnauthorizedDevice	BOOL	Decimal	UnauthorizedDevice:7
PortGi1_8UnauthorizedDevice	BOOL	Decimal	UnauthorizedDevice:8
PortGi1_9UnauthorizedDevice	BOOL	Decimal	UnauthorizedDevice:9
PortGi1_10UnauthorizedDevice	BOOL	Decimal	UnauthorizedDevice:10
PortGi1_11UnauthorizedDevice	BOOL	Decimal	UnauthorizedDevice:11
PortGi1_12UnauthorizedDevice	BOOL	Decimal	UnauthorizedDevice:12
PortGi1_13UnauthorizedDevice	BOOL	Decimal	UnauthorizedDevice:13
PortGi1_14UnauthorizedDevice	BOOL	Decimal	UnauthorizedDevice:14
PortGi1_15UnauthorizedDevice	BOOL	Decimal	UnauthorizedDevice:15
PortGi1_16UnauthorizedDevice	BOOL	Decimal	UnauthorizedDevice:16
PortGi1_17UnauthorizedDevice	BOOL	Decimal	UnauthorizedDevice:17
PortGi1_18UnauthorizedDevice	BOOL	Decimal	UnauthorizedDevice:18
PortGi1_19UnauthorizedDevice	BOOL	Decimal	UnauthorizedDevice:19
PortGi1_20UnauthorizedDevice	BOOL	Decimal	UnauthorizedDevice:20
PortGi1_21UnauthorizedDevice	BOOL	Decimal	UnauthorizedDevice:21
PortGi1_22UnauthorizedDevice	BOOL	Decimal	UnauthorizedDevice:22
PortGi1_23UnauthorizedDevice	BOOL	Decimal	UnauthorizedDevice:23
PortGi1_24UnauthorizedDevice	BOOL	Decimal	UnauthorizedDevice:24
PortTe1_25UnauthorizedDevice or PortGi1_25UnauthorizedDevice	BOOL	Decimal	UnauthorizedDevice:25
PortTe1_26UnauthorizedDevice or PortGi1_26UnauthorizedDevice	BOOL	Decimal	UnauthorizedDevice:26
PortTe1_27UnauthorizedDevice or PortGi1_27UnauthorizedDevice	BOOL	Decimal	UnauthorizedDevice:27



**Table 148 - Input Data Type (Continued)**

<b>AB:STRATIX_5410_28PORT_GB_MANAGED:I:0</b>			
<b>Member Name</b>	<b>Type</b>	<b>Default Display Style</b>	<b>Valid Values</b>
PortTe1_28UnauthorizedDevice or PortGi1_28UnauthorizedDevice	BOOL	Decimal	UnauthorizedDevice:28
AnyPortThreshold	BOOL	Decimal	ThresholdExceeded:0
PortGi1_1Threshold	BOOL	Decimal	ThresholdExceeded:1
PortGi1_2Threshold	BOOL	Decimal	ThresholdExceeded:2
PortGi1_3Threshold	BOOL	Decimal	ThresholdExceeded:3
PortGi1_4Threshold	BOOL	Decimal	ThresholdExceeded:4
PortGi1_5Threshold	BOOL	Decimal	ThresholdExceeded:5
PortGi1_6Threshold	BOOL	Decimal	ThresholdExceeded:6
PortGi1_7Threshold	BOOL	Decimal	ThresholdExceeded:7
PortGi1_8Threshold	BOOL	Decimal	ThresholdExceeded:8
PortGi1_9Threshold	BOOL	Decimal	ThresholdExceeded:9
PortGi1_10Threshold	BOOL	Decimal	ThresholdExceeded:10
PortGi1_11Threshold	BOOL	Decimal	ThresholdExceeded:11
PortGi1_12Threshold	BOOL	Decimal	ThresholdExceeded:12
PortGi1_13Threshold	BOOL	Decimal	ThresholdExceeded:13
PortGi1_14Threshold	BOOL	Decimal	ThresholdExceeded:14
PortGi1_15Threshold	BOOL	Decimal	ThresholdExceeded:15
PortGi1_16Threshold	BOOL	Decimal	ThresholdExceeded:16
PortGi1_17Threshold	BOOL	Decimal	ThresholdExceeded:17
PortGi1_18Threshold	BOOL	Decimal	ThresholdExceeded:18
PortGi1_19Threshold	BOOL	Decimal	ThresholdExceeded:19
PortGi1_20Threshold	BOOL	Decimal	ThresholdExceeded:20
PortGi1_21Threshold	BOOL	Decimal	ThresholdExceeded:21
PortGi1_22Threshold	BOOL	Decimal	ThresholdExceeded:22
PortGi1_23Threshold	BOOL	Decimal	ThresholdExceeded:23
PortGi1_24Threshold	BOOL	Decimal	ThresholdExceeded:24
PortTe1_25Threshold or PortGi1_25Threshold	BOOL	Decimal	ThresholdExceeded:25
PortTe1_26Threshold or PortGi1_26Threshold	BOOL	Decimal	ThresholdExceeded:26
PortTe1_27Threshold or PortGi1_27Threshold	BOOL	Decimal	ThresholdExceeded:27
PortTe1_28Threshold or PortGi1_28Threshold	BOOL	Decimal	ThresholdExceeded:28
AllPortsUtilization	SINT	Decimal	

**Table 148 - Input Data Type (Continued)**

<b>AB:STRATIX_5410_28PORT_GB_MANAGED:I:0</b>			
<b>Member Name</b>	<b>Type</b>	<b>Default Display Style</b>	<b>Valid Values</b>
PortGi1_1Utilization	SINT	Decimal	
PortGi1_2Utilization	SINT	Decimal	
PortGi1_3Utilization	SINT	Decimal	
PortGi1_4Utilization	SINT	Decimal	
PortGi1_5Utilization	SINT	Decimal	
PortGi1_6Utilization	SINT	Decimal	
PortGi1_7Utilization	SINT	Decimal	
PortGi1_8Utilization	SINT	Decimal	
PortGi1_9Utilization	SINT	Decimal	
PortGi1_10Utilization	SINT	Decimal	
PortGi1_11Utilization	SINT	Decimal	
PortGi1_12Utilization	SINT	Decimal	
PortGi1_13Utilization	SINT	Decimal	
PortGi1_14Utilization	SINT	Decimal	
PortGi1_15Utilization	SINT	Decimal	
PortGi1_16Utilization	SINT	Decimal	
PortGi1_17Utilization	SINT	Decimal	
PortGi1_18Utilization	SINT	Decimal	
PortGi1_19Utilization	SINT	Decimal	
PortGi1_20Utilization	SINT	Decimal	
PortGi1_21Utilization	SINT	Decimal	
PortGi1_22Utilization	SINT	Decimal	
PortGi1_23Utilization	SINT	Decimal	
PortGi1_24Utilization	SINT	Decimal	
PortTe1_25Utilization or PortGi1_25Utilization	SINT	Decimal	
PortTe1_26Utilization or PortGi1_26Utilization	SINT	Decimal	
PortTe1_27Utilization or PortGi1_27Utilization	SINT	Decimal	
PortTe1_28Utilization or PortGi1_28Utilization	SINT	Decimal	
MajorAlarmRelay	BOOL	Decimal	AlarmRelay:0
MulticastGroupActive	DINT	Binary	

**Table 149 - Output Data Type**

<b>AB:STRATIX_5410_28PORT_GB_MANAGED:0:0</b>			
<b>Member Name</b>	<b>Type</b>	<b>Default Display Style</b>	<b>Valid Values</b>
AllPortsDisabled	BOOL	Decimal	DisablePort:0
PortGi1_1Disable	BOOL	Decimal	DisablePort:1
PortGi1_2Disable	BOOL	Decimal	DisablePort:2
PortGi1_3Disable	BOOL	Decimal	DisablePort:3
PortGi1_4Disable	BOOL	Decimal	DisablePort:4
PortGi1_5Disable	BOOL	Decimal	DisablePort:5
PortGi1_6Disable	BOOL	Decimal	DisablePort:6
PortGi1_7Disable	BOOL	Decimal	DisablePort:7
PortGi1_8Disable	BOOL	Decimal	DisablePort:8
PortGi1_9Disable	BOOL	Decimal	DisablePort:9
PortGi1_10Disable	BOOL	Decimal	DisablePort:10
PortGi1_11Disable	BOOL	Decimal	DisablePort:11
PortGi1_12Disable	BOOL	Decimal	DisablePort:12
PortGi1_13Disable	BOOL	Decimal	DisablePort:13
PortGi1_14Disable	BOOL	Decimal	DisablePort:14
PortGi1_15Disable	BOOL	Decimal	DisablePort:15
PortGi1_16Disable	BOOL	Decimal	DisablePort:16
PortGi1_17Disable	BOOL	Decimal	DisablePort:17
PortGi1_18Disable	BOOL	Decimal	DisablePort:18
PortGi1_19Disable	BOOL	Decimal	DisablePort:19
PortGi1_20Disable	BOOL	Decimal	DisablePort:20
PortGi1_21Disable	BOOL	Decimal	DisablePort:21
PortGi1_22Disable	BOOL	Decimal	DisablePort:22
PortGi1_23Disable	BOOL	Decimal	DisablePort:23
PortGi1_24Disable	BOOL	Decimal	DisablePort:24
PortTe1_25Disable or PortGi1_25Disable	BOOL	Decimal	DisablePort:25
PortTe1_26Disable or PortGi1_26Disable	BOOL	Decimal	DisablePort:26
PortTe1_27Disable or PortGi1_27Disable	BOOL	Decimal	DisablePort:27
PortTe1_28Disable or PortGi1_28Disable	BOOL	Decimal	DisablePort:28

## Stratix 5700 and ArmorStratix 5700 Data Types

The following tables list module-defined data types for Stratix 5700 and ArmorStratix™ 5700 switches. The tables include information for input (I) and output (O).

### 6-port Gb Switches

Catalog numbers 1783-BMS4S2SGL, 1783-BMS4S2SGA, 1783-BMS06SGL, 1783-BM06SGA, 1783-BMS06TGL, 1783-BMS06TGA

**Table 150 - Input Data Types (6-port Gb switches)**

AB:STRATIX_5700_6PORT_GB_MANAGED:::0			
Member Name	Type	Default Display Style	Valid Values
Fault	DINT	Binary	
AnyPortConnected	BOOL	Decimal	LinkStatus:0
PortFa1_1Connected	BOOL	Decimal	LinkStatus:1
PortFa1_2Connected	BOOL	Decimal	LinkStatus:2
PortFa1_3Connected	BOOL	Decimal	LinkStatus:3
PortFa1_4Connected	BOOL	Decimal	LinkStatus:4
PortGi1_1Connected	BOOL	Decimal	LinkStatus:5
PortGi1_2Connected	BOOL	Decimal	LinkStatus:6
AnyPortUnauthorizedDevice	BOOL	Decimal	UnauthorizedDevice:0
PortFa1_1UnauthorizedDevice	BOOL	Decimal	UnauthorizedDevice:1
PortFa1_2UnauthorizedDevice	BOOL	Decimal	UnauthorizedDevice:2
PortFa1_3UnauthorizedDevice	BOOL	Decimal	UnauthorizedDevice:3
PortFa1_4UnauthorizedDevice	BOOL	Decimal	UnauthorizedDevice:4
PortGi1_1UnauthorizedDevice	BOOL	Decimal	UnauthorizedDevice:5
PortGi1_2UnauthorizedDevice	BOOL	Decimal	UnauthorizedDevice:6
AnyPortThreshold	BOOL	Decimal	ThresholdExceeded:0
PortFa1_1Threshold	BOOL	Decimal	ThresholdExceeded:1
PortFa1_2Threshold	BOOL	Decimal	ThresholdExceeded:2
PortFa1_3Threshold	BOOL	Decimal	ThresholdExceeded:3
PortFa1_4Threshold	BOOL	Decimal	ThresholdExceeded:4
PortGi1_1Threshold	BOOL	Decimal	ThresholdExceeded:5
PortGi1_2Threshold	BOOL	Decimal	ThresholdExceeded:6
AllPortsUtilization	SINT	Decimal	
PortFa1_1Utilization	SINT	Decimal	
PortFa1_2Utilization	SINT	Decimal	
PortFa1_3Utilization	SINT	Decimal	
PortFa1_4Utilization	SINT	Decimal	
PortGi1_1Utilization	SINT	Decimal	

**Table 150 - Input Data Types (6-port Gb switches) (Continued)**

<b>AB:STRATIX_5700_6PORT_GB_MANAGED:I:0</b>			
<b>Member Name</b>	<b>Type</b>	<b>Default Display Style</b>	<b>Valid Values</b>
PortGi1_2Utilization	SINT	Decimal	
MajorAlarmRelay	BOOL	Decimal	AlarmRelay:0
MulticastGroupsActive	DINT	Binary	

**Table 151 - Output Data Type (6-port Gb switches)**

<b>AB:STRATIX_5700_6PORT_GB_MANAGED:O:0</b>			
<b>Member Name</b>	<b>Type</b>	<b>Default Display Style</b>	<b>Valid Values</b>
AllPortsDisabled	BOOL	Decimal	DisablePort:0
PortFa1_1Disable	BOOL	Decimal	DisablePort:1
PortFa1_2Disable	BOOL	Decimal	DisablePort:2
PortFa1_3Disable	BOOL	Decimal	DisablePort:3
PortFa1_4Disable	BOOL	Decimal	DisablePort:4
PortGi1_1Disable	BOOL	Decimal	DisablePort:5
PortGi1_2Disable	BOOL	Decimal	DisablePort:6

## 6-port Switches

Catalog numbers 1783-BMS06SL, 1783-BMS06SA, 1783-BMS06TL, 1783-BMS06TA

**Table 152 - Input Data Type (6-port switches)**

<b>AB:STRATIX_5700_6PORT_MANAGED:I:0</b>			
<b>Member Name</b>	<b>Type</b>	<b>Default Display Style</b>	<b>Valid Values</b>
Fault	DINT	Binary	
AnyPortConnected	BOOL	Decimal	LinkStatus:0
PortFa1_1Connected	BOOL	Decimal	LinkStatus:1
PortFa1_2Connected	BOOL	Decimal	LinkStatus:2
PortFa1_3Connected	BOOL	Decimal	LinkStatus:3
PortFa1_4Connected	BOOL	Decimal	LinkStatus:4
PortFa1_5Connected	BOOL	Decimal	LinkStatus:5
PortFa1_6Connected	BOOL	Decimal	LinkStatus:6
AnyPortUnauthorizedDevice	BOOL	Decimal	UnauthorizedDevice:0
PortFa1_1UnauthorizedDevice	BOOL	Decimal	UnauthorizedDevice:1
PortFa1_2UnauthorizedDevice	BOOL	Decimal	UnauthorizedDevice:2
PortFa1_3UnauthorizedDevice	BOOL	Decimal	UnauthorizedDevice:3
PortFa1_4UnauthorizedDevice	BOOL	Decimal	UnauthorizedDevice:4
PortFa1_5UnauthorizedDevice	BOOL	Decimal	UnauthorizedDevice:5

**Table 152 - Input Data Type (6-port switches) (Continued)**

<b>AB:STRATIX_5700_6PORT_MANAGED:I:0</b>			
<b>Member Name</b>	<b>Type</b>	<b>Default Display Style</b>	<b>Valid Values</b>
PortFa1_6UnauthorizedDevice	BOOL	Decimal	UnauthorizedDevice:6
AnyPortThreshold	BOOL	Decimal	ThresholdExceeded:0
PortFa1_1Threshold	BOOL	Decimal	ThresholdExceeded:1
PortFa1_2Threshold	BOOL	Decimal	ThresholdExceeded:2
PortFa1_3Threshold	BOOL	Decimal	ThresholdExceeded:3
PortFa1_4Threshold	BOOL	Decimal	ThresholdExceeded:4
PortFa1_5Threshold	BOOL	Decimal	ThresholdExceeded:5
PortFa1_6Threshold	BOOL	Decimal	ThresholdExceeded:6
AllPortsUtilization	SINT	Decimal	
PortFa1_1Utilization	SINT	Decimal	
PortFa1_2Utilization	SINT	Decimal	
PortFa1_3Utilization	SINT	Decimal	
PortFa1_4Utilization	SINT	Decimal	
PortFa1_5Utilization	SINT	Decimal	
PortFa1_6Utilization	SINT	Decimal	
MajorAlarmRelay	BOOL	Decimal	AlarmRelay:0
MulticastGroupsActive	DINT	Binary	

**Table 153 - Output Data Type (6-port switches)**

<b>AB:STRATIX_5700_6PORT_MANAGED:O:0</b>			
<b>Member Name</b>	<b>Type</b>	<b>Default Display Style</b>	<b>Valid Values</b>
AllPortsDisabled	BOOL	Decimal	DisablePort:0
PortFa1_1Disable	BOOL	Decimal	DisablePort:1
PortFa1_2Disable	BOOL	Decimal	DisablePort:2
PortFa1_3Disable	BOOL	Decimal	DisablePort:3
PortFa1_4Disable	BOOL	Decimal	DisablePort:4
PortFa1_5Disable	BOOL	Decimal	DisablePort:5
PortFa1_6Disable	BOOL	Decimal	DisablePort:6

## 8-port Switches

Catalog number 1783-ZMS8TA

**Table 154 - Input Data Type (8-port switches)**

<b>AB:STRATIX_5700_8PORT_MANAGED:I:0</b>			
<b>Member Name</b>	<b>Type</b>	<b>Default Display Style</b>	<b>Valid Values</b>
Fault	DINT	Binary	
AnyPortConnected	BOOL	Decimal	LinkStatus:0
PortFa1_1Connected	BOOL	Decimal	LinkStatus:1
PortFa1_2Connected	BOOL	Decimal	LinkStatus:2
PortFa1_3Connected	BOOL	Decimal	LinkStatus:3
PortFa1_4Connected	BOOL	Decimal	LinkStatus:4
PortFa1_5Connected	BOOL	Decimal	LinkStatus:5
PortFa1_6Connected	BOOL	Decimal	LinkStatus:6
PortFa1_7Connected	BOOL	Decimal	LinkStatus:5
PortFa1_8Connected	BOOL	Decimal	LinkStatus:6
AnyPortUnauthorizedDevice	BOOL	Decimal	UnauthorizedDevice:0
PortFa1_1UnauthorizedDevice	BOOL	Decimal	UnauthorizedDevice:1
PortFa1_2UnauthorizedDevice	BOOL	Decimal	UnauthorizedDevice:2
PortFa1_3UnauthorizedDevice	BOOL	Decimal	UnauthorizedDevice:3
PortFa1_4UnauthorizedDevice	BOOL	Decimal	UnauthorizedDevice:4
PortFa1_5UnauthorizedDevice	BOOL	Decimal	UnauthorizedDevice:5
PortFa1_6UnauthorizedDevice	BOOL	Decimal	UnauthorizedDevice:6
PortFa1_7UnauthorizedDevice	BOOL	Decimal	UnauthorizedDevice:7
PortFa1_8UnauthorizedDevice	BOOL	Decimal	UnauthorizedDevice:8
AnyPortThreshold	BOOL	Decimal	ThresholdExceeded:0
PortFa1_1Threshold	BOOL	Decimal	ThresholdExceeded:1
PortFa1_2Threshold	BOOL	Decimal	ThresholdExceeded:2
PortFa1_3Threshold	BOOL	Decimal	ThresholdExceeded:3
PortFa1_4Threshold	BOOL	Decimal	ThresholdExceeded:4
PortFa1_5Threshold	BOOL	Decimal	ThresholdExceeded:5
PortFa1_6Threshold	BOOL	Decimal	ThresholdExceeded:6
PortFa1_7Threshold	BOOL	Decimal	ThresholdExceeded:5
PortFa1_8Threshold	BOOL	Decimal	ThresholdExceeded:6
AllPortsUtilization	SINT	Decimal	
PortFa1_1Utilization	SINT	Decimal	
PortFa1_2Utilization	SINT	Decimal	
PortFa1_3Utilization	SINT	Decimal	
PortFa1_4Utilization	SINT	Decimal	
PortFa1_5Utilization	SINT	Decimal	
PortFa1_6Utilization	SINT	Decimal	

**Table 154 - Input Data Type (8-port switches) (Continued)**

<b>AB:STRATIX_5700_8PORT_MANAGED:I:0</b>			
<b>Member Name</b>	<b>Type</b>	<b>Default Display Style</b>	<b>Valid Values</b>
PortFa1_7Utilization	SINT	Decimal	
PortFa1_8Utilization	SINT	Decimal	
MajorAlarmRelay	BOOL	Decimal	AlarmRelay:0
MulticastGroupsActive	DINT	Binary	

**Table 155 - Output Data Type (8-port switches)**

<b>AB:STRATIX_5700_8PORT_MANAGED:O:0</b>			
<b>Member Name</b>	<b>Type</b>	<b>Default Display Style</b>	<b>Valid Values</b>
AllPortsDisabled	BOOL	Decimal	DisablePort:0
PortFa1_1Disable	BOOL	Decimal	DisablePort:1
PortFa1_2Disable	BOOL	Decimal	DisablePort:2
PortFa1_3Disable	BOOL	Decimal	DisablePort:3
PortFa1_4Disable	BOOL	Decimal	DisablePort:4
PortFa1_5Disable	BOOL	Decimal	DisablePort:5
PortFa1_6Disable	BOOL	Decimal	DisablePort:6
PortFa1_7Disable	BOOL	Decimal	DisablePort:7
PortFa1_8Disable	BOOL	Decimal	DisablePort:8

## 10-port Gb Switches

Catalog numbers 1783-BMS10CGL, 1783-BMS10CGA, 1783-BMS10CGN, 1783-BMS10CGP, 1783-ZMS4T4E2TGN, 1783-ZMS4T4E2TGP

**Table 156 - Input Data Type (10-port Gb switches)**

<b>AB:STRATIX_5700_10PORT_GB_MANAGED:I:0</b>			
<b>Member Name</b>	<b>Type</b>	<b>Default Display Style</b>	<b>Valid Values</b>
Fault	DINT	Binary	
AnyPortConnected	BOOL	Decimal	LinkStatus:0
PortFa1_1Connected	BOOL	Decimal	LinkStatus:1
PortFa1_2Connected	BOOL	Decimal	LinkStatus:2
PortFa1_3Connected	BOOL	Decimal	LinkStatus:3
PortFa1_4Connected	BOOL	Decimal	LinkStatus:4
PortFa1_5Connected	BOOL	Decimal	LinkStatus:5
PortFa1_6Connected	BOOL	Decimal	LinkStatus:6
PortFa1_7Connected	BOOL	Decimal	LinkStatus:7
PortFa1_8Connected	BOOL	Decimal	LinkStatus:8



**Table 156 - Input Data Type (10-port Gb switches) (Continued)**

<b>AB:STRATIX_5700_10PORT_GB_MANAGED:I:0</b>			
<b>Member Name</b>	<b>Type</b>	<b>Default Display Style</b>	<b>Valid Values</b>
PortGi1_1Connected	BOOL	Decimal	LinkStatus:9
PortGi1_2Connected	BOOL	Decimal	LinkStatus:10
AnyPortUnauthorizedDevice	BOOL	Decimal	UnauthorizedDevice:0
PortFa1_1UnauthorizedDevice	BOOL	Decimal	UnauthorizedDevice:1
PortFa1_2UnauthorizedDevice	BOOL	Decimal	UnauthorizedDevice:2
PortFa1_3UnauthorizedDevice	BOOL	Decimal	UnauthorizedDevice:3
PortFa1_4UnauthorizedDevice	BOOL	Decimal	UnauthorizedDevice:4
PortFa1_5UnauthorizedDevice	BOOL	Decimal	UnauthorizedDevice:5
PortFa1_6UnauthorizedDevice	BOOL	Decimal	UnauthorizedDevice:6
PortFa1_7UnauthorizedDevice	BOOL	Decimal	UnauthorizedDevice:7
PortFa1_8UnauthorizedDevice	BOOL	Decimal	UnauthorizedDevice:8
PortGi1_1UnauthorizedDevice	BOOL	Decimal	UnauthorizedDevice:9
PortGi1_2UnauthorizedDevice	BOOL	Decimal	UnauthorizedDevice:10
AnyPortThreshold	BOOL	Decimal	ThresholdExceeded:0
PortFa1_1Threshold	BOOL	Decimal	ThresholdExceeded:1
PortFa1_2Threshold	BOOL	Decimal	ThresholdExceeded:2
PortFa1_3Threshold	BOOL	Decimal	ThresholdExceeded:3
PortFa1_4Threshold	BOOL	Decimal	ThresholdExceeded:4
PortFa1_5Threshold	BOOL	Decimal	ThresholdExceeded:5
PortFa1_6Threshold	BOOL	Decimal	ThresholdExceeded:6
PortFa1_7Threshold	BOOL	Decimal	ThresholdExceeded:7
PortFa1_8Threshold	BOOL	Decimal	ThresholdExceeded:8
PortGi1_1Threshold	BOOL	Decimal	ThresholdExceeded:9
PortGi1_2Threshold	BOOL	Decimal	ThresholdExceeded:10
AllPortsUtilization	SINT	Decimal	
PortFa1_1Utilization	SINT	Decimal	
PortFa1_2Utilization	SINT	Decimal	
PortFa1_3Utilization	SINT	Decimal	
PortFa1_4Utilization	SINT	Decimal	
PortFa1_5Utilization	SINT	Decimal	
PortFa1_6Utilization	SINT	Decimal	
PortFa1_7Utilization	SINT	Decimal	
PortFa1_8Utilization	SINT	Decimal	
PortGi1_1Utilization	SINT	Decimal	
PortGi1_2Utilization	SINT	Decimal	
MajorAlarmRelay	BOOL	Decimal	AlarmRelay:0
MulticastGroupsActive	DINT	Binary	

**Table 157 - Output Data Type (10-port Gb switches)**

<b>AB:STRATIX_5700_10PORT_MANAGED:O:0</b>			
<b>Member Name</b>	<b>Type</b>	<b>Default Display Style</b>	<b>Valid Values</b>
AllPortsDisabled	BOOL	Decimal	DisablePort:0
PortFa1_1Disable	BOOL	Decimal	DisablePort:1
PortFa1_2Disable	BOOL	Decimal	DisablePort:2
PortFa1_3Disable	BOOL	Decimal	DisablePort:3
PortFa1_4Disable	BOOL	Decimal	DisablePort:4
PortFa1_5Disable	BOOL	Decimal	DisablePort:5
PortFa1_6Disable	BOOL	Decimal	DisablePort:6
PortFa1_7Disable	BOOL	Decimal	DisablePort:7
PortFa1_8Disable	BOOL	Decimal	DisablePort:8
PortGi1_1Disable	BOOL	Decimal	DisablePort:9
PortGi1_2Disable	BOOL	Decimal	DisablePort:10

## 10-port Switches

Catalog numbers 1783-BMS10CL, 1783-BMS10CA

**Table 158 - Input Data Type (10-port switches)**

<b>AB:STRATIX_5700_10PORT_MANAGED:I:0</b>			
<b>Member Name</b>	<b>Type</b>	<b>Default Display Style</b>	<b>Valid Values</b>
Fault	DINT	Binary	
AnyPortConnected	BOOL	Decimal	LinkStatus:0
PortFa1_1Connected	BOOL	Decimal	LinkStatus:1
PortFa1_2Connected	BOOL	Decimal	LinkStatus:2
PortFa1_3Connected	BOOL	Decimal	LinkStatus:3
PortFa1_4Connected	BOOL	Decimal	LinkStatus:4
PortFa1_5Connected	BOOL	Decimal	LinkStatus:5
PortFa1_6Connected	BOOL	Decimal	LinkStatus:6
PortFa1_7Connected	BOOL	Decimal	LinkStatus:7
PortFa1_8Connected	BOOL	Decimal	LinkStatus:8
PortFa1_9Connected	BOOL	Decimal	LinkStatus:9
PortFa1_10Connected	BOOL	Decimal	LinkStatus:10
AnyPortUnauthorizedDevice	BOOL	Decimal	UnauthorizedDevice:0
PortFa1_1UnauthorizedDevice	BOOL	Decimal	UnauthorizedDevice:1
PortFa1_2UnauthorizedDevice	BOOL	Decimal	UnauthorizedDevice:2
PortFa1_3UnauthorizedDevice	BOOL	Decimal	UnauthorizedDevice:3
PortFa1_4UnauthorizedDevice	BOOL	Decimal	UnauthorizedDevice:4
PortFa1_5UnauthorizedDevice	BOOL	Decimal	UnauthorizedDevice:5

**Table 158 - Input Data Type (10-port switches) (Continued)**

<b>AB:STRATIX_5700_10PORT_MANAGED:I:0</b>			
<b>Member Name</b>	<b>Type</b>	<b>Default Display Style</b>	<b>Valid Values</b>
PortFa1_6UnauthorizedDevice	BOOL	Decimal	UnauthorizedDevice:6
PortFa1_7UnauthorizedDevice	BOOL	Decimal	UnauthorizedDevice:7
PortFa1_8UnauthorizedDevice	BOOL	Decimal	UnauthorizedDevice:8
PortFa1_9UnauthorizedDevice	BOOL	Decimal	UnauthorizedDevice:9
PortFa1_10UnauthorizedDevice	BOOL	Decimal	UnauthorizedDevice:10
AnyPortThreshold	BOOL	Decimal	ThresholdExceeded:0
PortFa1_1Threshold	BOOL	Decimal	ThresholdExceeded:1
PortFa1_2Threshold	BOOL	Decimal	ThresholdExceeded:2
PortFa1_3Threshold	BOOL	Decimal	ThresholdExceeded:3
PortFa1_4Threshold	BOOL	Decimal	ThresholdExceeded:4
PortFa1_5Threshold	BOOL	Decimal	ThresholdExceeded:5
PortFa1_6Threshold	BOOL	Decimal	ThresholdExceeded:6
PortFa1_7Threshold	BOOL	Decimal	ThresholdExceeded:7
PortFa1_8Threshold	BOOL	Decimal	ThresholdExceeded:8
PortFa1_9Threshold	BOOL	Decimal	ThresholdExceeded:9
PortFa1_10Threshold	BOOL	Decimal	ThresholdExceeded:10
AllPortsUtilization	SINT	Decimal	
PortFa1_1Utilization	SINT	Decimal	
PortFa1_2Utilization	SINT	Decimal	
PortFa1_3Utilization	SINT	Decimal	
PortFa1_4Utilization	SINT	Decimal	
PortFa1_5Utilization	SINT	Decimal	
PortFa1_6Utilization	SINT	Decimal	
PortFa1_7Utilization	SINT	Decimal	
PortFa1_8Utilization	SINT	Decimal	
PortFa1_9Utilization	SINT	Decimal	
PortFa1_10Utilization	SINT	Decimal	
MajorAlarmRelay	BOOL	Decimal	AlarmRelay:0
MulticastGroupsActive	DINT	Binary	

**Table 159 - Output Data Type (10-port switches)**

<b>AB:STRATIX_5700_10PORT_MANAGED:0:0</b>			
<b>Member Name</b>	<b>Type</b>	<b>Default Display Style</b>	<b>Valid Values</b>
AllPortsDisabled	BOOL	Decimal	DisablePort:0
PortFa1_1Disable	BOOL	Decimal	DisablePort:1
PortFa1_2Disable	BOOL	Decimal	DisablePort:2
PortFa1_3Disable	BOOL	Decimal	DisablePort:3
PortFa1_4Disable	BOOL	Decimal	DisablePort:4
PortFa1_5Disable	BOOL	Decimal	DisablePort:5
PortFa1_6Disable	BOOL	Decimal	DisablePort:6
PortFa1_7Disable	BOOL	Decimal	DisablePort:7
PortFa1_8Disable	BOOL	Decimal	DisablePort:8
PortFa1_9Disable	BOOL	Decimal	DisablePort:9
PortFa1_10Disable	BOOL	Decimal	DisablePort:10

## 16-port Switches

Catalog number 1783-ZMS16TA

**Table 160 - Input Data Type (16-port switches)**

<b>AB:STRATIX_5700_16PORT_MANAGED:I:0</b>			
<b>Member Name</b>	<b>Type</b>	<b>Default Display Style</b>	<b>Valid Values</b>
Fault	DINT	Binary	
AnyPortConnected	BOOL	Decimal	LinkStatus:0
PortFa1_1Connected	BOOL	Decimal	LinkStatus:1
PortFa1_2Connected	BOOL	Decimal	LinkStatus:2
PortFa1_3Connected	BOOL	Decimal	LinkStatus:3
PortFa1_4Connected	BOOL	Decimal	LinkStatus:4
PortFa1_5Connected	BOOL	Decimal	LinkStatus:5
PortFa1_6Connected	BOOL	Decimal	LinkStatus:6
PortFa1_7Connected	BOOL	Decimal	LinkStatus:7
PortFa1_8Connected	BOOL	Decimal	LinkStatus:8
PortFa1_9Connected	BOOL	Decimal	LinkStatus:9
PortFa1_10Connected	BOOL	Decimal	LinkStatus:10
PortFa1_11Connected	BOOL	Decimal	LinkStatus:11
PortFa1_12Connected	BOOL	Decimal	LinkStatus:12
PortFa1_13Connected	BOOL	Decimal	LinkStatus:13
PortFa1_14Connected	BOOL	Decimal	LinkStatus:14
PortFa1_15Connected	BOOL	Decimal	LinkStatus:15
PortFa1_16Connected	BOOL	Decimal	LinkStatus:16

**Table 160 - Input Data Type (16-port switches) (Continued)**

<b>AB:STRATIX_5700_16PORT_MANAGED:I:0</b>			
<b>Member Name</b>	<b>Type</b>	<b>Default Display Style</b>	<b>Valid Values</b>
AnyPortUnauthorizedDevice	BOOL	Decimal	UnauthorizedDevice:0
PortFa1_1UnauthorizedDevice	BOOL	Decimal	UnauthorizedDevice:1
PortFa1_2UnauthorizedDevice	BOOL	Decimal	UnauthorizedDevice:2
PortFa1_3UnauthorizedDevice	BOOL	Decimal	UnauthorizedDevice:3
PortFa1_4UnauthorizedDevice	BOOL	Decimal	UnauthorizedDevice:4
PortFa1_5UnauthorizedDevice	BOOL	Decimal	UnauthorizedDevice:5
PortFa1_6UnauthorizedDevice	BOOL	Decimal	UnauthorizedDevice:6
PortFa1_7UnauthorizedDevice	BOOL	Decimal	UnauthorizedDevice:7
PortFa1_8UnauthorizedDevice	BOOL	Decimal	UnauthorizedDevice:8
PortFa1_9UnauthorizedDevice	BOOL	Decimal	UnauthorizedDevice:9
PortFa1_10UnauthorizedDevice	BOOL	Decimal	UnauthorizedDevice:10
PortFa1_11UnauthorizedDevice	BOOL	Decimal	UnauthorizedDevice:11
PortFa1_12UnauthorizedDevice	BOOL	Decimal	UnauthorizedDevice:12
PortFa1_13UnauthorizedDevice	BOOL	Decimal	UnauthorizedDevice:13
PortFa1_14UnauthorizedDevice	BOOL	Decimal	UnauthorizedDevice:14
PortFa1_15UnauthorizedDevice	BOOL	Decimal	UnauthorizedDevice:15
PortFa1_16UnauthorizedDevice	BOOL	Decimal	UnauthorizedDevice:16
AnyPortThreshold	BOOL	Decimal	ThresholdExceeded:0
PortFa1_1Threshold	BOOL	Decimal	ThresholdExceeded:1
PortFa1_2Threshold	BOOL	Decimal	ThresholdExceeded:2
PortFa1_3Threshold	BOOL	Decimal	ThresholdExceeded:3
PortFa1_4Threshold	BOOL	Decimal	ThresholdExceeded:4
PortFa1_5Threshold	BOOL	Decimal	ThresholdExceeded:5
PortFa1_6Threshold	BOOL	Decimal	ThresholdExceeded:6
PortFa1_7Threshold	BOOL	Decimal	ThresholdExceeded:7
PortFa1_8Threshold	BOOL	Decimal	ThresholdExceeded:8
PortFa1_9Threshold	BOOL	Decimal	ThresholdExceeded:9
PortFa1_10Threshold	BOOL	Decimal	ThresholdExceeded:10
PortFa1_11Threshold	BOOL	Decimal	ThresholdExceeded:11
PortFa1_12Threshold	BOOL	Decimal	ThresholdExceeded:12
PortFa1_13Threshold	BOOL	Decimal	ThresholdExceeded:13
PortFa1_14Threshold	BOOL	Decimal	ThresholdExceeded:14
PortFa1_15Threshold	BOOL	Decimal	ThresholdExceeded:15
PortFa1_16Threshold	BOOL	Decimal	ThresholdExceeded:16
AllPortsUtilization	SINT	Decimal	
PortFa1_1Utilization	SINT	Decimal	
PortFa1_2Utilization	SINT	Decimal	
PortFa1_3Utilization	SINT	Decimal	

**Table 160 - Input Data Type (16-port switches) (Continued)**

<b>AB:STRATIX_5700_16PORT_MANAGED:I:0</b>			
<b>Member Name</b>	<b>Type</b>	<b>Default Display Style</b>	<b>Valid Values</b>
PortFa1_4Utilization	SINT	Decimal	
PortFa1_5Utilization	SINT	Decimal	
PortFa1_6Utilization	SINT	Decimal	
PortFa1_7Utilization	SINT	Decimal	
PortFa1_8Utilization	SINT	Decimal	
PortFa1_9Utilization	SINT	Decimal	
PortFa1_10Utilization	SINT	Decimal	
PortFa1_11Utilization	SINT	Decimal	
PortFa1_12Utilization	SINT	Decimal	
PortFa1_13Utilization	SINT	Decimal	
PortFa1_14Utilization	SINT	Decimal	
PortFa1_15Utilization	SINT	Decimal	
PortFa1_16Utilization	SINT	Decimal	
MajorAlarmRelay	BOOL	Decimal	AlarmRelay:0
MulticastGroupsActive	DINT	Binary	

**Table 161 - Output Data Type (16-port switches)**

<b>AB:STRATIX_5700_16PORT_MANAGED:O:0</b>			
<b>Member Name</b>	<b>Type</b>	<b>Default Display Style</b>	<b>Valid Values</b>
AllPortsDisabled	BOOL	Decimal	DisablePort:0
PortFa1_1Disable	BOOL	Decimal	DisablePort:1
PortFa1_2Disable	BOOL	Decimal	DisablePort:2
PortFa1_3Disable	BOOL	Decimal	DisablePort:3
PortFa1_4Disable	BOOL	Decimal	DisablePort:4
PortFa1_5Disable	BOOL	Decimal	DisablePort:5
PortFa1_6Disable	BOOL	Decimal	DisablePort:6
PortFa1_7Disable	BOOL	Decimal	DisablePort:7
PortFa1_8Disable	BOOL	Decimal	DisablePort:8
PortFa1_9Disable	BOOL	Decimal	DisablePort:9
PortFa1_10Disable	BOOL	Decimal	DisablePort:10
PortFa1_11Disable	BOOL	Decimal	DisablePort:11
PortFa1_12Disable	BOOL	Decimal	DisablePort:12
PortFa1_13Disable	BOOL	Decimal	DisablePort:13
PortFa1_14Disable	BOOL	Decimal	DisablePort:14
PortFa1_15Disable	BOOL	Decimal	DisablePort:15
PortFa1_16Disable	BOOL	Decimal	DisablePort:16

## 20-port Gb Switches

Catalog numbers 1783-BMS20CGL, 1783-BMS20CGN, 1783-BMS20CGP, 1783-BMS20CGPK

**Table 162 - Input Data Type (20-port Gb switches)**

AB:STRATIX_5700_20PORT_GB_MANAGED:I:0			
Member Name	Type	Default Display Style	Valid Values
Fault	DINT	Binary	
AnyPortConnected	BOOL	Decimal	LinkStatus:0
PortFa1_1Connected	BOOL	Decimal	LinkStatus:1
PortFa1_2Connected	BOOL	Decimal	LinkStatus:2
PortFa1_3Connected	BOOL	Decimal	LinkStatus:3
PortFa1_4Connected	BOOL	Decimal	LinkStatus:4
PortFa1_5Connected	BOOL	Decimal	LinkStatus:5
PortFa1_6Connected	BOOL	Decimal	LinkStatus:6
PortFa1_7Connected	BOOL	Decimal	LinkStatus:7
PortFa1_8Connected	BOOL	Decimal	LinkStatus:8
PortFa1_9Connected	BOOL	Decimal	LinkStatus:9
PortFa1_10Connected	BOOL	Decimal	LinkStatus:10
PortFa1_11Connected	BOOL	Decimal	LinkStatus:11
PortFa1_12Connected	BOOL	Decimal	LinkStatus:12
PortFa1_13Connected	BOOL	Decimal	LinkStatus:13
PortFa1_14Connected	BOOL	Decimal	LinkStatus:14
PortFa1_15Connected	BOOL	Decimal	LinkStatus:15
PortFa1_16Connected	BOOL	Decimal	LinkStatus:16
PortFa1_17Connected	BOOL	Decimal	LinkStatus:17
PortFa1_18Connected	BOOL	Decimal	LinkStatus:18
PortGi1_1Connected	BOOL	Decimal	LinkStatus:19
PortGi1_2Connected	BOOL	Decimal	LinkStatus:20
AnyPortUnauthorizedDevice	BOOL	Decimal	UnauthorizedDevice:0
PortFa1_1UnauthorizedDevice	BOOL	Decimal	UnauthorizedDevice:1
PortFa1_2UnauthorizedDevice	BOOL	Decimal	UnauthorizedDevice:2
PortFa1_3UnauthorizedDevice	BOOL	Decimal	UnauthorizedDevice:3
PortFa1_4UnauthorizedDevice	BOOL	Decimal	UnauthorizedDevice:4
PortFa1_5UnauthorizedDevice	BOOL	Decimal	UnauthorizedDevice:5
PortFa1_6UnauthorizedDevice	BOOL	Decimal	UnauthorizedDevice:6
PortFa1_7UnauthorizedDevice	BOOL	Decimal	UnauthorizedDevice:7
PortFa1_8UnauthorizedDevice	BOOL	Decimal	UnauthorizedDevice:8
PortFa1_9UnauthorizedDevice	BOOL	Decimal	UnauthorizedDevice:9
PortFa1_10UnauthorizedDevice	BOOL	Decimal	UnauthorizedDevice:10
PortFa1_11UnauthorizedDevice	BOOL	Decimal	UnauthorizedDevice:11

**Table 162 - Input Data Type (20-port Gb switches) (Continued)**

<b>AB:STRATIX_5700_20PORT_GB_MANAGED:I:0</b>			
<b>Member Name</b>	<b>Type</b>	<b>Default Display Style</b>	<b>Valid Values</b>
PortFa1_12UnauthorizedDevice	BOOL	Decimal	UnauthorizedDevice:12
PortFa1_13UnauthorizedDevice	BOOL	Decimal	UnauthorizedDevice:13
PortFa1_14UnauthorizedDevice	BOOL	Decimal	UnauthorizedDevice:14
PortFa1_15UnauthorizedDevice	BOOL	Decimal	UnauthorizedDevice:15
PortFa1_16UnauthorizedDevice	BOOL	Decimal	UnauthorizedDevice:16
PortFa1_17UnauthorizedDevice	BOOL	Decimal	UnauthorizedDevice:17
PortFa1_18UnauthorizedDevice	BOOL	Decimal	UnauthorizedDevice:18
PortGi1_1UnauthorizedDevice	BOOL	Decimal	UnauthorizedDevice:19
PortGi1_2UnauthorizedDevice	BOOL	Decimal	UnauthorizedDevice:20
AnyPortThreshold	BOOL	Decimal	ThresholdExceeded:0
PortFa1_1Threshold	BOOL	Decimal	ThresholdExceeded:1
PortFa1_2Threshold	BOOL	Decimal	ThresholdExceeded:2
PortFa1_3Threshold	BOOL	Decimal	ThresholdExceeded:3
PortFa1_4Threshold	BOOL	Decimal	ThresholdExceeded:4
PortFa1_5Threshold	BOOL	Decimal	ThresholdExceeded:5
PortFa1_6Threshold	BOOL	Decimal	ThresholdExceeded:6
PortFa1_7Threshold	BOOL	Decimal	ThresholdExceeded:7
PortFa1_8Threshold	BOOL	Decimal	ThresholdExceeded:8
PortFa1_9Threshold	BOOL	Decimal	ThresholdExceeded:9
PortFa1_10Threshold	BOOL	Decimal	ThresholdExceeded:10
PortFa1_11Threshold	BOOL	Decimal	ThresholdExceeded:11
PortFa1_12Threshold	BOOL	Decimal	ThresholdExceeded:12
PortFa1_13Threshold	BOOL	Decimal	ThresholdExceeded:13
PortFa1_14Threshold	BOOL	Decimal	ThresholdExceeded:14
PortFa1_15Threshold	BOOL	Decimal	ThresholdExceeded:15
PortFa1_16Threshold	BOOL	Decimal	ThresholdExceeded:16
PortFa1_17Threshold	BOOL	Decimal	ThresholdExceeded:17
PortFa1_18Threshold	BOOL	Decimal	ThresholdExceeded:18
PortGi1_1Threshold	BOOL	Decimal	ThresholdExceeded:19
PortGi1_2Threshold	BOOL	Decimal	ThresholdExceeded:20
AllPortsUtilization	SINT	Decimal	
PortFa1_1Utilization	SINT	Decimal	
PortFa1_2Utilization	SINT	Decimal	
PortFa1_3Utilization	SINT	Decimal	
PortFa1_4Utilization	SINT	Decimal	
PortFa1_5Utilization	SINT	Decimal	
PortFa1_6Utilization	SINT	Decimal	
PortFa1_7Utilization	SINT	Decimal	



**Table 162 - Input Data Type (20-port Gb switches) (Continued)**

<b>AB:STRATIX_5700_20PORT_GB_MANAGED:I:0</b>			
<b>Member Name</b>	<b>Type</b>	<b>Default Display Style</b>	<b>Valid Values</b>
PortFa1_8Utilization	SINT	Decimal	
PortFa1_9Utilization	SINT	Decimal	
PortFa1_10Utilization	SINT	Decimal	
PortFa1_11Utilization	SINT	Decimal	
PortFa1_12Utilization	SINT	Decimal	
PortFa1_13Utilization	SINT	Decimal	
PortFa1_14Utilization	SINT	Decimal	
PortFa1_15Utilization	SINT	Decimal	
PortFa1_16Utilization	SINT	Decimal	
PortFa1_17Utilization	SINT	Decimal	
PortFa1_18Utilization	SINT	Decimal	
PortGi1_1Utilization	SINT	Decimal	
PortGi1_2Utilization	SINT	Decimal	
MajorAlarmRelay	BOOL	Decimal	AlarmRelay:0
MulticastGroupsActive	DINT	Binary	

## 18-port Gb Switches

Catalog numbers 1783-BMS12T4E2CGNK, 1783-BMS12T4E2CGP, 1783-BMS12T4E2CGL, 1783-ZMS8T8E2TGN, 1783-ZMS8T8E2TGP

**Table 163 - Input Data Type (18-port Gb switches)**

<b>AB:STRATIX_5700_18PORT_GB_MANAGED:I:0</b>			
<b>Member Name</b>	<b>Type</b>	<b>Default Display Style</b>	<b>Valid Values</b>
Fault	DINT	Binary	
AnyPortConnected	BOOL	Decimal	LinkStatus:0
PortFa1_1Connected	BOOL	Decimal	LinkStatus:1
PortFa1_2Connected	BOOL	Decimal	LinkStatus:2
PortFa1_3Connected	BOOL	Decimal	LinkStatus:3
PortFa1_4Connected	BOOL	Decimal	LinkStatus:4
PortFa1_5Connected	BOOL	Decimal	LinkStatus:5
PortFa1_6Connected	BOOL	Decimal	LinkStatus:6
PortFa1_7Connected	BOOL	Decimal	LinkStatus:7
PortFa1_8Connected	BOOL	Decimal	LinkStatus:8
PortFa1_9Connected	BOOL	Decimal	LinkStatus:9
PortFa1_10Connected	BOOL	Decimal	LinkStatus:10
PortFa1_11Connected	BOOL	Decimal	LinkStatus:11
PortFa1_12Connected	BOOL	Decimal	LinkStatus:12

**Table 163 - Input Data Type (18-port Gb switches) (Continued)**

<b>AB:STRATIX_5700_18PORT_GB_MANAGED:I:0</b>			
<b>Member Name</b>	<b>Type</b>	<b>Default Display Style</b>	<b>Valid Values</b>
PortFa1_13Connected	BOOL	Decimal	LinkStatus:13
PortFa1_14Connected	BOOL	Decimal	LinkStatus:14
PortFa1_15Connected	BOOL	Decimal	LinkStatus:15
PortFa1_16Connected	BOOL	Decimal	LinkStatus:16
PortGi1_1Connected	BOOL	Decimal	LinkStatus:19
PortGi1_2Connected	BOOL	Decimal	LinkStatus:20
AnyPortUnauthorizedDevice	BOOL	Decimal	UnauthorizedDevice:0
PortFa1_1UnauthorizedDevice	BOOL	Decimal	UnauthorizedDevice:1
PortFa1_2UnauthorizedDevice	BOOL	Decimal	UnauthorizedDevice:2
PortFa1_3UnauthorizedDevice	BOOL	Decimal	UnauthorizedDevice:3
PortFa1_4UnauthorizedDevice	BOOL	Decimal	UnauthorizedDevice:4
PortFa1_5UnauthorizedDevice	BOOL	Decimal	UnauthorizedDevice:5
PortFa1_6UnauthorizedDevice	BOOL	Decimal	UnauthorizedDevice:6
PortFa1_7UnauthorizedDevice	BOOL	Decimal	UnauthorizedDevice:7
PortFa1_8UnauthorizedDevice	BOOL	Decimal	UnauthorizedDevice:8
PortFa1_9UnauthorizedDevice	BOOL	Decimal	UnauthorizedDevice:9
PortFa1_10UnauthorizedDevice	BOOL	Decimal	UnauthorizedDevice:10
PortFa1_11UnauthorizedDevice	BOOL	Decimal	UnauthorizedDevice:11
PortFa1_12UnauthorizedDevice	BOOL	Decimal	UnauthorizedDevice:12
PortFa1_13UnauthorizedDevice	BOOL	Decimal	UnauthorizedDevice:13
PortFa1_14UnauthorizedDevice	BOOL	Decimal	UnauthorizedDevice:14
PortFa1_15UnauthorizedDevice	BOOL	Decimal	UnauthorizedDevice:15
PortFa1_16UnauthorizedDevice	BOOL	Decimal	UnauthorizedDevice:16
PortGi1_1UnauthorizedDevice	BOOL	Decimal	UnauthorizedDevice:19
PortGi1_2UnauthorizedDevice	BOOL	Decimal	UnauthorizedDevice:20
AnyPortThreshold	BOOL	Decimal	ThresholdExceeded:0
PortFa1_1Threshold	BOOL	Decimal	ThresholdExceeded:1
PortFa1_2Threshold	BOOL	Decimal	ThresholdExceeded:2
PortFa1_3Threshold	BOOL	Decimal	ThresholdExceeded:3
PortFa1_4Threshold	BOOL	Decimal	ThresholdExceeded:4
PortFa1_5Threshold	BOOL	Decimal	ThresholdExceeded:5
PortFa1_6Threshold	BOOL	Decimal	ThresholdExceeded:6
PortFa1_7Threshold	BOOL	Decimal	ThresholdExceeded:7
PortFa1_8Threshold	BOOL	Decimal	ThresholdExceeded:8
PortFa1_9Threshold	BOOL	Decimal	ThresholdExceeded:9
PortFa1_10Threshold	BOOL	Decimal	ThresholdExceeded:10
PortFa1_11Threshold	BOOL	Decimal	ThresholdExceeded:11
PortFa1_12Threshold	BOOL	Decimal	ThresholdExceeded:12

**Table 163 - Input Data Type (18-port Gb switches) (Continued)**

<b>AB:STRATIX_5700_18PORT_GB_MANAGED:I:0</b>			
<b>Member Name</b>	<b>Type</b>	<b>Default Display Style</b>	<b>Valid Values</b>
PortFa1_13Threshold	BOOL	Decimal	ThresholdExceeded:13
PortFa1_14Threshold	BOOL	Decimal	ThresholdExceeded:14
PortFa1_15Threshold	BOOL	Decimal	ThresholdExceeded:15
PortFa1_16Threshold	BOOL	Decimal	ThresholdExceeded:16
PortGi1_1Threshold	BOOL	Decimal	ThresholdExceeded:19
PortGi1_2Threshold	BOOL	Decimal	ThresholdExceeded:20
AllPortsUtilization	SINT	Decimal	
PortFa1_1Utilization	SINT	Decimal	
PortFa1_2Utilization	SINT	Decimal	
PortFa1_3Utilization	SINT	Decimal	
PortFa1_4Utilization	SINT	Decimal	
PortFa1_5Utilization	SINT	Decimal	
PortFa1_6Utilization	SINT	Decimal	
PortFa1_7Utilization	SINT	Decimal	
PortFa1_8Utilization	SINT	Decimal	
PortFa1_9Utilization	SINT	Decimal	
PortFa1_10Utilization	SINT	Decimal	
PortFa1_11Utilization	SINT	Decimal	
PortFa1_12Utilization	SINT	Decimal	
PortFa1_13Utilization	SINT	Decimal	
PortFa1_14Utilization	SINT	Decimal	
PortFa1_15Utilization	SINT	Decimal	
PortFa1_16Utilization	SINT	Decimal	
PortGi1_1Utilization	SINT	Decimal	
PortGi1_2Utilization	SINT	Decimal	
MajorAlarmRelay	BOOL	Decimal	AlarmRelay:0
MulticastGroupsActive	DINT	Binary	

**Table 164 - Output Data Type (18-port Gb switches)**

<b>AB:STRATIX_5700_20PORT_GB_MANAGED:O:0</b>			
<b>Member Name</b>	<b>Type</b>	<b>Default Display Style</b>	<b>Valid Values</b>
AllPortsDisabled	BOOL	Decimal	DisablePort:0
PortFa1_1Disable	BOOL	Decimal	DisablePort:1
PortFa1_2Disable	BOOL	Decimal	DisablePort:2
PortFa1_3Disable	BOOL	Decimal	DisablePort:3
PortFa1_4Disable	BOOL	Decimal	DisablePort:4
PortFa1_5Disable	BOOL	Decimal	DisablePort:5

**Table 164 - Output Data Type (18-port Gb switches) (Continued)**

<b>AB:STRATIX_5700_20PORT_GB_MANAGED:0:0</b>			
<b>Member Name</b>	<b>Type</b>	<b>Default Display Style</b>	<b>Valid Values</b>
PortFa1_6Disable	BOOL	Decimal	DisablePort:6
PortFa1_7Disable	BOOL	Decimal	DisablePort:7
PortFa1_8Disable	BOOL	Decimal	DisablePort:8
PortFa1_9Disable	BOOL	Decimal	DisablePort:9
PortFa1_10Disable	BOOL	Decimal	DisablePort:10
PortFa1_11Disable	BOOL	Decimal	DisablePort:11
PortFa1_12Disable	BOOL	Decimal	DisablePort:12
PortFa1_13Disable	BOOL	Decimal	DisablePort:13
PortFa1_14Disable	BOOL	Decimal	DisablePort:14
PortFa1_15Disable	BOOL	Decimal	DisablePort:15
PortFa1_16Disable	BOOL	Decimal	DisablePort:16
PortGi1_1Disable	BOOL	Decimal	DisablePort:19
PortGi1_2Disable	BOOL	Decimal	DisablePort:20

## 20-port Gb Switches

Catalog numbers 1783-BMS20CGL, 1783-BMS20CGN, 1783-BMS20CGP, 1783-BMS20CGPK

**Table 165 - Input Data Type (20-port Gb switches)**

AB:STRATIX_5700_20PORT_GB_MANAGED:I:0			
Member Name	Type	Default Display Style	Valid Values
Fault	DINT	Binary	
AnyPortConnected	BOOL	Decimal	LinkStatus:0
PortFa1_1Connected	BOOL	Decimal	LinkStatus:1
PortFa1_2Connected	BOOL	Decimal	LinkStatus:2
PortFa1_3Connected	BOOL	Decimal	LinkStatus:3
PortFa1_4Connected	BOOL	Decimal	LinkStatus:4
PortFa1_5Connected	BOOL	Decimal	LinkStatus:5
PortFa1_6Connected	BOOL	Decimal	LinkStatus:6
PortFa1_7Connected	BOOL	Decimal	LinkStatus:7
PortFa1_8Connected	BOOL	Decimal	LinkStatus:8
PortFa1_9Connected	BOOL	Decimal	LinkStatus:9
PortFa1_10Connected	BOOL	Decimal	LinkStatus:10
PortFa1_11Connected	BOOL	Decimal	LinkStatus:11
PortFa1_12Connected	BOOL	Decimal	LinkStatus:12
PortFa1_13Connected	BOOL	Decimal	LinkStatus:13
PortFa1_14Connected	BOOL	Decimal	LinkStatus:14
PortFa1_15Connected	BOOL	Decimal	LinkStatus:15
PortFa1_16Connected	BOOL	Decimal	LinkStatus:16
PortFa1_17Connected	BOOL	Decimal	LinkStatus:17
PortFa1_18Connected	BOOL	Decimal	LinkStatus:18
PortGi1_1Connected	BOOL	Decimal	LinkStatus:19
PortGi1_2Connected	BOOL	Decimal	LinkStatus:20
AnyPortUnauthorizedDevice	BOOL	Decimal	UnauthorizedDevice:0
PortFa1_1UnauthorizedDevice	BOOL	Decimal	UnauthorizedDevice:1
PortFa1_2UnauthorizedDevice	BOOL	Decimal	UnauthorizedDevice:2
PortFa1_3UnauthorizedDevice	BOOL	Decimal	UnauthorizedDevice:3
PortFa1_4UnauthorizedDevice	BOOL	Decimal	UnauthorizedDevice:4
PortFa1_5UnauthorizedDevice	BOOL	Decimal	UnauthorizedDevice:5
PortFa1_6UnauthorizedDevice	BOOL	Decimal	UnauthorizedDevice:6
PortFa1_7UnauthorizedDevice	BOOL	Decimal	UnauthorizedDevice:7
PortFa1_8UnauthorizedDevice	BOOL	Decimal	UnauthorizedDevice:8
PortFa1_9UnauthorizedDevice	BOOL	Decimal	UnauthorizedDevice:9
PortFa1_10UnauthorizedDevice	BOOL	Decimal	UnauthorizedDevice:10
PortFa1_11UnauthorizedDevice	BOOL	Decimal	UnauthorizedDevice:11

**Table 165 - Input Data Type (20-port Gb switches) (Continued)**

<b>AB:STRATIX_5700_20PORT_GB_MANAGED:I:0</b>			
<b>Member Name</b>	<b>Type</b>	<b>Default Display Style</b>	<b>Valid Values</b>
PortFa1_12UnauthorizedDevice	BOOL	Decimal	UnauthorizedDevice:12
PortFa1_13UnauthorizedDevice	BOOL	Decimal	UnauthorizedDevice:13
PortFa1_14UnauthorizedDevice	BOOL	Decimal	UnauthorizedDevice:14
PortFa1_15UnauthorizedDevice	BOOL	Decimal	UnauthorizedDevice:15
PortFa1_16UnauthorizedDevice	BOOL	Decimal	UnauthorizedDevice:16
PortFa1_17UnauthorizedDevice	BOOL	Decimal	UnauthorizedDevice:17
PortFa1_18UnauthorizedDevice	BOOL	Decimal	UnauthorizedDevice:18
PortGi1_1UnauthorizedDevice	BOOL	Decimal	UnauthorizedDevice:19
PortGi1_2UnauthorizedDevice	BOOL	Decimal	UnauthorizedDevice:20
AnyPortThreshold	BOOL	Decimal	ThresholdExceeded:0
PortFa1_1Threshold	BOOL	Decimal	ThresholdExceeded:1
PortFa1_2Threshold	BOOL	Decimal	ThresholdExceeded:2
PortFa1_3Threshold	BOOL	Decimal	ThresholdExceeded:3
PortFa1_4Threshold	BOOL	Decimal	ThresholdExceeded:4
PortFa1_5Threshold	BOOL	Decimal	ThresholdExceeded:5
PortFa1_6Threshold	BOOL	Decimal	ThresholdExceeded:6
PortFa1_7Threshold	BOOL	Decimal	ThresholdExceeded:7
PortFa1_8Threshold	BOOL	Decimal	ThresholdExceeded:8
PortFa1_9Threshold	BOOL	Decimal	ThresholdExceeded:9
PortFa1_10Threshold	BOOL	Decimal	ThresholdExceeded:10
PortFa1_11Threshold	BOOL	Decimal	ThresholdExceeded:11
PortFa1_12Threshold	BOOL	Decimal	ThresholdExceeded:12
PortFa1_13Threshold	BOOL	Decimal	ThresholdExceeded:13
PortFa1_14Threshold	BOOL	Decimal	ThresholdExceeded:14
PortFa1_15Threshold	BOOL	Decimal	ThresholdExceeded:15
PortFa1_16Threshold	BOOL	Decimal	ThresholdExceeded:16
PortFa1_17Threshold	BOOL	Decimal	ThresholdExceeded:17
PortFa1_18Threshold	BOOL	Decimal	ThresholdExceeded:18
PortGi1_1Threshold	BOOL	Decimal	ThresholdExceeded:19
PortGi1_2Threshold	BOOL	Decimal	ThresholdExceeded:20
AllPortsUtilization	SINT	Decimal	
PortFa1_1Utilization	SINT	Decimal	
PortFa1_2Utilization	SINT	Decimal	
PortFa1_3Utilization	SINT	Decimal	
PortFa1_4Utilization	SINT	Decimal	
PortFa1_5Utilization	SINT	Decimal	
PortFa1_6Utilization	SINT	Decimal	
PortFa1_7Utilization	SINT	Decimal	

**Table 165 - Input Data Type (20-port Gb switches) (Continued)**

<b>AB:STRATIX_5700_20PORT_GB_MANAGED:I:0</b>			
<b>Member Name</b>	<b>Type</b>	<b>Default Display Style</b>	<b>Valid Values</b>
PortFa1_8Utilization	SINT	Decimal	
PortFa1_9Utilization	SINT	Decimal	
PortFa1_10Utilization	SINT	Decimal	
PortFa1_11Utilization	SINT	Decimal	
PortFa1_12Utilization	SINT	Decimal	
PortFa1_13Utilization	SINT	Decimal	
PortFa1_14Utilization	SINT	Decimal	
PortFa1_15Utilization	SINT	Decimal	
PortFa1_16Utilization	SINT	Decimal	
PortFa1_17Utilization	SINT	Decimal	
PortFa1_18Utilization	SINT	Decimal	
PortGi1_1Utilization	SINT	Decimal	
PortGi1_2Utilization	SINT	Decimal	
MajorAlarmRelay	BOOL	Decimal	AlarmRelay:0
MulticastGroupsActive	DINT	Binary	

**Table 166 - Output Data Type (20-port Gb switches)**

<b>AB:STRATIX_5700_20PORT_GB_MANAGED:O:0</b>			
<b>Member Name</b>	<b>Type</b>	<b>Default Display Style</b>	<b>Valid Values</b>
AllPortsDisabled	BOOL	Decimal	DisablePort:0
PortFa1_1Disable	BOOL	Decimal	DisablePort:1
PortFa1_2Disable	BOOL	Decimal	DisablePort:2
PortFa1_3Disable	BOOL	Decimal	DisablePort:3
PortFa1_4Disable	BOOL	Decimal	DisablePort:4
PortFa1_5Disable	BOOL	Decimal	DisablePort:5
PortFa1_6Disable	BOOL	Decimal	DisablePort:6
PortFa1_7Disable	BOOL	Decimal	DisablePort:7
PortFa1_8Disable	BOOL	Decimal	DisablePort:8
PortFa1_9Disable	BOOL	Decimal	DisablePort:9
PortFa1_10Disable	BOOL	Decimal	DisablePort:10
PortFa1_11Disable	BOOL	Decimal	DisablePort:11
PortFa1_12Disable	BOOL	Decimal	DisablePort:12
PortFa1_13Disable	BOOL	Decimal	DisablePort:13
PortFa1_14Disable	BOOL	Decimal	DisablePort:14
PortFa1_15Disable	BOOL	Decimal	DisablePort:15
PortFa1_16Disable	BOOL	Decimal	DisablePort:16
PortFa1_17Disable	BOOL	Decimal	DisablePort:17

**Table 166 - Output Data Type (20-port Gb switches) (Continued)**

AB:STRATIX_5700_20PORT_GB_MANAGED:0:0			
Member Name	Type	Default Display Style	Valid Values
PortFa1_18Disable	BOOL	Decimal	DisablePort:18
PortGi1_1Disable	BOOL	Decimal	DisablePort:19
PortGi1_2Disable	BOOL	Decimal	DisablePort:20

## 20-port Switches

Catalog numbers 1783-BMS20CL, 1783-BMS20CA

**Table 167 - Input Data Type (20-port switches)**

AB:STRATIX_5700_20PORT_MANAGED:I:0			
Member Name	Type	Default Display Style	Valid Values
Fault	DINT	Binary	
AnyPortConnected	BOOL	Decimal	LinkStatus:0
PortFa1_1Connected	BOOL	Decimal	LinkStatus:1
PortFa1_2Connected	BOOL	Decimal	LinkStatus:2
PortFa1_3Connected	BOOL	Decimal	LinkStatus:3
PortFa1_4Connected	BOOL	Decimal	LinkStatus:4
PortFa1_5Connected	BOOL	Decimal	LinkStatus:5
PortFa1_6Connected	BOOL	Decimal	LinkStatus:6
PortFa1_7Connected	BOOL	Decimal	LinkStatus:7
PortFa1_8Connected	BOOL	Decimal	LinkStatus:8
PortFa1_9Connected	BOOL	Decimal	LinkStatus:9
PortFa1_10Connected	BOOL	Decimal	LinkStatus:10
PortFa1_11Connected	BOOL	Decimal	LinkStatus:11
PortFa1_12Connected	BOOL	Decimal	LinkStatus:12
PortFa1_13Connected	BOOL	Decimal	LinkStatus:13
PortFa1_14Connected	BOOL	Decimal	LinkStatus:14
PortFa1_15Connected	BOOL	Decimal	LinkStatus:15
PortFa1_16Connected	BOOL	Decimal	LinkStatus:16
PortFa1_17Connected	BOOL	Decimal	LinkStatus:17
PortFa1_18Connected	BOOL	Decimal	LinkStatus:18
PortFa1_19Connected	BOOL	Decimal	LinkStatus:19
PortFa1_20Connected	BOOL	Decimal	LinkStatus:20
AnyPortUnauthorizedDevice	BOOL	Decimal	UnauthorizedDevice:0
PortFa1_1UnauthorizedDevice	BOOL	Decimal	UnauthorizedDevice:1
PortFa1_2UnauthorizedDevice	BOOL	Decimal	UnauthorizedDevice:2
PortFa1_3UnauthorizedDevice	BOOL	Decimal	UnauthorizedDevice:3



**Table 167 - Input Data Type (20-port switches) (Continued)**

<b>AB:STRATIX_5700_20PORT_MANAGED:I:0</b>			
<b>Member Name</b>	<b>Type</b>	<b>Default Display Style</b>	<b>Valid Values</b>
PortFa1_4UnauthorizedDevice	BOOL	Decimal	UnauthorizedDevice:4
PortFa1_5UnauthorizedDevice	BOOL	Decimal	UnauthorizedDevice:5
PortFa1_6UnauthorizedDevice	BOOL	Decimal	UnauthorizedDevice:6
PortFa1_7UnauthorizedDevice	BOOL	Decimal	UnauthorizedDevice:7
PortFa1_8UnauthorizedDevice	BOOL	Decimal	UnauthorizedDevice:8
PortFa1_9UnauthorizedDevice	BOOL	Decimal	UnauthorizedDevice:9
PortFa1_10UnauthorizedDevice	BOOL	Decimal	UnauthorizedDevice:10
PortFa1_11UnauthorizedDevice	BOOL	Decimal	UnauthorizedDevice:11
PortFa1_12UnauthorizedDevice	BOOL	Decimal	UnauthorizedDevice:12
PortFa1_13UnauthorizedDevice	BOOL	Decimal	UnauthorizedDevice:13
PortFa1_14UnauthorizedDevice	BOOL	Decimal	UnauthorizedDevice:14
PortFa1_15UnauthorizedDevice	BOOL	Decimal	UnauthorizedDevice:15
PortFa1_16UnauthorizedDevice	BOOL	Decimal	UnauthorizedDevice:16
PortFa1_17UnauthorizedDevice	BOOL	Decimal	UnauthorizedDevice:17
PortFa1_18UnauthorizedDevice	BOOL	Decimal	UnauthorizedDevice:18
PortFa1_19UnauthorizedDevice	BOOL	Decimal	UnauthorizedDevice:19
PortFa1_20UnauthorizedDevice	BOOL	Decimal	UnauthorizedDevice:20
AnyPortThreshold	BOOL	Decimal	ThresholdExceeded:0
PortFa1_1Threshold	BOOL	Decimal	ThresholdExceeded:1
PortFa1_2Threshold	BOOL	Decimal	ThresholdExceeded:2
PortFa1_3Threshold	BOOL	Decimal	ThresholdExceeded:3
PortFa1_4Threshold	BOOL	Decimal	ThresholdExceeded:4
PortFa1_5Threshold	BOOL	Decimal	ThresholdExceeded:5
PortFa1_6Threshold	BOOL	Decimal	ThresholdExceeded:6
PortFa1_7Threshold	BOOL	Decimal	ThresholdExceeded:7
PortFa1_8Threshold	BOOL	Decimal	ThresholdExceeded:8
PortFa1_9Threshold	BOOL	Decimal	ThresholdExceeded:9
PortFa1_10Threshold	BOOL	Decimal	ThresholdExceeded:10
PortFa1_11Threshold	BOOL	Decimal	ThresholdExceeded:11
PortFa1_12Threshold	BOOL	Decimal	ThresholdExceeded:12
PortFa1_13Threshold	BOOL	Decimal	ThresholdExceeded:13
PortFa1_14Threshold	BOOL	Decimal	ThresholdExceeded:14
PortFa1_15Threshold	BOOL	Decimal	ThresholdExceeded:15
PortFa1_16Threshold	BOOL	Decimal	ThresholdExceeded:16
PortFa1_17Threshold	BOOL	Decimal	ThresholdExceeded:17
PortFa1_18Threshold	BOOL	Decimal	ThresholdExceeded:18
PortFa1_19Threshold	BOOL	Decimal	ThresholdExceeded:19
PortFa1_20Threshold	BOOL	Decimal	ThresholdExceeded:20

**Table 167 - Input Data Type (20-port switches) (Continued)**

<b>AB:STRATIX_5700_20PORT_MANAGED:I:0</b>			
<b>Member Name</b>	<b>Type</b>	<b>Default Display Style</b>	<b>Valid Values</b>
AllPortsUtilization	SINT	Decimal	
PortFa1_1Utilization	SINT	Decimal	
PortFa1_2Utilization	SINT	Decimal	
PortFa1_3Utilization	SINT	Decimal	
PortFa1_4Utilization	SINT	Decimal	
PortFa1_5Utilization	SINT	Decimal	
PortFa1_6Utilization	SINT	Decimal	
PortFa1_7Utilization	SINT	Decimal	
PortFa1_8Utilization	SINT	Decimal	
PortFa1_9Utilization	SINT	Decimal	
PortFa1_10Utilization	SINT	Decimal	
PortFa1_11Utilization	SINT	Decimal	
PortFa1_12Utilization	SINT	Decimal	
PortFa1_13Utilization	SINT	Decimal	
PortFa1_14Utilization	SINT	Decimal	
PortFa1_15Utilization	SINT	Decimal	
PortFa1_16Utilization	SINT	Decimal	
PortFa1_17Utilization	SINT	Decimal	
PortFa1_18Utilization	SINT	Decimal	
PortFa1_19Utilization	SINT	Decimal	
PortFa1_20Utilization	SINT	Decimal	
MajorAlarmRelay	BOOL	Decimal	AlarmRelay:0
MulticastGroupsActive	DINT	Binary	

**Table 168 - Output Data Type (20-port switches)**

<b>AB:STRATIX_5700_20PORT_MANAGED:O:0</b>			
<b>Member Name</b>	<b>Type</b>	<b>Default Display Style</b>	<b>Valid Values</b>
AllPortsDisabled	BOOL	Decimal	DisablePort:0
PortFa1_1Disable	BOOL	Decimal	DisablePort:1
PortFa1_2Disable	BOOL	Decimal	DisablePort:2
PortFa1_3Disable	BOOL	Decimal	DisablePort:3
PortFa1_4Disable	BOOL	Decimal	DisablePort:4
PortFa1_5Disable	BOOL	Decimal	DisablePort:5
PortFa1_6Disable	BOOL	Decimal	DisablePort:6
PortFa1_7Disable	BOOL	Decimal	DisablePort:7
PortFa1_8Disable	BOOL	Decimal	DisablePort:8
PortFa1_9Disable	BOOL	Decimal	DisablePort:9

**Table 168 - Output Data Type (20-port switches) (Continued)**

<b>AB:STRATIX_5700_20PORT_MANAGED:0:0</b>			
<b>Member Name</b>	<b>Type</b>	<b>Default Display Style</b>	<b>Valid Values</b>
PortFa1_10Disable	BOOL	Decimal	DisablePort:10
PortFa1_11Disable	BOOL	Decimal	DisablePort:11
PortFa1_12Disable	BOOL	Decimal	DisablePort:12
PortFa1_13Disable	BOOL	Decimal	DisablePort:13
PortFa1_14Disable	BOOL	Decimal	DisablePort:14
PortFa1_15Disable	BOOL	Decimal	DisablePort:15
PortFa1_16Disable	BOOL	Decimal	DisablePort:16
PortFa1_17Disable	BOOL	Decimal	DisablePort:17
PortFa1_18Disable	BOOL	Decimal	DisablePort:18
PortFa1_19Disable	BOOL	Decimal	DisablePort:19
PortFa1_20Disable	BOOL	Decimal	DisablePort:20

## 24-port Switches

Catalog number 1783-ZMS24TA

**Table 169 - Input Data Type (24-port switches)**

<b>AB:STRATIX_5700_24PORT_MANAGED:I:0</b>			
<b>Member Name</b>	<b>Type</b>	<b>Default Display Style</b>	<b>Valid Values</b>
Fault	DINT	Binary	
AnyPortConnected	BOOL	Decimal	LinkStatus:0
PortFa1_1Connected	BOOL	Decimal	LinkStatus:1
PortFa1_2Connected	BOOL	Decimal	LinkStatus:2
PortFa1_3Connected	BOOL	Decimal	LinkStatus:3
PortFa1_4Connected	BOOL	Decimal	LinkStatus:4
PortFa1_5Connected	BOOL	Decimal	LinkStatus:5
PortFa1_6Connected	BOOL	Decimal	LinkStatus:6
PortFa1_7Connected	BOOL	Decimal	LinkStatus:7
PortFa1_8Connected	BOOL	Decimal	LinkStatus:8
PortFa1_9Connected	BOOL	Decimal	LinkStatus:9
PortFa1_10Connected	BOOL	Decimal	LinkStatus:10
PortFa1_11Connected	BOOL	Decimal	LinkStatus:11
PortFa1_12Connected	BOOL	Decimal	LinkStatus:12
PortFa1_13Connected	BOOL	Decimal	LinkStatus:13
PortFa1_14Connected	BOOL	Decimal	LinkStatus:14
PortFa1_15Connected	BOOL	Decimal	LinkStatus:15
PortFa1_16Connected	BOOL	Decimal	LinkStatus:16

**Table 169 - Input Data Type (24-port switches) (Continued)**

<b>AB:STRATIX_5700_24PORT_MANAGED:I:0</b>			
<b>Member Name</b>	<b>Type</b>	<b>Default Display Style</b>	<b>Valid Values</b>
PortFa1_17Connected	BOOL	Decimal	LinkStatus:17
PortFa1_18Connected	BOOL	Decimal	LinkStatus:18
PortFa1_19Connected	BOOL	Decimal	LinkStatus:19
PortFa1_20Connected	BOOL	Decimal	LinkStatus:20
PortFa1_21Connected	BOOL	Decimal	LinkStatus:21
PortFa1_22Connected	BOOL	Decimal	LinkStatus:22
PortFa1_23Connected	BOOL	Decimal	LinkStatus:23
PortFa1_24Connected	BOOL	Decimal	LinkStatus:24
AnyPortUnauthorizedDevice	BOOL	Decimal	UnauthorizedDevice:0
PortFa1_1UnauthorizedDevice	BOOL	Decimal	UnauthorizedDevice:1
PortFa1_2UnauthorizedDevice	BOOL	Decimal	UnauthorizedDevice:2
PortFa1_3UnauthorizedDevice	BOOL	Decimal	UnauthorizedDevice:3
PortFa1_4UnauthorizedDevice	BOOL	Decimal	UnauthorizedDevice:4
PortFa1_5UnauthorizedDevice	BOOL	Decimal	UnauthorizedDevice:5
PortFa1_6UnauthorizedDevice	BOOL	Decimal	UnauthorizedDevice:6
PortFa1_7UnauthorizedDevice	BOOL	Decimal	UnauthorizedDevice:7
PortFa1_8UnauthorizedDevice	BOOL	Decimal	UnauthorizedDevice:8
PortFa1_9UnauthorizedDevice	BOOL	Decimal	UnauthorizedDevice:9
PortFa1_10UnauthorizedDevice	BOOL	Decimal	UnauthorizedDevice:10
PortFa1_11UnauthorizedDevice	BOOL	Decimal	UnauthorizedDevice:11
PortFa1_12UnauthorizedDevice	BOOL	Decimal	UnauthorizedDevice:12
PortFa1_13UnauthorizedDevice	BOOL	Decimal	UnauthorizedDevice:13
PortFa1_14UnauthorizedDevice	BOOL	Decimal	UnauthorizedDevice:14
PortFa1_15UnauthorizedDevice	BOOL	Decimal	UnauthorizedDevice:15
PortFa1_16UnauthorizedDevice	BOOL	Decimal	UnauthorizedDevice:16
PortFa1_17UnauthorizedDevice	BOOL	Decimal	UnauthorizedDevice:17
PortFa1_18UnauthorizedDevice	BOOL	Decimal	UnauthorizedDevice:18
PortFa1_19UnauthorizedDevice	BOOL	Decimal	UnauthorizedDevice:19
PortFa1_20UnauthorizedDevice	BOOL	Decimal	UnauthorizedDevice:20
PortFa1_21UnauthorizedDevice	BOOL	Decimal	UnauthorizedDevice:21
PortFa1_22UnauthorizedDevice	BOOL	Decimal	UnauthorizedDevice:22
PortFa1_23UnauthorizedDevice	BOOL	Decimal	UnauthorizedDevice:23
PortFa1_24UnauthorizedDevice	BOOL	Decimal	UnauthorizedDevice:24
AnyPortThreshold	BOOL	Decimal	ThresholdExceeded:0
PortFa1_1Threshold	BOOL	Decimal	ThresholdExceeded:1
PortFa1_2Threshold	BOOL	Decimal	ThresholdExceeded:2
PortFa1_3Threshold	BOOL	Decimal	ThresholdExceeded:3
PortFa1_4Threshold	BOOL	Decimal	ThresholdExceeded:4

**Table 169 - Input Data Type (24-port switches) (Continued)**

<b>AB:STRATIX_5700_24PORT_MANAGED:I:0</b>			
<b>Member Name</b>	<b>Type</b>	<b>Default Display Style</b>	<b>Valid Values</b>
PortFa1_5Threshold	BOOL	Decimal	ThresholdExceeded:5
PortFa1_6Threshold	BOOL	Decimal	ThresholdExceeded:6
PortFa1_7Threshold	BOOL	Decimal	ThresholdExceeded:7
PortFa1_8Threshold	BOOL	Decimal	ThresholdExceeded:8
PortFa1_9Threshold	BOOL	Decimal	ThresholdExceeded:9
PortFa1_10Threshold	BOOL	Decimal	ThresholdExceeded:10
PortFa1_11Threshold	BOOL	Decimal	ThresholdExceeded:11
PortFa1_12Threshold	BOOL	Decimal	ThresholdExceeded:12
PortFa1_13Threshold	BOOL	Decimal	ThresholdExceeded:13
PortFa1_14Threshold	BOOL	Decimal	ThresholdExceeded:14
PortFa1_15Threshold	BOOL	Decimal	ThresholdExceeded:15
PortFa1_16Threshold	BOOL	Decimal	ThresholdExceeded:16
PortFa1_17Threshold	BOOL	Decimal	ThresholdExceeded:17
PortFa1_18Threshold	BOOL	Decimal	ThresholdExceeded:18
PortFa1_19Threshold	BOOL	Decimal	ThresholdExceeded:19
PortFa1_20Threshold	BOOL	Decimal	ThresholdExceeded:20
PortFa1_21Threshold	BOOL	Decimal	ThresholdExceeded:21
PortFa1_22Threshold	BOOL	Decimal	ThresholdExceeded:22
PortFa1_23Threshold	BOOL	Decimal	ThresholdExceeded:23
PortFa1_24Threshold	BOOL	Decimal	ThresholdExceeded:24
AllPortsUtilization	SINT	Decimal	
PortFa1_1Utilization	SINT	Decimal	
PortFa1_2Utilization	SINT	Decimal	
PortFa1_3Utilization	SINT	Decimal	
PortFa1_4Utilization	SINT	Decimal	
PortFa1_5Utilization	SINT	Decimal	
PortFa1_6Utilization	SINT	Decimal	
PortFa1_7Utilization	SINT	Decimal	
PortFa1_8Utilization	SINT	Decimal	
PortFa1_9Utilization	SINT	Decimal	
PortFa1_10Utilization	SINT	Decimal	
PortFa1_11Utilization	SINT	Decimal	
PortFa1_12Utilization	SINT	Decimal	
PortFa1_13Utilization	SINT	Decimal	
PortFa1_14Utilization	SINT	Decimal	
PortFa1_15Utilization	SINT	Decimal	
PortFa1_16Utilization	SINT	Decimal	
PortFa1_17Utilization	SINT	Decimal	

**Table 169 - Input Data Type (24-port switches) (Continued)**

<b>AB:STRATIX_5700_24PORT_MANAGED:I:0</b>			
<b>Member Name</b>	<b>Type</b>	<b>Default Display Style</b>	<b>Valid Values</b>
PortFa1_18Utilization	SINT	Decimal	
PortFa1_19Utilization	SINT	Decimal	
PortFa1_20Utilization	SINT	Decimal	
PortFa1_21Utilization	SINT	Decimal	
PortFa1_22Utilization	SINT	Decimal	
PortFa1_23Utilization	SINT	Decimal	
PortFa1_24Utilization	SINT	Decimal	
MajorAlarmRelay	BOOL	Decimal	AlarmRelay:0
MulticastGroupsActive	DINT	Binary	

**Table 170 - Output Data Type (24-port switches)**

<b>AB:STRATIX_5700_24PORT_MANAGED:O:0</b>			
<b>Member Name</b>	<b>Type</b>	<b>Default Display Style</b>	<b>Valid Values</b>
AllPortsDisabled	BOOL	Decimal	DisablePort:0
PortFa1_1Disable	BOOL	Decimal	DisablePort:1
PortFa1_2Disable	BOOL	Decimal	DisablePort:2
PortFa1_3Disable	BOOL	Decimal	DisablePort:3
PortFa1_4Disable	BOOL	Decimal	DisablePort:4
PortFa1_5Disable	BOOL	Decimal	DisablePort:5
PortFa1_6Disable	BOOL	Decimal	DisablePort:6
PortFa1_7Disable	BOOL	Decimal	DisablePort:7
PortFa1_8Disable	BOOL	Decimal	DisablePort:8
PortFa1_9Disable	BOOL	Decimal	DisablePort:9
PortFa1_10Disable	BOOL	Decimal	DisablePort:10
PortFa1_11Disable	BOOL	Decimal	DisablePort:11
PortFa1_12Disable	BOOL	Decimal	DisablePort:12
PortFa1_13Disable	BOOL	Decimal	DisablePort:13
PortFa1_14Disable	BOOL	Decimal	DisablePort:14
PortFa1_15Disable	BOOL	Decimal	DisablePort:15
PortFa1_16Disable	BOOL	Decimal	DisablePort:16
PortFa1_17Disable	BOOL	Decimal	DisablePort:17
PortFa1_18Disable	BOOL	Decimal	DisablePort:18
PortFa1_19Disable	BOOL	Decimal	DisablePort:19
PortFa1_20Disable	BOOL	Decimal	DisablePort:20
PortFa1_21Disable	BOOL	Decimal	DisablePort:21

**Table 170 - Output Data Type (24-port switches) (Continued)**

AB:STRATIX_5700_24PORT_MANAGED:0:0			
Member Name	Type	Default Display Style	Valid Values
PortFa1_22Disable	BOOL	Decimal	DisablePort:22
PortFa1_23Disable	BOOL	Decimal	DisablePort:23
PortFa1_24Disable	BOOL	Decimal	DisablePort:24

## Stratix 8000 and 8300 Data Types

The following tables show input and output data types for all 26 ports of the switch, as well as port assignments for data types.

**Table 171 - Input Data Types**

Tag Name	Type	Description
Fault	DINT	If there is a communication fault between the controller and the switch, all 32 bits in the module fault word are set to 1.
AnyPortConnected	BOOL	Indicates that at least one port has an active link.
PortGi1_1Connected	BOOL	Indicates that a particular port has an active link. 0 = Link not active 1 = Link active
PortGi1_2Connected	BOOL	
PortFa1_1Connected	BOOL	
PortFa1_2Connected	BOOL	
PortFa1_3Connected	BOOL	
PortFa1_4Connected	BOOL	
PortFa1_5Connected	BOOL	
PortFa1_6Connected	BOOL	
PortFa1_7Connected	BOOL	
PortFa1_8Connected	BOOL	
PortFa2_1Connected	BOOL	
PortFa2_2Connected	BOOL	
PortFa2_3Connected	BOOL	
PortFa2_4Connected	BOOL	
PortFa2_5Connected	BOOL	
PortFa2_6Connected	BOOL	
PortFa2_7Connected	BOOL	
PortFa2_8Connected	BOOL	
PortFa3_1Connected	BOOL	
PortFa3_2Connected	BOOL	
PortFa3_3Connected	BOOL	
PortFa3_4Connected	BOOL	
PortFa3_5Connected	BOOL	
PortFa3_6Connected	BOOL	
PortFa3_7Connected	BOOL	
PortFa3_8Connected	BOOL	

**Table 171 - Input Data Types (Continued)**

Tag Name	Type	Description
AnyPortUnauthorizedDevice	BOOL	Indicates that an unauthorized MAC ID has attempted to communicate on any port.
PortGi1_1UnauthorizedDevice	BOOL	Indicates that an unauthorized MAC ID has attempted to communicate on a particular port. 0 = No mismatch 1 = Mismatch
PortGi1_2UnauthorizedDevice	BOOL	
PortFa1_1UnauthorizedDevice	BOOL	
PortFa1_2UnauthorizedDevice	BOOL	
PortFa1_3UnauthorizedDevice	BOOL	
PortFa1_4UnauthorizedDevice	BOOL	
PortFa1_5UnauthorizedDevice	BOOL	
PortFa1_6UnauthorizedDevice	BOOL	
PortFa1_7UnauthorizedDevice	BOOL	
PortFa1_8UnauthorizedDevice	BOOL	
PortFa2_1UnauthorizedDevice	BOOL	
PortFa2_2UnauthorizedDevice	BOOL	
PortFa2_3UnauthorizedDevice	BOOL	
PortFa2_4UnauthorizedDevice	BOOL	
PortFa2_5UnauthorizedDevice	BOOL	
PortFa2_6UnauthorizedDevice	BOOL	
PortFa2_7UnauthorizedDevice	BOOL	
PortFa2_8UnauthorizedDevice	BOOL	
PortFa3_1UnauthorizedDevice	BOOL	
PortFa3_2UnauthorizedDevice	BOOL	
PortFa3_3UnauthorizedDevice	BOOL	
PortFa3_4UnauthorizedDevice	BOOL	
PortFa3_5UnauthorizedDevice	BOOL	
PortFa3_6UnauthorizedDevice	BOOL	
PortFa3_7UnauthorizedDevice	BOOL	
PortFa3_8UnauthorizedDevice	BOOL	
AnyPortThreshold	BOOL	Indicates that unicast, multicast, or broadcast threshold limit has been exceeded on any port.



**Table 171 - Input Data Types (Continued)**

Tag Name	Type	Description	
PortGi1_1Threshold	BOOL	Indicates that unicast, multicast, or broadcast threshold limit has been exceeded on a particular port. 0 = OK 1 = Threshold exceeded	
PortGi1_2Threshold	BOOL		
PortFa1_1Threshold	BOOL		
PortFa1_2Threshold	BOOL		
PortFa1_3Threshold	BOOL		
PortFa1_4Threshold	BOOL		
PortFa1_5Threshold	BOOL		
PortFa1_6Threshold	BOOL		
PortFa1_7Threshold	BOOL		
PortFa1_8Threshold	BOOL		
PortFa2_1Threshold	BOOL		
PortFa2_2Threshold	BOOL		
PortFa2_3Threshold	BOOL		
PortFa2_4Threshold	BOOL		
PortFa2_5Threshold	BOOL		
PortFa2_6Threshold	BOOL		
PortFa2_7Threshold	BOOL		
PortFa2_8Threshold	BOOL		
PortFa3_1Threshold	BOOL		
PortFa3_2Threshold	BOOL		
PortFa3_3Threshold	BOOL		
PortFa3_4Threshold	BOOL		
PortFa3_5Threshold	BOOL		
PortFa3_6Threshold	BOOL		
PortFa3_7Threshold	BOOL		
PortFa3_8Threshold	BOOL		
AllPortsUtilization	SINT		The sum of the percentage of the bandwidth utilized of all ports on the switch.

**Table 171 - Input Data Types (Continued)**

Tag Name	Type	Description	
PortGi1_1Utilization;	SINT	The percentage of the bandwidth utilized on a particular port.	
PortGi1_2Utilization;	SINT		
PortFa1_1Utilization;	SINT		
PortFa1_2Utilization;	SINT		
PortFa1_3Utilization;	SINT		
PortFa1_4Utilization;	SINT		
PortFa1_5Utilization;	SINT		
PortFa1_6Utilization;	SINT		
PortFa1_7Utilization;	SINT		
PortFa1_8Utilization;	SINT		
PortFa2_1Utilization;	SINT		
PortFa2_2Utilization;	SINT		
PortFa2_3Utilization;	SINT		
PortFa2_4Utilization;	SINT		
PortFa2_5Utilization;	SINT		
PortFa2_6Utilization;	SINT		
PortFa2_7Utilization;	SINT		
PortFa2_8Utilization;	SINT		
PortFa3_1Utilization;	SINT		
PortFa3_2Utilization;	SINT		
PortFa3_3Utilization;	SINT		
PortFa3_4Utilization;	SINT		
PortFa3_5Utilization;	SINT		
PortFa3_6Utilization;	SINT		
PortFa3_7Utilization;	SINT		
PortFa3_8Utilization;	SINT		
MajorAlarmRelay	BOOL		Indicates whether the major alarm relay is on or off. 0 = Contact open (off) 1 = Contact closed (on)
MinorAlarmRelay	BOOL		Indicates whether the minor alarm relay is on or off. 0 = Contact open (off) 1 = Contact closed (on)
MulticastGroupsActive	DINT		The number of active multicast groups across all ports.

**Table 172 - Output Data Types**

Tag Name	Type	Description
AllPortsDisable	BOOL	Setting this bit disables all ports on the switch. 0 = Enable 1 = Disable
PortGi1_1Disable	BOOL	Setting a particular bit disables that particular port. 0 = Enable 1 = Disable
PortGi1_2Disable	BOOL	
PortFa1_1Disable	BOOL	
PortFa1_2Disable	BOOL	
PortFa1_3Disable	BOOL	
PortFa1_4Disable	BOOL	
PortFa1_5Disable	BOOL	
PortFa1_6Disable	BOOL	
PortFa1_7Disable	BOOL	
PortFa1_8Disable	BOOL	
PortFa2_1Disable	BOOL	
PortFa2_2Disable	BOOL	
PortFa2_3Disable	BOOL	
PortFa2_4Disable	BOOL	
PortFa2_5Disable	BOOL	
PortFa2_6Disable	BOOL	
PortFa2_7Disable	BOOL	
PortFa2_8Disable	BOOL	
PortFa3_1Disable	BOOL	
PortFa3_2Disable	BOOL	
PortFa3_3Disable	BOOL	
PortFa3_4Disable	BOOL	
PortFa3_5Disable	BOOL	
PortFa3_6Disable	BOOL	
PortFa3_7Disable	BOOL	
PortFa3_8Disable	BOOL	

**Notes:**

---

## Port Assignments for CIP Data

<b>Topic</b>	<b>Page</b>
Stratix 5400 Port Assignments	406
Stratix 5410 Port Assignments	408
Stratix 5700 Port Assignments	409
ArmorStratix 5700 Port Assignments	410
Stratix 8000 and 8300 Port Assignments	411

The following tables identify the instance numbers of the Ethernet link objects that are associated with each port on Stratix® and ArmorStratix™ switches. Instance 0 does not apply to all ports as it does for bit maps.

The bit numbers identify each port when they are contained in a structure of all ports, such as in the output assembly. Bit 0 refers to any or all ports.

## Stratix 5400 Port Assignments

Table 173 - 8- and 12-port Switches

Bit	1783-HMS4C4CGN	1783-HMS8T4CGN	1783-HMS8S4CGN	1783-HMS4T4E4CGN	1783-HMS8TG4CGN 1783-HMS8TG4CGR	1783-HMS8SG4CGN 1783-HMS8SG4CGR	1783-HMS4EG8CGN 1783-HMS4EG8CGR
0	Any/All ports	Any/All ports	Any/All ports	Any/All ports	Any/All ports	Any/All ports	Any/All ports
1	Gi1/1	Gi1/1	Gi1/1	Gi1/1	Gi1/1	Gi1/1	Gi1/1
2	Gi1/2	Gi1/2	Gi1/2	Gi1/2	Gi1/2	Gi1/2	Gi1/2
3	Gi1/3	Gi1/3	Gi1/3	Gi1/3	Gi1/3	Gi1/3	Gi1/3
4	Gi1/4	Gi1/4	Gi1/4	Gi1/4	Gi1/4	Gi1/4	Gi1/4
5	Fa1/5	Fa1/5	Fa1/5	Fa1/5	Gi1/5	Gi1/5	Gi1/5
6	Fa1/6	Fa1/6	Fa1/6	Fa1/6	Gi1/6	Gi1/6	Gi1/6
7	Fa1/7	Fa1/7	Fa1/7	Fa1/7	Gi1/7	Gi1/7	Gi1/7
8	Fa1/8	Fa1/8	Fa1/8	Fa1/8	Gi1/8	Gi1/8	Gi1/8
9		Fa1/9	Fa1/9	Fa1/9	Gi1/9	Gi1/9	Gi1/9
10		Fa1/10	Fa1/10	Fa1/10	Gi1/10	Gi1/10	Gi1/10
11		Fa1/11	Fa1/11	Fa1/11	Gi1/11	Gi1/11	Gi1/11
12		Fa1/12	Fa1/12	Fa1/12	Gi1/12	Gi1/12	Gi1/12
27	SVI1	SVI1	SVI1	SVI1	SVI1	SVI1	SVI1

**Table 174 - 16- and 20-port Switches**

Bit	1783-HMS4S8E4CGN	1783-HMS4SG8EG4CGN 1783-HMS4SG8EG4CGR	1783-HMS16T4CGN	1783-HMS16TG4CGN 1783-HMS16TG4CGR	1783-HMS8TG8EG4CGN 1783-HMS8TG8EG4CGR
0	Any/All ports	Any/All ports	Any/All ports	Any/All ports	Any/All ports
1	Gi1/1	Gi1/1	Gi1/1	Gi1/1	Gi1/1
2	Gi1/2	Gi1/2	Gi1/2	Gi1/2	Gi1/2
3	Gi1/3	Gi1/3	Gi1/3	Gi1/3	Gi1/3
4	Gi1/4	Gi1/4	Gi1/4	Gi1/4	Gi1/4
5	Fa1/5	Gi1/5	Fa1/5	Gi1/5	Gi1/5
6	Fa1/6	Gi1/6	Fa1/6	Gi1/6	Gi1/6
7	Fa1/7	Gi1/7	Fa1/7	Gi1/7	Gi1/7
8	Fa1/8	Gi1/8	Fa1/8	Gi1/8	Gi1/8
9	Fa1/9	Gi1/9	Fa1/9	Gi1/9	Gi1/9
10	Fa1/10	Gi1/10	Fa1/10	Gi1/10	Gi1/10
11	Fa1/11	Gi1/11	Fa1/11	Gi1/11	Gi1/11
12	Fa1/12	Gi1/12	Fa1/12	Gi1/12	Gi1/12
13	Fa1/13	Gi1/13	Fa1/13	Gi1/13	Gi1/13
14	Fa1/14	Gi1/14	Fa1/14	Gi1/14	Gi1/14
15	Fa1/15	Gi1/15	Fa1/15	Gi1/15	Gi1/15
16	Fa1/16	Gi1/16	Fa1/16	Gi1/16	Gi1/16
17			Fa1/17	Gi1/17	Gi1/17
18			Fa1/18	Gi1/18	Gi1/18
19			Fa1/19	Gi1/19	Gi1/19
20			Fa1/20	Gi1/20	Gi1/20
27	SVI1	SVI1	SVI1	SVI1	SVI1

## Stratix 5410 Port Assignments

Bit	1783-IMS28NDC, 1783-IMS28NAC, 1783-IMS28GNDC, 1783-IMS28GNAC, 1783-IMS28RDC, 1783-IMS28RAC, 1783-IMS28GRDC, 1783-IMS28GRAC
0	Any/All ports
1	Gi1/1
2	Gi1/2
3	Gi1/3
4	Gi1/4
5	Gi1/5
6	Gi1/6
7	Gi1/7
8	Gi1/8
9	Gi1/9
10	Gi1/10
11	Gi1/11
12	Gi1/12
13	Gi1/13
14	Gi1/14
15	Gi1/15
16	Gi1/16
17	Gi1/17
18	Gi1/18
19	Gi1/19
20	Gi1/20
21	Gi1/21
22	Gi1/22
23	Gi1/23
24	Gi1/24
25	Te1/25 or Gi1/25
26	Te1/26 or Gi1/26
27	Te1/27 or Gi1/27
28	Te1/28 or Gi1/28



## Stratix 5700 Port Assignments

**Table 175 - 6- and 10-port Switches**

Bit	1783-BMS4S2SGL, 1783-BMS4S2SGA, 1783-BMS06SL, 1783-BMS06SA, 1783-BMS06TL, 1783-BMS06TA, 1783-BMS06SGL, 1783-BMS06SGA	1783-BMS06TGL, 1783-BMS06TGA	1783-BMS10CL, 1783-BMS10CA	1783-BMS10CGL, 1783-BMS10CGA, 1783-BMS10CGP, 1783-BMS10CGN
0	Any/All ports	Any/All ports	Any/All ports	Any/All ports
1	Fa1/1	Fa/1	Fa1/1	Fa1/1
2	Fa1/2	Fa1/2	Fa1/2	Fa1/2
3	Fa1/3	Fa1/3	Fa1/3	Fa1/3
4	Fa1/4	Fa1/4	Fa1/4	Fa1/4
5	Fa1/5	Gi1/1	Fa1/5	Fa1/5
6	Fa1/6	Gi1/2	Fa1/6	Fa1/6
7			Fa1/7	Fa1/7
8			Fa1/8	Fa1/8
9			Fa1/9	Gi1/1
10			Fa1/10	Gi1/2
27	SVI1	SVI1	SVI1	SVI1

**Table 176 - 18- and 20-port Switches**

Bit	1783-BMS12T4E2CGL, 1783-BMS12T4E2CGP, 1783-BMS12T4E2CGNK	1783-BMS20CL, 1783-BMS20CA	1783-BMS20CGL, 1783-BMS20CGN, 1783-BMS20CGP, 1783-BMS20CGPK
0	Any/All ports	Any/All ports	Any/All ports
1	Fa1/1	Fa1/1	Fa1/1
2	Fa1/2	Fa1/2	Fa1/2
3	Fa1/3	Fa1/3	Fa1/3
4	Fa1/4	Fa1/4	Fa1/4
5	Fa1/5	Fa1/5	Fa1/5
6	Fa1/6	Fa1/6	Fa1/6
7	Fa1/7	Fa1/7	Fa1/7
8	Fa1/8	Fa1/8	Fa1/8
9	Fa1/9	Fa1/9	Fa1/9
10	Fa1/10	Fa1/10	Fa1/10
11	Fa1/11	Fa1/11	Fa1/11
12	Fa1/12	Fa1/12	Fa1/12
13	Fa1/13	Fa1/13	Fa1/13
14	Fa1/14	Fa1/14	Fa1/14
15	Fa1/15	Fa1/15	Fa1/15
16	Gi1/1	Fa1/16	Fa1/16
17	Gi1/2	Fa1/17	Fa1/17
18	Gi1/3	Fa1/18	Fa1/18

**Table 176 - 18- and 20-port Switches (Continued)**

Bit	1783-BMS12T4E2CGL, 1783-BMS12T4E2CGP, 1783-BMS12T4E2CGNK	1783-BMS20CL, 1783-BMS20CA	1783-BMS20CGL, 1783-BMS20CGN, 1783-BMS20CGP, 1783-BMS20CGPK
19		Fa1/19	Gi1/1
20		Fa1/20	Gi1/2
27	SVI1	SVI1	SVI1

## ArmorStratix 5700 Port Assignments

Bit	1783-ZMS8TA	1783-ZMS4T4E2TGP, 1783-ZMS4T4E2TGN	1783-ZMS16TA	1783-ZMS8T8E2TGP, 1783-ZMS8T8E2TGN	1783-ZMS24TA
0	Any/All ports	Any/All ports	Any/All ports	Any/All ports	Any/All ports
1	Fa1/1	Fa/1	Fa1/1	Fa1/1	Fa1/1
2	Fa1/2	Fa1/2	Fa1/2	Fa1/2	Fa1/2
3	Fa1/3	Fa1/3	Fa1/3	Fa1/3	Fa1/3
4	Fa1/4	Fa1/4	Fa1/4	Fa1/4	Fa1/4
5	Fa1/5	Fa1/5	Fa1/5	Fa1/5	Fa1/5
6	Fa1/6	Fa1/6	Fa1/6	Fa1/6	Fa1/6
7	Fa1/7	Fa1/7	Fa1/7	Fa1/7	Fa1/7
8	Fa1/8	Fa1/8	Fa1/8	Fa1/8	Fa1/8
9		Gi1/1	Fa1/9	Fa1/9	Fa1/9
10		Gi1/2	Fa1/10	Fa1/10	Fa1/10
11			Fa1/11	Fa1/11	Fa1/11
12			Fa1/12	Fa1/12	Fa1/12
13			Fa1/13	Fa1/13	Fa1/13
14			Fa1/14	Fa1/14	Fa1/14
15			Fa1/15	Fa1/15	Fa1/15
16			Fa1/16	Fa1/16	Fa1/16
17				Gi1/1	Fa1/17
18				Gi1/2	Fa1/18
19					Fa1/19
20					Fa1/20
21					Fa1/21
22					Fa1/22
23					Fa1/23
24					Fa1/24
27	SVI1	SVI1	SVI1	SVI1	SVI1

## Stratix 8000 and 8300 Port Assignments

Bit	6-port Managed Ethernet Switch	10-port Managed Ethernet Switch	10-port Managed Ethernet Switch	14-port Managed Ethernet Switch	14-port Managed Ethernet Switch	14-port Managed Ethernet Switch	18-port Managed Ethernet Switch
0	Any/All ports	Any/All ports	Any/All ports	Any/All ports	Any/All ports	Any/All ports	Any/All ports
1	Gi1/1	Gi1/1	Gi1/1	Gi1/1	Gi1/1	Gi1/1	Gi1/1
2	Gi1/2	Gi1/2	Gi1/2	Gi1/2	Gi1/2	Gi1/2	Gi1/2
3	Fa1/1	Fa1/1	Fa1/1	Fa1/1	Fa1/1	Fa1/1	Fa1/1
4	Fa1/2	Fa1/2	Fa1/2	Fa1/2	Fa1/2	Fa1/2	Fa1/2
5	Fa1/3	Fa1/3	Fa1/3	Fa1/3	Fa1/3	Fa1/3	Fa1/3
6	Fa1/4	Fa1/4	Fa1/4	Fa1/4	Fa1/4	Fa1/4	Fa1/4
7		Fa1/5			Fa1/5		Fa1/5
8		Fa1/6			Fa1/6		Fa1/6
9		Fa1/7			Fa1/7		Fa1/7
10		Fa1/8			Fa1/8		Fa1/8
11			Fa2/1	Fa2/1	Fa2/1	Fa2/1	Fa2/1
12			Fa2/2	Fa2/2	Fa2/2	Fa2/2	Fa2/2
13			Fa2/3	Fa2/3	Fa2/3	Fa2/3	Fa2/3
14			Fa2/4	Fa2/4	Fa2/4	Fa2/4	Fa2/4
15				Fa2/5			Fa2/5
16				Fa2/6			Fa2/6
17				Fa2/7			Fa2/7
18				Fa2/8			Fa2/8
19						Fa3/1	
20						Fa3/2	
21						Fa3/3	
22						Fa3/4	
23							
24							
25							
26							

**Notes:**

## Port Numbering

<b>Topic</b>	<b>Page</b>
Stratix 5400 Port Numbering	414
Stratix 5410 Port Numbering	422
Stratix 5700 Port Numbering	423
ArmorStratix 5700 Port Numbering	430
Stratix 8000 and 8300 Port Numbering	433

## Stratix 5400 Port Numbering

The port ID consists of the following:

- Port type (Gigabit Ethernet for Gigabit ports and Fast Ethernet for 10/100 Mbps ports)
- Unit number (always 1)
- Port number (1...20, depending on the catalog number)

Gigabit Ethernet is abbreviated as Gi and Fast Ethernet as Fa.

**Table 177 - Stratix 5400 Port Numbering**

Cat. No.	Description	Port Numbering on Switch Labels	Port Numbering in config.txt Text File
1783-HMS4C4CGN	8-port (4 combo Gigabit ports; 4 combo Ethernet ports) managed switch; Layer 2 firmware	1	Gi1/1
		2	Gi1/2
		3	Gi1/3
		4	Gi1/4
		5	Fa1/5
		6	Fa1/6
		7	Fa1/7
		8	Fa1/8
1783-HMS8T4CGN	12-port (4 combo Gigabit ports; 8 Ethernet ports) managed switch; Layer 2 firmware	1	Gi1/1
		2	Gi1/2
		3	Gi1/3
		4	Gi1/4
		5	Fa1/5
		6	Fa1/6
		7	Fa1/7
		8	Fa1/8
		9	Fa1/9
		10	Fa1/10
		11	Fa1/11
		12	Fa1/12
1783-HMS8S4CGN	12-port (4 combo Gigabit ports; 8 SFP ports) managed switch; Layer 2 firmware	1	Gi1/1
		2	Gi1/2
		3	Gi1/3
		4	Gi1/4
		5	Fa1/5
		6	Fa1/6
		7	Fa1/7
		8	Fa1/8
		9	Fa1/9
		10	Fa1/10
		11	Fa1/11
		12	Fa1/12

**Table 177 - Stratix 5400 Port Numbering (Continued)**

Cat. No.	Description	Port Numbering on Switch Labels	Port Numbering in config.txt Text File
1783-HMS4T4E4CGN	12-port (4 combo Gigabit ports; 4 Ethernet ports; 4 PoE/PoE+ ports) managed switch; Layer 2 firmware	1 2 3 4 5 6 7 8 9 10 11 12	Gi1/1 Gi1/2 Gi1/3 Gi1/4 Fa1/5 Fa1/6 Fa1/7 Fa1/8 Fa1/9 Fa1/10 Fa1/11 Fa1/12
1783-HMS8TG4CGN	12-port (8 Gigabit ports; 4 Gigabit combo ports) managed switch; Layer 2 firmware	1 2 3 4 5 6 7 8 9 10 11 12	Gi1/1 Gi1/2 Gi1/3 Gi1/4 Gi1/5 Gi1/6 Gi1/7 Gi1/8 Gi1/9 Gi1/10 Gi1/11 Gi1/12
1783-HMS8SG4CGN	12-port (4 Gigabit combo ports; 8 Gigabit SFP ports) managed switch; Layer 2 firmware	1 2 3 4 5 6 7 8 9 10 11 12	Gi1/1 Gi1/2 Gi1/3 Gi1/4 Gi1/5 Gi1/6 Gi1/7 Gi1/8 Gi1/9 Gi1/10 Gi1/11 Gi1/12
1783-HMS4EG8CGN	12-port (4 Gigabit ports; 4 Gigabit combo ports; 4 Gigabit PoE/PoE+ ports) managed switch; Layer 2 firmware	1 2 3 4 5 6 7 8 9 10 11 12	Gi1/1 Gi1/2 Gi1/3 Gi1/4 Gi1/5 Gi1/6 Gi1/7 Gi1/8 Gi1/9 Gi1/10 Gi1/11 Gi1/12

**Table 177 - Stratix 5400 Port Numbering (Continued)**

Cat. No.	Description	Port Numbering on Switch Labels	Port Numbering in config.txt Text File
1783-HMS4S8E4CGN	16-port (4 combo Gigabit ports; 8 PoE/PoE+ ports; 4 SFP ports) managed switch; Layer 2 firmware	1 2 3 4 5 6 7 8 9 10 11 12 13 14 15 16	Gi1/1 Gi1/2 Gi1/3 Gi1/4 Fa1/5 Fa1/6 Fa1/7 Fa1/8 Fa1/9 Fa1/10 Fa1/11 Fa1/12 Fa1/13 Fa1/14 Fa1/15 Fa1/16
1783-HMS4SG8EG4CGN	16-port (4 Gigabit combo ports; 8 Gigabit PoE/PoE+ ports; 4 Gigabit SFP ports) managed switch; Layer 2 firmware	1 2 3 4 5 6 7 8 9 10 11 12 13 14 15 16	Gi1/1 Gi1/2 Gi1/3 Gi1/4 Gi1/5 Gi1/6 Gi1/7 Gi1/8 Gi1/9 Gi1/10 Gi1/11 Gi1/12 Gi1/13 Gi1/14 Gi1/15 Gi1/16



**Table 177 - Stratix 5400 Port Numbering (Continued)**

Cat. No.	Description	Port Numbering on Switch Labels	Port Numbering in config.txt Text File
1783-HMS16T4CGN	20-port (4 combo Gigabit ports; 16 Ethernet ports) managed switch; Layer 2 firmware	1 2 3 4 5 6 7 8 9 10 11 12 13 14 15 16 17 18 19 20	Gi1/1 Gi1/2 Gi1/3 Gi1/4 Fa1/5 Fa1/6 Fa1/7 Fa1/8 Fa1/9 Fa1/10 Fa1/11 Fa1/12 Fa1/13 Fa1/14 Fa1/15 Fa1/16 Fa1/17 Fa1/18 Fa1/19 Fa1/20
1783-HMS16TG4CGN	20-port (16 Gigabit ports; 4 Gigabit combo ports) managed switch; Layer 2 firmware	1 2 3 4 5 6 7 8 9 10 11 12 13 14 15 16 17 18 19 20	Gi1/1 Gi1/2 Gi1/3 Gi1/4 Gi1/5 Gi1/6 Gi1/7 Gi1/8 Gi1/9 Gi1/10 Gi1/11 Gi1/12 Gi1/13 Gi1/14 Gi1/15 Gi1/16 Gi1/17 Gi1/18 Gi1/19 Gi1/20

**Table 177 - Stratix 5400 Port Numbering (Continued)**

Cat. No.	Description	Port Numbering on Switch Labels	Port Numbering in config.txt Text File
1783-HMS8TG8EG4CGN	20-port (8 Gigabit ports; 4 Gigabit combo ports; 8 Gigabit PoE/PoE+ ports) managed switch; Layer 2 firmware	1 2 3 4 5 6 7 8 9 10 11 12 13 14 15 16 17 18 19 20	Gi1/1 Gi1/2 Gi1/3 Gi1/4 Gi1/5 Gi1/6 Gi1/7 Gi1/8 Gi1/9 Gi1/10 Gi1/11 Gi1/12 Gi1/13 Gi1/14 Gi1/15 Gi1/16 Gi1/17 Gi1/18 Gi1/19 Gi1/20
1783-HMS8TG4CGR	12-port (8 Ethernet ports; 4 Gigabit combo ports) managed switch; Layer 3 firmware	1 2 3 4 5 6 7 8 9 10 11 12	Gi1/1 Gi1/2 Gi1/3 Gi1/4 Gi1/5 Gi1/6 Gi1/7 Gi1/8 Gi1/9 Gi1/10 Gi1/11 Gi1/12
1783-HMS8SG4CGR	12-port (4 Gigabit combo ports; 8 Gigabit SFP ports) managed switch; Layer 3 firmware	1 2 3 4 5 6 7 8 9 10 11 12	Gi1/1 Gi1/2 Gi1/3 Gi1/4 Gi1/5 Gi1/6 Gi1/7 Gi1/8 Gi1/9 Gi1/10 Gi1/11 Gi1/12

**Table 177 - Stratix 5400 Port Numbering (Continued)**

Cat. No.	Description	Port Numbering on Switch Labels	Port Numbering in config.txt Text File
1783-HMS4EG8CGR	12-port (4 Gigabit ports; 4 Gigabit combo ports; 4 Gigabit PoE/PoE+ ports) managed switch; Layer 3 firmware	1 2 3 4 5 6 7 8 9 10 11 12	Gi1/1 Gi1/2 Gi1/3 Gi1/4 Gi1/5 Gi1/6 Gi1/7 Gi1/8 Gi1/9 Gi1/10 Gi1/11 Gi1/12

**Table 177 - Stratix 5400 Port Numbering (Continued)**

Cat. No.	Description	Port Numbering on Switch Labels	Port Numbering in config.txt Text File
1783-HMS4SG8EG4CGR	16-port (4 Gigabit combo ports; 8 Gigabit PoE/PoE+ ports; 4 Gigabit SFP ports) managed switch; Layer 3 firmware	1 2 3 4 5 6 7 8 9 10 11 12 13 14 15 16	Gi1/1 Gi1/2 Gi1/3 Gi1/4 Gi1/5 Gi1/6 Gi1/7 Gi1/8 Gi1/9 Gi1/10 Gi1/11 Gi1/12 Gi1/13 Gi1/14 Gi1/15 Gi1/16
1783-HMS16TG4CGR	20-port (16 Gigabit ports; 4 Gigabit combo ports) managed switch; Layer 3 firmware	1 2 3 4 5 6 7 8 9 10 11 12 13 14 15 16 17 18 19 20	Gi1/1 Gi1/2 Gi1/3 Gi1/4 Gi1/5 Gi1/6 Gi1/7 Gi1/8 Gi1/9 Gi1/10 Gi1/11 Gi1/12 Gi1/13 Gi1/14 Gi1/15 Gi1/16 Gi1/17 Gi1/18 Gi1/19 Gi1/20

**Table 177 - Stratix 5400 Port Numbering (Continued)**

Cat. No.	Description	Port Numbering on Switch Labels	Port Numbering in config.txt Text File
1783-HMS8TG8EG4CGR	20-port (8 Gigabit ports; 4 Gigabit combo ports; 8 Gigabit PoE/PoE+ ports) managed switch; Layer 3 firmware	1	Gi1/1
		2	Gi1/2
		3	Gi1/3
		4	Gi1/4
		5	Gi1/5
		6	Gi1/6
		7	Gi1/7
		8	Gi1/8
		9	Gi1/9
		10	Gi1/10
		11	Gi1/11
		12	Gi1/12
		13	Gi1/13
		14	Gi1/14
		15	Gi1/15
		16	Gi1/16
		17	Gi1/17
		18	Gi1/18
		19	Gi1/19
		20	Gi1/20

## Stratix 5410 Port Numbering

The port ID consists of the following:

- Port type (Gigabit Ethernet or 10 Gigabit Ethernet)
- Unit number (always 1))
- Port number (1...28)

Gigabit Ethernet is abbreviated as Gi and 10 Gigabit Ethernet as Te.

**Table 178 - Stratix 5410 Port Numbering**

Cat. No.	Description	Port Numbering on Switch Labels	Port Numbering in config.text File
1783-IMS28NDC	28-port (12 Gigabit PoE/PoE+ ports; 12 Gigabit+ 4 10 Gigabit SFP ports) managed switch; Layer 2 firmware; DC power supply	1	Gi1/1
		2	Gi1/2
1783-IMS28NAC	28-port (12 Gigabit PoE/PoE+ ports; 12 Gigabit+ 4 10 Gigabit SFP ports) managed switch; Layer 2 firmware; AC power supply	3	Gi1/3
		4	Gi1/4
		5	Gi1/5
1783-IMS28RDC	28-port (12 Gigabit PoE/PoE+ ports; 12 Gigabit+ 4 10 Gigabit SFP ports) managed switch; Layer 3 firmware; DC power supply	6	Gi1/6
		7	Gi1/7
1783-IMS28RAC	28-port (12 Gigabit PoE/PoE+ ports; 12 Gigabit+ 4 10 Gigabit SFP ports) managed switch; Layer 3 firmware; AC power supply	8	Gi1/8
		9	Gi1/9
1783-IMS28GNDC	28-port (12 Gigabit PoE/PoE+ ports; 16 Gigabit SFP ports) managed switch; Layer 2 firmware; DC power supply	10	Gi1/10
		11	Gi1/11
1783-IMS28GNAC	28-port (12 Gigabit PoE/PoE+ ports; 16 Gigabit SFP ports) managed switch; Layer 2 firmware; AC power supply	12	Gi1/12
		13	Gi1/13
		14	Gi1/14
1783-IMS28GRDC	28-port (12 Gigabit PoE/PoE+ ports; 16 Gigabit SFP ports) managed switch; Layer 3 firmware; DC power supply	15	Gi1/15
		16	Gi1/16
1783-IMS28GRAC	28-port (12 Gigabit PoE/PoE+ ports; 16 Gigabit SFP ports) managed switch; Layer 3 firmware; AC power supply	17	Gi1/17
		18	Gi1/18
		19	Gi1/19
		20	Gi1/20
		21	Gi1/21
		22	Gi1/22
		23	Gi1/23
		24	Gi1/24
		25	Te1/25 or Gi1/25
		26	Te1/26 or Gi1/26
		27	Te1/27 or Gi1/27
		28	Te1/28 or Gi1/28

**Stratix 5700 Port Numbering**

The port ID consists of the following:

- Port type (Gigabit Ethernet for Gigabit ports and Fast Ethernet for 10/100 Mbps ports)
- Unit number (always 1)
- Port number (1...2 for Gigabit ports, 1...18 for all others, depending on the catalog number)

Gigabit Ethernet is abbreviated as Gi and Fast Ethernet as Fa.

**Table 179 - Stratix 5700 Port Numbering**

Cat. No.	Description	Port Numbering on Switch Labels	Port Numbering in config.text File
1783-BMS4S2SGL	6-port (4 SFP slots; 2 SFP Gigabit slots) managed switch; lite firmware	1 2 3 4 5 6	Fa1/1 Fa1/2 Fa1/3 Fa1/4 Fa1/5 Fa1/6
1783-BMS4S2SGA	6-port (4 SFP slots; 2 SFP Gigabit slots) managed switch; full firmware	1 2 3 4 5 6	Fa1/1 Fa1/2 Fa1/3 Fa1/4 Fa1/5 Fa1/6
1783-BMS06SL	6-port (4 Ethernet ports; 2 SFP slots) managed switch; lite firmware	1 2 3 4 5 6	Fa1/1 Fa1/2 Fa1/3 Fa1/4 Fa1/5 Fa1/6
1783-BMS06SA	6-port (4 Ethernet ports; 2 SFP slots) managed switch; full firmware	1 2 3 4 5 6	Fa1/1 Fa1/2 Fa1/3 Fa1/4 Fa1/5 Fa1/6
1783-BMS06TL	6-port (6 Ethernet ports) managed switch; lite firmware	1 2 3 4 5 6	Fa1/1 Fa1/2 Fa1/3 Fa1/4 Fa1/5 Fa1/6
1783-BMS06TA	6-port (6 Ethernet ports) managed switch; full firmware	1 2 3 4 5 6	Fa1/1 Fa1/2 Fa1/3 Fa1/4 Fa1/5 Fa1/6
1783-BMS06SGL	6-port (4 Ethernet ports; 2 SFP Gigabit slots) managed switch; lite firmware	1 2 3 4 1 2	Fa1/1 Fa1/2 Fa1/3 Fa1/4 Gi1/1 Gi1/2

**Table 179 - Stratix 5700 Port Numbering (Continued)**

Cat. No.	Description	Port Numbering on Switch Labels	Port Numbering in config.text File
1783-BM06SGA	6-port (4 Ethernet ports; 2 SFP Gigabit slots) managed switch; full firmware	1 2 3 4 1 2	Fa1/1 Fa1/2 Fa1/3 Fa1/4 Gi1/1 Gi1/2
1783-BMS06TGL	6-port (4 Ethernet ports; 2 Gigabit ports) managed switch; lite firmware	1 2 3 4 1 2	Fa1/1 Fa1/2 Fa1/3 Fa1/4 Gi1/1 Gi1/2
1783-BMS06TGA	6-port (4 Ethernet ports; 2 Gigabit ports) managed switch; full firmware	1 2 3 4 1 2	Fa1/1 Fa1/2 Fa1/3 Fa1/4 Gi1/1 Gi1/2
1783-BMS10CL	10-port (8 Ethernet ports; 2 combo ports) managed switch; lite firmware	1 2 3 4 5 6 7 8 9 10	Fa1/1 Fa1/2 Fa1/3 Fa1/4 Fa1/5 Fa1/6 Fa1/7 Fa1/8 Fa1/9 Fa1/10
1783-BMS10CA	10-port (8 Ethernet ports; 2 combo ports) managed switch; full firmware	1 2 3 4 5 6 7 8 9 10	Fa1/1 Fa1/2 Fa1/3 Fa1/4 Fa1/5 Fa1/6 Fa1/7 Fa1/8 Fa1/9 Fa1/10
1783-BMS10CGL	10-port (8 Ethernet ports; 2 combo Gigabit ports) managed switch; lite firmware	1 2 3 4 5 6 7 8 1 2	Fa1/1 Fa1/2 Fa1/3 Fa1/4 Fa1/5 Fa1/6 Fa1/7 Fa1/8 Gi1/1 Gi1/2



**Table 179 - Stratix 5700 Port Numbering (Continued)**

Cat. No.	Description	Port Numbering on Switch Labels	Port Numbering in config.text File
1783-BMS10CGA	10-port (8 Ethernet ports; 2 combo Gigabit ports) managed switch; full firmware	1 2 3 4 5 6 7 8 1 2	Fa1/1 Fa1/2 Fa1/3 Fa1/4 Fa1/5 Fa1/6 Fa1/7 Fa1/8 Gi1/1 Gi1/2
1783-BMS10CGN	10-port (8 Ethernet ports; 2 combo Gigabit ports) managed switch; full firmware; PTP; NAT	1 2 3 4 5 6 7 8 1 2	Fa1/1 Fa1/2 Fa1/3 Fa1/4 Fa1/5 Fa1/6 Fa1/7 Fa1/8 Gi1/1 Gi1/2
1783-BMS10CGP	10-port (8 Ethernet ports; 2 combo Gigabit ports) managed switch; full firmware; PTP	1 2 3 4 5 6 7 8 1 2	Fa1/1 Fa1/2 Fa1/3 Fa1/4 Fa1/5 Fa1/6 Fa1/7 Fa1/8 Gi1/1 Gi1/2
1783-BMS12T4E2CGNK	18-port (12 Ethernet ports; 4 PoE/PoE+ ports; 2 combo Gigabit ports) managed switch; full firmware; PTP; NAT; conformal coating	1 2 3 4 5 6 7 8 9 10 11 12 13 14 15 16 1 2	Fa1/1 Fa1/2 Fa1/3 Fa1/4 Fa1/5 Fa1/6 Fa1/7 Fa1/8 Fa1/9 Fa1/10 Fa1/11 Fa1/12 Fa1/13 Fa1/14 Fa1/15 Fa1/16 Gi1/1 Gi1/2

**Table 179 - Stratix 5700 Port Numbering (Continued)**

Cat. No.	Description	Port Numbering on Switch Labels	Port Numbering in config.text File
1783-BMS12T4E2CGP	18-port (12 Ethernet ports; 4 PoE/PoE+ ports; 2 combo Gigabit ports) managed switch; full firmware; PTP	1 2 3 4 5 6 7 8 9 10 11 12 13 14 15 16 1 2	Fa1/1 Fa1/2 Fa1/3 Fa1/4 Fa1/5 Fa1/6 Fa1/7 Fa1/8 Fa1/9 Fa1/10 Fa1/11 Fa1/12 Fa1/13 Fa1/14 Fa1/15 Fa1/16 Gi1/1 Gi1/2
1783-BMS12T4E2CGL	18-port (12 Ethernet ports; 4 PoE/PoE+ ports; 2 combo Gigabit ports) managed switch; lite firmware	1 2 3 4 5 6 7 8 9 10 11 12 13 14 15 16 1 2	Fa1/1 Fa1/2 Fa1/3 Fa1/4 Fa1/5 Fa1/6 Fa1/7 Fa1/8 Fa1/9 Fa1/10 Fa1/11 Fa1/12 Fa1/13 Fa1/14 Fa1/15 Fa1/16 Gi1/1 Gi1/2
1783-BMS20CL	20-port (16 Ethernet ports; 2 SFP slots; 2 combo ports) managed switch; lite firmware	1 2 3 4 5 6 7 8 9 10 11 12 13 14 15 16 17 18 19 20	Fa1/1 Fa1/2 Fa1/3 Fa1/4 Fa1/5 Fa1/6 Fa1/7 Fa1/8 Fa1/9 Fa1/10 Fa1/11 Fa1/12 Fa1/13 Fa1/14 Fa1/15 Fa1/16 Fa1/17 Fa1/18 Fa1/19 Fa1/20

**Table 179 - Stratix 5700 Port Numbering (Continued)**

Cat. No.	Description	Port Numbering on Switch Labels	Port Numbering in config.text File
1783-BMS20CA	20-port (16 Ethernet ports; 2 SFP slots; 2 combo ports) managed switch; full firmware	1 2 3 4 5 6 7 8 9 10 11 12 13 14 15 16 17 18 19 20	Fa1/1 Fa1/2 Fa1/3 Fa1/4 Fa1/5 Fa1/6 Fa1/7 Fa1/8 Fa1/9 Fa1/10 Fa1/11 Fa1/12 Fa1/13 Fa1/14 Fa1/15 Fa1/16 Fa1/17 Fa1/18 Fa1/19 Fa1/20
1783-BMS20CGL	20-port (16 Ethernet ports; 2 SFP slots; 2 combo Gigabit ports) managed switch; lite firmware	1 2 3 4 5 6 7 8 9 10 11 12 13 14 15 16 17 18 1 2	Fa1/1 Fa1/2 Fa1/3 Fa1/4 Fa1/5 Fa1/6 Fa1/7 Fa1/8 Fa1/9 Fa1/10 Fa1/11 Fa1/12 Fa1/13 Fa1/14 Fa1/15 Fa1/16 Fa1/17 Fa1/18 Gi1/1 Gi1/2

**Table 179 - Stratix 5700 Port Numbering (Continued)**

Cat. No.	Description	Port Numbering on Switch Labels	Port Numbering in config.text File
1783-BMS20CGN	20-port (16 Ethernet ports; 2 SFP slots; 2 combo Gigabit ports) managed switch; full firmware; PTP; NAT	1 2 3 4 5 6 7 8 9 10 11 12 13 14 15 16 17 18 1 2	Fa1/1 Fa1/2 Fa1/3 Fa1/4 Fa1/5 Fa1/6 Fa1/7 Fa1/8 Fa1/9 Fa1/10 Fa1/11 Fa1/12 Fa1/13 Fa1/14 Fa1/15 Fa1/16 Fa1/17 Fa1/18 Gi1/1 Gi1/2
1783-BMS20CGP	20-port (16 Ethernet ports; 2 SFP slots; 2 combo Gigabit ports) managed switch; full firmware; PTP	1 2 3 4 5 6 7 8 9 10 11 12 13 14 15 16 17 18 1 2	Fa1/1 Fa1/2 Fa1/3 Fa1/4 Fa1/5 Fa1/6 Fa1/7 Fa1/8 Fa1/9 Fa1/10 Fa1/11 Fa1/12 Fa1/13 Fa1/14 Fa1/15 Fa1/16 Fa1/17 Fa1/18 Gi1/1 Gi1/2

**Table 179 - Stratix 5700 Port Numbering (Continued)**

Cat. No.	Description	Port Numbering on Switch Labels	Port Numbering in config.text File
1783-BMS20CGPK	20-port (16 Ethernet ports; 2 SFP slots; 2 combo Gigabit ports) managed switch; full firmware; PTP; conformal coating	1 2 3 4 5 6 7 8 9 10 11 12 13 14 15 16 17 18 1 2	Fa1/1 Fa1/2 Fa1/3 Fa1/4 Fa1/5 Fa1/6 Fa1/7 Fa1/8 Fa1/9 Fa1/10 Fa1/11 Fa1/12 Fa1/13 Fa1/14 Fa1/15 Fa1/16 Fa1/17 Fa1/18 Gi1/1 Gi1/2

## ArmorStratix 5700 Port Numbering

The port ID consists of the following:

- Port type (Gigabit Ethernet for Gigabit ports and Fast Ethernet for 10/100 Mbps ports)
- Unit number (always 1)
- Port number (1...2 for Gigabit ports, 1...18 for all others, depending on the catalog number)

Gigabit Ethernet is abbreviated as Gi and Fast Ethernet as Fa.

**Table 180 - ArmorStratix 5700 Port Numbering**

Cat. No.	Description	Port Numbering on Switch Labels	Port Numbering in config.text File
1783-ZMS8TA	8-port (8 Ethernet ports) managed switch; full firmware	1 2 3 4 5 6 7 8	Fa1/1 Fa1/2 Fa1/3 Fa1/4 Fa1/5 Fa1/6 Fa1/7 Fa1/8
1783-ZMS4T4E2TGP	10-port (2 Gigabit ports; 4 Ethernet ports; 4 PoE/PoE+ ports) managed switch; full firmware; PTP	GE-1 GE-2 1 2 3 4 5 6 7 8	Gi1/1 Gi1/2 Fa1/1 Fa1/2 Fa1/3 Fa1/4 Fa1/5 Fa1/6 Fa1/7 Fa1/8
1783-ZMS4T4E2TGN	10-port (2 Gigabit ports; 4 Ethernet ports; 4 PoE/PoE+ ports) managed switch; full firmware; PTP; NAT	GE-1 GE-2 1 2 3 4 5 6 7 8	Gi1/1 Gi1/2 Fa1/1 Fa1/2 Fa1/3 Fa1/4 Fa1/5 Fa1/6 Fa1/7 Fa1/8
1783-ZMS16TA	16-port (16 Ethernet ports) managed switch; full firmware	1 2 3 4 5 6 7 8 9 10 11 12 13 14 15 16	Fa1/1 Fa1/2 Fa1/3 Fa1/4 Fa1/5 Fa1/6 Fa1/7 Fa1/8 Fa1/9 Fa1/10 Fa1/11 Fa1/12 Fa1/13 Fa1/14 Fa1/15 Fa1/16

**Table 180 - ArmorStratix 5700 Port Numbering (Continued)**

Cat. No.	Description	Port Numbering on Switch Labels	Port Numbering in config.text File
1783-ZMS8T8E2TGP	18-port (2 Gigabit ports; 8 Ethernet ports; 8 PoE/PoE+ ports) managed switch; full firmware; PTP	GE-1 GE-2 1 2 3 4 5 6 7 8 9 10 11 12 13 14 15 16	Gi1/1 Gi1/2 Fa1/1 Fa1/2 Fa1/3 Fa1/4 Fa1/5 Fa1/6 Fa1/7 Fa1/8 Fa1/9 Fa1/10 Fa1/11 Fa1/12 Fa1/13 Fa1/14 Fa1/15 Fa1/16
1783-ZMS8T8E2TGN	18-port (2 Gigabit ports; 8 Ethernet ports; 8 PoE/PoE+ ports) managed switch; full firmware; PTP; NAT	GE-1 GE-2 1 2 3 4 5 6 7 8 9 10 11 12 13 14 15 16	Gi1/1 Gi1/2 Fa1/1 Fa1/2 Fa1/3 Fa1/4 Fa1/5 Fa1/6 Fa1/7 Fa1/8 Fa1/9 Fa1/10 Fa1/11 Fa1/12 Fa1/13 Fa1/14 Fa1/15 Fa1/16

**Table 180 - ArmorStratix 5700 Port Numbering (Continued)**

Cat. No.	Description	Port Numbering on Switch Labels	Port Numbering in config.text File
1783-ZMS24TA	24-port (24 Ethernet ports) managed switch; full firmware	1 2 3 4 5 6 7 8 9 10 11 12 13 14 15 16 17 18 19 20 21 22 23 24	Fa1/1 Fa1/2 Fa1/3 Fa1/4 Fa1/5 Fa1/6 Fa1/7 Fa1/8 Fa1/9 Fa1/10 Fa1/11 Fa1/12 Fa1/13 Fa1/14 Fa1/15 Fa1/16 Fa1/17 Fa1/18 Fa1/19 Fa1/20 Fa1/21 Fa1/22 Fa1/23 Fa1/24



## Stratix 8000 and 8300 Port Numbering

The port ID consists of the following:

- Port type (Gigabit Ethernet for Gigabit ports and Fast Ethernet for 10/100 Mbps ports)
- Unit number (1, 2, or 3)
- Port number (1...2 for Gigabits, 1...4 for the 6-port base and 1...8 for all others)

Gigabit Ethernet is abbreviated as Gi and Fast Ethernet as Fa.

For the expansion modules, the Fa# represents slot 2 o 3.

**Table 181 - Stratix 8000/8300 Switch and Expansion Module Port Numbering**

Cat. No.	Description	Port Numbering on Switch Labels	Port Numbering in config.txt Text File
1783-MS06T	6-port (2 Gigabit ports; 4 Ethernet ports) base switch	Gigabit ports: 1 2 Fast Ethernet ports: 1 2 3 4	Gigabit ports: Gi1/1 Gi1/2 Fast Ethernet ports: Fa1/1 Fa1/2 Fa1/3 Fa1/4
1783-MS10T	10-port (2 Gigabit ports; 8 Ethernet ports) base switch	Gigabit ports: 1 2 Fast Ethernet ports: 1 2 3 4 5 6 7 8	Gigabit ports: Gi1/1 Gi1/2 Fast Ethernet ports: Fa1/1 Fa1/2 Fa1/3 Fa1/4 Fa1/5 Fa1/6 Fa1/7 Fa1/8
1783-RMS06T	6-port (2 Gigabit ports; 4 Ethernet ports) base switch	Gigabit ports: 1 2 Fast Ethernet ports: 1 2 3 4	Gigabit ports: Gi1/1 Gi1/2 Fast Ethernet ports: Fa1/1 Fa1/2 Fa1/3 Fa1/4
1783-RMS10T	10-port (2 Gigabit ports; 8 Ethernet ports) base switch	Gigabit ports: 1 2 Fast Ethernet ports: 1 2 3 4 5 6 7 8	Gigabit ports: Gi1/1 Gi1/2 Fast Ethernet ports: Fa1/1 Fa1/2 Fa1/3 Fa1/4 Fa1/5 Fa1/6 Fa1/7 Fa1/8

**Table 181 - Stratix 8000/8300 Switch and Expansion Module Port Numbering (Continued)**

Cat. No.	Description	Port Numbering on Switch Labels	Port Numbering in config.txt Text File
1783-MX04E	4-port (4 PoE ports) expansion module	1 2 3 4	Fa#/1 Fa#/2 Fa#/3 Fa#/4
1783-MX04T04E	8-port(4 Ethernet ports; 4 PoE ports) expansion module	1 2 3 4 5 6 7 8	Fa#/1 Fa#/2 Fa#/3 Fa#/4 Fa#/5 Fa#/6 Fa#/7 Fa#/8
1783-MX04S	4-port (4 SFP ports) expansion module	1 2 3 4	Fa#/1 Fa#/2 Fa#/3 Fa#/4
1783-MX08S	8-port (8 SFP ports) expansion module	1 2 3 4 5 6 7 8	Fa#/1 Fa#/2 Fa#/3 Fa#/4 Fa#/5 Fa#/6 Fa#/7 Fa#/8
1783-MX08T	8-port (8 Ethernet ports) expansion module	1 2 3 4 5 6 7 8	Fa#/1 Fa#/2 Fa#/3 Fa#/4 Fa#/5 Fa#/6 Fa#/7 Fa#/8
1783-MX08F	8-port (8 Ethernet ports) expansion module	1 2 3 4 5 6 7 8	Fa#/1 Fa#/2 Fa#/3 Fa#/4 Fa#/5 Fa#/6 Fa#/7 Fa#/8

## Cables and Connectors

Topic	Page
Stratix 5410 Cables and Connectors	435
Stratix 5400 and 5700 Cables and Connectors	441
ArmorStratix 5700 Cables and Connectors	447
Stratix 8000/8300 Cables and Connectors	452

For recommended cables and SFP modules, see the Stratix Ethernet Device Specifications Technical Data, publication [1783-TD001](#).

### Stratix 5410 Cables and Connectors

This section describes how to connect to ports on Stratix® 5410 switches.

#### 10/100/1000 Ports

The 10/100/1000 Ethernet, PoE/PoE+ ports use standard RJ45 connectors and Ethernet pinouts with internal crossovers.

**Figure 57 - 10/100/1000 Connector Pinouts**

Pin	Label	1 2 3 4 5 6 7 8
1	TP0+	
2	TP0-	
3	TP1+	
4	TP2+	
5	TP2-	
6	TP1-	
7	TP3+	
8	TP3-	

## Connect to 10BASE-T- and 100BASE-TX-Compatible Devices

The auto-MDIX feature is enabled by default. Follow these cabling guidelines when the auto-MDIX feature has been disabled.

When connecting the ports to 10BASE-T- and 100BASE-TX-compatible devices, such as servers and routers, you can use a two or four twisted-pair, straight-through cable that is wired for 10BASE-T and 100BASE-TX.

To identify a crossover cable, compare the two modular ends of the cable. Hold the cable ends side-by-side, with the tab at the back. The color of the wire that is connected to the pin on the outside of the left plug must differ from the color of the wire that is connected to the pin on the inside of the right plug.

[Figure 67](#) and [Figure 68](#) show the cable schematics.

**Figure 58 - Two Twisted-pair Straight-through Cable Schematics**

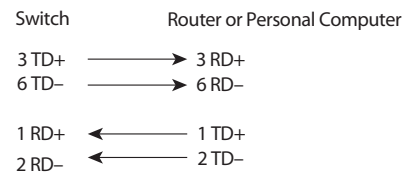

**Figure 59 - Four Twisted-pair Straight-through Cable Schematics**

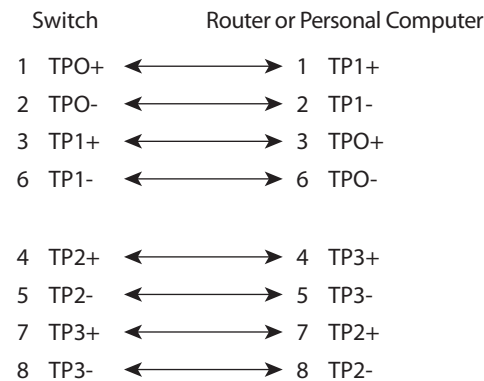

When connecting the ports to 10BASE-T- and 100BASE-TX-compatible devices, such as switches or repeaters, you can use a two or four twisted-pair, crossover cable.

Use a straight-through cable to connect two ports when only one port is designated with an X. Use a crossover cable to connect two ports when both ports are designated with an X or when both ports do not have an X.



## Console Ports

Console ports enable you to connect a switch to a computer if you use the Command-line interface (CLI) to configure and monitor a switch.

Stratix 5410 switches have these console ports:

- A USB 5-pin mini-Type B port on the front panel

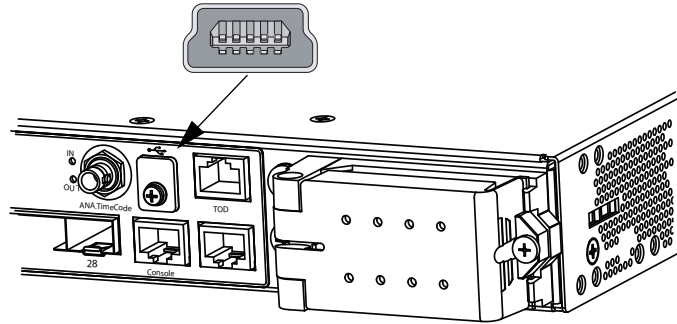

The USB console port uses a USB Type A to 5-pin mini-Type B cable. To use the USB cable, download the drivers for Microsoft Windows from <http://www.rockwellautomation.com>. The USB cable is not provided with the switch.

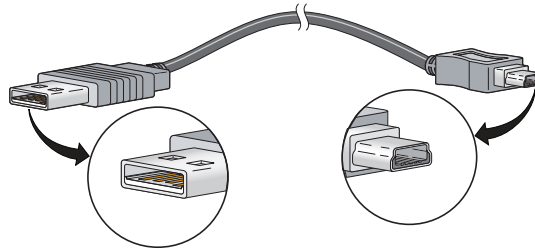

- RJ45 console port on the front panel

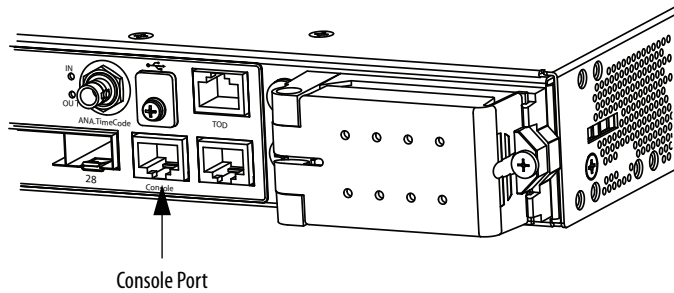

The following table lists the pinouts for the console port, the RJ45-to-DB-9 adapter cable, and the console device.

**Table 182 - Pinouts with DB-9 Pin**

Switch Console Port (DTE)	RJ45-to-DB-9 Terminal Adapter	Console Device
Signal	DB-9 Pin	Signal
RTS	8	CTS
DTR	6	DSR
TxD	2	RxD
GND	5	GND
GND	5	GND
RxD	3	TxD
DSR	4	DTR
CTS	7	RTS

The following table lists the pinouts for the console port, RJ45-to-DB-25 female DTE adapter, and the console device. The RJ45-to-DB-25 female DTE adapter is not supplied with the switch.

**Table 183 - Pinouts with DB-25 Pin**

Switch Console Port (DTE)	RJ45-to-DB-25 Terminal Adapter	Console Device
Signal	DB-25 Pin	Signal
RTS	5	CTS
DTR	6	DSR
TxD	3	RxD
GND	7	GND
GND	7	GND
RxD	2	TxD
DSR	20	DTR
CTS	4	RTS

## Alarm Port

The front panel alarm port uses an RJ45 connector.

**Figure 62 - Front Panel Alarm Connector**

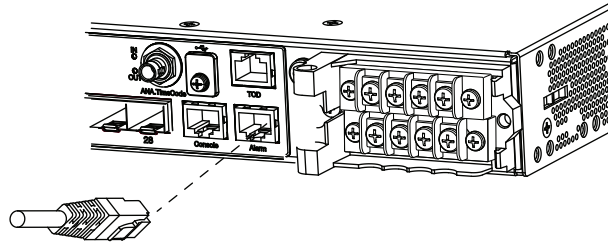

**Figure 63 - Alarm Connector Pinout**

Pin	Label	1	2	3	4	5	6	7	8
1	Alarm 1 input								
2	Alarm 2 input								
3	Alarm output normally closed								
4	Alarm 3 input								
5	Alarm 4 input								
6	Alarm output normally open								
7	Alarm output common								
8	Alarm input common								

## Ethernet, PoE Port Cable Specifications

For Ethernet, PoE ports, use a Category 5 (Cat 5) cable with a distance of up to 100 m (328 ft).



## Stratix 5400 and 5700 Cables and Connectors

This section describes how to connect to ports on Stratix 5400 and Stratix 5700 switches.

### 10/100 and 10/100/1000 Ports

The 10/100 and 10/100/1000 Ethernet ports use standard RJ45 connectors and Ethernet pinouts with internal crossovers.

**Figure 64 - 10/100 Connector Pinouts**

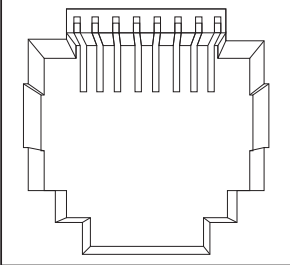
Pin	Label	1	2	3	4	5	6	7	8
1	RD+								
2	RD-								
3	TD+								
4	NC								
5	NC								
6	TD-								
7	NC								
8	NC								

**Figure 65 - 10/100/1000 Connector Pinouts**

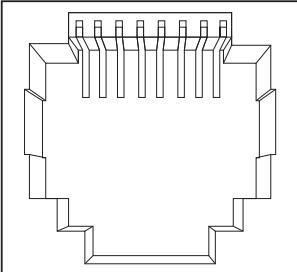
Pin	Label	1	2	3	4	5	6	7	8
1	TP0+								
2	TP0-								
3	TP1+								
4	TP2+								
5	TP2-								
6	TP1-								
7	TP3+								
8	TP3-								

PoE ports integrate power and data signals on the same wires. The ports use standard RJ45 connectors and Ethernet pinouts with internal crossovers.

**Figure 66 - 10/100 PoE Connector Pinouts and Power Sourcing Equipment (PSE) Voltage**

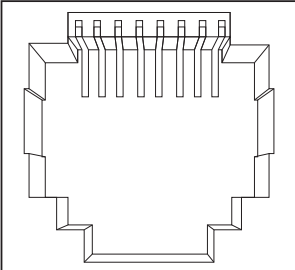
Pin	Label	Alternative A (MDI)	1	2	3	4	5	6	7	8
1	RD+	Positive V PSE								
2	RD-	Positive V PSE								
3	TD+	Negative V PSE								
4	NC									
5	NC									
6	TD-	Negative V PSE								
7	NC									
8	NC									

## Connect to 10BASE-T- and 100BASE-TX-Compatible Devices

The auto-MDIX feature is enabled by default. Follow these cabling guidelines when the auto-MDIX feature has been disabled.

When connecting the ports to 10BASE-T- and 100BASE-TX-compatible devices, such as servers and routers, you can use a two or four twisted-pair, straight-through cable that is wired for 10BASE-T and 100BASE-TX.

To identify a crossover cable, compare the two modular ends of the cable. Hold the cable ends side-by-side, with the tab at the back. The color of the wire that is connected to the pin on the outside of the left plug must differ in color from the wire that is connected to the pin on the inside of the right plug.

[Figure 67](#) and [Figure 68](#) show the cable schematics.

**Figure 67 - Two Twisted-pair Straight-through Cable Schematics**

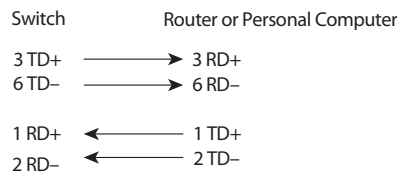

**Figure 68 - Four Twisted-pair Straight-through Cable Schematics**

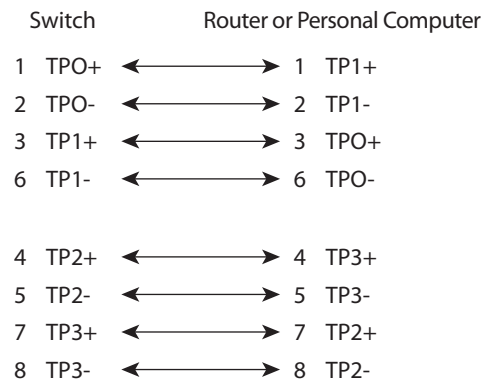

When connecting the ports to 10BASE-T- and 100BASE-TX-compatible devices, such as switches or repeaters, you can use a two or four twisted-pair, crossover cable.

Use a straight-through cable to connect two ports when only one port is designated with an X. Use a crossover cable to connect two ports when both ports are designated with an X or when both ports do not have an X.

You can use Category 3, 4, or 5 cabling when connecting to 10BASE-T-compatible devices. You must use Category 5 cabling when connecting to 100BASE-TX-compatible devices.

---

**IMPORTANT** Use a four twisted-pair, Category 5 cable when connecting to a 100BASE-T-compatible device or PoE port.

---

[Figure 69](#) and [Figure 70](#) show the cable schematics.

**Figure 69 - Two Twisted-pair Crossover Cable Schematics**

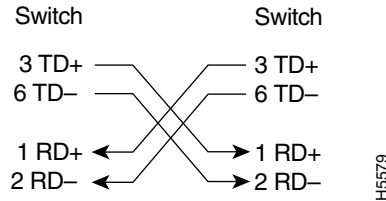

**Figure 70 - Four Twisted-pair Crossover Cable Schematics**

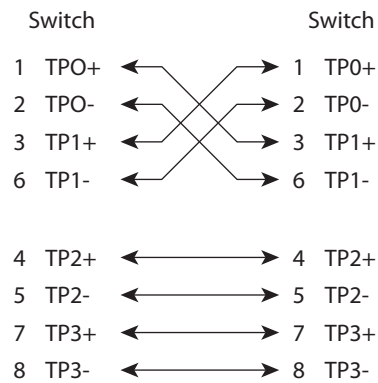

## Dual-purpose Ports (combo ports)

The Ethernet port on a dual-purpose port uses standard RJ45 connectors. The following figure shows the pinouts.

**Figure 71 - Ethernet Port RJ45 Connector**

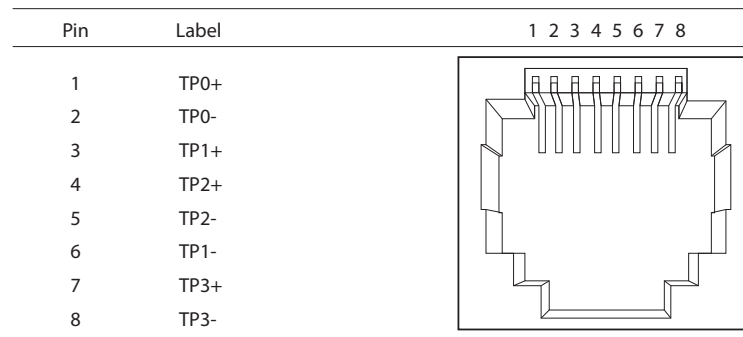

The SFP module slot on a dual-purpose port uses SFP modules for fiber-optic ports. The auto-MDIX feature is enabled by default.

## Console Ports

Console ports enable you to connect a switch to a computer if you use the Command-line interface (CLI) to configure and monitor a switch.

Stratix 5700 switches have these console ports:

- A USB 5-pin mini-Type B port on the front panel

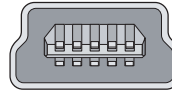

The USB console port uses a USB Type A to 5-pin mini-Type B cable. To use the USB cable, download the drivers for Microsoft Windows from <http://www.rockwellautomation.com>. The USB cable is not provided with the switch.

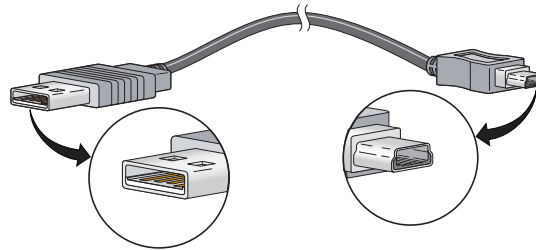

- RJ45 console ports on the front and rear panels
- Only one console port can be active at one time.

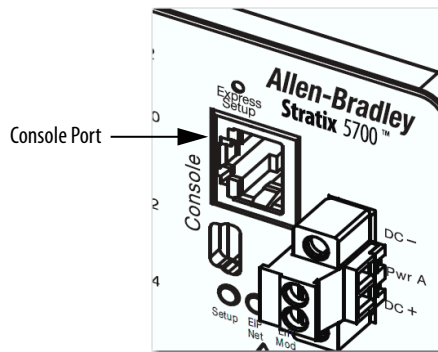

The following table lists the pinouts for the console port, the RJ45-to-DB-9 adapter cable, and the console device.

**Table 184 - Pinouts with DB-9 Pin**

Switch Console Port (DTE)	RJ45-to-DB-9 Terminal Adapter	Console Device
Signal	DB-9 Pin	Signal
RTS	8	CTS
DTR	6	DSR
TxD	2	RxD
GND	5	GND
GND	5	GND
RxD	3	TxD
DSR	4	DTR
CTS	7	RTS

The following table lists the pinouts for the console port, RJ45-to-DB-25 female DTE adapter, and the console device. The RJ45-to-DB-25 female DTE adapter is not supplied with the switch.

**Table 185 - Pinouts with DB-25 Pin**

Switch Console Port (DTE)	RJ45-to-DB-25 Terminal Adapter	Console Device
Signal	DB-25 Pin	Signal
RTS	5	CTS
DTR	6	DSR
TxD	3	RxD
GND	7	GND
GND	7	GND
RxD	2	TxD
DSR	20	DTR
CTS	4	RTS

## Alarm Ports

The front-panel alarm-relay connector ports are described in the following illustration and table.

**Figure 72 - Wiring Example for Alarm Inputs and Outputs**

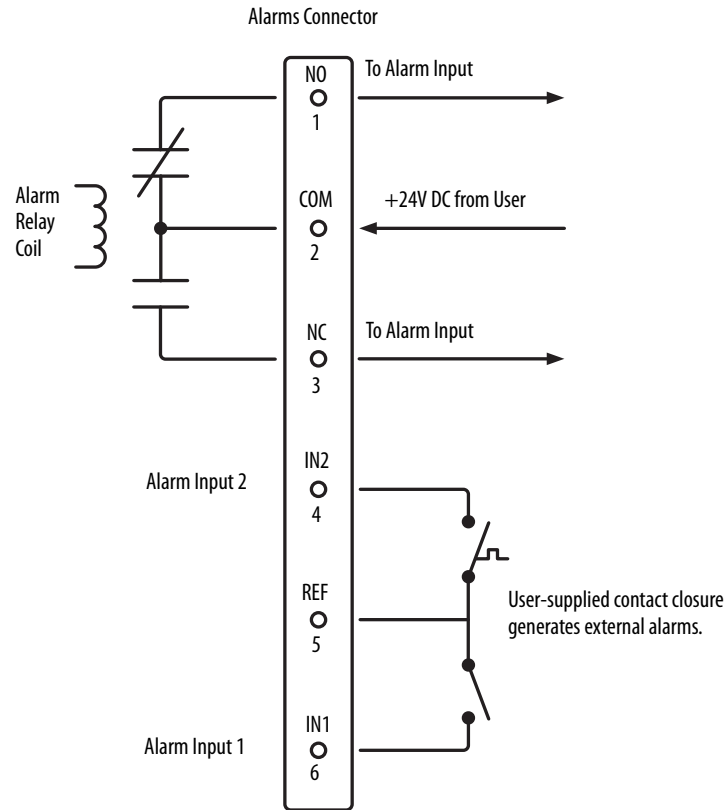

Label	Connection
NO	Alarm Output Normally Open (NO) connection
COM	Alarm Output Common connection
NC	Alarm Output Normally Closed (NC) connection
IN2	Alarm Input 2
REF	Alarm Input Reference Ground connection
IN1	Alarm Input 1

## PoE Port Cable Specifications

For PoE ports, use a Category 5 (Cat 5) cable with a distance of up to 100 m (328 ft).

## ArmorStratix 5700 Cables and Connectors

This section describes how to connect to ports on ArmorStratix 5700 switches.

### 10/100 Ports

The 10/100 Ethernet ports use M12 D-coded 4-pin connectors and Ethernet pinouts with twisted-pair crossovers or straight-through cables.

**Figure 73 - 10/100 Connector Pinouts**

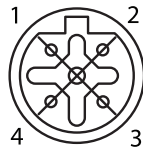

1	RD+
2	TD+
3	RD-
4	TD-

### 100/1000 Ports

The 100/1000 Ethernet ports use M12 X-coded 8-pin connectors and Ethernet pinouts with twisted-pair crossovers or straight-through cables.

**Figure 74 - 100/1000 Connector Pinouts**

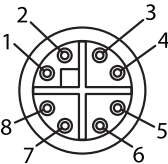

1	BI_DA+
2	BI_DA-
3	BI_DB+
4	BI_DB-
5	BI_DD+
6	BI_DD-
7	BI_DC-
8	BI_DC+

## Connect to 10BASE-T- and 100BASE-TX-Compatible Devices

The auto-MDIX feature is enabled by default. Follow these cabling guidelines when the auto-MDIX feature has been disabled.

When connecting the ports to 10BASE-T- and 100BASE-TX-compatible devices, such as servers and routers, you can use a two or four twisted-pair, straight-through cable that is wired for 10BASE-T and 100BASE-TX.

To identify a crossover cable, compare the two modular ends of the cable. Hold the cable ends side-by-side, with the tab at the back. The color of the wire that is connected to the pin on the outside of the left plug must differ in color from the wire that is connected to the pin on the inside of the right plug.

[Figure 75](#) and [Figure 76](#) show the cable schematics.

**Figure 75 - Two Twisted-pair Straight-through Cable Schematics**

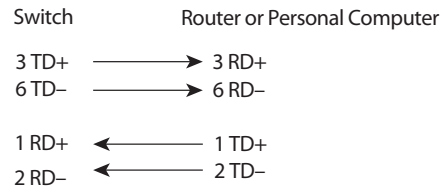

**Figure 76 - Four Twisted-pair Straight-through Cable Schematics**

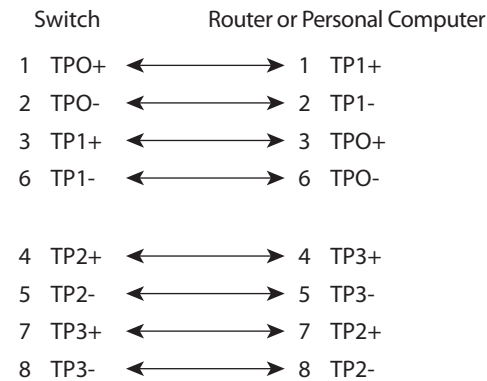



When connecting the ports to 10BASE-T- and 100BASE-TX-compatible devices, such as switches or repeaters, you can use a two or four twisted-pair, crossover cable.

Use a straight-through cable to connect two ports when only one port is designated with an X. Use a crossover cable to connect two ports when both ports are designated with an X or when both ports do not have an X.

You can use Category 3, 4, or 5 cabling when connecting to 10BASE-T-compatible devices. You must use Category 5 cabling when connecting to 100BASE-TX-compatible devices.

---

**IMPORTANT** Use a four twisted-pair, Category 5 cable when connecting to a 100BASE-T-compatible device or PoE port.

---

[Figure 77](#) and [Figure 78](#) show the cable schematics.

**Figure 77 - Two Twisted-pair Crossover Cable Schematics**

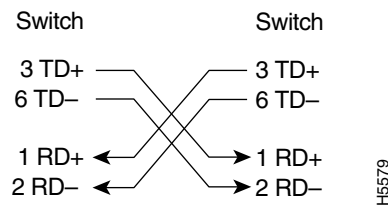

**Figure 78 - Four Twisted-pair Crossover Cable Schematics**

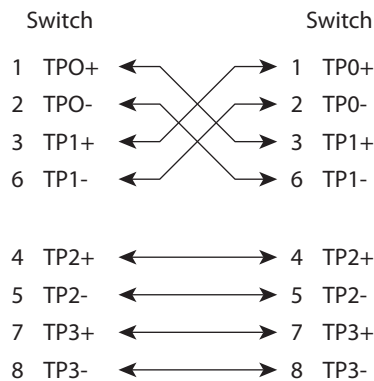

## Console Port

AzorStratix 5700 switches have one console port. The console port enables you to connect the switch to a computer if you use the Command-line interface (CLI) to configure and monitor the switch.

Connect to the console port with an M12-to-DB-9 cable (Figure 79):

- Obtain a male 5-pin DC Micro-style (M12) connector configuration cordset, such as Allen-Bradley Bulletin 889D.
- Obtain a DB-9 connector and attach it to one end of the cable.

Figure 79 - M12-to-DB-9 Cable

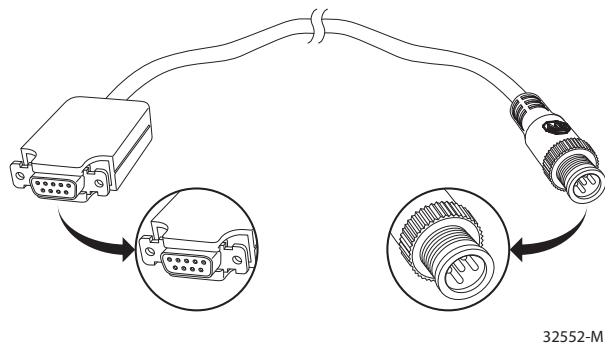

Figure 80 - Console Port Pinout

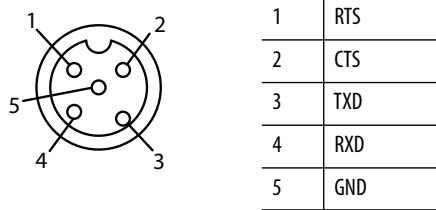
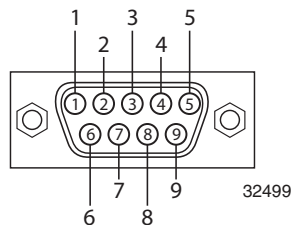

Figure 81 - DB-9 Connector Pinout



M8 Cable		DB9-S Connector	
Pin	Function	Pin	Function
1	RTS	8	CTS
2	CTS	7	RTS
3	TD	2	RD
4	RD	3	TD
5	GRND	5	GRND

### Alarm Ports

Alarm ports are included only on ArmorStratix 5700 switches with PoE. [Figure 82](#) shows the front-panel alarm relay connector and ports. The alarm connector uses a male 5-pin DC Micro-style (M12) connector configuration cordset, such as Allen-Bradley Bulletin 889D.

**Figure 82 - Alarm Connector Pinout**

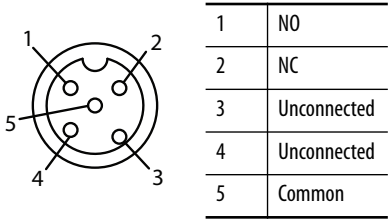

**Figure 83 - Wiring Example for Alarm Inputs and Outputs**

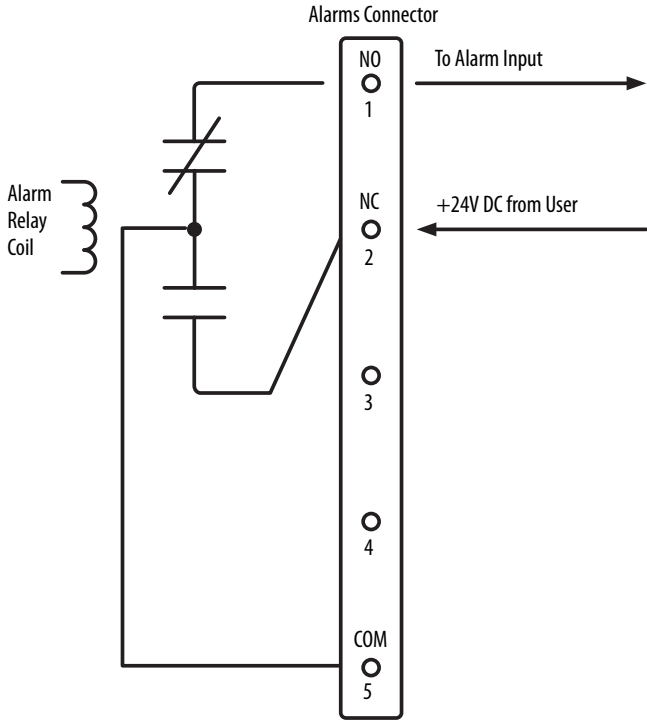

Label	Connection
NO	Alarm Output Normally Open (NO) connection
NC	Alarm Output Normally Closed (NC) connection
Unconnected	Unconnected
Unconnected	Unconnected
COM	Alarm Output Common connection

### PoE Port Cable Specifications

For PoE ports, use a Category 5 (Cat 5) cable with a distance of up to 100 m (328 ft).

## Stratix 8000/8300 Cables and Connectors

This section describes how to connect to ports on Stratix 8000/8300 switches.

### 10/100 and 10/100/1000 Ports

The 10/100 and 10/100/1000 Ethernet ports use standard RJ45 connectors and Ethernet pinouts with internal crossovers.

**TIP** The auto-MDIX feature is enabled by default.

**Figure 84 - 10/100 Connector Pinouts**

Pin	Label	1 2 3 4 5 6 7 8
1	RD+	
2	RD-	
3	TD+	
4	NC	
5	NC	
6	TD-	
7	NC	
8	NC	

**Figure 85 - 10/100/1000 Connector Pinouts**

Pin	Label	1 2 3 4 5 6 7 8
1	TP0+	
2	TP0-	
3	TP1+	
4	TP2+	
5	TP2-	
6	TP1-	
7	TP3+	
8	TP3-	

The PoE ports on the PoE expansion modules integrate power and data signals on the same wires. The ports use standard RJ45 connectors and Ethernet pinouts with internal crossovers.

**Figure 86 - 10/100 PoE Connector Pinouts and Power Sourcing Equipment (PSE) Voltage**

Pin	Label	Alternative A (MDI)	1 2 3 4 5 6 7 8
1	RD+	Positive V PSE	
2	RD-	Positive V PSE	
3	TD+	Negative V PSE	
4	NC		
5	NC		
6	TD-	Negative V PSE	
7	NC		
8	NC		

## Connect to 10BASE-T- and 100BASE-TX-compatible Devices

When connecting the ports to 10BASE-T- and 100BASE-TX-compatible devices, such as servers and routers, you can use a two or four twisted-pair, straight-through cable that is wired for 10BASE-T and 100BASE-TX.

To identify a crossover cable, compare the two modular ends of the cable. Hold the cable ends side-by-side, with the tab at the back. The color of the wire that is connected to the pin on the outside of the left plug must differ in color from the wire that is connected to the pin on the inside of the right plug.

[Figure 87](#) and [Figure 88](#) show the cable schematics.

**Figure 87 - Two Twisted-pair Straight-through Cable Schematics**

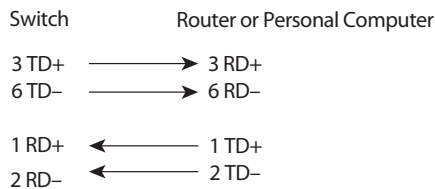

**Figure 88 - Four Twisted-pair Straight-through Cable Schematics**

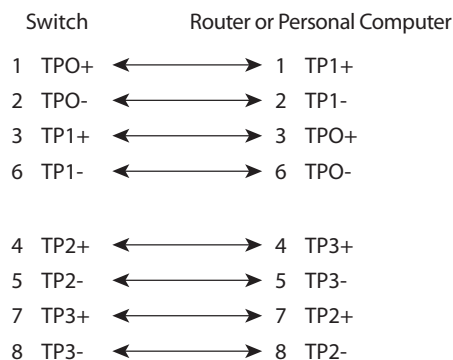

When connecting the ports to 10BASE-T- and 100BASE-TX-compatible devices, such as switches or repeaters, you can use a two or four twisted-pair, crossover cable.

Use a straight-through cable to connect two ports only when one port is designated with an X. Use a crossover cable to connect two ports when both ports are designated with an X or when both ports do not have an X.

You can use Category 3, 4, or 5 cabling when connecting to 10BASE-T-compatible devices. You must use Category 5 cabling when connecting to 100BASE-TX-compatible devices.

---

**IMPORTANT** Use a four twisted-pair, Category 5 cable when connecting to a 100BASE-T-compatible device or PoE port.

---

Figure 89 and Figure 90 show the cable schematics.

**Figure 89 - Two Twisted-pair Crossover Cable Schematics**

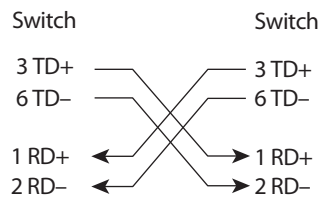

**Figure 90 - Four Twisted-pair Crossover Cable Schematics**

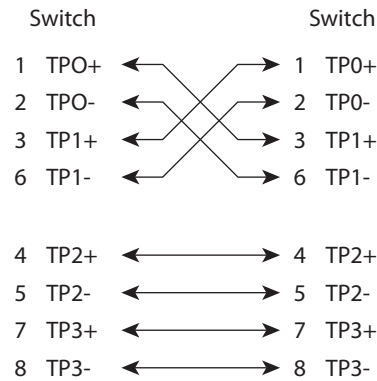

## 100Base-FX Ports

The 100Base-FX ports use the following:

- LC connectors, as shown in the following figure
- 50/125- or 62.5 /125-micron multimode fiber-optic cables

**Figure 91 - Fiber-optic SFP Module LC Connector**

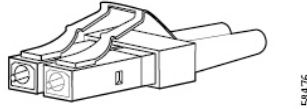

**ATTENTION:** Invisible laser radiation can be emitted from disconnected fibers or connectors. Do not stare into beams or view directly with optical instruments.

## SFP Transceiver Ports

The switch uses SFP transceivers for fiber-optic uplink ports.



**ATTENTION:** Invisible laser radiation can be emitted from disconnected fibers or connectors. Do not stare into beams or view directly with optical instruments.

## Dual-purpose Ports

The Ethernet port on a dual-purpose port uses standard RJ45 connectors. The following figure shows the pinouts.

**Figure 92 - Ethernet Port RJ45 Connector**

Pin	Label	1	2	3	4	5	6	7	8
1	TP0+								
2	TP0-								
3	TP1+								
4	TP2+								
5	TP2-								
6	TP1-								
7	TP3+								
8	TP3-								

The SFP module slot on a dual-purpose port uses SFP modules for fiber-optic ports.

**IMPORTANT** The auto-MDIX feature is enabled by default.

## Console Port

The console port enables you to connect the switch to a computer if you use the Command-line interface (CLI) to configure and monitor the switch.

The console port uses an 8-pin RJ45 connector. The supplied RJ45-to-DB-9 adapter cable connects the console port of the switch to a computer. Obtain an RJ45-to-DB-25 female DTE adapter if you want to connect the switch console port to a terminal.

[Table 186](#) lists the pinouts for the console port, the RJ45-to-DB-9 adapter cable, and the console device.

**Table 186 - Pinouts with CB-9 Pin**

Switch Console Port (DTE)	RJ45-to-DB-9 Terminal Adapter	Console Device
Signal	DB-9 Pin	Signal
RTS	8	CTS
DTR	6	DSR
TxD	2	RxD
GND	5	GND
GND	5	GND
RxD	3	TxD
DSR	4	DTR
CTS	7	RTS



The following table lists the pinouts for the console port, RJ45-to-DB-25 female DTE adapter, and the console device.

The RJ45-to-DB-25 female DTE adapter is not supplied with the switch.

**Table 187 - Pinouts with DB-25 Pin**

Switch Console Port (DTE)	RJ45-to-DB-25 Terminal Adapter	Console Device
Signal	DB-25 Pin	Signal
RTS	5	CTS
DTR	6	DSR
TxD	3	RxD
GND	7	GND
GND	7	GND
RxD	2	TxD
DSR	20	DTR
CTS	4	RTS

## PoE Port Cable Specifications

For PoE ports, use a Category 5 (Cat 5) cable with a distance of up to 100 m (328 ft).

**Notes:**

**A**

- access Device Manager** 48
- access management** 74
- access port**
  - choose 53
  - VLAN 0 priority tagging 250
- ACLs** 76 . . . 80
- adapter pinouts**
  - RJ45-to-DB-25 adapter 457
  - RJ45-to-DB-9 adapter 456
  - terminal
    - RJ45-to-DB-25 439, 445
    - RJ45-to-DB-9 439, 445
- address aliasing** 159
- address translation** 167, 207
- alert log** 309
- allocation, memory** 28
- announce interval** 98
- assign VLAN to NAT instance** 173
- Auto mode, PoE** 240
- auto-logout** 48
- auto-MDIX** 455
- autonegotiation**
  - Duplex mode 52, 150
  - speed 52, 150
  - troubleshoot 342

**B**

- Boundary mode** 87, 90
- BPDU Guard** 281
- broadcast storms** 233

**C**

- cable diagnostics** 309
- cables**
  - connect to 10BASE-T and 100BASE-TX compatible devices 453
  - connect to console port 456
  - connect to dual-purpose ports 455
  - connect to fiber ports 455
  - crossover 436, 437, 442, 443, 448, 449
  - damaged 339
  - Ethernet and fiber 339
  - identify 453
  - PoE module specifications 457
  - straight-through 436, 442, 448
- channel group, PRP** 220, 312
- CIP**
  - data 46
  - enable for active ring DHCP server 121
  - enable on VLAN 40
- CIP Sync Time Synchronization**
  - compatible switches 16
  - overview 86
- Cisco Discovery Protocol** 334

**CLI**

- access via console port 73
- access via SSH 40, 73
- access via Telnet 73

**clock modes**

- Boundary 87, 97
- End to End Transparent 87, 99
- Forward 87, 99
- NTP-PTP 88, 100

**connection faults** 60**connectors and cables**

- 10/100/1000 436, 442, 448, 449, 453, 454
- console 439, 445, 456, 457
- dual-purpose 443, 455
- SC connectors 455
- SFP module ports 455

**console port**

- specifications 439, 445, 456, 457

**crossover cable** 437, 443, 449, 454**cryptographic IOS software** 103**customization**

- DHCP server 133, 136
- IP address
  - DHCP IP address pool 134, 135
  - switch port 135
- IP address (for connected devices) 133
- IP address for connected devices 136
- Smartport roles 268

**D****default gateway**

- NAT 167, 179, 191, 202

**default router** 135**delay request interval** 98**denial-of-service attack** 233**Device Manager**

- access 48
- auto-logout 48
- hardware requirements 47
- overview 47
- software requirements 47

**Device-level ring. See DLR****DHCP**

- clients 322
- for ring devices 16, 113
- IP address pool 134, 136, 137
- persistence 131, 135, 136
- server 131
- status 322
- troubleshoot 341

**DLR**

- active DHCP server IP address 121
- compatible switches 16
- configure via Device Manager 119
- configure via Logix Designer application 123
- considerations 107
- DHCP 113, 128
- enable CIP 121
- multiple VLANs 105
- overview 104
- redundant gateways 108, 127
- status 323

**DNS server1 and 2** 135**domain name** 135**DOT1Q standard** 250**driver, Ethernet** 207**dual-purpose ports**

- connectors and cables 443, 455

**Duplex mode**

- default 52, 150
- setting 52, 150
- troubleshoot 342

**E****EIGRP** 140 . . . 145**End to End Transparent mode** 87, 92, 99**EtherChannels**

- configure via Device Manager 148
- configure via Logix Designer application 151
- example 147
- overview 146

**Ethernet drive** 207**EtherNet/IP CIP interface** 13**EtherNet/IP protocol** 268, 320**Express Setup**

- button 29
- global macro 44
- Long Press mode 35
- Medium Press mode 34
- modes 32
- Multi-mode 32
- requirements 28
- Short Press mode 33
- Single-mode 36

**F****factory default settings** 35, 344**Fault/Program action** 60**Feature mode** 153**firmware upgrade, troubleshoot** 344**Forward mode** 87, 94**frame size** 161**frequency bands** 154**Full-duplex mode** 52, 150**G****global macros**

- for CIP traffic 44
- for motion traffic 44, 162

**global navigation satellite system. See GNSS****GNSS** 21, 154, 155, 156**GNSS status** 299**GPS status indicator** 299**GSD file** 251, 254**H****Half-duplex mode** 52, 150**hardware features** 19**hardware requirements**

- Device Manager 47

**high priority PoE ports** 238**horizontal stacking** 157**HSR**

- compatible switches 16
- overview 156

**I****IEEE 802.1Q standard** 250**IEEE power classifications** 239**IGMP snooping**

- and address aliasing 159
- configure 160
- definition 159

**installation instructions** 12**IOS software**

- cryptographic 103
- non-cryptographic 103

**IP address**

- active ring DHCP server 121
- customization
  - connected devices 133, 136
  - DHCP IP address pool 134, 135
  - switch port 135
- DHCP IP address pool
  - ending range 135
  - starting range 134
- switch port 135
  - assigning 135
  - deleting 135
  - modifying 135
- translation 167
- troubleshoot 341
  - DHCP 341
  - wrong IP address 341

**L****LC connector** 455**lease length** 135**link integrity, verify with REP** 258**Link Layer Discovery Protocol** 334**Linx-based software** 45, 207**lite versus full firmware** 15

**locate switch**  
 via Device Manager 292  
 via Logix Designer application 306

**logout** 48

**Long Press mode Express Setup**  
 overview 32  
 run 35

**low priority PoE ports** 238

## M

**macros**

default global 162  
 Motion Prioritized QoS 162  
 QoS Priority Map 162  
 QoS Priority Queue 162

**management interface**

NAT 174

**management VLAN** 43, 284

**Medium Press mode Express Setup**

overview 32  
 requirements 28  
 run 34

**memory** 28

**MIBs, supported** 266

**mismatch prevention, Smartport roles** 269

**mode**

Access 268  
 Boundary 87, 90, 97  
 DLR 119, 120  
 dual power 83  
 End to End Transparent 87, 92, 99  
 EtherChannel 147, 148  
 Express Setup 32  
 Feature 153  
 Forward 87, 94, 99  
 NTP-PTP Clock 88, 95, 100  
 Over-determined Clock 155  
 Plug-n-Play 37  
 PoE 240, 245, 248  
 Program 60  
 REP 259  
 Restrict 228  
 Self-survey 155  
 STP 281, 282  
 Trunk 269

**module-defined data types** 347

**monitor**

alert log 309  
 CIP 320  
 DHCP clients 322  
 DLR 323  
 GNSS/GPS 299  
 NAT statistics 313  
 neighbors 334  
 port diagnostics 331  
 port mirroring 225  
 PROFINET 254  
 PRP 327

**Motion Prioritized QoS macro** 162

**MTU** 16, 161

**multicast storm** 233

**Multi-mode Express Setup**

overview 32  
 requirements 28

**Multiple Spanning Tree Protocol (MSTP)** 278

**multiple VLANs for DLR** 105

## N

**NAT**

configuration considerations 174  
 configuration overview 167  
 configure via Device Manager Web interface  
 175 . . . 186  
 configure via Logix Designer application  
 187, 198, 199  
 definition 167  
 diagnostics 313, 316 . . . 318  
 management interface 174  
 traffic permits and fixups 175, 186, 198  
 translation entry types 172

**native VLAN** 286

**NetFlow**

compatible switches 17  
 configuration 165  
 overview 163  
 templates 164

**network address translation. See NAT**

**network settings**

configure via Device Manager 37, 39  
 configure via Logix Designer application 42

**NTP**

configure via Device Manager 208  
 overview 208

**NTP-PTP Clock mode** 88, 95, 100

## O

**OSPF** 212 . . . 218

compatible switches 17

**Over-determined Clock mode, GNSS** 155

## P

**Per VLAN Spanning Tree Plus (PVST+)** 278

**pinouts**

10/100 ports 455  
 crossover cables 454  
 four twisted-pair, 1000BASE-T ports  
 437, 443, 449  
 PoE 441, 453  
 RJ45-to-DB-25 adapter 457  
 RJ45-to-DB-25 terminal adapter 439, 445  
 RJ45-to-DB-9  
 adapter 456  
 terminal adapter 439, 445  
 SFP module 455  
 straight-through cables  
 two twisted-pair 436, 442, 448, 453

**Plug-n-Play setup mode** 37

**PoE**

- cable specifications 457
- compatible switches 17
- configure via Device Manager Web interface 238
- features 238 . . . 243
- initial power allocation 239
- pinouts 441, 453
- power management modes 240
- powered device detection 239

**pool name** 135**pop-up blockers** 48**port**

- assignments for CIP data 405, 413
- configuration 59
- numbering 52
- roles 270
- security 227, 229
- states 60
- status 308
- threshold 235
- thresholds 236
- type 259

**port mirroring**

- configure via Device Manager 226
- overview 225

**port settings**

- auto-MDIX 52
- description 52, 150
- descriptions of 51
- Duplex mode 52, 150
- enable/disable 52
  - default 52
- speed 52, 150
  - default 52, 150

**PortFast** 281**power classifications** 239**power priority** 245**PPR**

- configuration considerations 222

**priority tagging** 249, 286, 287**PROFINET**

- compatible switches 17
- enable 252, 253
- GSD file 251
- monitor 254
- overview 249
- Real-Time (RT) 249
- TCP/IP 249
- traffic forwarding 249
- VLAN 0 priority tagging 249

**Program mode** 60**proxy settings** 48**PRP**

- channel group 220
- configuration 222
- node and VDAN limitations 221
- overview 219
- port statistics 312
- RedBox 219, 222
- status 327
- traffic and supervisory frames 221
- troubleshoot 225

**PTP**

- compatible switches 16
- configure via Device Manager 89
- configure via Logix Designer application 96
- overview 86

**PTP modes**

- Boundary 87, 97
- End to End Transparent 87, 99
- Forward 87, 99
- NTP-PTP Clock 88, 100

**Q****QoS Priority Map macro** 162**QoS Priority Queue macro** 162**QoS settings**

- default 44, 162
- motion traffic 162

**R****Rapid per VLAN Spanning Tree Plus (Rapid PVST+)** 278**Real-Time (RT) PROFINET traffic** 249**receiver, GNSS** 154**recovery**

- firmware upgrade 344

**RedBox** 219, 222**redundancy**

- EtherChannel 148

**redundant gateway** 108 . . . 112, 123, 323, 325**remote connection** 74**REP** 255

- open segment 256
- ring segment 257
- segments 257
- verify link integrity 258

**REP Admin VLAN** 259**REP segments**

- configure 259
- overview 255

**reset factory defaults** 344**reset, troubleshoot** 344**Resilient Ethernet Protocol**

- see REP 255

**restart with factory default settings** 35**RJ45 connector, console port** 456**RSWho** 45**S****satellite constellation** 154**SC connector** 455**SD card**

- synchronize
  - configuration 66
  - synchronize IOS files 66

**SD Flash Sync** 70

- SDM template** 263
  - security**
    - configure for ports 229
    - violations 228
  - segment ID** 259
  - Self-survey mode, GNSS** 155
  - settings, factory default** 35
  - SFP modules**
    - connectors 455
  - Short Press mode Express Setup**
    - overview 32
    - run 33
  - signaling, GNSS** 155
  - Single-mode Express Setup**
    - run 36
  - Smartport roles**
    - applying 270
    - changing VLAN memberships 270
    - customization
      - optimize ports 268
      - mismatch prevention 269
  - Smartport roles and VLANs** 276
  - SNMP**
    - configuring 267
    - MIBs supported 266
  - snooping, DHCP** 113, 121, 129
  - snooping, IGMP** 159
  - software features** 16
    - customization
      - DHCP server settings 133, 136
      - Smartport roles 268
    - troubleshoot
      - firmware upgrade 71
  - software requirements**
    - Device Manager 47
  - Spanning Tree Protocol** 255, 278
    - See also Rapid Spanning Tree Protocol
  - specifications** 12
  - speed**
    - setting 52, 150
    - troubleshoot 342
  - SSH** 73, 74
  - stacking, horizontal** 157
  - Static mode, PoE** 241
  - status indicators**
    - Stratix 5400 296, 297
    - Stratix 5410 299, 300
    - Stratix 8000/8300 301, 302
    - Stratix and ArmorStratix 5700 293, 294
  - STCN interface** 260
  - STCN segment** 260
  - STCN STP** 260
  - storm control**
    - described 233
    - thresholds 233
  - STP**
    - BPDU Guard 281
    - configure via Device Manager 279
    - configure via Logix Designer application 282
    - MSTP 278
    - overview 278
    - PortFast 281
    - PVST+ 278
    - Rapid PVST+ 278
  - straight-through cable**
    - pinout
      - two twisted-pair 10/100 ports 436, 437, 442, 443, 448, 449, 453, 454
  - subnet mask**
    - DHCP IP address pool 134
  - subnet translation** 172, 179, 183, 185, 189, 193
  - switch**
    - configuration properties 58
    - installation
      - troubleshoot 338
    - installation instructions 12
    - manage via Device Manager 47
    - monitor
      - alert log 309
      - port mirroring 225
    - status 305
    - troubleshoot 337
      - Device Manager display 341
      - DHCP 341
      - firmware upgrade 344
      - IP address problems 341
      - reset switch 344
      - wrong IP address 341
  - sync interval** 98
  - sync limit** 98
- T**
- tagging** 286, 287
  - TCP/IP PROFINET traffic** 249
  - Telnet** 73, 74
  - threshold**
    - port 235
    - traffic level 233
  - time synchronization**
    - configure via Device Manager 89
    - configure via Logix Designer application 96
  - timing message settings** 89, 96
  - traffic fixups and NAT** 175, 186, 198
  - traffic permits and NAT** 175, 186, 198
  - traffic suppression** 233
  - translate IP addresses** 167
  - translation entry types** 172

**troubleshoot**

- Device Manager display 341
- DHCP 341
- firmware upgrade 71, 344
- IP address problems 341
- PRP 225
- reset switch 344
- speed, duplex, and autonegotiation 342
- switch 337
- switch performance 342
- wrong IP address 341

**trunk port**

- choose 53
- VLAN 0 priority tagging 250

**U**

**unicast storm** 233

**upgrade firmware** 71

**V**

**VLAN 0 priority tagging**

- enable 52, 287
- for PROFINET 249, 250
- overview 286
- priority values 287

**VLAN memberships**

- changing 270
- prerequisite 270

**VLANs**

- access VLAN 53
- allowed 53
- assign to NAT instance 173, 178, 182, 189, 192
- configure via Device Manager 284
- configure via Logix Designer application 284
- enable CIP 40
- management VLAN 284
- multiple for DLR 105
- native VLAN 53, 286
- overview 283
- tagging 286





## Rockwell Automation Support

Use the following resources to access support information.

<b>Technical Support Center</b>	Knowledgebase Articles, How-to Videos, FAQs, Chat, User Forums, and Product Notification Updates.	<a href="https://rockwellautomation.custhelp.com/">https://rockwellautomation.custhelp.com/</a>
<b>Local Technical Support Phone Numbers</b>	Locate the phone number for your country.	<a href="http://www.rockwellautomation.com/global/support/get-support-now.page">http://www.rockwellautomation.com/global/support/get-support-now.page</a>
<b>Direct Dial Codes</b>	Find the Direct Dial Code for your product. Use the code to route your call directly to a technical support engineer.	<a href="http://www.rockwellautomation.com/global/support/direct-dial.page">http://www.rockwellautomation.com/global/support/direct-dial.page</a>
<b>Literature Library</b>	Installation Instructions, Manuals, Brochures, and Technical Data.	<a href="http://www.rockwellautomation.com/global/literature-library/overview.page">http://www.rockwellautomation.com/global/literature-library/overview.page</a>
<b>Product Compatibility and Download Center (PCDC)</b>	Get help determining how products interact, check features and capabilities, and find associated firmware.	<a href="http://www.rockwellautomation.com/global/support/pcdc.page">http://www.rockwellautomation.com/global/support/pcdc.page</a>

## Documentation Feedback

Your comments will help us serve your documentation needs better. If you have any suggestions on how to improve this document, complete the How Are We Doing? form at [http://literature.rockwellautomation.com/idc/groups/literature/documents/du/ra-du002\\_-en-e.pdf](http://literature.rockwellautomation.com/idc/groups/literature/documents/du/ra-du002_-en-e.pdf).

Rockwell Automation maintains current product environmental information on its website at <http://www.rockwellautomation.com/rockwellautomation/about-us/sustainability-ethics/product-environmental-compliance.page>.

Allen-Bradley, ArmorStratix, Rockwell Automation, Rockwell Software, RSLogix 5000, RSNetWorx, Stratix, Studio 5000, and Studio 5000 Logix Designer are trademarks of RockwellAutomation, Inc.

Trademarks not belonging to Rockwell Automation are property of their respective companies.

Rockwell Otomasyon Ticaret A.Ş., Kar Plaza İş Merkezi E Blok Kat:6 34752 İçerenköy, İstanbul, Tel: +90 (216) 5698400

**[www.rockwellautomation.com](http://www.rockwellautomation.com)**

### Power, Control and Information Solutions Headquarters

Americas: Rockwell Automation, 1201 South Second Street, Milwaukee, WI 53204-2496 USA, Tel: (1) 414.382.2000, Fax: (1) 414.382.4444

Europe/Middle East/Africa: Rockwell Automation NV, Pegasus Park, De Kleetlaan 12a, 1831 Diegem, Belgium, Tel: (32) 2 663 0600, Fax: (32) 2 663 0640

Asia Pacific: Rockwell Automation, Level 14, Core F, Cyberport 3, 100 Cyberport Road, Hong Kong, Tel: (852) 2887 4788, Fax: (852) 2508 1846

Publication 1783-UM007J-EN-P - March 2018

Supersedes Publication 1783-UM007I-EN-P - December 2017

Copyright © 2018 Rockwell Automation, Inc. All rights reserved. Printed in the U.S.A.