

Compact I/O Thermocouple/mV Input Module



Allen-Bradley

Catalog Numbers 1769-IT6

User Manual



Important User Information

Solid state equipment has operational characteristics differing from those of electromechanical equipment. Safety Guidelines for the Application, Installation and Maintenance of Solid State Controls (publication [SGI-1.1](http://www.rockwellautomation.com/literature/) available from your local Rockwell Automation sales office or online at <http://www.rockwellautomation.com/literature/>) describes some important differences between solid state equipment and hard-wired electromechanical devices. Because of this difference, and also because of the wide variety of uses for solid state equipment, all persons responsible for applying this equipment must satisfy themselves that each intended application of this equipment is acceptable.

In no event will Rockwell Automation, Inc. be responsible or liable for indirect or consequential damages resulting from the use or application of this equipment.

The examples and diagrams in this manual are included solely for illustrative purposes. Because of the many variables and requirements associated with any particular installation, Rockwell Automation, Inc. cannot assume responsibility or liability for actual use based on the examples and diagrams.

No patent liability is assumed by Rockwell Automation, Inc. with respect to use of information, circuits, equipment, or software described in this manual.

Reproduction of the contents of this manual, in whole or in part, without written permission of Rockwell Automation, Inc., is prohibited.

Throughout this manual, when necessary, we use notes to make you aware of safety considerations.



WARNING: Identifies information about practices or circumstances that can cause an explosion in a hazardous environment, which may lead to personal injury or death, property damage, or economic loss.



ATTENTION: Identifies information about practices or circumstances that can lead to personal injury or death, property damage, or economic loss. Attentions help you identify a hazard, avoid a hazard, and recognize the consequence



SHOCK HAZARD: Labels may be on or inside the equipment, for example, a drive or motor, to alert people that dangerous voltage may be present.



BURN HAZARD: Labels may be on or inside the equipment, for example, a drive or motor, to alert people that surfaces may reach dangerous temperatures.

IMPORTANT

Identifies information that is critical for successful application and understanding of the product.

Allen-Bradley, Rockwell Software, Rockwell Automation, Compact I/O, MicroLogix, CompactLogix, RSLogix 500, RSLogix 5000, RSNetWorx, and TechConnect are trademarks of Rockwell Automation, Inc.

Trademarks not belonging to Rockwell Automation are property of their respective companies.

We have added an Important statement about the placement of the 1769-IT6 module with regard to the Compact I/O power supplies on [page 18](#).

To help you find new and updated information in this release of the manual, we have included change bars as shown to the right of this paragraph. 

Notes:

	Preface	
	Who Should Use This Manual	9
	Additional Resources	9
	Conventions Used in This Manual	9
	Chapter 1	
Overview	General Description	11
	Thermocouple/mV Inputs and Ranges	11
	Data Formats	12
	Filter Frequencies	12
	Hardware Features	12
	General Diagnostic Features	14
	System Overview	14
	System Operation	14
	Module Operation	15
	Module Field Calibration	16
	Chapter 2	
Quick Start for Experienced Users	Before You Begin	17
	Required Tools and Equipment	17
	What You Need to Do	17
	Chapter 3	
Installation and Wiring	Compliance to European Union Directives	23
	EMC Directive	23
	Low Voltage Directive	23
	Power Requirements	24
	General Considerations	24
	Hazardous Location Considerations	24
	Preventing Electrostatic Discharge	25
	Removing Power	25
	Selecting a Location	25
	System Assembly	27
	Mounting	28
	Minimum Spacing	28
	Panel Mounting	28
	DIN Rail Mounting	29
	Replace a Single Module within a System	30

Module Data, Status, and Channel Configuration

Field Wiring Connections 30
 System Wiring Guidelines 30
 Terminal Door Label 32
 Removing and Replacing the Terminal Block 32
 Wire the Finger-safe Terminal Block 33
 Wire the Module 34
 Cold Junction Compensation 36
 Calibration 36

Chapter 4

Module Memory Map 37
 Accessing Input Image File Data 38
 Input Data File 38
 Input Data Values 38
 General Status Bits (S0 through S7) 39
 Open-circuit Flag Bits (OC0 through OC7) 39
 Over-range Flag Bits (O0 through O7) 40
 Under-range Flag Bits (U0 through U7) 40
 Configuring Channels 40
 Configuration Data File 41
 Channel Configuration 42
 Enabling or Disabling a Channel (bit 15) 43
 Selecting Data Formats (bits 14...12) 43
 Selecting Input Type (bits 11...8) 45
 Selecting Temperature Units (bit 7) 45
 Determining Open-circuit Response (bits 6 and 5) 46
 Selecting Input Filter Frequency (bits 2...0) 46
 Selecting Enable/Disable Cyclic Calibration (word 6, bit 0) 50
 Determining Effective Resolution and Range 50
 Determining Module Update Time 69
 Effects of Autocalibration on Module Update Time 70
 Calculating Module Update Time 71
 Impact of Autocalibration on Module Startup
 During Mode Change 73

Diagnostics and Troubleshooting

Chapter 5

Safety Considerations 75
 Indicator Lights 75
 Stand Clear of Equipment 75
 Program Alteration 76
 Safety Circuits 76
 Module Operation versus Channel Operation 76
 Power-up Diagnostics 76

	Channel Diagnostics.....	77
	Invalid Channel Configuration Detection	77
	Over-range or Under-range Detection.....	77
	Open-circuit Detection	77
	Non-critical versus Critical Module Errors	78
	Module Error Definition.....	78
	Module Error Field	78
	Extended-error Information Field.....	79
	Error Codes.....	80
	Module Inhibit Function	82
	Contacting Rockwell Automation	82
	 Appendix A	
Specifications	Accuracy versus Thermocouple Temperature and Filter Frequency ...	87
	Temperature Drift	105
	 Appendix B	
Two's Complement Binary Numbers	Positive Decimal Values.....	111
	Negative Decimal Values.....	112
	 Appendix C	
Thermocouple Descriptions	International Temperature Scale of 1990.....	113
	Type B Thermocouples	113
	Type E Thermocouples	115
	Type J Thermocouples.....	117
	Type K Thermocouples.....	119
	Type N Thermocouples.....	121
	Type R Thermocouples	123
	Type S Thermocouples	124
	Type T Thermocouples.....	126
	References	129
	 Appendix D	
Using Thermocouple Junctions	Using a Grounded Junction Thermocouple.....	135
	Using an Ungrounded (isolated) Junction Thermocouple	137
	Using an Exposed Junction Thermocouple	137
	 Appendix E	
Module Configuration by Using a MicroLogix 1500 System and RSLogix 500 Software	Module Addressing.....	139
	1769-IT6 Configuration File	140
	Configuring the 1769-IT6 Module in a MicroLogix 1500 System ...	141

Configuring Your 1769-IT6 Module with the Generic Profile for CompactLogix Controllers in RSLogix 5000 Software	Appendix F
	Configuring I/O Modules..... 148
	Configuring a 1769-IT6 Thermocouple Module..... 150
Configuring Your 1769-IT6 Module in a Remote DeviceNet System with a 1769-ADN DeviceNet Adapter	Appendix G
	Configuring the 1769-IT6 Module 154
Glossary	
Index	

Read this preface to familiarize yourself with the rest of the manual.

Who Should Use This Manual

Use this manual if you are responsible for designing, installing, programming, or troubleshooting control systems that use Allen-Bradley Compact I/O and/or compatible controllers, such as MicroLogix 1500 or CompactLogix.

Additional Resources

These documents contain additional information concerning related Rockwell Automation products.

Resource	Description
MicroLogix 1500 User Manual, publication 1764-UM001	A user manual containing information on how to install, use, and program your MicroLogix 1500 controller
1769-ADN DeviceNet Adapter User Manual, publication 1769-UM001	An overview of the Compact I/O system
CompactLogix User Manual, publication 1769-UM007	A user manual that contains information on installing, using, and programming CompactLogix controllers
Programmable Controller Grounding and Wiring Guidelines, publication 1770-4.1	In-depth information on grounding and wiring Allen-Bradley programmable controllers

You can view or download publications at <http://www.rockwellautomation.com/literature>. To order paper copies of technical documentation, contact your local Rockwell Automation distributor or sales representative.

Conventions Used in This Manual

These conventions are used throughout this manual:

- Bulleted lists (like this one) provide information not procedural steps.
- Numbered lists provide sequential steps or hierarchical information.
- **Bold** type is used for emphasis.

Notes:

Overview

This chapter describes the 1769-IT6 Thermocouple/mV Input Module and explains how the module reads thermocouple or millivolt analog input data. Included is information about:

- the module's hardware and diagnostic features.
- an overview of system and module operation.
- compatibility.

General Description

The thermocouple/mV input module supports thermocouple and millivolt signal measurement. It digitally converts and stores thermocouple and/or millivolt analog data from any combination of up to six thermocouple or millivolt analog sensors. Each input channel is individually configurable via software for a specific input device, data format and filter frequency, and provides open-circuit, over-range and under-range detection and indication.

Thermocouple/mV Inputs and Ranges

The table below defines thermocouple types and their associated full-scale temperature ranges. The second table lists the millivolt analog input signal ranges that each channel will support. To determine the practical temperature range your thermocouple supports, see the specifications in [Appendix A](#).

Thermocouple Type	°C Temperature Range	°F Temperature Range
J	-210...1200 °C	-346...2192 °F
K	-270...1370 °C	-454...2498 °F
T	-270...400 °C	-454...752 °F
E	-270...1000 °C	-454...1832 °F
R	0...1768 °C	32...3214 °F
S	0...1768 °C	32...3214 °F
B	300...1820 °C	572...3308 °F
N	-210...1300 °C	-346...2372 °F
C	0...2315 °C	32...4199 °F
CJC Sensor	0...85 °C	32...185 °F

Millivolt Input Type	Range
± 50 mV	-50...50 mV
± 100 mV	-100...100 mV

Data Formats

The data can be configured on board each module as:

- engineering units x 1.
- engineering units x 10.
- scaled-for-PID.
- percent of full-scale.
- raw/proportional data.

Filter Frequencies

The module uses a digital filter that provides high frequency noise rejection for the input signals. The filter is programmable, allowing you to select from these six different filter frequencies for each channel:

- 10 Hz
- 50 Hz
- 60 Hz
- 250 Hz
- 500 Hz
- 1000 Hz

Hardware Features

The module contains a removable terminal block. Channels are wired as differential inputs. Two cold junction compensation (CJC) sensors are attached to the terminal block to enable accurate readings from each channel. These sensors compensate for offset voltages introduced into the input signal as a result of the cold-junction where the thermocouple wires are connected to the module.

Module configuration is normally done via the controller's programming software. In addition, some controllers support configuration via the user program. In either case, the module configuration is stored in the memory of the controller. Refer to your controller's user manual for more information.

Figure 1 - Hardware Features

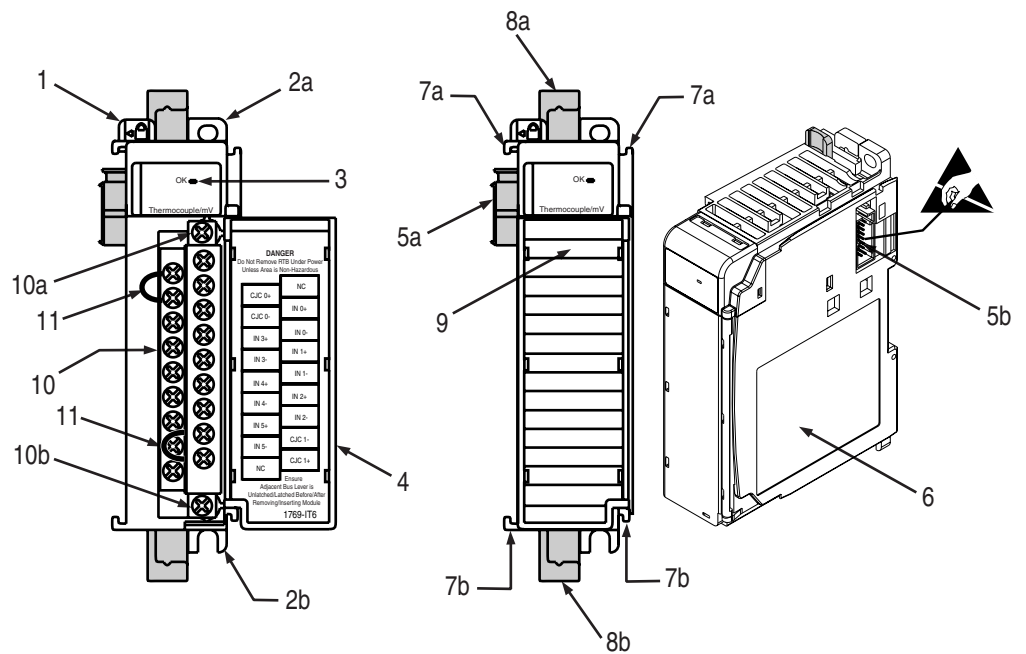

Item	Description
1	Bus lever
2a	Upper-panel mounting tab
2b	Lower-panel mounting tab
3	Module status indicator
4	Module door with terminal identification label
5a	Movable bus connector (bus interface) with female pins
5b	Stationary bus connector (bus interface) with male pins
6	Nameplate label
7a	Upper tongue-and-groove slots
7b	Lower tongue-and-groove slots
8a	Upper DIN-rail latch
8b	Lower DIN-rail latch
9	Write-on label for user identification tags
10	Removable terminal block (RTB) with finger-safe cover
10a	RTB upper-retaining screw
10b	RTB lower-retaining screw
11	CJC sensors

General Diagnostic Features

The module contains a diagnostic status indicator that helps you identify the source of anomalies that may occur during powerup or during normal channel operation. The status indicator indicates both status and power. Power-up and channel diagnostics are explained in [Chapter 5, Diagnostics and Troubleshooting](#).

System Overview

The modules communicate to the controller through the bus interface. The modules also receive 5 and 24V DC power through the bus interface.

System Operation

At powerup, the module performs a check of its internal circuits, memory, and basic functions. During this time, the module status indicator remains off. If no faults are found during power-up diagnostics, the module status indicator is turned on.

After power-up checks are complete, the module waits for valid channel configuration data. If an invalid configuration is detected, the module generates a configuration error. Once a channel is properly configured and enabled, it continuously converts the thermocouple or millivolt input to a value within the range selected for that channel.

Each time a channel is read by the input module, that data value is tested by the module for an over-range, under-range, open-circuit, or 'input data not valid' condition. If such a condition is detected, a unique bit is set in the channel status word. The channel status word is described in [Input Data File on page 38](#).

By using the module image table, the controller reads the two's complement binary converted thermocouple or millivolt data from the module. This typically occurs at the end of the program scan or when commanded by the control program. If the controller and the module determine that the data transfer has been made without error, the data is used in the control program.

Module Operation

When the module receives a differential input from an analog device, the module's circuitry multiplexes the input into an A/D converter. The converter reads the signal and converts it as required for the type of input. The module also continuously samples the CJC sensors and compensates for temperature changes at the terminal block cold junction, between the thermocouple wire and the input channel.

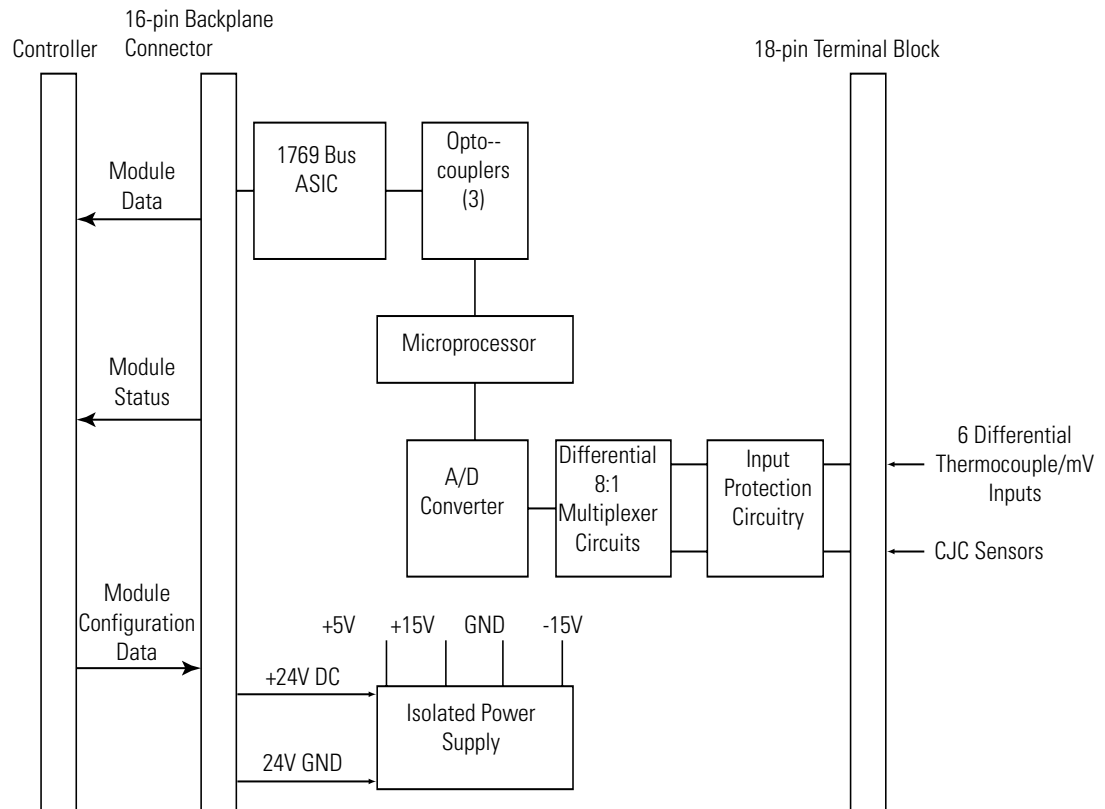

Each channel can receive input signals from a thermocouple or millivolt analog input device, depending upon how you configured the channel.

When configured for thermocouple input types, the module converts the analog input voltages into cold-junction compensated and linearized digital temperature readings. The module uses the National Institute of Standards and Technology (NIST) ITS-90 standard for linearization for all thermocouple types (J, K, T, E, R, S, B, N, C).

When configured for millivolt inputs, the module converts the analog values directly into digital counts.

Module Field Calibration

The module provides autocalibration, which compensates for offset and gain drift of the A/D converter caused by a temperature change within the module. An internal, high-precision, low drift voltage and system ground reference is used for this purpose. The input module performs autocalibration when a channel is initially enabled. In addition, you can program the module to perform a calibration cycle once every 5 minutes. See [Selecting Enable/Disable Cyclic Calibration \(word 6, bit 0\) on page 50](#) for information on configuring the module to perform periodic autocalibration.

Quick Start for Experienced Users

Before You Begin

This chapter can help you to get started using the 1769-IT6 thermocouple/mV input module. We base the procedures here on the assumption that you have an understanding of Allen-Bradley controllers. You should understand electronic process control and be able to interpret the ladder logic instructions required to generate the electronic signals that control your application.

Because it is a start-up guide for experienced users, this chapter does not contain detailed explanations about the procedures listed. It does, however, reference other chapters in this book where you can get more information about applying the procedures described in each step.

If you have any questions or are unfamiliar with the terms used or concepts presented in the procedural steps, always read the referenced chapters and other recommended documentation before trying to apply the information.

Required Tools and Equipment

Have these tools and equipment ready:

- Medium blade or cross-head screwdriver
- Thermocouple or millivolt analog input device
- Shielded, twisted-pair cable for wiring (Belden 8761 or equivalent for millivolt inputs, or shielded thermocouple extension wire for thermocouple inputs)
- Controller (for example, a MicroLogix 1500 or CompactLogix controller)
- Programming device and software (for example, RSLogix 500 or RSLogix 5000 software)

What You Need to Do

This chapter covers this information.

1. [Be sure that your 1769 system power supply has sufficient current output to support your system configuration.](#)
2. [Attach and lock the module.](#)
3. [Wire the module.](#)
4. [Configure the module.](#)
5. [Go through the start-up procedure.](#)
6. [Monitor the module status to check if the module is operating correctly.](#)

Step 1	Be sure that your 1769 system power supply⁽¹⁾ has sufficient current output to support your system configuration.	Reference Chapter 3 (Installation and Wiring)
---------------	---	--

(1) The system power supply could be catalog number 1769-PA2, 1769-PB2, 1769-PA4, 1769-PB4, or the internal supply of the MicroLogix 1500 packaged controller.

The module's maximum current draw is:

- 100 mA for 5V DC.
- 40 mA for 24V DC.

Step 2	Attach and lock the module.	Reference Chapter 3 (Installation and Wiring)
---------------	------------------------------------	--

TIP The module can be panel or DIN rail mounted. Modules can be assembled before or after mounting.



ATTENTION: Remove power before removing or inserting this module. If you remove or insert a module with power applied, an electrical arc may occur.

IMPORTANT To reduce the effects of electrical noise, install the 1769-IT6 module at least two slots away from Compact I/O 120/240V AC power supplies.

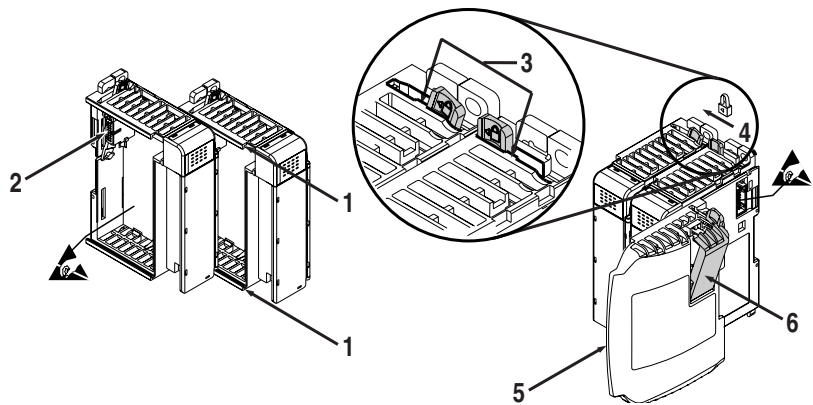

1. Check that the bus lever of the module to be installed is in the unlocked (fully right) position.
2. Use the upper and lower tongue-and-groove slots (1) to secure the modules together (or to a controller).
3. Move the module back along the tongue-and-groove slots until the bus connectors (2) line up with each other.
4. Push the bus lever back slightly to clear the positioning tab (3) by using your fingers or a small screwdriver.
5. Move the bus lever fully to the left (4) until it clicks to allow communication between the controller and module.

Be sure the bus lever is locked firmly in place.



ATTENTION: When attaching I/O modules, it is very important that the bus connectors are securely locked together to be sure of proper electrical connection.

6. Attach an end cap terminator (5) to the last module in the system by using the tongue-and-groove slots as before.
7. Lock the end cap bus terminator (6).

IMPORTANT A 1769-ECR or 1769-ECL right or left end cap respectively must be used to terminate the end of the 1769 communication bus.

Step 3	Wire the module.	Reference Chapter 3 (Installation and Wiring)
---------------	-------------------------	--

Follow these guidelines when wiring the module:

General Guidelines

- Power and input wiring must be in accordance with Class I, Division 2 wiring methods, Article 501-4(b) of the National Electric Code, NFPA 70, and in accordance with the authority having jurisdiction.
- Channels are isolated from one another by $\pm 10V$ DC maximum.
- Route field wiring away from any other wiring and keep it as far as possible from sources of electrical noise, such as motors, transformers, contactors, and AC devices. As a general rule, allow at least 15.2 cm (6 in.) of separation for every 120V of power.
- Routing field wiring in a grounded conduit can reduce electrical noise.
- If field wiring must cross AC or power cables, be sure that they cross at right angles.
- If multiple power supplies are used with analog millivolt inputs, the power supply commons must be connected.

Terminal Block Guidelines

- Do not use the module's NC terminals as connection points.
- Do not tamper with or remove the CJC sensors on the terminal block. Removal of either one or both sensors will reduce accuracy.
- For millivolt sensors, use Belden 8761 shielded, twisted-pair wire (or equivalent) to be sure of proper operation and high immunity to electrical noise.
- For a thermocouple, use the shielded, twisted-pair thermocouple extension lead wires specified by the thermocouple manufacturer. Using the incorrect type of thermocouple extension wire or not following the correct polarity will cause invalid readings.

- To be sure of optimum accuracy, limit overall cable impedance by keeping a cable as short as possible. Locate the module as close to input devices as the application permits.

Grounding Guidelines



ATTENTION: The possibility exists that a grounded or exposed thermocouple can become shorted to a potential greater than that of the thermocouple itself. Due to possible shock hazard, take care when wiring grounded or exposed thermocouples. See [Appendix D](#), Using Thermocouple Junctions.

- This product is intended to be mounted to a well-grounded mounting surface such as a metal panel. Additional grounding connections from the module's mounting tabs or DIN rail (if used) are not required unless the mounting surface cannot be grounded.
- Keep cable shield connections to ground as short as possible.
- Ground the shield drain wire at one end only. The preferred location is as follows.
 - For grounded thermocouples or millivolt sensors, this is at the sensor end.
 - For insulated/ungrounded thermocouples, this is at the module end. Contact your sensor manufacturer for additional details.
- Refer to Industrial Automation Wiring and Grounding Guidelines, Allen-Bradley publication [1770-4.1](#), for additional information.

Figure 2 - Terminal Connections with CJC Sensors

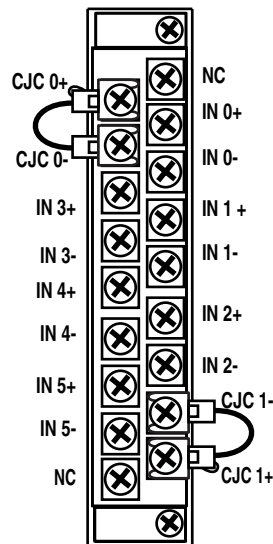

Step 4 Configure the module.	Reference Chapter 4 (Module Data, Status, and Channel Configuration)
--	---

The configuration file is typically modified by using the programming software compatible with your controller. It can also be modified through the control program, if supported by the controller. See [Channel Configuration on page 42](#) for more information.

Step 5 Go through the start-up procedure.	Reference Chapter 5 (Diagnostics and Troubleshooting)
---	--

1. Apply power to the controller system.
2. Download your program, which contains the thermocouple module configuration settings, to the controller.
3. Put the controller in Run mode.

During a normal startup, the module status indicator turns on.

TIP If the module status indicator does not turn on, cycle power. If the condition persists, contact your local distributor or Rockwell Automation for assistance.

Step 6 Monitor the module status to check if the module is operating correctly	Reference Chapter 5 (Diagnostics and Troubleshooting)
--	--

Module and channel configuration errors are reported to the controller. These errors are typically reported in the controller's I/O status file.

Channel status data is also reported in the module's input data table, so these bits can be used in your control program to flag a channel error.

Notes:

Installation and Wiring

This chapter tells you how to:

- determine the power requirements for the modules.
- avoid electrostatic damage.
- install the module.
- wire the module's terminal block.
- wire input devices.

Compliance to European Union Directives

This product is approved for installation within the European Union and EEA regions. It has been designed and tested to meet the following directives.

EMC Directive

The 1769-IT6 module is tested to meet Council Directive 89/336/EEC Electromagnetic Compatibility (EMC) and the following standards, in whole or in part, documented in a technical construction file:

- EN 50081-2
EMC—Generic Emission Standard, Part 2 - Industrial Environment
- EN 50082-2
EMC—Generic Immunity Standard, Part 2 - Industrial Environment

This product is intended for use in an industrial environment.

Low Voltage Directive

This product is tested to meet Council Directive 73/23/EEC Low Voltage, by applying the safety requirements of EN 61131-2 Programmable Controllers, Part 2 – Equipment Requirements and Tests.

For specific information required by EN61131-2, see the appropriate sections in this publication, as well as the Industrial Automation, Wiring and Grounding Guidelines for Noise Immunity, publication [1770-4.1](#).

Power Requirements

The module receives power through the bus interface from the 5/24V DC system power supply. The maximum current drawn by the module is:

- 100 mA at 5V DC.
- 40 mA at 24V DC.

General Considerations

Compact I/O modules are suitable for use in an industrial environment when installed in accordance with these instructions. Specifically, this equipment is intended for use in clean, dry environments (Pollution Degree 2⁽¹⁾) and to circuits not exceeding Over Voltage Category II⁽²⁾ (IEC 60664-1).⁽³⁾

Hazardous Location Considerations

This equipment is suitable for use in Class I, Division 2, Groups A, B, C, D or non-hazardous locations only. The following WARNING statement applies to use in hazardous locations.



WARNING: Explosion Hazard

- Substitution of components may impair suitability for Class I, Division 2.
 - Do not replace components or disconnect equipment unless power has been switched off or the area is known to be non-hazardous.
 - Do not connect or disconnect components unless power has been switched off or the area is known to be non-hazardous.
 - This product must be installed in an enclosure.
 - All wiring must comply with N.E.C. article 501-4(b).
-

(1) Pollution Degree 2 is an environment where, normally, only non-conductive pollution occurs except that occasionally a temporary conductivity caused by condensation shall be expected.

(2) Over Voltage Category II is the load level section of the electrical distribution system. At this level transient voltages are controlled and do not exceed the impulse voltage capability of the product's insulation.

(3) Pollution Degree 2 and Over Voltage Category II are International Electrotechnical Commission (IEC) designations.

Preventing Electrostatic Discharge



ATTENTION: Electrostatic discharge can damage integrated circuits or semiconductors if you touch analog I/O module bus connector pins or the terminal block on the input module. Follow these guidelines when you handle the module:

- Touch a grounded object to discharge static potential.
 - Wear an approved wrist-strap grounding device.
 - Do not touch the bus connector or connector pins.
 - Do not touch circuit components inside the module.
 - Use a static-safe work station, if available.
 - Keep the module in its static-shield bag when it is not in use.
-

Removing Power



ATTENTION: Remove power before removing or inserting this module. When you remove or insert a module with power applied, an electrical arc may occur. An electrical arc can cause personal injury or property damage by:

- sending an erroneous signal to your system's field devices, causing unintended machine motion.
 - causing an explosion in a hazardous environment.
- Electrical arcing causes excessive wear to contacts on both the module and its mating connector and may lead to premature failure.
-

Selecting a Location

Consider reducing noise and power supply distance when selecting a location.

Reducing Noise

Most applications require installation in an industrial enclosure to reduce the effects of electrical interference. Analog inputs are highly susceptible to electrical noise. Electrical noise coupled to the analog inputs will reduce the performance (accuracy) of the module.

Group your modules to minimize adverse effects from radiated electrical noise and heat. Consider the following conditions when selecting a location for the analog module. Position the module:

- away from sources of electrical noise such as hard-contact switches, relays, and AC motor drives.
- away from modules which generate significant radiated heat, such as the 1769-IA16 module. Refer to the module's heat dissipation specification.

In addition, route shielded, twisted-pair analog input wiring away from any high voltage I/O wiring.

Power Supply Distance

You can install as many modules as your power supply can support. However, all 1769 I/O modules have a power supply distance ratings. The maximum I/O module rating is eight, which means that a module may not be located more than eight modules away from the system power supply.

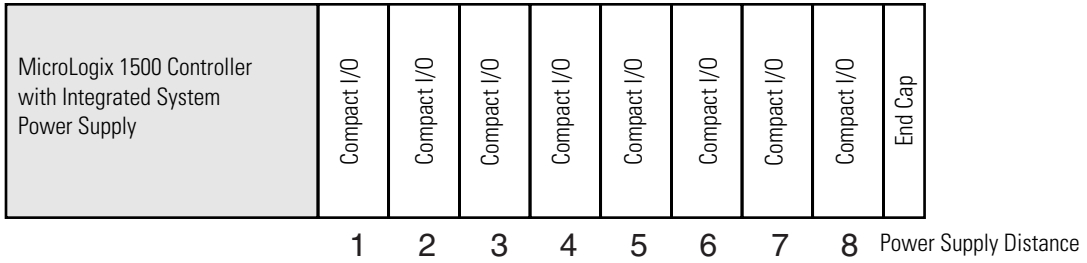

OR

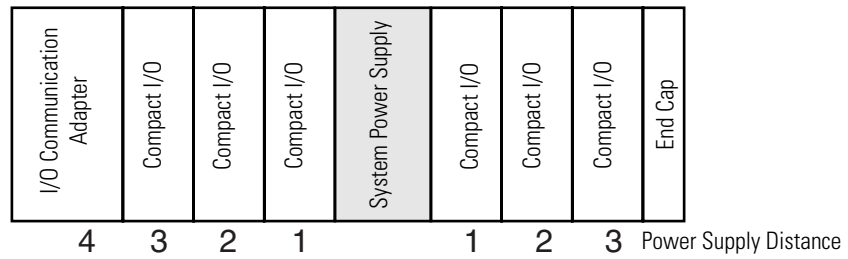

System Assembly

The module can be attached to the controller or an adjacent I/O module **before** or **after** mounting. For mounting instructions, see [Panel Mounting by Using the Dimensional Template on page 29](#), or [DIN Rail Mounting on page 29](#). To work with a system that is already mounted, see [Replace a Single Module within a System on page 30](#).

Follow this procedure to assemble the Compact I/O system.

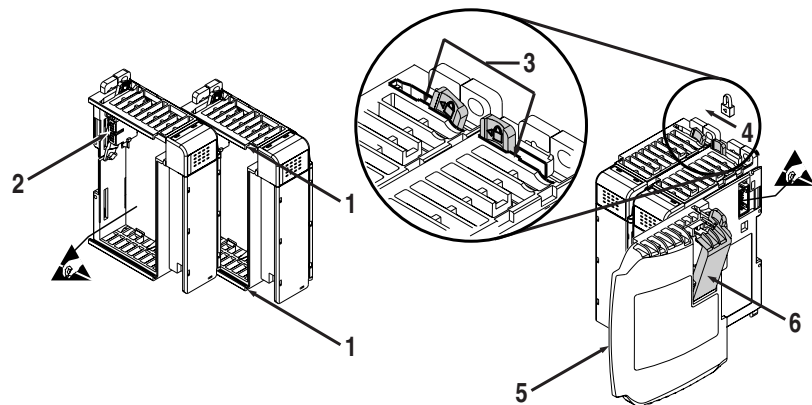

IMPORTANT To reduce the effects of electrical noise, install the 1769-IT6 module at least two slots away from the AC power supplies.

1. Disconnect power.
2. Check that the bus lever of the module to be installed is in the unlocked (fully right) position.

TIP If the module is being installed to the left of an existing module, check that the right-side adjacent module's bus lever is in the unlocked (fully right) position.
3. Use the upper and lower tongue-and-groove slots (1) to secure the modules together (or to a controller).
4. Move the module back along the tongue-and-groove slots until the bus connectors (2) line up with each other.
5. Push the bus lever back slightly to clear the positioning tab (3) by using your fingers or a small screwdriver.
6. To allow communication between the controller and module, move the bus lever fully to the left (4) until it clicks.

Be sure it is locked firmly in place.



ATTENTION: When attaching I/O modules, it is very important that the bus connectors are securely locked together to be sure of proper electrical connection.

7. Attach an end cap terminator (5) to the last module in the system by using the tongue-and-groove slots as before.

8. Lock the end cap bus terminator (6).

IMPORTANT A 1769-ECR or 1769-ECL right or left end cap respectively must be used to terminate the end of the bus.

Mounting



ATTENTION: During panel or DIN rail mounting of all devices, be sure that all debris (metal chips, wire strands) is kept from falling into the module. Debris that falls into the module could cause damage at powerup.

Minimum Spacing

Maintain spacing from enclosure walls, wireways, adjacent equipment, and so forth. Allow 50 mm (2 in.) of space on all sides for adequate ventilation, as shown below.

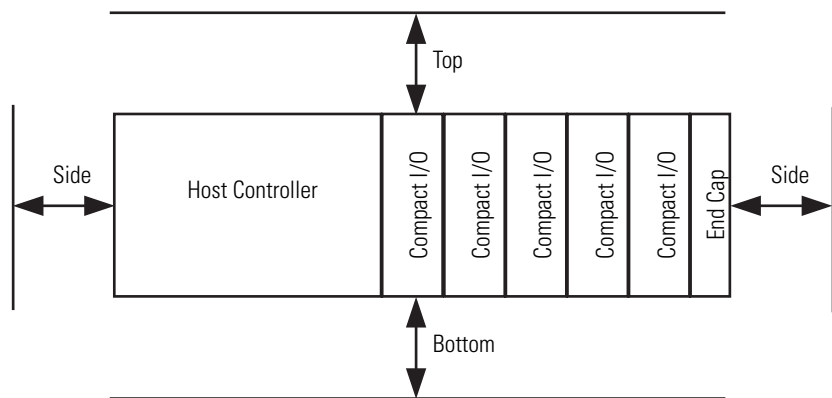

Panel Mounting

Mount the module to a panel by using two screws per module. Use M4 or #8 panhead screws. Mounting screws are required on every module.

Panel Mounting by Using the Dimensional Template

For more than 2 modules: (number of modules-1) X 35 mm (1.38 in.).

Refer to host controller documentation for this dimension.

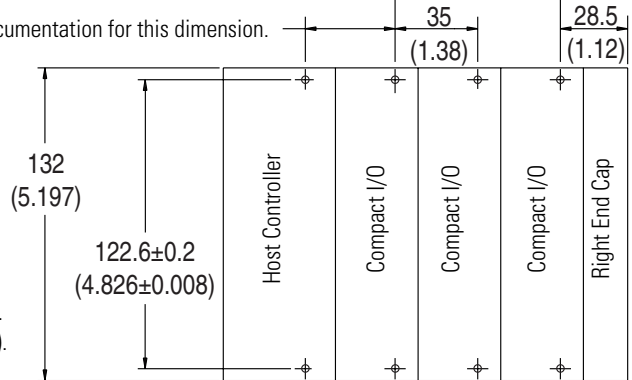

Important: All dimensions are in mm (inches).
Hole spacing tolerance: ± 0.04 mm (0.016 in.).

Panel Mounting Procedure by Using Modules as a Template

The following procedure allows you to use the assembled modules as a template for drilling holes in the panel. If you have sophisticated panel mounting equipment, you can use the dimensional template provided on [page 29](#). Due to module mounting hole tolerance, it is important to follow these procedures.

1. On a clean work surface, assemble no more than three modules.
2. Using the assembled modules as a template, carefully mark the center of all module-mounting holes on the panel.
3. Return the assembled modules to the clean work surface, including any previously mounted modules.
4. Drill and tap the mounting holes for the recommended M4 or #8 screw.
5. Place the modules back on the panel, and check for proper hole alignment.
6. Attach the modules to the panel by using the mounting screws.

TIP If mounting more modules, mount only the last one of this group and put the others aside. This reduces remounting time during drilling and tapping of the next group.

7. Repeat [steps 1...6](#) for any remaining modules.

DIN Rail Mounting

The module can be mounted by using either of these DIN rails:

- 35 x 7.5 mm (EN 50 022 - 35 x 7.5)
- 35 x 15 mm (EN 50 022 - 35 x 15)

Before mounting the module on a DIN rail, close the DIN rail latches. Press the DIN rail mounting area of the module against the DIN rail. The latches will momentarily open and lock into place.

Replace a Single Module within a System

The module can be replaced while the system is mounted to a panel (or DIN rail). Follow these steps in order.

1. Remove power.

See the important note on [page 27](#).

2. On the module to be removed, remove the upper and lower mounting screws from the module (or open the DIN latches with screwdriver).
3. Move the bus lever to the right to disconnect (unlock) the bus.
4. On the right-side adjacent module, move its bus lever to the right (unlock) to disconnect it from the module to be removed.
5. Gently slide the disconnected module forward.

If you feel excessive resistance, check that the module has been disconnected from the bus, and that both mounting screws have been removed (or DIN latches opened).

TIP It may be necessary to rock the module slightly from front to back to remove it, or, in a panel-mounted system, to loosen the screws of adjacent modules.

6. Before installing the replacement module, be sure that the bus lever on the module to be installed and on the right-side adjacent module or end cap are in the unlocked (fully right) position.
7. Slide the replacement module into the open slot.
8. Connect the modules together by locking (fully left) the bus levers on the replacement module and the right-side adjacent module.
9. Replace the mounting screws (or snap the module onto the DIN rail).

Field Wiring Connections

Use these guidelines when making field wiring connections.

System Wiring Guidelines

Consider these guidelines when wiring your system:

General Guidelines

- Power and input wiring must be in accordance with Class 1, Division 2 wiring methods, Article 501-4(b) of the National Electric Code, NFPA 70, and in accordance with the authority having jurisdiction.
- Channels are isolated from one another by $\pm 10V$ DC maximum.
- Route field wiring away from any other wiring and as far as possible from sources of electrical noise, such as motors, transformers, contactors, and AC devices. As a general rule, allow at least 15.2 cm (6 in.) of separation for every 120V of power.

- Routing field wiring in a grounded conduit can reduce electrical noise.
- If field wiring must cross AC or power cables, be sure that they cross at right angles.
- If multiple power supplies are used with analog millivolt inputs, the power supply commons must be connected.

Terminal Block Guidelines

- Do not use the module's NC terminals as connection points.
- Do not tamper with or remove the CJC sensors on the terminal block. Removal of one or both sensors will reduce accuracy.
- For millivolt sensors, use Belden 8761 shielded, twisted-pair wire (or equivalent) to be sure of proper operation and high immunity to electrical noise.
- For a thermocouple, use the shielded, twisted-pair thermocouple extension lead wires specified by the thermocouple manufacturer. Using the incorrect type of thermocouple extension wire or not following the correct polarity will cause invalid readings.
- To be sure of optimum accuracy, limit overall cable impedance by keeping a cable as short as possible. Locate the module as close to input devices as the application permits.

Grounding Guidelines



ATTENTION: The possibility exists that a grounded or exposed thermocouple can become shorted to a potential greater than that of the thermocouple itself. Due to possible shock hazard, take care when wiring grounded or exposed thermocouples. See [Appendix D](#), Using Thermocouple Junctions.

- This product is intended to be mounted to a well-grounded mounting surface such as a metal panel. Additional grounding connections from the module's mounting tabs or DIN rail (if used) are not required unless the mounting surface cannot be grounded.
- Keep cable shield connections to ground as short as possible.
- Ground the shield drain wire at one end only. The typical location is as follows:
 - For grounded thermocouples or millivolt sensors, this is at the sensor end.
 - For insulated/ungrounded thermocouples, this is at the module end. Contact your sensor manufacturer for additional details.
- If it is necessary to connect the shield drain wire at the module end, connect it to earth ground using a panel or DIN rail mounting screw.
- Refer to Industrial Automation Wiring and Grounding Guidelines, Allen-Bradley publication [1770-4.1](#), for additional information.

Noise Prevention Guidelines

- To limit the pickup of electrical noise, keep thermocouple and millivolt signal wires as far as possible from power and load lines.
- If noise persists for a device, try grounding the opposite end of the cable shield. (You can ground only one end at a time.)

Terminal Door Label

A removable, write-on label is provided with the module. Remove the label from the door, mark your unique identification of each terminal with permanent ink, and slide the label back into the door. Your markings (ID tag) will be visible when the module door is closed.

Removing and Replacing the Terminal Block

When wiring the module, you do not have to remove the terminal block. If you remove the terminal block, use the write-on label located on the side of the terminal block to identify the module location and type.



To remove the terminal block, loosen the upper and lower retaining screws. The terminal block will back away from the module as you remove the screws. Be careful not to damage the CJC sensors. When replacing the terminal block, torque the retaining screws to 0.46 N•m (4.1 lb•in).

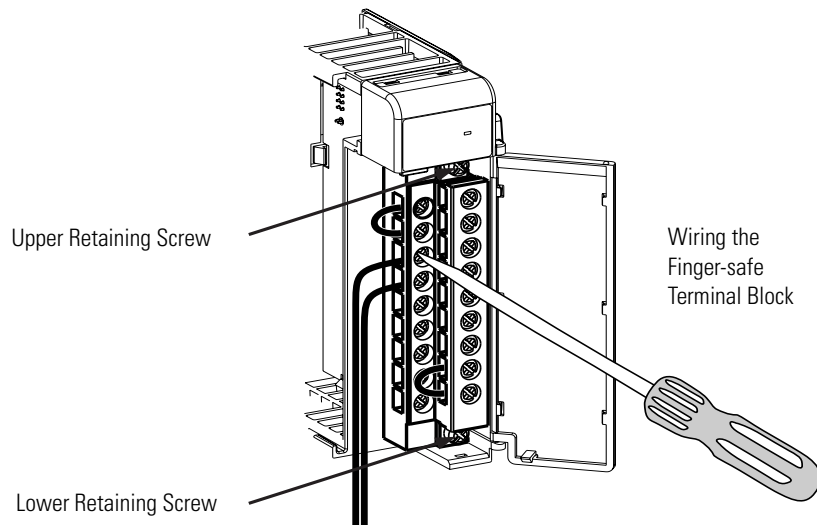

Wire the Finger-safe Terminal Block

When wiring the terminal block, keep the finger-safe cover in place.

1. Loosen the terminal screws to be wired.
2. Route the wire under the terminal pressure plate.

You can use the bare wire or a spade lug. The terminals accept a 6.35 mm (0.25 in.) spade lug.

TIP The terminal screws are non-captive. Therefore, it is possible to use a ring lug [maximum 1/4 inch o.d. with a 0.139 inch minimum i.d. (M3.5)] with the module.

3. Tighten the terminal screw making sure the pressure plate secures the wire.

Recommended torque when tightening terminal screws is 0.68 N•m (6 lb•in).

TIP If you need to remove the finger-safe cover, insert a screwdriver into one of the square, wiring holes and gently pry the cover off. If you wire the terminal block with the finger-safe cover removed, you may not be able to put it back on the terminal block because the wires will be in the way.

Wire Size and Terminal Screw Torque

Each terminal accepts up to two wires with these restrictions.

Wire Type		Wire Size	Terminal Screw Torque	Retaining Screw Torque
Solid	Cu-90 °C (194 °F)	0.325...2.080 mm ² (22...14 AWG)	0.68 N•m (6 lb•in)	0.46 N•m (4.1 lb•in)
Stranded	Cu-90 °C (194 °F)	0.325...1.310 mm ² (22...16 AWG)	0.68 N•m (6 lb•in)	0.46 N•m (4.1 lb•in)

Wire the Module



ATTENTION: To prevent shock hazard, care should be taken when wiring the module to analog signal sources. Before wiring any module, disconnect power from the system power supply and from any other source to the module.

After the module is properly installed, follow the wiring procedure below, using the proper thermocouple extension cable, or Belden 8761 for non-thermocouple applications.

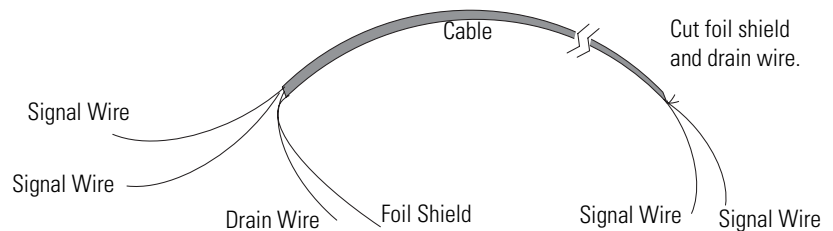

Follow these steps to wire your module.

1. At each end of the cable, strip some casing to expose the individual wires.
2. Trim the signal wires to 2 in. (5 cm) lengths.
3. Strip about 3/16 in. (5 mm) of insulation away to expose the end of the wire.



ATTENTION: Be careful when stripping wires. Wire fragments that fall into a module could cause damage at powerup.

4. At one end of the cable, twist the drain wire and foil shield together, bend them away from the cable, apply shrink wrap, and then earth ground at the preferred location based on the type of sensor you are using.

See [Grounding Guidelines on page 31](#).

5. At the other end of the cable, cut the drain wire and foil shield back to the cable and apply shrink wrap.
6. Connect the signal wires to the terminal block. Connect the other end of the cable to the analog input device.
7. Repeat [steps 1...5](#) for each channel on the module.

TIP See [Appendix D, Using Thermocouple Junctions](#), for additional information on wiring grounded, ungrounded, and exposed thermocouple types.

Figure 3 - Wiring Diagram

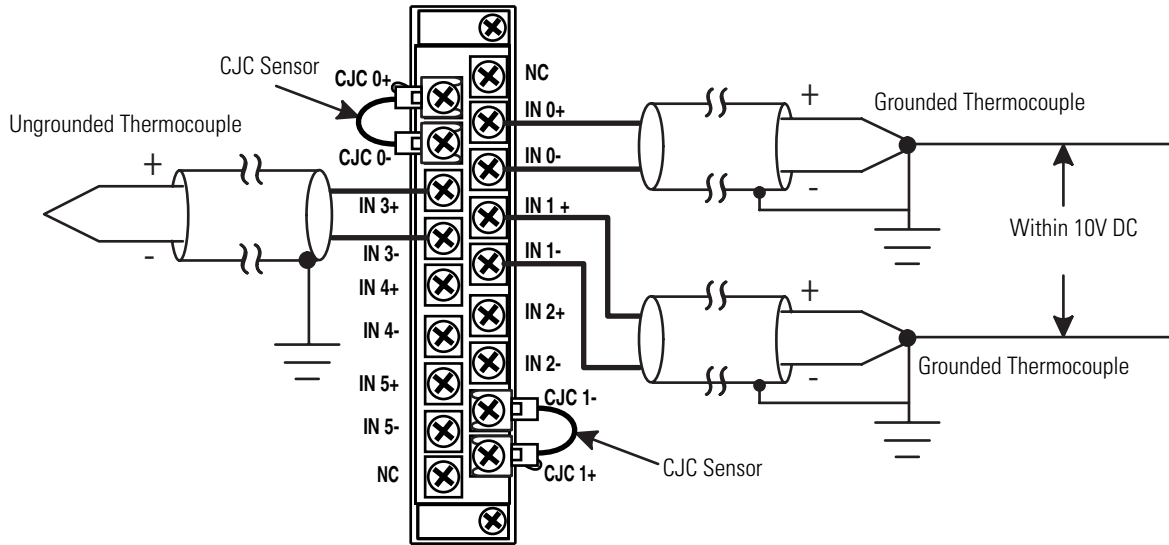

TIP When using an ungrounded thermocouple, the shield must be connected to ground at the module end.

IMPORTANT When using grounded and/or exposed thermocouples that are touching electrically conductive material, the ground potential between any two channels cannot exceed $\pm 10V$ DC, or temperature readings will be inaccurate.

Cold Junction Compensation

To obtain accurate readings from each of the channels, the cold junction temperature (temperature at the module's terminal junction between the thermocouple wire and the input channel) must be compensated for. Two cold junction compensating thermistors have been integrated in the removable terminal block. These thermistors must remain installed to retain accuracy.



ATTENTION: Do not remove or loosen the cold junction compensating thermistor assemblies located on between the two upper and lower CJC terminals. Both thermistor assemblies are critical to be sure of accurate thermocouple input readings at each channel. The module will operate in the Thermocouple mode, but at reduced accuracy if either CJC sensor is removed. [See Determining Open-circuit Response \(bits 6 and 5\) on page 46.](#)

If either of the thermistor assemblies are accidentally removed, re-install them by connecting each one across each pair of CJC terminals.

Calibration

The thermocouple module is initially calibrated at the factory. The module also has an autocalibration function.

When an autocalibration cycle takes place, the module's multiplexer is set to system ground potential and an A/D reading is taken. The A/D converter then sets its internal input to the module's precision voltage source, and another reading is taken. The A/D converter uses these numbers to compensate for system offset (zero) and gain (span) errors.

Autocalibration of a channel occurs whenever a channel is enabled. You can also program your module to perform cyclic calibration cycles, every five minutes. [See Selecting Enable/Disable Cyclic Calibration \(word 6, bit 0\) on page 50.](#)

To maintain optimal system accuracy, periodically perform an autocalibration cycle.

IMPORTANT The module does not convert input data while the calibration cycle is in progress following a change in configuration. Module scan times are increased by up to 112 ms during cyclic autocalibration.

Module Data, Status, and Channel Configuration

After installing the 1769-IT6 thermocouple/mV input module, you must configure it for operation, usually by using the programming software compatible with the controller (for example, RSLogix 500 or RSLogix 5000 software). Once configuration is complete and reflected in the ladder logic, you need to operate the module and verify its configuration.

This chapter contains information on the following:

- Module memory map
- Accessing input image file data
- Configuring channels
- Determining effective resolution and range
- Determining module update time

Module Memory Map

The module uses eight input words for data and status bits (input image), and seven configuration words.

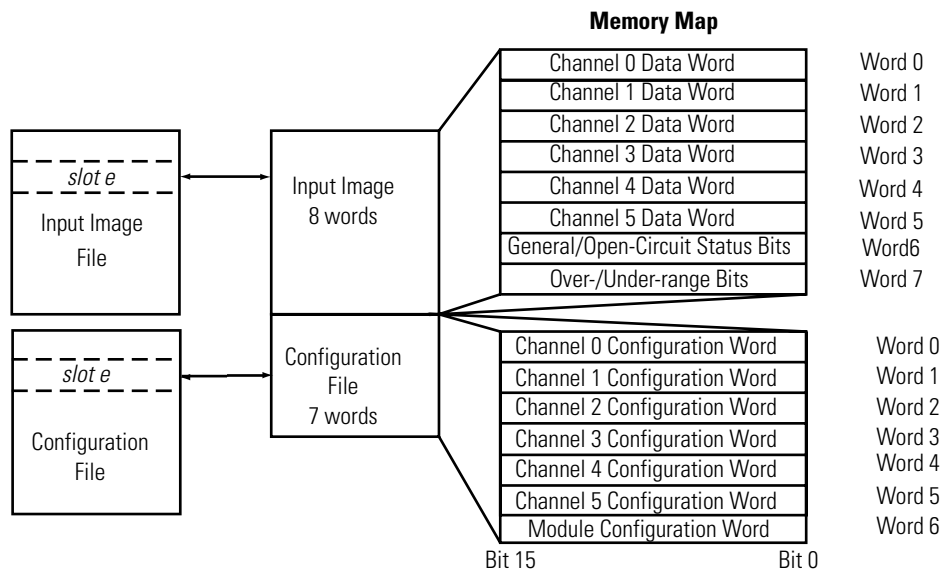

TIP

Not all controllers support program access to the configuration file. Refer to your controller's user manual.

Accessing Input Image File Data

The input image file represents data words and status words. Input words 0...5 hold the input data that represents the value of the analog inputs for channels 0...5. These data words are valid only when the channel is enabled and there are no errors. Input words 6 and 7 hold the status bits. To receive valid status information, the channel must be enabled.

You can access the information in the input image file by using the programming software configuration screen. For information on configuring the module in a:

- MicroLogix 1500 system by using RSLogix 500 software, see [Appendix E](#).
- CompactLogix system by using RSLogix 5000 software, see [Appendix F](#).
- 1769-ADN DeviceNet adapter by using RSNetWorx software, see [Appendix G](#).

Input Data File

The input data table allows you to access module read data for use in the control program, via word and bit access. The data table structure is shown in this table.

Table 1 - Input Data Table

Word/Bit ⁽¹⁾	15	14	13	12	11	10	9	8	7	6	5	4	3	2	1	0
0	Analog Input Data Channel 0															
1	Analog Input Data Channel 1															
2	Analog Input Data Channel 2															
3	Analog Input Data Channel 3															
4	Analog Input Data Channel 4															
5	Analog Input Data Channel 5															
6	OC7	OC6	OC5	OC4	OC3	OC2	OC1	OC0	S7	S6	S5	S4	S3	S2	S1	S0
7	U0	U0	U1	U1	U2	U2	U3	U3	U4	U4	U5	U5	U6	U6	U7	U7

(1) Changing bit values is not supported by all controllers. Refer to your controller manual for details.

Input Data Values

Data words 0...5 correspond to channels 0...5 and contain the converted analog input data from the input device. The most significant bit, bit 15, is the sign bit (SGN).

General Status Bits (S0 through S7)

Bits S0 through S5 of word 6 contain the general status information for channels 0...5, respectively. Bits S6 and S7 contain general status information for the two CJC sensors (S6 corresponds to CJC0, S7 to CJC1). If set (1), these bits indicate an error (over- or under-range, open-circuit, or input data not valid condition) associated with that channel. The data not valid condition is described below.

Input Data Not Valid Condition

The general status bits S0 to S5 also indicate whether the input data for a particular channel, 0...5, is being properly converted (valid) by the module. This 'invalid data' condition can occur (bit set) when the download of a new configuration to a channel is accepted by the module (proper configuration), but before the A/D converter can provide valid (properly configured) data to the 1769 bus master/controller. The following information highlights the bit operation of the input data not valid condition.

1. The default and module power-up bit condition is reset (0).
2. The bit condition is set (1) when a new configuration is received and determined valid by the module.

The set (1) bit condition remains until the module begins converting analog data for the previously accepted new configuration. When conversion begins, the bit condition is reset (0). The amount of time it takes for the module to begin the conversion process depends on the number of channels being configured and the amount of configuration data downloaded by the controller.

TIP If the new configuration is invalid, the bit function remains reset (0) and the module posts a configuration error. [See Configuration Errors on page 79.](#)

3. If A/D hardware errors prevent the conversion process from taking place, the bit condition is set (1).

Open-circuit Flag Bits (OC0 through OC7)

Bits OC0 through OC5 of word 6 contain open-circuit error information for channels 0...5, respectively. Errors for the CJC sensors are indicated in OC6 and OC7. The bit is set (1) when an open-circuit condition exists. [See Open-circuit Detection on page 77](#) for more information on open-circuit operation.

Over-range Flag Bits (O0 through O7)

Over-range bits for channels 0...5 and the CJC sensors are contained in word 7, even-numbered bits. They apply to all input types. When set (1), the over-range flag bit indicates an input signal that is at the maximum of its normal operating range for the represented channel or sensor. The module automatically resets (0) the bit when the data value falls below the maximum for that range.

Under-range Flag Bits (U0 through U7)

Under-range bits for channels 0...5 and the CJC sensors are contained in word 7, odd-numbered bits. They apply to all input types. When set (1), the under-range flag bit indicates an input signal that is at the minimum of its normal operating range for the represented channel or sensor. The module automatically resets (0) the bit when the under-range condition is cleared and the data value is within the normal operating range.

Configuring Channels

After module installation, you must configure operation details, such as thermocouple type and temperature units, for each channel. Channel configuration data for the module is stored in the controller configuration file, which is both readable and writable.

The configuration data file is shown below. Bit definitions are provided in [Channel Configuration on page 42](#). Detailed definitions of each of the configuration parameters follow the table.

Configuration Data File

The default value of the configuration data is represented by zeros in the data file. The structure of the channel configuration file is shown below.

Word/ Bit	15	14	13	12	11	10	9	8	7	6	5	4	3	2	1	0
0	Enable Channel 0	Data Format Channel 0			Input Type Channel 0			Temperature Units Channel 0		Open-circuit Condition Channel 0		Not Used	Not Used	Filter Frequency Channel 0		
1	Enable Channel 1	Data Format Channel 1			Input Type Channel 1			Temperature Units Channel 1		Open-circuit Condition Channel 1		Not Used	Not Used	Filter Frequency Channel 1		
2	Enable Channel 2	Data Format Channel 2			Input Type Channel 2			Temperature Units Channel 2		Open-circuit Condition Channel 2		Not Used	Not Used	Filter Frequency Channel 2		
3	Enable Channel 3	Data Format Channel 3			Input Type Channel 3			Temperature Units Channel 3		Open-circuit Condition Channel 3		Not Used	Not Used	Filter Frequency Channel 3		
4	Enable Channel 4	Data Format Channel 4			Input Type Channel 4			Temperature Units Channel 4		Open-circuit Condition Channel 4		Not Used	Not Used	Filter Frequency Channel 4		
5	Enable Channel 5	Data Format Channel 5			Input Type Channel 5			Temperature Units Channel 5		Open-circuit Condition Channel 5		Not Used	Not Used	Filter Frequency Channel 5		
6	Reserved														Enable/Disable Cyclic Calibration	

The configuration file can also be modified through the control program, if supported by the controller. For information on configuring the module in a:

- MicroLogix 1500 system by using RSLogix 500 software, see [Appendix E](#).
- CompactLogix system by using RSLogix 5000 software, see [Appendix F](#).
- 1769-ADN DeviceNet adapter by using RSNetWorx software, see [Appendix G](#).

The structure and bit settings are shown in [Channel Configuration on page 42](#).

Channel Configuration

Each channel configuration word consists of bit fields, the settings of which determine how the channel operates. See this table and the descriptions that follow for valid configuration settings and their meanings.

To select		Make these bit settings																
		15	14	13	12	11	10	9	8	7	6	5	4	3	2	1	0	
Filter frequency	10 Hz												Not used ⁽¹⁾			1	1	0
	60 Hz															0	0	0
	50 Hz															0	0	1
	250Hz															0	1	1
	500 Hz															1	0	0
	1 kHz															1	0	1
Open circuit	Upscale										0	0						
	Downscale										0	1						
	Hold last state										1	0						
	Zero										1	1						
Temperature units	°C									0								
	°F									1								
Input type	Thermocouple J					0	0	0	0									
	Thermocouple K					0	0	0	1									
	Thermocouple T					0	0	1	0									
	Thermocouple E					0	0	1	1									
	Thermocouple R					0	1	0	0									
	Thermocouple S					0	1	0	1									
	Thermocouple B					0	1	1	0									
	Thermocouple N					0	1	1	1									
	Thermocouple C					1	0	0	0									
	-50...50 mV					1	0	0	1									
	-100...100 mV					1	0	1	0									
Data format	Raw/proportional		0	0	0													
	Engineering units		0	0	1													
	Engineering units x 10		1	0	0													
	Scaled-for-PID		0	1	0													
	Percent range		0	1	1													
Enable channel	Disable	0																
	Enable	1																

(1) An attempt to write any non-valid (spare) bit configuration into any selection field results in a module configuration error.

TIP Default settings for a particular function are indicated by zeros. For example, the default filter frequency is 60 Hz.

Enabling or Disabling a Channel (bit 15)

You can enable or disable each of the six channels individually by using bit 15. The module scans enabled channels only. Enabling a channel forces it to be recalibrated before it measures input data. Disabling a channel sets the channel data word to zero.

TIP When a channel is not enabled (0), no input is provided to the controller by the A/D converter. This speeds up the response of the active channels, improving performance.

Selecting Data Formats (bits 14...12)

This selection configures channels 0...5 to present analog data in any of these formats:

- [Raw/Proportional Data](#)
- [Engineering Units x 1](#)
- [Engineering Units x 10](#)
- [Scaled-for-PID](#)
- [Percent Range](#)

Table 2 - Channel Data Word Format

Input Type	Data Format						
	Engineering Units x 1		Engineering Units x 10		Scaled-for-PID	Raw/Proportional Data	Percent Range
	°C	°F	°C	°F			
J	-2100...12,000	-3460...21,920	-210...1200	-346...2192	0...16,383	-32,767...32,767	0...10,000
K	-2700...13,700	-4540...24,980	-270...1370	-454...2498			
T	-2700...4000	-4540...7520	-270...400	-454...752			
E	-2700...10,000	-4540...18,320	-270...1000	-454...1832			
R	0...17,680	320...32,140	0...1768	32...3214			
S	0...17,680	320...32,140	0...1768	32...3214			
B	3000...18,200	5720...32,767 ⁽¹⁾	300...1820	572...3308			
N	-2100...13,000	-3460...23,720	-210...1300	-346...2372			
C	0...23,150	320...32,767 ⁽¹⁾	0...2315	32...4199			
±50 mV	-5000...5000 ⁽²⁾		-500...500 ⁽²⁾				
±100 mV	-10,000...10,000 ⁽²⁾		-1000...1000 ⁽²⁾				

(1) Type B and C thermocouples cannot be represented in engineering units x1 (°F) above 3276.7 °F; therefore, it will be treated as an over-range error.

(2) When millivolts are selected, the temperature setting is ignored. Analog input data is the same for °C or °F selection.

TIP The engineering units data formats represent real engineering temperature units provided by the module to the controller. The raw/proportional counts, scaled-for-PID, and percent of full-scale data formats, may yield the highest effective resolutions, but may also require that you convert channel data to real engineering units in your control program.

Raw/Proportional Data

The value presented to the controller is proportional to the selected input and scaled into the maximum data range allowed by the bit resolution of the A/D converter and filter selected. The raw/proportional data format also provides the best resolution of all the data formats.

If you select the raw/proportional data format for a channel, the data word will be a number between -32,767 and 32,767. For example, if a type J thermocouple is selected, the lowest temperature of -210 °C (-346 °F) corresponds to -32,767 counts. The highest temperature of 1200 °C (2192 °F) corresponds to 32,767. [See Determining Effective Resolution and Range on page 50.](#)

Engineering Units x 1

When using this data format for a thermocouple or millivolt input, the module scales the thermocouple or millivolt input data to the actual engineering values for the selected millivolt input or thermocouple type. It expresses temperatures in 0.1 °C or 0.1 °F units. For millivolt inputs, the module expresses voltages in 0.01 mV units.

TIP Use the engineering units x 10 setting to produce temperature readings in whole degrees Celsius or Fahrenheit.

The resolution of the engineering units x 1 data format is dependent on the range selected and the filter selected. [See Determining Effective Resolution and Range on page 50.](#)

Engineering Units x 10

When using a thermocouple input with this data format, the module scales the input data to the actual temperature values for the selected thermocouple type. With this format, the module expresses temperatures in 1 °C or 1 °F units. For millivolt inputs, the module expresses voltages in 0.1 mV units.

The resolution of the engineering units x 10 data format is dependent on the range selected and the filter selected. [See Determining Effective Resolution and Range on page 50.](#)

Scaled-for-PID

The value presented to the controller is a signed integer, with 0 representing the lower input range and 16,383 representing the upper input range.

To obtain the value, the module scales the input signal range to 0...16,383, which is standard to the PID algorithm for the MicroLogix 1500 controller and other Allen-Bradley controllers (for example, SLC controllers). For example, if a type J thermocouple is used, the lowest temperature for the thermocouple is -210 °C (-346 °F), which corresponds to 0 counts. The highest temperature in the input range, 1200 °C (2192 °F), corresponds to 16,383 counts.

Percent Range

Input data is presented as a percentage of the specified range. The module scales the input signal range to 0...10,000. For example, using a type J thermocouple, the range -210...1200 °C (-346...2192 °F) is represented as 0...100%. [See Determining Effective Resolution and Range on page 50.](#)

Selecting Input Type (bits 11...8)

Bits 11...8 in the channel configuration word indicate the type of thermocouple or millivolt input device. Each channel can be individually configured for any type of input.

Selecting Temperature Units (bit 7)

The module supports two different linearized/scaled ranges for thermocouples, degrees Celsius (°C) and degrees Fahrenheit (°F). Bit 7 is ignored for millivolt input types, or when raw/proportional, scaled-for-PID, or percent data formats are used.

IMPORTANT If you are using engineering units x 1 data format and degrees Fahrenheit temperature units, thermocouple types B and C cannot achieve full-scale temperature with 16-bit signed numerical representation. An over-range error will occur for the configured channel if it tries to represent the full-scale value. The maximum representable temperature is 1802.61 °C (3276.7 °F).

Determining Open-circuit Response (bits 6 and 5)

An open-circuit condition occurs when an input device or its extension wire is physically separated or open. This can happen if the wire is cut or disconnected from the terminal block.

TIP If either CJC sensor is removed from the module terminal block, its open-circuit bit is set (1) and the module continues to calculate thermocouple readings at reduced accuracy. If an open CJC circuit is detected at powerup, the module uses 25 °C (77 °F) as the sensed temperature at that location. If an open CJC circuit is detected during normal operation, the last valid CJC reading is used. An input channel configured for millivolt input is not affected by CJC open-circuit conditions. See [Open-circuit Detection on page 77](#) for additional details.

Bits 6 and 5 define the state of the channel data word when an open-circuit condition is detected for the corresponding channel. The module overrides the actual input data depending on the option that you specify when it detects an open circuit. The open-circuit options are explained in this table.

Table 3 - Open-circuit Response Definitions

Response Option	Definition
Upscale	Sets the input data value to full upper scale value of channel data word. The full-scale value is determined by the selected input type and data format.
Downscale	Sets the input data value to full lower scale value of channel data word. The low scale value is determined by the selected input type and data format.
Last State	Sets the input data value to the last input value prior to the detection of the open-circuit.
Zero	Sets the input data value to 0 to force the channel data word to 0.

Selecting Input Filter Frequency (bits 2...0)

The input filter selection field allows you to select the filter frequency for each channel and provides system status of the input filter setting for channels 0...5. The filter frequency affects the following, as explained later in this chapter:

- Noise rejection characteristics for module inputs
- Channel step response
- Channel cut-off frequency
- Effective resolution
- Module update time

Effects of Filter Frequency on Noise Rejection

The filter frequency that you choose for a module channel determines the amount of noise rejection for the inputs. A lower frequency (50 Hz versus 500 Hz) provides better noise rejection and increases effective resolution, but also increases channel update time. A higher filter frequency provides lower noise rejection, but decreases the channel update time and effective resolution.

When selecting a filter frequency, be sure to consider cut-off frequency and channel step response to obtain acceptable noise rejection. Choose a filter frequency so that your fastest-changing signal is below that of the filter's cut-off frequency.

Common Mode Rejection is better than 115 dB at 50 and 60 Hz, with the 50 and 60 Hz filters selected, respectively, or with the 10 Hz filter selected. The module performs well in the presence of common mode noise as long as the signals applied to the user positive and negative input terminals do not exceed the common mode voltage rating ($\pm 10V$) of the module. Improper earth ground may be a source of common mode noise.

TIP Transducer power supply noise, transducer circuit noise, or process variable irregularities may also be sources of normal mode noise. The filter frequency of the module's CJC sensors is the lowest filter frequency of any enabled thermocouple type to maximize the trade-offs between effective resolution and channel update time.

Effects of Filter Frequency on Channel Step Response

The selected channel filter frequency determines the channel's step response. The step response is the time required for the analog input signal to reach 100% of its expected final value, given a full-scale step change in the input signal. This means that if an input signal changes faster than the channel step response, a portion of that signal will be attenuated by the channel filter. The channel step response is calculated by a settling time of $3 \times (1/\text{filter frequency})$.

Table 4 - Filter Frequency and Step Response

Filter Frequency	Step Response
10 Hz	300 ms
50 Hz	60 ms
60 Hz	50 ms
250 Hz	12 ms
500 Hz	6 ms
1 kHz	3 ms

Channel Cut-off Frequency

The filter cut-off frequency, -3 dB, is the point on the frequency response curve where frequency components of the input signal are passed with 3 dB of attenuation. This table shows cut-off frequencies for the supported filters.

Table 5 - Filter Frequency versus Channel Cut-off Frequency

Filter Frequency	Cut-off Frequency
10 Hz	2.62 Hz
50 Hz	13.1 Hz
60 Hz	15.7 Hz
250 Hz	65.5 Hz
500 Hz	131 Hz
1 kHz	262 Hz

All input frequency components at or below the cut-off frequency are passed by the digital filter with less than 3 dB of attenuation. All frequency components above the cut-off frequency are increasingly attenuated as shown in the graphs on [page 49](#).

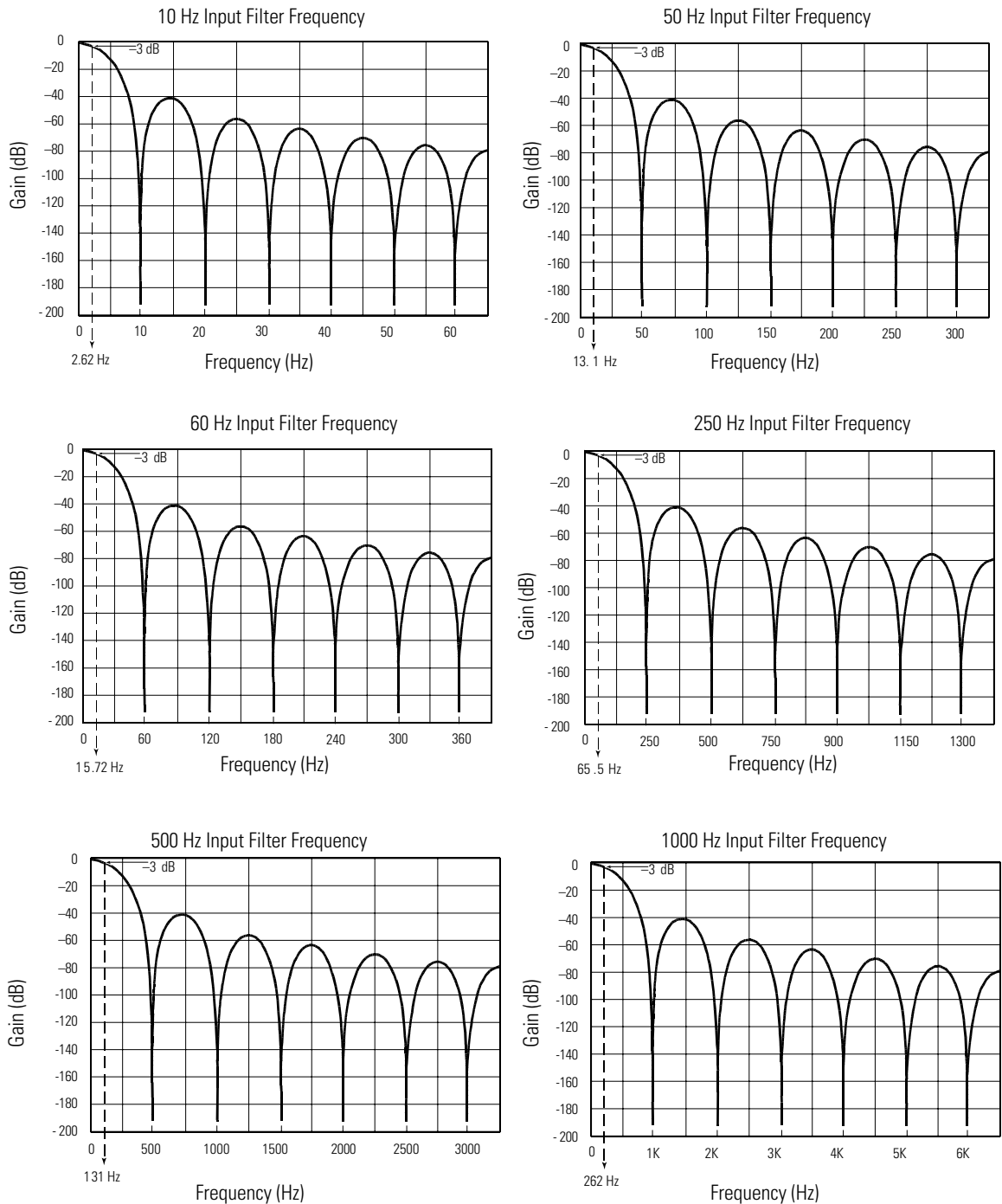
Figure 4 - Frequency Response Graphs

The cut-off frequency for each channel is defined by its filter frequency selection. Choose a filter frequency so that your fastest changing signal is below that of the filter's cut-off frequency. The cut-off frequency should not be confused with the update time. The cut-off frequency relates to how the digital filter attenuates frequency components of the input signal. The update time defines the rate at which an input channel is scanned and its channel data word is updated.

Selecting Enable/Disable Cyclic Calibration (word 6, bit 0)

Cyclic calibration functions to reduce offset and gain drift errors due to temperature changes within the module. By setting word 6, bit 0 to 0, you can configure the module to perform calibration on all enabled channels. Setting this bit to 1 disables cyclic calibration.

You can program the calibration cycle to occur whenever you desire for systems that allow modifications to the state of this bit via the ladder program. When the calibration function is enabled (bit = 0), a calibration cycle occurs once for all enabled channels. If the function remains enabled, a calibration cycle occurs every five minutes thereafter. The calibration cycle of each enabled channel is staggered over several module scan cycles within the five minute period to limit impact on the system response speed.

[See Effects of Autocalibration on Module Update Time on page 70.](#)

Determining Effective Resolution and Range

The effective resolution for an input channel depends upon the filter frequency selected for that channel. The following graphs provide the effective resolution for each of the range selections at the six available frequencies. These graphs do not include the affects of unfiltered input noise. Choose the frequency that most closely matches your requirements.

Figure 5 - Effective Resolution versus Input Filter Selection for Type B Thermocouples Using 10, 50, and 60 Hz Filters

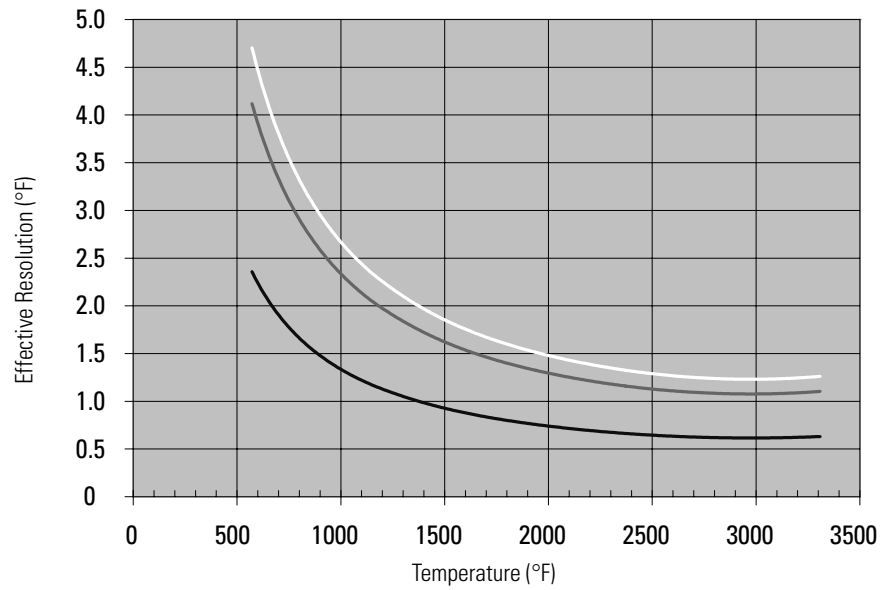
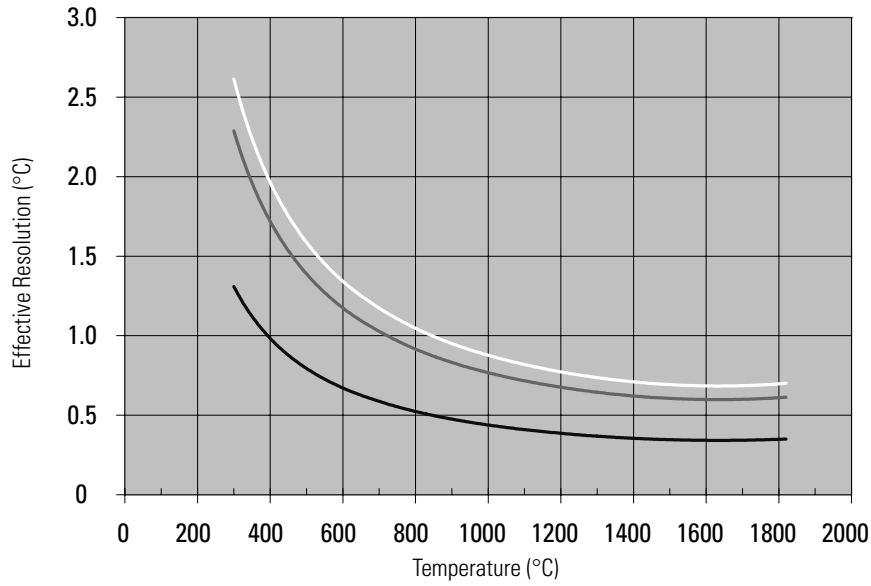

Figure 6 - Effective Resolution versus Input Filter Selection for Type B Thermocouples Using 250, 500, and 1 kHz Filters

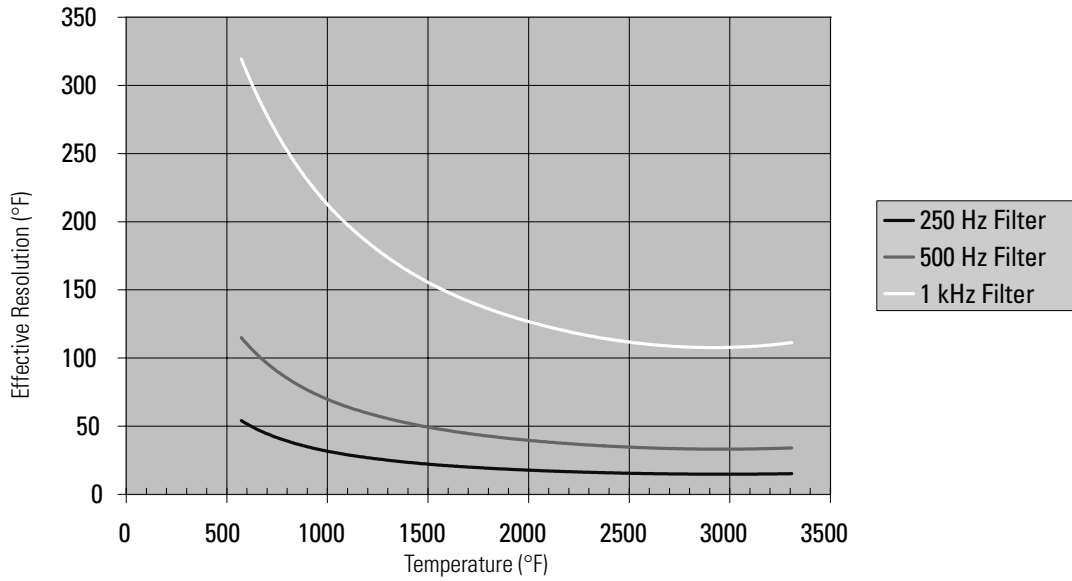
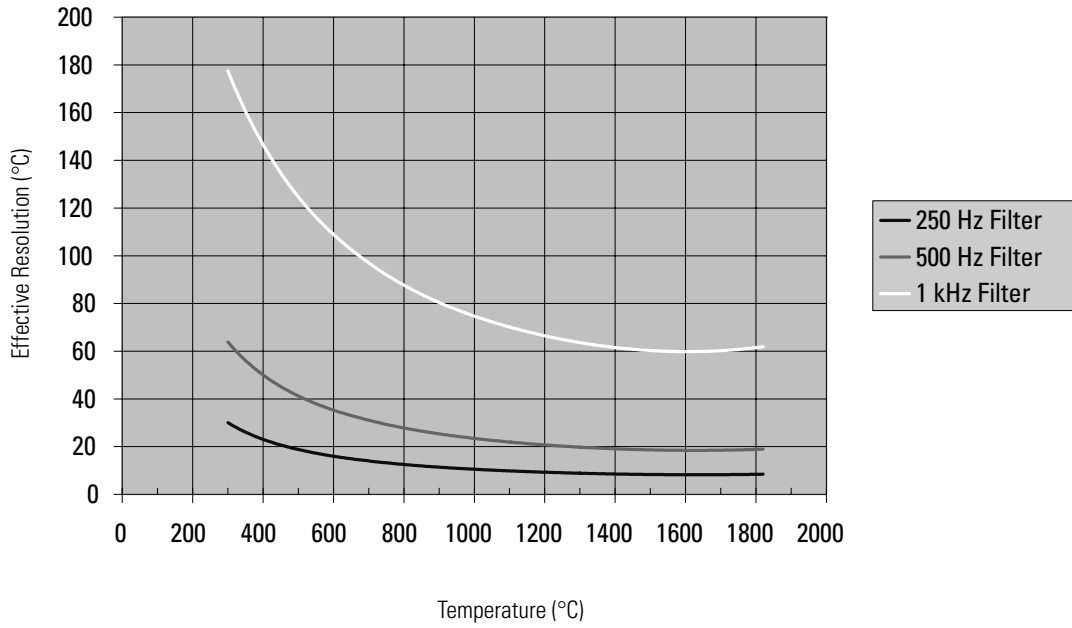

Figure 7 - Effective Resolution versus Input Filter Selection for Type C Thermocouples Using 10, 50, and 60 Hz Filters

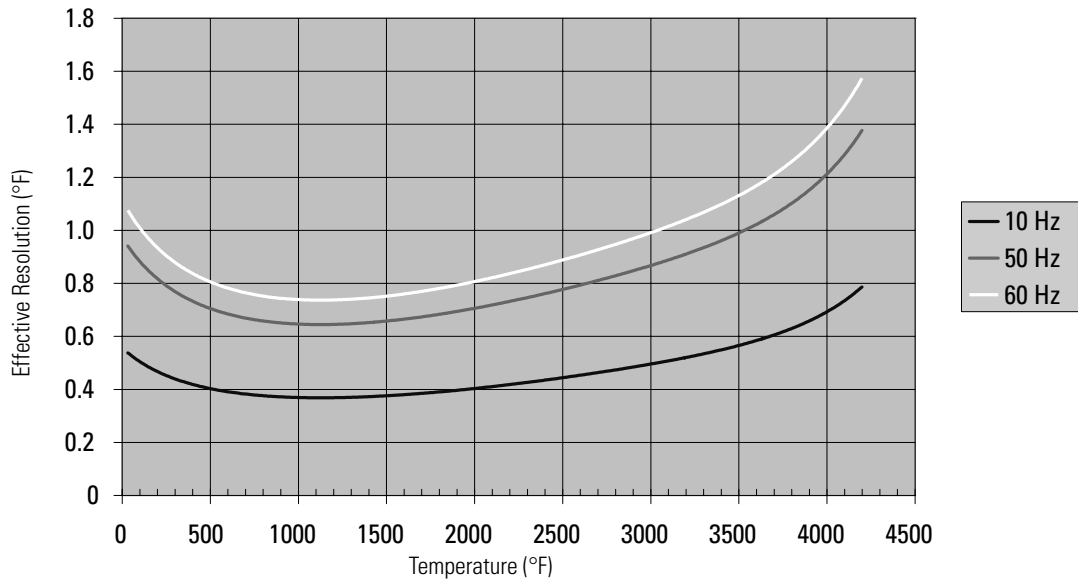
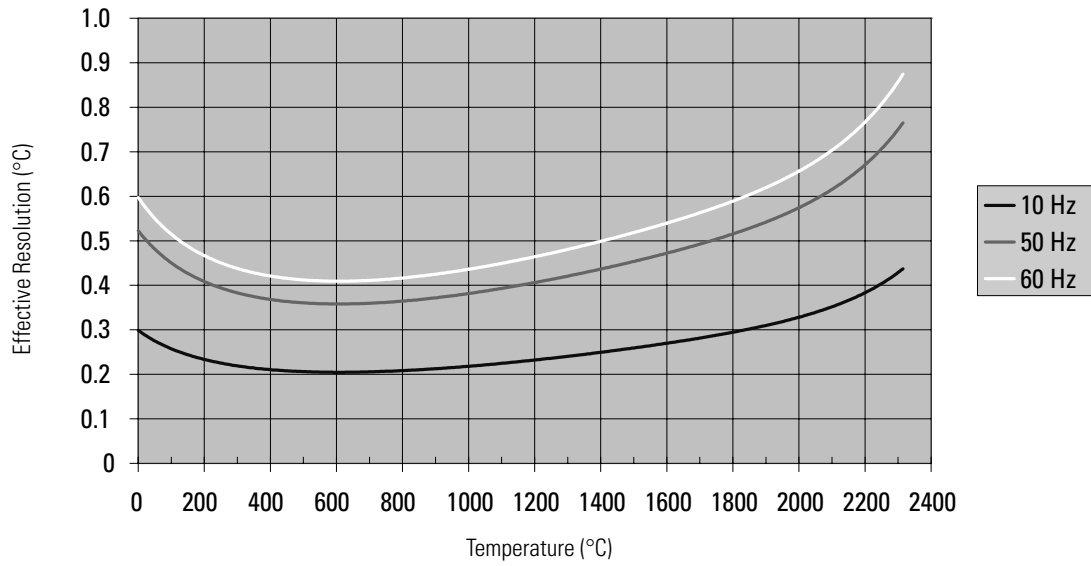

Figure 8 - Effective Resolution versus Input Filter Selection for Type C Thermocouples Using 250, 500, and 1 kHz Filters

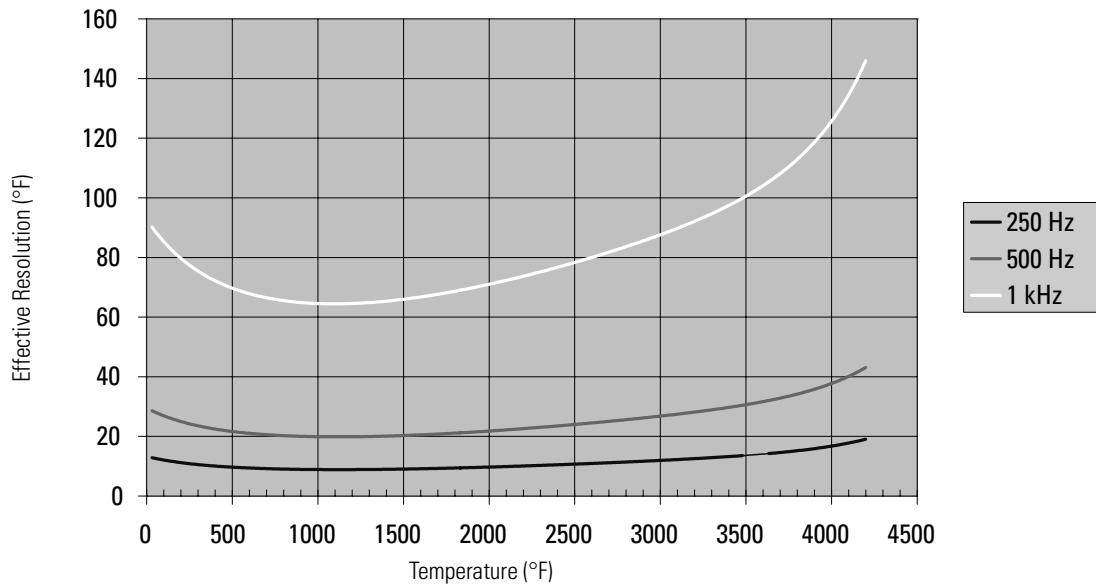
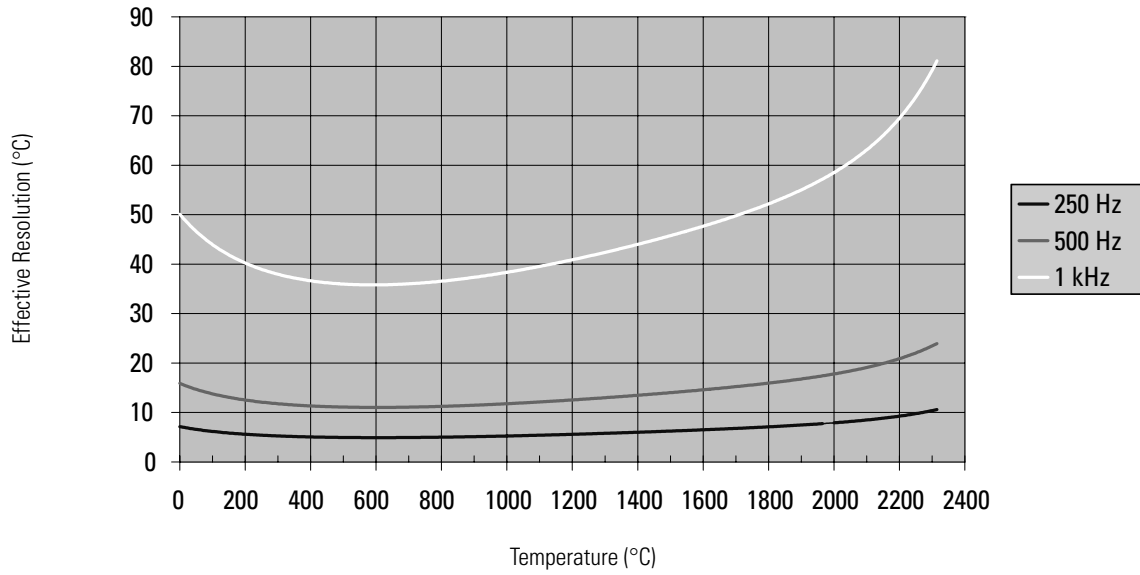

Figure 9 - Effective Resolution versus Input Filter Selection for Type E Thermocouples Using 10, 50, and 60 Hz Filters

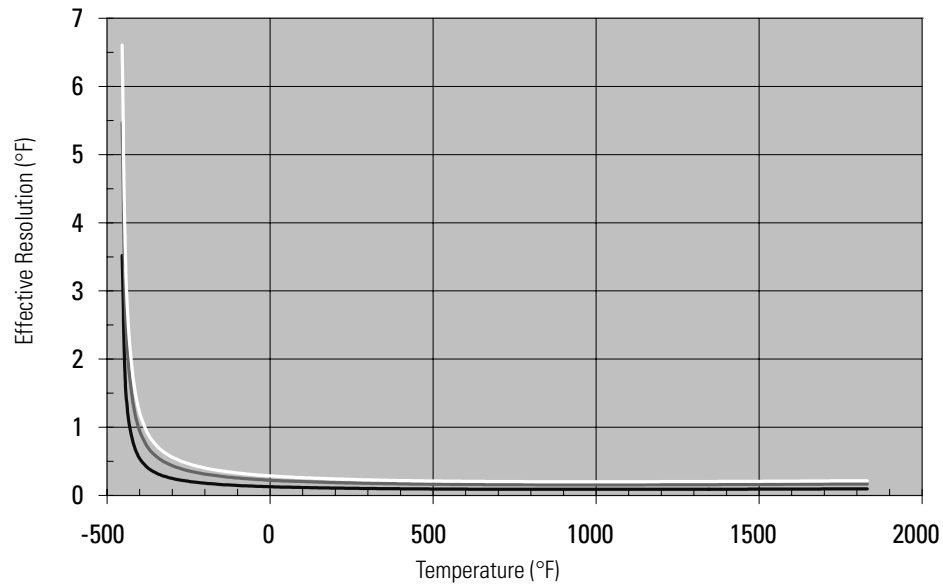
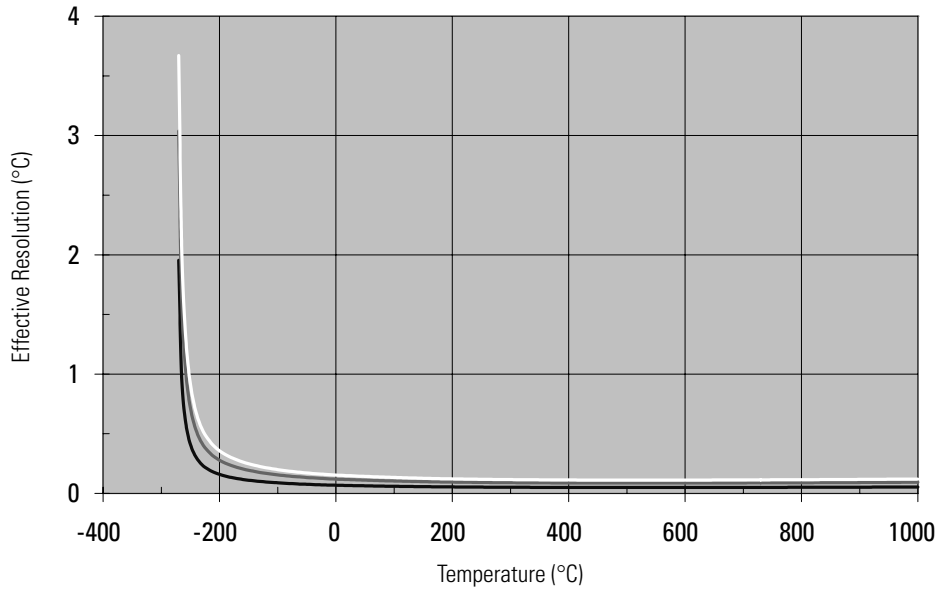

Figure 10 - Effective Resolution versus Input Filter Selection for Type E Thermocouples Using 250, 500, and 1 kHz Filters

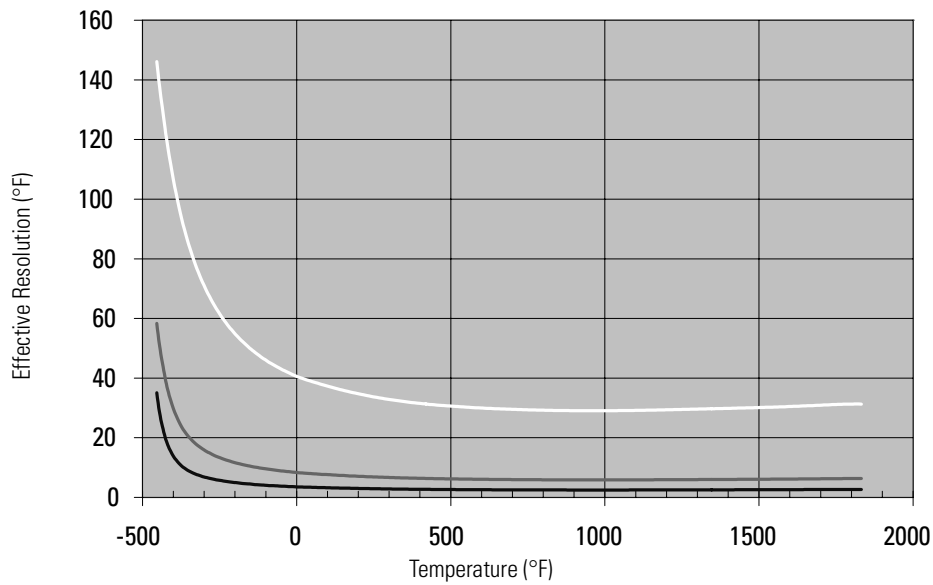
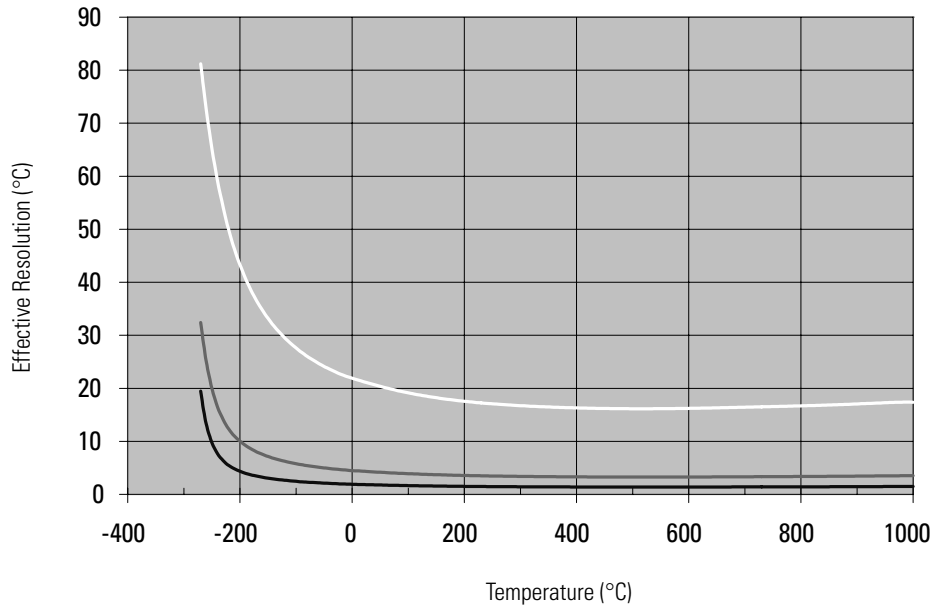

Figure 11 - Effective Resolution versus Input Filter Selection for Type J Thermocouples Using 10, 50, and 60 Hz Filters

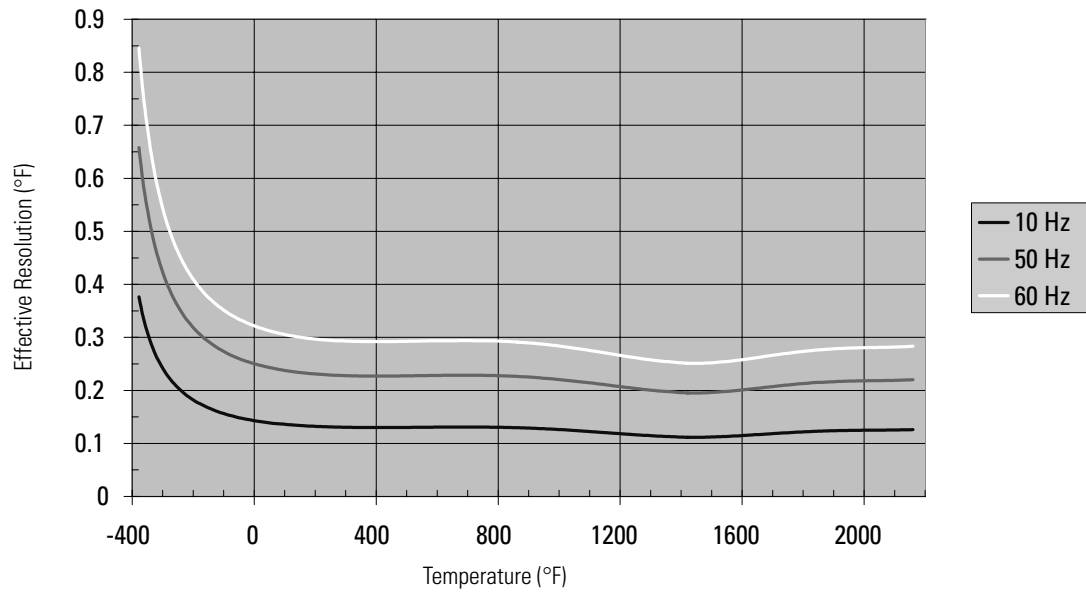
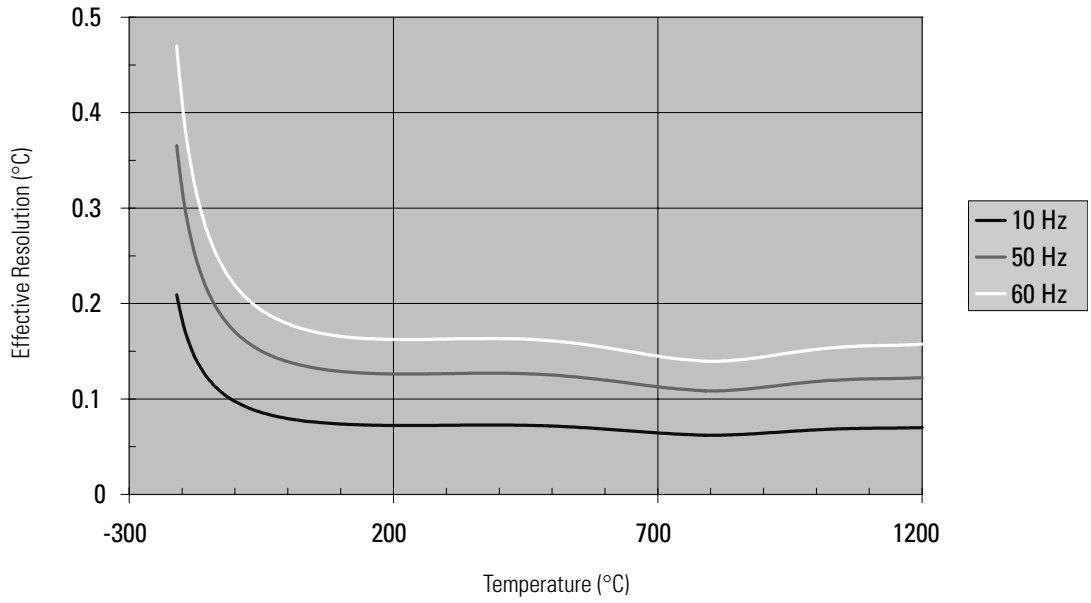

Figure 12 - Effective Resolution versus Input Filter Selection for Type J Thermocouples Using 250, 500, and 1 kHz Filters

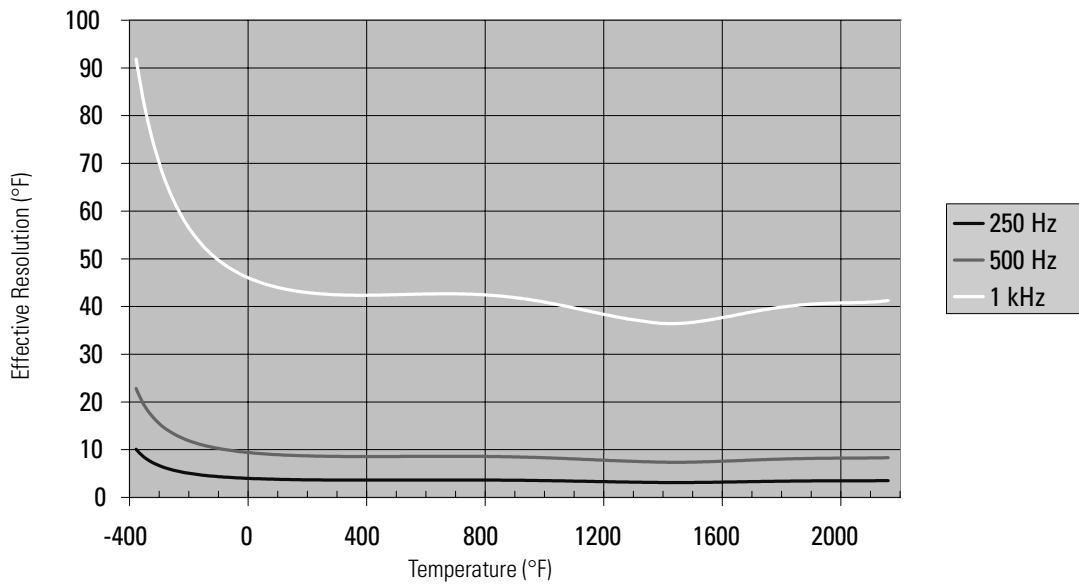
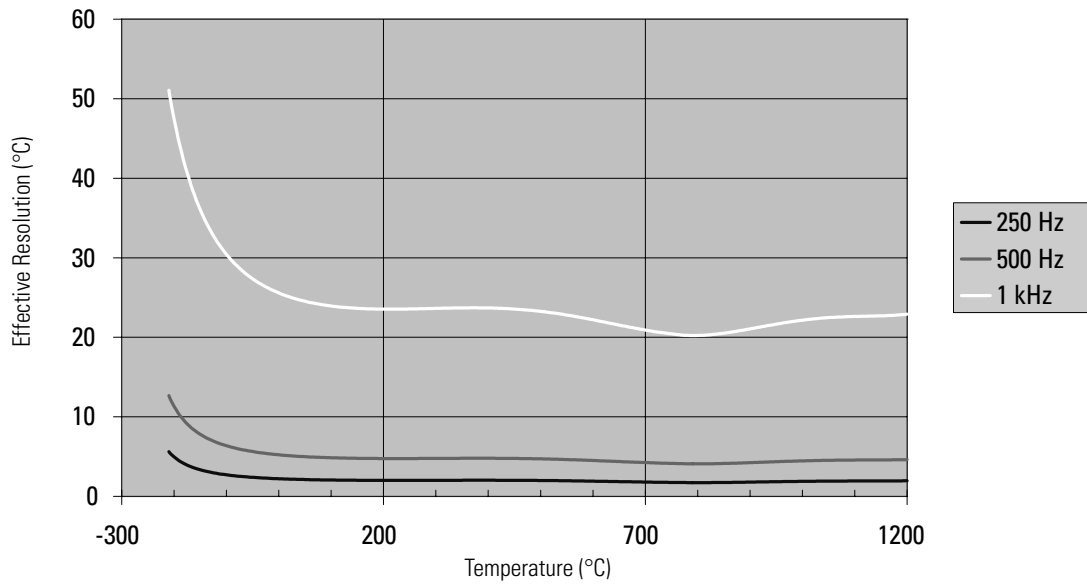

Figure 13 - Effective Resolution versus Input Filter Selection for Type K Thermocouples Using 10, 50, and 60 Hz Filters

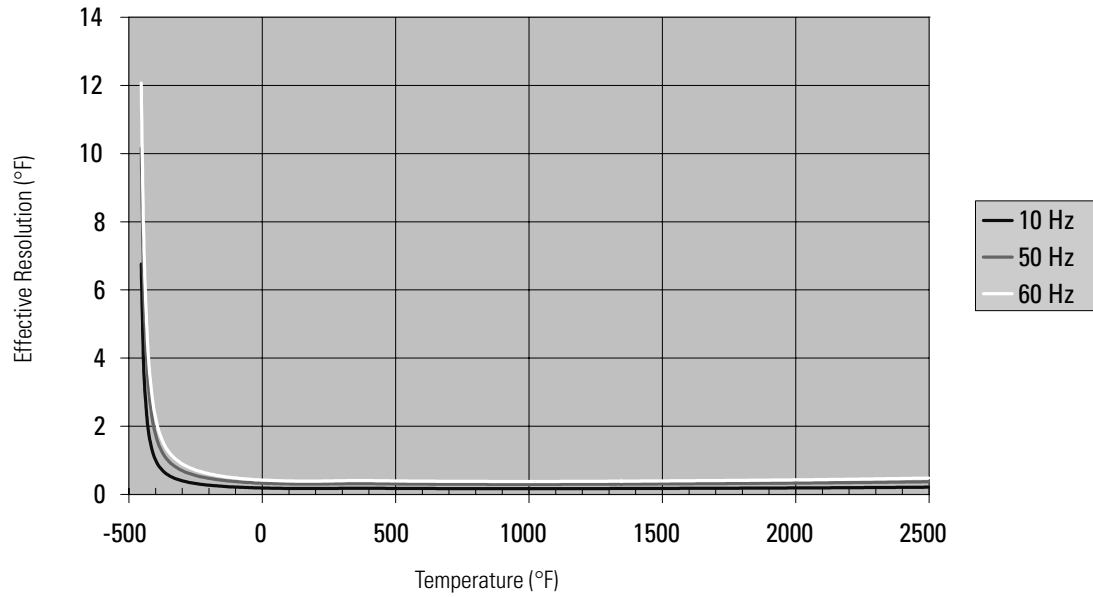
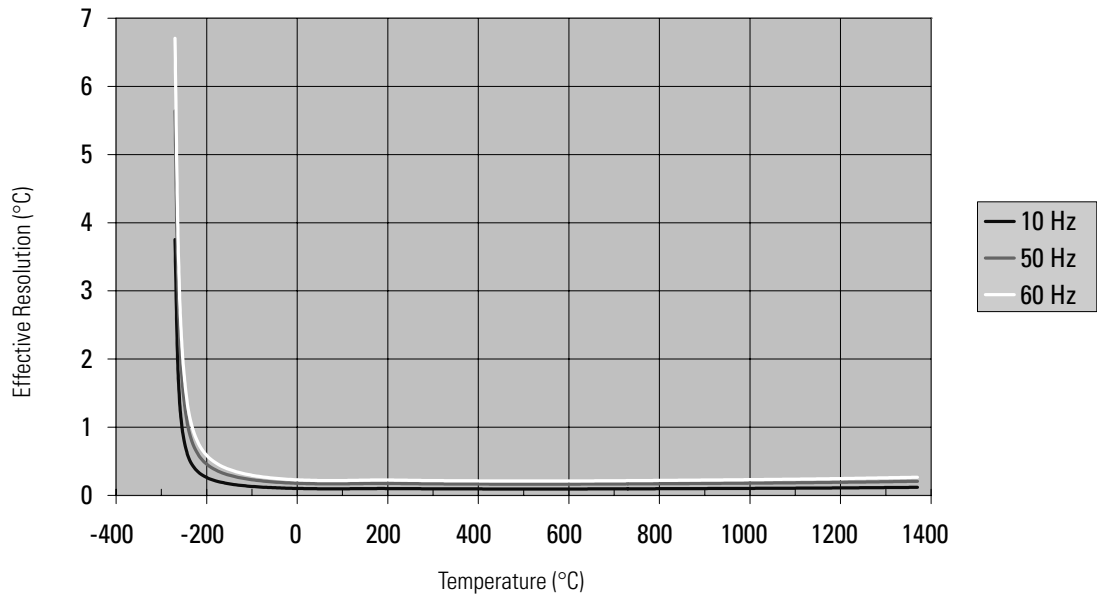

Figure 14 - Effective Resolution versus Input Filter Selection for Type K Thermocouples Using 250, 500, and 1 kHz Filters

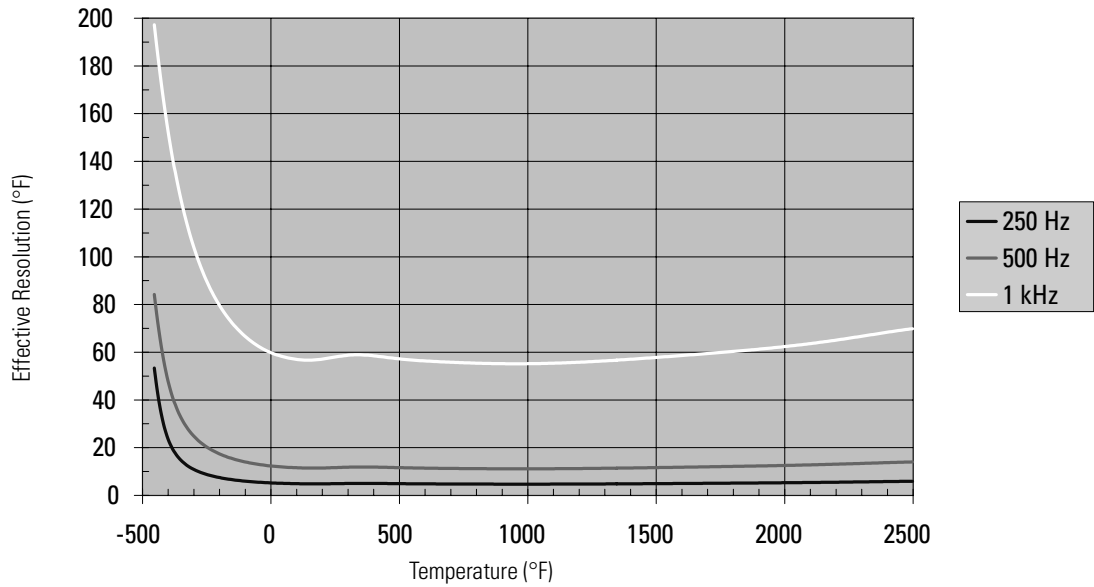
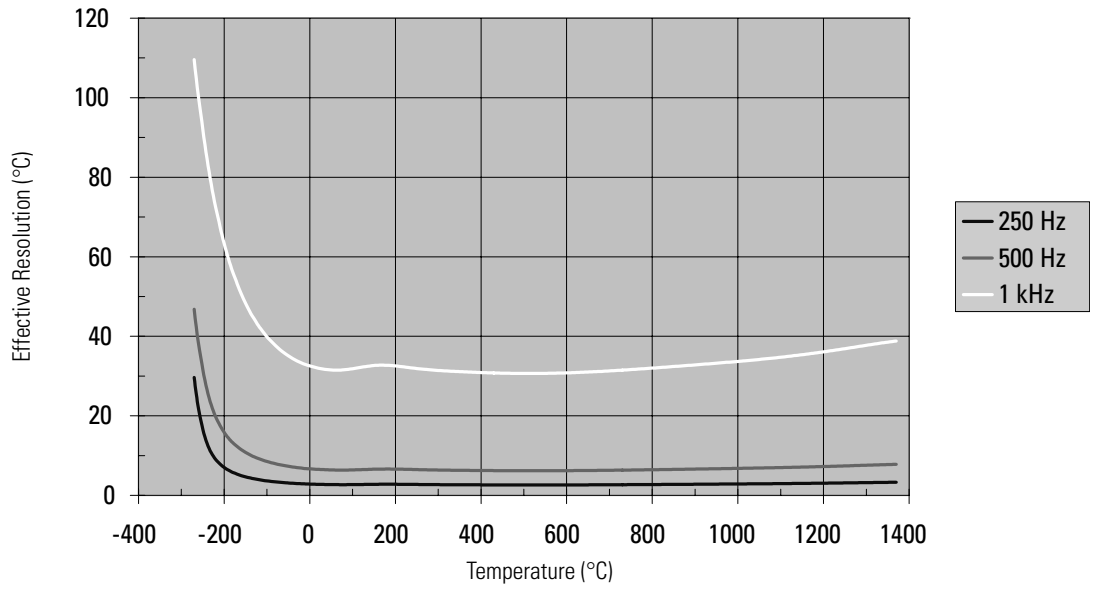

Figure 15 - Effective Resolution versus Input Filter Selection for Type N Thermocouples Using 10, 50, and 60 Hz Filters

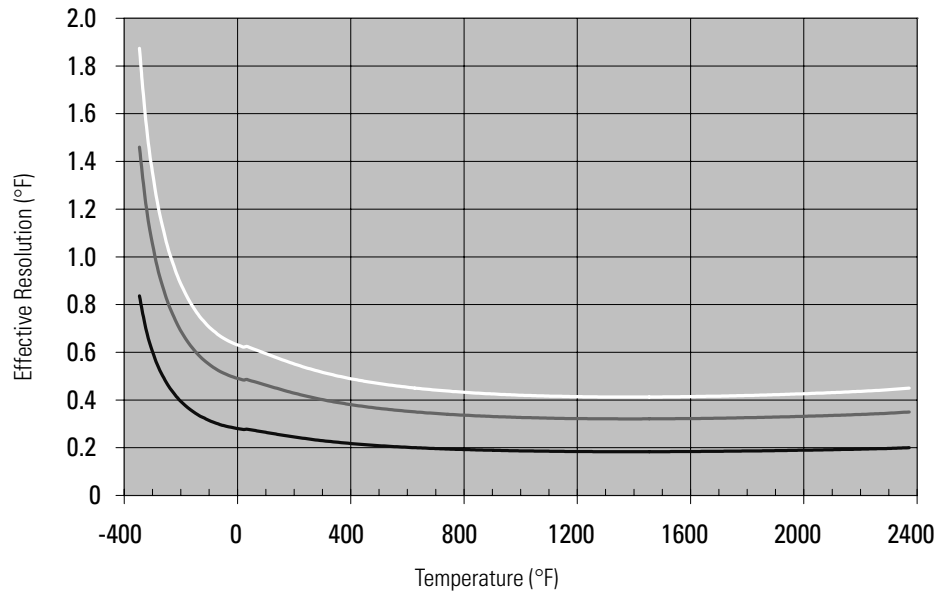
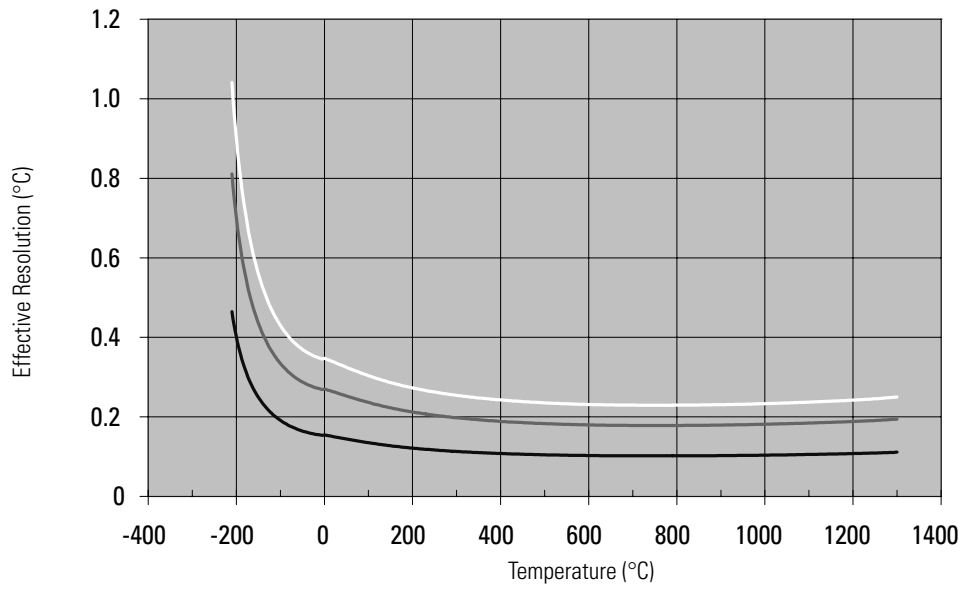

Figure 16 - Effective Resolution versus Input Filter Selection for Type N Thermocouples Using 250, 500, and 1 kHz Filters

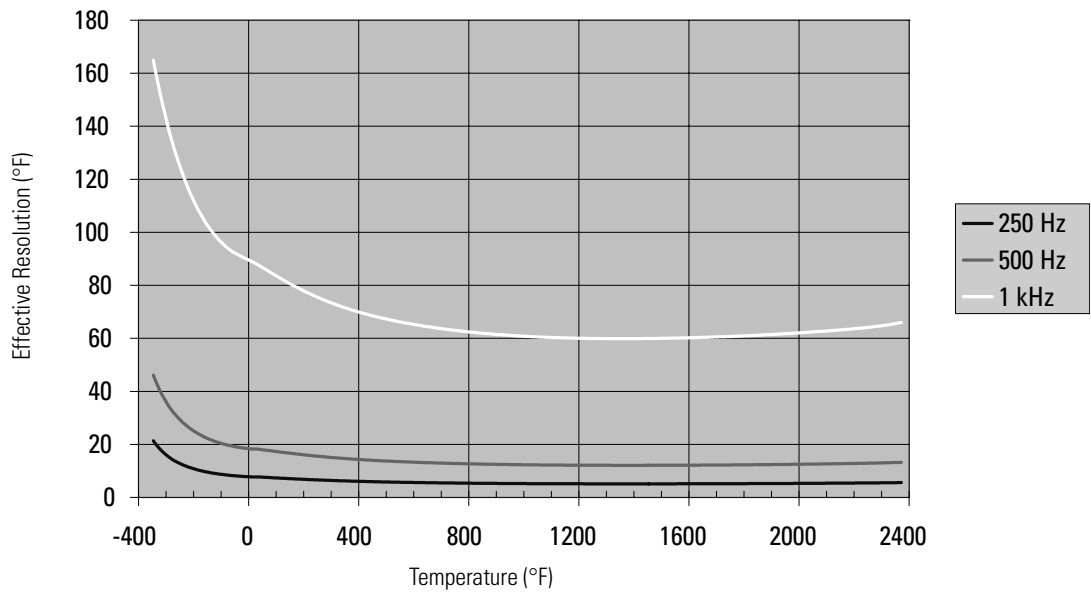
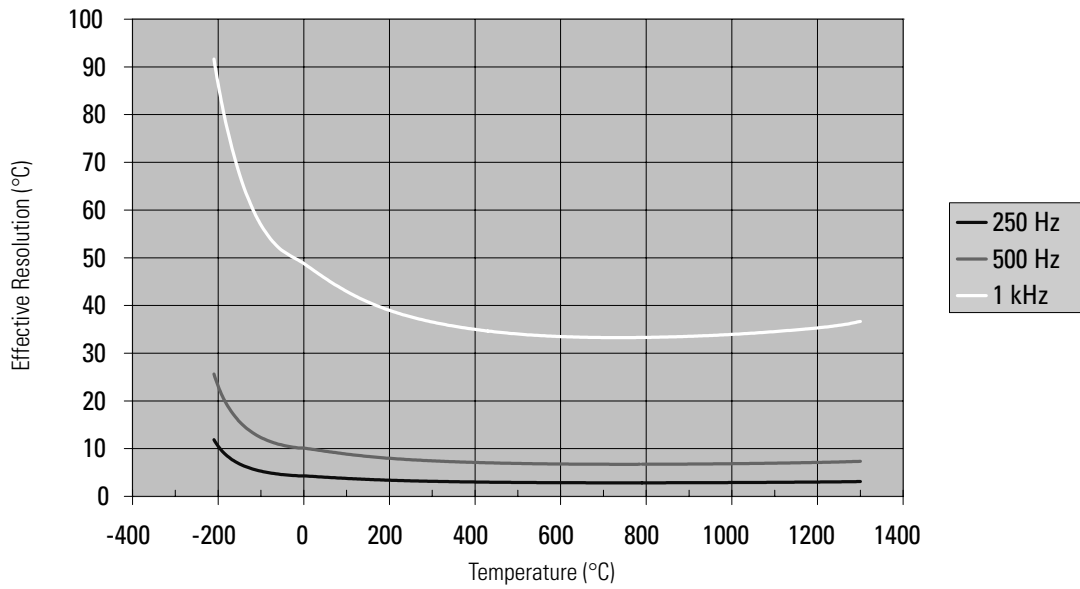

Figure 17 - Effective Resolution versus Input Filter Selection for Type R Thermocouples Using 10, 50, and 60 Hz Filters

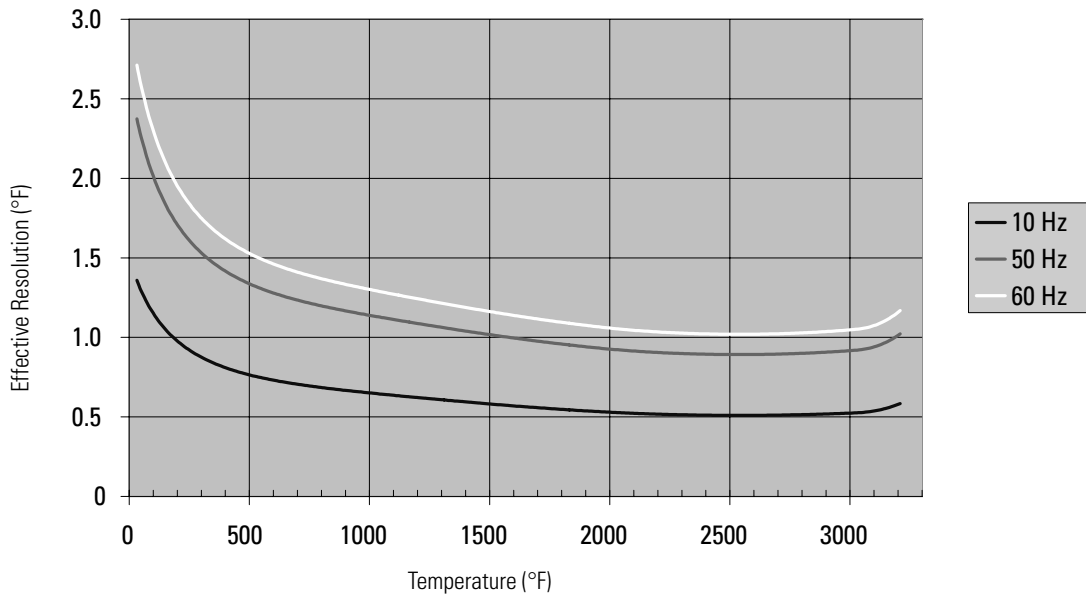
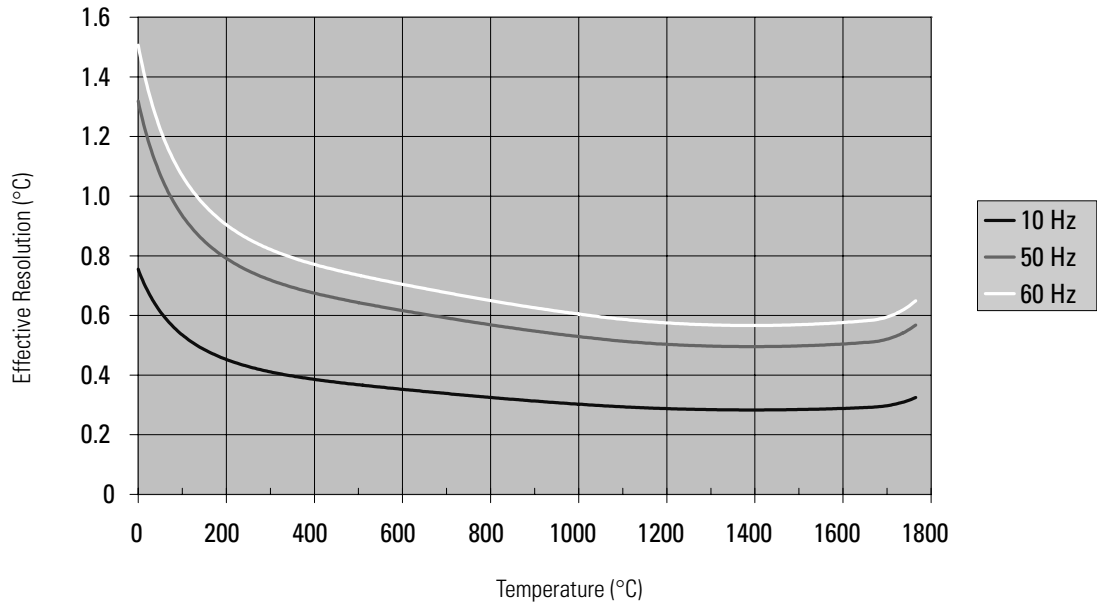

Figure 18 - Effective Resolution versus Input Filter Selection for Type R Thermocouples Using 250, 500, and 1 kHz Filters

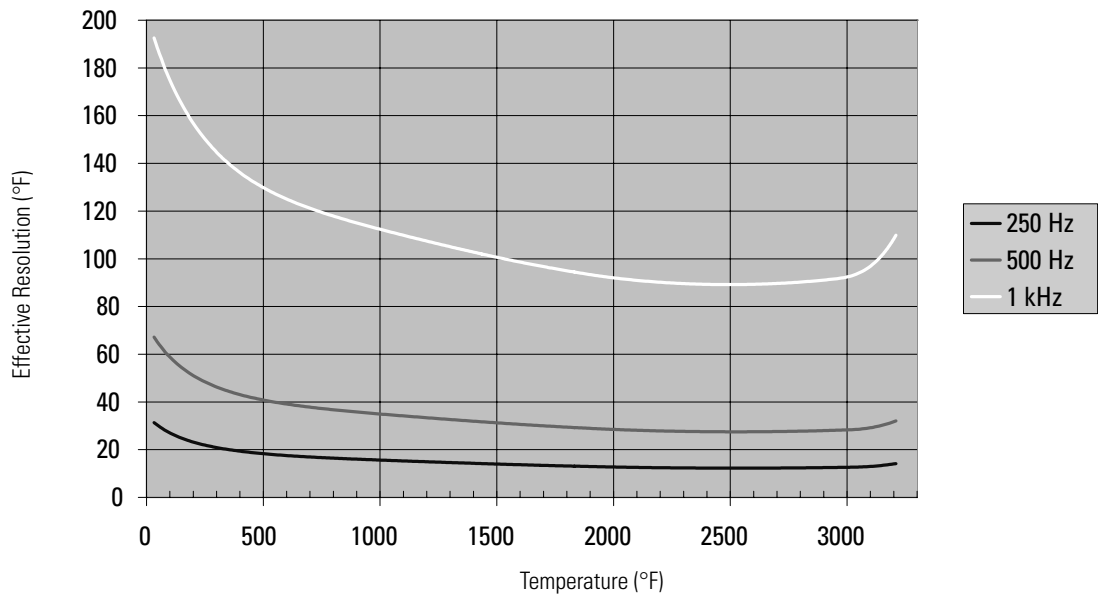
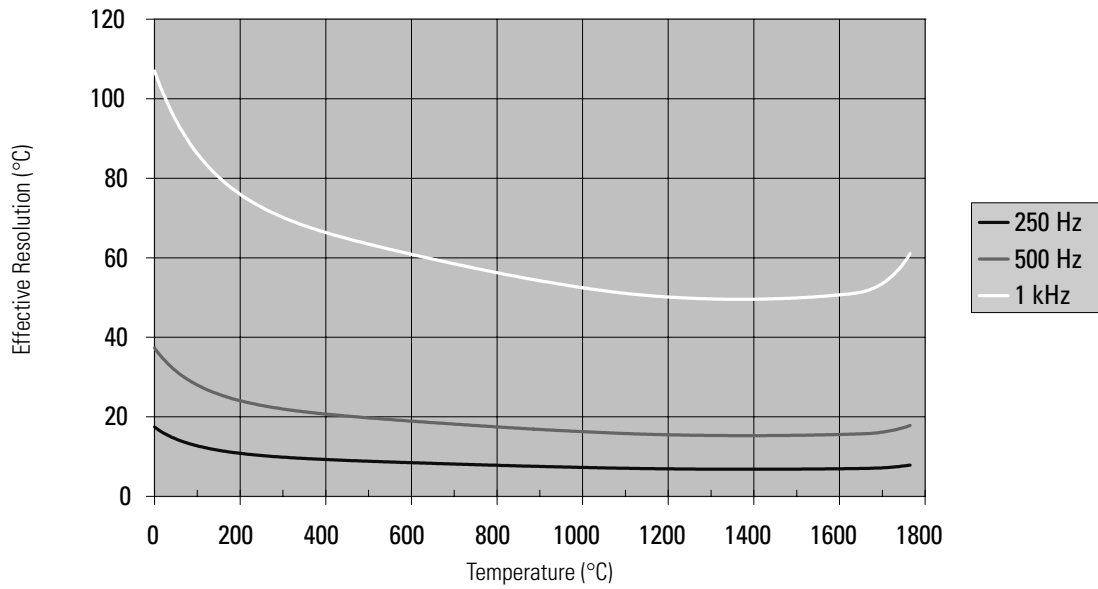

Figure 19 - Effective Resolution versus Input Filter Selection for Type S Thermocouples Using 10, 50, and 60 Hz Filters

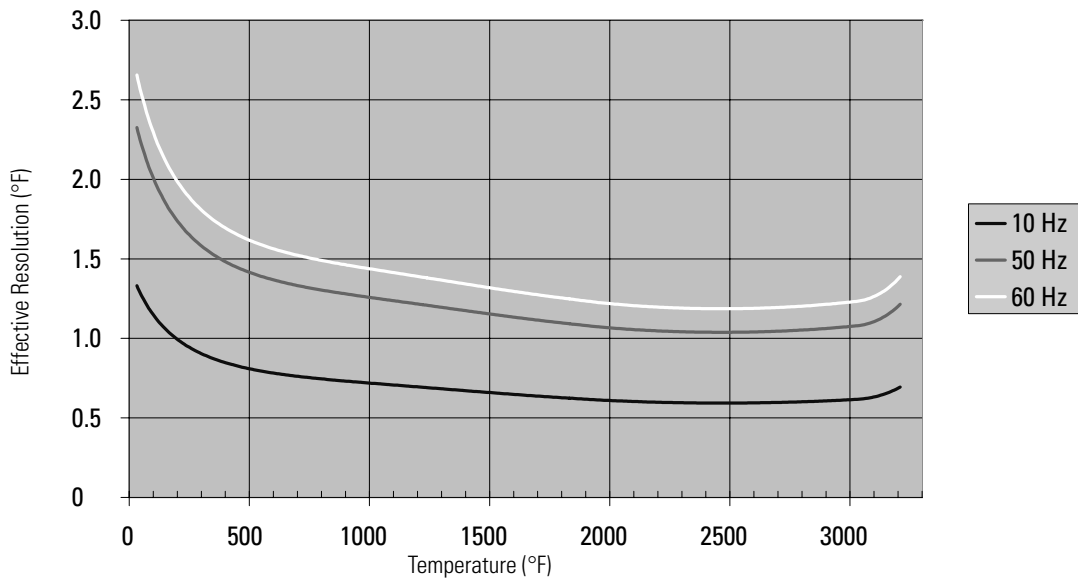
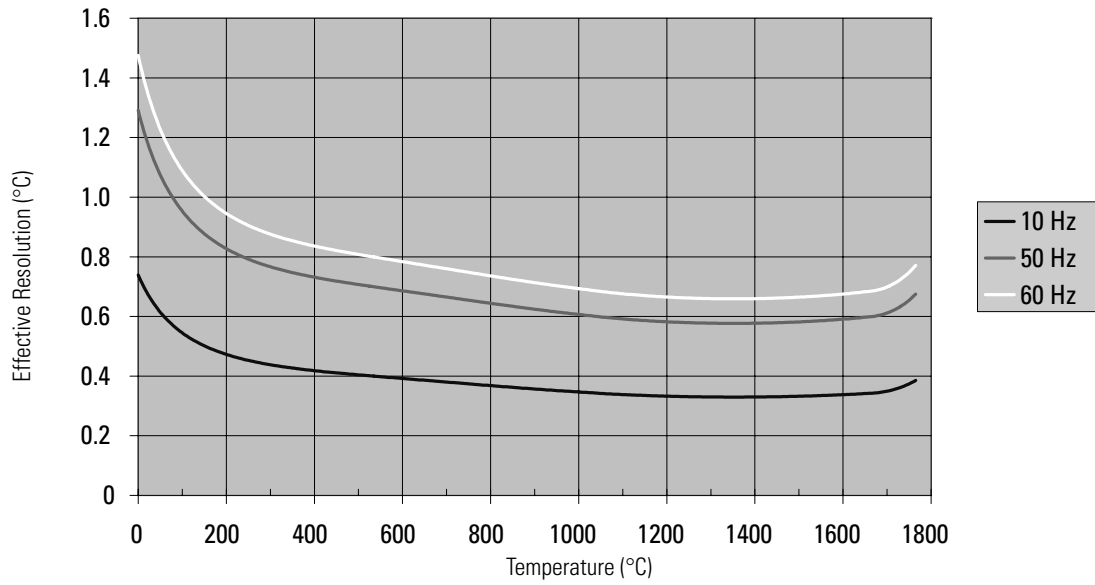

Figure 20 - Effective Resolution versus Input Filter Selection for Type S Thermocouples Using 250, 500, and 1 kHz Filters

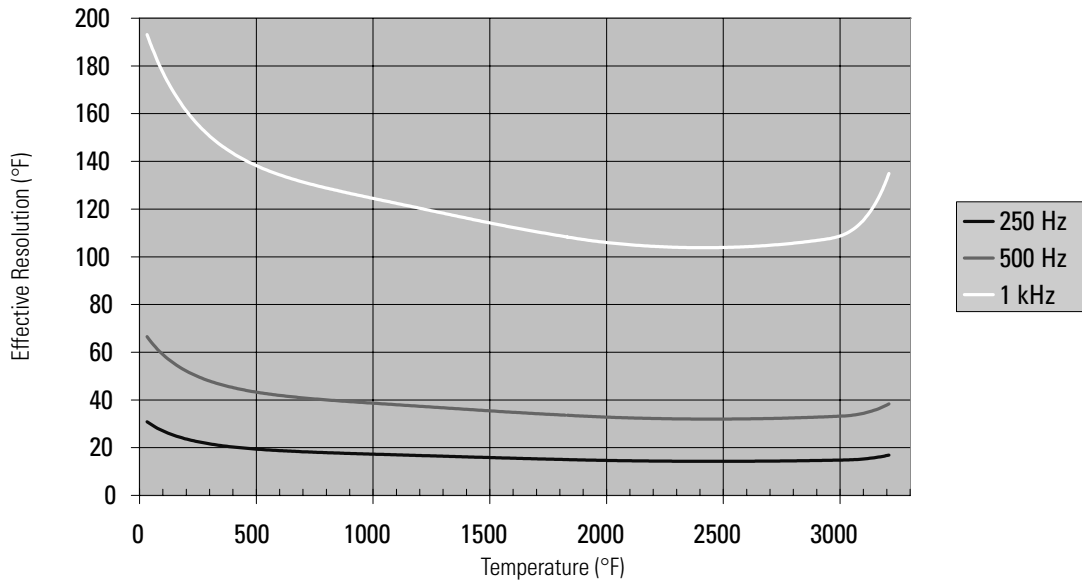
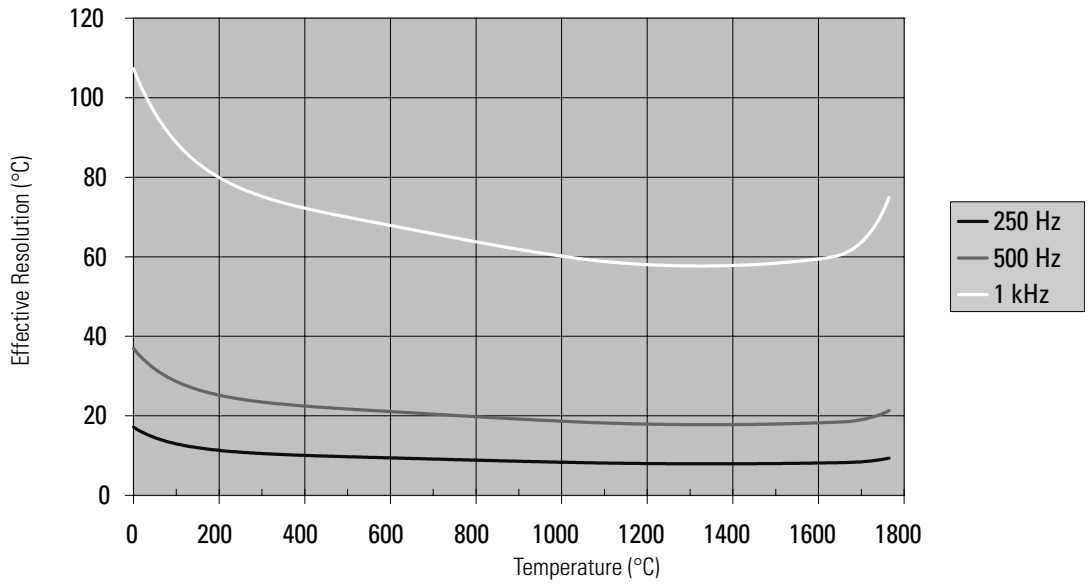

Figure 21 - Effective Resolution versus Input Filter Selection for Type T Thermocouples Using 10, 50, and 60 Hz Filters

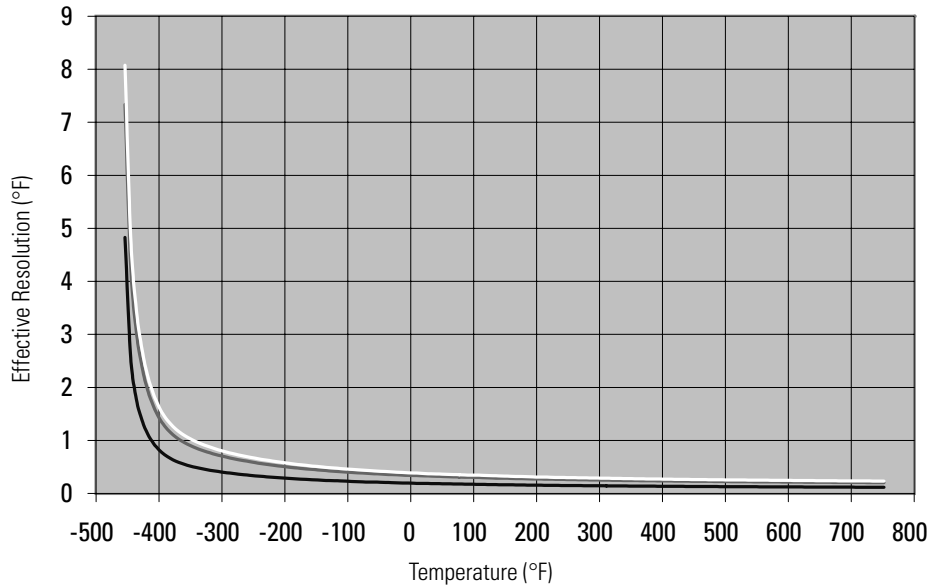
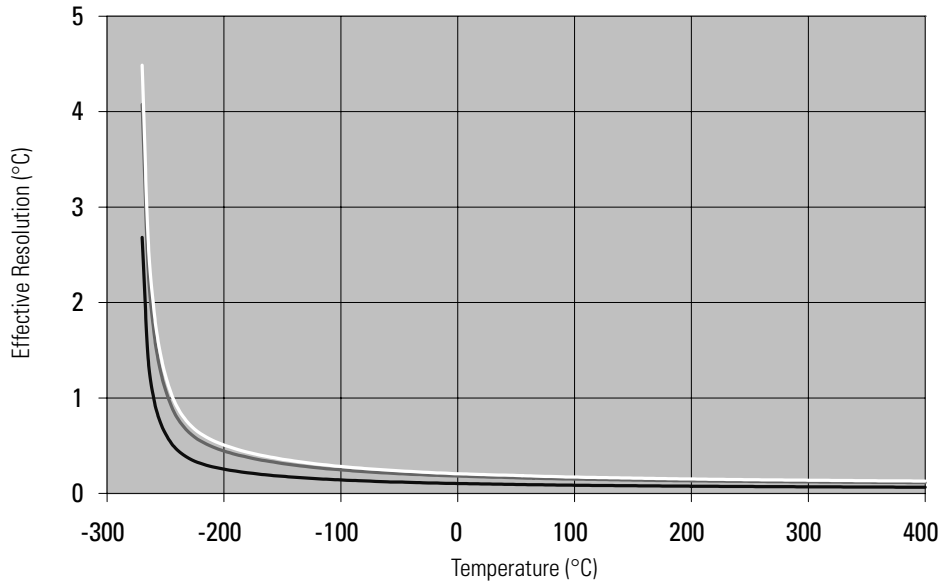

Figure 22 - Effective Resolution versus Input Filter Selection for Type T Thermocouples Using 250, 500, and 1 kHz Filters

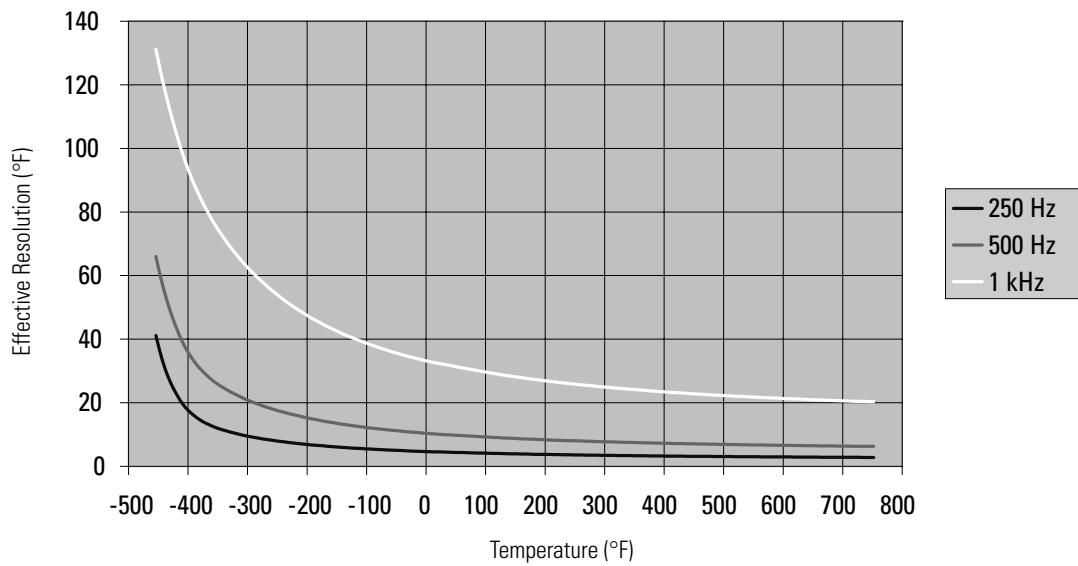
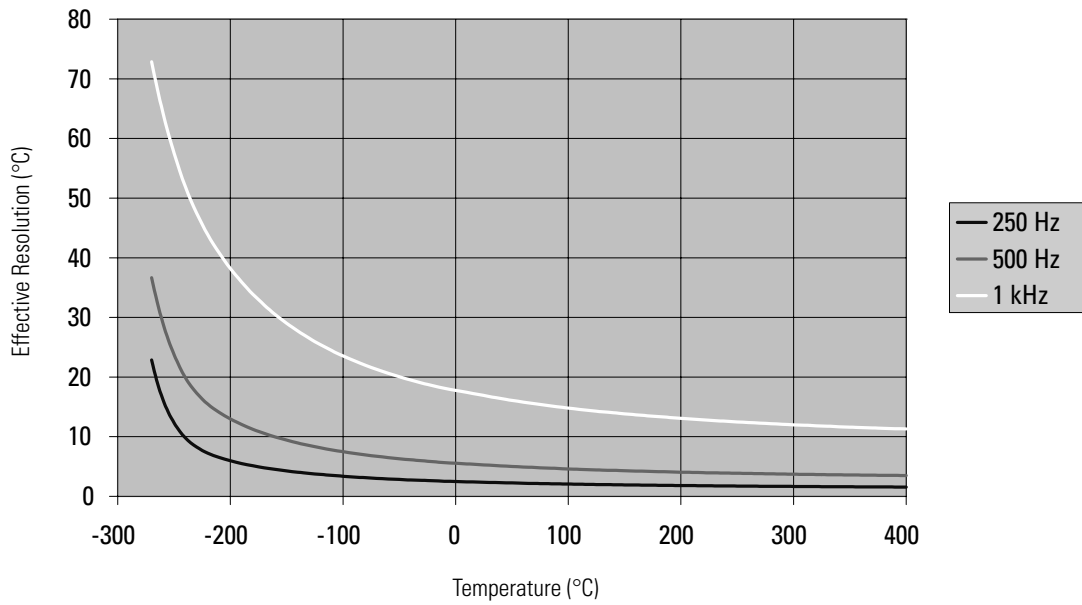

Table 6 - Effective Resolution versus Input Filter Selection for Millivolt Inputs

Filter Frequency	±50 mV	±100 mV
10 Hz	6 µV	6 µV
50 Hz	9 µV	12 µV
60 Hz	9 µV	12 µV
250 Hz	125 µV	150 µV
500 Hz	250 µV	300 µV
1 kHz	1000 µV	1300 µV

The table below identifies the number of significant bits used to represent the input data for each available filter frequency. The number of significant bits is defined as the number of bits that will have little or no jitter due to noise, and is used in defining the effective resolution.

TIP The resolutions provided by the filters apply to the raw/proportional data format only.

Determining Module Update Time

The module update time is defined as the time required for the module to sample and convert the input signals of all enabled input channels and provide the resulting data values to the processor. Module update time can be calculated by adding the sum of all enabled channel's times. The module sequentially samples the enabled channels in a continuous loop as shown below.

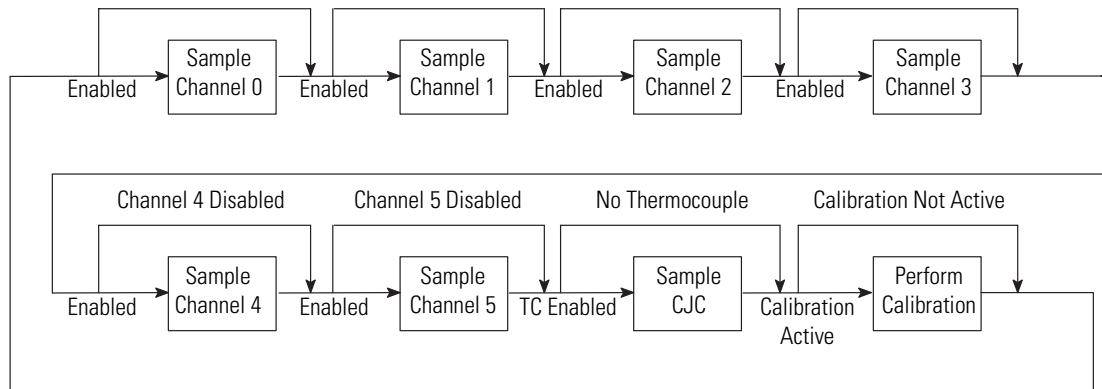

Channel update time is dependent upon the input filter selection. This table shows the channel update times.

Table 7 - Channel Update Time

Filter Frequency	Channel Update Time
10 Hz	303 ms
50 Hz	63 ms
60 Hz	53 ms
250 Hz	15 ms
500 Hz	9 ms
1 kHz	7 ms

The CJC input is sampled only if one or more channels are enabled for any thermocouple type. The CJC update time is equal to the largest channel update time of any of the enabled thermocouple inputs types. In that case, a single CJC update is done per scan. See the scan diagram on the previous page. The cyclic calibration time applies only when cyclic calibration is enabled and active. If enabled, the cyclic calibration is staggered over several scan cycles once every five minutes to limit the overall impact to module update time.

Effects of Autocalibration on Module Update Time

The module's autocalibration feature allows it to correct for accuracy errors caused by temperature drift over the module operating temperature range (0...60 °C (32...140 °F)). Autocalibration occurs automatically on a system mode change from Program-to-Run for all configured channels or if any online⁽¹⁾ configuration change is made to a channel. In addition, you can configure the module to perform autocalibration every 5 minutes during normal operation, or you can disable this feature by using the Enable/Disable Cyclic Calibration function (default is enabled). This feature allows you to implement a calibration cycle anytime, at your command, by enabling and then disabling this bit.⁽¹⁾

(1) Not all controllers allow online configuration changes. Refer to your controller's user manual for details. During an online configuration change, input data for the affected channel is not updated by the module.

If you enable the cyclic autocalibration function, the module update time increases when the autocalibration occurs. To limit its impact on the module update time, the autocalibration function is divided over two module scans. The first part (offset/0) of a channel calibration adds 71 ms and the second part (gain/span) adds 112 ms to the module update. This takes place over two consecutive module scans. Each enabled channel requires a separate offset/0 and gain/span cycle, unless **any** channel to be scanned uses an Input Type of the same Input Class as **any previously calibrated** channel. See the figure on [page 69](#) and the Input Class table below. In that case, offset and gain calibration values from the previous channel are used, and no additional time is required.

Table 8 - Input Class

Input Type	Input Class
Thermocouples B, C, R, S, and T	1
Thermocouples E, J, K, and N	2
50 mV	2
100 mV	3
CJC Sensors	4

Calculating Module Update Time

To determine the module update time, add the individual channel update times for each enabled channel and the CJC update time if any of the channels are enabled as thermocouple inputs.

EXAMPLE 1. Two Channels Enabled for Millivolt Inputs

Channel 0: ± 50 mV with 60 Hz filter

Channel 1 Input: ± 50 mV with 500 Hz filter

From Channel Update Time, on [page 42](#).

Module Update Time

= Ch 0 Update Time + Ch 1 Update Time

= 53 ms + 9 ms

= 62 ms

EXAMPLE 2. Three Channels Enabled for Different Inputs

Channel 0 Input: Type J Thermocouple with 10 Hz filter

Channel 1 Input: Type J Thermocouple with 60 Hz filter

Channel 2 Input: ± 100 mV with 250 Hz filter

From Channel Update Time, on [page 42](#).

Module Update Time

= Ch 0 Update Time + Ch 1 Update Time

+ Ch 2 Update Time + CJC Update Time (uses lowest thermocouple filter selected)

= 303 ms + 53 ms + 15 ms + 303 ms

= 674 ms

EXAMPLE 3. Three Channels Enabled for Different Inputs with Cyclic Calibration Enabled

Channel 0 Input: Type T Thermocouple with 60 Hz Filter

Channel 1 Input: Type T Thermocouple with 60 Hz Filter

Channel 2 Input: Type J Thermocouple with 60 Hz Filter

From Channel Update Time, on [page 42](#).

Module Update Time 'without' an Autocalibration Cycle

= Ch 0 Update Time + Ch 1 Update Time

+ Ch 2 Update Time + CJC Update Time (uses lowest thermocouple filter selected)

= 53 ms + 53 ms + 53 ms + 53 ms = 212 ms

Module Update Time 'during' an Autocalibration Cycle

Channel 0 Scan 1 (Module Scan 1)

= Ch 0 Update Time + Ch 1 Update Time

+ Ch 2 Update Time + CJC Update Time + 'Ch 0 Gain Time'

= 53 ms + 53 ms + 53 ms + 53 ms + '112 ms' = 324 ms

Channel 0 Scan 3 (Module Scan 2)

= Ch 0 Update Time + Ch 1 Update Time

+ Ch 2 Update Time + CJC Update Time + 'Ch 0 Offset Time'

= 53 ms + 53 ms + 53 ms + 53 ms + '71 ms' = 283 ms

Channel 1 Scan 1 (no scan impact)

No autocalibration cycle is required because Channel 1 is the same Input Class as Channel 0. Data is updated in scan 3.

Channel 2 Scan 1 (Module Scan 3)

= Ch 0 Update Time + Ch 1 Update Time

+ Ch 2 Update Time + CJC Update Time + 'Ch 2 Gain Time'

= 53 ms + 53 ms + 53 ms + 53 ms + '112 ms' = 324 ms

Channel 2 Scan 2 (Module Scan 4)

= Ch 0 Update Time + Ch 1 Update Time

+ Ch 2 Update Time + CJC Update Time + 'Ch 2 Offset Time'

= 53 ms + 53 ms + 53 ms + 53 ms + '71 ms' = 283 ms

CJC Scan 1 (Module Scan 5)

= Ch 0 Update Time + Ch 1 Update Time

+ Ch 2 Update Time + CJC Update Time + 'CJC Gain Time'

= 53 ms + 53 ms + 53 ms + 53 ms + '112 ms' = 324 ms

CJC Scan 2 (Module Scan 6)

= Ch 0 Update Time + Ch 1 Update Time

+ Ch 2 Update Time + CJC Update Time + 'CJC Offset Time'

= 53 ms + 53 ms + 53 ms + 53 ms + '71 ms' = 283 ms

After the above cycles are complete, the module returns to scans without autocalibration for approximately 5 minutes. At that time, the autocalibration cycle repeats.

Impact of Autocalibration on Module Startup During Mode Change

Regardless of the selection of the Enable/Disable Cyclic Calibration function, an autocalibration cycle occurs automatically on a mode change from Program-to-Run and on subsequent module startups/initialization for all configured channels. During module startup, input data is not updated by the module and the General Status bits (S0 through S5) are set to 1, indicating a Data Not Valid condition. The amount of time it takes the module to start up is dependent on channel filter frequency selections as indicated in [Channel Update Time, on page 69](#). This is an example calculation of module start-up time.

EXAMPLE Two Channels Enabled for Different Inputs

Channel 0 Input: Type T Thermocouple with 60 Hz filter

Channel 1 Input: Type J Thermocouple with 60 Hz filter

Module Start-up Time

$$\begin{aligned} &= (\text{Ch 0 Gain Time} + \text{Ch 0 Offset Time}) + (\text{Ch 1 Gain Time} \\ &\quad + \text{Ch 1 Offset Time}) + (\text{CJC Gain Time} + \text{CJC Offset Time}) \\ &\quad + (\text{CJC 0 Data Acquisition} + \text{CJC 1 Data Acquisition} \\ &\quad + \text{Ch 0 Data Acquisition} + \text{Ch 1 Data Acquisition}) \\ &= (112 \text{ ms} + 71 \text{ ms}) + (112 \text{ ms} + 71 \text{ ms}) + (53 \text{ ms} + 53 \text{ ms} \\ &\quad + 53 \text{ ms} + 53 \text{ ms}) \\ &= 183 \text{ ms} + 183 \text{ ms} + 183 \text{ ms} + 212 \text{ ms} = 761 \text{ ms} \end{aligned}$$

Notes:

Diagnostics and Troubleshooting

This chapter describes troubleshooting the thermocouple/mV input module. This chapter contains information on:

- safety considerations while troubleshooting.
- internal diagnostics during module operation.
- module errors.
- contacting Rockwell Automation for technical assistance.

Safety Considerations

Safety considerations are an important element of proper troubleshooting procedures. Actively thinking about the safety of yourself and others, as well as the condition of your equipment, is of primary importance.

The following sections describe several safety concerns you should be aware of when troubleshooting your control system.



ATTENTION: Never reach into a machine to actuate a switch because unexpected motion can occur and cause injury. Remove all electrical power at the main power disconnect switches before checking electrical connections or inputs/outputs causing machine motion.

Indicator Lights

When the green status indicator on the module is illuminated, it indicates that power is applied to the module and that it has passed its internal tests.

Stand Clear of Equipment

When troubleshooting any system anomaly, have all personnel remain clear of the equipment. The anomaly could be intermittent, and sudden unexpected machine motion could occur. Have someone ready to operate an emergency stop switch in case it becomes necessary to shut off power.

Program Alteration

There are several possible causes of alteration to the user program, including extreme environmental conditions, Electromagnetic Interference (EMI), improper grounding, improper wiring connections, and unauthorized tampering. If you suspect a program has been altered, check it against a previously saved master program.

Safety Circuits

Circuits installed on the machine for safety reasons, like over-travel limit switches, stop push buttons, and interlocks, should always be hard-wired to the master control relay. These devices must be wired in series so that when any one device opens, the master control relay is de-energized, thereby removing power to the machine. Never alter these circuits to defeat their function. Serious injury or machine damage could result.

Module Operation versus Channel Operation

The module performs diagnostic operations at both the module level and the channel level. Module-level operations include functions such as power-up, configuration, and communication with a 1769 bus master, such as a MicroLogix 1500 controller, 1769-ADN DeviceNet adapter, or CompactLogix controller.

Channel-level operations describe channel related functions, such as data conversion and over- or under-range detection.

Internal diagnostics are performed at both levels of operation. When detected, module error conditions are immediately indicated by the module status indicator. Both module hardware and channel configuration error conditions are reported to the controller. Channel over-range or under-range and open-circuit conditions are reported in the module's input data table. Module hardware errors are typically reported in the controller's I/O status file. Refer to your controller manual for details.

Power-up Diagnostics

At module powerup, a series of internal diagnostic tests are performed. If these diagnostic tests are not successfully completed, the module status indicator remains off and a module error is reported to the controller.

If module status indicator is	Indicated condition	Corrective action
On	Proper operation	No action required.
Off	Module fault	Cycle power. If condition persists, replace the module. Call your local distributor or Rockwell Automation for assistance.

Channel Diagnostics

When an input channel is enabled, the module performs a diagnostic check to see that the channel has been properly configured. In addition, the channel is tested on every scan for configuration errors, over-range and under-range, and open-circuit conditions.

Invalid Channel Configuration Detection

Whenever a channel configuration word is improperly defined, the module reports an error. See [page 78](#) through [page 81](#) for a description of module errors.

Over-range or Under-range Detection

Whenever the data received at the channel word is out of the defined operating range, an over-range or under-range error is indicated in input data word 7.

Possible causes of an out-of-range condition include the:

- temperature is too hot or cold for the type of thermocouple being used.
- wrong thermocouple is being used for the input type selected, or for the configuration that was programmed.
- input device is faulty.
- signal input from the input device is beyond the scaling range.

Open-circuit Detection

On each scan, the module performs an open-circuit test on all enabled channels. Whenever an open-circuit condition occurs, the open-circuit bit for that channel is set in input data word 6.

Possible causes of an open circuit include:

- the input device is broken.
- a wire is loose or cut.
- the input device is not installed on the configured channel.
- a thermocouple is installed incorrectly.

Non-critical versus Critical Module Errors

Non-critical module errors are typically recoverable. Channel errors (over-range or under-range errors) are non-critical. Non-critical error conditions are indicated in the module input data table.

Critical module errors are conditions that may prevent normal or recoverable operation of the system. When these types of errors occur, the system typically leaves the run or program mode of operation until the error can be dealt with. Critical module errors are indicated in [Table 11 on page 80](#).

Module Error Definition

Analog module errors are expressed in two fields as four-digit hex format with the most significant digit as 'don't care' and irrelevant. The two fields are 'Module Error' and 'Extended Error Information'. The structure of the module error data is shown below.

Table 9 - Module Error Table

'Don't Care' Bits				Module Error			Extended Error Information								
15	14	13	12	11	10	9	8	7	6	5	4	3	2	1	0
0	0	0	0	0	0	0	0	0	0	0	0	0	0	0	0
Hex Digit 4				Hex Digit 3			Hex Digit 2				Hex Digit 1				

Module Error Field

The purpose of the module error field is to classify module errors into three distinct groups, as described in the table below. The type of error determines what kind of information exists in the extended error information field. These types of module errors are typically reported in the controller's I/O status file. Refer to your controller manual for details.

Table 10 - Module Error Types

Error Type	Module Error Field Value Bits 11...9 (binary)	Description
No errors	000	No error is present. The extended error field holds no additional information.
Hardware errors	001	General and specific hardware error codes are specified in the extended error information field.
Configuration errors	010	Module-specific error codes are indicated in the extended error field. These error codes correspond to options that you can change directly. For example, the input range or input filter selection.

Extended-error Information Field

Check the extended error information field when a non-zero value is present in the module error field. Depending upon the value in the module error field, the extended error information field can contain error codes that are module-specific or common to all 1769 analog modules.

TIP If no errors are present in the module error field, the extended error information field is set to zero.

Hardware Errors

General or module-specific hardware errors are indicated by module error code 001. See [Table 11 on page 80](#).

Configuration Errors

If you set the fields in the configuration file to invalid or unsupported values, the module generates a critical error.

[Table 11 on page 80](#) lists the possible module-specific configuration error codes defined for the modules.

Error Codes

This table explains the extended error code.

Table 11 - Extended Error Codes

Error Type	Hex Equivalent ⁽¹⁾	Module Error Code	Extended Error Information Code	Error Description
		Binary	Binary	
No error	X000	000	0 0000 0000	No error
General common hardware error	X200	001	0 0000 0000	General hardware error; no additional information
	X201	001	0 0000 0001	Power-up reset state
Hardware-specific error	X300	001	1 0000 0000	General hardware error; no additional information
	X301	001	1 0000 0001	Microprocessor hardware error; hardware ROM error
	X302	001	1 0000 0010	Hardware EEPROM error
	X303	001	1 0000 0011	Channel 0 calibration error
	X304	001	1 0000 0100	Channel 1 calibration error
	X305	001	1 0000 0101	Channel 2 calibration error
	X306	001	1 0000 0110	Channel 3 calibration error
	X307	001	1 0000 0111	Channel 4 calibration error
	X308	001	1 0000 1000	Channel 5 calibration error
	X309	001	1 0000 1001	CJC0 calibration error
	X30A	001	1 0000 1010	CJC1 calibration error
	X30B	001	1 0000 1011	Channel 0 analog/digital converter error
	X30C	001	1 0000 1100	Channel 1 analog/digital converter error
	X30D	001	1 0000 1101	Channel 2 analog/digital converter error
	X30E	001	1 0000 1110	Channel 3 analog/digital converter error
	X30F	001	1 0000 1111	Channel 4 analog/digital converter error
	X310	001	1 0001 0000	Channel 5 analog/digital converter error
	X311	001	1 0001 0001	CJC0 analog/digital converter error
X312	001	1 0001 0010	CJC1 analog/digital converter error	

Table 11 - Extended Error Codes

Error Type	Hex Equivalent ⁽¹⁾	Module Error Code	Extended Error Information Code	Error Description
		Binary	Binary	
Module-specific configuration error	X400	010	0 0000 0000	General configuration error; no additional information
	X401	010	0 0000 0001	Invalid input type selected (channel 0)
	X402	010	0 0000 0010	Invalid input type selected (channel 1)
	X403	010	0 0000 0011	Invalid input type selected (channel 2)
	X404	010	0 0000 0100	Invalid input type selected (channel 3)
	X405	010	0 0000 0101	Invalid input type selected (channel 4)
	X406	010	0 0000 0110	Invalid input type selected (channel 5)
	X407	010	0 0000 0111	Invalid input filter selected (channel 0)
	X408	010	0 0000 1000	Invalid input filter selected (channel 1)
	X409	010	0 0000 1001	Invalid input filter selected (channel 2)
	X40A	010	0 0000 1010	Invalid input filter selected (channel 3)
	X40B	010	0 0000 1011	Invalid input filter selected (channel 4)
	X40C	010	0 0000 1100	Invalid input filter selected (channel 5)
	X40D	010	0 0000 1101	Invalid input format selected (channel 0)
	X40E	010	0 0000 1110	Invalid input format selected (channel 1)
	X40F	010	0 0000 1111	Invalid input format selected (channel 2)
	X410	010	0 0001 0000	Invalid input format selected (channel 3)
	X411	010	0 0001 0001	Invalid input format selected (channel 4)
	X412	010	0 0001 0010	Invalid input format selected (channel 5)
	X413	010	0 0001 0011	An unused bit has been set for channel 0
X414	010	0 0001 0100	An unused bit has been set for channel 1	
X415	010	0 0001 0101	An unused bit has been set for channel 2	
X416	010	0 0001 0110	An unused bit has been set for channel 3	
X417	010	0 0001 0111	An unused bit has been set for channel 4	
X418	010	0 0001 1000	An unused bit has been set for channel 5	
X419	010	0 0001 1001	Invalid module-configuration register	

(1) X represents the 'Don't Care' digit.

Module Inhibit Function

Some controllers support the module inhibit function. See your controller manual for details.

Whenever the 1769-IT6 module is inhibited, the module continues to provide information about changes at its inputs to the 1769 CompactBus master (for example, a CompactLogix controller).

Contacting Rockwell Automation

If you need to contact Rockwell Automation for assistance, please have the following information available when you call:

- A clear statement of the anomaly, including a description of what the system is actually doing. Note the status indicator state; also note data and configuration words for the module.
- A list of remedies you have already tried.
- Processor type and firmware number (see the label on the processor).
- Hardware types in the system, including all I/O modules.
- Fault code, if the processor is faulted.

Specifications

Table 12 - General Specifications - 1769-IT6

Attribute	1769-IT6
Dimensions (HxDxW), approx.	118 x 87 x 35 mm (4.65 x 3.43 x 1.38 in.) height including mounting tabs is 138 mm (5.43 in.)
Shipping weight (with carton), approx.	276 g (0.61 lb)
Storage temperature	-40...85 °C (-40...185 °F)
Operating temperature	0...60 °C (32...140 °F)
Operating humidity	5...95% noncondensing
Operating altitude	2000 m (6561 ft)
Vibration, operating	10...500 Hz, 5 g, 0.030 in. peak-to-peak
Vibration, relay operation	2 g
Shock, operating	30 g, 11 ms panel mounted (20 g, 11 ms DIN rail mounted)
Shock, relay operation	7.5 g panel mounted (5 g DIN rail mounted)
Shock, nonoperating	40 g panel mounted (30 g DIN rail mounted)
System power-supply distance rating	8 (The module may not be more than 7 modules away from a system power supply.)
Recommended cable	Belden 8761 (shielded) for millivolt inputs Shielded thermocouple extension wire for the specific type of thermocouple you are using. Follow thermocouple manufacturer's recommendations.
Agency certification	C-UL certified (under CSA C22.2 No. 142) UL 508 listed CE compliant for all applicable directives
Hazardous environment class	Class I, Division 2, Hazardous Location, Groups A, B, C, D (UL 1604, C-UL under CSA C22.2 No. 213)
Radiated and conducted emissions	EN50081-2 Class A

Table 12 - General Specifications - 1769-IT6

Attribute	1769-IT6
Electrical /EMC	The module has passed testing at the following levels.
ESD immunity (IEC61000-4-2)	4 kV contact, 8 kV air, 4 kV indirect
Radiated immunity (IEC61000-4-3)	10 V/m , 80...1000 MHz, 80% amplitude modulation, 900 MHz keyed carrier
Fast transient burst (IEC61000-4-4)	2 kV, 5 kHz
Surge immunity (IEC61000-4-5)	1kV galvanic gun
Conducted immunity (IEC61000-4-6)	10V, 0.15 to 80MHz ⁽¹⁾ ⁽²⁾

⁽¹⁾ Conducted immunity frequency range may be 150 kHz...30 MHz if the radiated immunity frequency range is 30...1000 MHz.

⁽²⁾ For grounded thermocouples, the 10V level is reduced to 3V.

Table 13 - Input Specifications - 1769-IT6

Attribute	1769-IT6
Number of inputs	6 input channels plus 2 CJC sensors
Bus current draw, max	100 mA at 5V DC 40 mA at 24V DC
Heat dissipation	1.5 total W (The Watts per point, plus the minimum Watts, with all points energized.)
Converter type	Delta Sigma
Response speed per channel	Input filter and configuration dependent. See Effects of Filter Frequency on Channel Step Response on page 47.
Rated working voltage ⁽¹⁾	30V AC/30V DC
Common mode voltage range ⁽²⁾	±10V max per channel
Common mode rejection	115 dB (min) at 50 Hz (with 10 Hz or 50 Hz filter) 115 dB (min) at 60 Hz (with 10 Hz or 60 Hz filter)
Normal mode rejection ratio	85 dB (min) at 50 Hz (with 10 Hz or 50 Hz filter) 85 dB (min) at 60 Hz (with 10 Hz or 60 Hz filter)
Cable impedance, max	25 W (for specified accuracy)
Input impedance	>10 MW
Open-circuit detection time	7 ms to 2.1s ⁽³⁾
Calibration	The module performs autocalibration upon powerup and whenever a channel is enabled. You can also program the module to calibrate every five minutes.
Non-linearity (in percent full scale)	±0.03%
Module error over full temperature range (0...60 °C (32...140 °F))	See page 86 .
CJC sensor accuracy	±0.3 °C (±0.54 °F)
CJC accuracy	±1.0 °C (±1.8 °F)
Overload at input terminals, max	±35V DC continuous ⁽⁴⁾
Input group to bus isolation	720V DC for 1 min (qualification test) 30V AC/30V DC working voltage
Input channel configuration	Via configuration software or the user program (by writing a unique bit pattern into the module's configuration file). Refer to your controller's user manual to determine if user program configuration is supported.

Table 13 - Input Specifications - 1769-IT6

Attribute	1769-IT6
Module OK status indicator	On: module has power, has passed internal diagnostics, and is communicating over the bus. Off: Any of the above is not true.
Channel diagnostics	Over- or under-range and open-circuit by bit reporting
Vendor I.D. code	1
Product type code	10
Product code	36

- (1) Rated working voltage is the maximum continuous voltage that can be applied at the input terminal, including the input signal and the value that floats above ground potential (for example, 30V DC input signal and 20V DC potential above ground).
- (2) For proper operation, both the plus and minus input terminals must be within $\pm 10V$ DC of analog common.
- (3) Open-circuit detection time is equal to the module scan time, which is based on the number of enabled channels, and the filter frequency of each channel.
- (4) Maximum current input is limited due to input impedance.

Table 14 - Repeatability at 25 °C (77 °F)⁽¹⁾ (2)

Input Type	Repeatability for 10 Hz Filter
Thermocouple J	± 0.1 °C (± 0.18 °F)
Thermocouple N (-110...1300 °C (-166...2372 °F))	± 0.1 °C (± 0.18 °F)
Thermocouple N (-210...-110 °C (-346...-166 °F))	± 0.25 °C (± 0.45 °F)
Thermocouple T (-170...400 °C (-274...752 °F))	± 0.1 °C (± 0.18 °F)
Thermocouple T (-270...-170 °C (-454...-274 °F))	± 1.5 °C (± 2.7 °F)
Thermocouple K (-270...1370 °C (-454...2498 °F))	± 0.1 °C (± 0.18 °F)
Thermocouple (-270...-170 °C (-454...-274 °F))	± 2.0 °C (± 3.6 °F)
Thermocouple E (-220...1000 °C (-364...1832 °F))	± 0.1 °C (± 0.18 °F)
Thermocouple E (-270...-220 °C (-454...-364 °F))	± 1.0 °C (± 1.8 °F)
Thermocouples S and R	± 0.4 °C (± 0.72 °F)
Thermocouple C	± 0.7 °C (± 1.26 °F)
Thermocouple B	± 0.2 °C (± 0.36 °F)
± 50 mV	± 6 μ V
± 100 mV	± 6 μ V

- (1) Repeatability is the ability of the input module to register the same reading in successive measurements for the same input signal.
- (2) Repeatability at any other temperature in the 0...60 °C (32...140 °F) range is the same as long as the temperature is stable.

Table 15 - Accuracy

Input Type ⁽¹⁾	With Autocalibration Enabled		Without Autocalibration
	Accuracy ^{(2) (3)} for 10 Hz, 50 Hz, and 60 Hz Filters, max		Temperature Drift, max ^{(2) (4)}
	At 25 °C (77 °F) Ambient	At 0...60 °C (32...140 °F) Ambient	At 0...60 °C (32...140 °F) Ambient
Thermocouple J (-210...1200 °C (-346...2192 °F))	±0.6 °C (± 1.1 °F)	±0.9 °C (± 1.7 °F)	±0.0218 °C/°C (±0.0218 °F/°F)
Thermocouple N (-200...1300 °C (-328...2372 °F))	±1 °C (± 1.8 °F)	±1.5 °C (±2.7 °F)	±0.0367 °C/°C (±0.0367 °F/°F)
Thermocouple N (-210...-200 °C (-346...-328 °F))	±1.2 °C (±2.2 °F)	±1.8 °C (±3.3 °F)	±0.0424 °C/°C (±0.0424 °F/°F)
Thermocouple T (-230...400 °C (-382...752 °F))	±1 °C (± 1.8 °F)	±1.5 °C (±2.7 °F)	±0.0349 °C/°C (±0.0349 °F/°F)
Thermocouple T (-270...-230 °C (-454...-382 °F))	±5.4 °C (± 9.8 °F)	±7.0 °C (±12.6 °F)	±0.3500 °C/°C (±0.3500 °F/°F)
Thermocouple K (-230...1370 °C (-382...2498 °F))	±1 °C (± 1.8 °F)	±1.5 °C (±2.7 °F)	±0.4995 °C/°C (±0.4995 °F/°F)
Thermocouple K (-270...-225 °C (-454...-373 °F))	±7.5 °C (± 13.5 °F)	±10 °C (±18 °F)	±0.0378 °C/°C (±0.0378 °F/°F)
Thermocouple E (-210...1000 °C (-346...1832 °F))	±0.5 °C (± 0.9 °F)	±0.8 °C (±1.5 °F)	±0.0199 °C/°C (±0.0199 °F/°F)
Thermocouple E (-270...-210 °C (-454...-346 °F))	±4.2 °C (± 7.6 °F)	±6.3 °C (±11.4 °F)	±0.2698 °C/°C (±0.2698 °F/°F)
Thermocouple R	±1.7 °C (± 3.1 °F)	±2.6 °C (± 4.7 °F)	±0.0613 °C/°C (±0.0613 °F/°F)
Thermocouple S	±1.7 °C (± 3.1 °F)	±2.6 °C (± 4.7 °F)	±0.0600 °C/°C (±0.0600 °F/°F)
Thermocouple C	±1.8 °C (±3.3 °F)	±3.5 °C (±6.3 °F)	±0.0899 °C/°C (±0.0899 °F/°F)
Thermocouple B	±3.0 °C (±5.4 °F)	±4.5 °C (±8.1 °F)	±0.1009 °C/°C (±0.1009 °F/°F)
±50 mV	±15 µV	±25 µV	±0.44 µV/°C (±0.80 µV/°F)
±100 mV	±20 µV	±30 µV	±0.69 µV/°C (±1.25 µV/°F)

⁽¹⁾ The module uses the National Institute of Standards and Technology (NIST) ITS-90 standard for thermocouple linearization.

⁽²⁾ Accuracy and temperature drift information does not include the affects of errors or drift in the cold junction compensation circuit.

⁽³⁾ Accuracy is dependent upon the analog/digital converter output rate selection, data format, and input noise.

⁽⁴⁾ Temperature drift with autocalibration is slightly better than without autocalibration.

TIP

For more detailed accuracy and drift information, see the accuracy graphs on [page 87](#) through [page 104](#) and the temperature drift graphs on [page 105](#) through [page 109](#).

Accuracy versus Thermocouple Temperature and Filter Frequency

The following graphs show the module's accuracy when operating at 25 °C (77 °F) for each thermocouple type over the thermocouple's temperature range for each frequency. The effect of errors in cold junction compensation is not included.

Figure 23 - Module Accuracy at 25 °C (77 °F) Ambient for Type B Thermocouple Using 10, 50, and 60 Hz Filter

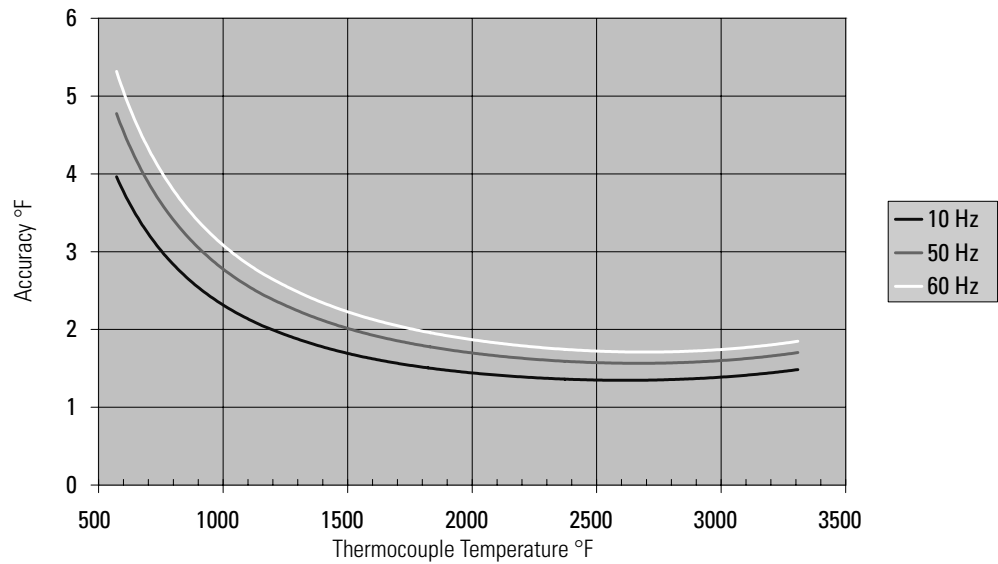
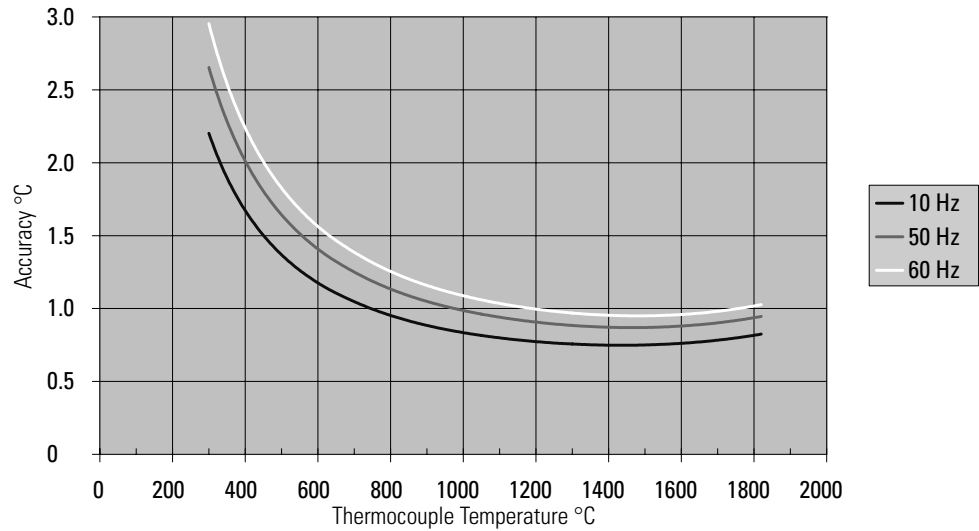

Figure 24 - Module Accuracy at 25 °C (77 °F) Ambient for Type B Thermocouple Using 250, 500, and 1 kHz Filter

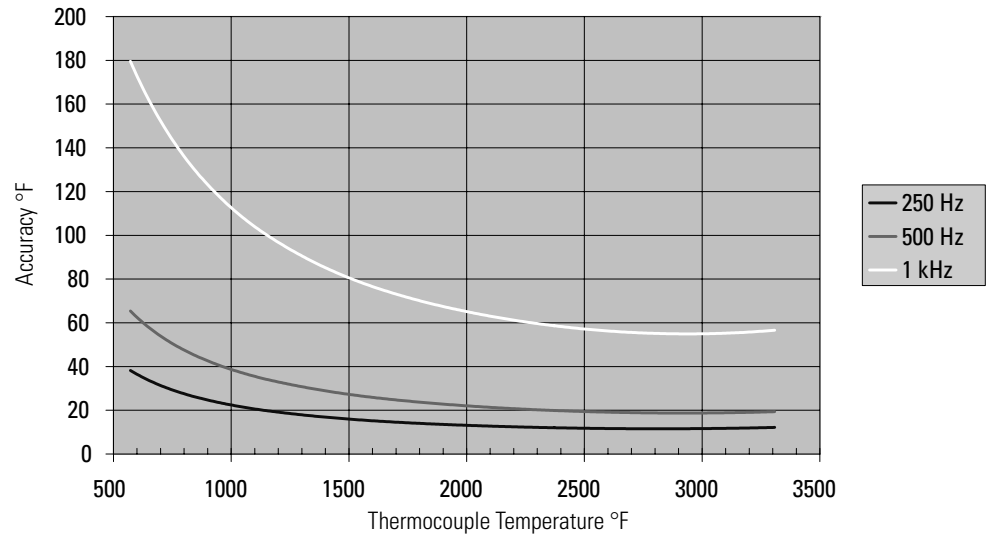
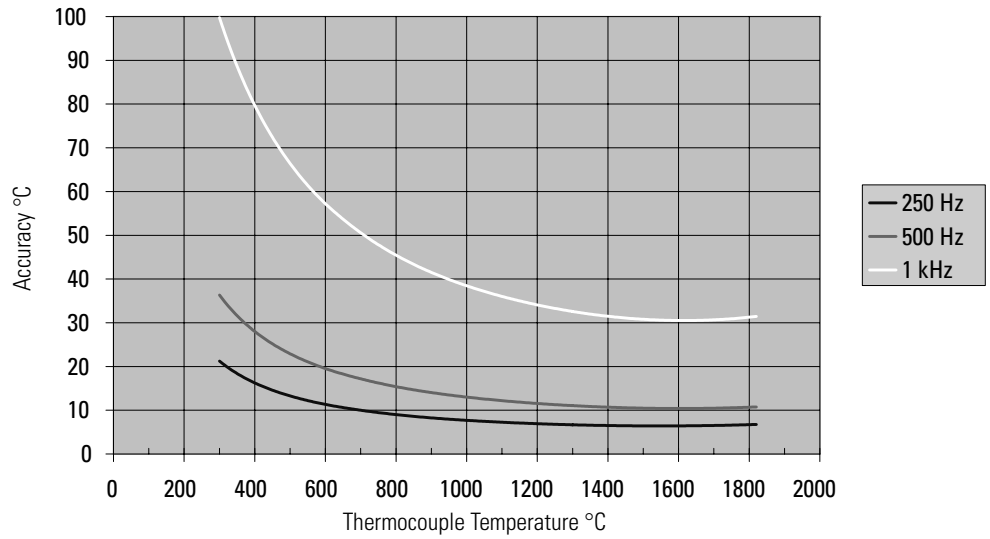

Figure 25 - Module Accuracy at 25 °C (77 °F) Ambient for Type C Thermocouple Using 10, 50, and 60 Hz Filter

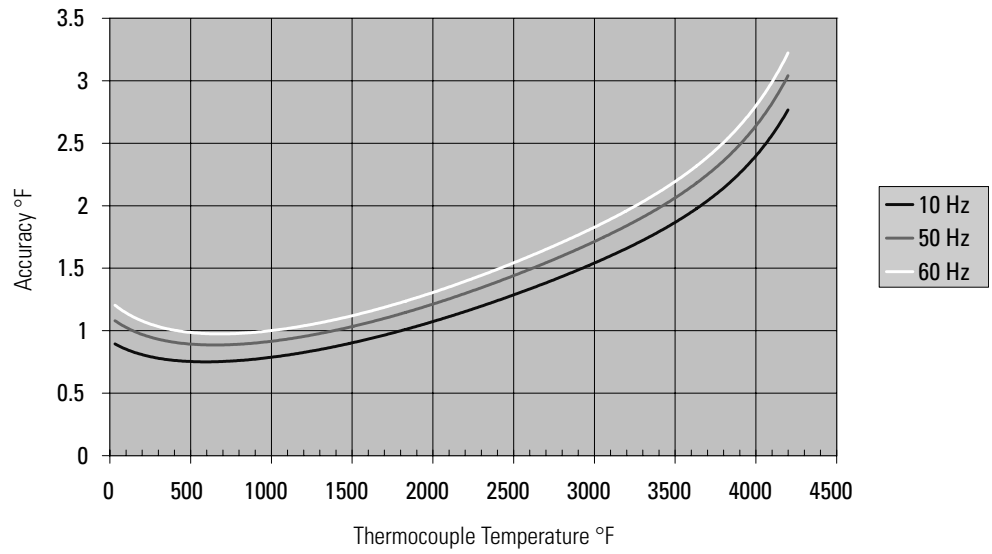
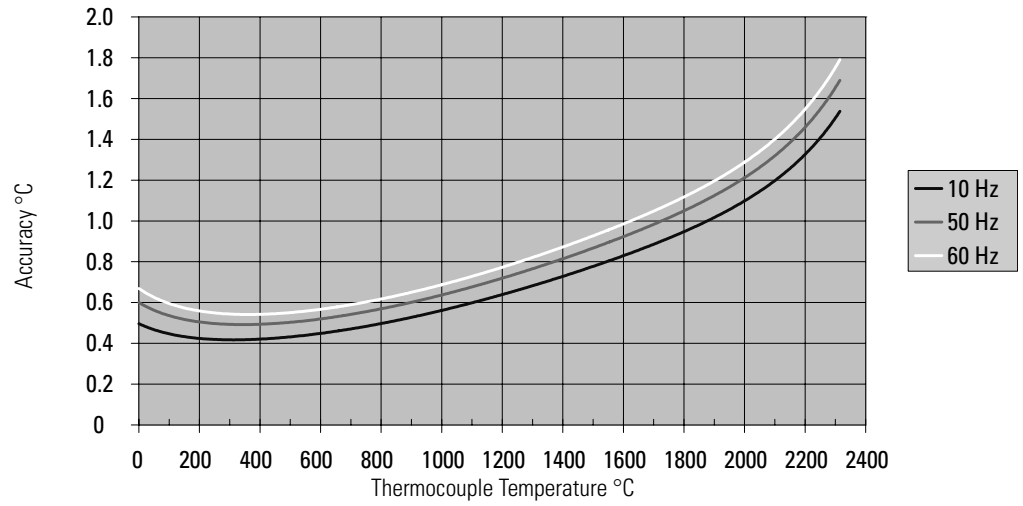

Figure 26 - Module Accuracy at 25 °C (77 °F) Ambient for Type C Thermocouple Using 250, 500, and 1 kHz Filter

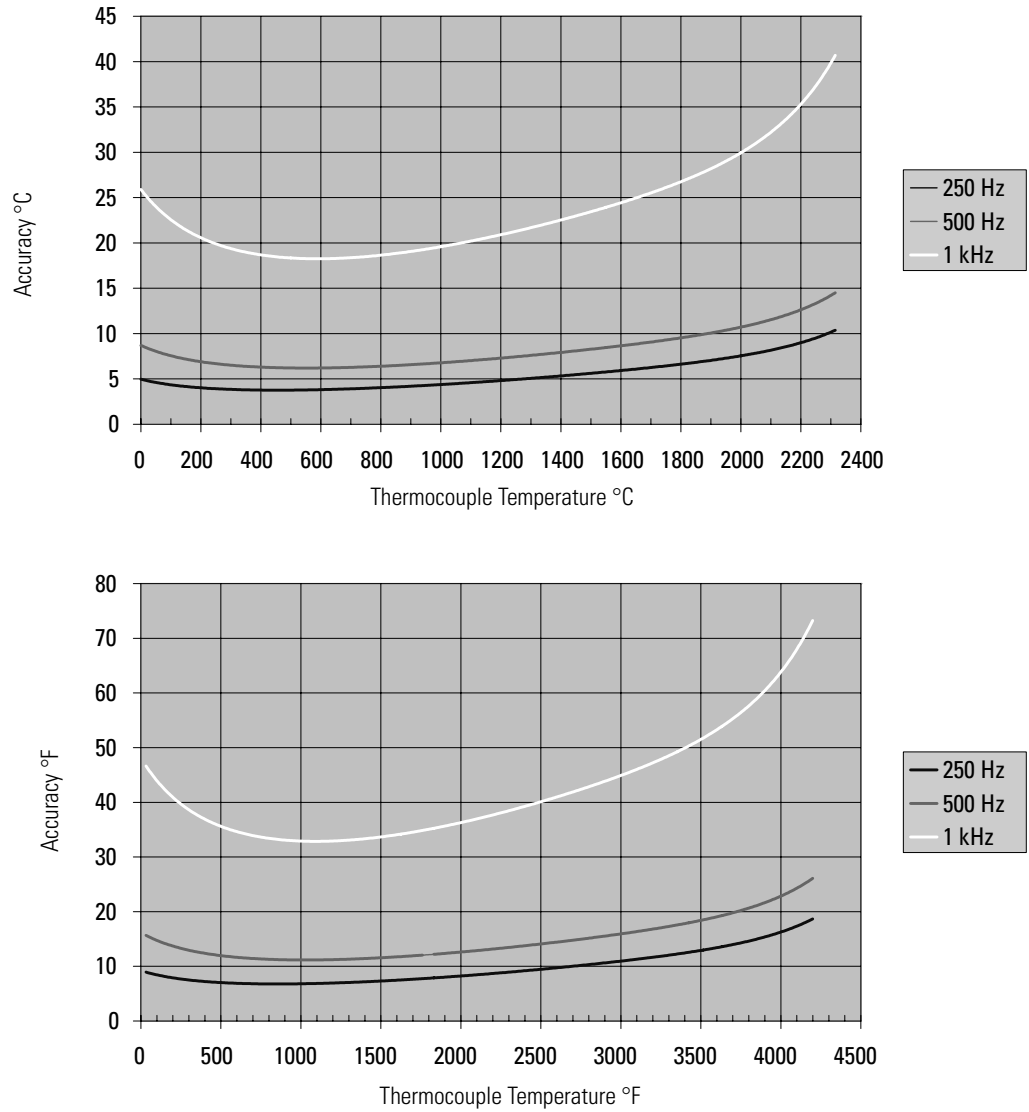

Figure 27 - Module Accuracy at 25 °C (77 °F) Ambient for Type E Thermocouple Using 10, 50, and 60 Hz Filter

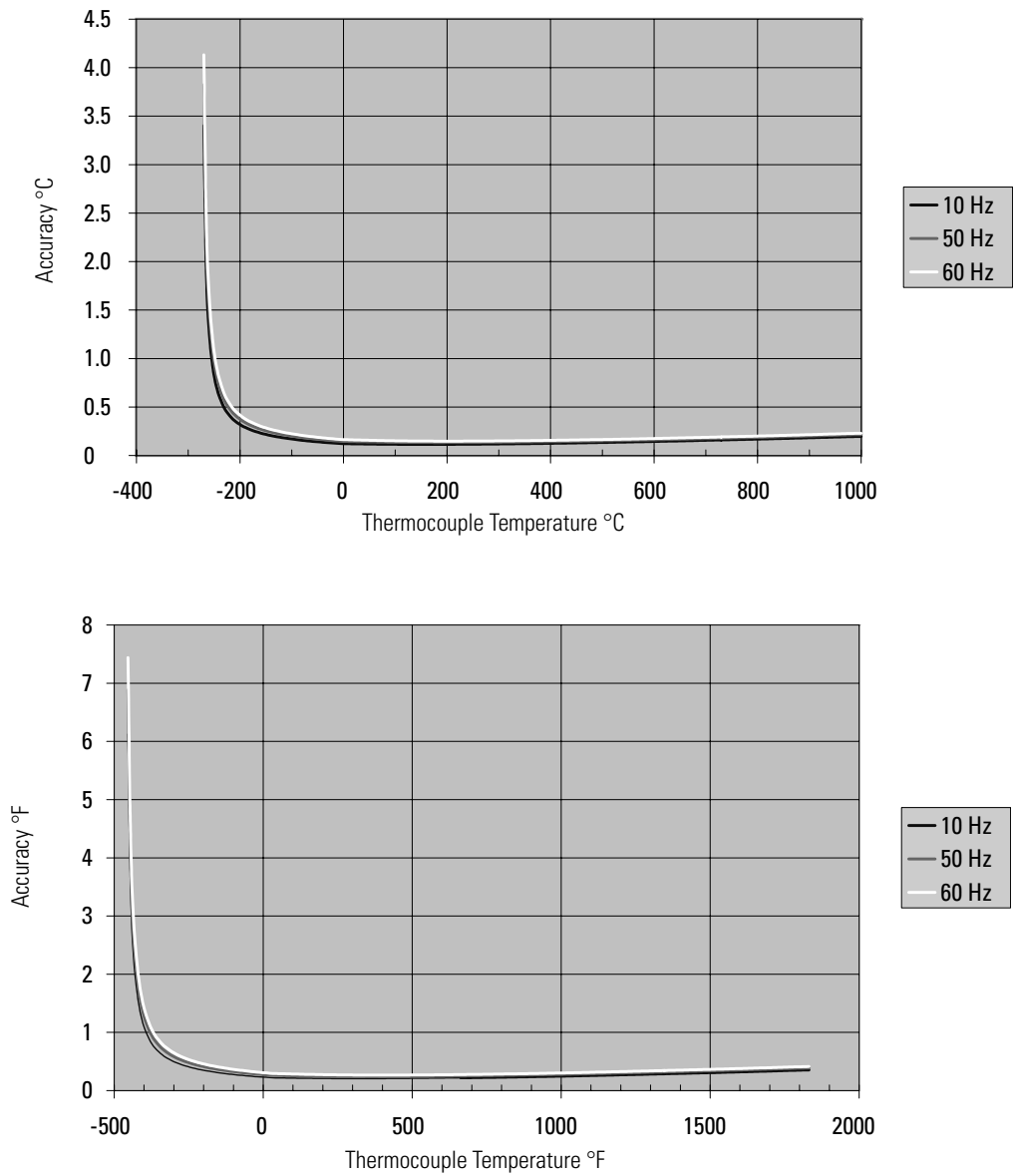

Figure 28 - Module Accuracy at 25 °C (77 °F) Ambient for Type E Thermocouple Using 250, 500, and 1 kHz Filter

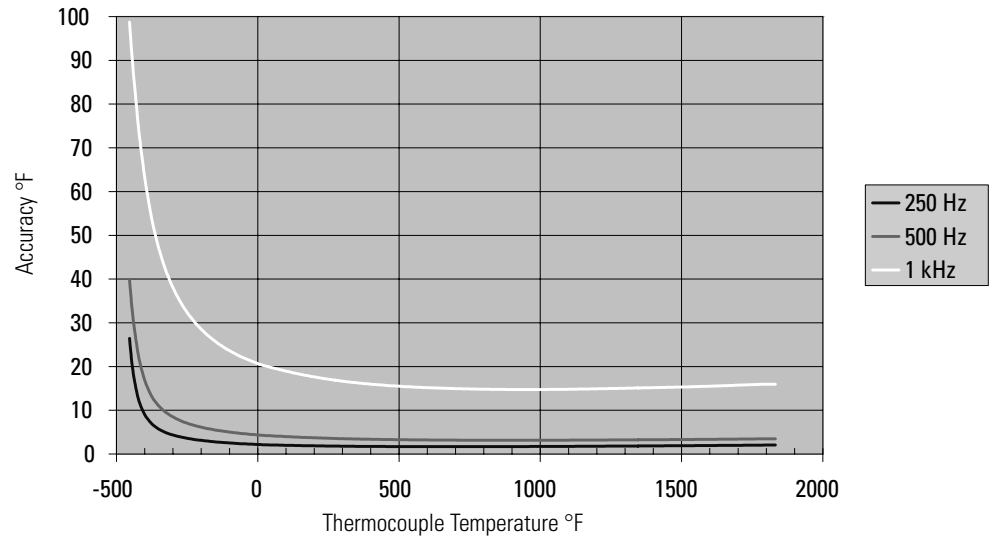
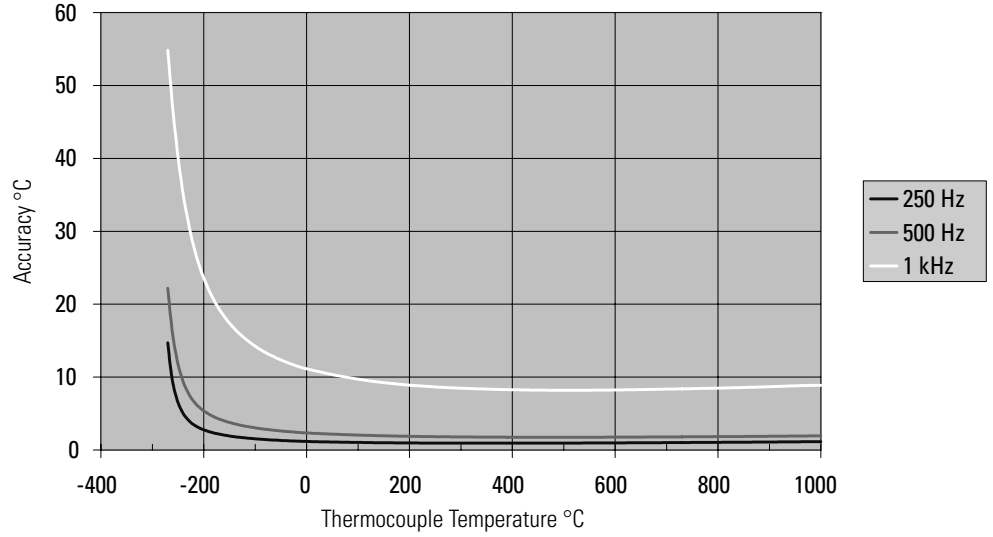

Figure 29 - Module Accuracy at 25 °C (77 °F) Ambient for Type J Thermocouple Using 10, 50, and 60 Hz Filter

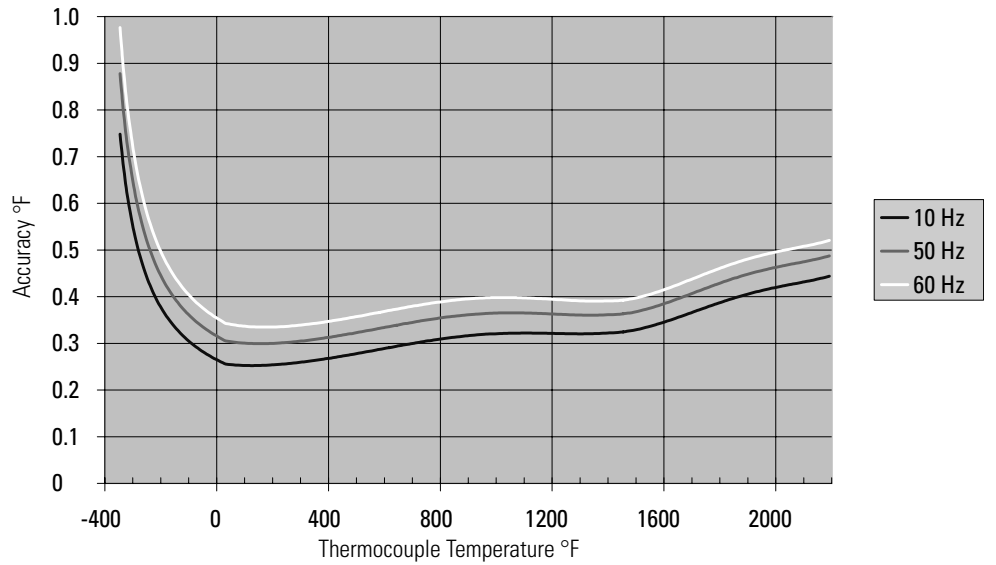
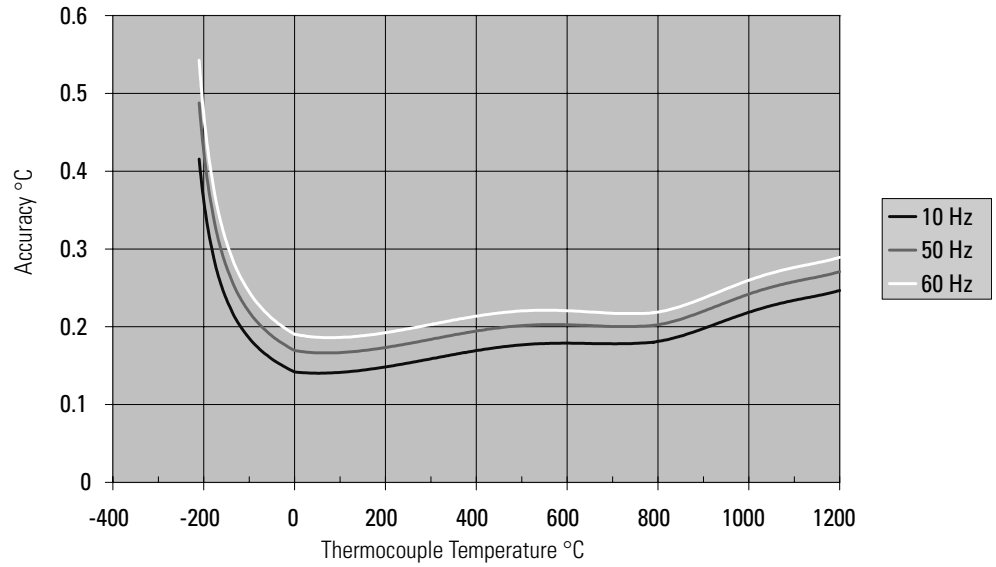

Figure 30 - Module Accuracy at 25 °C (77 °F) Ambient for Type J Thermocouple Using 250, 500, and 1 kHz Filter

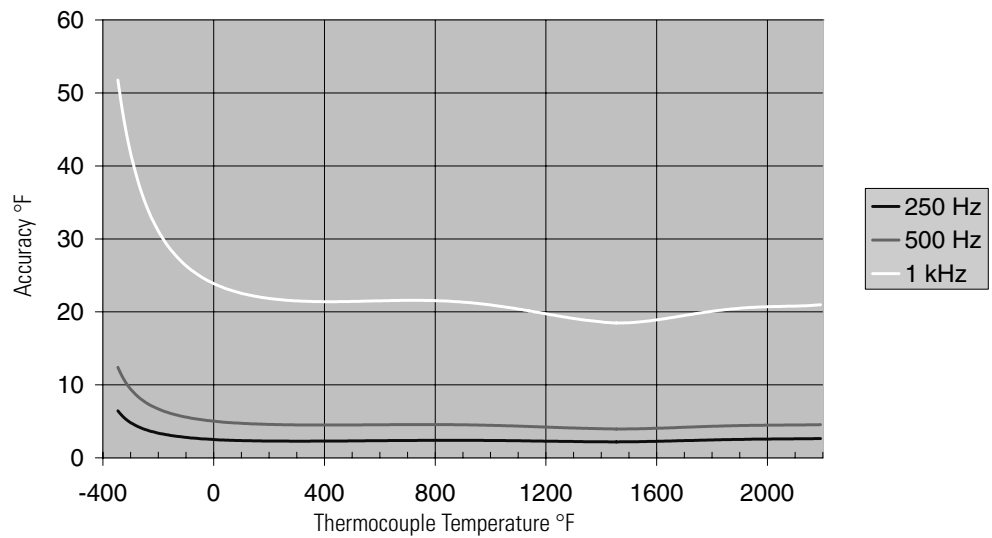
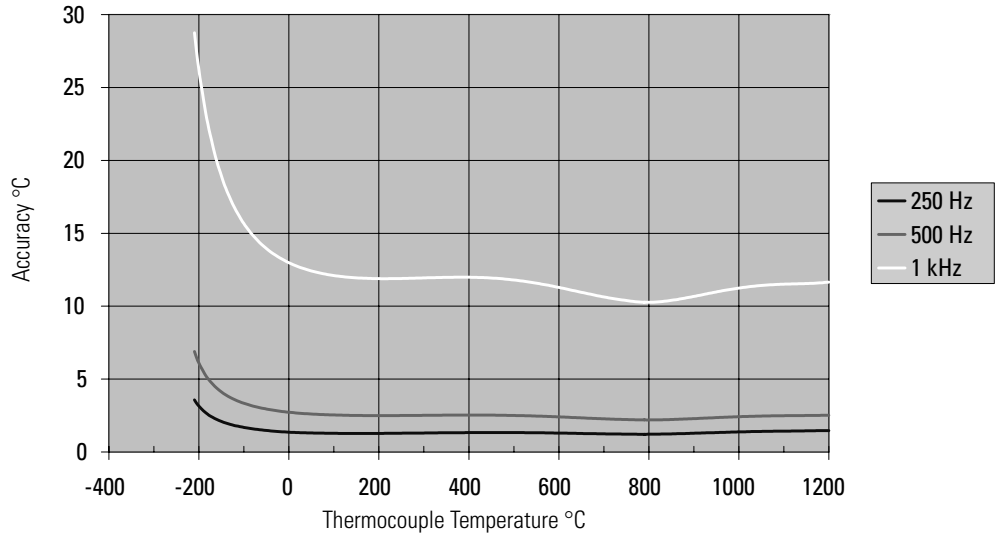

Figure 31 - Module Accuracy at 25 °C (77 °F) Ambient for Type K Thermocouple Using 10, 50, and 60 Hz Filter

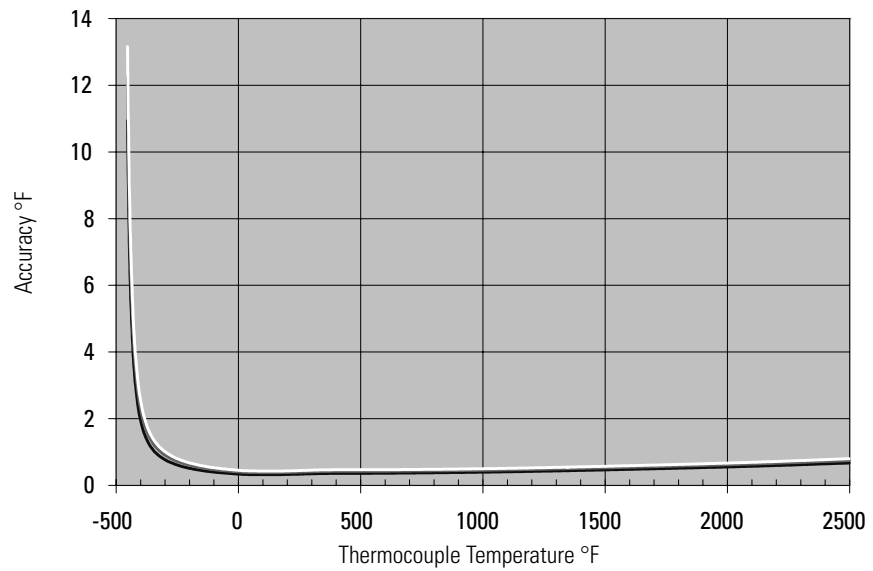
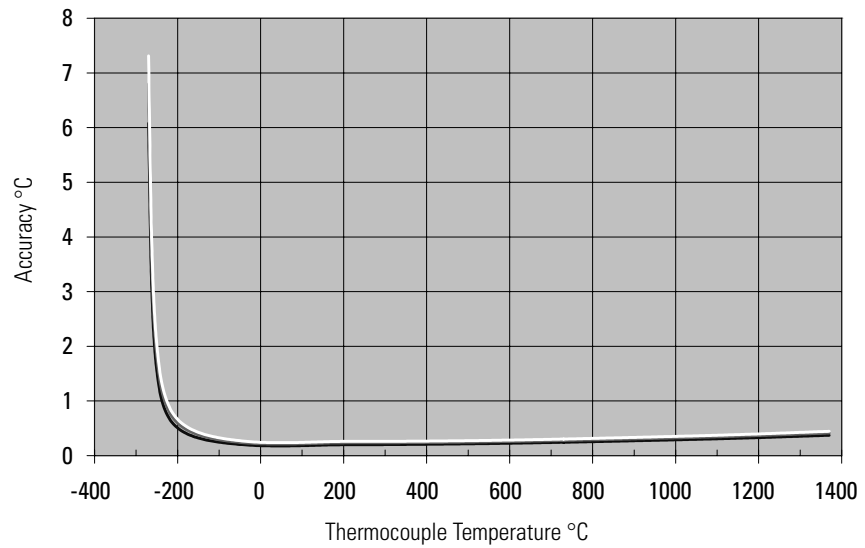

Figure 32 - Module Accuracy at 25 °C (77 °F) Ambient for Type K Thermocouple Using 250, 500, and 1 kHz Filter

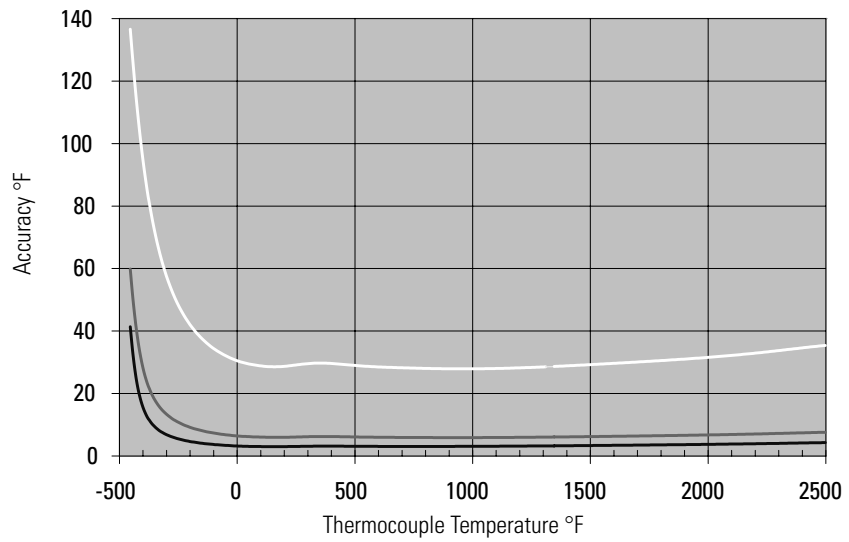
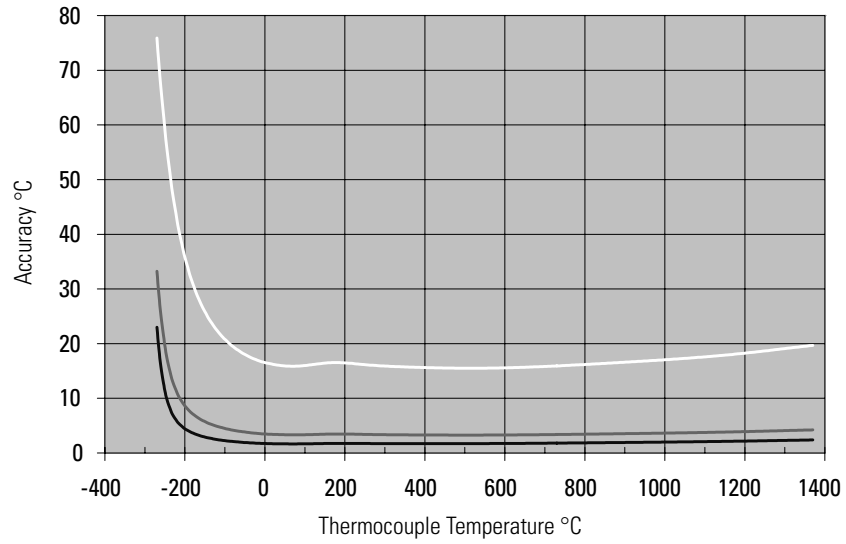

Figure 33 - Module Accuracy at 25 °C (77 °F) Ambient for Type N Thermocouple Using 10, 50, and 60 Hz Filter

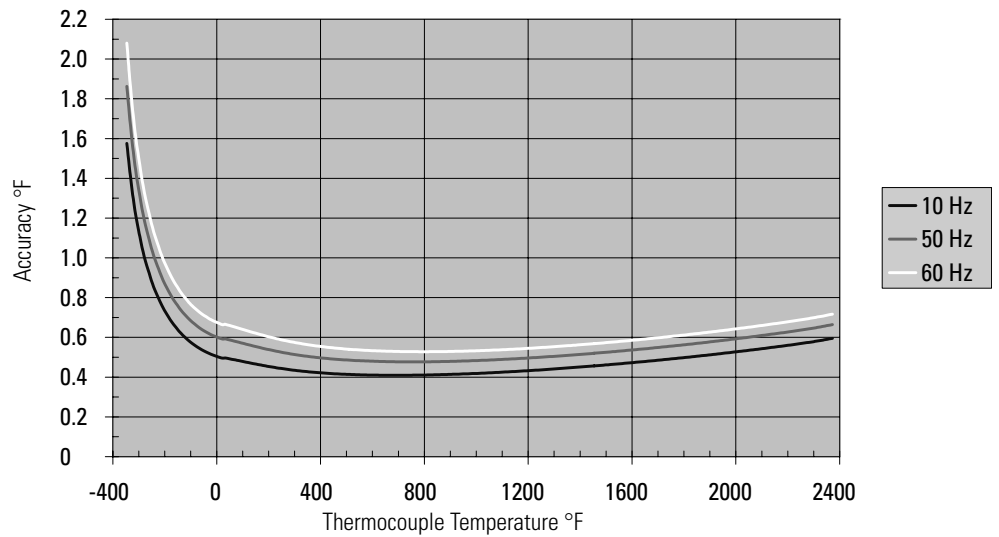
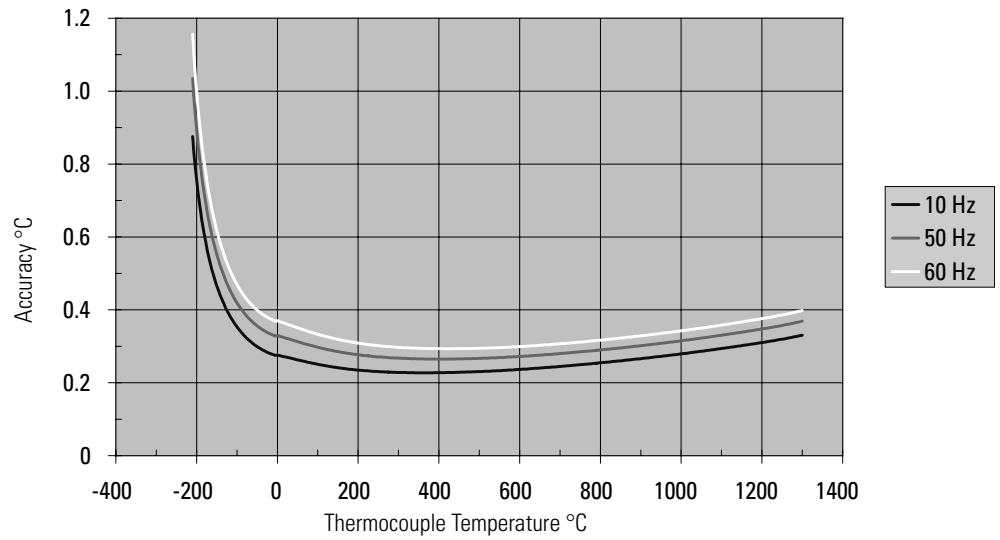

Figure 34 - Module Accuracy at 25 °C (77 °F) Ambient for Type N Thermocouple Using 250, 500, and 1 kHz Filter

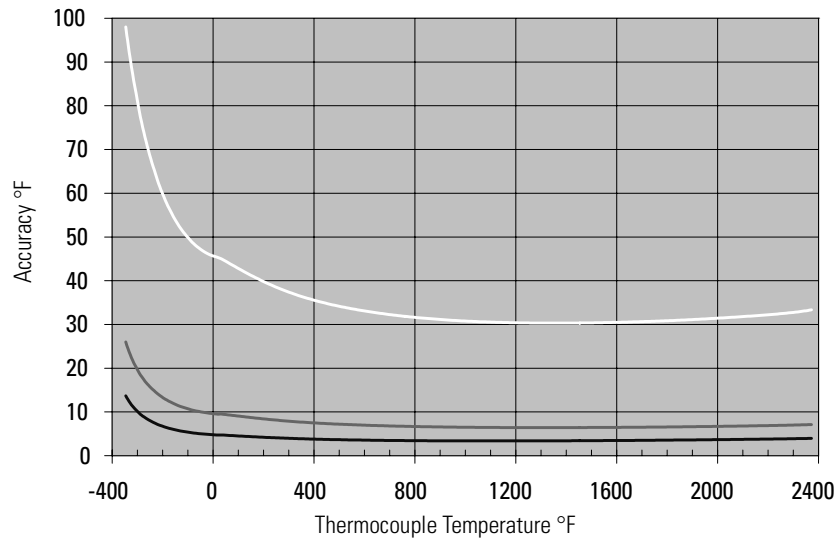
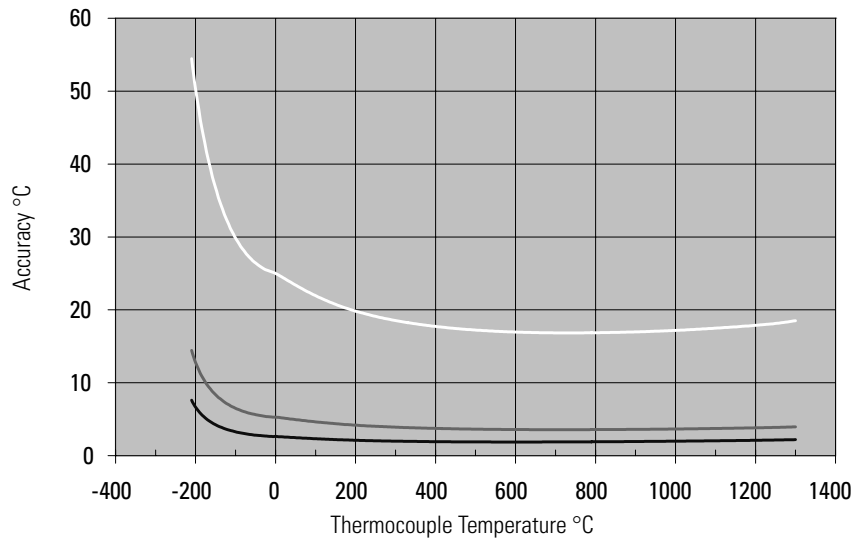

Figure 35 - Module Accuracy at 25 °C (77 °F) Ambient for Type R Thermocouple Using 10, 50, and 60 Hz Filter

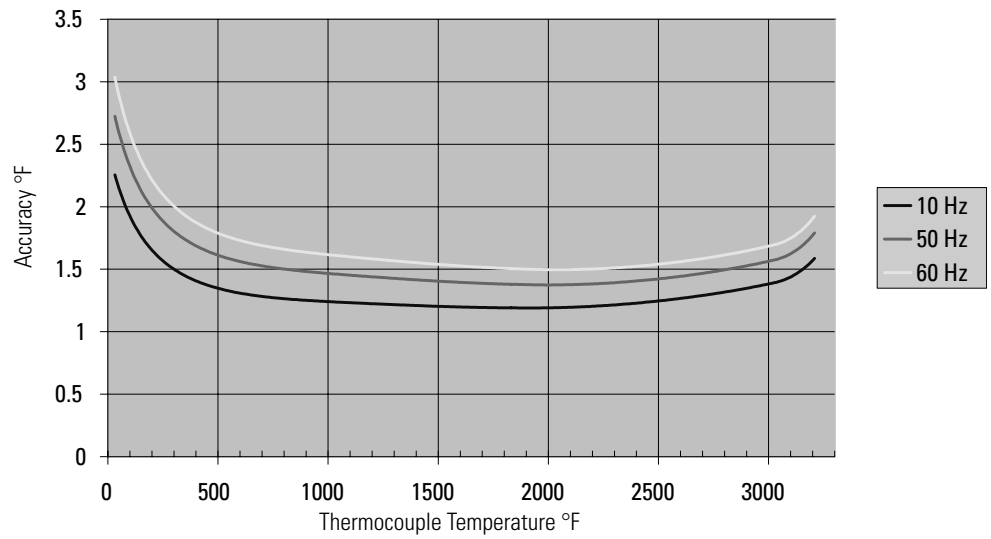
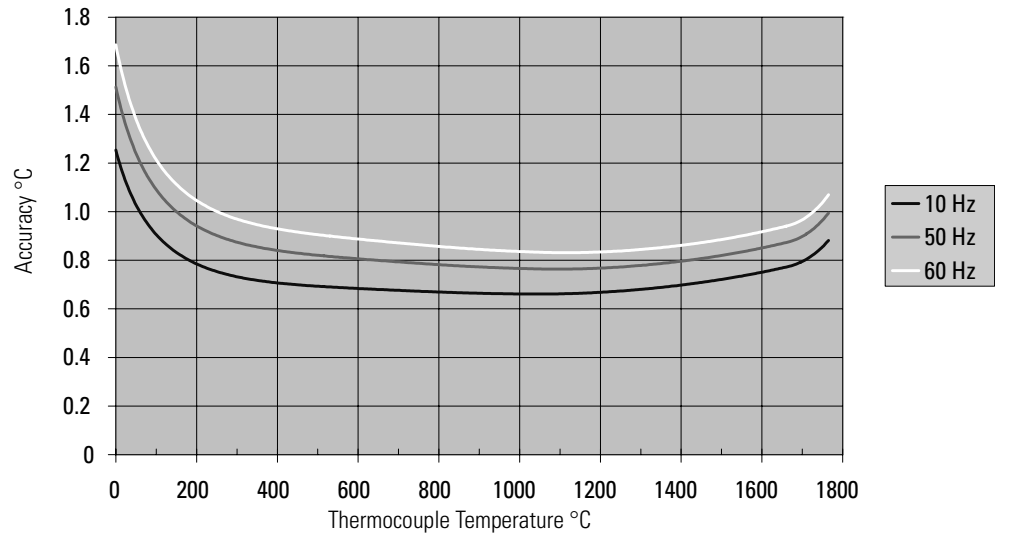

Figure 36 - Module Accuracy at 25 °C (77 °F) Ambient for Type R Thermocouple Using 250, 500, and 1 kHz Filter

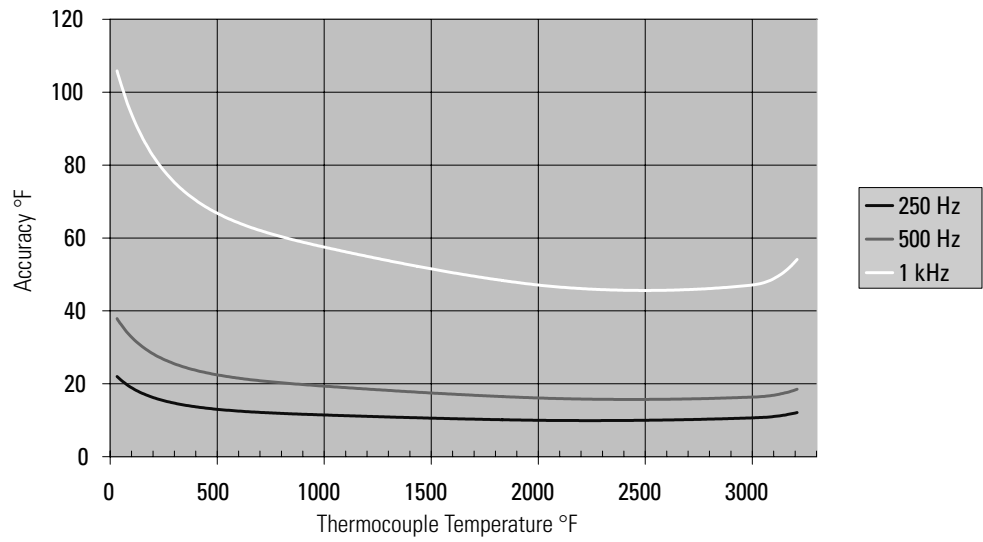
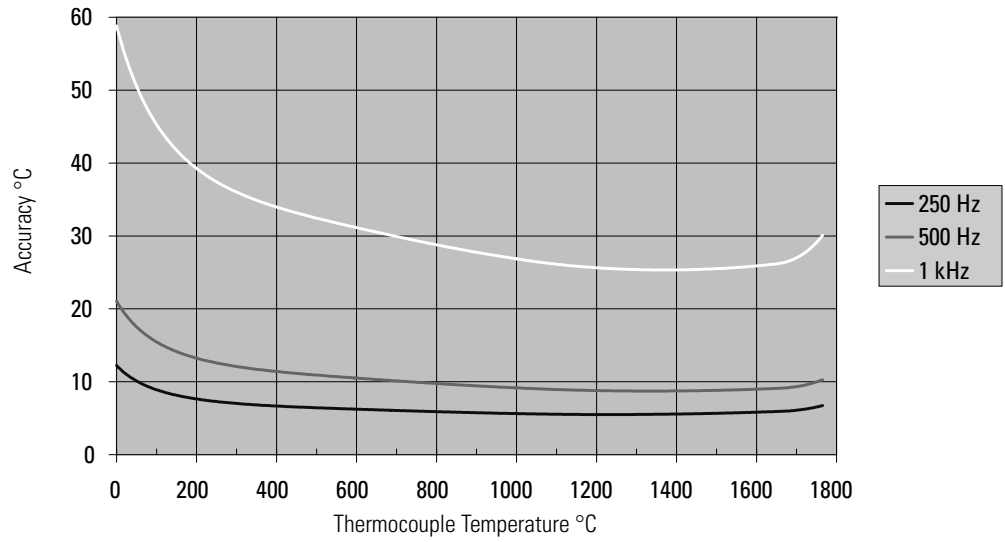

Figure 37 - Module Accuracy at 25 °C (77 °F) Ambient for Type S Thermocouple Using 10, 50, and 60 Hz Filter

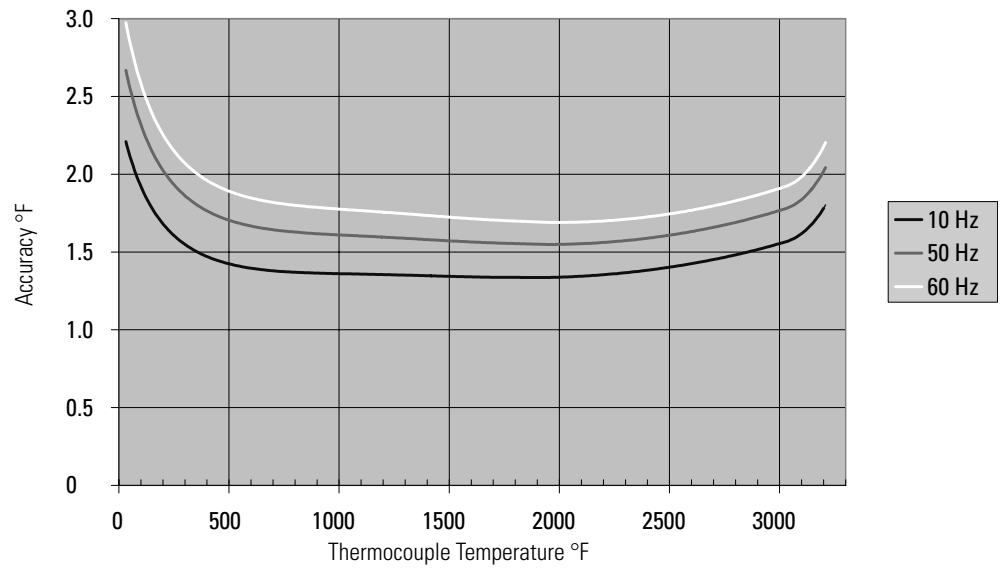
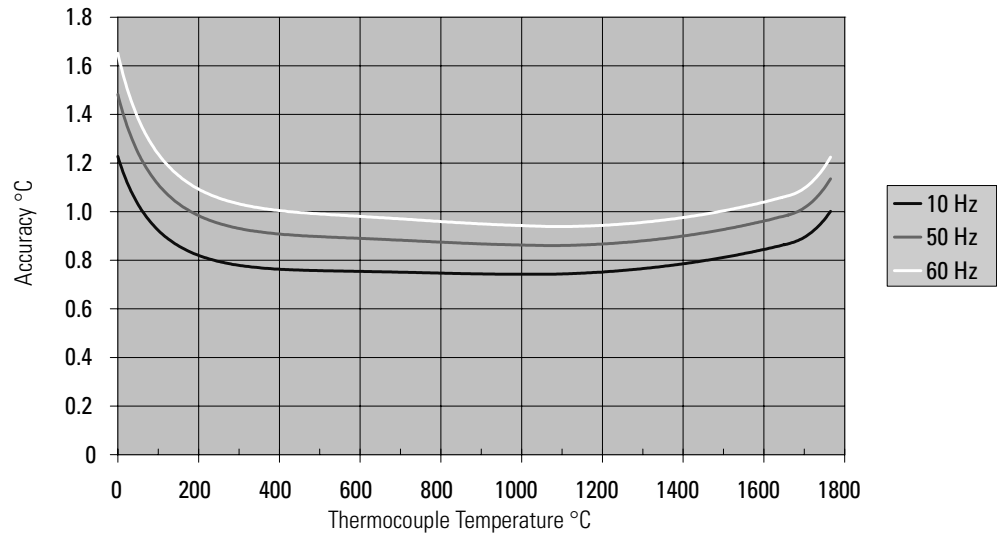

Figure 38 - Module Accuracy at 25 °C (77 °F) Ambient for Type S Thermocouple Using 250, 500, and 1 kHz Filter

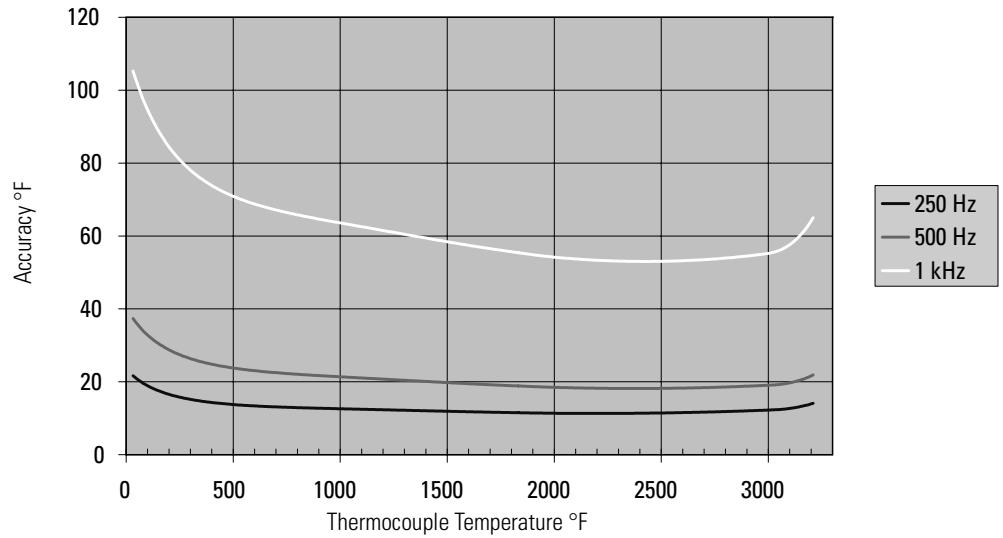
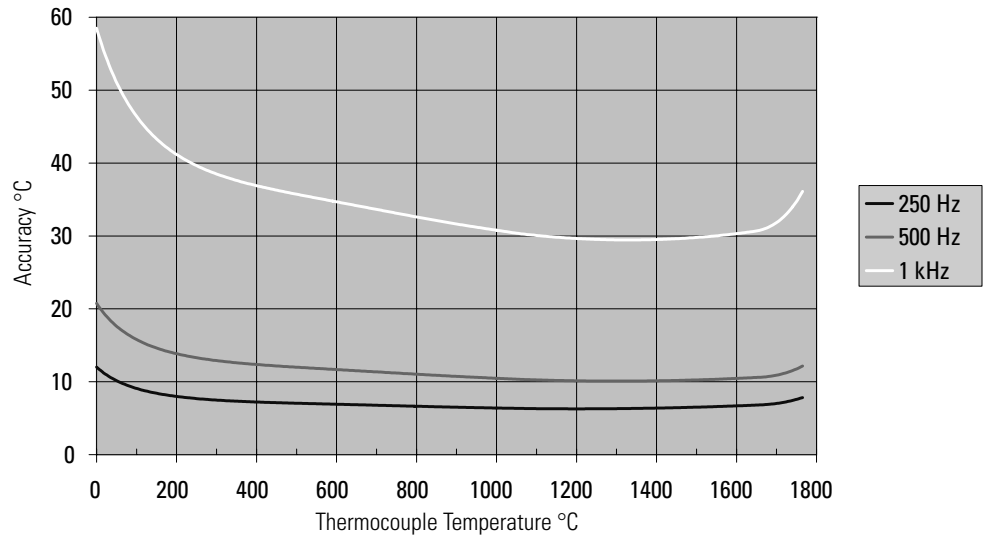

Figure 39 - Module Accuracy at 25 °C (77 °F) Ambient for Type T Thermocouple Using 10, 50, and 60 Hz Filter

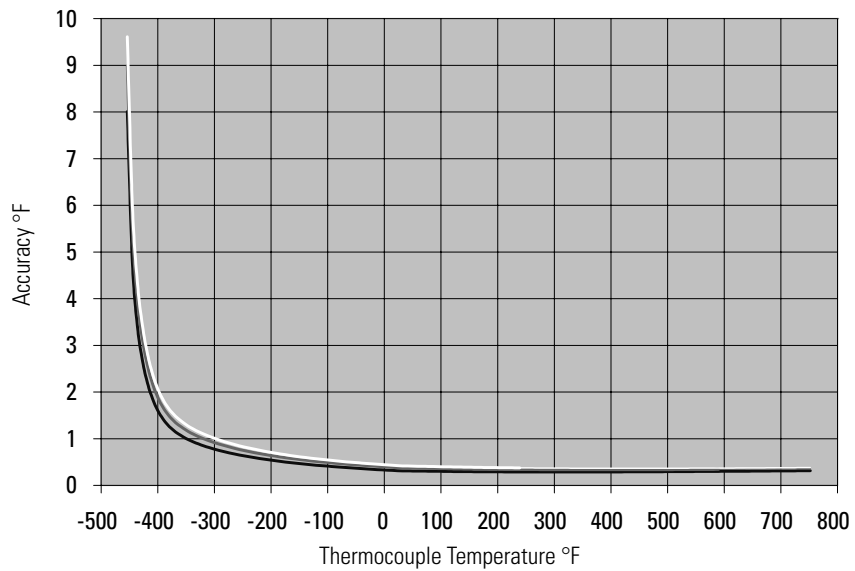
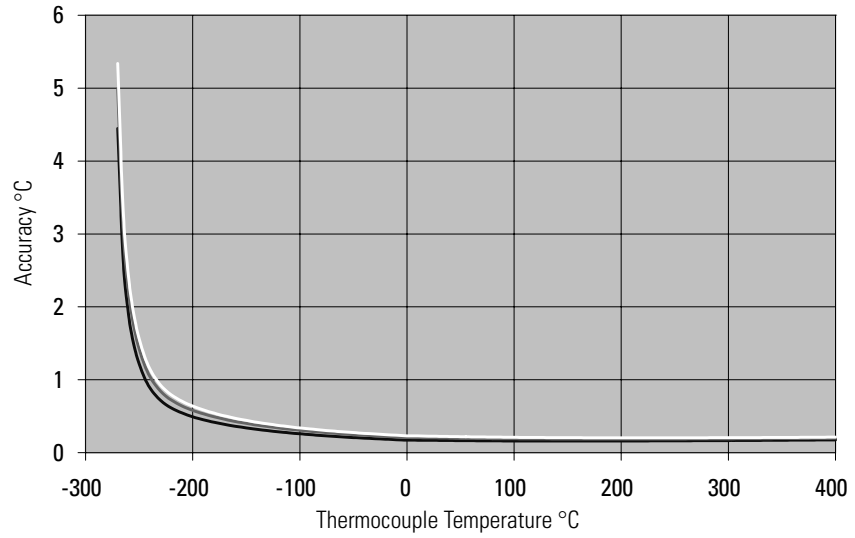
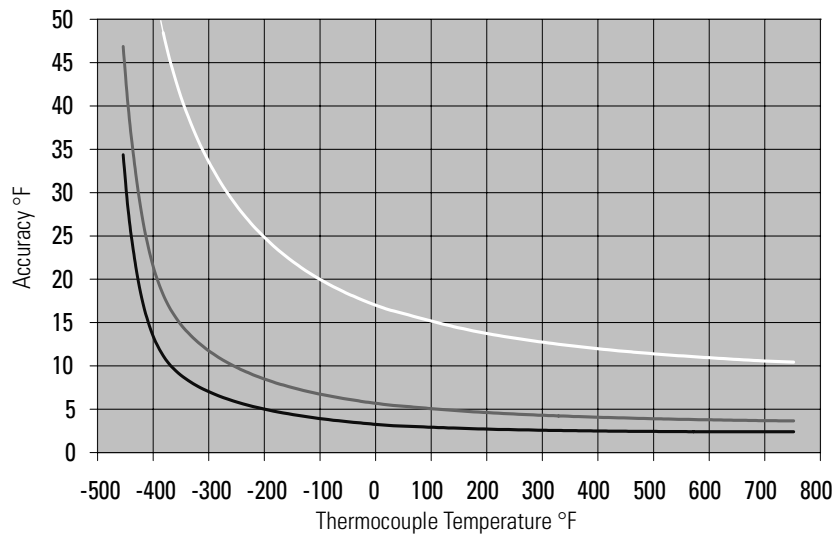
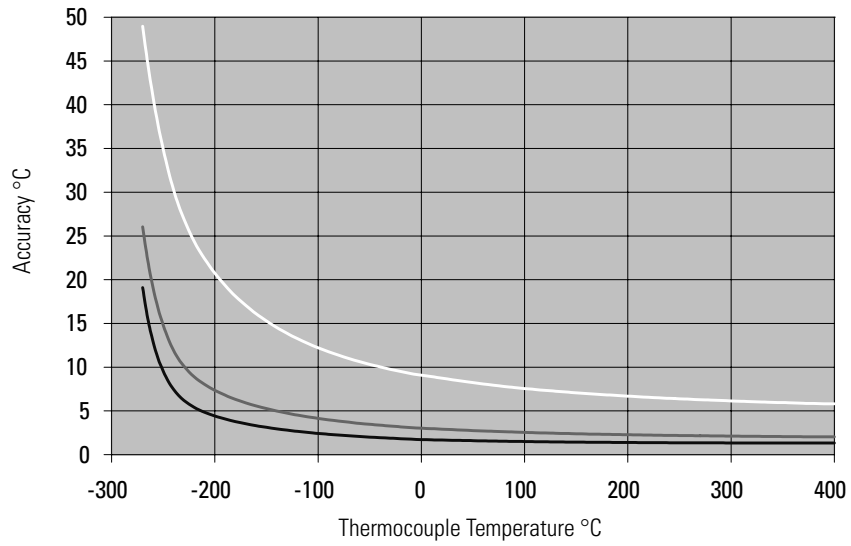

Figure 40 - Module Accuracy at 25 °C (77 °F) Ambient for Type T Thermocouple Using 250, 500, and 1 kHz Filter



Temperature Drift

The graphs below show the module's temperature drift **without autocalibration** for each thermocouple type over the thermocouple's temperature range, assuming terminal block temperature is stable. **The effects of CJC temperature drift are not included.**

Figure 41 - Module Temperature Drift Using Type B Thermocouple

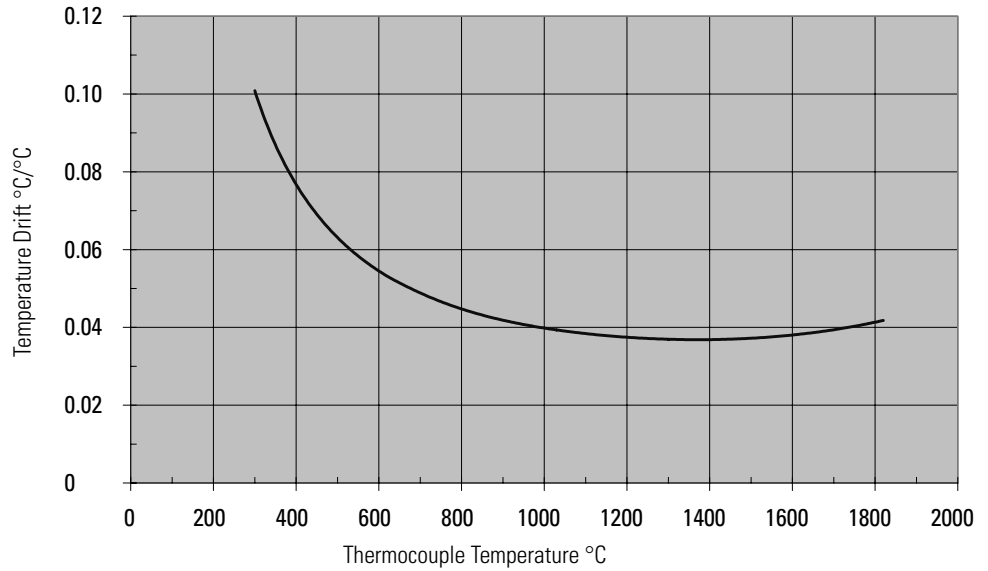

Figure 42 - Module Temperature Drift Using Type C Thermocouple

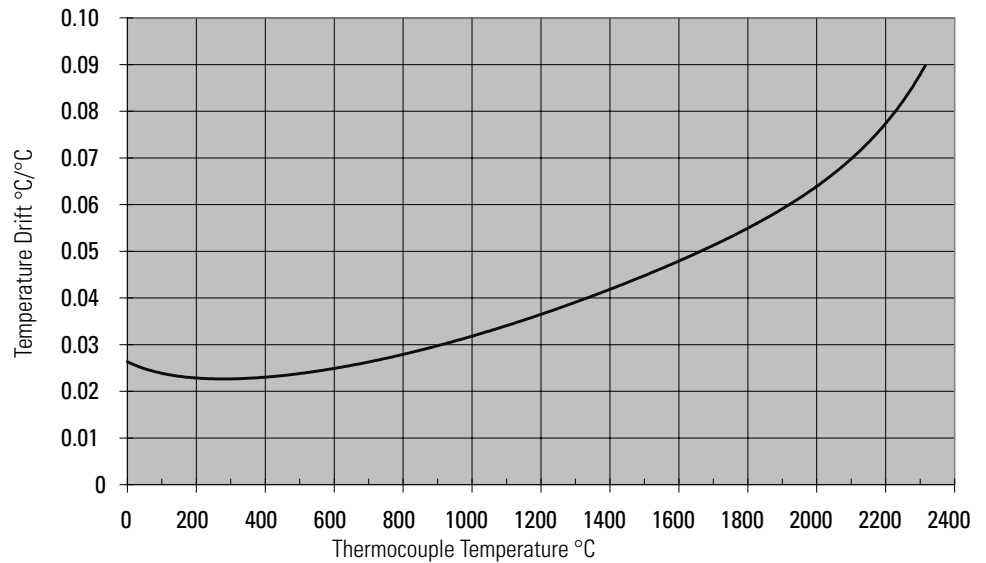

Figure 43 - Module Temperature Drift Using Type E Thermocouple

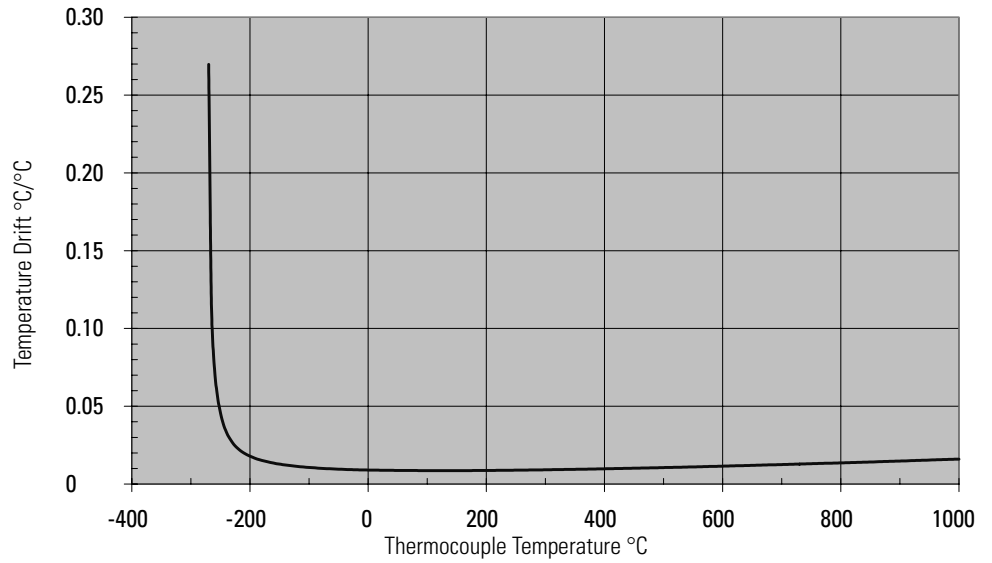

Figure 44 - Module Temperature Drift Using Type J Thermocouple

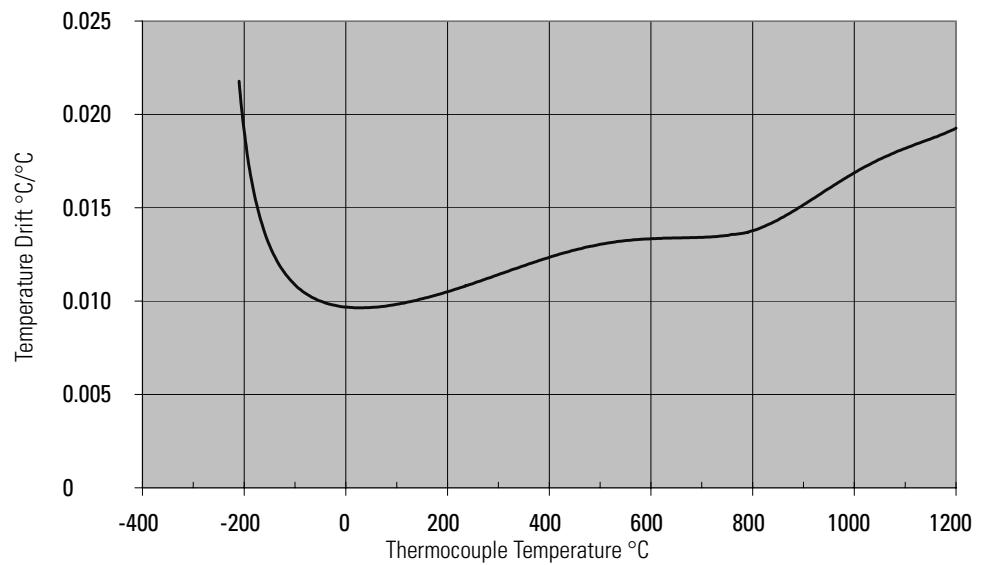

Figure 45 - Module Temperature Drift Using Type K Thermocouple

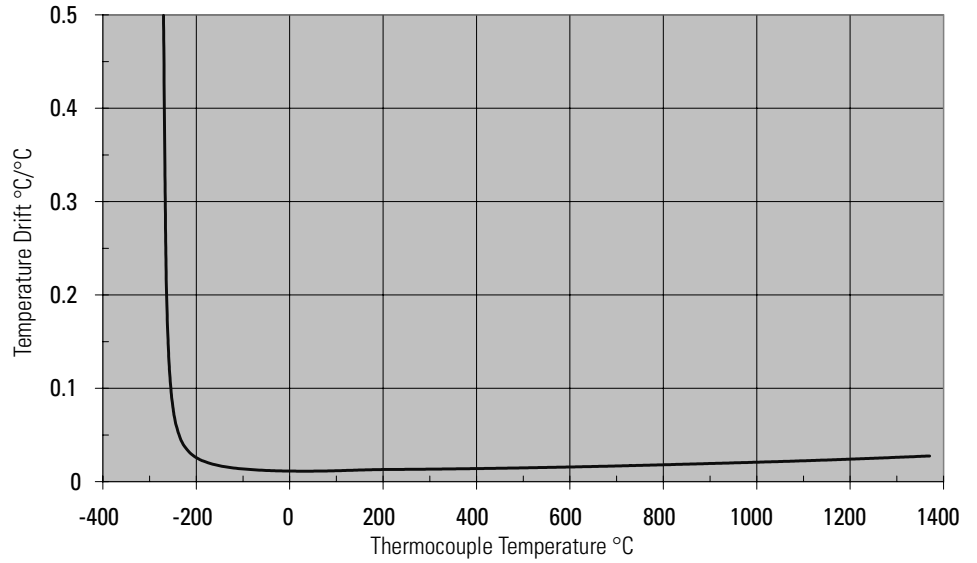

Figure 46 - Module Temperature Drift Using Type N Thermocouple

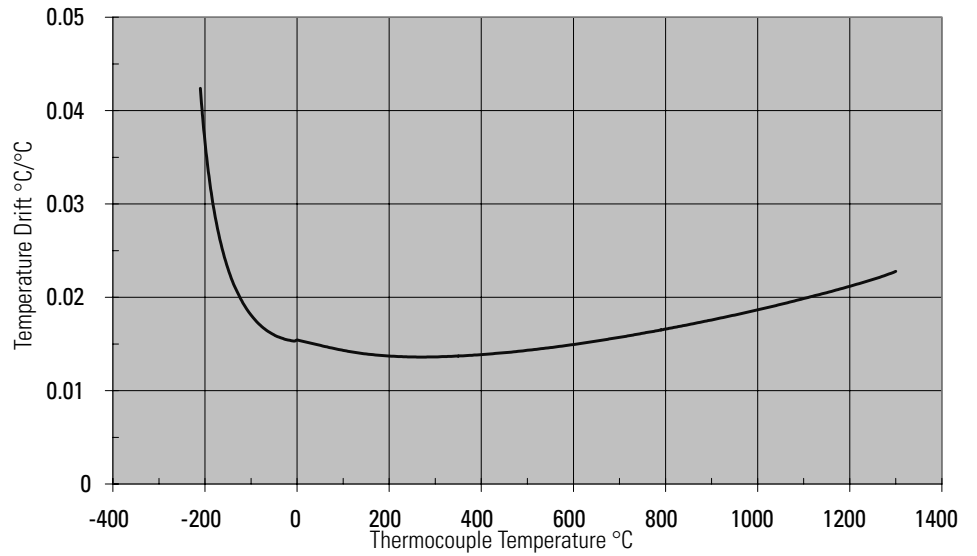

Figure 47 - Module Temperature Drift Using Type R Thermocouple

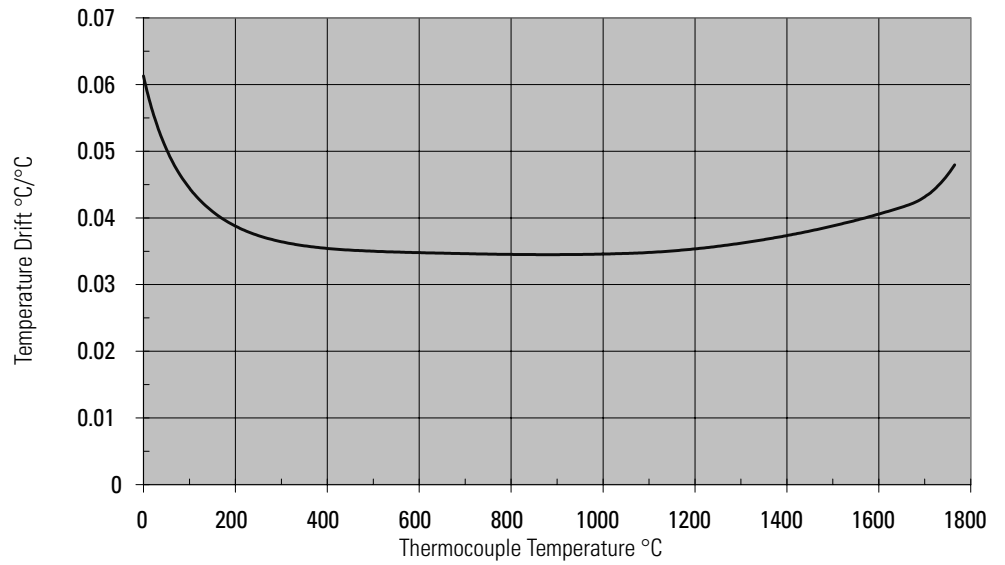

Figure 48 - Module Temperature Drift Using Type S Thermocouple

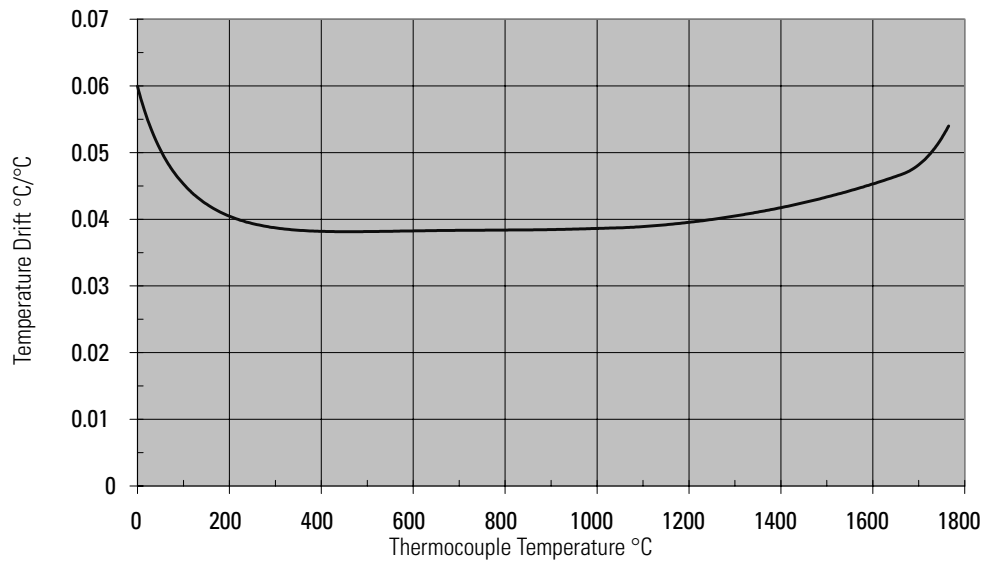
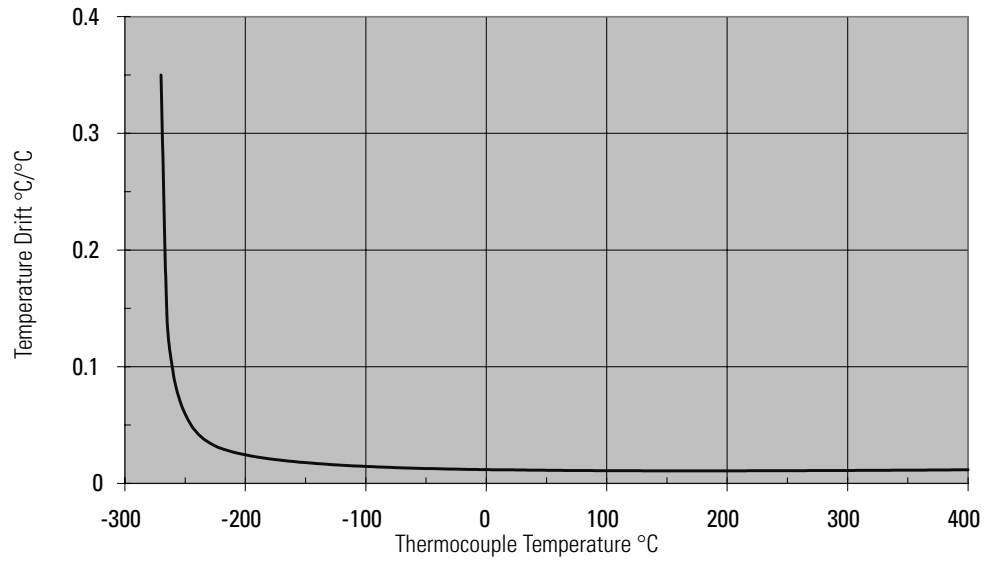

Figure 49 - Module Temperature Drift Using Type T Thermocouple



Notes:

Two's Complement Binary Numbers

The processor memory stores 16-bit binary numbers. Two's complement binary is used when performing mathematical calculations internal to the processor. Analog input values from the analog modules are returned to the processor in 16-bit two's complement binary format. For positive numbers, the binary notation and two's complement binary notation are identical.

As indicated in the figure on the next page, each position in the number has a decimal value, beginning at the right with 20 and ending at the left with 215. Each position can be 0 or 1 in the processor memory. A 0 indicates a value of 0; a 1 indicates the decimal value of the position. The equivalent decimal value of the binary number is the sum of the position values.

Positive Decimal Values

The leftmost position is always 0 for positive values. As indicated in the figure below, this limits the maximum positive decimal value to 32,767 (all positions are 1 except the leftmost position). This is an example.

$$0000\ 1001\ 0000\ 1110 = 211+28+23+22+21 = 2048+256+8+4+2 = 2318$$

$$0010\ 0011\ 0010\ 1000 = 213+29+28+25+23 = 8192+512+256+32+8 = 9000$$

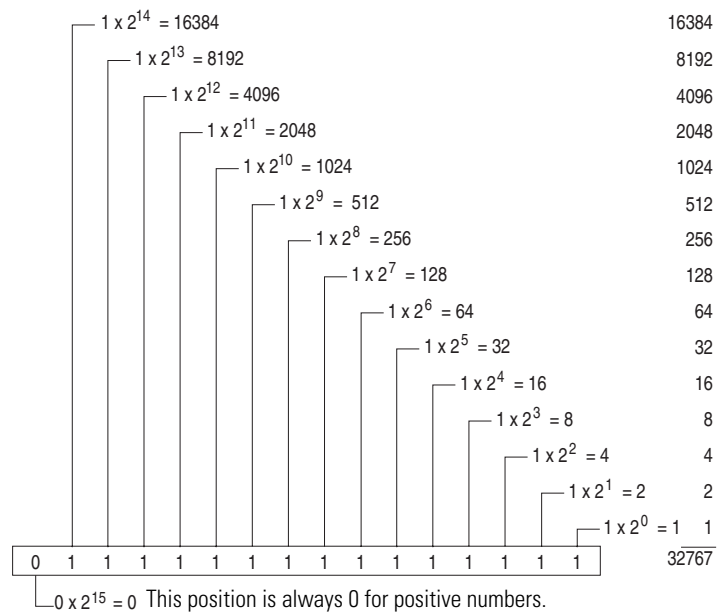

Negative Decimal Values

In two's complement notation, the leftmost position is always 1 for negative values. The equivalent decimal value of the binary number is obtained by subtracting the value of the leftmost position, 32,768, from the sum of the values of the other positions. In the figure below (all positions are 1), the value is $32,767 - 32,768 = -1$. This is an example.

$$1111\ 1000\ 0010\ 0011 = (2^{14}+2^{13}+2^{12}+2^{11}+2^5+2^4+2^3+2^2+2^1) - 2^{15} =$$

$$(16384+8192+4096+2048+1024+512+256+128+64+32+16+8+4+2+1) - 32768 = 30755 - 32768 = -2013$$

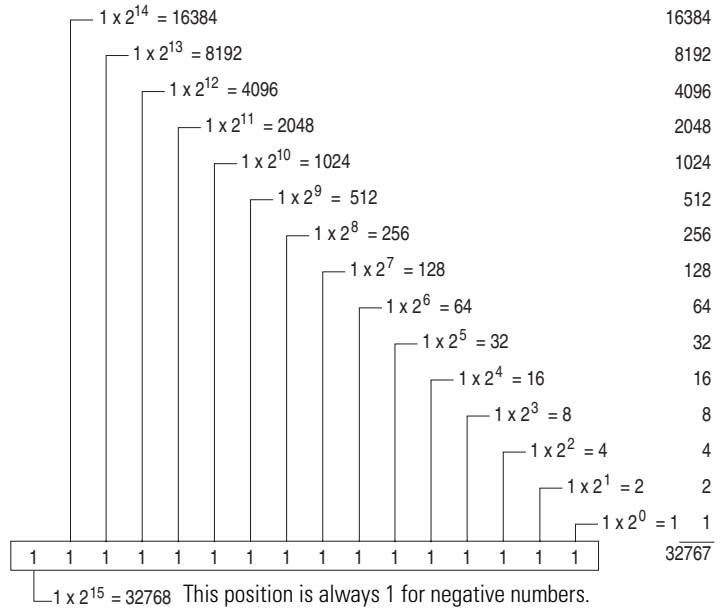

Thermocouple Descriptions

The information in this appendix was extracted from the NIST Monograph 175 issued in January 1990, which supersedes the IPTS-68 Monograph 125 issued in March 1974. NIST Monograph 175 is provided by the United States Department of Commerce, National Institute of Standards and Technology.

International Temperature Scale of 1990

The ITS-90 [1,3] is realized, maintained, and disseminated by NIST to provide a standard scale of temperature for use in science and industry in the United States. This scale was adopted by the International Committee of Weights and Measures (CIPM) at its meeting in September 1989, and it became the official international temperature scale on January 1, 1990. The ITS-90 supersedes the IPTS-68(75) [2] and the 1976 Provisional 0.5 K to 30 K Temperature Scale (EPT-76) [4].

The adoption of the ITS-90 removed several deficiencies and limitations associated with IPTS-68. Temperatures on the ITS-90 are in closer agreement with thermodynamic values than were those of the IPTS-68 and EPT-76. Additionally, improvements have been made in the non-uniqueness and reproducibility of the temperature scale, especially in the temperature range from $t_{68} = 630.74 \dots 1064.43$ °C, where the type S thermocouple was the standard interpolating device on the IPTS-68.

For additional technical information regarding ITS-90, refer to the NIST Monograph 175.

Type B Thermocouples

This section discusses platinum-30% rhodium alloy versus platinum-6% rhodium alloy thermocouples, commonly called type B thermocouples. This type is sometimes referred to by the nominal chemical composition of its thermoelements: platinum-30% rhodium versus platinum-6% rhodium or '30-6'. The positive (BP) thermoelement typically contains $29.60 \pm 0.2\%$ rhodium and the negative (BN) thermoelement usually contains $6.12 \pm 0.02\%$ rhodium. The effect of differences in rhodium content are described later in this section. An industrial consensus standard [21] (ASTM E1159-87) specifies that rhodium having a purity of 99.98% shall be alloyed with platinum of 99.99% purity to produce the thermoelements. This consensus standard [21] describes the purity of commercial type B materials that are used in many industrial thermometry applications that meet the calibration tolerances described later in this section. Both thermoelements will typically have significant impurities of elements such as palladium, iridium, iron, and silicon [38].

Studies by Ehringer [39], Walker et al. [25,26], and Glawe and Szaniszló [24] have demonstrated that thermocouples, in which both legs are platinum-rhodium alloys, are suitable for reliable temperature measurements at high temperatures. Such thermocouples have been shown to offer the following distinct advantages over types R and S thermocouples at high temperatures: (1) improved stability, (2) increased mechanical strength, and (3) higher operating temperatures.

The research by Burns and Gallagher [38] indicated that the 30-6 thermocouple can be used intermittently (for several hours) up to 1790 °C and continuously (for several hundred hours) at temperatures up to about 1700 °C with only small changes in calibration. The maximum temperature limit for the thermocouple is governed, primarily, by the melting point of the platinum-6% rhodium thermoelement that is estimated to be about 1820 °C by Acken [40]. The thermocouple is most reliable when used in a clean oxidizing atmosphere (air) but also has been used successfully in neutral atmospheres or vacuum by Walker et al [25,26], Hendricks and McElroy [41], and Glawe and Szaniszló [24]. The stability of the thermocouple at high temperatures has been shown by Walker et al. [25,26] to depend, primarily, on the quality of the materials used for protecting and insulating the thermocouple. High purity alumina with low iron-content appears to be the most suitable material for the purpose.

Type B thermocouples should not be used in reducing atmospheres, nor those containing deleterious vapors or other contaminants that are reactive with the platinum group metals [42], unless suitably protected with nonmetallic protecting tubes. They should never be used in metallic protecting tubes at high temperatures.

The Seebeck coefficient of type B thermocouples decreases with decreasing temperature below about 1600 °C (2912 °F) and becomes almost negligible at room temperature. Consequently, in most applications the reference junction temperature of the thermocouple does not need to be controlled or even known, as long as it is between 0...50 °C (32...122 °F). For example, the voltage developed by the thermocouple, with the reference junction at 0 °C (32 °F), undergoes a reversal in sign at about 42 °C (107.6 °F), and between 0...50 °C (32...122 °F) varies from a minimum of -2.6 μ V near 21 °C (69.8 °F) to a maximum of 2.3 μ V at 50 °C (122 °F). Therefore, in use, if the reference junction of the thermocouple is within the range 0...50 °C (32...122 °F), then a 0 °C (32 °F) reference junction temperature can be assumed and the error introduced will not exceed 3 μ V. At temperatures above 1100 °C (2012 °F), an additional measurement error of 3 μ V (about 0.3 °C (32.5 °F)) would be insignificant in most instances.

ASTM Standard E230-87 in the 1992 Annual Book of ASTM Standards [7] specifies that the initial calibration tolerances for type B commercial thermocouples be $\pm 0.5\%$ between 870...1700 °C (1598...3092 °F). Type B thermocouples can also be supplied to meet special tolerances of $\pm 0.25\%$. Tolerances are not specified for type B thermocouples below 870 °C (1598 °F).

The suggested upper temperature limit of 1700 °C (3092 °F) given in the ASTM standard [7] for protected type B thermocouples applies to 0.51 mm² (24 AWG) wire. This temperature limit applies to thermocouples used in conventional closed-end protecting tubes and it is intended only as a rough guide to the user. It does not apply to thermocouples having compacted mineral oxide insulation.

Type E Thermocouples

This section describes Nickel-Chromium Alloy Versus Copper-Nickel Alloy thermocouples, known as type E thermocouples. This type, and the other base-metal types, do not have specific chemical compositions given in standards; rather, any materials whose emf-temperature relationship agrees with that of the specified reference table within certain tolerances can be considered to be a type E thermocouple. The positive thermoelement, EP, is the same material as KP. The negative thermoelement, EN, is the same material as TN.

The low-temperature research [8] by members of the NBS Cryogenics Division showed that type E thermocouples are very useful down to liquid hydrogen temperatures (n.b.p. about 20.3 °K) where their Seebeck coefficient is about 8 mV/°C. They may even be used down to liquid helium temperatures (4.2 °K) although their Seebeck coefficient becomes quite low, only about 2 mV/°C at 4 °K. Both thermoelements of type E thermocouples have a relatively low thermal conductivity, good resistance to corrosion in moist atmospheres, and reasonably good homogeneity. For these three reasons and their relatively high Seebeck coefficients, type E thermocouples have been recommended [8] as the most useful of the letter-designated thermocouple types for low-temperature measurements.

For measurements below 20 °K, the non-letter-designated thermocouple, KP versus gold-0.07, is recommended. The properties of this thermocouple have been described by Sparks and Powell [12].

Type E thermocouples also have the largest Seebeck coefficient above 0 °C (32 °F) for any of the letter-designated thermocouples. For that reason they are being used more often whenever environmental conditions permit.

Type E thermocouples are recommended by the ASTM [5] for use in the temperature range from -200...900 °C (-328...1652 °F) in oxidizing or inert atmospheres. If used for extended times in air above 500 °C (932 °F), heavy gauge wires are recommended because the oxidation rate is rapid at elevated temperatures. About 50 years ago, Dahl [11] studied the thermoelectric stability of EP and EN type alloys when heated in air at elevated temperatures. His work should be consulted for details. More recent stability data on these alloys in air were reported by Burley et al. [13]. Type E thermocouples should not be used at high temperatures in sulfurous, reducing, or alternately reducing and oxidizing atmospheres unless suitably protected with protecting tubes.

They also should not be used in vacuum (at high temperatures) for extended times because the chromium in the positive thermoelement, a nickel-chromium alloy, vaporizes out of solution and alters the calibration. In addition, their use in atmospheres that promote 'green-rot' corrosion of the positive thermoelement should be avoided. Such corrosion results from the preferential oxidation of chromium in atmospheres with low, but not negligible, oxygen content and can lead to a large decrease in the thermoelectric voltage of the thermocouple with time. The effect is most serious at temperatures between 800 °C (1472 °F) and 1050 °C (1922 °F).

The negative thermoelement, a copper-nickel alloy, is subject to composition changes under thermal neutron irradiation because the copper is converted to nickel and zinc.

Neither thermoelement of type E thermocouples is very sensitive to minor changes in composition or impurity level because both are already heavily alloyed. Similarly, they are also not extremely sensitive to minor differences in heat treatment (provided that the treatment does not violate any of the restrictions mentioned above). For most general applications, they may be used with the heat treatment given by the wire manufacturers. However, when the highest accuracy is sought, additional preparatory heat treatments may be desirable to enhance their performance. Details on this and other phases of the use and behavior of type KP thermoelements (EP is the same as KP) are given in publications by Pots and McElroy [14], by Burley and Ackland [15], by Burley [16], by Wang and Starr [17,18], by Bentley [19], and by Kollie et al. [20].

ASTM Standard E230-87 in the 1992 Annual Book of ASTM Standards [7] specifies that the initial calibration tolerances for type E commercial thermocouples be ± 1.7 °C (± 35.06 °F) or $\pm 0.5\%$ (whichever is greater) between 0 °C (32 °F) and 900 °C (1652 °F), and ± 1.7 °C (± 35.06 °F) or $\pm 1\%$ (whichever is greater) between -200 °C (-328 °F) and 0 °C (32 °F). Type E thermocouples can also be supplied to meet special tolerances that are equal to ± 1 °C (33.8 °F) or $\pm 0.4\%$ (whichever is greater) between 0 °C (32 °F) and 900 °C (1652 °F), and ± 1 °C (33.8 °F) or $\pm 0.5\%$ (whichever is greater) between -200 °C (-328 °F) and 0 °C (32 °F). Type E thermocouple materials are normally supplied to meet the tolerances specified for temperatures above 0 °C (32 °F). The same materials, however, may not satisfy the tolerances specified for the -200...0 °C (-328...32 °F) range. If materials are required to meet the tolerances below 0 °C (32 °F), this should be specified when they are purchased.

The suggested upper temperature limit, 870 °C (1598 °F), given in the ASTM standard [7] for protected type E thermocouples applies to 3.25 mm² (8 AWG) wire. It decreases to 650 °C (1202 °F) for 1.63 mm² (14 AWG), 540 °C (1004 °F) for 0.81 mm² (20 AWG), 430 °C (806 °F) for 0.51 or 0.33 mm² (24 or 28 AWG), and 370 °C (698 °F) for 0.25 mm² (30 AWG). These temperature limits apply to thermocouples used in conventional closed-end protecting tubes and they are intended only as a rough guide to the user. They do not apply to thermocouples having compacted mineral oxide insulation.

Type J Thermocouples

This section discusses iron versus copper-nickel alloy (SAMA) thermocouples, called type J thermocouples. A type J thermocouple is one of the most common types of industrial thermocouples, because of its relatively high Seebeck coefficient and low cost. It has been reported that more than 200 tons of type J materials are supplied annually to industry in this country. However, this type is least suitable for accurate thermometry because there are significant nonlinear deviations in the thermoelectric output of thermocouples obtained from different manufacturers. These irregular deviations lead to difficulties in obtaining accurate calibrations based on a limited number of calibration points. The positive thermoelement is commercially pure (99.5% Fe) iron, usually containing significant impurity levels of carbon, chromium, copper, manganese, nickel, phosphorus, silicon, and sulfur.

Thermocouple wire represents such a small fraction of the total production of commercial iron wire that the producers do not control the chemical composition to maintain constant thermoelectric properties. Instead, instrument companies and thermocouple fabricators select material most suitable for the thermocouple usage. The total and specific types of impurities that occur in commercial iron change with time, location of primary ores, and methods of smelting. Many unusual lots have been selected in the past, for example spools of industrial iron wire and even scrapped rails from an elevated train line. At present, iron wire that most closely fits these tables has about 0.25% manganese and 0.12% copper, plus other minor impurities.

The negative thermoelement for type J thermocouples is a copper-nickel alloy known ambiguously as constantan. The word constantan has commonly referred to copper-nickel alloys containing anywhere from 45...60% copper, plus minor impurities of carbon, cobalt, iron, and manganese. Constantan for type J thermocouples usually contains about 55% copper, 45% nickel, and a small but thermoelectrically significant amount of cobalt, iron, and manganese, about 0.1% or more. It should be emphasized that type JN thermoelements are NOT generally interchangeable with type TN (or EN) thermoelements, although they are all referred to as 'constantan'. To provide some differentiation in nomenclature, type JN is often referred to as SAMA constantan.

Type J thermocouples are recommended by the ASTM [5] for use in the temperature range from 0...760 °C (32...1400 °F) in vacuum, oxidizing, reducing, or inert atmospheres. If used for extended times in air above 500 °C (932 °F), heavy gauge wires are recommended because the oxidation rate is rapid at elevated temperatures. Oxidation normally causes a gradual decrease in the thermoelectric voltage of the thermocouple with time. Because iron rusts in moist atmospheres and may become brittle, type J thermocouples are not recommended for use below 0 °C (32 °F). In addition, they should not be used unprotected in sulfurous atmospheres above 500 °C (932 °F).

The positive thermoelement, iron, is relatively insensitive to composition changes under thermal neutron irradiation, but does exhibit a slight increase in manganese content. The negative thermoelement, a copper-nickel alloy, is subject to substantial composition changes under thermal neutron irradiation because copper is converted to nickel and zinc.

Iron undergoes a magnetic transformation near 769 °C (1416 °F) and an alpha-gamma crystal transformation near 910 °C (1670 °F) [6]. Both of these transformations, especially the latter, seriously affect the thermoelectric properties of iron, and therefore of type J thermocouples. This behavior and the rapid oxidation rate of iron are the main reasons why iron versus constantan thermocouples are not recommended as a standardized type above 760 °C (1400 °F). If type J thermocouples are taken to high temperatures, especially above 900 °C (1652 °F), they will lose the accuracy of their calibration when they are recycled to lower temperatures. If type J thermocouples are used in air at temperatures above 760 °C (1400 °F), only the largest wire, 3.3 mm² (8 AWG) should be used and they should be held at the measured temperature for 10...20 minutes before readings are taken. The thermoelectric voltage of the type J thermocouples may change by as much as 40 μV (or 0.6 °C (33.08 °F) equivalent) per minute when first brought up to temperatures near 900 °C (1652 °F).

ASTM Standard E230-87 in the 1992 Annual Book of ASTM Standards [7] specifies that the initial calibration tolerances for type J commercial thermocouples be ±2.2 °C (±35.96 °F) or ±0.75% (whichever is greater) between 0 °C (32 °F) and 750 °C (1382 °F). Type J thermocouples can also be supplied to meet special tolerances, which are equal to approximately one-half the standard tolerances given above. Tolerances are not specified for type J thermocouples below 0 °C (32 °F) or above 750 °C (1382 °F).

The suggested upper temperature limit of 760 °C (1400 °F) given in the above ASTM standard [7] for protected type J thermocouples applies to 3.25 mm² (8 AWG) wire. For smaller diameter wires the suggested upper temperature limit decreases to 590 °C (1094 °F) for 1.63 mm² (14 AWG), 480 °C (896 °F) for 0.81 mm² (20 AWG), 370 °C (698 °F) for 0.51 or 0.33 mm² (24 or 28 AWG), and 320 °C (608 °F) for 0.25 mm² (30 AWG). These temperature limits apply to thermocouples used in conventional closed-end protecting tubes and they are intended only as a rough guide to the user. They do not apply to sheathed thermocouples having compacted mineral oxide insulation.

Type K Thermocouples

This section describes nickel-chromium alloy versus nickel-aluminum alloy thermocouples, called type K thermocouples. This type is more resistant to oxidation at elevated temperatures than types E, J, or T thermocouples and, consequently, it finds wide application at temperatures above 500 °C (932 °F). The positive thermoelement, KP, which is the same as EP, is an alloy that typically contains about 89 or 90% nickel, 9 or 9.5% chromium, both silicon and iron in amounts up to about 0.5%, plus smaller amounts of other constituents such as carbon, manganese, cobalt, and niobium. The negative thermoelement, KN, is typically composed of about 95 or 96 percent nickel, 1...1.5% silicon, 1...2.3% aluminum, 1.6...3.2% manganese, up to about 0.5% cobalt and smaller amounts of other constituents such as iron, copper, and lead. Also, type KN thermoelements with modified compositions are available for use in special applications. These include alloys in which the manganese and aluminum contents are reduced or eliminated, while the silicon and cobalt contents are increased.

The low temperature research [8] by members of the NBS Cryogenics Division showed that the type K thermocouple may be used down to liquid helium temperatures (about 4 °K) but that its Seebeck coefficient becomes quite small below 20 °K. Its Seebeck coefficient at 20 °K is only about 4 μV/K, being roughly one-half that of the type E thermocouple which is the most suitable of the letter-designated thermocouples types for measurements down to 20 °K. Type KP and type KN thermoelements do have a relatively low thermal conductivity and good resistance to corrosion in moist atmospheres at low temperatures. The thermoelectric homogeneity of type KN thermoelements, however, was found [8] to be not quite as good as that of type EN thermoelements.

Type K thermocouples are recommended by the ASTM [5] for use at temperatures within the range -250...1260 °C (-418...2300 °F) in oxidizing or inert atmospheres. Both the KP and the KN thermoelements are subject to deterioration by oxidation when used in air above about 750 °C (1382 °F), but even so, type K thermocouples may be used at temperatures up to about 1350 °C (2462 °F) for short periods with only small changes in calibration. When oxidation occurs it normally leads to a gradual increase in the thermoelectric voltage with time. The magnitude of the change in the thermoelectric voltage and the physical life of the thermocouple will depend upon such factors as the temperature, the time at temperature, the diameter of the thermoelements and the conditions of use.

The ASTM Manual [5] indicates that type K thermocouples should not be used at high temperatures in sulfurous, reducing, or alternately oxidizing and reducing atmospheres unless suitably protected with protecting tubes. They also should not be used in vacuum (at high temperatures) for extended times because the chromium in the positive thermoelement, a nickel-chromium alloy, vaporizes out of solution and alters the calibration.

In addition, avoid their use in atmospheres that promote 'green-rot' corrosion [9] of the positive thermoelement. Such corrosion results from the preferential oxidation of chromium in atmospheres with low, but not negligible, oxygen content and can lead to a large decrease in the thermoelectric voltage of the thermocouple with time. The effect is most serious at temperatures between 800 °C (1472 °F) and 1050 °C (1922 °F).

Both thermoelements of type K thermocouples are reasonably stable, thermoelectrically, under neutron irradiation because the resulting changes in their chemical compositions due to transmutation are small. The KN thermoelements are somewhat less stable than the KP thermoelements in that they experience a small increase in the iron content accompanied by a slight decrease in the manganese and cobalt contents.

ASTM Standard E230-87 in the 1992 Annual Book of ASTM Standards [7] specifies that the initial calibration tolerances for type K commercial thermocouples be ± 2.2 °C (± 35.96 °F) or $\pm 0.75\%$ (whichever is greater) between 0 °C (32 °F) and 1250 °C (2282 °F), and ± 2.2 °C (± 35.96 °F) or $\pm 2\%$ (whichever is greater) between -200 °C (-328 °F) and 0 °C (32 °F). In the 0...1250 °C (32...2282 °F) range, type K thermocouples can be supplied to meet special tolerances that are equal to approximately one-half the standard tolerances given above. Type K thermocouple materials are normally supplied to meet the tolerances specified for temperatures above 0 °C (32 °F). However, the same materials may not satisfy the tolerances specified for the -200...0 °C (-328...32 °F) range. If materials are required to meet the tolerances below 0 °C (32 °F), this should be specified when they are purchased.

The suggested upper temperature limit of 1260 °C (2300 °F) given in the ASTM standard [7] for protected type K thermocouples applies to 3.25 mm² (8 AWG) wire. It decreases to 1090 °C (1994 °F) for 1.63 mm² (14 AWG), 980 °C (1796 °F) for 0.81 mm² (20 AWG), 870 °C (1598 °F) for 0.51 or 0.33 mm² (24 or 28 AWG), and 760 °C (1400 °F) for 0.25 mm² (30 AWG). These temperature limits apply to thermocouples used in conventional closed-end protecting tubes and they are intended only as a rough guide to the user. They do not apply to thermocouples having compacted mineral oxide insulation.

Type N Thermocouples

This section describes nickel-chromium-silicon alloy versus nickel-silicon-magnesium alloy thermocouples, commonly referred to as type N thermocouples. This type is the newest of the letter-designated thermocouples. It offers higher thermoelectric stability in air above 1000 °C (1832 °F) and better air-oxidation resistance than types E, J, and K thermocouples. The positive thermoelement, NP, is an alloy that typically contains about 84% nickel, 14...14.4% chromium, 1.3...1.6% silicon, plus small amounts (usually not exceeding about 0.1%) of other elements such as magnesium, iron, carbon, and cobalt. The negative thermoelement, NN, is an alloy that typically contains about 95% nickel, 4.2...4.6% silicon, 0.5...1.5% magnesium, plus minor impurities of iron, cobalt, manganese and carbon totaling about 0.1...0.3%. The type NP and NN alloys were known originally [16] as *nicrosil* and *nisil*, respectively.

The research reported in NBS Monograph 161 showed that the type N thermocouple may be used down to liquid helium temperatures (about 4 °K) but that its Seebeck coefficient becomes very small below 20 °K. Its Seebeck coefficient at 20 °K is about 2.5 $\mu\text{V}/\text{K}$, roughly one-third that of type E thermocouples that are the most suitable of the letter-designated thermocouple types for measurements down to 20 °K. Nevertheless, types NP and NN thermoelements do have a relatively low thermal conductivity and good resistance to corrosion in moist atmospheres at low temperatures.

Type N thermocouples are best suited for use in oxidizing or inert atmospheres. Their suggested upper temperature limit, when used in conventional closed-end protecting tubes, is set at 1260 °C (2300 °F) by the ASTM [7] for 3.25 mm diameter thermoelements. Their maximum upper temperature limit is defined by the melting temperature of the thermoelements, which are nominally 1410 °C (2570 °F) for type NP and 1340 °C (2444 °F) for type NN [5].

The thermoelectric stability and physical life of type N thermocouples when used in air at elevated temperatures will depend upon factors such as the temperature, the time at temperature, the diameter of the thermoelements, and the conditions of use. Their thermoelectric stability and oxidation resistance in air have been investigated and compared with those of type K thermocouples by Burley [16], by Burley and others [13,44-47], by Wang and Starr [17,43,48,49], by McLaren and Murdock [33], by Bentley [19], and by Hess [50].

Type N thermocouples, in general, are subject to the same environmental restrictions as types E and K. They are not recommended for use at high temperatures in sulfurous, reducing, or alternately oxidizing and reducing atmospheres unless suitably protected with protecting tubes. They also should not be used in vacuum (at high temperatures) for extended times because the chromium and silicon in the positive thermoelement, a nickel-chromium-silicon alloy, vaporize out of solution and alter the calibration.

In addition, their use in atmospheres with low, but not negligible, oxygen content is not recommended, because it can lead to changes in calibration due to the preferential oxidation of chromium in the positive thermoelement. Nevertheless, Wang and Starr [49] studied the performances of type N thermocouples in reducing atmospheres, as well as in stagnant air, at temperatures in the 870...1180 °C (1598...2156 °F) range and found them to be markedly more stable thermoelectrically than type K thermocouples under similar conditions.

The performance of type N thermocouples fabricated in metal-sheathed, compacted ceramic insulated form also has been the subject of considerable study. Anderson and others [51], Bentley and Morgan [52], and Wang and Bediones [53] have evaluated the high-temperature, thermoelectric stability of thermocouples insulated with magnesium oxide and sheathed in Inconel and in stainless steel. Their studies showed that the thermoelectric instabilities of such assemblies increase rapidly with temperature above 1000 °C (1832 °F). It was found also that the smaller the diameter of the sheath the greater the instability. Additionally, thermocouples sheathed in Inconel showed substantially less instability above 1000 °C (1832 °F) than those sheathed in stainless steel. Bentley and Morgan [52] stressed the importance of using Inconel sheathing with a very low manganese content to achieve the most stable performance. The use of special Ni-Cr based alloys for sheathing to improve the chemical and physical compatibility with the thermoelements also has been investigated by Burley [54-56] and by Bentley [57-60].

Neither thermoelement of a type N thermocouple is extremely sensitive to minor differences in heat treatment (provided that the treatment does not violate any of the restrictions mentioned above). For most general applications, they may be used with the heat treatment routinely given by the wire manufacturer. Bentley [61,62], however, has reported reversible changes in the Seebeck coefficient of type NP and NN thermoelements when heated at temperatures between 200 °C (392 °F) and 1000 °C (1832 °F). These impose limitations on the accuracy obtainable with type N thermocouples. The magnitude of such changes was found to depend on the source of the thermoelements. Consequently, when the highest accuracy and stability are sought, selective testing of materials, as well as special preparatory heat treatments beyond those given by the manufacturer, will usually be necessary. Bentley's articles [61,62] should be consulted for guidelines and details.

ASTM Standard E230-87 in the 1992 Annual Book of ASTM Standards [7] specifies that the initial calibration tolerances for type N commercial thermocouples be ± 2.2 °C (± 35.96 °F) or $\pm 0.75\%$ (whichever is greater) between 0 °C (32 °F) and 1250 °C (2282 °F). Type N thermocouples can also be supplied to meet special tolerances that are equal to approximately one-half the standard tolerances given above. Tolerances are not specified for type N thermocouples below 0 °C (32 °F).

The suggested upper temperature limit of 1260 °C (2300 °F) given in the ASTM standard [7] for protected type N thermocouples applies to 3.25 mm² (8 AWG) wire. It decreases to 1090 °C (1994 °F) for 1.63 mm² (14 AWG), 980 °C (1796 °F) for 0.81 mm² (20 AWG), 870 °C (1598 °F) for 0.51 or 33 mm² (24 or 28 AWG), and 760 °C (1400 °F) for 0.25 mm² (30 AWG). These temperature limits apply to thermocouples used in conventional closed-end protecting tubes and they are intended only as a rough guide to the user. They do not apply to thermocouples having compacted mineral oxide insulation.

Type R Thermocouples

This section describes platinum-13% rhodium alloy versus platinum thermocouples, called type R thermocouples. This type is often referred to by the nominal chemical composition of its positive (RP) thermoelement: platinum-13% rhodium. The negative (RN) thermoelement is commercially-available platinum that has a nominal purity of 99.99% [21]. An industrial consensus standard (ASTM E1159-87) specifies that rhodium having a nominal purity of 99.98% shall be alloyed with platinum of 99.99% purity to produce the positive thermoelement, which typically contains 13.00 ±0.05% rhodium by weight. This consensus standard [21] describes the purity of commercial type R materials that are used in many industrial thermometry applications and that meet the calibration tolerances described later in this section. It does not cover, however, the higher-purity, reference-grade materials that traditionally were used to construct thermocouples used as transfer standards and reference thermometers in various laboratory applications and to develop reference functions and tables [22,23]. The higher purity alloy material typically contains less than 500 atomic ppm of impurities and the platinum less than 100 atomic ppm of impurities [22]. Differences between such high purity commercial material and the platinum thermoelectric reference standard, Pt-67, are described in [22] and [23].

A reference function for the type R thermocouple, based on the ITS-90 and the SI volt, was determined recently from new data obtained in a collaborative effort by NIST and NPL. The results of this international collaboration were reported by Burns et al [23]. The function was used to compute the reference table given in this monograph.

Type R thermocouples have about a 12% larger Seebeck coefficient than do Type S thermocouples over much of the range. Type R thermocouples were not standard interpolating instruments on the IPTS-68 for the 630.74 °C (1167.33 °F) to gold freezing-point range. Other than these two points, and remarks regarding history and composition, all of the precautions and restrictions on usage given in the section on type S thermocouples also apply to type R thermocouples. Glawe and Szaniszlo [24], and Walker et al [25,26] have determined the effects that prolonged exposure at elevated temperatures (>1200 °C (>2192 °F)) in vacuum, air, and argon atmospheres have on the thermoelectric voltages of type R thermocouples.

ASTM Standard E230-87 in the 1992 Annual Book of ASTM Standards [7] specifies that the initial calibration tolerances for type R commercial thermocouples be ± 1.5 °C (± 34.7 °F) or $\pm 0.25\%$ (whichever is greater) between 0 °C (32 °F) and 1450 °C (2642 °F). Type R thermocouples can be supplied to meet special tolerances of ± 0.6 °C (± 33.08 °F) or $\pm 0.1\%$ (whichever is greater).

The suggested upper temperature limit, 1480 °C (2696 °F), given in the ASTM standard [7] for protected type R thermocouples applies to 0.51 mm² (24 AWG) wire. This temperature limit applies to thermocouples used in conventional closed-end protecting tubes and it is intended only as a rough guide to the user. It does not apply to thermocouples having compacted mineral oxide insulation.

Type S Thermocouples

This section describes platinum-10% rhodium alloy versus platinum thermocouples, commonly known as type S thermocouples. This type is often referred to by the nominal chemical composition of its positive (SP) thermoelement: platinum-10% rhodium. The negative (SN) thermoelement is commercially available platinum that has a nominal purity of 99.99% [21]. An industrial consensus standard (ASTM E1159-87) specifies that rhodium having a nominal purity of 99.98% shall be alloyed with platinum of 99.99% purity to produce the positive thermoelement, which typically contains 10.00 $\pm 0.05\%$ rhodium by weight. The consensus standard [21] describes the purity of commercial type S materials that are used in many industrial thermometry applications and that meet the calibration tolerances described later in this section. It does not cover, however, the higher-purity, reference-grade materials that traditionally were used to construct thermocouples used as standard instruments of the IPTS-68, as transfer standards and reference thermometers in various laboratory applications, and to develop reference functions and tables [27,28]. The higher purity alloy material typically contains less than 500 atomic ppm of impurities and the platinum less than 100 atomic ppm of impurities [27]. Difference between such high purity commercial material and the platinum thermoelectric reference standard, Pt-67, are described in [27] and [28].

A reference function for the type S thermocouple, based on the ITS-90 and the SI volt, was determined recently from new data obtained in an international collaborative effort involving eight national laboratories. The results of this international collaboration were reported by Burns et al. [28]. The new function was used to compute the reference table given in this monograph.

Research [27] demonstrated that type S thermocouples can be used from -50 °C (-58 °F) to the platinum melting-point temperature. They may be used intermittently at temperatures up to the platinum melting point and continuously up to about 1300 °C (2372 °F) with only small changes in their calibrations. The ultimate useful life of the thermocouples when used at such elevated temperatures is governed primarily by physical problems of impurity diffusion and grain growth, which lead to mechanical failure. The thermocouple is most reliable when used in a clean oxidizing atmosphere (air) but may be used also in inert gaseous atmospheres or in a vacuum for short periods of time. However, type B thermocouples are generally more suitable for such applications above 1200 °C (2192 °F). Type S thermocouples should not be used in reducing atmospheres, nor in those containing metallic vapor (such as lead or zinc), nonmetallic vapors (such as arsenic, phosphorus, or sulfur) or easily reduced oxides, unless they are suitably protected with nonmetallic protecting tubes. Also, they should never be inserted directly into a metallic protection tube for use at high temperatures. The stability of type S thermocouples at high temperatures (>1200 °C (>2192 °F)) depends primarily upon the quality of the materials used for protection and insulation, and has been studied by Walker et al. [25,26] and by Bentley [29]. High purity alumina, with low iron content, appears to be the most suitable material for insulating, protecting, and mechanically supporting the thermocouple wires.

Both thermoelements of type S thermocouples are sensitive to impurity contamination. In fact, type R thermocouples were developed essentially because of iron contamination effects in some British platinum-10 percent rhodium wires. The effects of various impurities on the thermoelectric voltages of platinum based thermocouple materials have been described by Rhys and Taimsalu [35], by Cochrane [36] and by Aliotta [37]. Impurity contamination usually causes negative changes [25,26,29] in the thermoelectric voltage of the thermocouple with time, the extent of which will depend upon the type and amount of chemical contaminant. Such changes were shown to be due mainly to the platinum thermoelement [25,26,29]. Volatilization of the rhodium from the positive thermoelement for the vapor transport of rhodium from the positive thermoelement to the pure platinum negative thermoelement also will cause negative drifts in the thermoelectric voltage. Bentley [29] demonstrated that the vapor transport of rhodium can be virtually eliminated at 1700 °C (3092 °F) by using a single length of twin-bore tubing to insulate the thermoelements and that contamination of the thermocouple by impurities transferred from the alumina insulator can be reduced by heat treating the insulator prior to its use.

McLaren and Murdock [30-33] and Bentley and Jones [34] thoroughly studied the performance of type S thermocouples in the range 0...1100 °C (32...2012 °F). They described how thermally reversible effects, such as quenched-in point defects, mechanical stresses, and preferential oxidation of rhodium in the type SP thermoelement, cause chemical and physical inhomogeneities in the thermocouple and thereby limit its accuracy in this range. They emphasized the importance of annealing techniques.

The positive thermoelement is unstable in a thermal neutron flux because the rhodium converts to palladium. The negative thermoelement is relatively stable to neutron transmutation. Fast neutron bombardment, however, will cause physical damage, which will change the thermoelectric voltage unless it is annealed out.

At the gold freezing-point temperature, 1064.18 °C (1947.52 °F), the thermoelectric voltage of type S thermocouples increases by about 340 μV (about 3%) per weight percent increase in rhodium content; the Seebeck coefficient increases by about 4% per weight percent increase at the same temperature.

ASTM Standard E230-87 in the 1992 Annual Book of ASTM Standards [7] specifies that the initial calibration tolerances for type S commercial thermocouples be ± 1.5 °C (± 34.7 °F) or $\pm 0.25\%$ (whichever is greater) between 0 °C (32 °F) and 1450 °C (2642 °F). Type S thermocouples can be supplied to meet special tolerances of ± 0.6 °C (± 33.08 °F) or $\pm 0.1\%$ (whichever is greater).

The suggested upper temperature limit, 1480 °C (2696 °F), given in the ASTM standard [7] for protected type S thermocouples applies to 0.51 mm² (24 AWG) wire. This temperature limit applies to thermocouples used in conventional closed-end protecting tubes and it is intended only as a rough guide to the user. It does not apply to thermocouples having compacted mineral oxide insulation.

Type T Thermocouples

This section describes copper Versus copper-nickel alloy thermocouples, called type T thermocouples. This type is one of the oldest and most popular thermocouples for determining temperatures within the range from about 370 °C (698 °F) down to the triple point of neon (-248.5939 °C (-415.4690 °F)). Its positive thermoelement, TP, is typically copper of high electrical conductivity and low oxygen content that conforms to ASTM Specification B3 for soft or annealed bare copper wire. Such material is about 99.95% pure copper with an oxygen content varying from 0.02...0.07% (depending upon sulfur content) and with other impurities totaling about 0.01%. Above about -200 °C (-328 °F), the thermoelectric properties of type TP thermoelements, which satisfy the above conditions, are exceptionally uniform and exhibit little variation between lots. Below about -200 °C (-328 °F) the thermoelectric properties are affected more strongly by the presence of dilute transition metal solutes, particularly iron.

The negative thermoelement, TN or EN, is a copper-nickel alloy known ambiguously as constantan. The word constantan refers to a family of copper-nickel alloys containing anywhere from 45...60% copper. These alloys also typically contain small percentages of cobalt, manganese and iron, as well as trace impurities of other elements such as carbon, magnesium, silicon, and so forth. The constantan for type T thermocouples usually contains about 55% copper, 45% nickel, and small but thermoelectrically significant amounts, about 0.1% or larger, of cobalt, iron, or manganese. It should be emphasized that type TN (or EN) thermoelements are not generally interchangeable with type JN thermoelements although they are all referred to as 'constantan'. In order to provide some differentiation in nomenclature, type TN (or EN) is often referred to as Adams' (or RP1080) constantan and type JN is usually referred to as SAMA constantan.

The thermoelectric relations for type TN and type EN thermoelements are the same, that is the voltage versus temperature equations and tables for platinum versus type TN thermoelements apply to both types of thermoelements over the temperature range recommended for each thermocouple type. However, it should not be assumed that type TN and type EN thermoelements may be used interchangeably or that they have the same commercial initial calibration tolerances.

The low temperature research [8] by members of the NBS Cryogenics Division showed that the type T thermocouple may be used down to liquid helium temperatures (about 4 °K) but that its Seebeck coefficient becomes quite small below 20 °K. Its Seebeck coefficient at 20 °K is only about 5.6 $\mu\text{V}/\text{K}$, being roughly two-thirds that of the type E thermocouple. The thermoelectric homogeneity of most type TP and type TN (or EN) thermoelements is reasonably good. There is considerable variability, however, in the thermoelectric properties of type TP thermoelements below about 70 °K caused by variations in the amounts and types of impurities present in these nearly pure materials. The high thermal conductivity of the type TP thermoelements can also be troublesome in precise applications. For these reasons, type T thermocouples are generally unsuitable for use below about 20 °K. Type E thermocouples are recommended as the most suitable of the letter-designated thermocouple types for general low-temperature use, because they offer the best overall combination of desirable properties.

Type T thermocouples are recommended by the ASTM [5] for use in the temperature range from -200...370 °C (-328...698 °F) in vacuum or in oxidizing, reducing, or inert atmospheres. The suggested upper temperature limit for continuous service of protected type T thermocouples is set at 370 °C (698 °F) for 1.63 mm² (14 AWG) thermoelements because type TP thermoelements oxidize rapidly above this temperature. However, the thermoelectric properties of type TP thermoelements are apparently not grossly affected by oxidation because negligible changes in the thermoelectric voltage were observed at NBS [10] for 12, 18, and 22 AWG type TP thermoelements during 30 hours of heating in air at 500 °C (932 °F).

At this temperature the type TN thermoelements have good resistance to oxidation and exhibit only small voltage changes heated in air for long periods of time, as shown by the studies of Dahl [11]. Higher operating temperatures, up to at least 800 °C (1472 °F), are possible in inert atmospheres where the deterioration of the type TP thermoelement is no longer an anomaly. The use of type T thermocouples in hydrogen atmospheres at temperatures above about 370 °C (698 °F) is not recommended because type TP thermoelements may become brittle.

Type T thermocouples are not well suited for use in nuclear environments because both thermoelements are subject to significant changes in composition under thermal neutron irradiation. The copper in the thermoelements is converted to nickel and zinc.

Because of the high thermal conductivity of type TP thermoelements, special care should be exercised when using the thermocouples to be sure that the measuring and reference junctions assume the desired temperatures.

ASTM Standard E230-87 in the 1992 Annual Book of ASTM Standards [7] specifies that the initial calibration tolerances for type T commercial thermocouples be ± 1 °C (± 33.8 °F) or $\pm 0.75\%$ (whichever is greater) between 0 °C (32 °F) and 350 °C (662 °F), and ± 1 °C (± 33.8 °F) or $\pm 1.5\%$ (whichever is greater) between -200 °C (-328 °F) and 0 °C (32 °F). Type T thermocouples can also be supplied to meet special tolerances which are equal to approximately one-half the standard tolerances given above. Type T thermocouple materials are normally supplied to meet the tolerances specified for temperatures above 0 °C (32 °F). However, the same materials may not satisfy the tolerances specified for the -200...0 °C (-328...32 °F) range. If materials are required to meet the tolerances below 0 °C (32 °F), this should be specified when they are purchased.

The suggested upper temperature limit of 370 °C (698 °F) given in the ASTM standard [7] for protected type T thermocouples applies to 1.63 mm² (14 AWG) wire. It decreases to 260 °C (500 °F) for 0.81 mm² (20 AWG), 200 °C (392 °F) for 0.51 or 0.33 mm² (24 or 28 AWG), and 150 °C (302 °F) for 0.25 mm² (30 AWG). These temperature limits apply to thermocouples used in conventional closed-end protecting tubes and they are intended only as a rough guide to the user. They do not apply to thermocouples having compacted mineral oxide insulation.

References

- [1] Preston-Thomas, H. The International Temperature Scale of 1990 (ITS-90). *Metrologia* 27, 3-10; 1990. *ibid.* p. 107.
- [2] The International Practical Temperature Scale of 1968, Amended Edition of 1975. *Metrologia* 12, 7-17, 1976.
- [3] Mangum, B. W.; Furukawa, G. T. Guidelines for realizing the International Temperature Scale of 1990 (ITS-90). *Natl. Inst. Stand. Technol. Tech. Note* 1265; 1990 August. 190 p.
- [4] The 1976 Provisional 0.5 to 30 K Temperature Scale. *Metrologia* 15, 65-68; 1979.
- [5] ASTM, American Society for Testing and Materials. Manual on the use of thermocouples in temperature measurement. Special Tech. Publ. 470B; edited by Benedict, R. P.; Philadelphia: ASTM; 1981. 258p.
- [6] Hansen, M.; Anderko, K. Constitution of binary alloys. New York: McGraw-Hill Book Co.; 1958.
- [7] ASTM, American Society for Testing and Materials, Standard E230-87, 1992 Annual Book of ASTM Standards. Vol. 14.03; Philadelphia: ASTM; 1992. 102-230.
- [8] Sparks, L. L.; Powell, R. L.; Hall, W. J. Reference tables for low-temperature thermocouples. *Natl. Bur. Stand. (U.S.) Monogr.* 124; 1972 June. 61p.
- [9] Starr, C.D.; Wang, T. P. Effect of oxidation on stability of thermocouples, *Proceedings of the American Society for Testing and Materials* Vol. 63, 1185-1194; 1963.
- [10] Roeser, W. F.; Dahl, A. I. Reference tables for iron-constantan and copper-constantan thermocouples. *J. Res. Natl. Bur. Stand. (U.S.)* 20, 337-355; RP1080; 1938 March.
- [11] Dahl, A. I. Stability of base-metal thermocouples in air from 800 to 2200°F. *J. Res. Natl. Bur. Stand. (U.S.)* 24, 205-224; RP1278; 1940 February.
- [12] Sparks, L. L.; Powell, R. L. Low temperatures thermocouples: KP, "normal" silver, and copper versus Au-0.02 at % Fe and Au-0.07 at % Fe. *J. Res. Natl. Bur. Stand. (U.S.)* 76A(3), 263-283; 1972 May-June.
- [13] Burley, N. A.; Hess, R. M.; Howie, C. F.; Coleman, J. A. The nicrosil versus nilsil thermocouple: A critical comparison with the ANSI standard letter-designated base-metal thermocouples. *Temperature: Its Measurement and Control in Science and Industry; Vol. 5*, Schooley, J. F., ed.; New York: American Institute of Physics; 1982. 1159-1166.

- [14] Potts, J. F. Jr.; McElroy, D. L. The effects of cold working, heat treatment, and oxidation on the thermal emf of nickel-base thermoelements. Herzfeld, C. M.; Brickwedde, F. G.; Dahl, A. I.; Hardy, J. D., ed. *Temperature: Its Measurement and Control in Science and Industry*; Vol. 3, Part 2; New York: Reinhold Publishing Corp.; 1962. 243-264.
- [15] Burley, N. A.; Ackland, R. G. The stability of the thermo-emf/temperature characteristics of nickel-base thermocouples. *Jour. of Australian Inst. of Metals* 12(1), 23-31; 1967.
- [16] Burley, N. A. Nicrosil and nisil: Highly stable nickel-base alloys for thermocouples. *Temperature: Its Measurement and Control in Science and Industry*; Vol. 4, Plumb, H. H., ed.; Pittsburgh: Instrument Society of America; 1972. 1677-1695.
- [17] Wang, T. P.; Starr, C. D. Electromotive force stability of nicrosil-nisil. *Journal of Testing and Evaluation* 8(4), 192-198; 1980.
- [18] Starr, C. D.; Wang, T. P. Effect of oxidation on stability of thermocouples, *Proceedings of the American Society for Testing and Materials* Vol. 63 1185-1194; 1963.
- [19] Bentley, R. E. Short-term instabilities in thermocouples containing nickel-based alloys. *High Temperatures- High Pressures* 15, 599-611; 1983.
- [20] Kollie, T. G.; Horton, J. L.; Carr, K. R.; Herskovitz, M. B.; Mossman, C. A. Temperature measurement errors with type K (Chromel versus Alumel) thermocouples due to short-ranged ordering in Chromel. *Rev. Sci. Instrum.* 46, 1447-1461; 1975.
- [21] ASTM, American Society for Testing and Materials, Standard E1159-87, 1992 Annual Book of ASTM Standards. Vol. 14.03; Philadelphia: ASTM; 1992. 388-389.
- [22] Bedford, R. E.; Ma, C. K.; Barber, C. R.; Chandler, T. R.; Quinn, T. J.; Burns, G. W.; Scroger, M. New reference tables for platinum 10% rhodium/platinum and platinum 13% rhodium/platinum thermocouples. *Temperature: Its Measurement and Control in Science and Industry*; Vol. 4, Part 3, p. 1585; Plumb, H. H., ed.; Pittsburgh: Instrument Society of America; 1972.
- [23] Burns, G. W.; Strouse, G. F.; Mangum, B. W.; Croarkin, M. C.; Guthrie, W. F.; Chattle, M. New reference functions for platinum-13% rhodium versus platinum (type R) and platinum-30% rhodium versus platinum-6% rhodium (type B) thermocouples based on the ITS-90. in *Temperature: Its Measurement and Control in Science and Industry*; Vol. 6; Schooley, J. F., ed.; New York: American Institute of Physics; 1992. 559-564.

- [24] Glawe, G. E.; Szaniszlo, A. J. Long-term drift of some noble- and refractory-metal thermocouples at 1600K in air, argon, and vacuum. *Temperature: Its Measurement and Control in Science and Industry*; Vol. 4; Plumb, H. H., ed.; Pittsburgh: Instrument Society of America; 1972. 1645-1662.
- [25] Walker, B. E.; Ewing, C. T.; Miller, R. R. Thermoelectric instability of some noble metal thermocouples at high temperatures. *Rev. Sci. Instrum.* 33, 1029-1040; 1962.
- [26] Walker, B. E.; Ewing, C. T.; Miller, R. R. Study of the instability of noble metal thermocouples in vacuum. *Rev. Sci. Instrum.* 36, 601-606; 1965.
- [27] Bedford, R. E.; Ma, C. K.; Barber, C. R.; Chandler, T. R.; Quinn, T. J.; Burns, G. W.; Scroger, M. New reference tables for platinum 10% rhodium/platinum and platinum 13% rhodium/platinum thermocouples. *Temperature: Its Measurement and Control in Science and Industry*; Vol. 4; Plumb, H. H., ed.; Pittsburgh: Instrument Society of America; 1972. 1585-1603.
- [28] Burns, G. W.; Strouse, G. F.; Mangum, B. W.; Croarkin, M. C.; Guthrie, W. F.; Marcarino, P.; Battuello, M.; Lee, H. K.; Kim, J. C.; Gam, K. S.; Rhee, C.; Chattle, M.; Arai, M.; Sakurai, H.; Pokhodun, A. I.; Moiseeva, N. P.; Perevalova, S. A.; de Groot, M. J.; Zhang, J.; Fan, K.; Wu, S. New reference functions for platinum-10% rhodium versus platinum (type S) thermocouples based on the ITS-90, Part I and Part II. in *Temperature: Its Measurement and Control in Science and Industry*; Vol. 6; Schooley, J. F., ed.; New York: American Institute of Physics; 1992. 537-546.
- [29] Bentley, R. E. Changes in Seebeck coefficient of Pt and Pt 10% Rh after use to 1700C in high-purity polycrystalline alumina. *Int. J. Thermophys.* 6(1), 83-99; 1985.
- [30] McLaren, E. H.; Murdock, E. G. New considerations on the preparation, properties and limitations of the standard thermocouple for thermometry. *Temperature: Its Measurement and Control in Science and Industry*; Vol. 4; Plumb, H. H., ed.; Pittsburgh: Instrument Society of America; 1972. 1543-1560.
- [31] McLaren, E. H.; Murdock, E. G. The properties of Pt/PtRh thermocouples for thermometry in the range 0-1100°C: I. Basic measurements with standard thermocouples. *National Research Council of Canada Publication APH 2212/NRCC 17407*; 1979.
- [32] McLaren, E. H.; Murdock, E. G. The properties of Pt/PtRh thermocouples for thermometry in the range 0-1100°C: II. Effect of heat treatment on standard thermocouples. *National Research Council of Canada Publication APH 2213/NRCC 17408*; 1979.

- [33] McLaren, E. H.; Murdock, E. G. Properties of some noble and base metal thermocouples at fixed points in the range 0-1100°C. *Temperature: Its Measurement and Control in Science and Industry*; Vol. 5; Schooley, J. F., ed.; New York: American Institute of Physics; 1982. 953-975.
- [34] Bentley, R. E.; Jones, T. P. Inhomogeneities in type S thermocouples when used to 1064°C. *High Temperatures- High Pressures* 12, 33-45; 1980.
- [35] Rhys, D. W.; Taimsalu, P. Effect of alloying additions on the thermoelectric properties of platinum. *Engelhard Tech. Bull.* 10, 41-47; 1969.
- [36] Cochrane, J. Relationship of chemical composition to the electrical properties of platinum. *Engelhard Tech. Bull.* 11, 58-71; 1969. Also in *Temperature: Its Measurement and Control in Science and Industry*; Vol. 4; Plumb, H. H., ed.; Pittsburgh: Instrument Society of America; 1972. 1619-1632.
- [37] Aliotta, J. Effects of impurities on the thermoelectric properties of platinum. *Inst. and Control Systems*, 106-107; March 1972.
- [38] Burns, G. W.; Gallagher, J. S. Reference tables for the Pt-30 percent Rh versus Pt-6 percent Rh thermocouple. *J. Res. Natl. Bur. Stand. (U.S.)* 70C, 89-125; 1966.
- [39] Ehringer, H. Uber die lebensdauer von PtRh-thermoelementen. *Metall* 8, 596-598; 1954.
- [40] Acken, J. S. Some properties of platinum-rhodium alloys. *J. Res. Natl. Bur. Stand. (U.S.)* 12, 249; RP650; 1934.
- [41] Hendricks, J. W.; McElroy, D. L. High temperature- high vacuum thermocouple drift tests. *Environmental Quarterly*, 34-38; March 1967.
- [42] Zysk, E. D. Platinum metal thermocouples. *Temperature: Its Measurement and Control in Science and Industry*; Vol. 3; Herzfeld, C. M., ed.; New York: Reinhold Publishing Corp.; 1962. Part 2, pp. 135-156.
- [43] Starr, C. D.; Wang, T. P. A new stable nickel-base thermocouple. *Journal of Testing and Evaluation* 4(1), 42-56; 1976.
- [44] Burley, N. A.; Powell, R. L.; Burns, G. W.; Scroger, M. G. The nicrosil versus nisol thermocouple: properties and thermoelectric reference data. *Natl. Bur. Stand. (U.S.) Monogr.* 161; 1978 April. 167p.
- [45] Burley, N. A.; Jones, T. P. Practical performance of nicrosil-nisol thermocouples. *Temperature Measurement*, 1975; Billing, B. F.; Quinn, T. J., ed.; London and Bristol: Institute of Physics; 1975. 172-180.

- [46] Burley, N. A.; Hess, R. M.; Howie, C. F. Nicrosil and nisil: new nickel-based thermocouple alloys of ultra-high thermoelectric stability. *High Temperatures- High Pressures* 12, 403-410; 1980.
- [47] Burley, N. A.; Cocking, J. L.; Burns, G. W.; Scroger, M. G. The nicrosil versus nisil thermocouple: the influence of magnesium on the thermoelectric stability and oxidation resistance of the alloys. *Temperature: Its Measurement and Control in Science and Industry*; Vol. 5, Schooley, J. F., ed.; New York: American Institute of Physics; 1982. 1129-1145.
- [48] Wang, T. P.; Starr, C. D. Nicrosil-nisil thermocouples in production furnaces in the 538°C (1000°F) to 1177°C (2150°F) range. *ISA Transactions* 18(4), 83-99; 1979.
- [49] Wang, T. P.; Starr, C. D. Oxidation resistance and stability of nicrosil-nisil in air and in reducing atmospheres. *Temperature: Its Measurement and Control in Science and Industry*; Vol. 5, Schooley, J. F., ed.; New York: American Institute of Physics; 1982. 1147-1157.
- [50] Hess, T. G. Nicrosil-nisil: high-performance thermocouple alloys. *ISA Transactions* 16(3), 81-84; 1977.
- [51] Anderson, R. L.; Lyons, J. D.; Kollie, T. G.; Christie, W. H.; Eby, R. Decalibration of sheathed thermocouples. *Temperature: Its Measurement and Control in Science and Industry*; Vol. 5., Schooley, J. F., ed.; New York: American Institute of Physics; 1982. 977-1007.
- [52] Bentley, R. E.; Morgan, T. L. Ni-based thermocouples in the mineral-insulated metal-sheathed format: thermoelectric instabilities to 1100°C. *J. Phys. E: Sci. Instrum.* 19, 262-268; 1986.
- [53] Wang, T. P.; Bediones, D. 10,000 hr. stability test of types K, N, and a Ni-Mo/Ni-Co thermocouple in air and short-term tests in reducing atmospheres. *Temperature: Its Measurement and Control in Science and Industry*; Vol. 6; Schooley, J. F., ed.; New York: American Institute of Physics; 1992. 595-600.
- [54] Burley, N. A. N-CLAD-N: A novel advanced type N integrally-sheathed thermocouple of ultra-high thermoelectric stability. *High Temperatures- High Pressures* 8, 609-616; 1986.
- [55] Burley, N. A. A novel advanced type N integrally-sheathed thermocouple of ultra-high thermoelectric stability. *Thermal and Temperature Measurement in Science and Industry*; 3rd Int. IMEKO Conf.; Sheffield; Sept. 1987. 115-125.
- [56] Burley, N. A. "N-CLAD-N" A novel integrally sheathed thermocouple: optimum design rationale for ultra-high thermoelectric stability. *Temperature: Its Measurement and Control in Science and Industry*; Vol. 6; Schooley, J. F., ed.; New York: American Institute of Physics; 1992. 579-584.

[57] Bentley, R. E. The new nicosil-sheathed type N MIMS thermocouple: an assessment of the first production batch. *Mater. Australas.* 18(6), 16-18; 1986.

[58] Bentley, R. E.; Russell, Nicosil sheathed mineral-insulated type N thermocouple probes for short-term variable-immersion applications to 1100°C. *Sensors and Actuators* 16, 89-100; 1989.

[59] Bentley, R. E. Irreversible thermoelectric changes in type K and type N thermocouple alloys within nicosil-sheathed MIMS cable. *J. Phys. D.* 22, 1908-1915; 1989.

[60] Bentley, R. E. Thermoelectric behavior of Ni-based ID-MIMS thermocouples using the nicosil-plus sheathing alloy. *Temperature: Its Measurement and Control in Science and Industry*; Vol. 6; Schooley, J. F., ed.; New York: American Institute of Physics; 1992. 585-590.

[61] Bentley, R. E. Thermoelectric hysteresis in nicosil and nilsil. *J. Phys. E: Sci. Instrum.* 20, 1368-1373; 1987.

[62] Bentley, R. E. Thermoelectric hysteresis in nickel-based thermocouple alloys. *J. Phys. D.* 22, 1902-1907; 1989.

Using Thermocouple Junctions

This appendix describes the types of thermocouple junctions available, and explains the trade-offs in using them with the 1769-IT6 thermocouple/mV analog input module.



ATTENTION: Take care when choosing a thermocouple junction, and connecting it from the environment to the module. If you do not take adequate precautions for a given thermocouple type, the electrical isolation of the module might be compromised.

Available thermocouple junctions are:

- grounded.
- ungrounded (isolated).
- exposed.

Using a Grounded Junction Thermocouple

With a grounded junction thermocouple, the measuring junction is physically connected to the protective sheath, forming a completely sealed integral junction. If the sheath is metal (or electrically conductive), there is electrical continuity between the junction and sheath. The junction is protected from corrosive or erosive conditions. The response time approaches that of the exposed junction type described in [Using an Exposed Junction Thermocouple on page 137](#).

Figure 50 - Grounded Junction Thermocouple

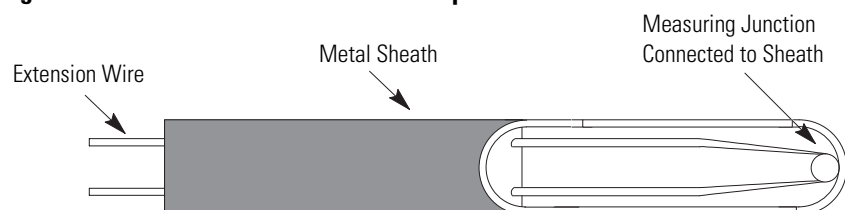

The shield input terminals for a grounded junction thermocouple are connected together and then connected to chassis ground. Use of this thermocouple with an electrically conductive sheath removes the thermocouple signal to chassis ground isolation of the module. In addition, if multiple grounded junction thermocouples are used, the module channel-to-channel isolation is removed, because there is no isolation between signal and sheath (sheaths are tied together). Note that the isolation is removed even if the sheaths are connected to chassis ground at a location other than the module, because the module is connected to chassis ground.

Figure 51 - Shield Input Terminals for a Grounded Junction Thermocouple

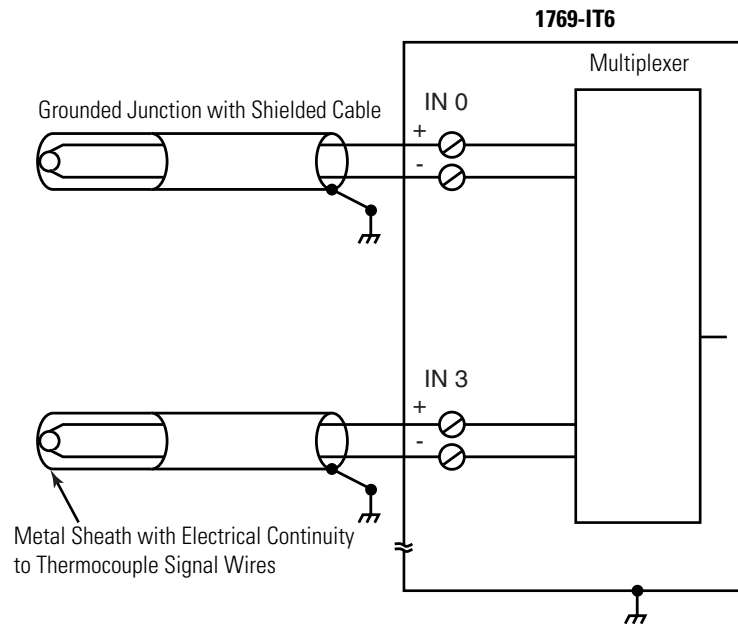

We recommend that a grounded junction thermocouple have a protective sheath made of electrically insulated material (for example, ceramic). An alternative is to float the metal sheath with respect to any path to chassis ground or to another thermocouple metal sheath. Thus, the metal sheath must be insulated from electrically conductive process material, and have all connections to chassis ground broken. Note that a floated sheath can result in a less noise-immune thermocouple signal.

Using an Ungrounded (isolated) Junction Thermocouple

An ungrounded (isolated) junction thermocouple uses a measuring junction that is electrically isolated from the protective metal sheath. This junction type is often used in situations when noise will affect readings, as well as situations using frequent or rapid temperature cycling. For this type of thermocouple junction, the response time is longer than for the grounded junction.

Figure 52 - Ungrounded (isolated) Junction Thermocouple

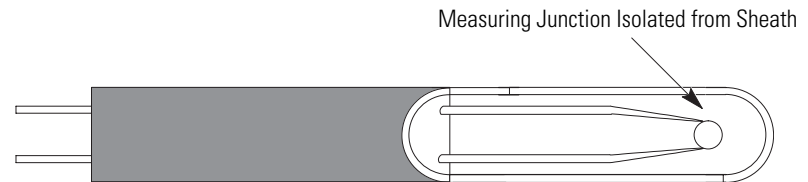

Using an Exposed Junction Thermocouple

An exposed junction thermocouple uses a measuring junction that does not have a protective metal sheath. A thermocouple with this junction type provides the fastest response time but leaves thermocouple wires unprotected against corrosive or mechanical damage.

Figure 53 - Exposed Junction Thermocouple

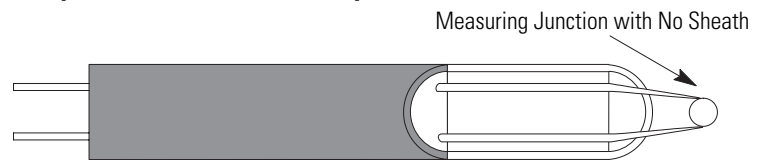

As shown in the next illustration, using an exposed junction thermocouple can result in removal of channel-to-channel isolation. Isolation is removed if multiple exposed thermocouples are in direct contact with electrically conductive process material.

Figure 54 - Exposed Junction Thermocouple Results in Removal of Channel-to-channel Isolation

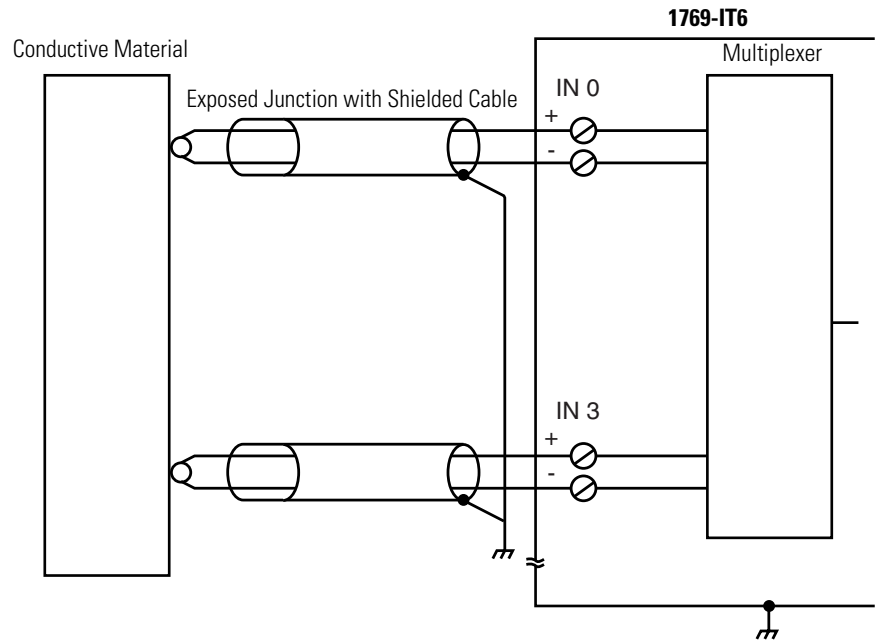

Follow these guidelines to prevent violation of channel-to-channel isolation.

- For multiple exposed junction thermocouples, do not allow the measuring junctions to make direct contact with electrically conductive process material.
- Preferably use a single exposed junction thermocouple with multiple ungrounded junction thermocouples.
- Consider using all ungrounded junction thermocouples instead of the exposed junction type.

Module Configuration by Using a MicroLogix 1500 System and RSLogix 500 Software

This appendix examines the 1769-IT6 module's addressing scheme and describes module configuration by using RSLogix 500 and a MicroLogix 1500 controller.

Module Addressing

This memory map shows the input and configuration image tables for the module. For detailed information on the image table, see [Chapter 4](#).

Figure 55 - Memory Map for Input and Configuration Image Tables

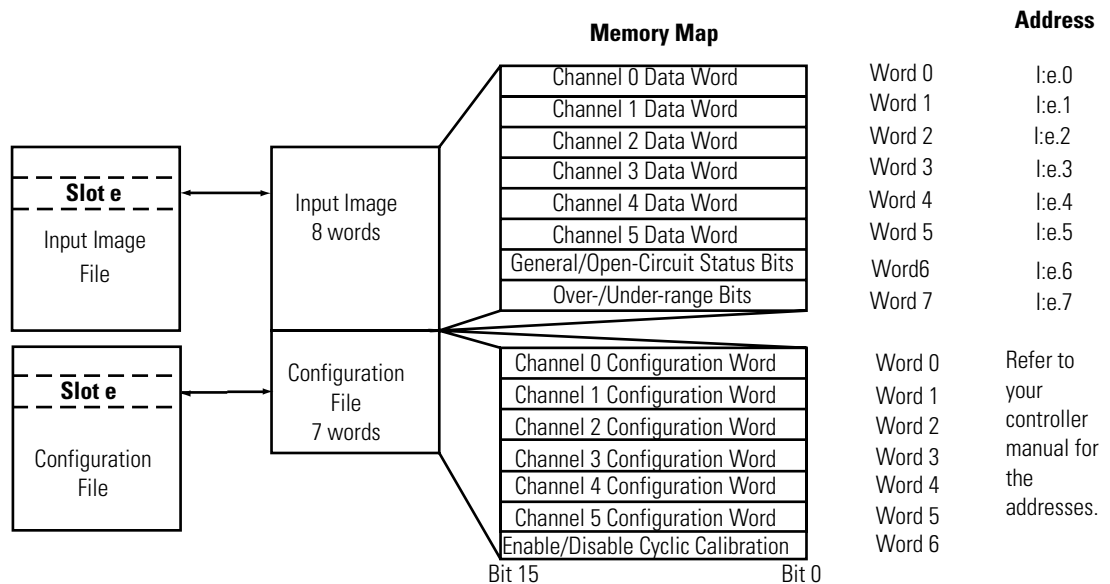

For example, to obtain the general status of channel 2 of the module located in slot e, use address I:e.6/2.

Figure 56 - General Status of Channel 2

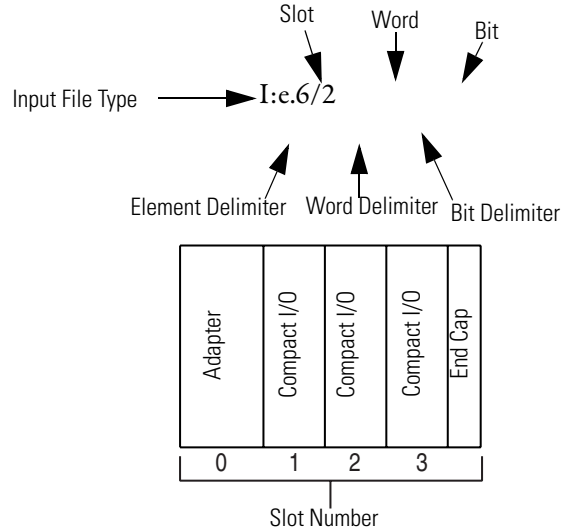

TIP The end cap does not use a slot address.

1769-IT6 Configuration File

The configuration file contains information you use to define the way a specific channel functions. The configuration file is explained in more detail in [Configuring Channels on page 40](#).

The configuration file is modified by using the programming software configuration screen. For an example of module configuration by using RSLogix 500 software, see [Configuring the 1769-IT6 Module in a MicroLogix 1500 System on page 141](#).

Table 16 - Software Configuration Channel Defaults⁽¹⁾

Parameter	Default Setting
Disable/Enable Channel	Disable
Filter Frequency	60 Hz
Input Type	Thermocouple Type J
Data Format	Raw/Proportional
Temperature Units	°C
Open-circuit Response	Upscale
Disable Cyclic Calibration	Enable

⁽¹⁾ May be overridden by the software.

Configuring the 1769-IT6 Module in a MicroLogix 1500 System

This example takes you through configuring your 1769-IT6 thermocouple/mV input module with RSLogix 500 programming software, assumes your module is installed as expansion I/O in a MicroLogix 1500 system, and that RSLinx software is properly configured and a communication link has been established between the MicroLogix processor and RSLogix 500 software.

Start RSLogix 500 software and create a MicroLogix 1500 application.

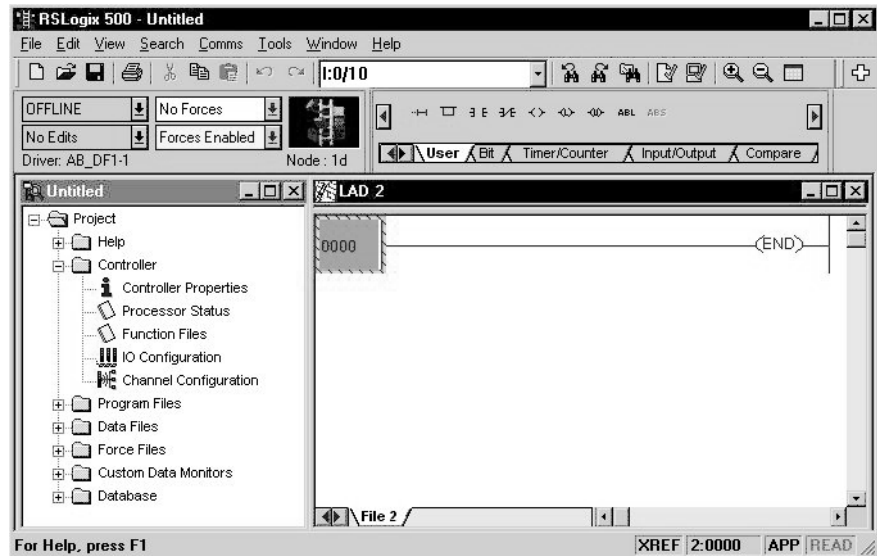

While offline, double-click the Read IO Configuration icon under the controller folder. This IO Configuration dialog box appears.

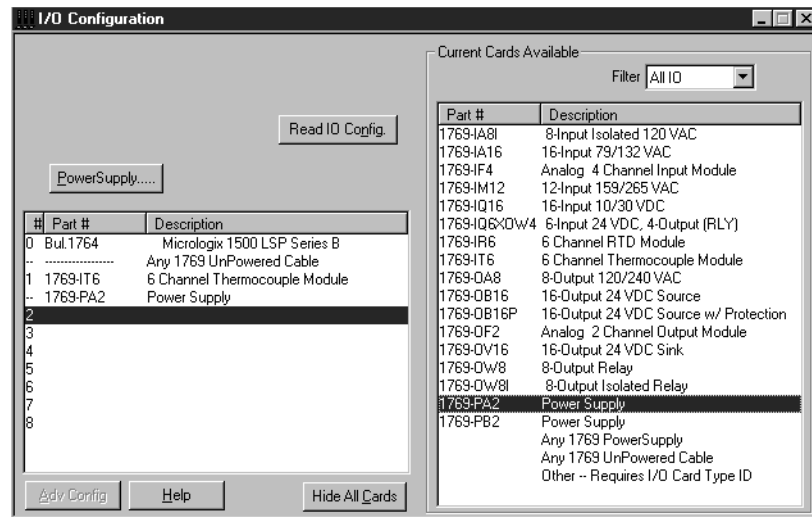

This dialog box lets you manually enter expansion modules into expansion slots, or to automatically read the configuration of the controller. To read the existing controller configuration, click **Read IO Config.**

A communication dialog box appears, identifying the current communication configuration so that you can verify the target controller. If the communication settings are correct, click **Read IO Config**.

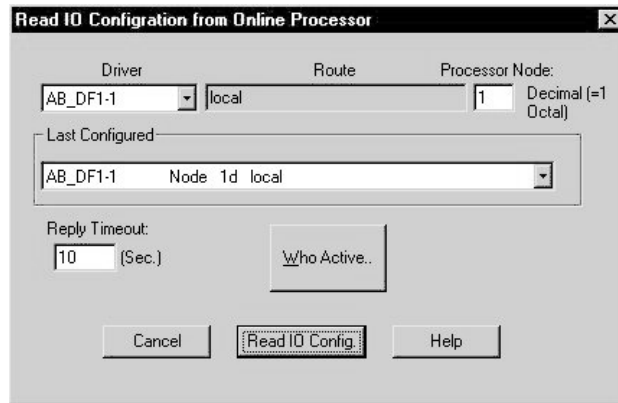

The actual I/O configuration is displayed. In this example, a second tier of I/O is attached to the MicroLogix 1500 processor.

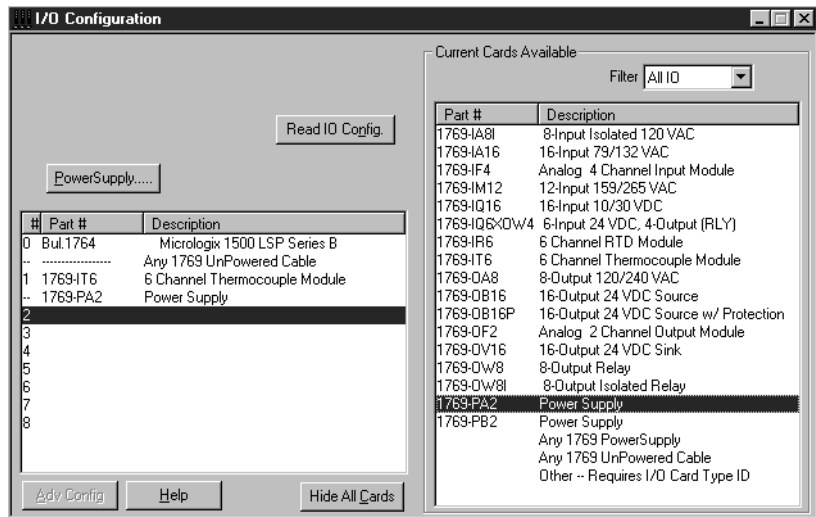

The 1769-IT6 module is installed in slot 1. To configure the module, double-click the module/slot. The general configuration dialog box appears.

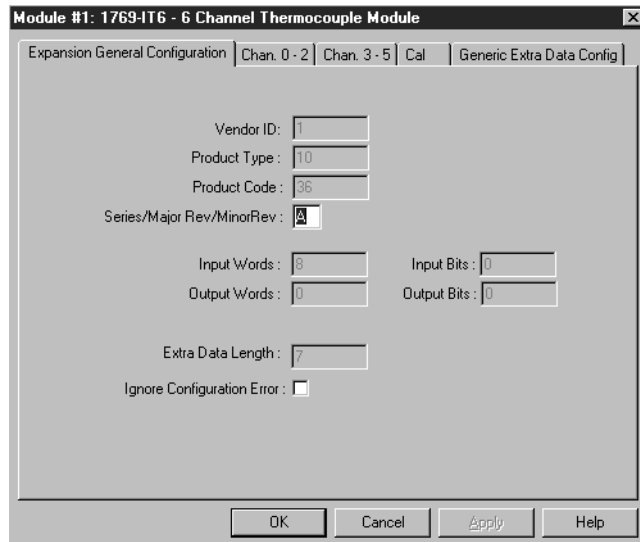

Configuration options for channels 0...2 are on a separate tab from channels 3...5, as shown below. To enable a channel, click its Enable box so that a checkmark appears. For optimum module performance, disable any channel that is not hardwired to a real input. Then, choose your Data Format, Input Type, Filter Frequency, Open Circuit response, and Units for each channel.

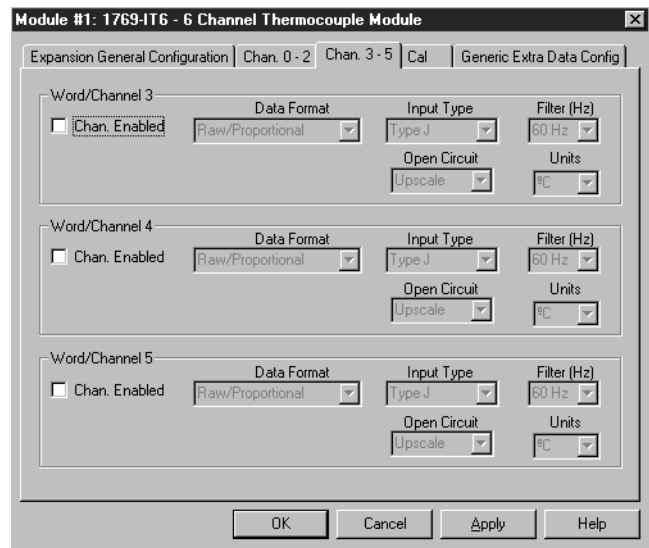
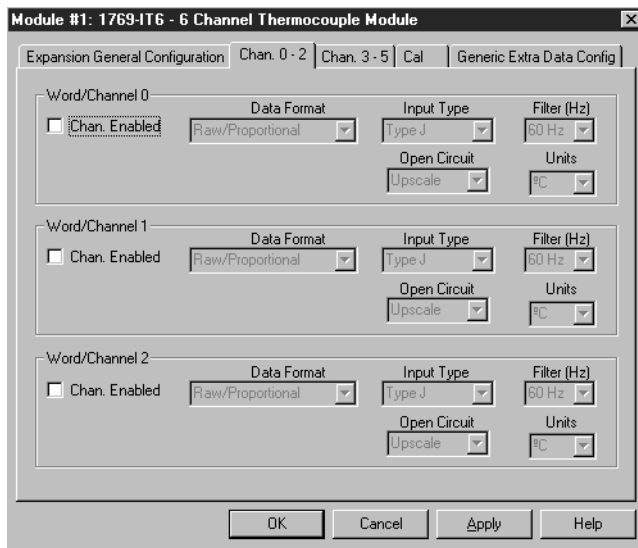

TIP

For a complete description of each of these parameters and the choices available for each of them, see [Configuration Data File on page 41](#).

Configuring Cyclic Calibration

The Cal tab contains a checkbox for disabling cyclic calibration. See [Selecting Enable/Disable Cyclic Calibration \(word 6, bit 0\) on page 50](#) for more information.

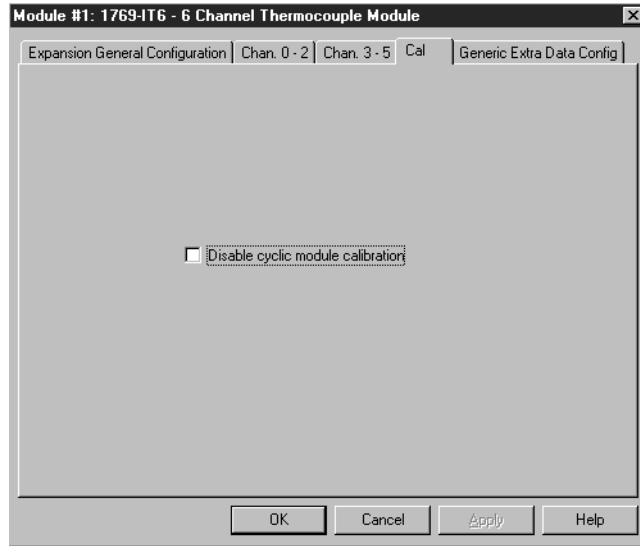

Generic Extra Data Configuration

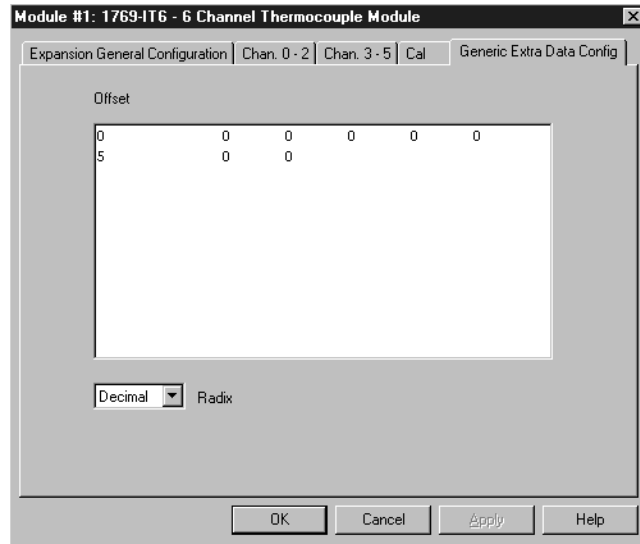

This tab redisplay the configuration information entered on the Analog Input Configuration screen in a raw data format. You have the option of entering the configuration by using this tab instead of the configuration tabs. You do not have to enter data in both places.

Configuring Your 1769-IT6 Module with the Generic Profile for CompactLogix Controllers in RSLogix 5000 Software

The procedure in this example is used only when your 1769-IT6 thermocouple module profile is not available in RSLogix 5000 Programming Software. The initial release of the CompactLogix5320 controller includes the 1769 Generic I/O Profile, with individual 1769 I/O module profiles to follow.

To configure a 1769-IT6 thermocouple module for a CompactLogix controller by using RSLogix 5000 software with the 1769 generic profile, begin a new project in RSLogix 5000 software. Click the new project icon or, from the File pull-down menu, choose New. This dialog box appears.

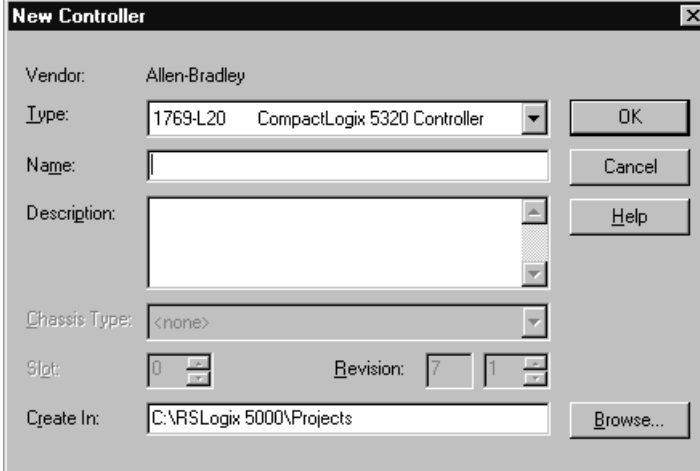

The screenshot shows the 'New Controller' dialog box with the following fields and controls:

- Vendor:** Allen-Bradley
- Type:** 1769-L20 CompactLogix 5320 Controller (dropdown menu)
- Name:** (empty text field)
- Description:** (empty text area)
- Chassis Type:** <none> (dropdown menu)
- Slot:** 0 (spin box)
- Revision:** 7 (spin box)
- Create In:** C:\RSLogix 5000\Projects (text field)
- Buttons:** OK, Cancel, Help, Browse...

Choose your controller type and enter a name for your project, then click OK. This main RSLogix 5000 dialog box appears.

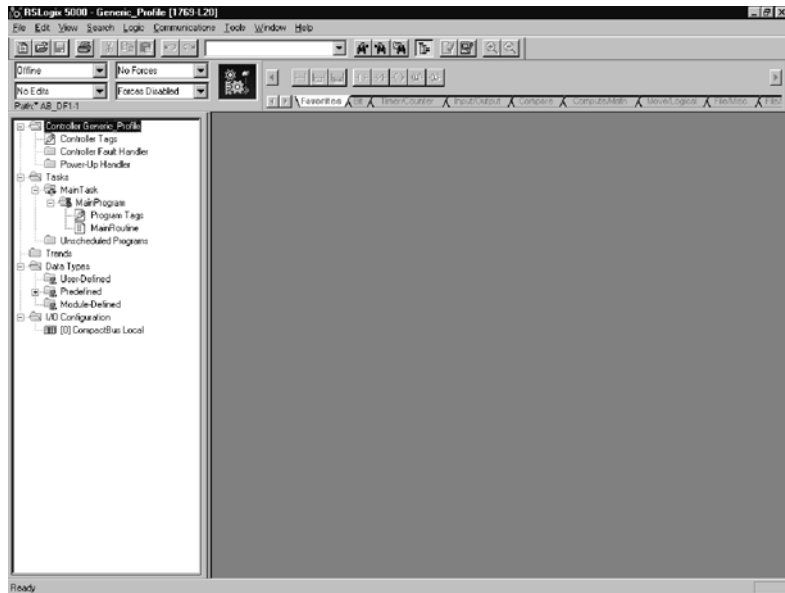

In the Controller Organizer on the left of the dialog box, right-click '[0] CompactBus Local', choose New Module. This dialog box appears.

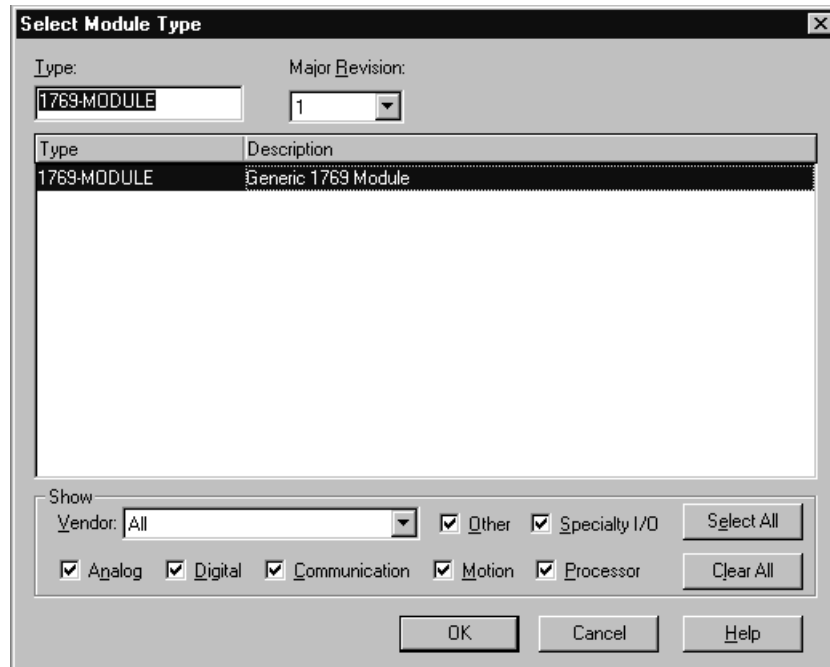

Use this dialog box to narrow your search for I/O modules to configure into your system. With the initial release of the CompactLogix5320 controller, this dialog box includes only the 'Generic 1769 Module'.

Click OK and this default Generic Profile dialog box appears.

First, choose the Comm Format ('Input Data – INT' for the 1769-IT6 module), then fill in the name field. For this example, 'IT6' is used to help identify the module type in the Controller Organizer. The Description field is optional and may be used to provide more details concerning this I/O module in your application.

The slot number must be selected next, although it will begin with the first available slot number, 1, and increments automatically for each subsequent Generic Profile you configure. For this example, the 1769-IT6 thermocouple module is located in slot 1.

Table 17 - 1769-IT6 Comm Format, Assembly Instance, and Size Values

1769 I/O Module	Comm Format	Parameter	Assembly Instance	Size (16-bit)
IT6	Input Data – INT	Input	101	8
		Output	104	0
		Config	102	8

Enter the Assembly Instance numbers and their associated sizes for the 1769-IT6 module into the Generic Profile.

When complete, the Generic Profile for a 1769-IT6 module should look like this.

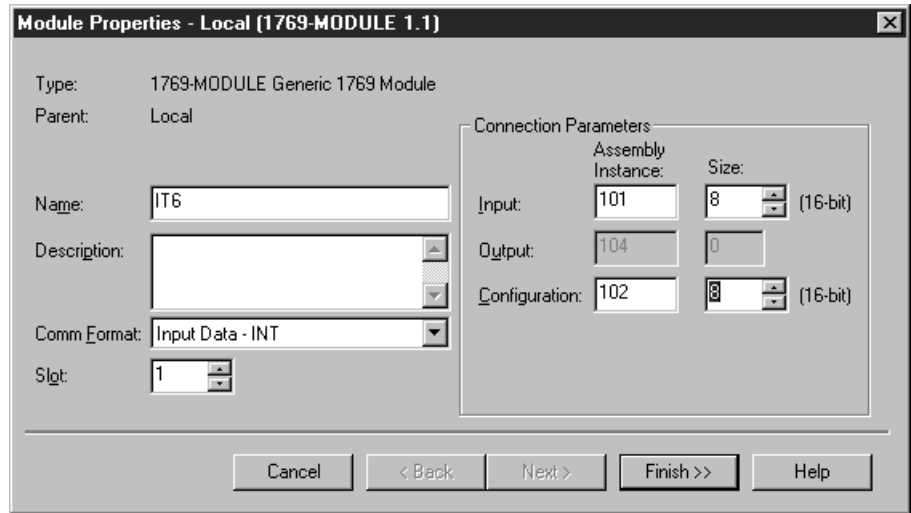

At this point, you may click 'Finish' to complete the configuration of your I/O module.

Configure each I/O module in this manner. The CompactLogix5320 controller supports a maximum of eight I/O modules. The valid slot numbers to select when configuring I/O modules are 1...8.

Configuring I/O Modules

Once you have created a Generic Profile for 1769-IT6 thermocouple module, you must enter configuration information into the Tag database that is automatically created from the Generic Profile information you entered. This configuration information is downloaded to each module at program download, at powerup, and when an inhibited module is uninhibited.

First, enter the Controller Tag database by double-clicking Controller Tags in the upper portion of the Controller Organizer.

Based on the Generic Profile created earlier for 1769-IT6 module, the Controller Tags dialog box looks like this.

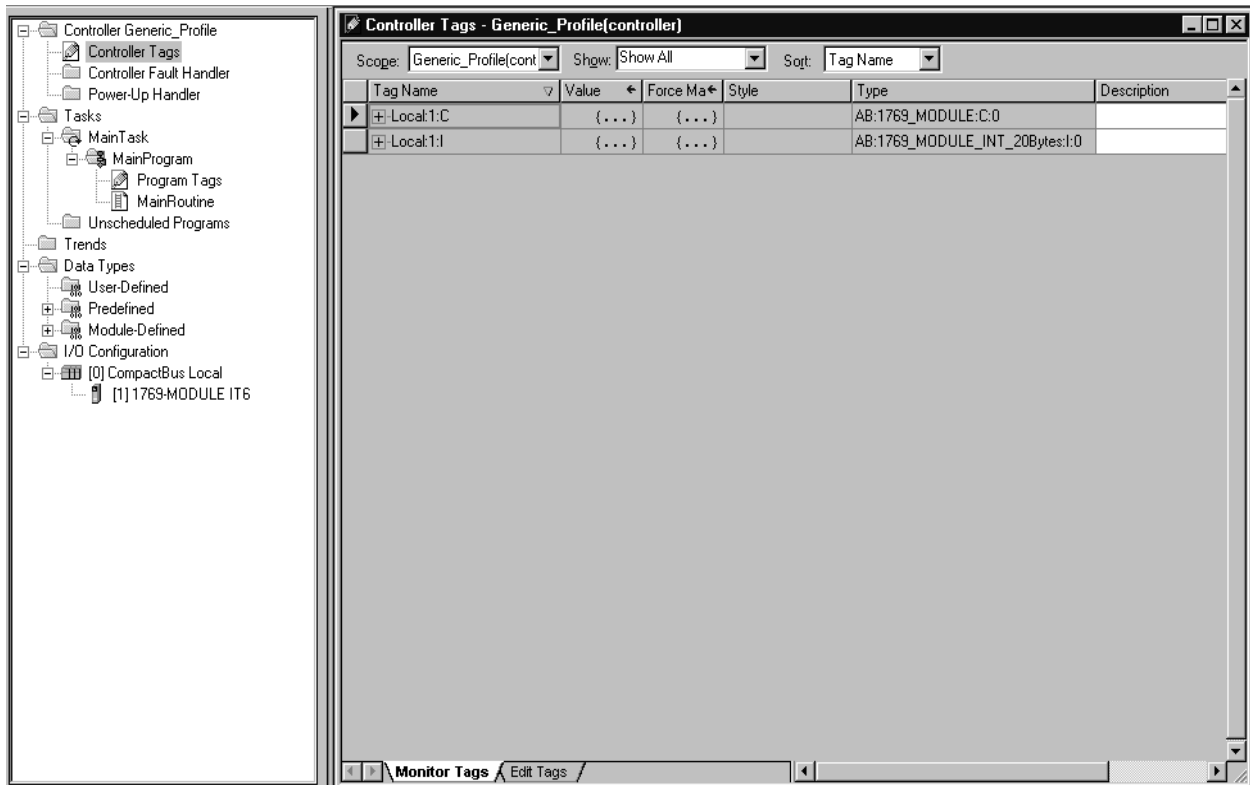

Tag addresses are automatically created for configured I/O modules. All local I/O addresses are preceded by the word Local. These addresses have the following format:

- Input Data: Local:s:I
- Configuration Data: Local:s:C

Where s is the slot number assigned the I/O modules in the Generic Profiles.

To configure an I/O module, you must open up the configuration tag for that module by clicking the plus sign to the left of its configuration tag in the Controller Tag database.

Configuring a 1769-IT6 Thermocouple Module

To configure the 1769-IT6 module in slot 1, click the plus sign left of Local:1:C. Configuration data is entered under the Local:1:C.Data tag. Click the plus sign to the left of Local:1:C.Data to reveal the eight integer data words where configuration data may be entered for the 1769-IT6 module. The tag addresses for these eight words are Local:1:C.Data[0] through Local:1:C.Data[7]. Only the first seven words of the configuration file apply. The last word must exist but should contain a value of 0 decimal.

The first 6 configuration words, 0...5, apply to 1769-IT6 channels 0...5 respectively. All six words configure the same parameters for the six different channels. The seventh configuration word is used for enabling or disabling cyclic calibration. The following table shows the various parameters to configure in each channel configuration word. For a complete description of each of these parameters and the choices available for each of them, see [Configuration Data File on page 41](#).

Table 18 - Parameters to Configure in Each Channel Configuration Word

Bits (words 0...5)	Parameter
0...2	Filter Frequency
4	Not Used
5 and 6	Open Circuit Condition
7	Temperature Units Bit
8...11	Input Type
12...14	Data Format
15	Enable Channel Bit

Once you have entered your configuration selections for each channel, enter your program logic, save your project, and download it to your CompactLogix controller. Your module configuration data is downloaded to your I/O modules at this time. Your 1769-IT6 module input data is located in the following tag addresses when the controller is in Run mode.

Table 19 - Tag Addresses When Controller is in Run Mode

1769-IT6 Channel	Tag Address
0	Local:1:I.Data[0] ⁽¹⁾
1	Local:1:I.Data[1]
2	Local:1:I.Data[2]
3	Local:1:I.Data[3]
4	Local:1:I.Data[4]
5	Local:1:I.Data[5]

⁽¹⁾ Where 1 represents the slot number of the 1769-IT6 module.

Configuring Your 1769-IT6 Module in a Remote DeviceNet System with a 1769-ADN DeviceNet Adapter

This application example assumes your 1769-IT6 thermocouple input module is in a remote DeviceNet system controlled by a 1769-ADN DeviceNet adapter. RSNetworx for DeviceNet software is not only used to configure your DeviceNet network, but is also used to configure individual I/O modules in remote DeviceNet adapter systems.

For additional information on configuring your DeviceNet scanners and adapters, please refer to the documentation for these products, including the Compact I/O 1769-ADN DeviceNet Adapter User Manual, publication [1769-UM001](#). The adapter manual also contains examples on how to modify I/O module configuration with Explicit Messages while the system is running. Whether you are configuring an I/O module offline and downloading to the adapter or you accomplish the configuration online, the 1769-IT6 Thermocouple module must be configured prior to configuring the DeviceNet adapter in the DeviceNet scanner's scanlist. The only ways to configure or reconfigure I/O modules after the adapter is placed in the scanner's scanlist are via Explicit Messages or by removing the adapter from the scanner's scanlist, modifying the configuration of the I/O module, then adding the adapter back into the scanner's scanlist.

This example takes you through configuring your 1769-IT6 thermocouple input module with RSNetWorx for DeviceNet software, version 3.00 or later, prior to adding your adapter to the scanlist of your DeviceNet scanner.

Start RSNetWorx for DeviceNet software. This dialog box appears.

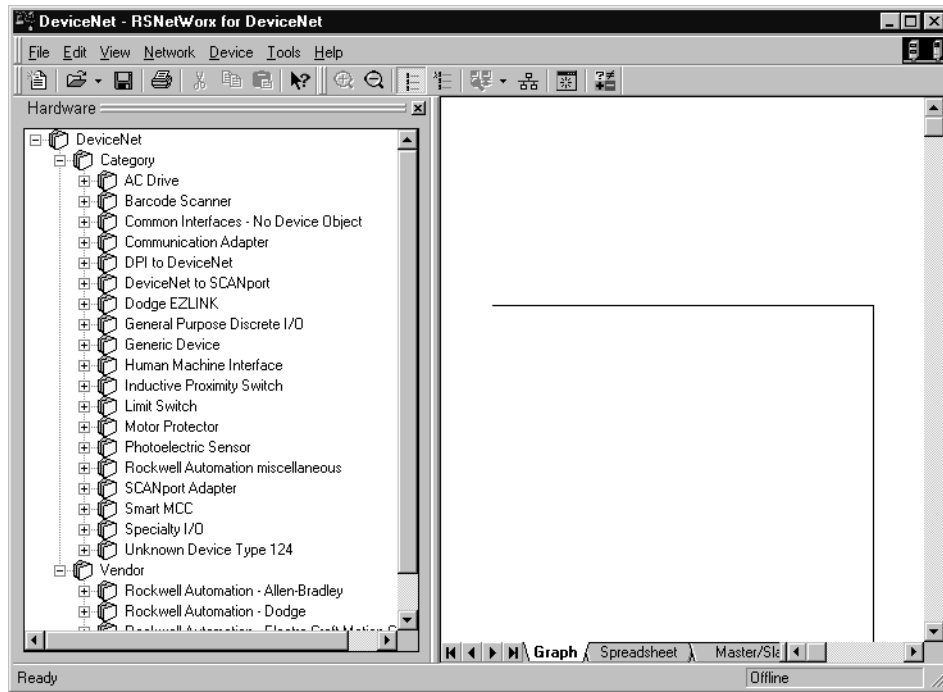

In the left column under Category, click the '+' sign next to Communication Adapters. The list of products under Communication Adapters contains the 1769-ADN/A adapter. Should this adapter not appear under Communication Adapters, your RSNetWorx for DeviceNet software is not version 3.00 or later. To continue, you will need to obtain an upgrade for your software.

If the 1769-ADN/A adapter does appear, double-click it and it will be placed on the network to the right as shown below.

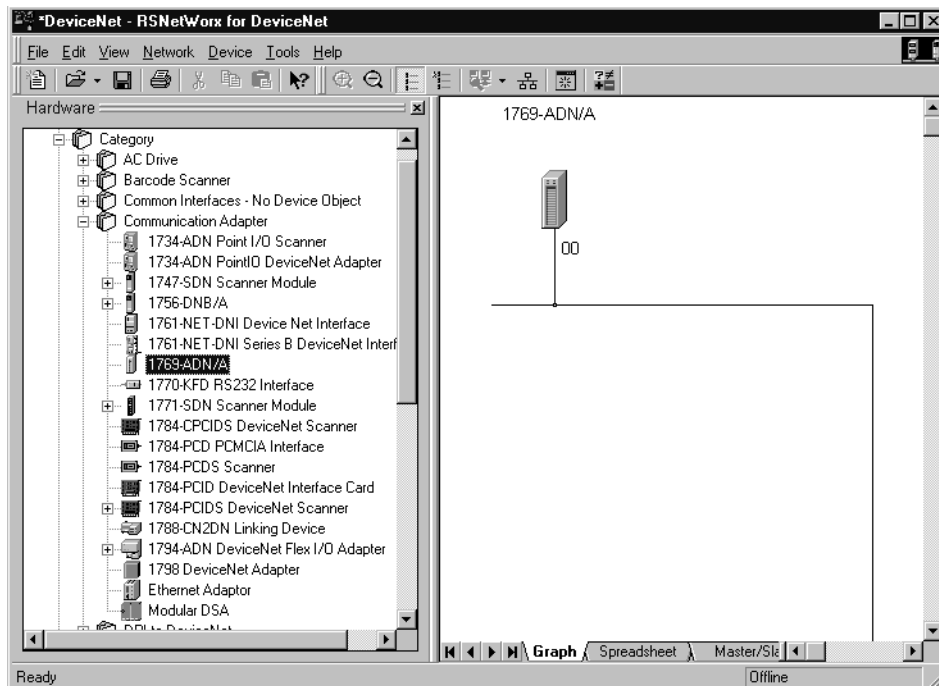

To configure I/O for the adapter, double-click the adapter that you just placed on the network, and this dialog box appears.

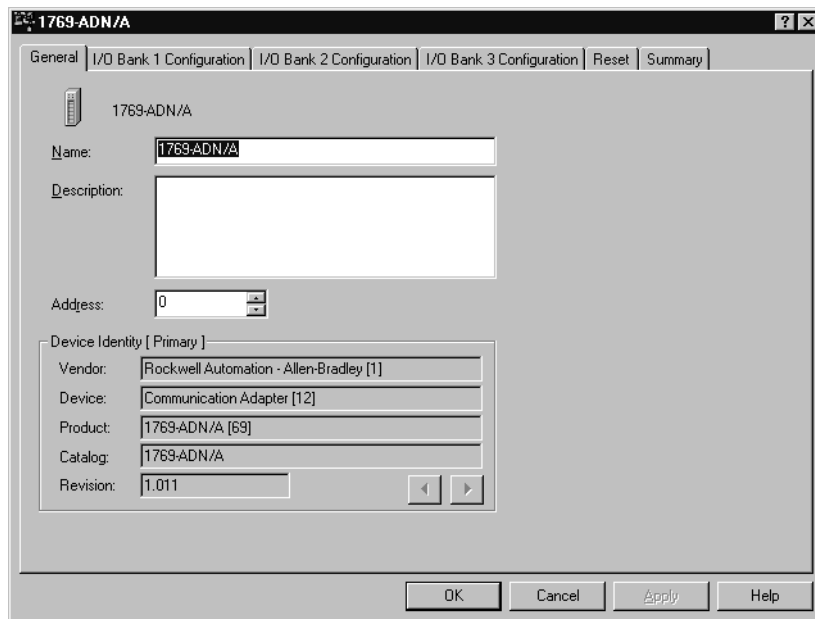

At this point, you may modify the adapters DeviceNet node address, if desired.

Next, click the I/O Bank 1 Configuration tab. This dialog box appears.

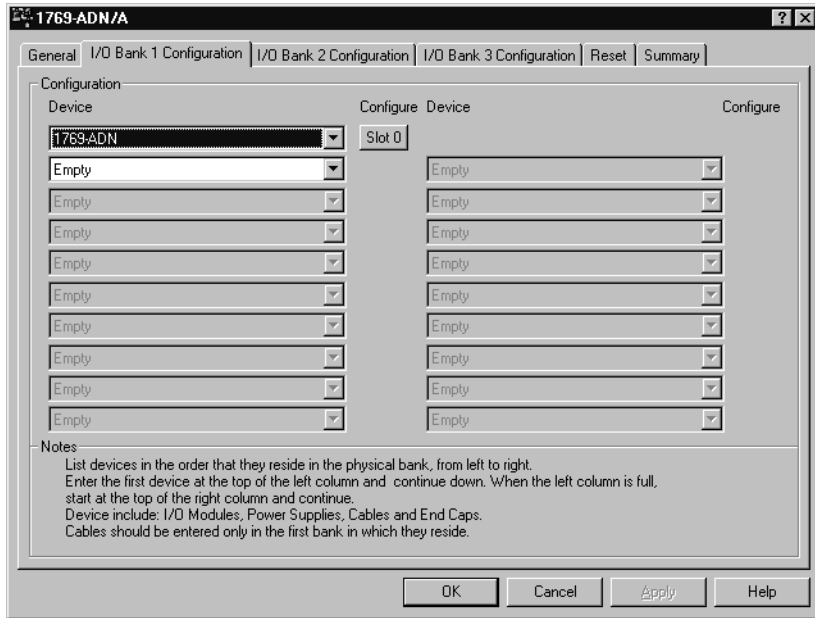

Configuring the 1769-IT6 Module

The 1769-ADN adapter appears in slot 0. Your I/O modules, power supplies, end cap, and interconnect cables must be entered in the proper order, following the 1769 I/O rules contained in the 1769-ADN user's manual. For simplicity sake, we placed the 1769-IT6 module in slot 1 to show how it is configured. As a minimum, a power supply and end cap must also be placed after the 1769-IT6 module, even though they do not have a slot number associated with them. To place the 1769-IT6 module into Bank 1, click the arrow next to the first empty slot after the 1769-ADN adapter. A list of all possible 1769 products appears. Choose the 1769-IT6 module.

Slot 1 appears to the right of the 1769-IT6 module. Click this Slot 1 box and this 1769-IT6 configuration dialog box appears.

The screenshot shows the '1769-IT6 - 6 Channel Thermocouple/mV Input' dialog box. It has a title bar with a question mark and a close button. The 'Module Slot Position' is set to 1. Under 'I/O Data Size', 'Input Size' is 8 words and 'Output Size' is 0 words. The 'Keying' section shows 'Revision' as 1 and 'Electronic Keying' as 'Exact Match'. The 'Configuration' section has a checkbox for 'Disable Cyclic Calibration' which is unchecked. Below this is a table with 6 channels, each with an 'Enable' checkbox, 'Data Format', 'Input Type', 'Temp Units', and 'Open Circ' dropdown menu.

Channel	Enable	Data Format	Input Type	Temp Units	Open Circ
0	<input type="checkbox"/>	Raw/Proportional	J	Degress F	Upscale
1	<input type="checkbox"/>	Raw/Proportional	J	Degress F	Upscale
2	<input type="checkbox"/>	Raw/Proportional	J	Degress F	Upscale
3	<input type="checkbox"/>	Raw/Proportional	J	Degress F	Upscale
4	<input type="checkbox"/>	Raw/Proportional	J	Degress F	Upscale
5	<input type="checkbox"/>	Raw/Proportional	J	Degress F	Upscale

By default, the 1769-IT6 module contains eight input words and no output words. Click Data Description. This shows what the eight input words represent, that is, the first six words are the actual thermocouple input data, while the following two words contain status, open-circuit bits and over- and under-range bits for the six channels. Click OK or Cancel to exit this dialog box and return to the Configuration dialog box.

If your application requires only the six data words and not the status information, click 'Set for I/O only' and the Input Size will change to six words. You may leave the Electronic Keying to 'Exact Match.' It is not recommended to Disable Keying, but if you are not sure of the exact revision of your module, selecting Compatible Module will allow your system to operate and the system will still require a 1769-IT6 module in slot 1.

Each of the six thermocouple input channels are disabled by default. To enable a channel, click its Enable box so a checkmark appears in it. Then, choose your Data Format, Input Type, Temperature Units, Open-Circuit Condition, and Filter Frequency for each channel you are using. See [Channel Configuration on page 42](#) for a complete description of each of these configuration categories.

In this example, channels 0...5 are being used. All six channels have J-type thermocouples connected. A 60 Hz filter frequency (the default) is used for all six channels, along with receiving the thermocouple input data in Engineering Units x 10. We also chose °F for the Temperature Units. This selection, coupled with choosing Engineering Units x 10 for the data format allows us to receive the data into the controllers tag database as actual temperature data in °F. The Open-circuit Detection is Upscale.

This means that if an open-circuit condition should occur at any of the six thermocouple input channels, the input value for that channel is the full-scale value selected by the input type and data format. We can therefore monitor each channel for full scale (open-circuit) as well as monitor the Open-Circuit bits in input word 6, for each channel. When complete, the configuration dialog box looks like this.

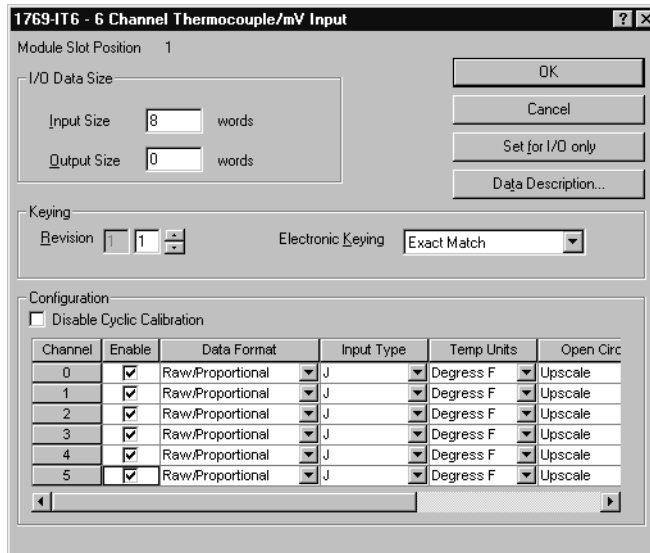

Click OK and your configuration for the 1769-IT6 thermocouple input module is complete.

Refer to your Compact I/O 1769-ADN DeviceNet Adapter User Manual, publication [1769-UM001](#), for information concerning DeviceNet network configuration and operation.

The following terms and abbreviations are used throughout this manual. For definitions of terms not listed here, refer to the Allen-Bradley Industrial Automation Glossary, publication [AG-7.1](#).

- A/D converter** Refers to the analog to digital converter inherent to the module. The converter produces a digital value whose magnitude is proportional to the magnitude of an analog input signal.
- attenuation** The reduction in the magnitude of a signal as it passes through a system.
- bus connector** A 16-pin male and female connector that provides electrical interconnection between the modules.
- channel** Refers to input interfaces available on the module's terminal block. Each channel is configured for connection to a thermocouple or millivolt input device, and has its own data and diagnostic status words.
- channel update time** The time required for the module to sample and convert the input signals of one enabled input channel and update the channel data word.
- CJC** Cold junction compensation. CJC is the means by which the module compensates for the offset voltage error introduced by the temperature at the junction between a thermocouple lead wire and the module terminal block (the cold junction).
- common mode rejection** For analog inputs, the maximum level to which a common mode input voltage appears in the numerical value read by the processor, expressed in dB.
- common mode rejection ration (CMRR)** The ratio of a device's differential voltage gain to common mode voltage gain. Expressed in dB, CMRR is a comparative measure of a device's ability to reject interference caused by a voltage common to its input terminals relative to ground. $CMRR=20 \text{ Log}_{10} (V_1/V_2)$
- common mode voltage** The voltage difference between the negative terminal and analog common during normal differential operation.
- common mode voltage range** The largest voltage difference allowed between either the positive or negative terminal and analog common during normal differential operation.
- configuration word** Word containing the channel configuration information needed by the module to configure and operate each channel.
- cut-off frequency** The frequency at which the input signal is attenuated 3 dB by a digital filter. Frequency components of the input signal that are below the cut-off frequency are passed with under 3 dB of attenuation for low-pass filters.
- data word** A 16-bit integer that represents the value of the input channel. The channel data word is valid only when the channel is enabled and there are no channel errors. When the channel is disabled the channel data word is cleared (0).

- dB** (decibel) A logarithmic measure of the ratio of two signal levels.
- digital filter** A low-pass filter incorporated into the A/D converter. The digital filter provides very steep roll-off above its cut-off frequency, which provides high frequency noise rejection.
- effective resolution** The number of bits in a channel configuration word that do not vary due to noise.
- filter** A device that passes a signal or range of signals and eliminates all others.
- filter frequency** The user-selectable frequency for a digital filter.
- full-scale** The magnitude of input over which normal operation is permitted.
- full-scale range** The difference between the maximum and minimum specified analog input values for a device.
- gain drift** Change in full-scale transition voltage measured over the operating temperature range of the module.
- input data scaling** Data scaling that depends on the data format selected for a channel configuration word. Scaling is selected to fit the temperature or voltage resolution for your application.
- input image** The input from the module to the controller. The input image contains the module data words and status bits.
- linearity error** Any deviation of the converted input or actual output from a straight line of values representing the ideal analog input. An analog input is composed of a series of input values corresponding to digital codes. For an ideal analog input, the values lie in a straight line spaced by inputs corresponding to 1 LSB. Linearity is expressed in percent full-scale input. See the variation from the straight line due to linearity error (exaggerated) in the example below.

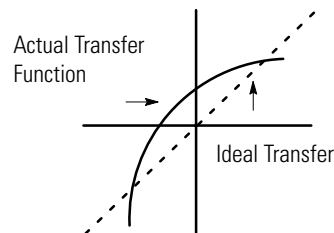

- LSB** (least significant bit) The LSB represents the smallest value within a string of bits. For analog modules, 16-bit, two's complement binary codes are used in the I/O image. For analog inputs, the LSB is defined as the rightmost bit of the 16-bit field (bit 0). The weight of the LSB value is defined as the full-scale range divided by the resolution.
- module scan time** Same as 'module update time'.

- module update time** The time required for the module to sample and convert the input signals of all enabled input channels and make the resulting data values available to the processor.
- multiplexer** An switching system that allows several signals to share a common A/D converter.
- normal mode rejection** (differential mode rejection) A logarithmic measure, in dB, of a device's ability to reject noise signals between or among circuit signal conductors. The measurement does not apply to noise signals between the equipment grounding conductor or signal reference structure and the signal conductors.
- number of significant bits** The power of two that represents the total number of completely different digital codes to which an analog signal can be converted or from which it can be generated.
- overall accuracy** The worst-case deviation of the digital representation of the input signal from the ideal over the full input range is the overall accuracy. Overall accuracy is expressed in percent of full scale.
- repeatability** The closeness of agreement among repeated measurements of the same variable under the same conditions.
- resolution** The increment of change represented by one unit. For example, the resolution of engineering units x1 is 0.1° and the resolution of raw/proportional data is equal to $(\text{maximum_value} - \text{minimum_value})/65534$.
- sampling time** The time required by the A/D converter to sample an input channel.
- status word** Contains status information about the channel's current configuration and operational state. You can use this information in your ladder program to determine whether the channel data word is valid.
- step response time** The time required for the channel data word signal to reach a specified percentage of its expected final value, given a full-scale step change in the input signal.
- thermocouple** A temperature sensing device consisting of a pair of dissimilar conductors welded or fused together at one end to form a measuring junction. The free ends are available for connection to the reference (cold) junction. A temperature difference between the junctions must exist for the device to function.
- update time** See 'module update time'.

Notes:

Numerics

-3 dB frequency 48

A

A/D

definition 157

abbreviations 157

accuracy 86

analog input module

overview 11, 75

attenuation

cut-off frequency 48

definition 157

autocalibration

module update time 70

B

before you begin 17

bus connector

definition 157

locking 27

bus interface 14

C

calibration 16

channel

definition 157

channel configuration 40

channel configuration word 42

channel diagnostics 77

channel status indicator 14

channel step response

effects of filter frequency 47

channel update time

definition 157

CJC

definition 157

CJC sensors

error indication 39

general status bits 39

location 13

module operation 15

open-circuit condition 46

over-range flag 40

terminal connections 20

under-range flag 40

wiring 35

CMRR. See common mode rejection ratio

common mode rejection 47

definition 157

common mode rejection ratio

definition 157

common mode voltage

definition 157

common mode voltage range

definition 157

common mode voltage rating 47

configuration errors 79

configuration word

definition 157

contacting Rockwell Automation 82

cut-off frequency 48

definition 157

D

data not valid condition 39

data word

definition 157

dB

definition 158

decibel. See dB.

definition of terms 157

differential mode rejection. See normal mode rejection.

digital filter

definition 158

DIN rail mounting 29

E

effective resolution

at available filter frequencies ??-69

definition 158

electrical noise 25

EMC Directive 23

end cap terminator 19, 27

equipment required for installation 17

error codes 80

error definitions 78

errors

configuration 79

critical 78

extended error information field 79

hardware 79

module error field 78

non-critical 78

European Union Directives 23

extended error codes 80

extended error information field 79

F

fault condition

at powerup 14

filter

definition 158

filter frequency
definition 158
effect on effective resolution 50
effect on noise rejection 46
effect on step response 47
selecting 46

finger-safe terminal block 33

full-scale
definition 158

full-scale range
definition 158

G

gain drift
definition 158

general status bits 39

grounding 20, 31

H

hardware errors 79

heat considerations 25

I

input data formats
engineering units x 1 44
engineering units x 10 44
percent range 45
raw/proportional data 44
scaled for PID 45

input data scaling
definition 158

input filter selection 46

input image
definition 158

input module
channel configuration 42
enable channel 43

input module status
general status bits 39
over-range flag bits 40
under-range flag bits 40

input type/range selection 45

installation
getting started 17
grounding 20, 31
heat and noise considerations 25

International Temperature Scale 1990 113

ITS-90 113

L

linearity error
definition 158

LSB
definition 158

M

millivolt inputs
range 11

module error field 78

module inhibit function 82

module scan time
definition 158

module status
data not valid 39

module update time 69
definition 159

mounting 28-29

multiplexer
definition 159

N

negative decimal values 112

noise rejection 46

normal mode rejection
definition 159

number of significant bits
definition 159

O

open-circuit
detection 77
error bits 39

operation
system 14

out-of range detection 77

overall accuracy
definition 159

over-range flag bits 40

P

panel mounting 28-29

positive decimal values 111

power-up diagnostics 76

power-up sequence 14

program alteration 76

R

removing terminal block 32

replacing a module 30

resolution
definition 159

S

safety circuits 76

sampling time
definition 159

scan time 158
spacing 28
specifications 83
start-up instructions 17
status indicator 75
status word
 definition 159
step response time
 definition 159
system operation 14

T

terminal block
 removing 32
 wiring 33
terminal door label 32
terminal screw torque 33
thermocouple
 accuracy 86
 definition 159
 descriptions 113
 exposed junction 137
 grounded junction 135
 junction types 135
 repeatability 85
 ungrounded junction 137
 using junctions 135
tools required for installation 17
troubleshooting
 safety considerations 75
two's complement binary numbers 111
type B
 description 113
 temperature range 11
type C
 temperature range 11

type E
 description 115
 temperature range 11
type J
 description 117
 temperature range 11
type K
 description 119
 temperature range 11
type N
 description 121
 temperature range 11
type R
 description 123
 temperature range 11
type S
 description 124
 temperature range 11
type T
 description 126
 temperature range 11

U

under-range flag bits 40
update time 69
update time. See channel update time.
update time. See module update time.

W

wire size 33
wiring 23
 module 33
 modules 34
 routing considerations 25
 terminal block 33

Notes:

Notes:

Notes:

Rockwell Automation Support

Rockwell Automation provides technical information on the Web to assist you in using its products. At <http://www.rockwellautomation.com/support/>, you can find technical manuals, a knowledge base of FAQs, technical and application notes, sample code and links to software service packs, and a MySupport feature that you can customize to make the best use of these tools.

For an additional level of technical phone support for installation, configuration, and troubleshooting, we offer TechConnect support programs. For more information, contact your local distributor or Rockwell Automation representative, or visit <http://www.rockwellautomation.com/support/>.

Installation Assistance

If you experience an anomaly within the first 24 hours of installation, review the information that is contained in this manual. You can contact Customer Support for initial help in getting your product up and running.

United States or Canada	1.440.646.3434
Outside United States or Canada	Use the Worldwide Locator at http://www.rockwellautomation.com/support/americas/phone_en.html , or contact your local Rockwell Automation representative.

New Product Satisfaction Return

Rockwell Automation tests all of its products to ensure that they are fully operational when shipped from the manufacturing facility. However, if your product is not functioning and needs to be returned, follow these procedures.

United States	Contact your distributor. You must provide a Customer Support case number (call the phone number above to obtain one) to your distributor to complete the return process.
Outside United States	Please contact your local Rockwell Automation representative for the return procedure.

Documentation Feedback

Your comments will help us serve your documentation needs better. If you have any suggestions on how to improve this document, complete this form, publication [RA-DU002](#), available at <http://www.rockwellautomation.com/literature/>.

www.rockwellautomation.com

Power, Control and Information Solutions Headquarters

Americas: Rockwell Automation, 1201 South Second Street, Milwaukee, WI 53204 USA, Tel: (1) 414.382.2000, Fax: (1) 414.382.4444

Europe/Middle East/Africa: Rockwell Automation, Vorstlaan/Boulevard du Souverain 36, 1170 Brussels, Belgium, Tel: (32) 2 663 0600, Fax: (32) 2 663 0640

Asia Pacific: Rockwell Automation, Level 14, Core F, Cyberport 3, 100 Cyberport Road, Hong Kong, Tel: (852) 2887 4788, Fax: (852) 2508 1846

Publication 1769-UM004B-EN-P - March 2010

Supersedes Publication 1769-UM004A-EN-P - February 2001

Copyright © 2010 Rockwell Automation, Inc. All rights reserved. Printed in the U.S.A.