

CompactLogix EtherNet/IP Web Server Module

Catalog Number 1768-EWEB

Topic	Page
Important User Information	2
Minimum Spacing	7
What You Need	8
Install the Modules	8
Wire the Module	14
Connect the Module	15
Configure the Module	16
Confirm Your Installation	16
Remove the EtherNet/IP Web Server Module	17
Troubleshoot the Module	18
Status Indicators	19
Specifications	20
Additional Resources	23

Important User Information

Solid-state equipment has operational characteristics differing from those of electromechanical equipment. Safety Guidelines for the Application, Installation and Maintenance of Solid State Controls (Publication [SGI-1.1](#) available from your local Rockwell Automation sales office or online at <http://www.rockwellautomation.com/literature/>) describes some important differences between solid-state equipment and hard-wired electromechanical devices. Because of this difference, and also because of the wide variety of uses for solid-state equipment, all persons responsible for applying this equipment must satisfy themselves that each intended application of this equipment is acceptable.





In no event will Rockwell Automation, Inc. be responsible or liable for indirect or consequential damages resulting from the use or application of this equipment.

The examples and diagrams in this manual are included solely for illustrative purposes. Because of the many variables and requirements associated with any particular installation, Rockwell Automation, Inc. cannot assume responsibility or liability for actual use based on the examples and diagrams.



No patent liability is assumed by Rockwell Automation, Inc. with respect to use of information, circuits, equipment, or software described in this manual.

Reproduction of the contents of this manual, in whole or in part, without written permission of Rockwell Automation, Inc., is prohibited.

Throughout this manual, when necessary, we use notes to make you aware of safety considerations.

	WARNING: Identifies information about practices or circumstances that can cause an explosion in a hazardous environment, which may lead to personal injury or death, property damage, or economic loss.
	ATTENTION: Identifies information about practices or circumstances that can lead to personal injury or death, property damage, or economic loss. Attentions help you identify a hazard, avoid a hazard and recognize the consequences.
	SHOCK HAZARD: Labels may be on or inside the equipment, for example, drive or motor, to alert people that dangerous voltage may be present.
	BURN HAZARD: Labels may be on or inside the equipment, for example, drive or motor, to alert people that surfaces may reach dangerous temperatures.
IMPORTANT	Identifies information that is critical for successful application and understanding of the product.

North American Hazardous Location Approval

The following information applies when operating this equipment in hazardous locations.	Informations sur l'utilisation de cet équipement en environnements dangereux.
<p>Products marked "CL I, DIV 2, GP A, B, C, D" are suitable for use in Class I Division 2 Groups A, B, C, D, Hazardous Locations and nonhazardous locations only. Each product is supplied with markings on the rating nameplate indicating the hazardous location temperature code. When combining products within a system, the most adverse temperature code (lowest "T" number) may be used to help determine the overall temperature code of the system. Combinations of equipment in your system are subject to investigation by the local Authority Having Jurisdiction at the time of installation.</p>	<p>Les produits marqués "CL I, DIV 2, GP A, B, C, D" ne conviennent qu'à une utilisation en environnements de Classe I Division 2 Groupes A, B, C, D dangereux et non dangereux. Chaque produit est livré avec des marquages sur sa plaque d'identification qui indiquent le code de température pour les environnements dangereux. Lorsque plusieurs produits sont combinés dans un système, le code de température le plus défavorable (code de température le plus faible) peut être utilisé pour déterminer le code de température global du système. Les combinaisons d'équipements dans le système sont sujettes à inspection par les autorités locales qualifiées au moment de l'installation.</p>
<div style="display: flex; align-items: center;">  <div> <p>WARNING: Explosion Hazard -</p> <ul style="list-style-type: none"> • Do not disconnect equipment unless power has been removed or the area is known to be nonhazardous. • Do not disconnect connections to this equipment unless power has been removed or the area is known to be nonhazardous. Secure any external connections that mate to this equipment by using screws, sliding latches, threaded connectors, or other means provided with this product. • Substitution of components may impair suitability for Class I, Division 2. • If this product contains batteries, they must only be changed in an area known to be nonhazardous. </div> </div>	<div style="display: flex; align-items: center;">  <div> <p>AVERTISSEMENT: Risque d'Explosion -</p> <ul style="list-style-type: none"> • Couper le courant ou s'assurer que l'environnement est classé non dangereux avant de débrancher l'équipement. • Couper le courant ou s'assurer que l'environnement est classé non dangereux avant de débrancher les connecteurs. Fixer tous les connecteurs externes reliés à cet équipement à l'aide de vis, loquets coulissants, connecteurs filetés ou autres moyens fournis avec ce produit. • La substitution de composants peut rendre cet équipement inadapté à une utilisation en environnement de Classe I, Division 2. • S'assurer que l'environnement est classé non dangereux avant de changer les piles. </div> </div>

European Hazardous Location Approval

This equipment is intended for use in potentially explosive atmospheres as defined by European Union Directive 94/9/EC.

Intertek certifies that this equipment has been found to comply with the Essential Health and Safety Requirements relating to the design and construction of Category 3 equipment intended for use in Zone 2 potentially explosive atmospheres, given in Annex II to this Directive. The examination and test results are recorded in confidential report No.100014190DAL-001.

Compliance with the Essential Health and Safety Requirements has been assured by compliance with EN 60079-15.



WARNING: This equipment must be installed in an enclosure providing at least IP54 protection when applied in Zone 2 environments.

Provision shall be made to prevent the rated voltage from being exceeded by transient disturbances of more than 40% when applied in Zone 2 environments.

Environment and Enclosure



ATTENTION: This equipment is intended for use in a Pollution Degree 2 industrial environment, in overvoltage Category II applications (as defined in IEC 60664-1), at altitudes up to 2000 m (6562 ft) without derating.

This equipment is considered Group 1, Class A industrial equipment according to IEC/CISPR 11. Without appropriate precautions, there may be difficulties with electromagnetic compatibility in residential and other environments due to conducted and radiated disturbances.

This equipment is supplied as open-type equipment. It must be mounted within an enclosure that is suitably designed for those specific environmental conditions that will be present and appropriately designed to prevent personal injury resulting from accessibility to live parts. The enclosure must have suitable flame-retardant properties to prevent or minimize the spread of flame, complying with a flame spread rating of 5VA, V2, V1, V0 (or equivalent) if non-metallic. The interior of the enclosure must be accessible only by the use of a tool. Subsequent sections of this publication may contain additional information regarding specific enclosure type ratings that are required to comply with certain product safety certifications.

In addition to this publication, see:

- Industrial Automation Wiring and Grounding Guidelines, Rockwell Automation publication [1770-4.1](#), for additional installation requirements.
 - NEMA Standard 250 and IEC 60529, as applicable, for explanations of the degrees of protection provided by different types of enclosure.
-

Prevent Electrostatic Discharge



ATTENTION: This equipment is sensitive to electrostatic discharge, which can cause internal damage and affect normal operation. Follow these guidelines when you handle this equipment:

- Touch a grounded object to discharge potential static.
 - Wear an approved grounding wriststrap.
 - Do not touch connectors or pins on component boards.
 - Do not touch circuit components inside the equipment.
 - If available, use a static-safe workstation.
 - When not in use, store the equipment in appropriate static-safe packaging.
-

Minimum Spacing

Plan for this minimum spacing from enclosure walls, wireways, and other equipment.

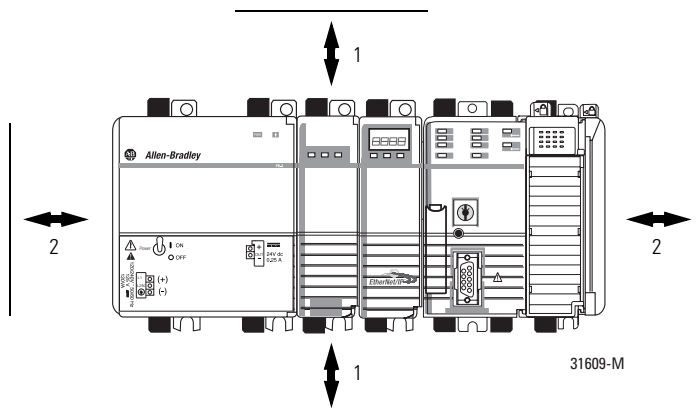

Item	Description
1	105 mm (4 in.)
2	90 mm (3.54 in.)

See [Specifications](#) on page [20](#) for the temperature range.

What You Need

Item	Cat. No. or Size	
1768 CompactLogix power supply	1768-PA3	
1768 CompactLogix controller	1768-L43	
1769 end cap Connects to the controller as the last module, either: <ul style="list-style-type: none"> • without any 1769-series modules attached to the controller (1768-series only) • with a combination of 1768-series and 1769-series modules attached to the controller 	1769-ECR	
RJ45 Ethernet connector	See Wire the Module on page 14	
DIN rail or mounting screws (one or the other but not both)	DIN rail	Either of these sizes: <ul style="list-style-type: none"> • 35 x 7.5 mm (EN 50 022 - 35 x 7.5) • 35 x 15 mm (EN 50 022 - 35 x 15)
	Screws	M4 or #8 panhead screws

Install the Modules



ATTENTION: This product is grounded through the DIN rail to chassis ground. Use zinc-plated yellow-chromate steel DIN rail to assure proper grounding. The use of other DIN rail materials (for example, aluminum or plastic) that can corrode, oxidize, or are poor conductors, can result in improper or intermittent grounding. Secure DIN rail to mounting surface approximately every 200 mm (7.87 in.) and use end-anchors appropriately.

If You Are Using Screws to Mount Your Modules

IMPORTANT Do not use screws and DIN rail to mount the modules. It is possible to break the mounting tabs off if you screw the modules to the panel while they are on DIN rail

The steps in these instructions show how to mount the modules on DIN rail. If you are using screws instead of DIN rail, make these changes to the instructions.

1. Follow the steps in [Mount the Controller on the DIN Rail](#) on page 10 to connect the modules together.
2. Use the modules as a template and mark pilot holes on your panel.
3. Drill the pilot holes for M4 or #8 screws.
4. Use M4 or #8 screws to mount the modules to your panel. Use 1.16 N•m (10 lb•in) of torque.
5. Ground the module on a ground bus with a dedicated earth ground stake.
6. Connect the ground bus to a functional earth ground on the DIN rail or panel.
7. Refer to Industrial Automation Wiring and Grounding Guidelines, publication [1770-4.1](#), for additional information.

Install the DIN Rail

Mount the DIN rail in a suitable location.



ATTENTION: This product is grounded through the DIN rail to chassis ground. Use zinc plated yellow-chromate steel DIN rail to assure proper grounding. The use of other DIN rail materials (for example, aluminum or plastic) that can corrode, oxidize, or are poor conductors, can result in improper or intermittent grounding. Secure DIN rail to mounting surface approximately every 200 mm (7.8 in.) and use end-anchors appropriately.

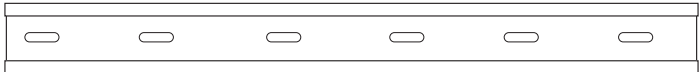

Mount the Controller on the DIN Rail

1. Close the DIN rail latches on the controller.

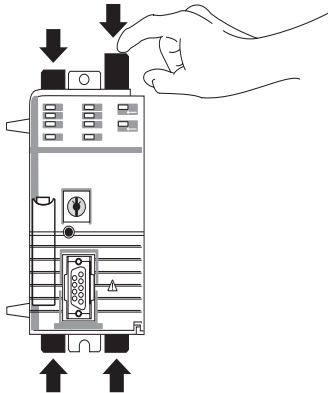

2. Align and press the controller onto the DIN rail until the latches snap closed.

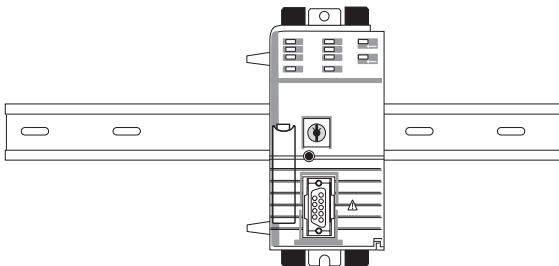

Mount the EtherNet/IP Web Server Module on the DIN Rail

1. Open the DIN rail latches on the module.

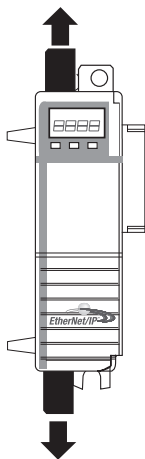

2. Align and press the module onto the DIN rail to the left of the controller.

3. Slide module snugly against the controller.

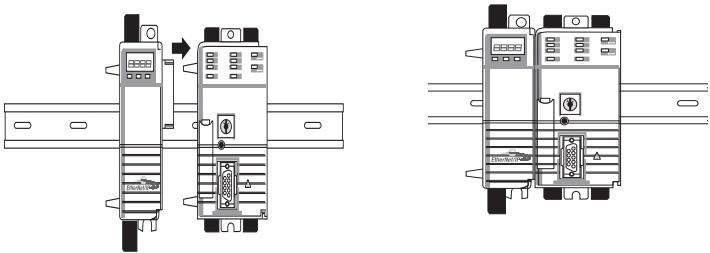

Mount the Power Supply on the DIN Rail

1. Close the DIN rail latches on the power supply.
2. Align and press the power supply onto the DIN rail until the latches snap closed.
3. Slide the power supply snugly against the module.

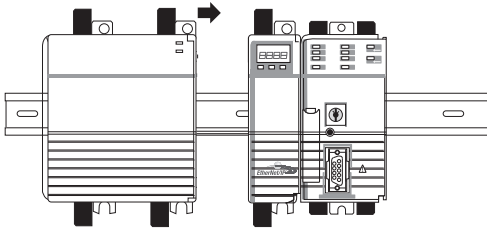

Mount the I/O Modules on the DIN Rail

1. Close the DIN rail latches on the module.
2. Align the tongue-and-groove slots of the module with the tongue-and-groove slots of the controller and slide the module back towards the DIN rail.

When the module is in place, the DIN rail latches snap closed.

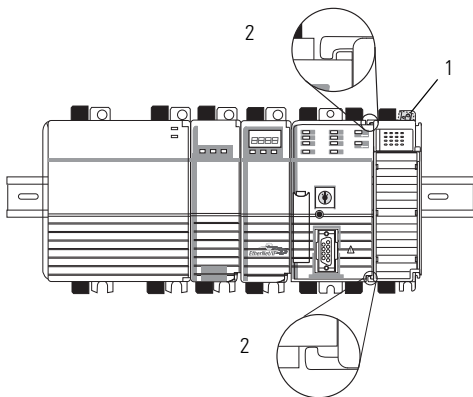

Item	Description
1	Locking tab
2	Tongue-and-groove slot

3. Slide the locking tab of the module to the left to lock the module in place.
4. Align the tongue-and-groove slots of the end-cap with the tongue-and-groove slots of the module.
5. Slide the end-cap back towards the DIN rail.

14 CompactLogix EtherNet/IP Web Server Module

6. Move the lock latch to the left to lock the endcap on the module.

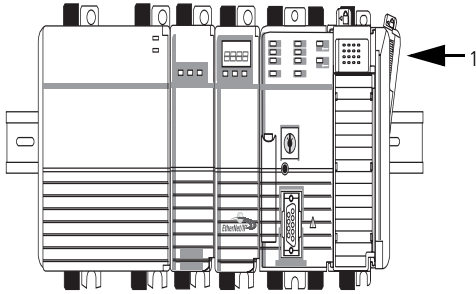

Item	Description
1	Lock latch

Wire the Module

Use an RJ45 connector to connect to the EtherNet/IP network.

8 ---- NC
7 ---- NC
6 ---- RD-
5 ---- NC
4 ---- NC
3 ---- RD+
2 ---- TD-
1 ---- TD+

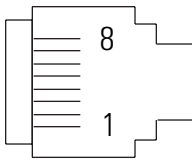

Connect the Module



WARNING: If you connect or disconnect the cable with power applied to this module or any device on the network, an electrical arc can occur. This could cause an explosion in hazardous location installations. Be sure that power is removed or the area is nonhazardous before proceeding.

IMPORTANT

We recommend connecting the module to the network via a 100 MB Ethernet switch, which will reduce collisions and lost packets and increase network bandwidth. For detailed EtherNet/IP connection information, see the EtherNet/IP Modules in Logix5000 Control Systems User Manual, publication [ENET-UM001](#).

Attach the RJ45 connector to the Ethernet port on the bottom of the module.

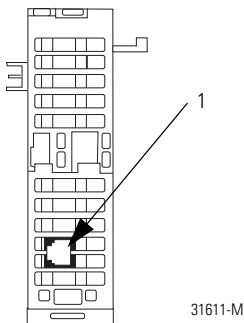

Item	Description
1	Ethernet port

Configure the Module

To configure your module, refer to the configuration chapter of the Web Server Modules User Manual, publication [ENET-UM527](#).

Confirm Your Installation

Verify the following status indicators' states.

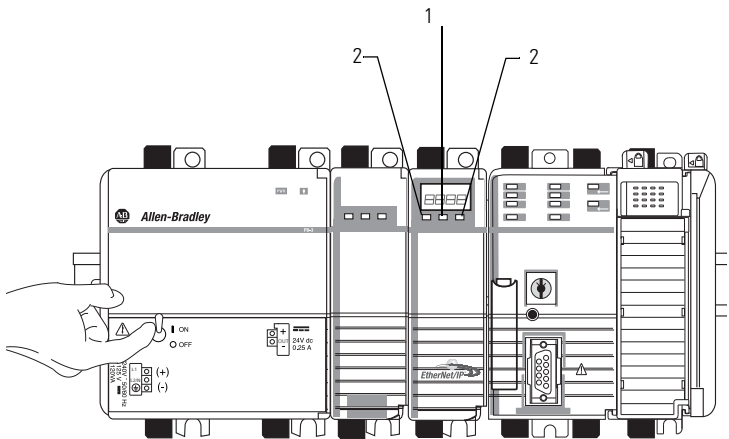

31608-M

Item	Description
1	Solid or flashing green
2	Solid green

See [Troubleshoot the Module](#) on page 18 if the status indicators are in other states.

Remove the EtherNet/IP Web Server Module

IMPORTANT When you turn the CompactLogix power supply off, make sure you wait for all status indicators on the power supply and controller to turn off before disconnecting any part from the system.

If you disconnect the CompactLogix system while the controller is still writing its program to memory, the program write will not be completed and you will lose your program.

1. Turn off power.
2. Open the DIN rail latches of the EtherNet/IP Web Server Module and the module directly left of the EtherNet/IP Web Server module.
3. Slide the EtherNet/IP module to the right with other modules.
4. Slide the controller away from the EtherNet/IP module.
5. Pull the EtherNet/IP module forward off the DIN rail.

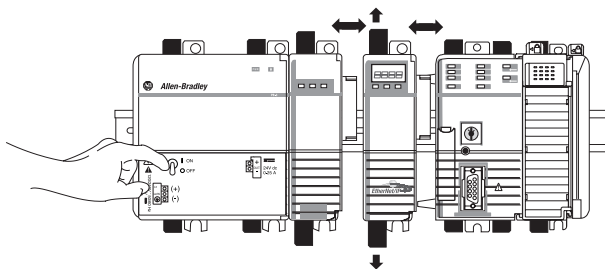

Troubleshoot the Module

The three bi-color (red/green) status indicators on the module provide diagnostic information about the module and its connections to the network. If the alphanumeric display and status indicators do not sequence through the expected states, refer to the troubleshooting tables.

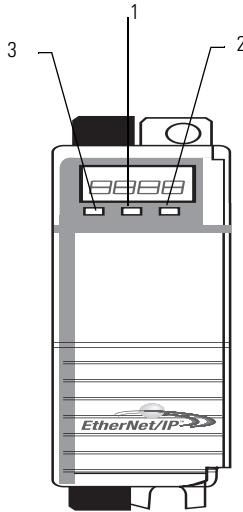

Item	Description
1	Link status indicator
2	OK status indicator
3	Network status indicator

Status Indicators

The module status indicators provides the following information:

Indicator	Status	Description
NET	Off	Module is not powered, or does not have an IP address. <ul style="list-style-type: none"> • Verify there is chassis power and the module is completely inserted into the chassis and backplane. • Make sure the module has been configured.
	Flashing Green	Module has obtained an IP address, but has no established connections.
	Green	Module has an IP address and at least one established connection.
	Flashing Red	One or more of the connections in which the module is the target has timed out.
	Red	Module has detected that its IP address is already in use. Assign a unique IP address to the module.
Link	Off	No data transmission. Module is not ready to communicate.
	Green	Module is ready to communicate.
	Flashing Green	Data transmission in progress. Module is communicating over the network.
OK	Off	Module does not have 5V DC power. Verify there is power and the module is properly installed.
	Flashing Green	Standby mode. Module is not configured.
	Green	Module is operating correctly.
	Flashing Red	A minor, recoverable fault has been detected. This could be caused by an error in the configuration.
	Red	A major, unrecoverable fault has been detected. Recycle power to the module. If this does not clear the fault, replace the module.
	Flashing Red and Green	Module performing power-up self-test.

Specifications

Technical Specifications - 1768-EWEB

Attribute	1768-EWEB
Backplane current	834 mA at 5.2V DC
Power consumption	4.34 W
Power dissipation	4.38 W
Isolation (continuous-voltage rating)	30V, Functional Insulation Type, Ethernet network to system Type tested at 710V DC for 60 s
Wire Size	Ethernet network connections: RJ45 connector according to IEC 60603-7, 2 or 4 pair Category 5e minimum cable according to TIA 568-B.1 or Category 5 cable according to ISO/IEC 24702
Wiring category ⁽¹⁾	2 - on communication ports
North American temp code	T4A
IEC temp code	T4
Mounting screw torque	1.16 N•m (10 lb•in), using M4 or #8 screws
Dimensions (HxWxD), approx.	132 x 56.7 x 105.1 mm (5.20 x 2.23 x 4.12 in.)
Weight, approx.	0.213 kg (7.5 oz)

- (1) Use this Conductor Category information for planning conductor routing. Refer to Industrial Automation Wiring and Grounding Guidelines, publication [1770-4.1](#).

Environmental Specifications - 1768-EWEB

Attribute	1768-EWEB
Temperature, operating <ul style="list-style-type: none"> • IEC 60068-2-1 (Test Ad, Operating Cold) • IEC 60068-2-2 (Test Bd, Operating Dry Heat) • IEC 60068-2-14 (Test Nb, Operating Thermal Shock) 	0...60 °C (32...140 °F)
Temperature, nonoperating <ul style="list-style-type: none"> • IEC 60068-2-1 (Test Ab, Unpackaged Nonoperating Cold) • IEC 60068-2-2 (Test Bb, Unpackaged Nonoperating Dry Heat) • IEC 60068-2-14 (Test Na, Unpackaged Nonoperating Thermal Shock) 	-40...85 °C (-40...185 °F)
Relative humidity <ul style="list-style-type: none"> • IEC 60068-2-30 (Test Db, Unpackaged Damp Heat) 	5...95% noncondensing
Vibration <ul style="list-style-type: none"> • IEC 60068-2-6 (Test Fc, Operating) 	5 g @ 10...500 Hz
Operating shock <ul style="list-style-type: none"> • IEC 60068-2-27 (Test Ea, Unpackaged Shock) 	30 g
Nonoperating shock <ul style="list-style-type: none"> • IEC 60068-2-27 (Test Ea, Unpackaged Shock) 	50 g
Emissions <ul style="list-style-type: none"> • CISPR 11 	Group 1, Class A
ESD immunity <ul style="list-style-type: none"> • IEC 61000-4-2 	4 kV contact discharges 8 kV air discharges
Radiated RF immunity <ul style="list-style-type: none"> • IEC 61000-4-3 	10V/m with 1 kHz sine-wave 80%AM from 30...2000 MHz 10V/m with 200 Hz 50% Pulse 100%AM at 900 MHz 10V/m with 200 Hz 50% Pulse 100%AM at 1890 MHz 1V/m with 1 kHz sine-wave 80%AM from 2000...2700 MHz
EFT/B immunity <ul style="list-style-type: none"> • IEC 61000-4-4 	±2 kV at 5 kHz on communication ports

Environmental Specifications - 1768-EWEB

Attribute	1768-EWEB
Surge transient immunity • IEC 61000-4-5	±2 kV line-earth(CM) on communication ports
Conducted RF immunity • IEC 61000-4-6:	10V rms with 1 kHz sine-wave 80%AM from 150 kHz...80 MHz
Enclosure type rating	None (open-style)

Certifications

Certification (when product is marked) ⁽¹⁾	Value
c-UL-us	<ul style="list-style-type: none"> • UL Listed Industrial Control Equipment, certified for US and Canada. See UL File E65584. • UL Listed for Class I, Division 2 Group A,B,C,D Hazardous Locations, certified for U.S. and Canada. See UL File E194810.
CE	European Union 2004/108/EC EMC Directive, compliant with: <ul style="list-style-type: none"> • EN 61326-1; Meas./Control/Lab., Industrial Requirements • EN 61000-6-2; Industrial Immunity • EN 61000-6-4; Industrial Emissions • EN 61131-2; Programmable Controllers (Clause 8, Zone A & B)
C-Tick	Australian Radiocommunications Act, compliant with: <ul style="list-style-type: none"> • AS/NZS CISPR 11; Industrial Emissions
Ex	European Union 94/9/EC ATEX Directive, compliant with: <ul style="list-style-type: none"> • EN 60079-15; Potentially Explosive Atmospheres, Protection "n" • EN 60079-0; General Requirements II 3 G Ex nA IIC T4
EtherNet/IP	<ul style="list-style-type: none"> • ODVA conformance tested to EtherNet/IP specifications

(1) See the Product Certification link at www.ab.com for Declarations of Conformity, Certificates, and other certification details.

Additional Resources

These documents contain additional information concerning related Rockwell Automation products.

Resource	Description
EtherNet/IP Modules in Logix5000 Control Systems User Manual, publication ENET-UM001	Provides information about how to use EtherNet/IP modules with various Logix5000 controllers.
1768 CompactLogix Controller Installation Instructions, publication 1768-IN004	Provides information for installing a 1768 CompactLogix controller.
1769 CompactLogix Power Supplies Installation Instructions, publication 1768-IN001	Provides information about how to install CompactLogix power supplies.
Industrial Automation Wiring and Grounding Guidelines, publication 1770-4.1	Provides general guidelines for installing a Rockwell Automation industrial system.
Product Certifications website, http://ab.com	Provides declarations of conformity, certificates, and other certification details.

You can view or download publications at <http://www.rockwellautomation.com/literature/>. To order paper copies of technical documentation, contact your local Rockwell Automation distributor or sales representative.

Rockwell Automation Support

Rockwell Automation provides technical information on the Web to assist you in using its products. At <http://www.rockwellautomation.com/support/>, you can find technical manuals, a knowledge base of FAQs, technical and application notes, sample code and links to software service packs, and a MySupport feature that you can customize to make the best use of these tools.

For an additional level of technical phone support for installation, configuration, and troubleshooting, we offer TechConnect support programs. For more information, contact your local distributor or Rockwell Automation representative, or visit <http://www.rockwellautomation.com/support/>.

Installation Assistance

If you experience a problem within the first 24 hours of installation, please review the information that's contained in this manual. You can also contact a special Customer Support number for initial help in getting your product up and running.

United States or Canada	1.440.646.3434
Outside United States or Canada	Use the Worldwide Locator at http://www.rockwellautomation.com/support/americas/phone_en.html , or contact your local Rockwell Automation representative.

New Product Satisfaction Return

Rockwell Automation tests all of its products to ensure that they are fully operational when shipped from the manufacturing facility. However, if your product is not functioning and needs to be returned, follow these procedures.

United States	Contact your distributor. You must provide a Customer Support case number (call the phone number above to obtain one) to your distributor to complete the return process.
Outside United States	Please contact your local Rockwell Automation representative for the return procedure.

Documentation Feedback

Your comments will help us serve your documentation needs better. If you have any suggestions on how to improve this document, complete this form, publication [RA-DU002](#), available at <http://www.rockwellautomation.com/literature/>.

Allen-Bradley, Allen-Bradley, CompactLogix, RSLogix5000, Rockwell Software, Rockwell Automation, and TechConnect are trademarks of Rockwell Automation, Inc.

Trademarks not belonging to Rockwell Automation are property of their respective companies.

Rockwell Otomasyon Ticaret A.Ş., Kar Plaza İş Merkezi E Blok Kat:6 34752 İçerenköy, İstanbul, Tel: +90 (216) 5698400

www.rockwellautomation.com

Power, Control and Information Solutions Headquarters

Americas: Rockwell Automation, 1201 South Second Street, Milwaukee, WI 53204-2496 USA, Tel: (1) 414.382.2000, Fax: (1) 414.382.4444
Europe/Middle East/Africa: Rockwell Automation NV, Pegasus Park, De Kleerlaan 12a, 1831 Diegem, Belgium, Tel: (32) 2 663 0600, Fax: (32) 2 663 0640
Asia Pacific: Rockwell Automation, Level 14, Core F, Cyberport 3, 100 Cyberport Road, Hong Kong, Tel: (852) 2887 4788, Fax: (852) 2508 1846

Publication 1768-IN007B-EN-P - August 2010

PN-83489

Supersedes Publication 1768-IN007A-EN-P - September 2006 Copyright © 2010 Rockwell Automation, Inc. All rights reserved. Printed in the U.S.A.