

ControlLogix 5580 and GuardLogix 5580 Controllers

Catalog Numbers 1756-L81E, 1756-L81EK, 1756-L81ES, 1756-L81ESK, 1756-L82E, 1756-L82EK, 1756-L82ES, 1756-L82ESK, 1756-L83E, 1756-L83EK, 1756-L83ES, 1756-L83ESK, 1756-L84E, 1756-L84EK, 1756-L84ES, 1756-L84ESK, 1756-L85E, 1756-L85EK, 1756-L8SP, 1756-L8SPK

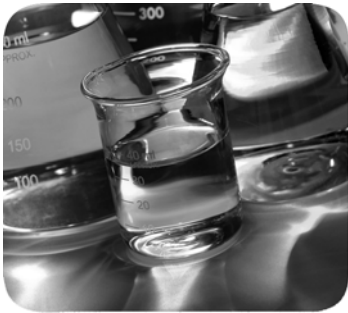

Important User Information

Read this document and the documents listed in the additional resources section about installation, configuration, and operation of this equipment before you install, configure, operate, or maintain this product. Users are required to familiarize themselves with installation and wiring instructions in addition to requirements of all applicable codes, laws, and standards.

Activities including installation, adjustments, putting into service, use, assembly, disassembly, and maintenance are required to be carried out by suitably trained personnel in accordance with applicable code of practice.

If this equipment is used in a manner not specified by the manufacturer, the protection provided by the equipment may be impaired.

In no event will Rockwell Automation, Inc. be responsible or liable for indirect or consequential damages resulting from the use or application of this equipment.

The examples and diagrams in this manual are included solely for illustrative purposes. Because of the many variables and requirements associated with any particular installation, Rockwell Automation, Inc. cannot assume responsibility or liability for actual use based on the examples and diagrams.

No patent liability is assumed by Rockwell Automation, Inc. with respect to use of information, circuits, equipment, or software described in this manual.

Reproduction of the contents of this manual, in whole or in part, without written permission of Rockwell Automation, Inc., is prohibited

Throughout this manual, when necessary, we use notes to make you aware of safety considerations.



WARNING: Identifies information about practices or circumstances that can cause an explosion in a hazardous environment, which may lead to personal injury or death, property damage, or economic loss.



ATTENTION: Identifies information about practices or circumstances that can lead to personal injury or death, property damage, or economic loss. Attentions help you identify a hazard, avoid a hazard, and recognize the consequence.

IMPORTANT Identifies information that is critical for successful application and understanding of the product.

Labels may also be on or inside the equipment to provide specific precautions.



SHOCK HAZARD: Labels may be on or inside the equipment, for example, a drive or motor, to alert people that dangerous voltage may be present.



BURN HAZARD: Labels may be on or inside the equipment, for example, a drive or motor, to alert people that surfaces may reach dangerous temperatures.



ARC FLASH HAZARD: Labels may be on or inside the equipment, for example, a motor control center, to alert people to potential Arc Flash. Arc Flash will cause severe injury or death. Wear proper Personal Protective Equipment (PPE). Follow ALL Regulatory requirements for safe work practices and for Personal Protective Equipment (PPE).

	Preface	9
	Summary of Changes	9
	Overview	9
	Additional Resources	9
	 Chapter 1	
ControlLogix and GuardLogix Systems	Minimum Requirements	13
	ControlLogix System	14
	Standalone Controller and I/O	14
	Multiple Controllers in One Chassis	15
	Multiple Devices Connected via Multiple Networks	16
	GuardLogix System	17
	Design the System	20
	ControlLogix 5580 Controller Features	21
	GuardLogix 5580 Controller Features	22
	Features Supported By GuardLogix 5580 Controllers Via the Safety Task	23
	 Chapter 2	
Safety Concept of GuardLogix Controllers	Functional Safety Capability	25
	Safety Network Number	26
	Safety Signature	26
	Distinguish between Standard and Safety Components	27
	Controller Data-flow Capabilities	28
	Safety Terminology	29
	 Chapter 3	
Communication Networks	Networks Available	31
	EtherNet/IP Network Communication	33
	EtherNet/IP Link Speeds	33
	EtherNet/IP Communication Modules	36
	Software for EtherNet/IP Networks	37
	Double Data Rate (DDR) Backplane Communication for ControlLogix Controllers	37
	ControlNet Network Communication	38
	GuardLogix ControlNet Example	39
	ControlNet Modules	40
	Software for ControlNet Networks	40
	DeviceNet Network Communication	41
	DeviceNet Bridge Module and Linking Devices	42
	Software for DeviceNet Networks	42
	Connections Over DeviceNet Networks	42
	DeviceNet Module Memory	42

Data Highway Plus (DH+) Network Communication 43
 Communicate Over a DH+ Network 44
 Universal Remote I/O (RIO) Communication 45
 Communicate Over a Universal Remote I/O Network 46
 Foundation Fieldbus Communication 47
 HART Communication 48

Chapter 4

Connect to a Controller

Configure EtherNet/IP and USB Drivers on Your Workstation .. 50
 Configure the EtherNet/IP Communication Driver in
 RSLinx Classic Software 50
 Configure the USB Communication Driver in
 RSLinx Classic Software 53
 Connection Options 55
 Connect to an EtherNet/IP Network 55
 Connect a USB Cable..... 62
 Update Controller Firmware..... 63
 Determine Required Controller Firmware..... 63
 Obtain Controller Firmware 63
 Use ControlFLASH Software to Update Firmware..... 64
 Use AutoFlash to Update Firmware..... 68

Chapter 5

Start Using the Controller

Create a Logix Designer Application Project..... 71
 Additional Configuration for a GuardLogix Controller..... 72
 Set the Safety Level for a GuardLogix Controller 72
 Passwords for Safety-locking and Unlocking 73
 Protect the Safety Signature in Run Mode 74
 Assign the Safety Network Number (SNN)..... 75
 Change the Safety Network Numbers (SNNs) 78
 Copy and Paste a Safety Network Number (SNN) 80
 Go Online with the Controller..... 81
 Use RSWho..... 81
 Use a Recent Communication Path 82
 Additional Considerations for Going Online with a GuardLogix
 Controller 83
 Match Project to Controller..... 83
 Firmware Revision Matching 84
 Safety Status/Faults..... 84
 Safety Signature and Safety-locked and -unlocked Status 85
 Checks for Going Online with a GuardLogix Controller..... 86
 Download to the Controller 87
 Use Who Active..... 87
 Use the Controller Status Menu 88
 Additional Considerations for Download to a
 GuardLogix Controller 88

Upload from the Controller..... 90
 Use Who Active..... 90
 Use the Controller Status Menu 91
 Additional Considerations for Upload from a
 GuardLogix Controller 92
 Choose the Controller Operation Mode 93
 Use the Mode Switch to Change the Operation Mode..... 94
 Use the Logix Designer Application to Change the
 Operation Mode 95
 Reset Button..... 96
 Stage 1 Reset 97
 Stage 2 Reset 98
 Safety Partner Reset..... 99

Chapter 6

Use the Secure Digital Card

Considerations for Storing and Loading a Safety Project 103
 Store to the SD Card 104
 Load from the SD Card..... 108
 Controller Power-up..... 108
 User-initiated Action 109
 Other Secure Digital Card Tasks 110

Chapter 7

**Manage Controller
Communication**

Connection Overview 111
 Nodes on an EtherNet/IP Network..... 112
 Devices Included in the Node Count..... 112
 Devices Excluded from the Node Count..... 113
 Controller Communication Interaction with Control Data..... 114
 Produce and Consume (Interlock) Data..... 115
 Requested Packet Interval (RPI) of Multicast Tags 116
 Send and Receive Messages..... 117
 Determine Whether to Cache Message Connections 118
 Socket Interface..... 118

Chapter 8

Standard I/O Modules

Selecting ControlLogix
 I/O Modules..... 119
 Electronic Keying..... 120
 Local I/O Modules 121
 Add Local I/O to the I/O Configuration 121
 Remote I/O Modules..... 126
 Add Remote I/O to the Ethernet Port on the Controller 127
 Add Remote I/O to a Local Communication Module 129
 Add to the I/O Configuration While Online 133
 Modules and Devices that Can be Added While Online 134

Determine When Data is Updated..... 135
 Input Data Update Flowchart 135
 Output Data Update Flowchart 136

Chapter 9

Safety I/O Devices

Add Safety I/O Devices..... 137
 Configure Safety I/O Devices 138
 Using Network Address Translation (NAT) with
 CIP Safety Devices 140
 Set the Safety Network Number (SNN)..... 141
 Connection Reaction Time Limit 142
 Safety I/O Device Signature..... 143
 Configuration via the Logix Designer Application..... 143
 Different Configuration Owner (data-only connection) 144
 Reset Safety I/O Device to Out-of-box Condition..... 145
 I/O Device Address Format..... 146
 Monitor Safety I/O Device Status 146
 Replace a Safety I/O Device 147
 Configuration Ownership..... 147
 Replacement Configuration 148
 Replacement with ‘Configure Only When No Safety Signature
 Exists’ Enabled 149
 Replacement with ‘Configure Always’ Enabled..... 154

Chapter 10

Develop Standard Applications

Elements of a Control Application..... 155
 Tasks..... 157
 Task Priority 159
 Programs 159
 Scheduled and Unscheduled Programs 161
 Routines..... 162
 Parameters and Local Tags 163
 Program Parameters 164
 Programming Languages 164
 Add-On Instructions 165
 Extended Properties 166
 Access the Module Object from an Add-On Instruction 167
 Monitor Controller Status 168
 Monitor I/O Connections..... 169
 Determine If I/O Communication Has Timed Out 169
 Determine if I/O Communication to a Specific I/O Module has
 Timed Out..... 170
 Automatic Handling of I/O Module Connection Faults..... 170
 Sample Controller Projects..... 171

	Chapter 11	
Develop Safety Applications	Safety Task	174
	Safety Task Period	175
	Safety Task Execution.....	176
	Safety Programs	176
	Safety Routines	176
	Safety Add-On Instructions	177
	Safety Tags	177
	Valid Data Types	178
	Scope.....	178
	Program Parameters	179
	Produced/Consumed Safety Tags.....	179
	Configure the SNN for a Peer Safety Controller Connection.....	180
	Produce a Safety Tag.....	184
	Consume Safety Tag Data.....	185
	Safety Tag Mapping	188
	Restrictions	188
	Create Tag Mapping Pairs.....	189
	Monitor Tag Mapping Status.....	190
	Safety Application Protection	191
	Safety-lock the Controller	191
	Set Passwords for Safety-locking and Unlocking.....	193
	Generate a Safety Signature.....	194
	Programming Restrictions	196
	Monitor Safety Status	197
	View Status via the Online Bar.....	197
	View Status via the Safety Tab	199
	Monitor Safety Connections	200
Utilizing Status.....	201	
Safety Faults	203	
Nonrecoverable Controller Faults.....	203	
Nonrecoverable Safety Faults in the Safety Application	203	
Recoverable Faults in the Safety Application	204	
View Faults	204	
Fault Codes	205	
Develop a Fault Routine for Safety Applications	206	
Use GSV/SSV Instructions in a Safety Application.....	207	
	Chapter 12	
Develop Motion Applications	Motion Overview	210
	Program Motion Control.....	211
	Obtain Axis Information	213

	Chapter 13	
Troubleshoot the Controller	Controller Diagnostics with Logix Designer	215
	I/O Module Properties Tab	216
	Notification in the Tag Monitor.....	217
	Enable Major Fault on Controller	218
	Port Diagnostics	219
	Advanced Time Sync	221
	Controller Diagnostics with Linx-based Software	224
	Controller Web Pages	225
	Tasks Webpage.....	226
	Browse Chassis Webpage.....	227
	 Appendix A	
Status Indicators	Status Display and Indicators.....	230
	General Status Messages	231
	GuardLogix Status Messages	232
	Safety Partner Status Messages.....	233
	Fault Messages	233
	Major Fault Messages.....	234
	I/O Fault Codes	236
	Controller Status Indicators.....	239
	RUN Indicator.....	239
	FORCE Indicator	239
	SD Indicator	240
	OK Indicator	240
	Safety Partner OK Indicator	241
	EtherNet/IP Indicators.....	241
	Thermal Monitoring and Thermal Fault Behavior	242
	 Appendix B	
Security Options	Disable the Ethernet Port.....	243
	Disable the Ethernet Port on the Port Configuration Tab....	244
	Disable the Ethernet Port With a MSG Instruction	245
	Disable the 4-character Status Display.....	246
	Disable All Categories of Messages	247
	Disable Individual Categories of Messages	249
	Disable the Controller Web Pages	250
	 Appendix C	
Change Controller Type	Change from a Standard to a Safety Controller	253
	Change from a Safety to a Standard Controller	254
	Change Safety Controller Types.....	254
	 Index	255

Summary of Changes

This manual contains new and updated information as indicated in the following table.

Topic	Page
Added GuardLogix® 5580 and Safety information	Throughout

Overview

This manual provides information about designing a system, operating a ControlLogix® or GuardLogix-based controllers system, and developing applications.

You must be trained and experienced in the creation, operation, and maintenance of safety systems.

For information on Safety Integrity Level (SIL) and Performance Level (PL) requirements and safety application requirements, see the GuardLogix 5580 and Compact GuardLogix 5380 Controller Systems Safety Reference Manual, publication [1756-RM012](#).

Additional Resources

These documents contain additional information concerning related products from Rockwell Automation.

Table 1 - Additional Resources

Resource	Description	
Hardware Installation	ControlLogix 5580 Controllers Installation Instructions, publication 1756-IN043	Provides installation instructions for ControlLogix 5580 controllers.
	GuardLogix 5580 Controllers Installation Instructions, publication 1756-IN048	Provides installation instructions for GuardLogix 5580 controllers.
	ControlLogix Power Supply Installation Instructions, publication 1756-IN619	Describes how to install standard power supplies.
	ControlLogix Redundant Power Supply Installation Instructions, publication 1756-IN620	Describes how to install redundant power supplies.
	ControlLogix Chassis Installation Instructions, publication 1756-IN621	Describes how to install ControlLogix chassis.
	Replacement door labels for the 1756 I/O modules, publication IASIMP-SP021	Contains door labels for the 1756 I/O modules that are available to print.
Technical Data	1756 ControlLogix Controllers Technical Data, publication 1756-TD001	Provides specifications for ControlLogix controllers.
	1756 ControlLogix I/O Specifications Technical Data, publication 1756-TD002	Provides specifications for ControlLogix I/O modules.
	Compact 5000 I/O Modules Specifications Technical Data, publication 5069-TD001	Provides specifications for Compact 5000™ I/O EtherNet/IP adapters and Compact 5000 I/O modules.

Table 1 - Additional Resources (continued)

Resource		Description
Networks (ControlNet, DeviceNet, EtherNet/IP)	EtherNet/IP Communication Modules in Logix5000 Series Systems User Manual, publication ENET-UM004	How to install and configure the 5069-AEN2TR EtherNet/IP adapter.
	Guidance for Selecting Cables for EtherNet/IP Networks, publication ENET-WP007-EN-P	Provides information on how to select cabling based on the application, environmental conditions, and mechanical requirements.
	ControlNet Network Configuration User Manual, publication CNET-UM001	Provides information about ControlNet networks.
	DeviceNet Media Design Installation Guide, publication DNET-UM072	Provides information about DeviceNet networks.
CIP Sync (time synchronization)	Integrated Architecture and CIP Sync Configuration Application Technique, publication IA-AT003	Describes how to configure CIP Sync with Integrated Architecture® products and applications.
Safety application requirements	GuardLogix 5580 and Compact GuardLogix 5380 Controller Systems Safety Reference Manual, publication 1756-RM012	Contains detailed requirements for achieving and maintaining SIL 2/PLd and SIL 3/PLe with the GuardLogix 5580 controller system, using the Studio 5000 Logix Designer® application.
Motion	Integrated Motion on the EtherNet/IP Network Configuration and Startup User Manual, publication MOTION-UM003	Details how to design your ControlLogix system for Integrated Motion on the EtherNet/IP network applications.
	Integrated Motion on the EtherNet/IP Network Reference Manual, publication MOTION-RM003	Detailed information on axis control modes and attributes for Integrated Motion on EtherNet/IP networks.
	Motion Coordinate System User Manual, publication MOTION-UM002	Details how to create and configure a coordinated motion application system.
	SERCOS and Analog Motion Configuration and Startup User Manual, publication MOTION-UM001	Details how to configure a Sercos motion application system.
Design Considerations	Logix5000 Controllers Design Considerations Reference Manual, publication 1756-RM094	Provides information to help design and plan LOGIX 5000™ systems.
	ControlLogix System Selection Guide, publication 1756-SG001	Provides information to help design and select components for your ControlLogix system.
	Ethernet Design Considerations Reference Manual, publication ENET-RM002	Provides additional information about network design for your system.
	FOUNDATION Fieldbus Design Considerations Reference Manual, PROCES-RM005	This document provides design choices and best practices for implementing a FOUNDATION Fieldbus network with the 1788-EN2FFR or 1788-CN2FFR linking devices.
	Using Logix5000 Controllers as Masters or Slaves on Modbus Application Solution, publication CIG-AP129	For more information about using Modbus sample programs.

Table 1 - Additional Resources (continued)

Resource		Description
Programming Tasks and Procedures	Logix5000 Controllers Common Procedures Programming Manual, publication 1756-PM001	Provides access to the Logix5000 Controllers set of programming manuals. The manuals cover such topics as how to manage project files, organize tags, program logic, test routines, handle faults, and more.
	Logix5000 Controllers Program Parameters, publication 1756-PM021	
	Logix5000 Controllers Add-On Instructions Programming Manual, publication 1756-PM010	Provides information on how to use add-on instructions.
	Logix5000 Controllers I/O and Tag Data Programming Manual, publication 1756-PM004	Provides information on how to create and configure program tags for optimal task and program execution.
	Logix5000 Controllers Major, Minor, and I/O Faults Programming Manual, publication 1756-PM014	Provides more information about I/O faults.
	Logix5000 Controllers Messages Programming Manual, publication 1756-PM012	Provides information about controller messages.
	Logix5000 Controllers Nonvolatile Memory Card Programming Manual, publication 1756-PM017	Provides information on how to use a nonvolatile memory card in a Logix5000 controller.
	Logix5000 Controllers Produced and Consumed Tags Programming Manual, publication 1756-PM011	Provides more information on how to use produced and consumed tags.
	Logix5000 Controllers General Instructions Reference Manual, publication 1756-RM003	Provides information on the programming instructions available to use in Logix Designer application projects.
	GuardLogix Safety Application Instruction Set Reference Manual, publication 1756-RM095	Provides information on the GuardLogix Safety application instruction set.
Product Certifications	Product Certifications website, https://www.rockwellautomation.com/global/certification/overview.page	Provides declarations of conformity, certificates, and other certification details.

You can view or download publications at <http://www.rockwellautomation.com/literature/>.

To order paper copies of technical documentation, contact your local Allen-Bradley distributor or Rockwell Automation sales representative.

Notes:

ControlLogix and GuardLogix Systems

This chapter describes features and functions that are associated with the ControlLogix® 5580 and GuardLogix® 5580 controllers.

Topic	Page
Minimum Requirements	13
ControlLogix System	14
GuardLogix System	17
Design the System	20
ControlLogix 5580 Controller Features	21

Minimum Requirements

ControlLogix



GuardLogix



The controllers have these minimum requirements.

- ControlLogix Chassis, Series C (Series B chassis function within a derated temperature range)
- ControlLogix Chassis Power Supply
- Programming software

System	Cat. No.	Studio 5000 Logix Designer® ⁽²⁾
ControlLogix	1756-L83E, 1756-L83EK ⁽¹⁾ , 1756-L85E, 1756-L85EK	Version 28.00.00 or later
ControlLogix	1756-L81E, 1756-L81EK, 1756-L82E, 1756-L82EK, 1756-L84E, 1756-L84EK	Version 29.00.00 or later
GuardLogix	1756-L81ES, 1756-L81ESK, 1756-L82ES, 1756-L82ESK, 1756-L83ES, 1756-L83ESK, 1756-L84ES, 1756-L84ESK, 1756-L8SP, 1756-L8SPK	Version 31.00.00 or later ⁽³⁾

(1) Catalog numbers followed by a "K" indicate a conformal coating option.

(2) For compatible Linx-based communication software and ControlFLASH™ software, see the [Product Compatibility and Download Center \(PCDC\)](#).

(3) Studio 5000 Logix Designer® Professional, Full Edition, or a separately licensed GuardLogix Safety Editor must be present on the workstation in order to edit a GuardLogix project.

IMPORTANT If safety connections or safety logic are required for your application, then you must use a GuardLogix controller.

Waste Electrical and Electronic Equipment (WEEE)



At the end of its life, this equipment should be collected separately from any unsorted municipal waste.

ControlLogix System

ControlLogix



The ControlLogix system is chassis-based, which provides options for configuring a variety of communications and I/O capabilities.

The ControlLogix controllers support multiple programming languages that enable sequential, process, motion, and drive control.

A variety of system configuration options are described in the following sections.

Standalone Controller and I/O

One of the simplest controller configurations is a standalone controller with I/O assembled in one chassis.

Figure 1 - Standalone Controller and I/O

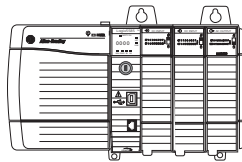

Multiple Controllers in One Chassis

You can use multiple controllers in one ControlLogix chassis. This example shows a ControlLogix 5580 controller (slot 0) connected directly to the EtherNet/IP Network, a ControlLogix 5570 controller (slot 1) connected to the network through a 1756-EN2TR module (slot 7), and a GuardLogix 5580 controller in a SIL 2/PLd configuration (slot 5) connected directly to the EtherNet/IP Network.

Figure 2 - Multiple Controllers in One Chassis

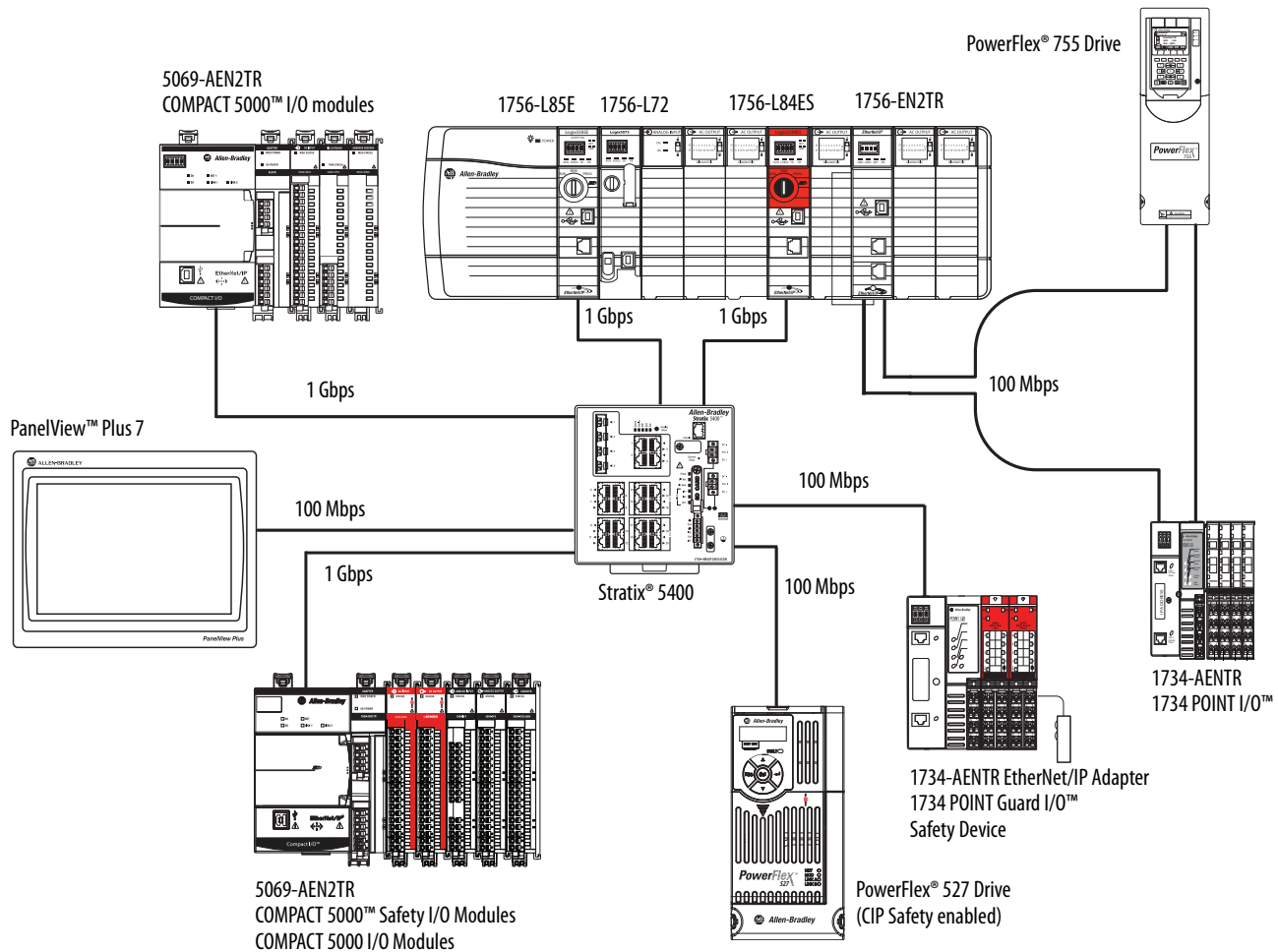

IMPORTANT You cannot bridge through the Ethernet (front) port of another controller to add remote I/O.

Multiple Devices Connected via Multiple Networks

For some applications, various devices can be connected to the ControlLogix chassis via multiple communication networks. For example, a system can be connected to the following:

- Distributed I/O via an Ethernet network
- A PowerFlex drive connected via a DeviceNet network
- Distributed I/O via a ControlNet network.
- Flowmeters that are connected via a HART connection

Figure 3 - Multiple Devices Connected Via Multiple Networks

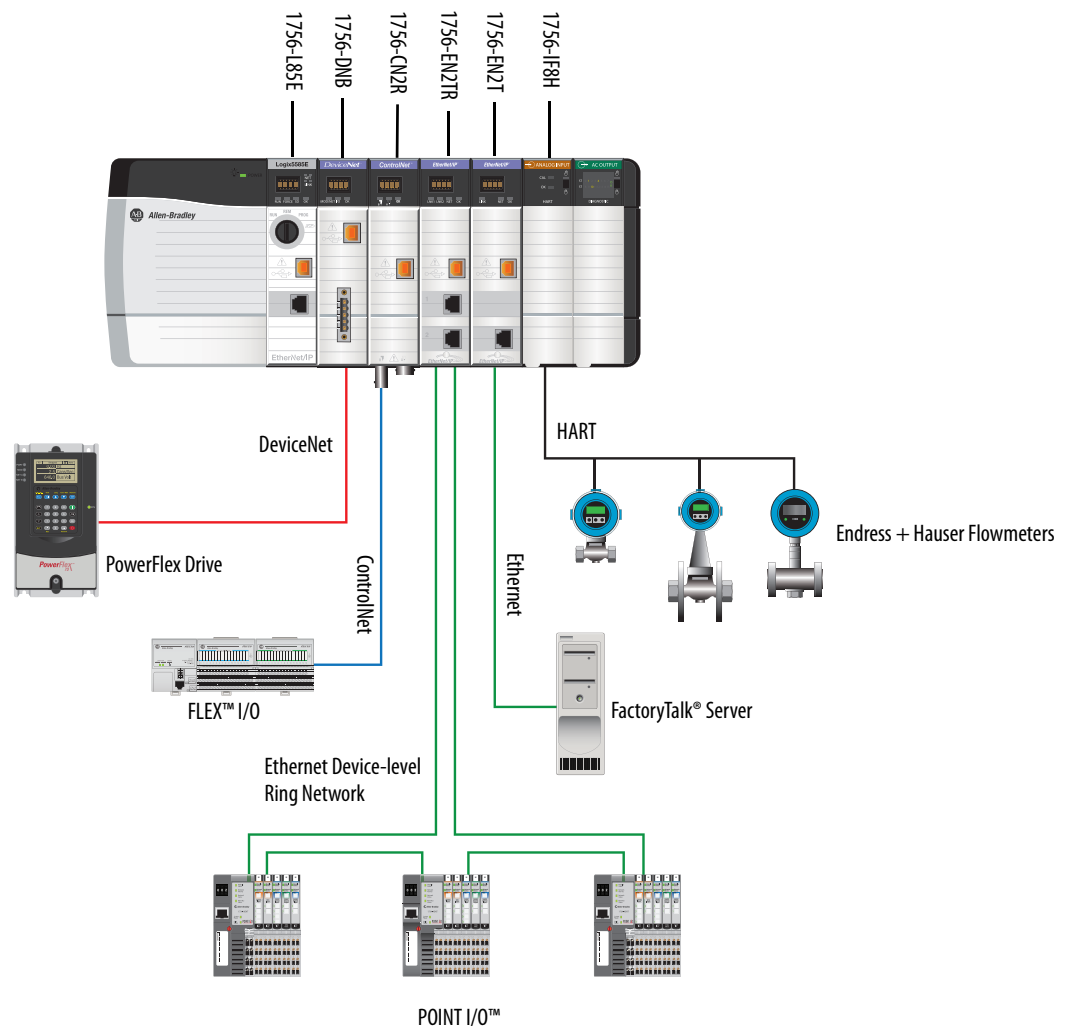

GuardLogix System

GuardLogix



The GuardLogix system can communicate with safety I/O devices via CIP Safety over an EtherNet/IP network (Guard I/O™ modules, integrated safety drives, integrated safety components).

For a GuardLogix controller, you can interface to local standard I/O in the backplane via standard tasks while you interface with remote safety I/O through the EtherNet/IP port.

The GuardLogix system supports up to SIL 3 and PL_e safety applications.

- Without a safety partner installed, you can achieve SIL 2/PL_d (Category 3) with the use of the safety task and safety I/O.
- With the use of the safety task and a safety partner installed, you can achieve SIL 3/PL_e (Category 4) capability.

IMPORTANT For the safety task, GuardLogix controllers support Ladder Diagram only.

For standard tasks, GuardLogix controllers support:

- Ladder Diagram (LD)
 - Structured Text (ST)
 - Function Block Diagram (FBD)
 - Sequential Function Chart (SFC)
-

For SIL 3 safety applications, the GuardLogix system is composed of a primary GuardLogix controller and a safety partner that function together in a 1oo2 architecture.

- The primary controller is the processor that performs standard and safety functions and communicates with the safety partner for safety-related functions in the GuardLogix control system.
- The safety partner is a co-processor that provides an isolated second channel for safety-related functions in the system. The safety partner does not have a key switch or communication port. The primary controller controls the configuration and operation of the safety partner.
- The safety partner must be installed in the slot immediately to the right of the primary controller. The firmware major and minor revisions of the primary controller and safety partner must match exactly to establish the control partnership that is required for safety applications

For information on Safety Integrity Level (SIL) and Performance Level (PL) requirements and safety application requirements, see the GuardLogix 5580 and Compact GuardLogix 5380 Controller Systems Safety Reference Manual, publication [1756-RM012](#).

GuardLogix with Safety I/O and Integrated Safety Drives

In this example, a single GuardLogix safety controller makes the Motion and Safety connections.

IMPORTANT If only one controller is used in an application with Motion and Safety connections, it must be a safety controller such as the GuardLogix 5580 controller.

Figure 4 - Motion and Safety Configuration (single controller)

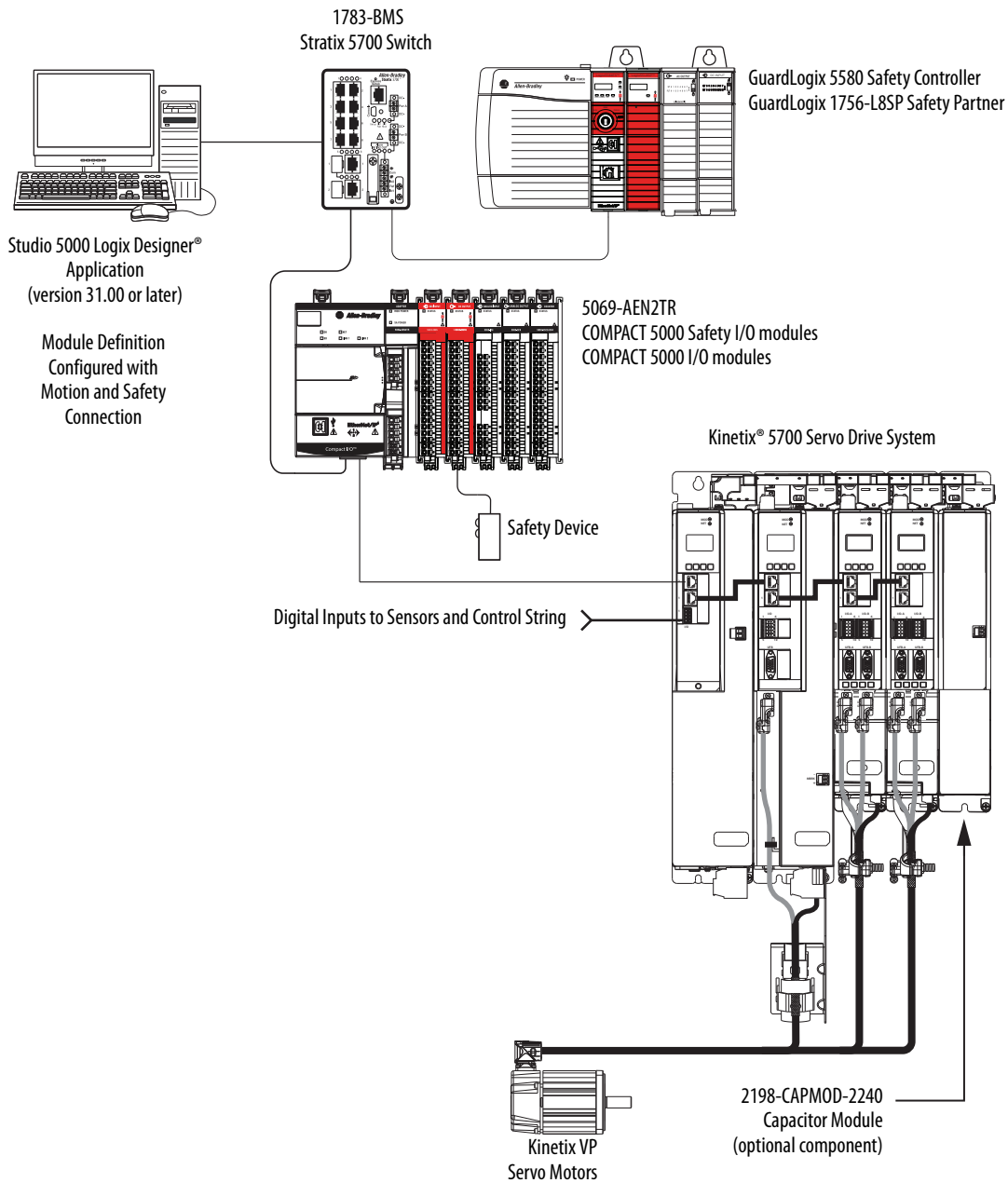

In this example, a standard controller makes the Motion-only connection and a separate GuardLogix 5580 controller makes the safety-only connection.

IMPORTANT If two controllers are used in an application with motion-only and safety-only connections, the safety-only connection must be a GuardLogix controller while the motion-only connection can be made by either a standard or a safety controller.

Figure 5 - Motion and Safety Configuration (multi-controller)

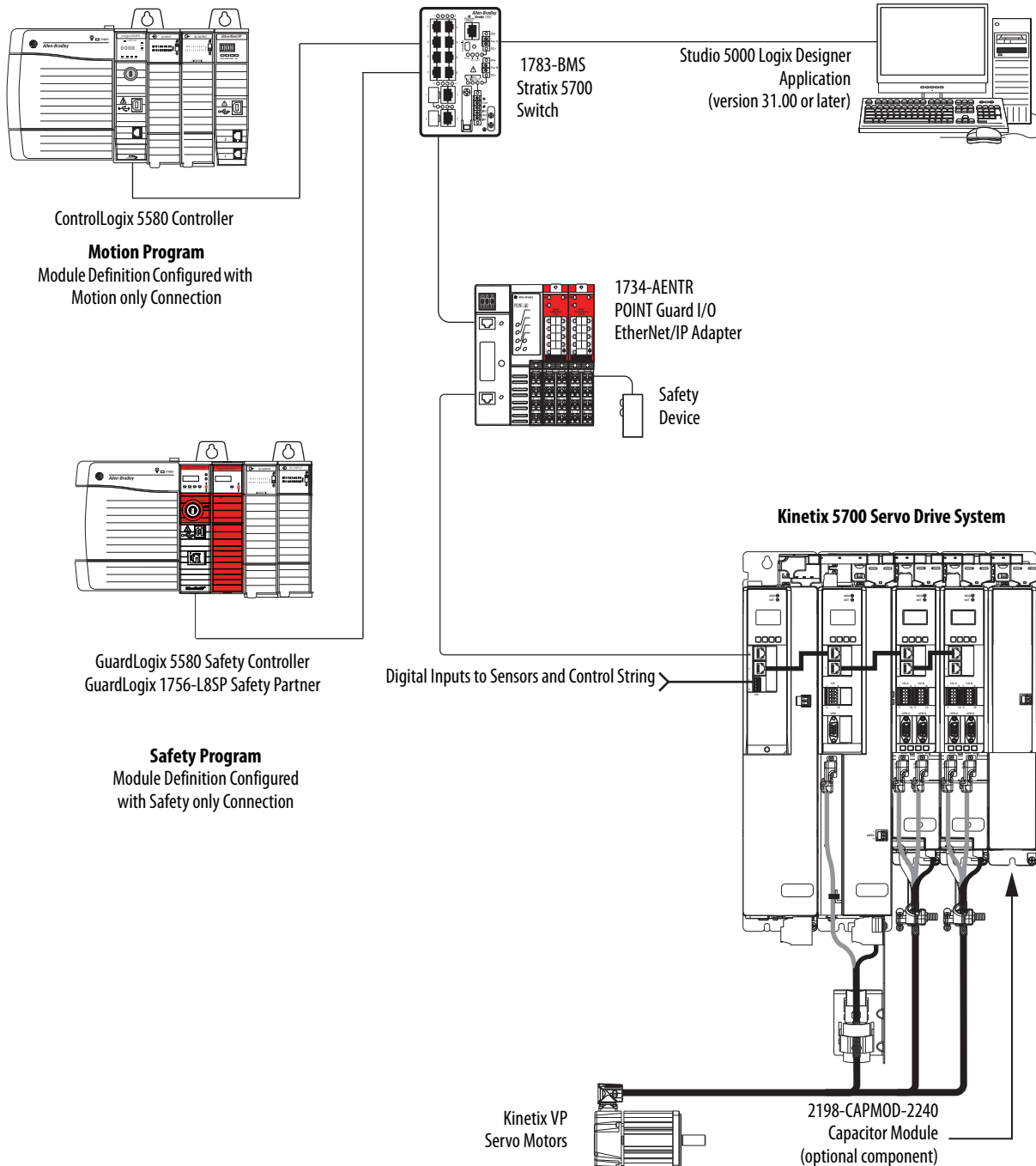

Design the System

ControlLogix



GuardLogix



When you design a system, there are several system components to consider for your application:

- I/O devices
- Motion control axes and drives
- Communication modules
- Controllers
- Chassis
- Power supplies
- Studio 5000 Logix Designer Application

In addition, safety systems have also have components to consider:

- Safety Controller
- Safety Partner (for SIL 3/PLe applications)
- Safety I/O
- Safety Devices

For more information to design and select components for your system, see:

- 1756 ControlLogix Controllers Technical Data, publication [1756-TD001](#)
- 1756 ControlLogix I/O Specifications Technical Data, publication [1756-TD002](#)
- COMPACT 5000 I/O Modules Specifications Technical Data, publication [5069-TD001](#)
- GuardLogix 5580 and Compact GuardLogix 5380 Controller Systems Safety Reference Manual, publication [1756-RM012](#)

See the [Additional Resources](#) section in the preface for more information if you are designing your system for any of the following applications:

- Motion with Integrated Motion on the EtherNet/IP network
- Motion with the use of a coordinate system
- Motion with Sercos or analog motion

ControlLogix 5580 Controller Features

This table lists the system, communication, and programming features available with ControlLogix 5580 controllers.

ControlLogix



Table 1 - ControlLogix 5580 Controller Features

Feature	1756-L81E	1756-L82E	1756-L83E	1756-L84E	1756-L85E
User Memory	3 MB	5 MB	10 MB	20 MB	40 MB
EtherNet/IP nodes supported, max ⁽¹⁾	60 nodes ⁽⁴⁾ 100 nodes ⁽⁵⁾	80 nodes ⁽⁴⁾ 175 nodes ⁽⁵⁾	100 nodes ⁽³⁾ 250 nodes ⁽⁵⁾	150 nodes ⁽⁴⁾ 250 nodes ⁽⁵⁾	300 nodes ⁽⁶⁾
Communication ports	1 - USB port, 2.0 full-speed, Type B 1 - EtherNet/IP port: 10 Mbps, 100 Mbps, 1 Gbps link speeds				
Communication options	<ul style="list-style-type: none"> • EtherNet/IP • ControlNet • DeviceNet • Data Highway Plus™ • Remote I/O • SynchLink™ • Third-party process and device networks 				
Controller tasks	<ul style="list-style-type: none"> • 32 tasks • 1000 programs/task • Event tasks: all event triggers 				
Integrated motion	<ul style="list-style-type: none"> • Integrated Motion on the EtherNet/IP network • Sercos interface⁽²⁾ • Analog options⁽²⁾: <ul style="list-style-type: none"> – Encoder input – Linear displacement transducer (LDT) input – Serial Synchronous Input (SSI) 				
Programming languages	<ul style="list-style-type: none"> • Ladder Diagram (LD) • Structured Text (ST) • Function Block Diagram (FBD) • Sequential Function Chart (SFC) 				

(1) A node is an EtherNet/IP device that you add directly to the I/O configuration, and counts toward the node limits of the controller. For more information on EtherNet/IP nodes, see the ControlLogix 5580 Controllers User Manual, publication [1756-UM543](#).

(2) With Studio 5000 Logix Designer Application Version 31 or greater.

(3) With Studio 5000 Logix Designer Application Version 28 and Version 29.

(4) With Studio 5000 Logix Designer Application Version 29.

(5) With Studio 5000 Logix Designer Application Version 30 or greater.

(6) With Studio 5000 Logix Designer Application Version 28 or greater.

GuardLogix 5580 Controller Features

GuardLogix



This table lists the system, communication, and programming features available with GuardLogix 5580 controllers.

Table 2 - GuardLogix 5580 Controller Features

Feature	1756-L81ES	1756-L82ES	1756-L83ES	1756-L84ES
User Memory	3 MB	5 MB	10 MB	20 MB
Safety Memory	1.5 MB	2.5 MB	5 MB	6 MB
EtherNet/IP nodes supported, max	100	175	250	250
Communication ports	1 - USB port, 2.0 full-speed, Type B 1 - EtherNet/IP port: 10 Mbps, 100 Mbps, 1 Gbps link speeds			
Communication options	<ul style="list-style-type: none"> • EtherNet/IP (1756-EWEB cannot be used for safety connections) • Support for Network address translation (NAT) • ControlNet • DeviceNet • Data Highway Plus™ • Remote I/O • SynchLink™ • Third-party process and device networks 			
Controller tasks	<ul style="list-style-type: none"> • 31 standard tasks, 1 safety task • 1000 programs/task • Event tasks: all event triggers 			
Integrated motion	Integrated motion is supported in standard task only. <ul style="list-style-type: none"> • Integrated Motion on the EtherNet/IP network • Sercos interface • Analog options: <ul style="list-style-type: none"> – Encoder input – Linear displacement transducer (LDT) input – Serial Synchronous Input (SSI) 			
Programming languages	<ul style="list-style-type: none"> • For the safety task, GuardLogix controllers support Ladder Diagram only. • For standard tasks, GuardLogix controllers support: <ul style="list-style-type: none"> – Ladder Diagram (LD) – Structured Text (ST) – Function Block Diagram (FBD) – Sequential Function Chart (SFC) 			
Integrated safety	<ul style="list-style-type: none"> • Integrated safety on the EtherNet/IP network (Kinetix drives, PowerFlex drives, safety components) • Distribute and control safety I/O (over EtherNet/IP and DeviceNet networks only) • Produce and consume safety tag data. 			
Controller Features	<ul style="list-style-type: none"> • Data access control • Firmware supervisor • Secure Digital (SD) card • Safety Connections • Standard Connections 			

Features Supported By GuardLogix 5580 Controllers Via the Safety Task

In the Logix Designer application, version 31 or later, the Safety task supports a subset of features that are supported in the standard task as listed in this table.

Feature	Studio 5000 Logix Designer Application, Version 31 or Later	
	Safety Task	Standard Task
Add-on instructions	X	X
Instruction-based alarms and events	—	X
Tag-based alarms	—	X
Controller logging	X	X
Event tasks ⁽¹⁾	—	X
Function block diagrams (FBD)	—	X
Integrated motion ⁽²⁾	X	X
Analog motion	—	X
Sercos motion	—	X
Drive Safety Instructions	X	—
Ladder Diagram (LD)	X	X
Language switching	X	X
License-based source protection	—	X
Online import of program components	—	X
Online export of program components	X	X
Sequential function chart (SFC) routines	—	X
Structured Text (ST)	—	X

(1) While the safety task cannot be an Event task, standard Event tasks can be triggered with the use of the Event instruction in the safety task.

(2) With the use of Drive Safety Instructions and Kinetix 5700 ERS4 drives.

IMPORTANT Safety Consideration

GuardLogix 5580 controllers can produce standard tags as unicast or multicast, but they can only produce safety tags as unicast. The controllers can consume safety tags as either unicast or multicast.

When you configure a produced safety tag, you are only allowed to configure unicast connection options. Logix Designer does not allow you to configure multicast connection options.

When you configure a consumed tag, you must consider the capabilities of the producer:

- If the producer in the I/O tree of this controller is a GuardLogix 5580 or Compact GuardLogix 5380 controller, and you are consuming a safety tag, you must configure the consumed tag to use unicast.
- If the producer in the I/O tree of this controller is a GuardLogix 5570 or 5560, or a Compact GuardLogix 5370, the safety consumed tag can be configured as either unicast or multicast.
- GuardLogix 5580 controllers do not produce safety tags to GuardLogix 5570 (firmware revision 30 and earlier) controllers in the same chassis, because GuardLogix 5580 controllers can only produce safety tags as unicast, and GuardLogix 5570 (firmware revision 30 and earlier) controllers cannot configure consumed tags as unicast. This restriction does not apply over EtherNet/IP, as consumed tags can be configured for unicast.

Notes:

GuardLogix Only



Safety Concept of GuardLogix Controllers

Topic	Page
Functional Safety Capability	25
Safety Network Number	26
Safety Signature	26
Distinguish between Standard and Safety Components	27
Controller Data-flow Capabilities	28
Safety Terminology	29

Functional Safety Capability

The GuardLogix® 5580 controller system is certified for use in safety applications up to and including SIL 2/PLd and SIL 3/PLe where the de-energized state is the safe state.

For SIL 3/PLe safety applications, the GuardLogix system is made up of a primary controller and a safety partner, that function together in a 1oo2 architecture.

For SIL 2/PLd and SIL 3/PLe safety system requirements, including functional validation test intervals, system reaction time, and PFD/PFH calculations, see the GuardLogix 5580 and Compact GuardLogix 5380 Controller Systems Safety Reference Manual, publication [1756-RM012](#).

You must read, understand, and fulfill these requirements before you operate a GuardLogix SIL 2/PLd or SIL 3/PLe safety system.

Safety Network Number

The safety network number (SNN) uniquely identifies CIP Safety subnets within a routable safety network. The combination of SNN + Node Address uniquely identifies each CIP Safety port on each device in the routable safety network.

The GuardLogix 5580 controllers require two safety network numbers: one for the EtherNet/IP port, and one for the backplane.

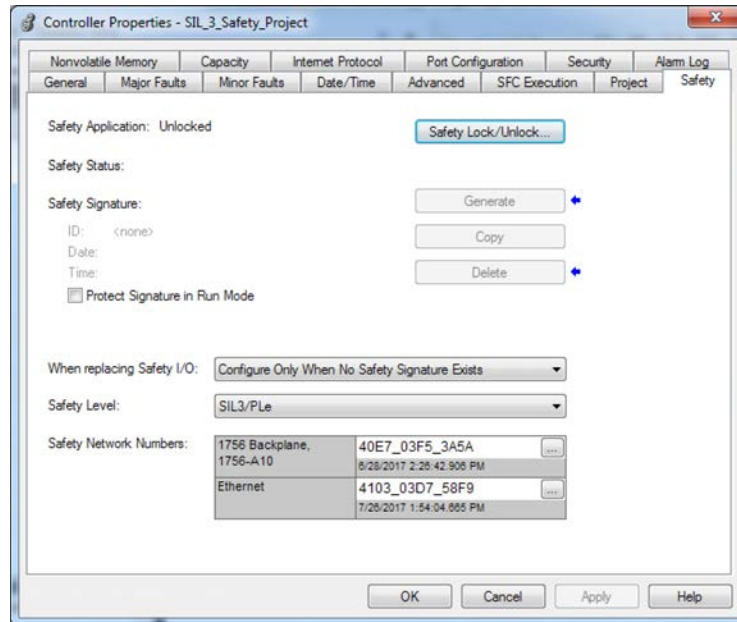

For an explanation of the Safety Network Number, see the GuardLogix 5580 and Compact GuardLogix 5380 Controller Systems Safety Reference Manual, publication [1756-RM012](#).

For information on how to assign the SNN, see [Assign the Safety Network Number \(SNN\) on page 75](#).

Safety Signature

The safety signature consists of an ID number, date, and time that uniquely identifies the safety portion of a project. This signature includes safety logic, data, and configuration.

The GuardLogix system uses the safety signature to determine project integrity and to let you verify that the correct project is downloaded to the target controller. The ability to create, record, and verify the safety signature is a mandatory part of the safety-application development process.

The safety signature must be present to operate as a SIL 2/PLd or SIL 3/PLe safety controller.

See [Generate a Safety Signature on page 194](#) for more information.

Distinguish between Standard and Safety Components

Slots of a GuardLogix system chassis that are not used by the safety function can be populated with other ControlLogix® modules that are certified to the Low Voltage and EMC Directives. See the Rockwell Automation Product Certifications page (<http://www.rockwellautomation.com/global/certification/overview.page?>) to find the CE certificate for the ControlLogix Product Family, and determine the modules that are certified.

You must create and document a clear, logical, and visible distinction between the safety and standard portions of the controller project. As part of this distinction, the Studio 5000 Logix Designer® application features safety identification icons to identify the safety task, safety programs, safety routines, and safety components.

In addition, the Logix Designer application uses a safety class attribute that is visible whenever safety task, safety programs, safety routine, safety tag, or safety Add-On Instruction properties are displayed.

Controller Data-flow Capabilities

This illustration explains the standard and safety data-flow capabilities of the GuardLogix controller.

Figure 6 - Data-flow Capabilities

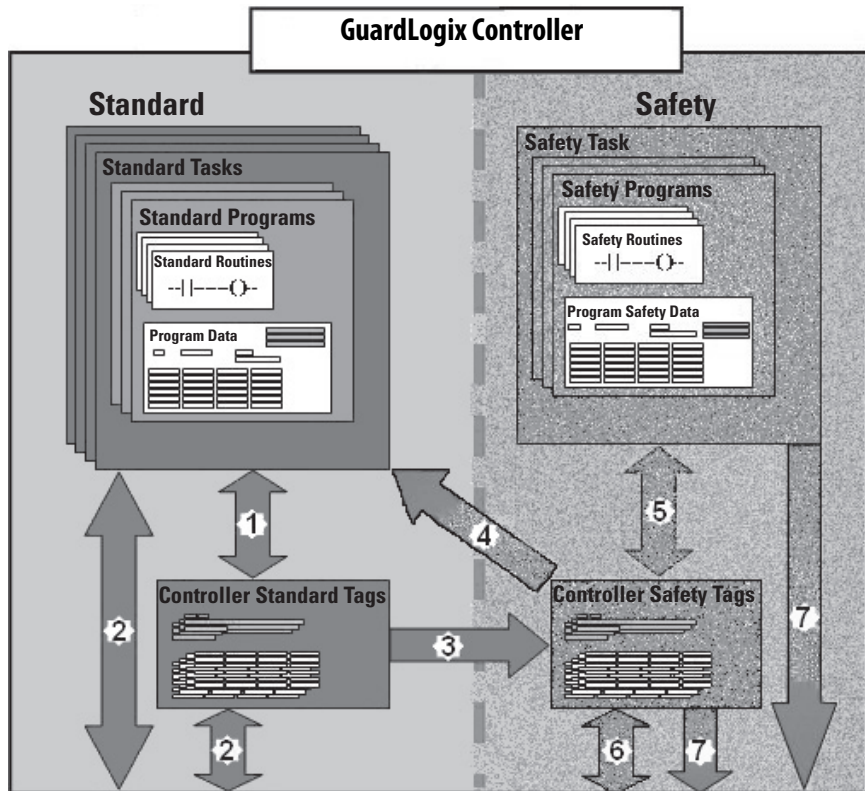

No.	Description
1	Standard tags and logic behave the same way that they do in a standard ControlLogix controller.
2	Standard tag data, program- or controller-scoped, can be exchanged with external HMI devices, personal computers, and other controllers.
3	GuardLogix controllers are integrated controllers with the ability to move (map) standard tag data into safety tags for use within the safety task. This is the only way to get standard tag data in to the safety task. Safety logic in the safety task cannot read or write the standard tag that is the source in the tag mapping data transfer; it can only reference the safety tag destination of the mapping. But, it can read and write that safety tag.  ATTENTION: Mapped tag data must not be used to control a SIL 2/PLd or SIL 3/PLe output directly.
4	Controller-scoped safety tags can be read directly by standard logic.
5	Safety tags can be read or written by safety logic.
6	Safety tags can be exchanged between safety controllers over Ethernet or ControlNet networks, including 1756 and 5069 GuardLogix controllers.
7	Safety tag data, program- or controller-scoped, can be read by external devices, such as HMI devices, personal computers, or other standard controllers. External devices cannot write to safety tags (whether the controller is protected or not). Once this data is read, it is considered standard data, not SIL 3/PLe data.

Safety Terminology

This table defines safety terms that are used in this manual.

Table 3 - Safety Terms and Definitions

Abbreviation	Full Term	Definition
1oo1	One Out of One	Identifies the programmable electronic controller architecture. 1oo1 is a single-channel system.
1oo2	One Out of Two	Identifies the programmable electronic controller architecture. 1oo2 is a dual-channel system.
CIP safety	Common Industrial Protocol – Safety Certified	SIL 3/PLe-rated version of CIP.
DC	Diagnostic Coverage	The ratio of the detected failure rate to the total failure rate.
PFD	Probability of Failure on Demand	The average probability of a system to fail to perform its design function on demand.
PFH	Probability of Failure per Hour	The probability of a system to have a dangerous failure occur per hour.
PL	Performance Level	ISO 13849-1 safety rating.
SIL	Safety Integrity Level	A relative level of risk-reduction provided by a safety function, or to specify a target level of risk reduction.
SIL CL	SIL Claim Limit	The maximum safety integrity level (SIL) that can be achieved.
SNN	Safety Network Number	A unique number that identifies a section of a safety network.
UNID	Unique Node ID (also called unique node reference)	The unique node reference is a combination of a safety network number (SNN) and the node address of the node.

Notes:

ControlLogix



GuardLogix



Communication Networks

Several communication networks are available.

Topic	Page
Networks Available	31
EtherNet/IP Network Communication	33
Double Data Rate (DDR) Backplane Communication for ControlLogix Controllers	37
ControlNet Network Communication	38
DeviceNet Network Communication	41
Data Highway Plus (DH+) Network Communication	43
Universal Remote I/O (RIO) Communication	45
Foundation Fieldbus Communication	47
HART Communication	48

Networks Available

[Table 4](#) describes typical application features that are used with ControlLogix® and GuardLogix® systems, and lists the networks available to support such application features.

Table 4 - Applications and Supported Networks

Application Features	ControlLogix and GuardLogix Supported Networks for Standard Communications	GuardLogix Supported Networks for CIP Safety Communications
Integrated Motion ⁽¹⁾	EtherNet/IP	EtherNet/IP
Time synchronization	EtherNet/IP	EtherNet/IP
Control of distributed I/O	<ul style="list-style-type: none"> EtherNet/IP DeviceNet ControlNet Foundation Fieldbus HART Universal remote I/O 	Time synchronization does not use the safety protocol.
Produce/consume data between controllers	<ul style="list-style-type: none"> EtherNet/IP ControlNet 	<ul style="list-style-type: none"> EtherNet/IP ControlNet
Messaging to and from other devices, including access to the controller via the Studio 5000 Logix Designer® application	<ul style="list-style-type: none"> EtherNet/IP ControlNet DeviceNet (only to devices) Data Highway Plus™ (DH+™) DH-485 	Messaging does not use the safety protocol.

(1) The controllers also support analog and Sercos motion interfaces. For more information, See [Develop Motion Applications on page 209](#).

For more information about using EtherNet/IP modules, see these publications:

- EtherNet/IP Modules in Logix5000 Control Systems User Manual, publication [ENET-UM001](#)
- EtherNet/IP Communication Modules in 5000 Series Systems, publication [ENET-UM004](#)

For more information about network design, see these publications;

- Ethernet Design Considerations Reference Manual, publication [ENET-RM002](#).
- ControlNet Network Configuration User Manual, publication [CNET-UM001](#)
- DeviceNet Media Design Installation Guide, publication [DNET-UM072](#)
- FOUNDATION Fieldbus Design Considerations Reference Manual, publication [PROCES-RM005](#)

EtherNet/IP Network Communication

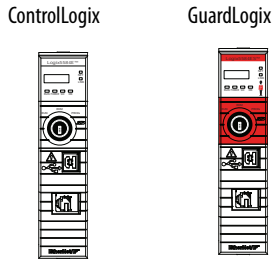

The EtherNet/IP network offers a full suite of control, configuration, and data collection services by layering the Common Industrial Protocol (CIP) over the standard Internet protocols, such as TCP/IP and UDP. This combination of well-accepted standards provides the capability that is required to support information data exchange and control applications.

IMPORTANT You cannot bridge through the Ethernet (front) port of another controller to add remote I/O.

EtherNet/IP Link Speeds

The controller supports 10 Mbps/100 Mbps/1 Gbps EtherNet/IP link speeds.

Network performance in the controller system is optimal if the 1 Gbps link speed is used. However, legacy Ethernet devices do not support the 1 Gbps link speed. Instead, they support a maximum rate of 100 Mbps.

The difference in maximum link speeds impacts your controller system and, in some applications, restricts you from using the 1 Gbps link speeds on a controller.

When you design a controller system and consider using the 1 Gbps rate on the controller, remember the following:

- You can use the 1 Gbps link speed on the controller port when all network devices support 1 Gbps, for example, 5069-AEN2TR adapters with COMPACT 5000™ I/O modules.

When switches are used in a star topology, configure the controller ports to use Auto Negotiate.

Figure 7 - 1 Gb EtherNet/IP Network Example

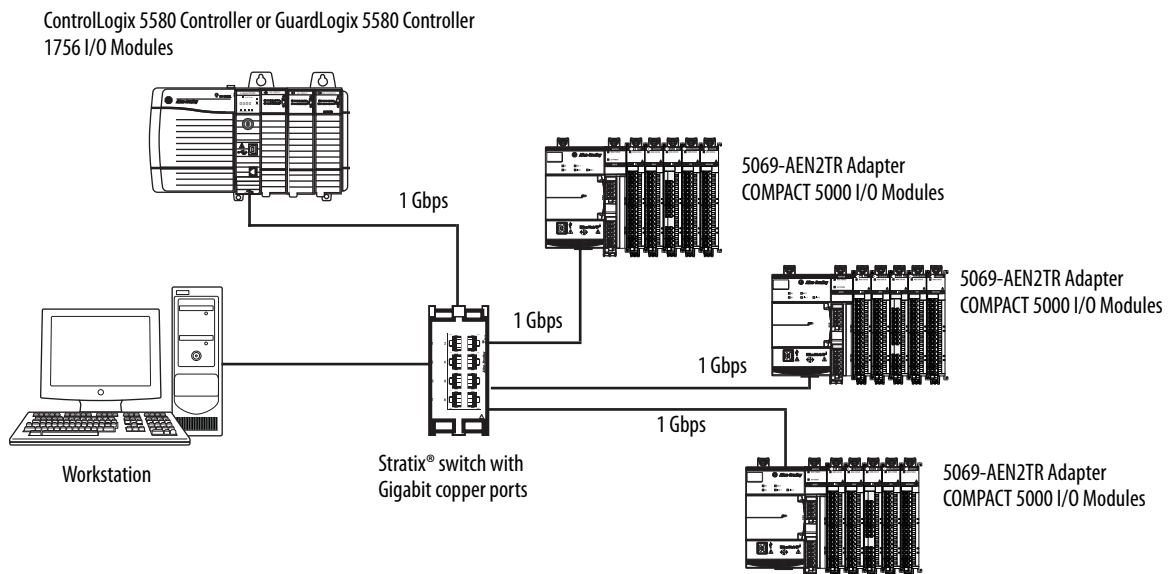

- You can use the 1 Gbps link speed on the controller port when some network devices support a maximum link speed of 100 Mbps. However, the controller must be connected to those devices through a managed switch.

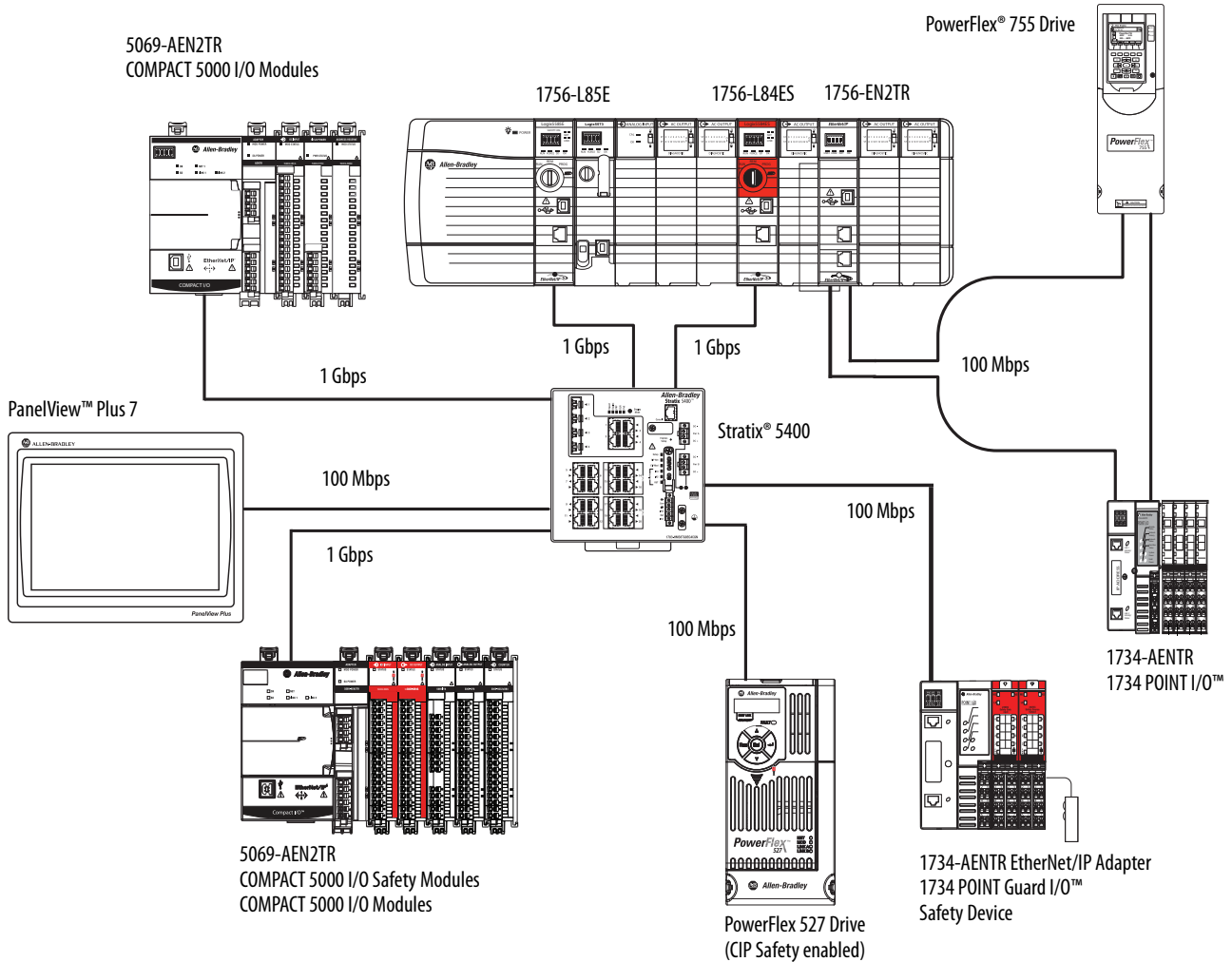

- Do not mix 1 Gbps and 100 Mbps link speeds within a single DLR ring or linear network.

IMPORTANT Do not use different link speeds on device ports in the same EtherNet/IP network without a managed switch.

If you use two or more of these components **with a legacy Ethernet device in a ring or linear topology**, set all devices to a fixed speed of 100 Mbps and full duplex:

- ControlLogix 5580/GuardLogix 5580 Controllers
- CompactLogix™ 5380 Controllers
- 5069 communication adapters
- 5094 communication adapters

This can help prevent bursts of traffic, and DLR traffic reversal due to a ring break, from causing issues.

Figure 8 - 100 Mbps EtherNet/IP Network Example With An Unmanaged Switch

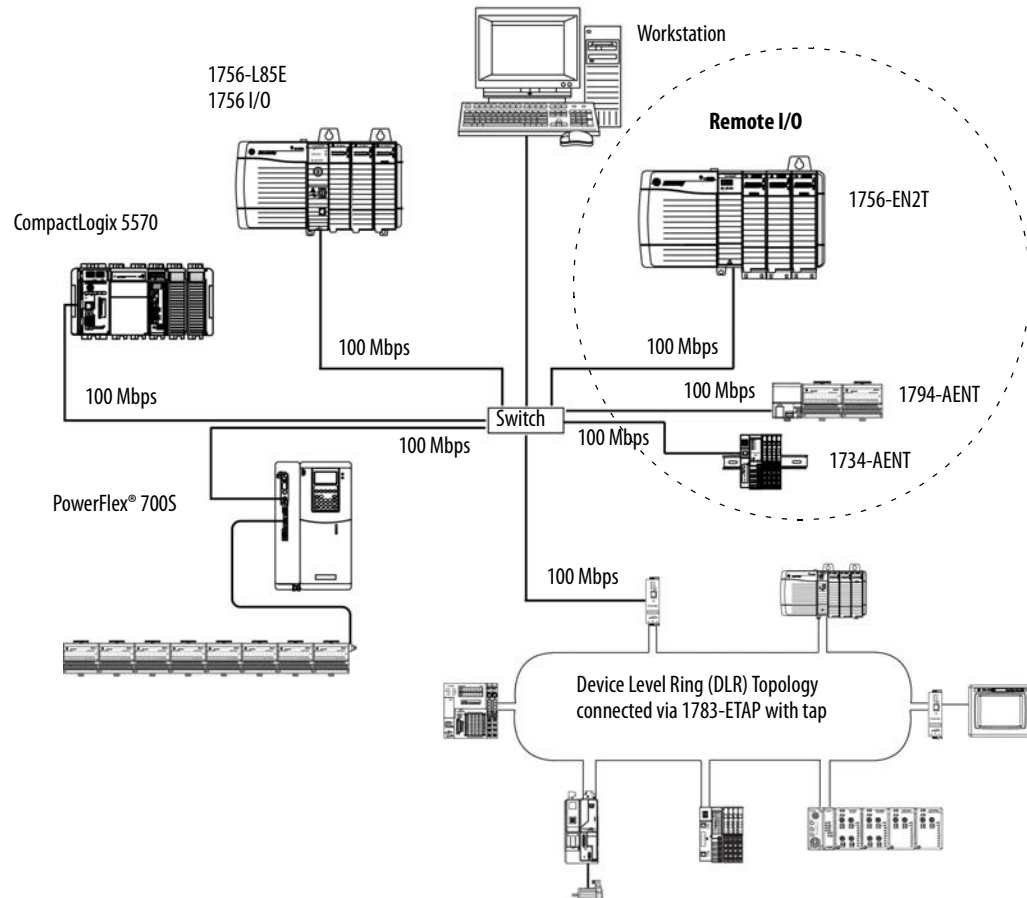

EtherNet/IP Communication Modules

For EtherNet/IP network communication, you have several modules to choose from. [Table 5](#) lists modules and their primary features.

For more information, see the 1756 ControlLogix Communication Modules Specifications Technical Data, publication [1756-TD003](#).

Table 5 - EtherNet/IP Communication Modules

Module	Is used to
1756-L81E, 1756-L81EK ⁽¹⁾ , 1756-L81ES, 1756-L81ESK, 1756-L82E, 1756-L82EK, 1756-L82ES, 1756-L82ESK, 1756-L83E, 1756-L83EK, 1756-L83ES, 1756-L83ESK, 1756-L84E, 1756-L84EK, 1756-L84ES, 1756-L84ESK, 1756-L85E, 1756-L85EK	<ul style="list-style-type: none"> • Directly connect the controller to an EtherNet/IP network without requiring a bridge module. • Connect the controller with I/O modules. • Communicate with other EtherNet/IP devices (messages, produced/consumed tags). • Bridge messages between EtherNet/IP and modules in the ControlLogix chassis. • Support 10 Mbps, 100 Mbps, 1 Gbps link speeds.
1756-ENBT, 1756-ENBTK	<ul style="list-style-type: none"> • Connect controllers to I/O modules (requires an adapter for distributed I/O). • Communicate with other EtherNet/IP devices (messages). • Serve as a pathway to share data between Logix 5000™ series controllers (produce/consume). • Bridge EtherNet/IP nodes to route messages to devices on other networks. • Support 10 Mbps and 100 Mbps link speeds.
1756-EN2T, 1756-EN2TK	<ul style="list-style-type: none"> • Perform the same functions as a 1756-ENBT module, with twice the capacity for more demanding applications. • Provide a temporary configuration connection via the USB port. • Configure IP addresses quickly by using rotary switches. • Contains all the functionality of the 1756-EWEB module, but has a higher PPS limit.
1756-EN2F, 1756-EN2FK	<ul style="list-style-type: none"> • Perform the same functions as a 1756-EN2T module. • Connect fiber media by an LC fiber connector on the module.
1756-EN2TP, 1756-EN2TPK	<ul style="list-style-type: none"> • Perform the same functions as a 1756-EN2T module. • Support for Parallel Redundancy Protocol.
1756-EN2TR, 1756-EN2TRK	<ul style="list-style-type: none"> • Perform the same functions as a 1756-EN2T module. • Support communication on a ring topology for a Device Level Ring (DLR) single-fault tolerant ring network. • Also supports a linear topology.
1756-EN2TRXT	<ul style="list-style-type: none"> • Perform the same functions as a 1756-EN2T module. • Support communication on a ring topology for a Device Level Ring (DLR) single-fault tolerant ring network. • Operate in extreme environments with -25...70 °C (-13...158 °F) temperatures.
1756-EN3TR, 1756-EN3TRK	<ul style="list-style-type: none"> • Perform the same functions as the 1756-EN2TR module. • Extended Integrated Motion on EtherNet/IP network. • Support of up to 128 motion axes.
1756-EN2TSC	<ul style="list-style-type: none"> • Perform the same functions as a 1756-ENBT module, with twice the capacity for more demanding applications. • Support for secure access to a control system from within the plant network. • Provide a temporary configuration connection via the USB port. • Configure IP addresses quickly by using rotary switches.
1756-EN2TXT	<ul style="list-style-type: none"> • Perform the same functions as a 1756-EN2T module. • Operate in extreme environments with -25...70 °C (-13...158 °F) temperatures.
1756-EWEB, 1756-EWEBK	<ul style="list-style-type: none"> • Provide customizable web pages for external access to controller information. • Provide remote access via an Internet browser to tags in a local ControlLogix controller. • Communicate with other EtherNet/IP devices (messages). • Bridge EtherNet/IP nodes to route messages to devices on other networks. • Support Ethernet devices that are not EtherNet/IP-based with a socket interface. • Support 10 Mbps and 100 Mbps link speeds. <p>This module does not provide support for I/O or produced/consumed tags. This module does not support CIP safety.</p>

(1) Catalog numbers followed by a "K" indicate a conformal coating option.

Software for EtherNet/IP Networks

[Table 6](#) lists software that is used with the EtherNet/IP networks and modules.

Table 6 - Software for Use with EtherNet/IP Networks

Software	Is used to	Required or Optional
Studio 5000 Logix Designer	<ul style="list-style-type: none"> Configure controller projects. Define EtherNet/IP communication. 	Required
Linux-based communication software	<ul style="list-style-type: none"> Configure communication devices. Provide diagnostics. Establish communication between devices. 	Required
BOOTP/DHCP Utility	<ul style="list-style-type: none"> Assign IP addresses to the controller and devices on an EtherNet/IP network. 	Optional
RSNetWorx™ for EtherNet/IP	<ul style="list-style-type: none"> Configure EtherNet/IP devices by IP addresses and/or host names. Provide bandwidth status. 	

Double Data Rate (DDR) Backplane Communication for ControlLogix Controllers

The controllers provides double data rate capabilities across the ControlLogix backplane.

The following communication modules support DDR when used with the controllers. Minimum series are indicated as follows:

- 1756-EN2T/C, 1756-EN2TK/C
- 1756-EN2TF/B, 1756-EN2TFK/B
- 1756-EN2TP/A, 1756-EN2TPK/A
- 1756-EN2TR/B, 1756-EN2TRK/B
- 1756-EN2TXT/C
- 1756-EN3TR/A, 1756-EN3TRK/A

For efficient DDR communication, make sure that all modules in the communication path are DDR modules.

If the chassis has a mix of DDR and non-DDR modules, then the DDR communication occurs between the modules that support it. Communication between the non-DDR modules in the chassis occurs at the non-DDR rate.

When multicast communication is used within a chassis that has a mix of DDR and non-DDR modules, then the transmission rate is limited to the slowest module—or at the non-DDR rate.

ControlNet Network Communication

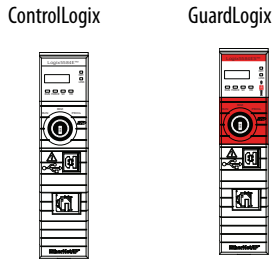

The ControlNet network is a real-time control network that provides high-speed transport of time-critical I/O and interlocking data and messaging data. This includes the upload and download of program and configuration data on one physical-media link.

The ControlNet network is highly deterministic and repeatable and is unaffected when devices are connected or disconnected from the network. This quality results in dependable, synchronized, and coordinated real-time performance.

The ControlNet network often functions as the following:

- A substitute/replacement for the remote I/O (RIO) network because the ControlNet network adeptly handles large numbers of I/O points
- A backbone for multiple distributed DeviceNet networks
- A peer interlocking network

In the example in [Figure 9](#), these actions occur via the ControlNet network:

- The controllers produce and consume tags.
- The controllers initiate MSG instructions that do the following:
 - Send and receive data.
 - Configure devices.
- The workstation is used to do the following:
 - Configure the ControlNet devices and the ControlNet network.
 - Download and upload projects from the controllers.

Figure 9 - ControlNet Network Overview

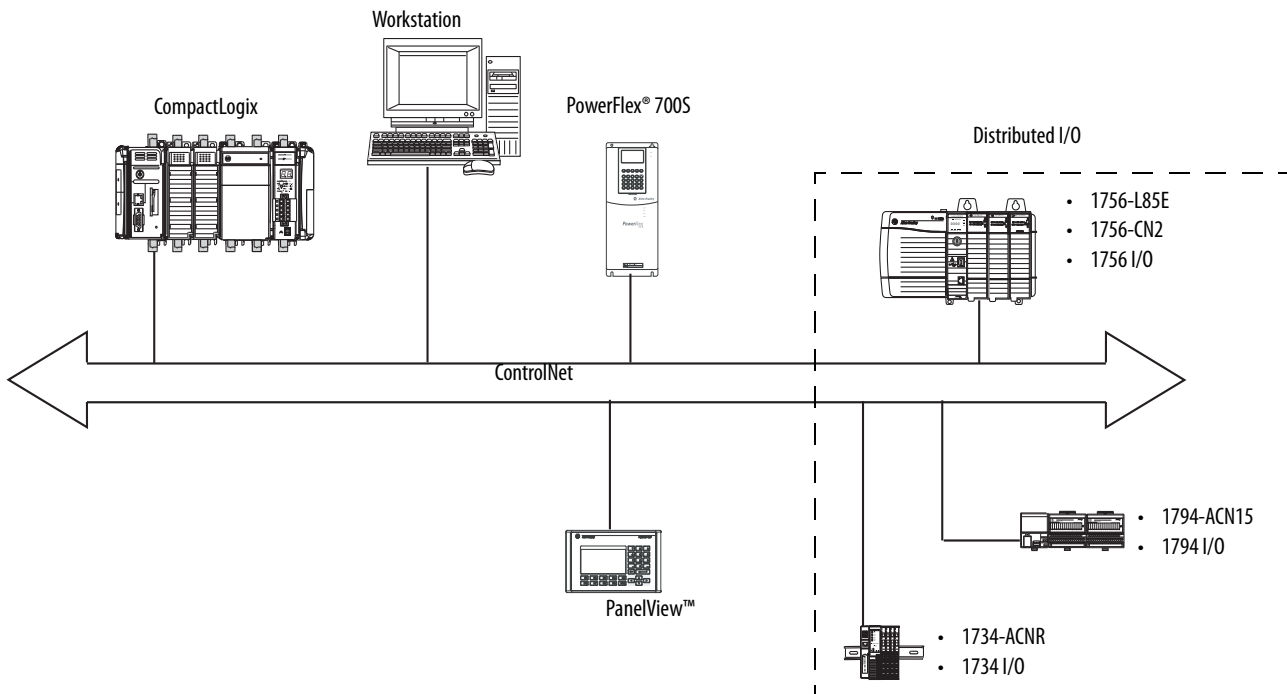

GuardLogix ControlNet Example

The ControlNet communication modules provide the following:

- Support for messaging, produced/consumed safety and standard tags, and distributed standard I/O
- Support the use of coax and fiber repeaters for isolation and increased distance.

This example illustrates the following:

- GuardLogix controllers can produce and consume standard or safety tags between each other.
- GuardLogix controllers can initiate MSG instructions that send/receive standard data or configure devices. GuardLogix controllers do not support MSG instructions for safety data.
- The 1756-CN2 module can be used as a bridge, letting the GuardLogix controller produce and consume standard and safety data to and from I/O devices.

Figure 10 - ControlNet Communication Example

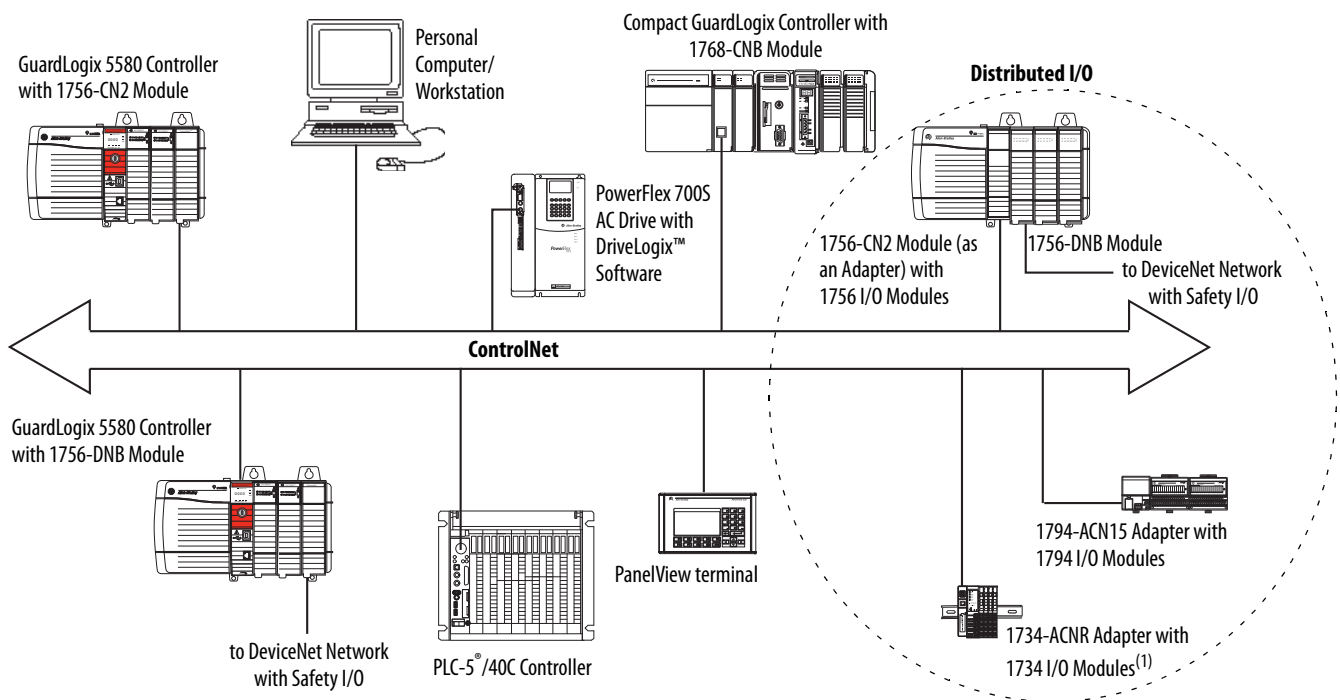

(1) The 1734-ACN adapter does not support POINT Guard Safety I/O modules.

ControlNet Modules

[Table 7](#) lists the available ControlNet modules and their primary features.

Table 7 - ControlLogix ControlNet modules

Module	System	Is used to
1756-CNB, 1756-CNBK	ControlLogix	<ul style="list-style-type: none"> Control I/O modules. Communicate with other ControlNet devices (messages). Share data with other Logix 5000 series controllers (produce/consume). Bridge ControlNet links to route messages to devices on other networks. Standard connections only.
1756-CN2, 1756-CN2K	ControlLogix GuardLogix	<ul style="list-style-type: none"> Perform the same functions as a 1756-CNB module. Provide twice the capacity for more demanding applications.
1756-CN2R, 1756-CN2RK	ControlLogix GuardLogix	<ul style="list-style-type: none"> Perform the same functions as a 1756-CN2 module. Support redundant ControlNet media.
1756-CN2RXT	ControlLogix GuardLogix	<ul style="list-style-type: none"> Perform same functions as a 1756-CN2R module. Operate in extreme environments with -25...70 °C (-13...158 °F) temperatures.
1756-CNBR, 1756-CNBRK	ControlLogix	<ul style="list-style-type: none"> Perform the same functions as a 1756-CNB module. Support redundant ControlNet media. Standard connections only.

For more information about using ControlNet modules, see ControlNet Modules in Logix5000 Control Systems User Manual, publication [CNET-UM001](#).

Software for ControlNet Networks

[Table 8](#) lists software that is used with the ControlNet networks and modules.

Table 8 - Software for Use with ControlNet Networks

Software	Is used to	Required or Optional
Studio 5000 Logix Designer	<ul style="list-style-type: none"> Configure ControlLogix projects. Define ControlNet communication. 	Required
RSNetWorx for ControlNet	<ul style="list-style-type: none"> Configure ControlNet devices. Schedule a network. 	
Linux-based communication software	<ul style="list-style-type: none"> Configure communication devices. Provide diagnostics. Establish communication between devices. 	

DeviceNet Network Communication

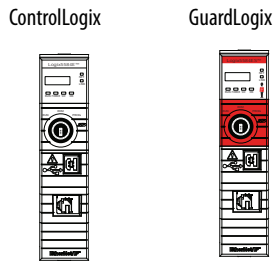

The DeviceNet network uses the Common Industrial Protocol (CIP) to provide the control, configuration, and data collection capabilities for industrial devices. The DeviceNet network uses the proven Controller Area Network (CAN) technology, which lowers installation costs and decreases installation time and costly downtime.

A DeviceNet network provides access to the intelligence present in your devices by letting you connect devices directly to plant-floor controllers without having to hard-wire each device into an I/O module.

Figure 11 - ControlLogix DeviceNet Network Overview

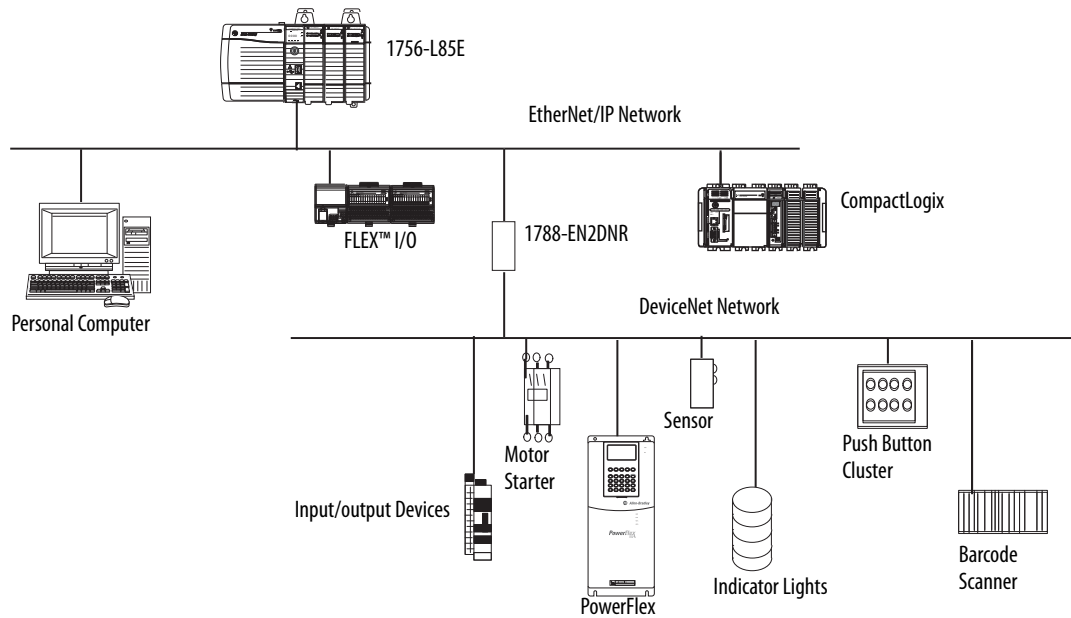

In this example, the ControlLogix controller is connected to the DeviceNet network and devices via the 1788-EN2DNR linking device.

For more information about using DeviceNet modules and devices, see DeviceNet Modules in Logix5000 Control Systems User Manual, publication [DNET-UM004](#).

DeviceNet Bridge Module and Linking Devices

[Table 9](#) lists the available DeviceNet bridge and linking devices that can be used with the DeviceNet network.

Table 9 - DeviceNet Communication Modules and Capabilities

Module/Device	System	Is used to
1756-DNB, 1756-DNBK	ControlLogix GuardLogix	<ul style="list-style-type: none"> Control I/O modules. Communicate with other DeviceNet devices (via messages).
1788-EN2DNR	ControlLogix	Link an EtherNet/IP network to a DeviceNet network.
1788-CN2DN	ControlLogix	Link a ControlNet network to a DeviceNet network.

Software for DeviceNet Networks

[Table 10](#) lists software that is used with the DeviceNet networks and modules.

Table 10 - Software for Use with DeviceNet Networks

Software	Is used to	Required or Optional
Studio 5000 Logix Designer	<ul style="list-style-type: none"> Configure ControlLogix projects. Define DeviceNet communication. 	Required
RSNetWorx for DeviceNet	<ul style="list-style-type: none"> Configure DeviceNet devices. Define the scan list for those devices. 	
Linux-based communication software	<ul style="list-style-type: none"> Configure communication devices. Provide diagnostics. Establish communication between devices. 	

Connections Over DeviceNet Networks

The ControlLogix controller requires two connections for each 1756-DNB module. One connection is for module status and configuration. The other connection is a rack-optimized connection for the device data.

DeviceNet Module Memory

The 1756-DNB module has fixed sections of memory for the input and output data of the DeviceNet devices on the network. Each device on your network requires some input or output memory of the scanner. Some devices send and receive data, so they need input and output memory. The 1756-DNB module supports up to the following:

- 124 DINTs of input data
- 123 DINTs of output data

Data Highway Plus (DH+) Network Communication

ControlLogix



For DH+™ network communication, you have two module options for use in the ControlLogix chassis. [Table 11](#) lists the DH+ modules and capabilities.

Table 11 - DH+ Modules and Capabilities

RIO Module	Is used to
1756-DHRIO, 1756-DHRIOK	<ul style="list-style-type: none"> Function as a remote I/O (RIO) scanner. Support 32 logical rack connections or 16 block transfer connections per channel. Establish connections between controllers and I/O adapters. Distribute control so that each controller has its own I/O. Use for standard communications only.
1756-DHRIOXT	<ul style="list-style-type: none"> Performs the same functions as a 1756-DHRIO module. Operates in extreme environments with -25...70 °C (-13...158 °F) temperatures. Use for standard communications only.

For DH+ network communication, use a 1756-DHRIO or 1756-DHRIOXT module in the ControlLogix chassis to exchange information between these controllers:

- PLC and SLC™ controllers
- ControlLogix controllers and PLC or SLC controllers
- ControlLogix controllers

You can connect a maximum of 32 stations to one DH+ link:

- Channel A supports 57.6 Kbps, 115.2 Kbps, and 230.4 Kbps.
- Channel B supports 57.6 Kbps and 115.2 Kbps.

Figure 12 - ControlLogix DH+ Network Communication Example

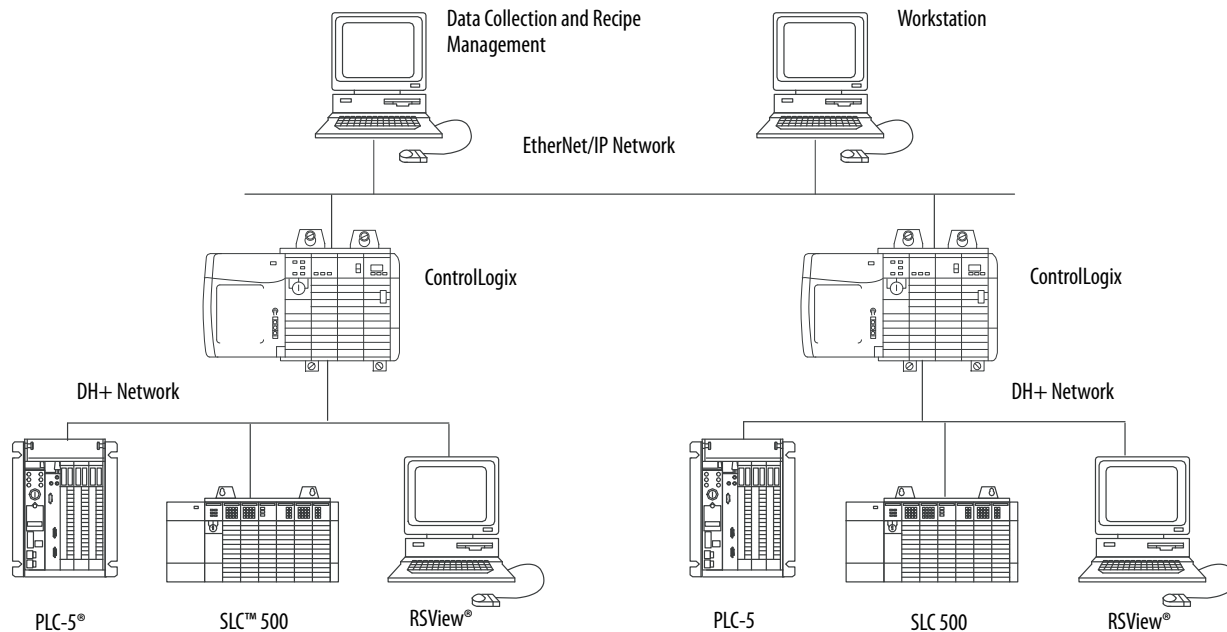

Communicate Over a DH+ Network

For the controller to communicate to a workstation or other device over a DH+ network, use Linx-based communication software to do the following:

- Specify a unique link ID for each ControlLogix backplane and additional network in the communication path.
- Configure the routing table for the 1756-DHRIO or 1756-DHRIOXT module.

The 1756-DHRIO or 1756-DHRIOXT module can route a message through up to four communication networks and three chassis. This limit applies only to the routing of a message and not to the total number of networks or chassis in a system.

For more information to configure and use a DH+ network via the 1756-DHRIO or 1756-DHRIOXT module, see the Data Highway Plus-Remote I/O Communication Interface Module User Manual, publication [1756-UM514](#).

Universal Remote I/O (RIO) Communication

ControlLogix



For universal remote I/O communication, you have three module options for use in the ControlLogix chassis. [Table 12](#) lists the RIO modules and capabilities.

Table 12 - RIO Modules and Capabilities

RIO Module	Is used to
1756-RIO, 1756-RIOK	<ul style="list-style-type: none"> Function as an RIO scanner and adapter. Support connections to 32 racks in any combination of rack size or block transfers. Update data to the ControlLogix controller by using scheduled connections. Use for standard communications only.
1756-DHRIO, 1756-DHRIOK	<ul style="list-style-type: none"> Function as an RIO scanner. Support 32 logical rack connections or 16 block transfer connections per channel. Establish connections between controllers and I/O adapters. Distribute control so that each controller has its own I/O. Use for standard communications only.
1756-DHRIOXT	<ul style="list-style-type: none"> Performs the same functions as a 1756-DHRIO module. Operates in extreme environments with -25...+70 °C (-13...+158 °F) temperatures. Use for standard communications only.

When a channel on the 1756-DHRIO or 1756-DHRIOXT module is configured for remote I/O, the module acts as a scanner for a universal remote I/O network. The controller communicates to the module to send and receive the I/O data on the universal remote I/O network.

The 1756-RIO module can act as a scanner or adapter on a remote I/O network. The 1756-RIO module transfers digital, block transfer, analog, and specialty data without message instructions.

Figure 13 - ControlLogix Universal Remote I/O Communication Example

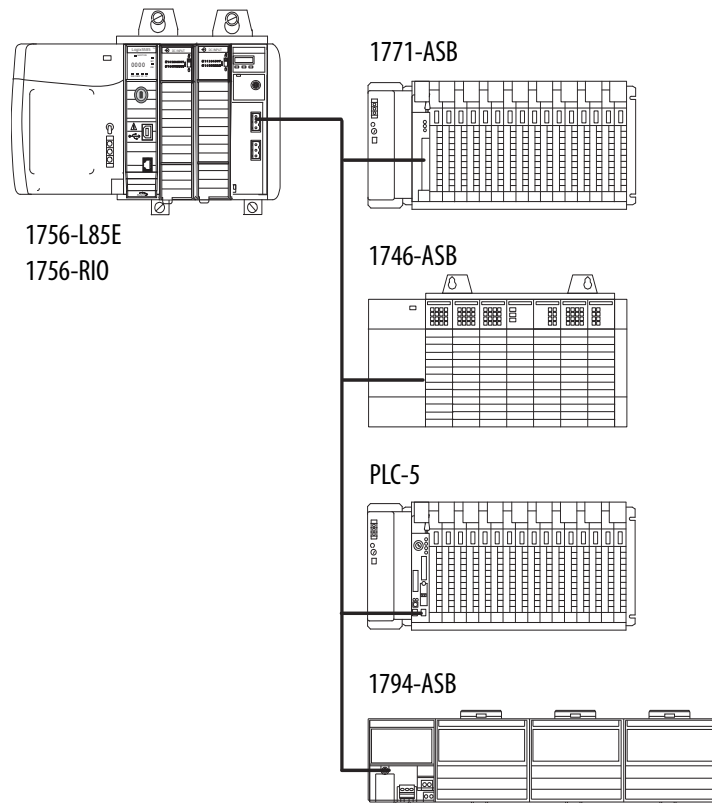

Communicate Over a Universal Remote I/O Network

For the controller to control I/O over a universal remote I/O network, you must complete these tasks.

1. Configure the remote I/O adapter.
2. Lay out the remote I/O network cable.
3. Connect the remote I/O network cable.
4. Configure the scanner channel.

For more information to configure a remote I/O network with the 1756-RIO, 1756-DHRIO, or 1756-DHRIOXT modules, see these publications:

- Data Highway Plus-Remote I/O Communication Interface Module User Manual, publication [1756-UM514](#)
- ControlLogix Remote I/O Communication Module User Manual, publication [1756-UM534](#)

As you design your remote I/O network, remember the following:

- All devices that are connected to a remote I/O network must communicate by using the same communication rate. These rates are available for remote I/O:
 - 57.6 Kbps
 - 115.2 Kbps
 - 230.4 Kbps
- You must assign unique partial and full racks to each channel used in Remote I/O Scanner mode.

Both channels of a 1756-DHRIO or 1756-DHRIOXT module cannot scan the same partial or full rack address. Both module channels can communicate to 00...37 octal or 40...77 octal, but each channel can communicate only with one address at a time in whichever of these two ranges it falls.

Foundation Fieldbus Communication

ControlLogix



Foundation Fieldbus is an open interoperable fieldbus that is designed for process control instrumentation. The Foundation Fieldbus devices that are described in [Table 13](#) can be connected to the ControlLogix controller via another network as shown in the following example.

Table 13 - Foundation Fieldbus Devices and Capabilities

Fieldbus Device	Is used to
1788-EN2FFR	<ul style="list-style-type: none"> • Bridge an EtherNet/IP network to Foundation Fieldbus. • Connect via a low-speed serial (H1) and high-speed Ethernet (HSE) network connections. • Access devices directly via an OPC server. • Use for standard communications only.
1788-CN2FFR	<ul style="list-style-type: none"> • Connect via low-speed serial (H1) connections. • Bridge a ControlNet network to a Foundation Fieldbus. • Support redundant ControlNet media. • Use for standard communications only.

Foundation Fieldbus distributes and executes control in the device. The Foundation Fieldbus linking device does the following:

- Bridges from an EtherNet/IP network to an H1 connection
- Accepts HSE or EtherNet/IP messages and converts them to the H1 protocol

Figure 14 - Foundation Fieldbus Example

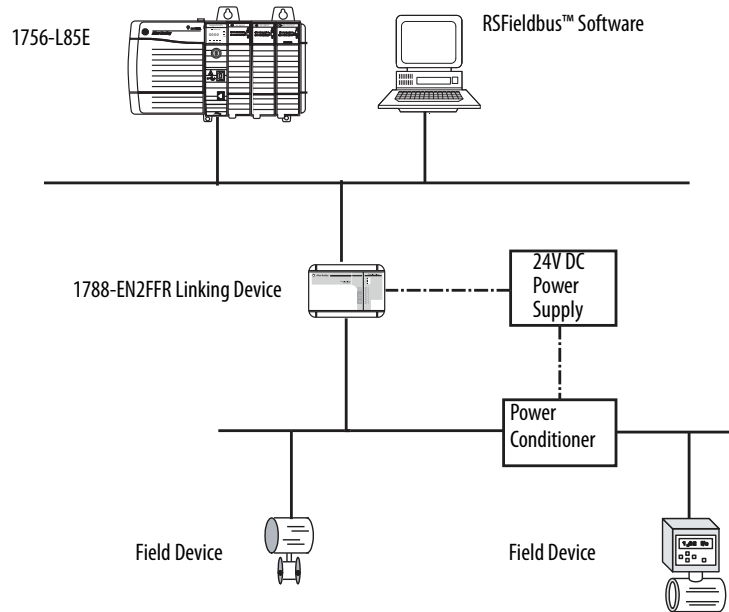

For more information about using the Foundation Fieldbus devices available from Rockwell Automation, see these publications:

- EtherNet/IP and ControlNet to FOUNDATION Fieldbus Linking Device User Manual, publication [1788-UM057](#)
- FOUNDATION Fieldbus Design Considerations Reference Manual, publication [PROCES-RM005](#)

HART Communication

ControlLogix



HART (Highway Addressable Remote Transducer) is an open protocol that is designed for process control instrumentation.

Device	Is used to
1756 analog HART I/O modules: 1756-IF8H, 1756-IF8HK 1756-IF8IH 1756-IF16H, 1756-IF16HK 1756-IF16IH 1756-OF8H, 1756-OF8HK 1756-OF8IH	<ul style="list-style-type: none"> • Act as HART master to allow communication with HART field devices. • Interface directly with field devices (through built-in HART modems), which mitigates the need for external hardware and more wiring. • Provide access to more field device data, including voltage and current measurements. • Directly connect asset management software to HART devices. • Support differential wiring for environments where improved noise immunity is needed (input modules). • Use for standard communications only.
ProSoft interface MVI56-HART	<ul style="list-style-type: none"> • Acquire data or control applications with slow update requirements, such as a tank farm. • Does not require external hardware to access HART signal. • Does not provide a direct connection to asset management software. • Use for standard communications only.

The HART protocol combines digital signals with analog signals to ready the digital signal for the Process Variable (PV). The HART protocol also provides diagnostic data from the transmitter.

Figure 15 - HART Protocol Example

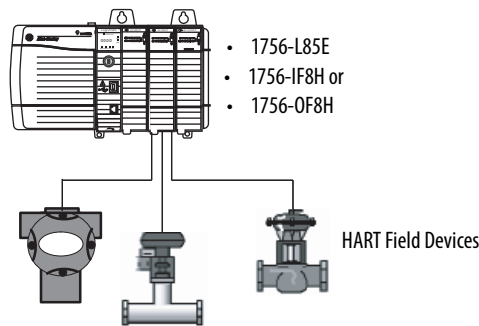

For more information about using the HART I/O modules, see the ControlLogix HART Analog I/O Modules User Manual, publication [1756-UM533](#).

For more information about the ProSoft HART interface, see the ProSoft Technologies website at <http://www.prosoft-technology.com>.

ControlLogix



GuardLogix



Connect to a Controller

Topic	Page
Configure EtherNet/IP and USB Drivers on Your Workstation	50
Connection Options	55
Update Controller Firmware	63

You connect to a controller through Linx-based software. To use Linx-based software, you must use a communication driver that corresponds to the cable connections.

For example, before you can connect to the controller via an Ethernet cable, you must create an EtherNet/IP driver through Linx-based software.

TIP The example procedures in this chapter use RSLinx® Classic. For other Linx-based communication software, the procedure may slightly differ. See the online help for your Linx-based software.

A communication driver is required to complete the following tasks:

- Upload and download Studio 5000 Logix Designer® application projects
- Update controller firmware
- Set or change the controller IP address
- Collect controller data for electronic operator interfaces over an Ethernet network
- Connect RSNetWorx™ for EtherNet/IP to the Ethernet network for online monitoring of network resource utilization.

Configure EtherNet/IP and USB Drivers on Your Workstation

Before you can connect to the controller through the EtherNet/IP or USB port, you must configure the EtherNet/IP or USB driver in Linx-based software on your workstation.

A workstation running Studio 5000 Logix Designer programming software can use either the EtherNet/IP or USB communication driver.

- EtherNet/IP driver:
 - Supports runtime communications.
 - Supports communications over longer distances when compared to the USB driver.
 - Requires that the workstation and controller IP addresses and other network parameters are configured correctly.
- USB driver:
 - Convenient method to connect to an unconfigured controller, so that you can configure the Ethernet port on the controller.
 - Convenient method to connect to a controller when the Ethernet port configuration is unknown.
 - Convenient method to update the controller firmware.
 - Not intended for run-time connections; it is a temporary-use only connection with a limited cabling distance.

Configure the EtherNet/IP Communication Driver in RSLinx Classic Software

Before you add a driver, confirm that these conditions exist:

- The workstation is properly connected to the Ethernet network.
- The IP address and other network parameters are correctly configured for the workstation.

To configure the EtherNet/IP driver, follow these steps.

1. From the Communications menu, choose Configure Drivers.

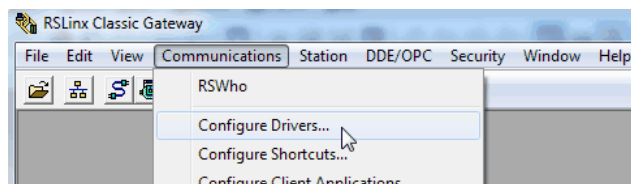

The Configure Drivers dialog box appears.

2. From the Available Driver Types pull-down menu, choose EtherNet/IP Driver.
3. Click Add New.

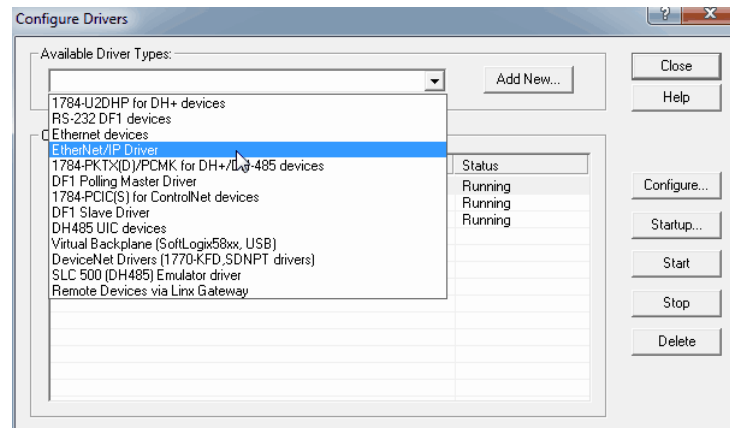

The Add New RSLinx Driver dialog box appears.

4. Type a name for the new driver and click OK.

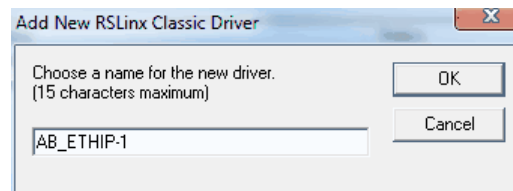

The Configure driver dialog box appears.

5. Click Browse Local Subnet.

TIP To view devices on another subnet or VLAN from the workstation running Linx-based communication software, click Browse Remote Subnet.

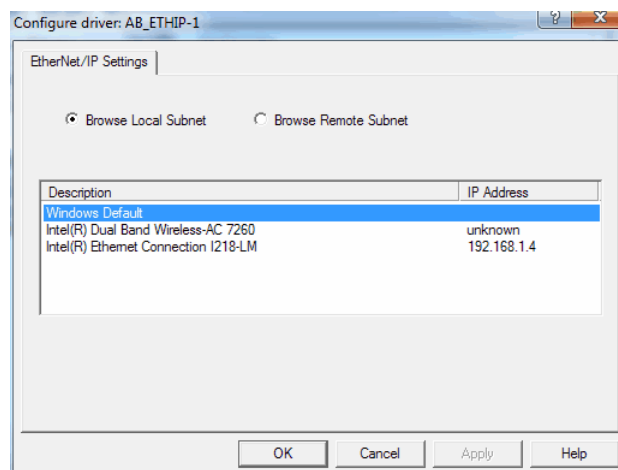

6. Select the Driver that you want to use.

7. Click OK to close the dialog box.

The new driver is available.

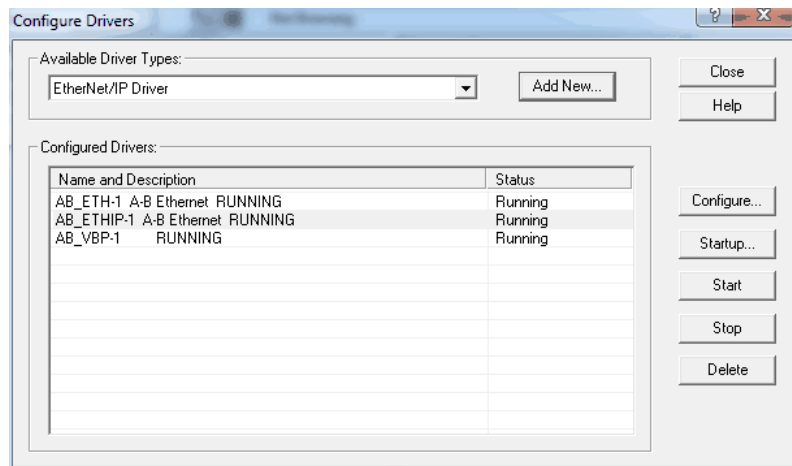

8. On the Configure Drivers dialog box, click Close.

Configure the USB Communication Driver in RSLinx Classic Software

In RSLinx Classic software, version 3.80.00 or later, a USB driver automatically appears in the software when you connect the USB cable from your workstation to the controller.

The USB driver can take a moment to appear in RSLinx Classic software.

IMPORTANT The USB driver appears in RSLinx Classic software only when a USB cable is connected between the workstation and the controller.

Once the cable is disconnected, the driver disappears from RSLinx Classic software.

If you use the RSLinx Classic software, version 3.80.00 or later, and a USB driver does not appear automatically, you can complete the following steps.

1. Connect your controller and workstation by using a USB cable.

The Found New Hardware Wizard dialog box appears.



2. Click any of the Windows Update connection options and click Next.

TIP If the software for the USB driver is not found and the installation is canceled, verify that you have installed RSLinx Classic software, version 3.80 or later.

3. Click Install the software automatically (Recommended) and click Next.

The software is installed.

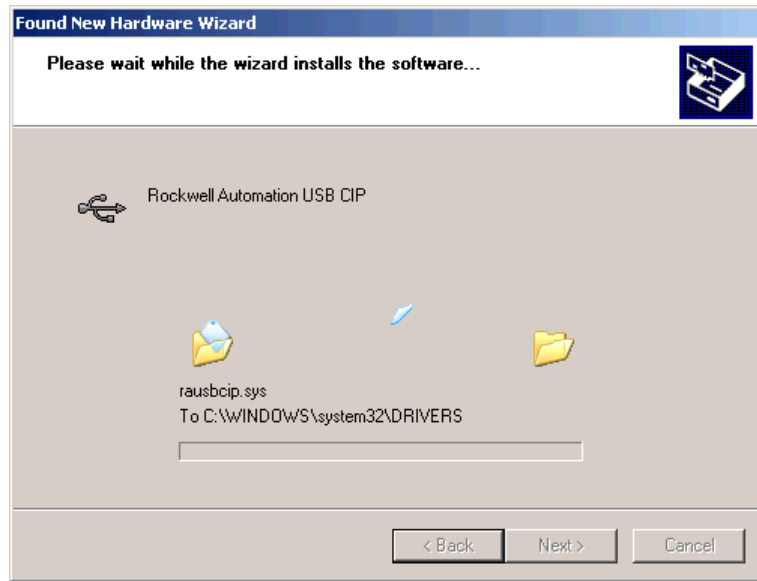

4. Click Finish to configure your USB driver.

To browse to your controller in RSLinx software, click the RSWho icon.



The RSLinx Workstation organizer appears.

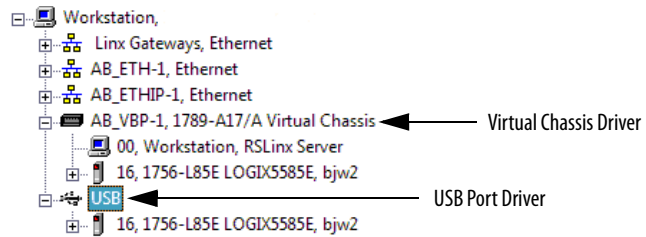

Your controller appears under two drivers, a virtual chassis and the USB port. You can use either driver to browse to your controller.

Connection Options

ControlLogix



GuardLogix



Before you can begin using your controller, you must make a connection to the controller. Make sure you have already configured the EtherNet/IP or USB communication drivers (see [Configure EtherNet/IP and USB Drivers on Your Workstation on page 50](#))

Connection options with the controller include the following:

- The controller has an Ethernet port that supports 10 Mbps, 100 Mbps, or 1 Gbps. See [Connect to an EtherNet/IP Network on page 55](#).
- The controller has a USB port that uses a Type B receptacle. The port is USB 2.0 compatible and runs at 12 Mbps. See [Connect a USB Cable on page 62](#).
- Install and configure a communication module in the chassis with the controller as described in the installation instructions for the communication module.

Connect to an EtherNet/IP Network



WARNING: If you connect or disconnect the communications cable with power applied to this module or any device on the network, an electrical arc can occur. This could cause an explosion in hazardous location installations. Be sure that power is removed or the area is nonhazardous before proceeding.

If you are connecting the controller directly to an EtherNet/IP network, then connect a CAT 5e or CAT 6 Ethernet cable with an RJ45 connector to the Ethernet port on the controller.

For information on how to select the proper cable, see Guidance for Selecting Cables for EtherNet/IP Networks, publication [ENET-WP007-EN-P](#).

Determine Network Parameters

To operate an EtherNet/IP network, you must define these parameters.

EtherNet/IP Network Parameter	Description
IP address	The IP address uniquely identifies the module. The IP address is in the form <i>xxx.xxx.xxx.xxx</i> where each <i>xxx</i> is a number from 000 . . . 255. There are some reserved values that you cannot use as the first octet in the address. These numbers are examples of values you cannot use: <ul style="list-style-type: none"> • 001 .xxx.xxx.xxx • 127 .xxx.xxx.xxx • 223 to 255 .xxx.xxx.xxx The specific reserved values that cannot be used vary according to the conditions of each application. The previous values are only examples of reserved values.
Subnet mask	The subnet mask divides IP addresses into a network address and a host address. It defines whether the controller exchanges Ethernet packets directly with another device, or whether it routes packets through the Gateway. This field is set to 0.0.0.0 by default.
Gateway	A gateway connects individual physical networks into a system of networks. When a node communicates with a node on another network, a gateway transfers the data between the two networks. This field is set to 0.0.0.0 by default.

If you use DNS addressing, or reference the controller via host name in MSG instructions, define these parameters.

Table 14 - EtherNet/IP Network Parameters for DNS Addressing

EtherNet/IP Network Parameter	Description
Host name	<p>A host name is part of a text address that identifies the host for a module. The full text address of a module is <i>host_name.domain_name</i>.</p> <p>Safety Considerations Safety connections are not allowed to use host names (this requires DNS lookup, which is not allowed for Safety I/O). Safety devices on EtherNet/IP networks do not present the host name parameter. Standard devices do present the host name parameter, regardless of whether the project is safety or standard. GuardLogix 5580 controllers can have safety connections or standard connections. When used in a standard project, GuardLogix 5580 controllers are considered standard devices (the only connections are standard consumed tags), so the controller presents the host name parameter. When GuardLogix 5580 controllers are used in a safety project, it is assumed to be a safety device, and the host name parameter is not presented.</p>
Domain name	<p>A domain name is part of a text address that identifies the domain in which the module resides. The full text address of a module is <i>host_name.domain_name</i>. The domain name has a 48-character limit. If you specify a DNS server, you must type a domain name. Also, if you send email from the module, some mail relay servers require a domain name during the initial handshake of the SMTP session.</p>
Primary DNS server address	<p>An address that identifies any DNS servers that are used in the network. You must have a DNS server if you specified a domain name or a host name in the module configuration. The DNS server converts the domain name or host name to an IP address that is used by the network.</p> <p>For more information on DNS addressing, see page 61.</p>
Secondary DNS server address	

Set the Network IP Address with the BootP DHCP EtherNet/IP Commissioning Tool

The controllers are set to DHCP by default.

The BootP DHCP tool is a standalone server that you can use to set an IP address. When used, the BootP DHCP tool sets an IP address and other Transport Control Protocol (TCP) parameters.

Access the BootP DHCP tool from one of these locations:

- All Programs > Rockwell Software > BOOTP-DHCP Tool

If you have not installed the server, you can download and install it from <http://www.ab.com/networks/ethernet/bootp.html>.

- Tools directory on the Studio 5000® environment installation CD

IMPORTANT Before you start the BootP DHCP tool, make sure that you have the module hardware (MAC) address. The hardware address is on a label on the side of the controller, and uses an address in a format similar to the following:

00-00-BC-14-55-35

To set the IP address with a BootP DHCP tool, follow these steps.

1. Connect your workstation to the Ethernet network where the controller appears.
2. Start the BootP DHCP tool.

The MAC address of the controller appears in the Request History window.

3. Select the appropriate controller.

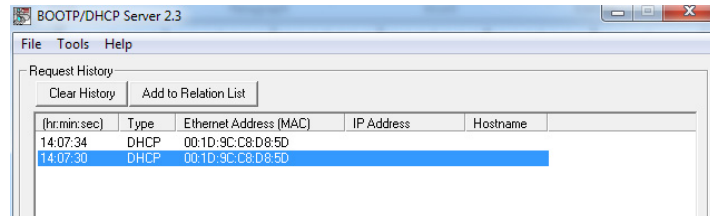

4. Click Add to Relation List.

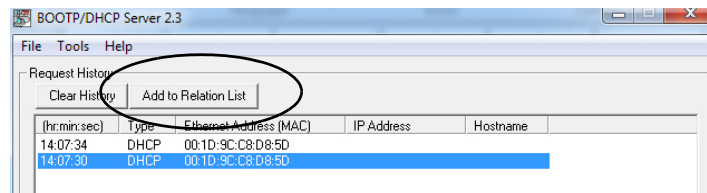

The New Entry dialog box appears.

5. Type an IP Address, Hostname, and Description for the module.

Hostname and Description are optional.

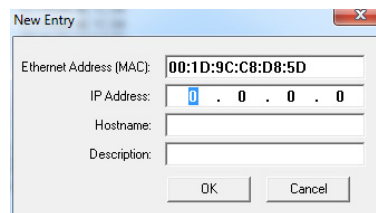

6. Click OK.
7. To assign this configuration to the module, wait for the module to appear in the Relation List panel and select it.
8. Click Disable BOOTP/DHCP.

The module now uses the assigned configuration and does not issue a BOOTP or DHCP request.

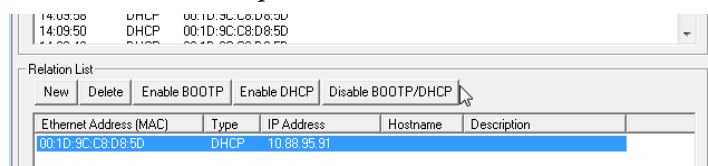

IMPORTANT Remember the following:

If you do not click Disable BOOTP/DHCP, then on a power cycle the host clears the current IP configuration and begins sending DHCP requests again.

If you click Disable BOOTP/DHCP and it does not disable BOOTP/DHCP, you can use RSLinx Classic software to disable BOOTP/DHCP.

For more information on how to use RSLinx Classic software to disable BOOTP/DHCP, see [Disable BOOTP/DHCP from RSLinx Classic Software on page 58](#).

Disable BOOTP/DHCP from RSLinx Classic Software

To disable BOOTP/DHCP from RSLinx Classic software, complete these steps.

1. Start RSLinx Classic software.

After several seconds, an RSWho dialog box appears.

2. If no RSWho dialog box appears, from the Communications pull-down menu, choose RSWho.
3. Navigate to the controller.

You can access the controller via the USB or an EtherNet/IP driver.

4. Right-click on the controller and choose Module Configuration.
5. Click the Port Configuration tab.
6. From the Network Configuration Type, click Static to disable BOOTP/DHCP.
7. Click OK.

Use a DHCP Server to Set the Controller IP Address

Because the controllers are DHCP-enabled when they are in the out-of-box condition, you can use a DHCP server to set the IP address.

The DHCP server automatically assigns IP addresses to client stations logging on to a TCP/IP network. DHCP is based on BOOTP and maintains some backward compatibility.



ATTENTION: You can use a DHCP server that is configured to always assign the same IP address to specific devices when they appear on the EtherNet/IP network and request an IP address.

If your system does not use a DHCP server that assigns the same IP address for specific devices, we strongly recommend that you assign the controller a fixed IP address. Do not set the IP address dynamically. That is, do not use the Obtain IP settings automatically by using DHCP option in RSLinx Classic software or the Logix Designer application.

When a controller uses Obtain IP settings automatically by using DHCP, the IP address for that controller is cleared with each power cycle. If the same IP address is not automatically assigned to the controller via a DHCP server, when it requests a new IP address, it can be assigned a new IP address.

The use of a new IP address can have unintended consequences. For example, a Duplicate IP Address condition can exist or the controller can experience configuration faults because the IP address differs from what is stored in the Logix Designer application project.

Failure to observe this precaution can result in unintended machine motion or loss of process control.

Duplicate IP Address Detection

The controller verifies that its IP address does not match any other network device IP address when you perform either of these tasks:

- Connect the module to a EtherNet/IP network.
- Change the controller IP address.

If the controller IP address matches that of another device on the network, the controller EtherNet/IP port transitions to Conflict mode. In Conflict mode, these conditions exist:

- Network (NET) status indicator is solid red.
- The 4-character display indicates the conflict.

The display scrolls: <IP_address_of_this_module> Duplicate IP
<Mac_address_of_duplicate_node_detected>

For example: 192.168.1.1 Duplicate IP - 00:00:BC:02:34:B4

Duplicate IP Address Resolution

When two devices on a network have IP addresses that conflict, the resolution depends on the conditions in which the duplication is detected. This table describes how duplicate IP addresses are resolved.

Duplicate IP Address Detection Conditions	Resolution Process
<ul style="list-style-type: none"> • Both devices support duplicate IP address detection. • Second device is added to the network after the first device is operating on the network. 	<ol style="list-style-type: none"> 1. The device that began operation first uses the IP address and continues to operate without interruption. 2. The device that begins operation second detects the duplication and enters Conflict mode. <p>To assign a new IP address to the controller and leave Conflict mode, see Set the Network IP Address with the BootP DHCP EtherNet/IP Commissioning Tool on page 56.</p>
<ul style="list-style-type: none"> • Both devices support duplicate IP address detection • Both devices were powered up at approximately the same time. 	<p>Both EtherNet/IP devices enter Conflict mode.</p> <p>To resolve this conflict, follow these steps:</p> <ol style="list-style-type: none"> a. Assign a new IP address to the controller. See Set the Network IP Address with the BootP DHCP EtherNet/IP Commissioning Tool on page 56. b. Cycle power to the other device.
<p>One device supports duplicate IP address detection and a second device does not</p>	<ol style="list-style-type: none"> 1. Regardless of which device obtained the IP address first, the device that does not support IP address detection uses the IP address and continues to operate without interruption. 2. The device that supports duplicate IP address detection detects the duplication and enters Conflict mode. <p>To assign a new IP address to the controller and leave Conflict mode, see Set the Network IP Address with the BootP DHCP EtherNet/IP Commissioning Tool on page 56.</p>

DNS Addressing

You can also use DNS addressing to specify a host name for a controller, a domain name, and DNS servers. DNS addressing makes it possible to configure similar network structures and IP address sequences under different domains.

DNS addressing is necessary only if you refer to the controller by host name, such as in path descriptions in MSG instructions.

To use DNS addressing, follow these steps.

1. Assign a host name to the controller.

A network administrator can assign a host name. Valid host names must be IEC-1131-3 compliant.

2. Configure the controller parameters.
3. Configure the IP address, subnet mask, gateway address, a host name for the controller, domain name, and primary/secondary DNS server addresses.

In the DNS server, the host name must match the IP address of the controller.

4. In the Logix Designer application, add the controller to the I/O configuration tree.

IMPORTANT If a child module resides in the same domain as its parent module, type the host name. If the domain of the child module differs from the domain of its parent module, type the host name and the domain name (hostname.domainname)

IMPORTANT You can also use DNS addressing in a module profile in the I/O configuration tree or in a message path. If the domain name of the destination module differs from the domain name of the source module, then use a fully qualified DNS name (hostname.domainname). For example, to send a message from EN2T1.location1.companyA to EN2T1.location2.companyA, the host names match, but the domains differ. Without the entry of a fully qualified DNS name, the module adds the default domain name to the specified host name.

Connect a USB Cable

To use the USB port of the controller, you must have Linx-based communication software installed on your workstation. Use a USB cable to connect your workstation to the USB port. With this connection, you can update firmware and download programs to the controller directly from your workstation.



ATTENTION: The USB port is intended only for temporary local programming purposes and not intended for permanent connection. The USB cable is not to exceed 3.0 m (9.84 ft) and must not contain hubs.



WARNING: Do not use the USB port in hazardous locations.

Figure 16 - USB Connection

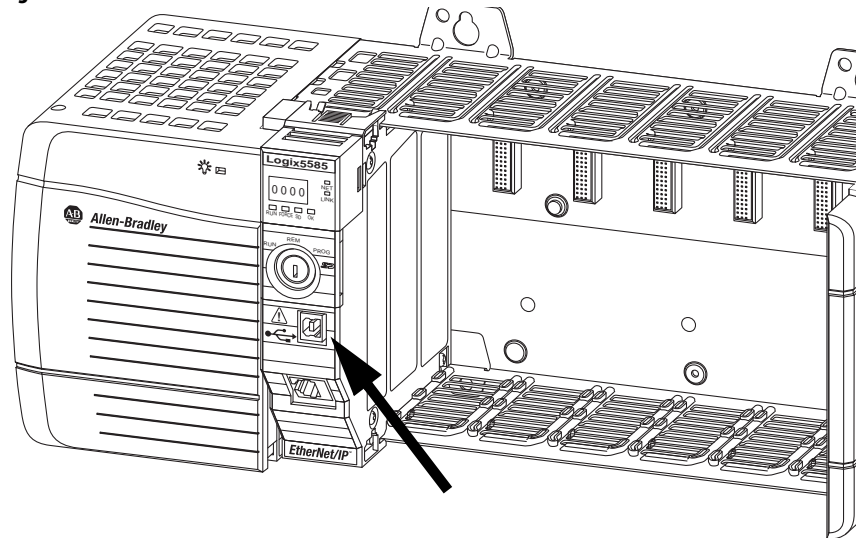

Update Controller Firmware

ControlLogix



GuardLogix



To update controller firmware, use one of these tools:

- ControlFLASH™ software
- AutoFlash feature of the Logix Designer application

IMPORTANT Safety Consideration

You cannot update a controller that is safety locked.

To update your controller firmware, complete these tasks:

- Determine Required Controller Firmware
- Obtain Controller Firmware
- Either [Use ControlFLASH Software to Update Firmware](#) or [Use AutoFlash to Update Firmware](#)

Determine Required Controller Firmware

IMPORTANT The controller must be in Remote Program or Program mode and all major recoverable faults must be cleared to accept updates.

The firmware major revision level must match the software major version level. For example, if the controller firmware revision is 31.xxx, you must use the Logix Designer application, version 31.

IMPORTANT Safety Consideration

For a GuardLogix® system that includes a Safety Partner (SIL 3/PLe only), the firmware on the primary controller and safety partner must match. When you update the firmware on the primary controller, the safety partner updates automatically.

Obtain Controller Firmware

You can obtain controller firmware in these ways:

- Firmware is packaged as part of the Studio 5000 Logix Designer environment installation.

IMPORTANT The firmware that is packaged with the software installation is the initial release of the controller firmware. Subsequent firmware revisions to address anomalies may be released during a product's life.

We recommend that you check the Product Compatibility and Download Center (PCDC) to determine if later revisions of the controller firmware are available. For more information, see the next bullet.

- From the Rockwell Automation Product Compatibility and Download Center (PCDC). You can check for available revisions of controller firmware, and download controller firmware, associated files, and product release notes.

To visit PCDC, go to <http://compatibility.rockwellautomation.com/Pages/home.aspx>.

Use ControlFLASH Software to Update Firmware

To update your controller firmware with ControlFLASH software, complete these steps.



ATTENTION: If the Secure Digital Card is locked and set to load on power-up, then this update may be overwritten by firmware on the SD card.

1. Verify that the network connection is made and the network driver has been configured in Linx-based communication software.
2. From the Windows Start Menu, click FLASH Programming Tools > ControlFLASH.

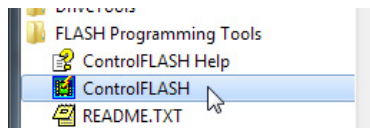

3. Click Next.



4. Select the catalog number of your controller, and click Next.

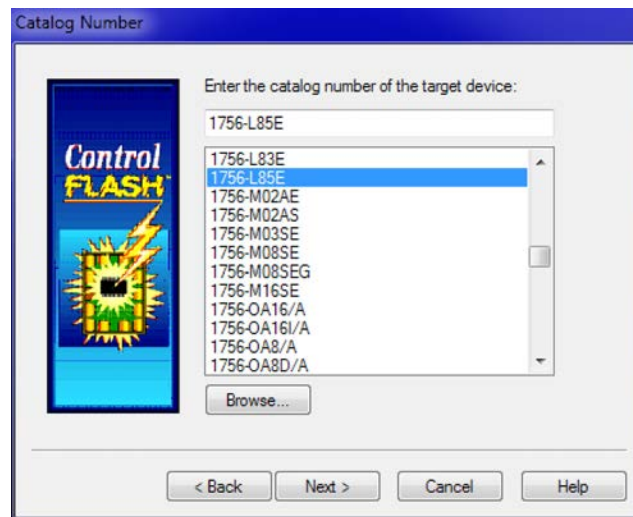

5. Expand the network driver to locate your controller.

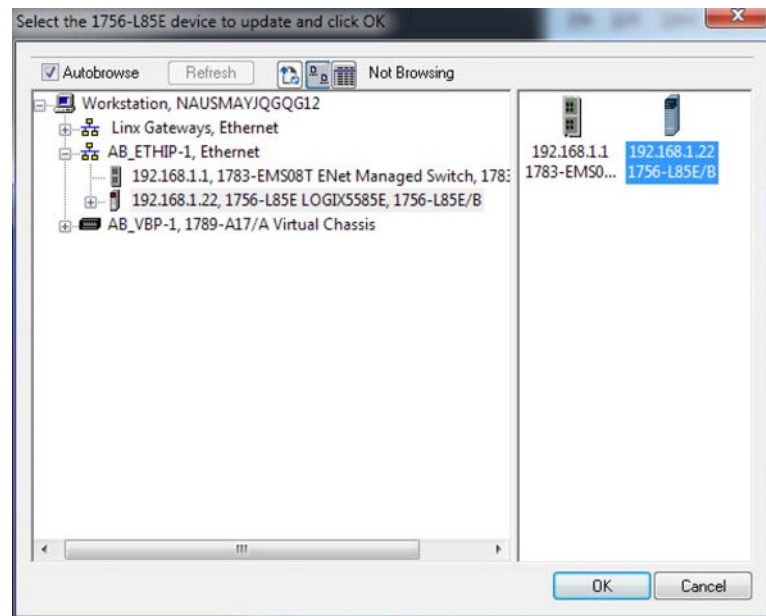

6. Select the controller, and click OK.

7. Select the firmware revision, and click Next.

If the firmware revision you need is not on the list, choose Show all revisions.

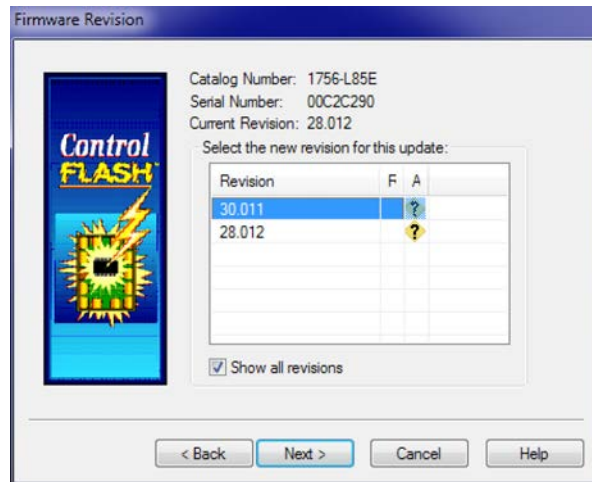

TIP If you experience a Script File Error after selecting the firmware revision number (see the following example), there is likely a problem with your firmware files.

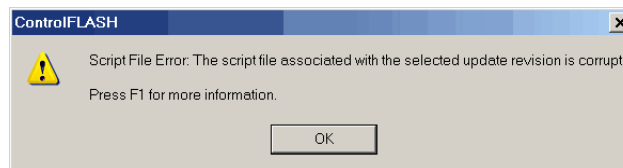

To recover, perform the following:

- Go to <http://www.rockwellautomation.com/support/> and download the firmware revision you are trying to update. Replace the firmware revision that you have previously installed with that posted on the Technical Support website.
- If the replacement firmware revision does not resolve the anomaly, contact Rockwell Automation Technical Support.

8. On the Summary Screen, click Finish.

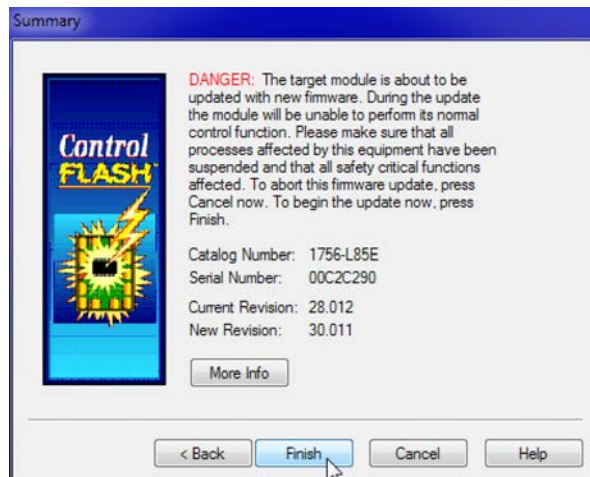

- When a confirmation dialog box appears, click Yes.

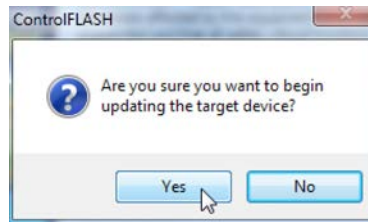

The progress dialog box indicates the progress of the firmware update. The controllers indicate progress in updates and blocks.

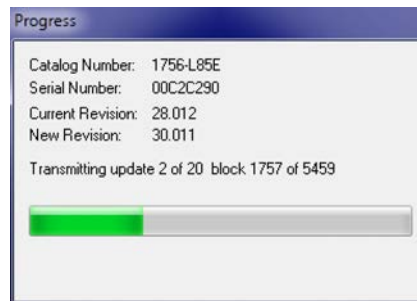

WARNING: Allow the firmware update to complete before you cycle power or otherwise interrupt the update.

TIP If the ControlFLASH update of the controller is interrupted, the controllers revert to boot firmware (revision 1.xxx).

- When the update is complete, the Update Status dialog box indicates that the update is complete.

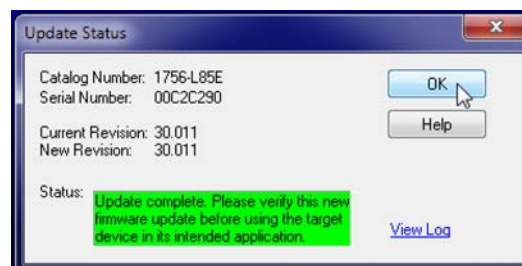

- On the Update Status dialog box, click OK.
- Close the ControlFLASH software.

Use AutoFlash to Update Firmware

To update your controller firmware with the AutoFlash feature, complete these steps.



ATTENTION: If the Secure Digital Card is locked and set to load on power-up, then this update may be overwritten by firmware on the SD card.

1. Verify that the network connection is made and your network driver is configured in Linx-based communication software.
2. Use the Logix Designer application to create a controller project.
3. On the Path bar, click Who Active.

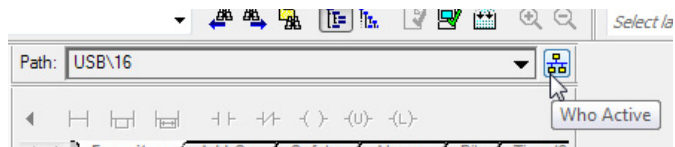

4. On the Who Active dialog box, select your controller under the communication driver you want to use, and click Update Firmware.

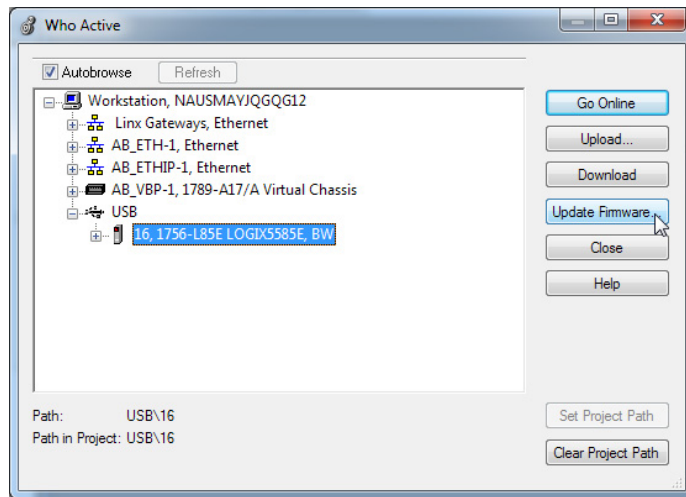

5. On the Choose Firmware Revision dialog, browse to the location of the firmware files (C:\Program Files (x86)\ControlFLASH).

6. Select the firmware revision, and click Update.

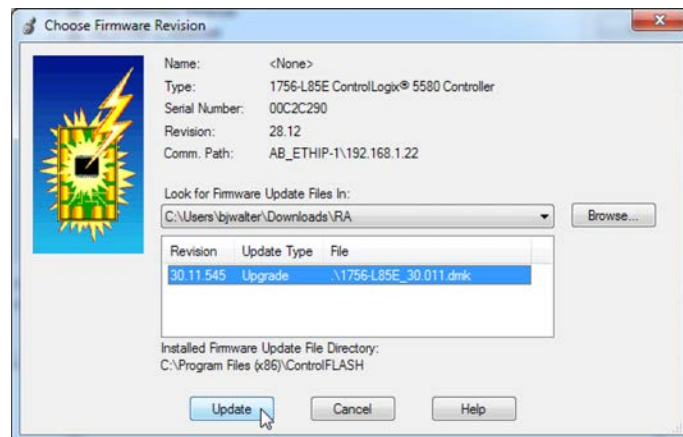

7. On the Confirmation dialog, click Yes.

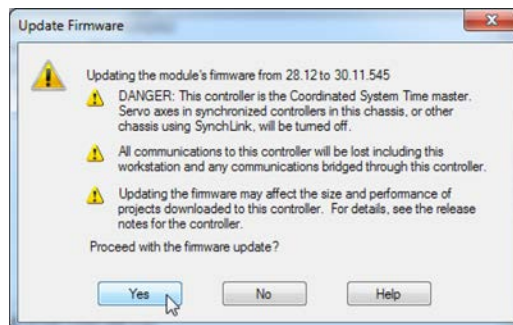

8. On the ControlFLASH Attention dialog, click OK.

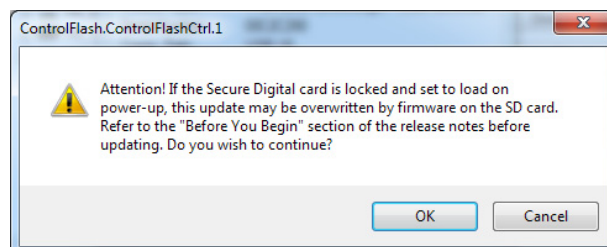

The firmware update begins.

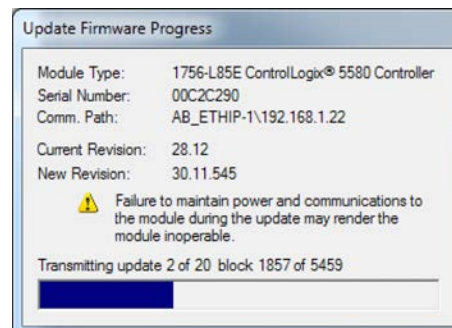

Allow the firmware update to complete without interruption. When the firmware update is complete, the progress dialog closes.

Notes:

Start Using the Controller

Topic	Page
Create a Logix Designer Application Project	71
Additional Configuration for a GuardLogix Controller	72
Go Online with the Controller	81
Download to the Controller	87
Upload from the Controller	90
Choose the Controller Operation Mode	93
Reset Button	96

Create a Logix Designer Application Project

ControlLogix



GuardLogix



Create a controller project by using the Studio 5000 Logix Designer® application.

1. Create a new project and select the controller.
2. Define the properties of the controller.

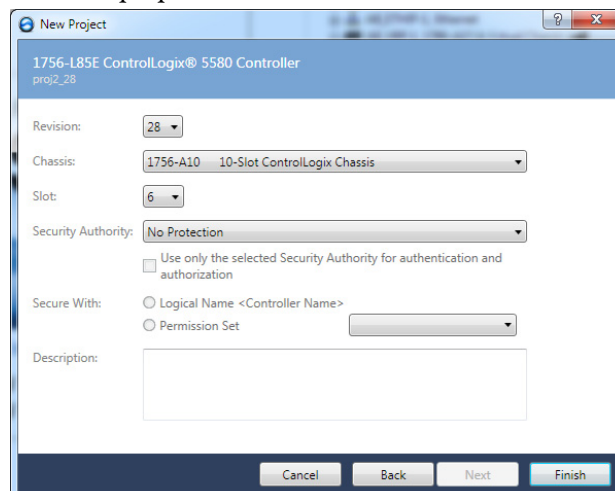

- Choose the major revision of firmware for the controller.
- Choose the chassis size.
- Choose the slot for the controller.
- Choose a security authority option.

For detailed information on security, refer to the Logix5000 Controllers Security Programming Manual, publication [1756-PM016](#).

- Enter a description of the project.

Additional Configuration for a GuardLogix Controller

GuardLogix



GuardLogix® controllers require additional configuration after you create the project. These topics describe how to configure your controller.

For a GuardLogix controller, the Logix Designer application creates a safety task and a safety program. A main Ladder Diagram safety routine called MainRoutine is also created within the safety program.

A red bar under the icon distinguishes safety programs and routines from standard project components in the Controller Organizer.

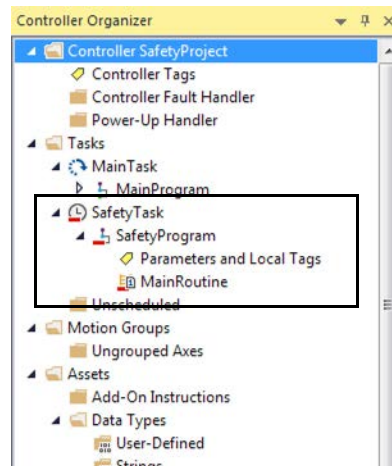

Set the Safety Level for a GuardLogix Controller

The safety level declares to the Logix Designer application the intent of the safety application. The safety level indicates whether the project is at safety level SIL 2/PLd or SIL 3/PLe.

- The safety level required for an application is based on a required risk assessment performed by the customer.
- The safety level achieved is determined by conformance to Safety Integrity Level (SIL) and Performance Level (PL) requirements and safety application requirements. See the GuardLogix 5580 and Compact GuardLogix 5380 Controller Systems Safety Reference Manual, publication [1756-RM012](#).

You must specify the safety level:

- The default setting is SIL 2/PLd.
- You can only modify the setting offline, when the safety application is in the Unlocked state and no safety signature exists.
- For SIL 3/PLe, you must have a 1756-L8SP Safety Partner installed to the right of the primary controller.
- If you select SIL 3/PLe, a safety partner appears in the Controller Organizer I/O tree. If you change the value back to SIL 2/PLd, the safety partner disappears from the I/O tree.

Perform these steps to set the Safety Level:

1. On the Online toolbar, click the Controller Properties icon.
2. On the Controller Properties dialog, click the Safety tab.
3. On the Safety tab, select the Safety Level.

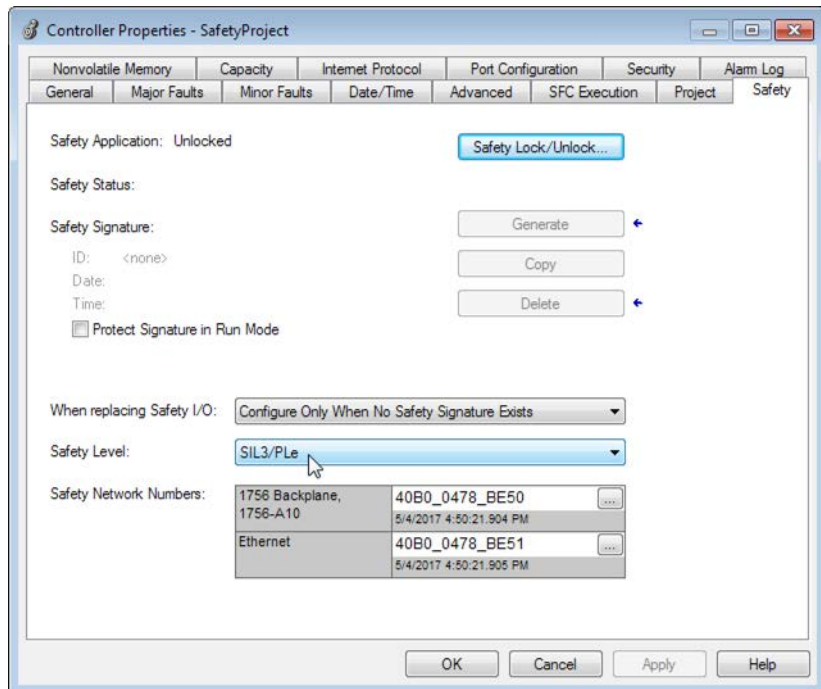

4. Click Apply.
5. Click OK.

Passwords for Safety-locking and Unlocking

Safety-locking the controller helps to protect safety control components from modification. Only safety components, such as the safety task, safety programs, safety routines, safety tags, and safety signature are affected. Standard components are unaffected. You can safety-lock or -unlock the controller project when online or offline.

The safety-lock and -unlock feature uses two separate passwords. Passwords are optional.

IMPORTANT Rockwell Automation does not provide any form of password or security override services. When products and passwords are configured, Rockwell Automation encourages customers to follow good security practices and to plan accordingly for password management.

For information on how to set passwords, see [Set Passwords for Safety-locking and Unlocking on page 193](#).

Protect the Safety Signature in Run Mode

You can prevent the safety signature from being deleted while the controller is in Remote Run mode, regardless of whether the safety application is locked or unlocked.

IMPORTANT You must complete these steps before you create a safety signature or safety lock the controller. Once a safety signature exists, or the application is safety locked, the Protect Signature in Run Mode checkbox is not editable.

Follow these steps to protect the safety signature:

1. Open the Controller Properties dialog box.
2. Click the Safety tab.
3. Check Protect Signature in Run Mode.
4. Click OK.

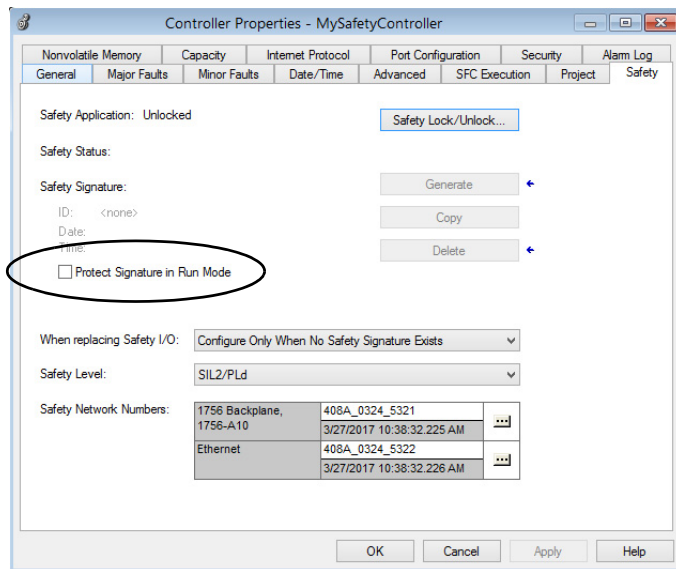

Assign the Safety Network Number (SNN)

The GuardLogix 5580 controllers have two safety network numbers: one for the EtherNet/IP port, and one for the backplane.

When a safety project is created, the Logix Designer application automatically creates two time-based safety network numbers (SNNs), one for the EtherNet/IP port and one for the backplane. We recommend changing each SNN to the SNN already established for that subnet, if one exists. That way, devices created later in the project will automatically be assigned the correct SNN.

Each safety network must have a unique safety network number. You must be sure that a unique SNN is assigned to the following:

- Each CIP safety network that contains safety devices
- Each chassis that contains one or more GuardLogix controllers

TIP Multiple safety network numbers can be assigned to a CIP safety subnet or a ControlBus™ chassis that contains more than one safety device. However, for simplicity, we recommend that each CIP safety subnet has only one unique SNN.

For an explanation on the Safety Network Number, see the GuardLogix 5580 and Compact GuardLogix 5380 Controller Systems Safety Reference Manual, publication [1756-RM012](#).

The SNN can be software-assigned (time-based) or user-assigned (manual). These two formats of the SNN are described in the following sections:

- [Automatic Assignment of Time-based SNN on page 76](#)
- [Manual Assignment of SNN on page 76](#)

Automatic Assignment of Time-based SNN

When a new controller or device is created, a time-based SNN is automatically assigned. Subsequent new safety device additions to the same CIP safety network are assigned the same SNN defined within the lowest address on that CIP safety network.

If the time-based format is selected, the SNN value is the date and time when the number was generated, according to the computer running the configuration software.

Figure 17 - Time-based Format

The screenshot shows a dialog box titled "Safety Network Number". Under the "Format:" section, the "Time-based" radio button is selected. Below it, the date and time "6/28/2017 2:26:42.906 PM" are displayed. To the right of this text is a "Generate" button. Under the "Manual" section, the "Manual" radio button is unselected. Below it, there is a "Backplane:" label followed by an empty text box and the label "(Decimal)". Under the "Number:" section, the text box contains "40E7_03F5_3A5A" and is followed by the label "(Hex)". To the right of the text box are "Copy" and "Paste" buttons. At the bottom of the dialog box are "OK", "Cancel", and "Help" buttons.

Manual Assignment of SNN

The manual option is intended for routable CIP safety systems where the number of network subnets and interconnecting networks is small, and where you can manage and assign the SNN in a logical manner for your specific application.

For the manual option, enter the SNN as a value from 1...9999 (decimal).

Figure 18 - Manual Entry

The screenshot shows the same "Safety Network Number" dialog box. Under the "Format:" section, the "Manual" radio button is selected. Below it, the "Backplane:" label is followed by a text box containing the value "17" and the label "(Decimal)". Under the "Number:" section, the text box contains "0001_0000_0011" and is followed by the label "(Hex)". To the right of the text box are "Copy" and "Paste" buttons. At the bottom of the dialog box are "OK", "Cancel", and "Help" buttons.

You can allow the Logix Designer application to automatically assign an SNN, or you can assign the SNN manually.

See [Change the Safety Network Numbers \(SNNs\) on page 78](#).

IMPORTANT If you assign an SNN manually, make sure that system expansion does not result in a duplication of SNN and unique node reference combinations.

A warning appears if your project contains duplicate SNN and unique node reference combinations. You can still verify the project, but Rockwell Automation recommends that you resolve the duplicate combinations.

However, there can be safety devices on the routable safety network that have the same SNN and node address and are not in the project. In this case, these safety devices are unknown to the Logix Designer application, and you may not see a warning.

If there are duplicate unique node references, as the system user, you are responsible for proving that an unsafe condition cannot result.

Automatic Versus Manual Assignment of the SNN

For typical users, the automatic assignment of an SNN is sufficient. However, manual manipulation of the SNN is required if the following is true:

- One or more controller ports are on a CIP safety subnet that already have an established SNN.
- A safety project is copied to another hardware installation within the same routable CIP safety system.

Change the Safety Network Numbers (SNNs)

Before changing the SNNs you must do the following:

- Unlock the project, if it is safety-locked.
See [Safety-lock the Controller on page 191](#).
- Delete the safety signature, if one exists.
See [Delete the Safety Signature on page 195](#).

Change the Safety Network Numbers (SNN) of the Controller Ports

1. On the Online toolbar, click the Controller Properties icon
2. On the Controller Properties dialog, click the Safety tab.
3. On the Safety tab, click  to the right of the safety network number for the port that you want to change.

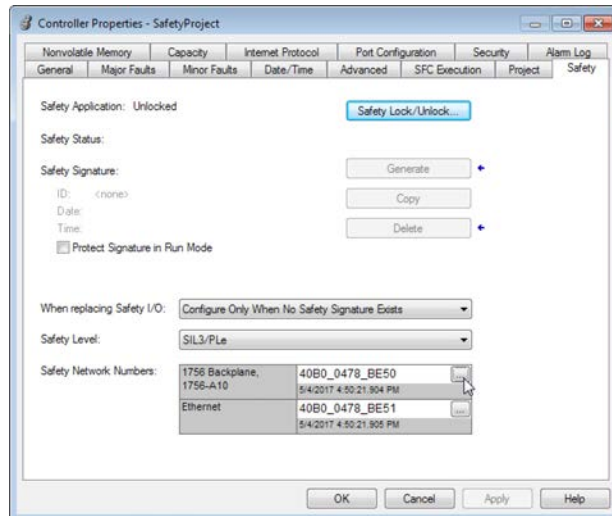

4. On the Safety Network Number dialog box, click Time-based and then Generate.

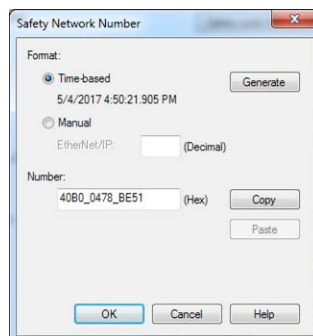

5. Click OK.

Change the Safety Network Number (SNN) of Safety I/O Devices on the CIP Safety Network

This example uses an EtherNet/IP network.

1. Find the first EtherNet/IP communication module in the I/O Configuration tree.
2. Expand the safety I/O devices available through the EtherNet/IP communication module.
3. Double-click the first safety I/O device to view the General tab.

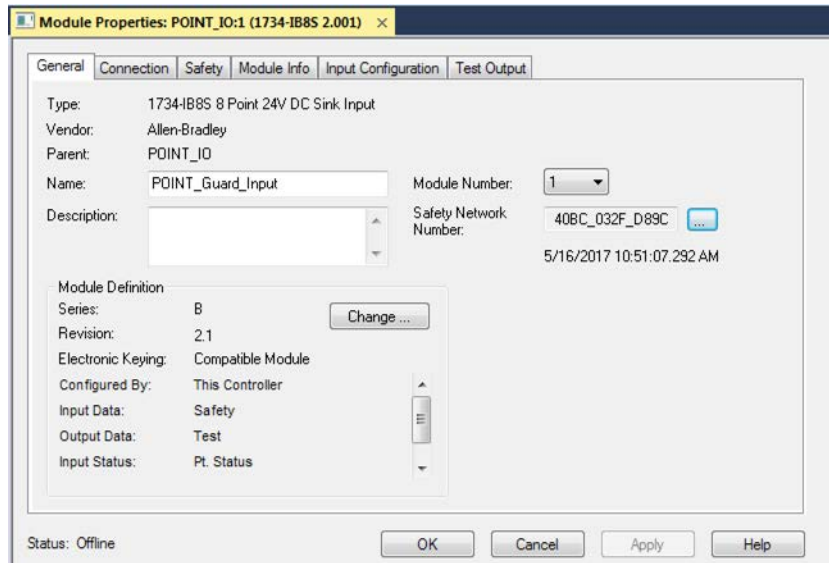



4. Click to the right of the safety network number to open the Safety Network Number dialog box.
5. Choose Time-based and click Generate to generate a new SNN for that EtherNet/IP network.
6. Click OK.
7. Click Copy to copy the new SNN to the Windows Clipboard.
8. Open the General Tab of the Module Properties dialog box of the next safety I/O device under that EtherNet/IP module.
9. Click to the right of the safety network number to open the Safety Network Number dialog box.
10. On the Safety Network Number dialog box, click Paste to paste that EtherNet/IP network's SNN into that device.
11. Click OK.
12. Repeat steps [8...10](#) for the remaining safety I/O devices under that EtherNet/IP communication module.
13. Repeat steps [2...10](#) for any remaining network communication modules under the I/O Configuration tree.

Copy and Paste a Safety Network Number (SNN)

If you already have a project where one or more of the controller ports already has an established SNN, then you can copy and paste that SNN when you create a new project that uses the same controller.

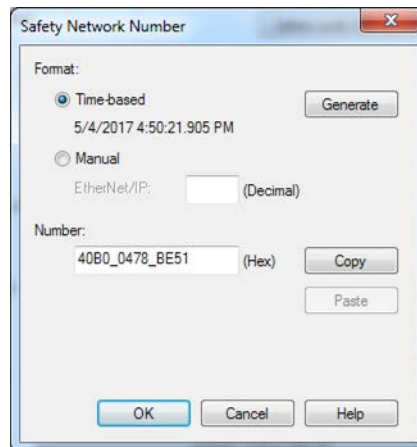
1. In the software configuration tool of the module's configuration owner, open the Safety Network Number dialog box for the module.



2. Click Copy.
3. Click the General tab on the Module Properties dialog box of the I/O device in the I/O Configuration tree of the consuming controller project.
This consuming controller is not the configuration owner.
4. Click  to the right of the safety network number to open the Safety Network Number dialog box.
5. Click Paste.
6. Click OK.

Go Online with the Controller

To go online with the controller, you must first specify a communication path in the Logix Designer application.

ControlLogix



GuardLogix



TIP For this section, the USB port was chosen as the communication path. Other paths through the embedded Ethernet port or via the backplane are also possible.

Use RSWho

1. Open or create a Logix Designer application project.
2. In the application, click RSWho.

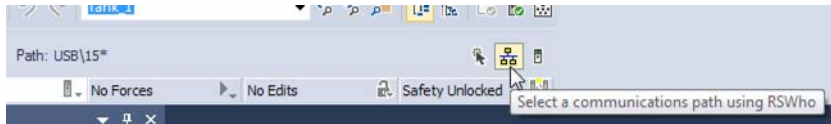

3. Expand the communication path and select the controller.

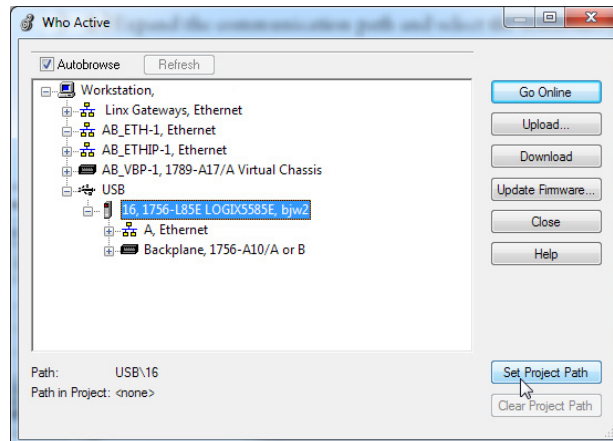

4. If you want to store the path in the project file, click Set Project Path.

If you store the project path in the project, then you do not have to choose the path each time you go online.

5. After choosing the communication path, click Go Online in the Who Active dialog box.

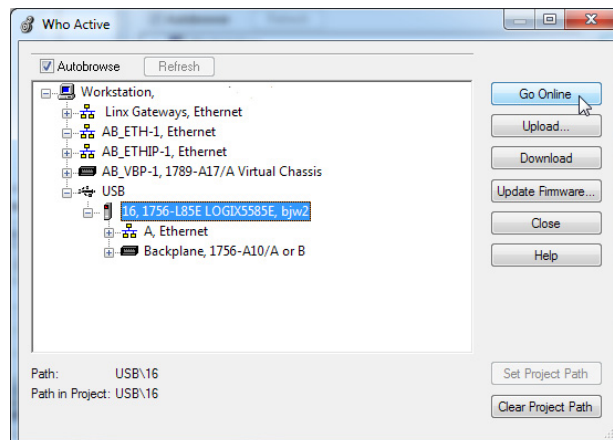

Go Online will use the highlighted node in the Who Active tree, regardless of the setting for Path in Project. For more information on the Who Active dialog box, see the Logix Designer Online Help.

See [Additional Considerations for Going Online with a GuardLogix Controller on page 83](#).

Use a Recent Communication Path

You can also select a recent communications path and go online or apply it to your project.

1. In the application, click the arrow that is on the Path bar.



2. On the Select Recent Communications Path dialog box, choose the path.

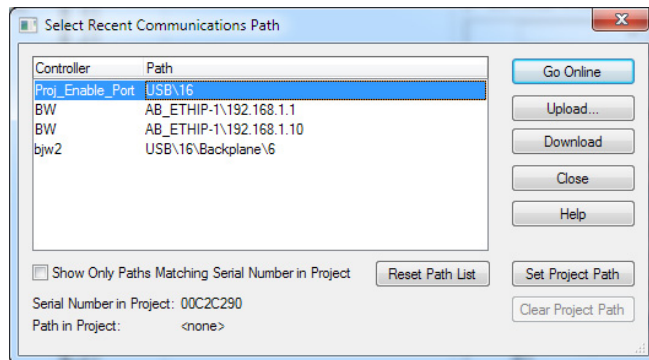

3. To store the path in your project, click Set Project Path.
4. Click Go Online.

For more information on the Select Recent Communications Path dialog box, see the Logix Designer Online Help.

Once you have established a communication path, then you can choose Go Online from the Controller Status menu when you are working in the project.

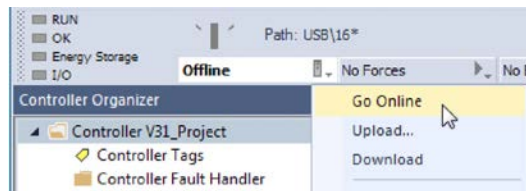

See [Additional Considerations for Going Online with a GuardLogix Controller on page 83](#).

Additional Considerations for Going Online with a GuardLogix Controller

GuardLogix



The Logix Designer application determines whether you can go online with a target controller based on whether the offline project is new or whether changes occurred in the offline project. If the project is new, you must first download the project to the controller. If changes occurred to the project, you are prompted to upload or download. If no changes occurred, you can go online to monitor the execution of the project.

A number of factors affect these processes, including Project to Controller Match feature, the safety status and faults, the existence of a safety signature, the safety-lock/-unlock status of the project and the controller, and the configured safety level disagreeing with the presence or absence of a partner in the chassis.

Match Project to Controller

The Match Project to Controller feature affects the download, upload, and go online processes of standard and safety projects. This feature is located on the Controller Properties Advanced tab.

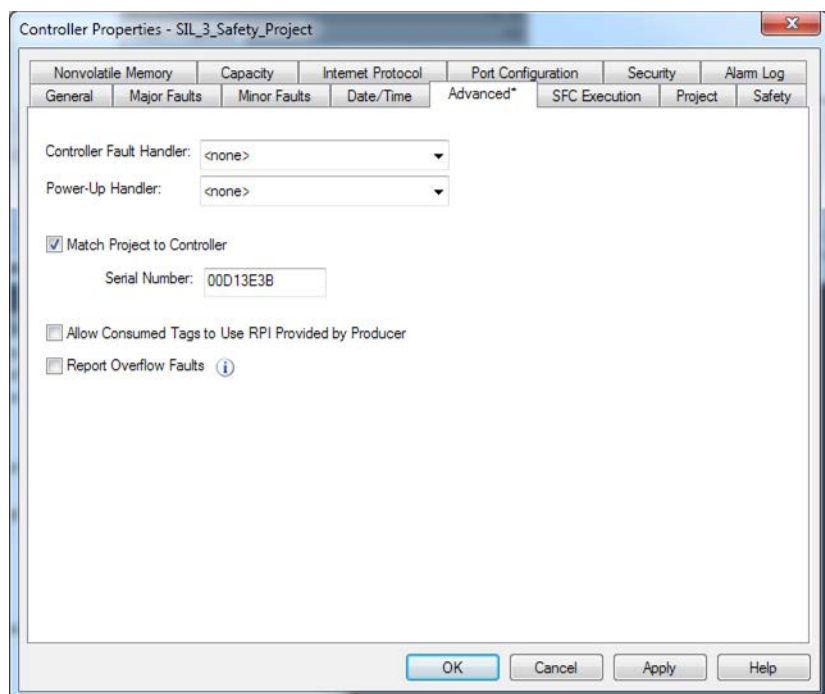

If the Match Project to Controller feature is enabled in the offline project, the Logix Designer application compares the serial number of the controller in the offline project to that of the connected controller. If they do not match, you must cancel the download/upload, connect to the correct controller, or confirm that you are connected to the correct controller that updates the serial number in the project to match the target controller.

Firmware Revision Matching

Firmware revision matching affects the download process. If the revision of the controller does not match the revision of the project, you are prompted to update the firmware of the controller. The Logix Designer application lets you update the firmware as part of the download sequence.

IMPORTANT To update the firmware of the controller, first install a firmware upgrade kit. An upgrade kit ships on a supplemental DVD along with the Studio 5000® environment.

TIP You can also upgrade the firmware by choosing ControlFLASH™ from the Tools menu in the Logix Designer application.

Safety Status/Faults

Uploading program logic and going online is allowed regardless of safety status. Safety status and faults only affect the download process.

You can view the safety status via the Safety tab on the Controller Properties dialog box.

Safety Signature and Safety-locked and -unlocked Status

The existence of a safety signature and the safety-locked or -unlocked status of the controller affect both the upload and download processes.

The safety signature and the safety lock status are uploaded with the project. For example, if the project in the controller was safety-unlocked, the offline project remains safety-unlocked following the upload, even if it was locked prior to the upload.

Following an upload, the safety signature in the offline project matches the controller's safety signature.

The safety lock status always uploads with the project, even when there is no safety signature.

The existence of a safety signature, and the controller's safety-lock status, determines whether or not a download can proceed.

Table 15 - Effect of Safety-lock and safety signature on Download Operation

Safety-lock Status	Safety Signature Status	Download Functionality
Controller safety-unlocked	safety signature in the offline project matches the safety signature in the controller.	All standard project components are downloaded. Safety tags are reinitialized to the values they had when the safety signature was created. Safety lock status matches the status in the offline project.
	safety signatures do not match.	If the controller had a safety signature, it is automatically deleted, and the entire project is downloaded. Safety lock status matches the status in the offline project.
Controller safety-locked	safety signatures match.	If the offline project and the controller are safety-locked, all standard project components are downloaded and safety tags are reinitialized to the values they had when the safety signature was created. If the offline project is not safety-locked, but the controller is, the download is blocked and you must first unlock the controller to allow the download to proceed.
	safety signatures do not match.	You must first safety-unlock the controller to allow the download to proceed. If the controller had a safety signature, it is automatically deleted, and the entire project is downloaded. Safety lock status matches the status in the offline project.

Checks for Going Online with a GuardLogix Controller

For a safety project, the Logix Designer application checks for the following:

- Do the offline project and controller serial numbers match (if Project to Controller Match is selected)?
- Does the offline project contain changes that are not in the controller project?
- Do the revisions of the offline project and controller firmware match?
- Are either the offline project or the controller safety-locked?
- Do the offline project and the controller have compatible safety signatures?

Table 16 - Connect to the Controller with a Safety Project

If the software indicates	Then
Unable to connect to controller. Mismatch between the offline project and the controller serial number. Selected controller may be the wrong controller.	Connect to the correct controller, select another project file, or choose the Update project serial number checkbox and choose Go Online... to connect to the controller and update the offline project serial number to match the controller.
Unable to connect to controller. The revision of the offline project and the controller's firmware are not compatible.	Choose one of the following options: <ul style="list-style-type: none"> • Choose Update Firmware. Choose the required revision and click Update. Click Yes to confirm your selection. IMPORTANT: The online project is deleted. • To preserve the online project, cancel the online process and install a version of the Studio 5000 environment that is compatible with the firmware revision of your controller.
You need to upload or download to go online by using the open project.	Choose one of the following options: <ul style="list-style-type: none"> • Upload to update the offline project. • Download to update the controller project. • Choose File to select another offline project.
Unable to connect in a manner that preserves safety signature. The firmware minor revision on the controller is not compatible with safety signature in offline project.	<ul style="list-style-type: none"> • To preserve the safety signature when the firmware minor revision is incompatible, update the firmware revision in the controller to exactly match the offline project. Then go online to the controller. • To proceed with the download despite the safety signature incompatibility, click Download. The safety signature is deleted. IMPORTANT: The safety system requires revalidation.
Unable to connect to controller. Incompatible safety signature cannot be deleted while project is safety-locked.	Cancel the online process. You must safety-unlock the offline project before attempting to go online.

When the controller and the Logix Designer application are online, the safety-locked status and safety signature of the controller match the controller's project. The safety-lock status and safety signature of the offline project are overwritten by the controller. If you do not want the changes to the offline project to be permanent, do not save the project file following the go online process.

Download to the Controller

When you download a project to the controller, it copies the project from the Logix Designer application onto the controller.

ControlLogix



GuardLogix



Use Who Active

You can use the features of the Who Active dialog box to download to your controller after you have set the communication path. Complete these steps to download to the controller.

1. After choosing the communication path, click Download in the Who Active dialog box.

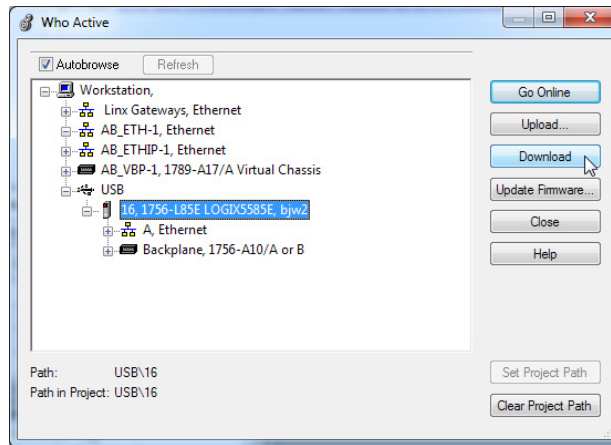

2. After reading the warnings in the Download dialog box, click Download.

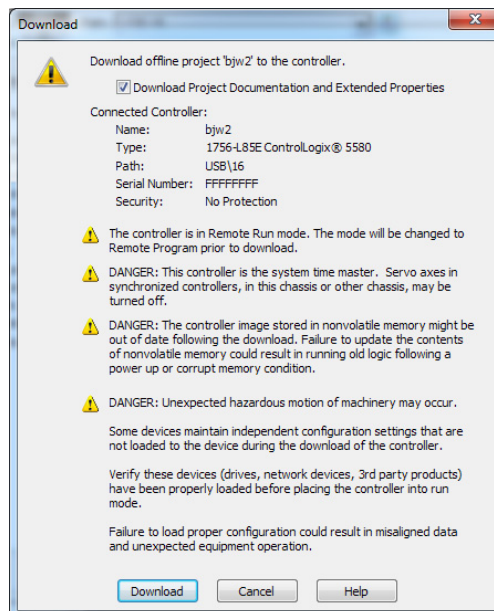

Use the Controller Status Menu

After you choose a communication path in the Logix Designer application, you can use the Controller Status menu to download to the controller. To download, from the Controller Status menu, choose Download.

Figure 19 - Download Via the Controller Status Menu

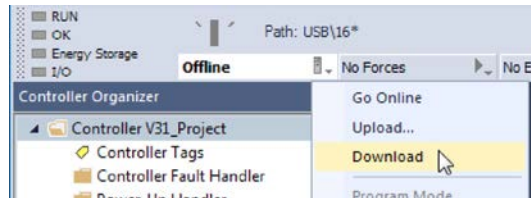

TIP After the download completes, the project name appears on the scrolling status display.

Additional Considerations for Download to a GuardLogix Controller

GuardLogix



For a safety project, the Logix Designer application compares the following information in the offline project and the controller:

- Controller serial number (if project to controller match is selected)
- Firmware major and minor revisions
- Safety status
- Safety signature (if one exists)
- Safety-lock status
- Safety Partner (if one exists). The Logix Designer application does not allow the download of a project configured for SIL 2 if a safety partner is to the right of the primary controller.

After the checks all pass, a download confirmation dialog appears. Click Download.

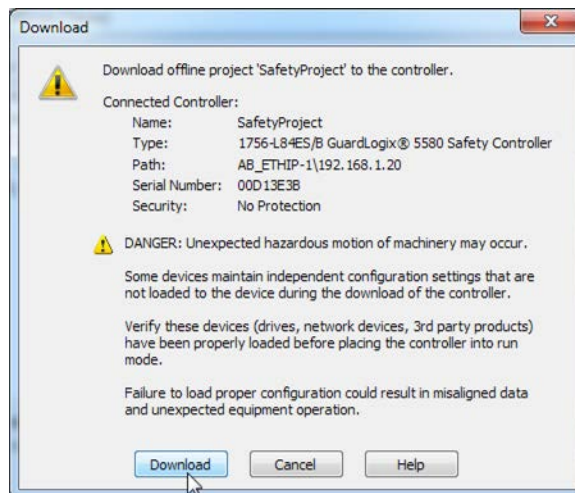

The Logix Designer application displays status messages in the download dialog, progress screen, and the Errors window.

If the software indicates:	Then:
Unable to download to the controller. Mismatch between the offline project and the controller serial number. Selected controller may be the wrong controller.	Connect to the correct controller or verify that this is the correct controller. If it is the correct controller, check the Update project serial number checkbox to allow the download to proceed. The project serial number is modified to match the controller serial number.
Unable to download to the controller. The major revision of the offline project and the controller's firmware are not compatible.	Choose Update Firmware. Choose the required revision and click Update. Click Yes to confirm your selection.
Unable to download a SIL 2 application, Safety Partner is Present.	Remove the safety partner.
Unable to download to controller. The safety partner is missing or unavailable.	Cancel the download process. Install a compatible safety partner before attempting to download.
Unable to download to controller. The firmware revision of the safety partner is not compatible with the primary controller.	Update the firmware revision of the safety partner. Choose Update Firmware. Choose the required revision and click Update. Click Yes to confirm your selection.
Unable to download to controller. Safety partnership has not been established.	Cancel this download process and attempt a new download.
Unable to download to controller. Incompatible safety signature cannot be deleted while the project is safety-locked.	Cancel the download. To download the project, you must safety-unlock the offline project, delete the safety signature, and download the project.
Cannot download in a manner that preserves the safety signature. Controller's firmware minor revision is not compatible with safety signature in offline project.	<p>IMPORTANT: The safety system requires revalidation.</p> <ul style="list-style-type: none"> • If the firmware minor revision is incompatible, to preserve the safety signature, update the firmware revision in the controller to exactly match the offline project. Then download the offline project. • To proceed with the download despite the safety signature incompatibility, click Download. The safety signature is deleted. <p>IMPORTANT: The safety system requires revalidation.</p>
Unable to download to controller. Controller is locked. Controller and offline project safety signatures do not match.	Choose Unlock. The Safety Unlock for Download dialog box appears. If the Delete Signature checkbox is selected and you choose Unlock, click Yes to confirm the deletion.
Downloading safety signature...	The safety signature is present in the offline project and is downloading.
Reloading safety signature...	The safety signature is present in the offline project and is not downloaded, because a matching signature exists in the controller and is reloaded from there.

Following a successful download, the safety-locked status and safety signature of the controller match the project that was downloaded. Safety data is initialized to the values that existed when the safety signature was created.

Upload from the Controller

When you upload a project from the controller, it copies the project from the controller to the Logix Designer application.

ControlLogix



GuardLogix



Use Who Active

You can use the features of the Who Active dialog box to upload from your controller after you have set the communication path. Complete these steps to upload from the controller.

1. After choosing the communication path, click Upload on the Who Active dialog box.

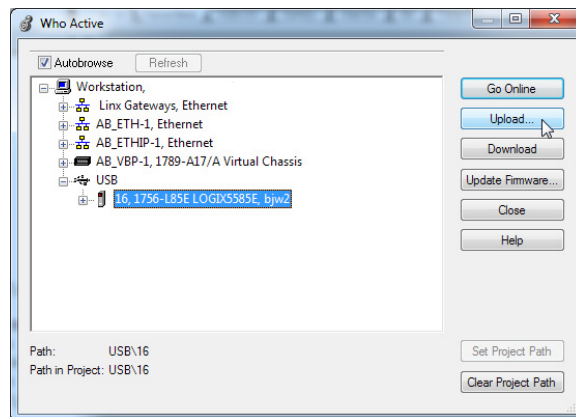

2. On the Connected to Upload dialog box, verify that the project is the one you want to upload.
3. Click Upload.

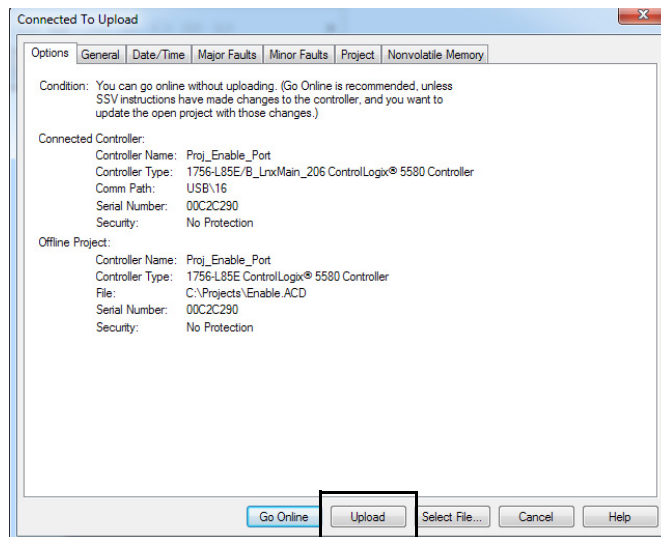

For more information on the Connected To upload dialog box, see the Logix Designer Online Help.

Use the Controller Status Menu

After you have chosen a communication path in the Logix Designer application, you can use the Controller Status menu to upload from the controller.

1. From the Controller Status menu, choose Upload.

Figure 20 - Upload Via the Controller Status Menu

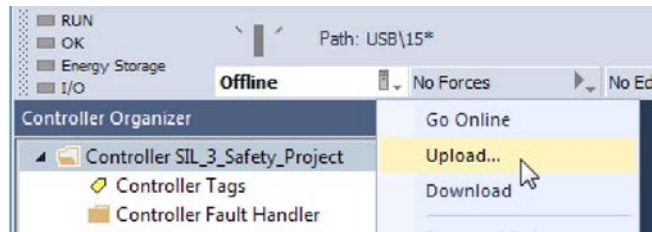

2. On the Connected to Upload dialog box, verify that the project is the one you want to upload.
3. Click Upload.

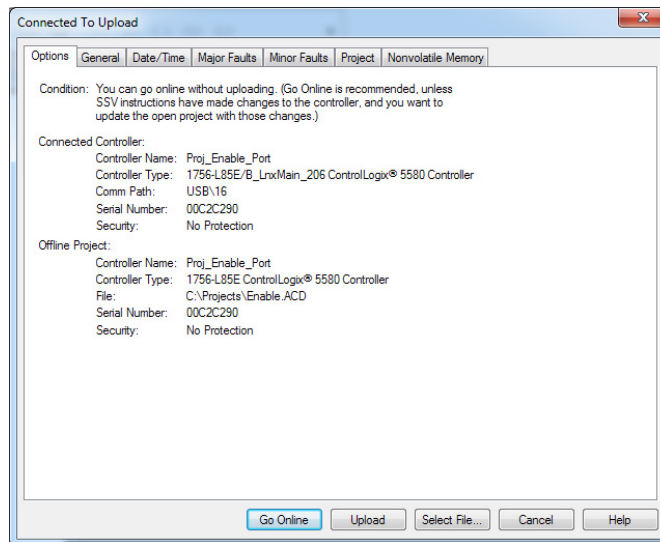

Additional Considerations for Upload from a GuardLogix Controller

GuardLogix



For a safety project, the Logix Designer application compares the following information in the project and the controller:

- Controller serial number (if project to controller match is selected)
- Open project to the controller project
- Firmware major and minor revisions
- Safety signature (if one exists)

IMPORTANT An upload is allowed regardless of the Safety status and the Safety Locked state of the offline project and controller. The locked status follows the state of the uploaded project.

Upload Behavior:	Response:
If the project to controller match is enabled, the Logix Designer application checks whether the serial number of the open project and the serial number of the controller match.	<ul style="list-style-type: none"> • Connect to the correct controller or verify that this is the correct controller. • Select a new project to upload into or select another project by choosing Select File. • If it is the correct controller, select the Update project serial number checkbox to allow the download to proceed. The project serial number is modified to match the controller serial number.
The Logix Designer application checks whether the open project matches the controller project.	<ul style="list-style-type: none"> • If the projects do not match, you must select a matching file or cancel the upload process. • If the projects match, the software checks for changes in the offline (open) project.
The Logix Designer application checks for changes in the offline project.	<ul style="list-style-type: none"> • If there are no changes in the offline project, you can go online without uploading. Click Go Online. • If there are changes in the open project that are not present in the controller, you can choose to upload the project, cancel the upload, or select another file.
Uploading safety signature...	This message appears during the upload only if a safety signature matching the one in the controller does not exist in the offline project.

If you choose Upload, the standard and safety applications are uploaded. If a safety task signature exists, it is also uploaded. The safety-lock status of the project reflects the original status of the online (controller) project.

TIP Prior to the upload, if an offline safety task signature exists, or the offline project is safety-locked but the controller is safety-unlocked or has no safety task signature, the offline safety task signature and safety-locked state are replaced by the online values (safety-unlocked with no safety task signature). If you do not want to make these changes permanent, do not save the offline project following the upload.

Choose the Controller Operation Mode

Use this table as a reference when determining your controller operation mode.

ControlLogix



GuardLogix



Mode Switch Position ⁽¹⁾	Available Controller Modes	In this mode you can:	In this mode you cannot:	 ATTENTION:
RUN	Run mode —The controller is actively controlling the process/machine. Projects cannot be edited in the Logix Designer application when in Run mode.	<ul style="list-style-type: none"> • Turn outputs to the state commanded by the logic of the project. • Execute (scan) tasks • Send messages • Send and receive data in response to a message from another controller • Produce and consume tags 	<ul style="list-style-type: none"> • Turn outputs to their configured state for Program mode • Change the mode of the controller via the Logix Designer application • Download a project • Schedule a ControlNet network • While online, edit the project 	Run mode is used only when all conditions are safe.
REM	Remote Run mode —This mode is identical to Run mode except you can edit the project online, and change the controller mode through the Logix Designer application.	<ul style="list-style-type: none"> • Turn outputs to the state commanded by the logic of the project. • Execute (scan) tasks • Change the mode of the controller via the Logix Designer application • While online, edit the project • Send messages • Send and receive data in response to a message from another controller • Produce and consume tags 	<ul style="list-style-type: none"> • Turn outputs to their configured state for Program mode • Download a project • Schedule a ControlNet network 	You are able to modify a project file online in Remote Run mode. Be sure to control outputs with care to avoid injury to personnel and damage to equipment.
	Remote Program mode —This mode functions like Program mode, except you can change the controller mode through the Logix Designer application.	<ul style="list-style-type: none"> • Turn outputs to their configured state for Program mode • Change the mode of the controller via the Logix Designer application • Download a project • Schedule a ControlNet network • While online, edit the project • Send and receive data in response to a message from another controller • Produce and consume tags 	<ul style="list-style-type: none"> • Turn outputs to the state commanded by the logic of the project. • Execute (scan) tasks 	Outputs are commanded to their Program mode state, which can cause a dangerous situation.
	Remote Test mode —This controller mode executes code, but I/O is not controlled. You can edit the project online, and change the controller mode through the Logix Designer application. Output modules are commanded to their Program mode state (on, off, or hold).	<ul style="list-style-type: none"> • Turn outputs to their configured state for Program mode • Execute (scan) tasks • Change the mode of the controller via the Logix Designer application • While online, edit the project • Send messages • Send and receive data in response to a message from another controller • Produce and consume tags 	<ul style="list-style-type: none"> • Turn outputs to the state commanded by the logic of the project. • Download a project • Schedule a ControlNet network • Send messages 	
PROG	Program mode —This controller mode does not execute code or control I/O, but editing operations are available. Output modules are commanded to their Program mode state (On, Off, or Hold). In this position, controller modes cannot be changed through the Logix Designer application.	<ul style="list-style-type: none"> • Turn outputs to their configured state for Program mode • Download a project • Schedule a ControlNet network • While online, edit the project • Send and receive data in response to a message from another controller • Produce and consume tags 	<ul style="list-style-type: none"> • Turn outputs to the state commanded by the logic of the project. • Execute (scan) tasks • Change the mode of the controller via the Logix Designer application • Send messages 	Do not use Program mode as an emergency stop (E-stop). Program mode is not a safety device. Outputs are commanded to their Program mode state, which can cause a dangerous situation.

(1) Moving the mode switch from Run to Remote leaves the controller in the Remote Run mode, while moving the switch from Program to Remote leaves the controller in the Remote Program mode. You cannot choose Remote Test mode by the mode switch alone, it is only available via the Logix Designer application.

Use the Mode Switch to Change the Operation Mode

To change the operation mode, use the controller mode switch. The controller mode switch provides a mechanical means to enhance controller and control system security. You must physically move the mode switch on the controller to change its operating mode from RUN, to REM, or to PROG.

When the mode switch on the controller is set to RUN mode, features like online editing, program downloads, and firmware updates are prohibited. See [Choose the Controller Operation Mode on page 93](#) for a complete list of prohibited features.

The physical mode switch can complement other authorization and authentication methods that similarly control user-access to the controller, such as the FactoryTalk® Security service.

IMPORTANT During runtime, we recommend that you place the controller mode switch in RUN mode and remove the key (if applicable) from the switch. This can help discourage unauthorized access to the controller or potential tampering with the program of the controller, configuration, or device firmware.

Place the mode switch in REM or PROG mode during controller commissioning and maintenance and whenever temporary access is necessary to change the program, configuration, or firmware of the product.

The mode switch on the front of the controller can be used to change the controller to one of these modes:

- Run (RUN)
- Remote (REM)
- Program (PROG)

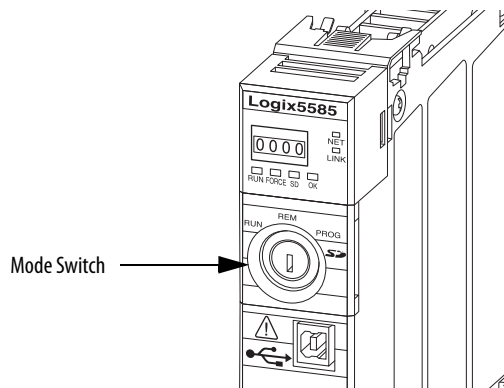

Use the Logix Designer Application to Change the Operation Mode

When you are online with the controller, and the controller mode switch is set to Remote (REM or the center position), then you can use Logix Designer to change the operation mode.

The Controller Status menu lets you specify these operation modes:

- Remote Program
- Remote Run
- Remote Test

Figure 21 - Operation Mode

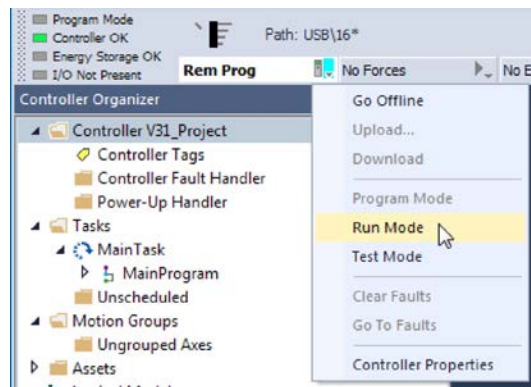

TIP For this example, the controller mode switch is set to Remote mode. If your controller mode switch is set to Run or Program modes, the menu options change.

Reset Button

ControlLogix



GuardLogix



You can reset the ControlLogix® and GuardLogix controllers, and the 1756-L8SP Safety Partner, with the reset button. The reset button is only read during a power-up or restart. If you press the reset button at another time, it has no effect.

For a GuardLogix controller, the Safety Locked status or safety signature does not prevent you from performing a controller reset. Because the application is cleared from the controller during a reset, the safety level of the controller is cleared also. When you download a safety project to the controller, the safety level is set to the level specified in the project.

A controller has two stages of reset:

- A Stage 1 reset clears the application program and memory, but retains the IP address and all network settings. A stage 1 reset occurs only if the controller contains a user application. See [Stage 1 Reset on page 97](#).
- A Stage 2 reset returns the controller to out-of box settings (including firmware), and clears all network settings. A stage 2 reset occurs only if the controller does not contain a user application, and the current controller firmware is not a 1.x version. See [Stage 2 Reset on page 98](#).

The Safety Partner reset returns the safety partner to out-of box settings (including firmware). See [Safety Partner Reset on page 99](#).

IMPORTANT Because port enable/disable status is associated with the application program, the controller Ethernet port becomes enabled after a Stage 1 or Stage 2 reset.



WARNING: When you press the reset button while power is on, an Electric Arc can occur. This could cause an explosion in hazardous location installations. Be sure that power is removed or the area is nonhazardous before proceeding.

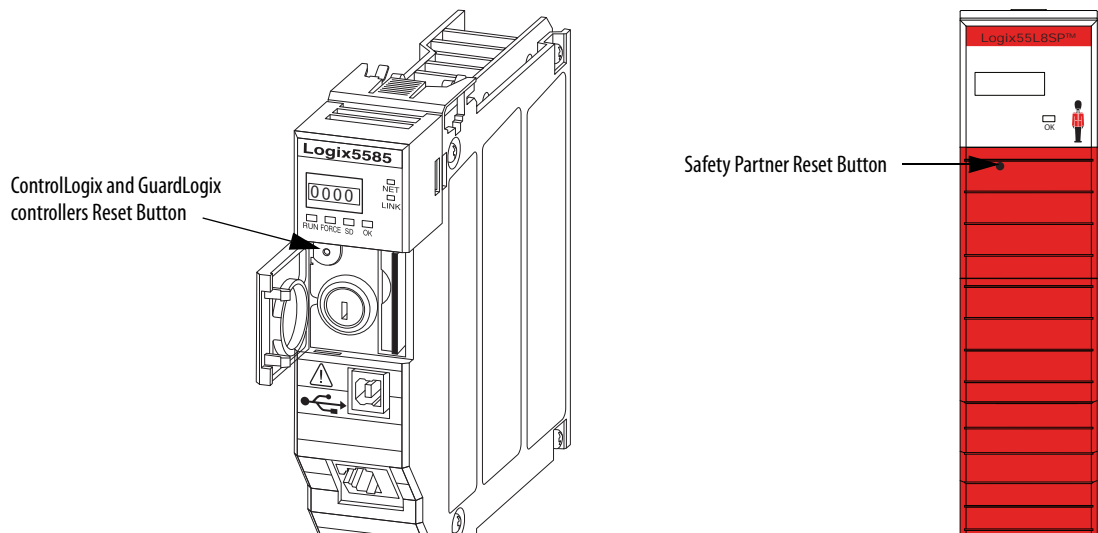

Stage 1 Reset

The stage 1 reset:

- Clears the application program.
- Retains the network settings for the embedded Ethernet port.
- Retains APR (motion position info) information.
- Retains all PTP configuration (Time Synchronization) parameters.
- Retains Wall Clock Time within the energy retention capability of the module.
- Creates a timestamped entry in the Controller Log that a Stage 1 Reset event has occurred.
- Resets the controller to begin the controller start up process.
- Prevents the controller from loading firmware or software from the SD card on this first start up after the reset, regardless of the setting on the SD card, and without modifying the SD card contents (the write-protect setting is irrelevant). An SD card will reload (if configured to do so) on subsequent powerup situations.
- Enables the Ethernet Port, if it was previously disabled.

To perform a Stage 1 reset, complete these steps. This process assumes that an SD card is installed in the controller.

1. Power down the controller.
2. Remove the key from the keyswitch.
3. Open the front door on the controller.
4. Use a small tool with a diameter of a paper clip, to press and hold the reset button. The button is recessed behind the panel.
5. While holding in the reset button, power up the controller.
6. Continue to hold the reset button while the 4-character display cycles through CLR, 4, 3, 2, 1, Project Cleared.
7. After Project Cleared appears, release the reset button.

IMPORTANT If you release the reset button before Project Cleared scrolls across the display, the controller continues with powerup and does not reset.

After a Stage 1 reset is performed, load a Logix Designer application project to the controller in these ways:

- Download the project from the Logix Designer application - For more information, see [Download to the Controller on page 87](#)
- Cycle power on the controller to load a project from the SD card.

This option works only if the project stored on the SD card is configured to load the project on powerup.

Stage 2 Reset

The stage 2 reset:

- Returns the module to revision 1.x firmware (the out-of-box firmware revision).
- Clears all user settings to the out-of-box values including network and time synchronization settings.
- Resets the controller to begin the controller start up process.
- There will be no entries in the controller log after a Stage 2 reset, but saved logs on the SD card remain.

Follow these steps to perform a Stage 2 reset:

1. Power down the controller.
2. Remove the key from the keyswitch.
3. Open the front door on the controller.
4. Remove the SD card.
5. Use a small tool with a diameter of a paper clip, to press and hold the reset button. The button is recessed behind the panel.
6. While holding in the reset button, power up the controller.
7. Continue to hold the reset button while the 4-character display cycles through DFLT, 4, 3, 2, 1, Factory Default.
8. After Factory Default appears, release the reset button.
9. On your workstation, delete all of the files on the SD card.
10. Power down the controller.
11. Reinstall the SD card.
12. Powerup the controller.
13. Verify that the controller is at firmware revision 1.x, and the controller is set to DHCP.

After a Stage 2 reset is performed, you must complete these tasks to use the controller again:

- Configure the Ethernet ports, set the desired EtherNet/IP mode, and set the controller IP address configuration. For more information, see [Set the Controller IP Address on page 66](#).
- Update the firmware revision - For more information, see [Update Controller Firmware on page 76](#).
- Download a Logix Designer application project to the controller in one of these ways:
 - Download the project from the Logix Designer application - For more information, see [Download to the Controller on page 87](#).
 - Cycle power on the controller to load a project from the SD card. This option works only if the project stored on the SD card is configured to load the project on powerup.

Safety Partner Reset

Follow these steps to perform a safety partner reset:

1. Power down the safety partner.
2. Use a small tool with a diameter of a paper clip, to press and hold the reset button. This button is recessed 5 mm (0.19 in.) behind the panel.
3. While holding in the reset button, power up the safety partner.
4. Continue to hold the reset button while the 4-character display cycles through DFLT, 4, 3, 2, 1, Factory Default.
5. After Factory Default appears, release the reset button.

Notes:

Use the Secure Digital Card

Topic	Page
Considerations for Storing and Loading a Safety Project	103
Store to the SD Card	104
Load from the SD Card	108
Other Secure Digital Card Tasks	110

ControlLogix



GuardLogix



The controllers ship with a Secure Digital (SD) card installed. We recommend that you leave the SD card installed, so if a fault occurs, diagnostic data is automatically written to the card. Rockwell Automation can then use the data to help investigate the cause of the fault.

We recommend that you use the SD cards available from Rockwell Automation:

- 2 GB SD card, catalog number 1784-SD2
- CodeMeter CmCard SD, 4 GB, catalog number 9509-CMSDCD4 (when license-based source protection and execution protection features are enabled)

While other SD cards can be used with the controller, Rockwell Automation has not tested the use of those cards with the controller and you could experience data corruption or loss.

SD cards that are not provided by Rockwell Automation can have different industrial, environmental, and certification ratings as those cards that are available from Rockwell Automation. These cards can have difficulty with survival in the same industrial environments as the industrially rated versions available from Rockwell Automation.

The memory card that is compatible with your ControlLogix® controller is used to load or store the contents of user memory for the controller.

When you use the Store feature, the project that is stored on the SD card matches the project in the controller memory at that time. Changes that you make after you store the project are not reflected in the project on the SD card.

If you make changes to the project in the controller memory but do not store those changes, the next time that you load the project from the SD card to the controller, you overwrite the changes.

IMPORTANT Do not remove the SD card while the controller is reading from, or writing to, the card. If you remove the card during either activity, the data on the card or controller can become corrupt.

Additionally, the controller firmware at the time when the card is removed can become corrupted. Leave the card in the controller until the OK status indicator turns solid green.

If an SD card is installed, you can see the contents of the card on the Nonvolatile Memory tab of the Controller Properties dialog box. If a safety application is stored on the card, the safety-lock status and the safety signature are shown.

The project must be online to see the contents of the SD card.

For detailed information on how to use nonvolatile memory, refer to the Logix5000 Controllers Nonvolatile Memory Programming Manual, publication [1756-PM017](#).

Considerations for Storing and Loading a Safety Project

GuardLogix



Only GuardLogix® 5580 controllers support safety projects. ControlLogix 5580 controllers do not support safety projects.

You cannot store a safety project if the safety task status is Safety Task Inoperable. When you store a safety project, the controller firmware is also stored to the SD card.

If no application project exists in the controller, you can save only the firmware of the safety controller if a valid partnership exists. A firmware-only load does not clear a Safety Task Inoperable condition.

If a safety signature exists when you store a project, the following occurs:

- Safety tags are stored with the value they had when the signature was first created.
- Standard tags are stored with their current values.
- The current safety signature is saved.

When you store a safety application project on an SD card, Rockwell Automation recommends you select Program (Remote Only) as the Load mode, that is, the mode that the controller enters after a project is loaded from the SD card.

IMPORTANT To prevent the firmware stored on the SD card from overwriting newly-updated firmware:

- The update process first checks the load option on the SD card, and changes the load option to User Initiated if necessary.
- The firmware update proceeds.
- The controller resets.
- The load option remains set to User Initiated.

If the SD card is locked, the load option does not change, and the firmware that is stored on the SD card can overwrite the newly-updated firmware.

Store to the SD Card

ControlLogix



GuardLogix



We recommend that you back up your Logix Designer project to an SD card on a regular basis.

If a major nonrecoverable fault occurs that removes the program from the controller memory, the backup copy on the SD card can be automatically restored to the controller to quickly resume normal controller operation.

To store a project to the SD card, complete these steps.

1. Make sure that the controller is online in Program mode or Remote Program mode.
2. Right-click the controller name and choose Properties.
3. On the Nonvolatile Memory tab, click Load/Store.

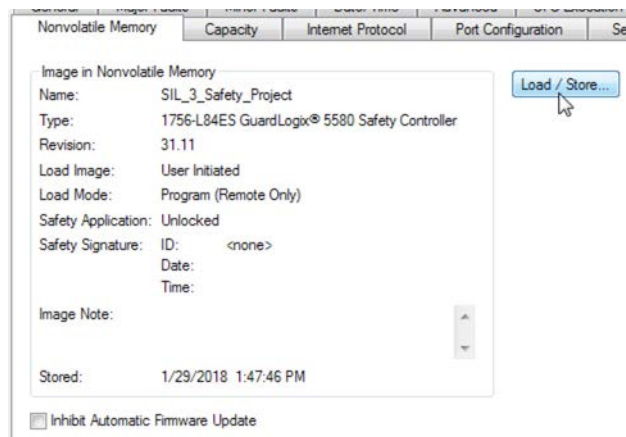

TIP If Load/Store is dimmed (unavailable), verify the following:

- The controller is in Program mode or Remote Program mode
- You have specified the correct communication path.
- The SD card is installed.
- The SD card is unlocked. The locked status appears in the bottom-left corner of the Nonvolatile memory/Load Store dialog box.

If the SD card is not installed, a message in the lower-left corner of the Nonvolatile Memory tab indicates the missing card.

 Nonvolatile memory not present.

4. Change the Load Image properties according to your application requirements.

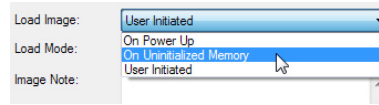

This table describes the Load Image options.

Table 17 - Load Image Options

If you want to load the project	Then select this Load Image option	Notes	Safety Considerations
Whenever you turn on or cycle power	On Power Up	<ul style="list-style-type: none"> During a power cycle, you lose any online changes, tag values, and network schedule that you have not stored in the nonvolatile memory. The controller loads the stored project and firmware at every powerup regardless of the firmware or application project on the controller. You can always use the Studio 5000 Logix Designer® application to load the project. 	<ul style="list-style-type: none"> For a safety application, On Power Up loads whether or not the controller is safety-locked or there is a safety task signature.
Whenever there is no project in the controller and you turn on or cycle chassis power	On Uninitialized Memory	<ul style="list-style-type: none"> If the project has been cleared from memory, this option loads the project back into the controller on power up. The controller updates the firmware on the controller, if required. The application project stored in nonvolatile memory is also loaded and the controller enters the selected mode, either Program or Run. You can always use the Logix Designer application to load the project. 	<ul style="list-style-type: none"> The controller also updates the firmware on the safety partner, if required.
Only through the Logix Designer application	User Initiated	<ul style="list-style-type: none"> If the controller type as well as the major and minor revisions of the project in nonvolatile memory match the controller type and major and minor revisions of the controller, you can initiate a load. 	<ul style="list-style-type: none"> You can initiate a load, regardless of the Safety Task status. You can load a project to a safety-locked controller only when the safety task signature of the project stored in nonvolatile memory matches the project on the controller. If the signatures do not match or the controller is safety-locked without a safety task signature, you are prompted to first unlock the controller. IMPORTANT: When you unlock the controller and initiate a load from nonvolatile memory, the safety-lock status, passwords, and safety task signature are set to the values contained in nonvolatile memory once the load is complete. If the firmware on the primary controller matches the revision in nonvolatile memory, the safety partner firmware is updated, if required, the application stored in nonvolatile memory is loaded so that the Safety Task status becomes Safety Task Operable and the controller enters the Program mode.

IMPORTANT To prevent the firmware stored on the SD card from overwriting newly-updated firmware:

- The update process first checks the load option on the SD card, and changes the load option to User Initiated if necessary.
- The firmware update proceeds.
- The controller resets.
- The load option remains set to User Initiated.

If the SD card is locked, the load option does not change, and the firmware that is stored on the SD card can overwrite the newly-updated firmware.

- Change the Load Mode properties according to your application requirements.

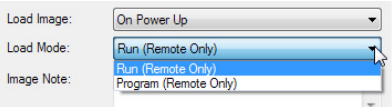
If you want the controller to go to this mode after loading	Then choose	Menu Items
Program	Program (remote only)	
Run	Run (remote only)	

IMPORTANT Safety Consideration

Rockwell Automation recommends that you use Program (Remote Only), when you set the Load Mode for a safety application project.

- According to your application requirements, set the Automatic Firmware Update properties for I/O devices in the configuration tree of the controller. The Automatic Firmware Update property is also referred to as the Firmware Supervisor feature.

IMPORTANT Safety Consideration

Some Safety I/O devices do not support the Firmware Supervisor feature. For example, Safety I/O devices on DeviceNet networks and POINT Guard I/O™ modules do not support the Firmware Supervisor feature.

This table describes the Automatic Firmware Update options for I/O devices.

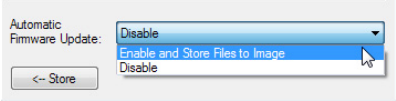
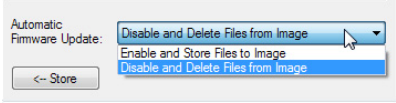
Setting	Description	Menu Items
Disable	Disables any automatic firmware updates. This item only appears in the menu when you initially save the image.	
Enable and Store Files to Image	Enables automatic firmware updates for I/O devices in the configuration tree of the controller. Saves I/O device firmware and controller firmware to the image. Only I/O devices that are configured for Exact Match Keying will participate in the Automatic Firmware Update process. ⁽¹⁾	
Disable and Delete Files from Image	Disables automatic firmware updates for I/O devices in the configuration tree of the controller. Removes I/O device firmware from the image, but does not remove controller firmware from image. This item only appears in the menu on subsequent saves of the image.	

(1) The devices that are used with this option must support the revision of firmware being updated to.

- Click Store.
- Click Yes in the confirmation dialog box that appears.

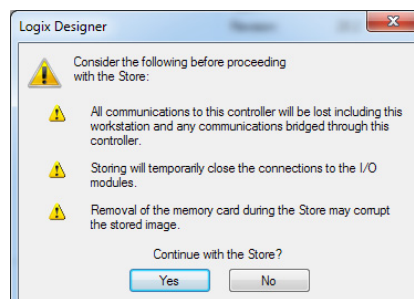

If you enabled Automatic Firmware Update, then a dialog box appears to inform you which modules are not included in the Automatic Firmware Update operation.

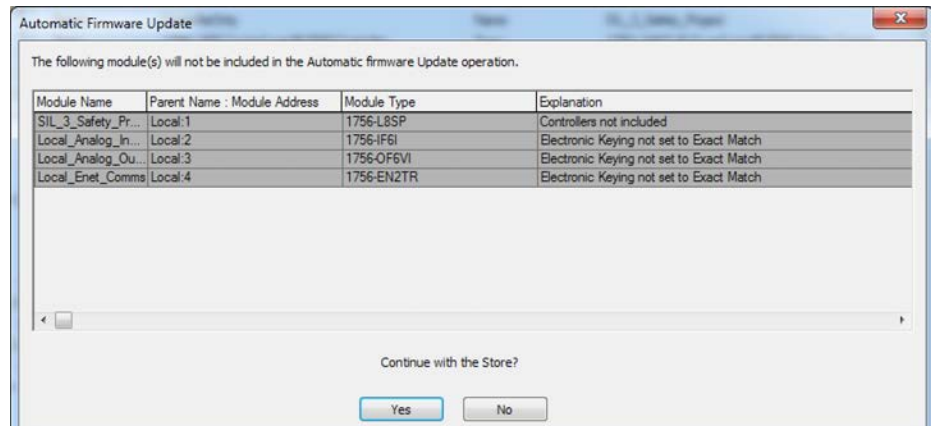

IMPORTANT Do not remove the SD card while the controller is reading from, or writing to, the card. If you remove the card during either activity, the data on the card or controller can become corrupt. Additionally, the controller firmware at the time when the card is removed can become corrupted. Leave the card in the controller until the OK status indicator turns solid green.

9. On the Automatic Firmware Update dialog box, click Yes.

The project is saved to the SD card as indicated by the controller status indicators.

These indications show the store status

While the store is **in progress**, the following occurs:

- OK indicator is flashing green
- SD indicator is flashing green
- Saving... Do Not Remove SD Card is shown on the status display
- A dialog box in the Logix Designer application indicates that the store is in progress
- Controller Resets
- SAVE is shown on the status display

When the store is **complete**, the following occurs:

- The controller resets.
-

IMPORTANT Allow the store to complete without interruption. If you interrupt the store, data corruption or loss can occur.

Load from the SD Card

ControlLogix



GuardLogix



After you have set the communication path, are online with the controller, and have changed the controller to Program mode, you can load a project to the controller from the memory card.

IMPORTANT With the SD card and brand new, out-of-box controllers:

- If you insert an SD card with an image into a brand new, out-of-box controller (firmware 1.x), then at power-up the controller automatically updates the firmware up to the version of firmware that is stored on the SD card. The update happens regardless of the Load Image setting in the image on the SD card (User Initiated, On Power Up, or On Uninitialized Memory).
- If the image was created with either On Power Up or On Uninitialized Memory settings, then the controller both updates the firmware and loads in the controller application.

You can load from an SD card to a controller in one of the following ways:

- [Controller Power-up](#)
- [User-initiated Action](#)

TIP You can always use the Logix Designer application to load the project.

Controller Power-up

This table shows what happens at power up when you insert an SD card that contains an image into a controller.

Image Setting	Controller is in out-of-box condition (v1.x firmware)	Firmware > 1.x and internal non-volatile memory is not valid ⁽²⁾	Firmware > 1.x and internal non-volatile memory is valid ⁽²⁾
User Initiated	Loads Firmware Only ⁽¹⁾	Does Nothing	Does Nothing
On Power Up	Loads both Firmware and Application	<ul style="list-style-type: none"> • Loads Firmware if there is a revision mismatch • Loads Application 	<ul style="list-style-type: none"> • Loads Firmware if there is a revision mismatch • Loads Application
On Uninitialized Memory	Loads both Firmware and Application ⁽¹⁾	<ul style="list-style-type: none"> • Loads Firmware if there is a revision mismatch • Loads Application 	Does Nothing

(1) Indicates change in behavior from ControlLogix 5570 and older controllers.

(2) "Valid" includes the No Project condition.

User-initiated Action

IMPORTANT For an out-of-box controller that uses firmware revision 1.xx, you must manually update the controller to the required firmware revision before you can load a project on the controller.

You must complete the following before you can upload a project to the controller from the SD card when the controller is already powered-up:

- Make sure that the controller has a working firmware revision.
- Establish the communication path.
- Go online with the controller.
- Make sure that the controller is in Program mode.

To load a project to the controller from the memory card, complete these steps.

1. Open the Controller Properties, and click the Nonvolatile Memory tab.
2. On the Nonvolatile Memory tab, verify that the project listed next to Name: is the project that you want to load.



TIP If no project is stored on the SD card, a message in the lower-left corner of the Nonvolatile Memory tab indicates that an image (or project) is not available as shown here.

 No image in the nonvolatile memory.

TIP For information on how to change the project that is available to load from nonvolatile memory, see the Logix5000 Controllers Nonvolatile Memory Programming Manual, publication [1756-PM017](#).

3. Click Load/Store.

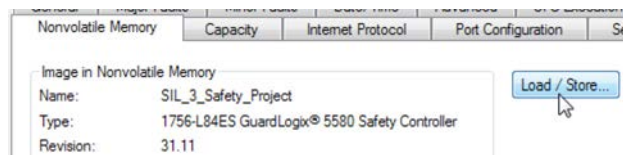

TIP If Load/Store is dimmed (unavailable), verify the following:

- You have specified the correct communication path and are online with the controller.
- The SD card is installed.
- Verify that the controller is not in Run Mode.

4. Click Load.

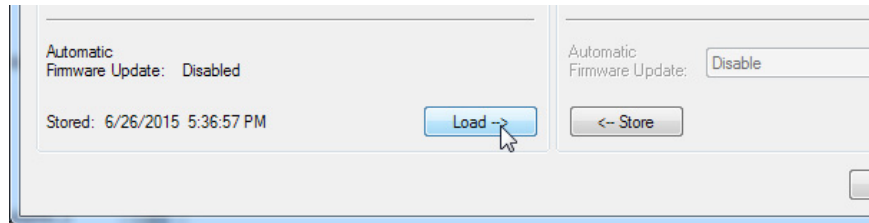

After you click Load, the project loads to the controller as indicated by the controller status indicators.

These indications show the load status

While the **load is in progress**, the following occurs:

- OK indicator is solid red
- SD indicator is flashing green
- Loading... Do Not Remove SD Card is shown on the status display
- Updating Firmware... Do Not Remove SD Card can be shown on the status display if the firmware is also updating with the load
- A dialog box in the Logix Designer application indicates that the store is in progress

When the **load is complete**, the following occurs:

- Controller reboots.

IMPORTANT Let the load to complete without interruption. If you interrupt the load, data corruption or loss can occur.

Other Secure Digital Card Tasks

ControlLogix



GuardLogix



You can perform these tasks with the SD card:

- Change the image that is loaded from the card
- Check for a load that was completed
- Clear an image from the SD card
- Store an empty image
- Change load parameters
- Read/write application data to the card
- View safety-lock status and safety signatures on the Non-volatile Memory tab - GuardLogix 5580 controllers only.

For more information to complete any of these tasks, see the Logix5000 Controllers Memory Card Programming Manual, publication [1756-PM017](#).

Manage Controller Communication

Topic	Page
Connection Overview	111
Nodes on an EtherNet/IP Network	112
Controller Communication Interaction with Control Data	114
Produce and Consume (Interlock) Data	115
Send and Receive Messages	117
Socket Interface	118

Connection Overview

ControlLogix



GuardLogix



The controller provides connection resources whenever communications are established between two devices.

Connections are used when the system contains the following conditions or activities:

- I/O modules, communication modules, and adapter modules are present in the I/O configuration of the user project.
- Produced or Consumed tags are configured in the user project.
- Connected Messages are executed in the user application.
- External devices, programming terminals, or HMIs communicate with the controller.

Nodes on an EtherNet/IP Network

ControlLogix



GuardLogix



When configuring your control system, you must account for the number of EtherNet/IP nodes you include in the I/O configuration tree in your project. [Table 18](#) shows the maximum number of EtherNet/IP nodes supported for each controller.

With firmware revision 29 and later, the Ethernet Nodes field on the Controllers Properties Capacity tab keeps a running count as you add EtherNet/IP nodes to the I/O configuration tree. See [Figure 22 on page 113](#).

Table 18 - Maximum Number of Ethernet/IP Nodes Supported

System	Cat. No. ⁽¹⁾	Version 28	Version 29	Version 30	Version 31
ControlLogix®	1756-L81E	—	60	100	100
	1756-L82E	—	80	175	175
	1756-L83E	100	100	250	250
	1756-L84E	—	150	250	250
	1756-L85E	300	300	300	300
GuardLogix®	1756-L81ES	—	—	—	100
	1756-L82ES	—	—	—	175
	1756-L83ES	—	—	—	250
	1756-L84ES	—	—	—	250

(1) This table also applies to conformed coated catalog numbers. Controller catalog numbers followed by a “K” indicate a conformed coated model.

IMPORTANT EtherNet/IP communication modules in the local chassis with the controller do not count as nodes, but EtherNet/IP devices connected to the communication modules do count as nodes. See [Figure 22 on page 113](#).

Devices Included in the Node Count

Any EtherNet/IP devices that you add to the I/O configuration section are counted toward the controller node limits. The following are examples of devices that must be counted:

- Remote communication adapters
- Remote controllers.
- Devices with an embedded EtherNet/IP port, such as I/O modules, drives, and linking devices
- EtherNet/IP devices connected to a communication module in the local chassis, even though the communication module in the local chassis does not count as a node. See [Figure 22 on page 113](#).
- HMI devices that are included in the I/O configuration section, for example, PanelView™ Plus terminals.
- Third-party devices that are directly connected to the EtherNet/IP network.

Devices Excluded from the Node Count

When considering the EtherNet/IP node limitation of a ControlLogix 5580 controller, you do not count Ethernet devices that exist on the EtherNet/IP network but are not added to the I/O configuration section of the project.

The following devices are **not added** to the I/O configuration section in your project and are **not counted** among the total number of nodes:

- Computer
- Communication modules in the local chassis.
- HMIs that are not added to the I/O configuration section.
- Devices that are the target of MSG Instructions
- Standard Ethernet devices with which the controller communicates via a socket interface

This example shows four nodes in the I/O tree.

Figure 22 - EtherNet/IP Nodes Example

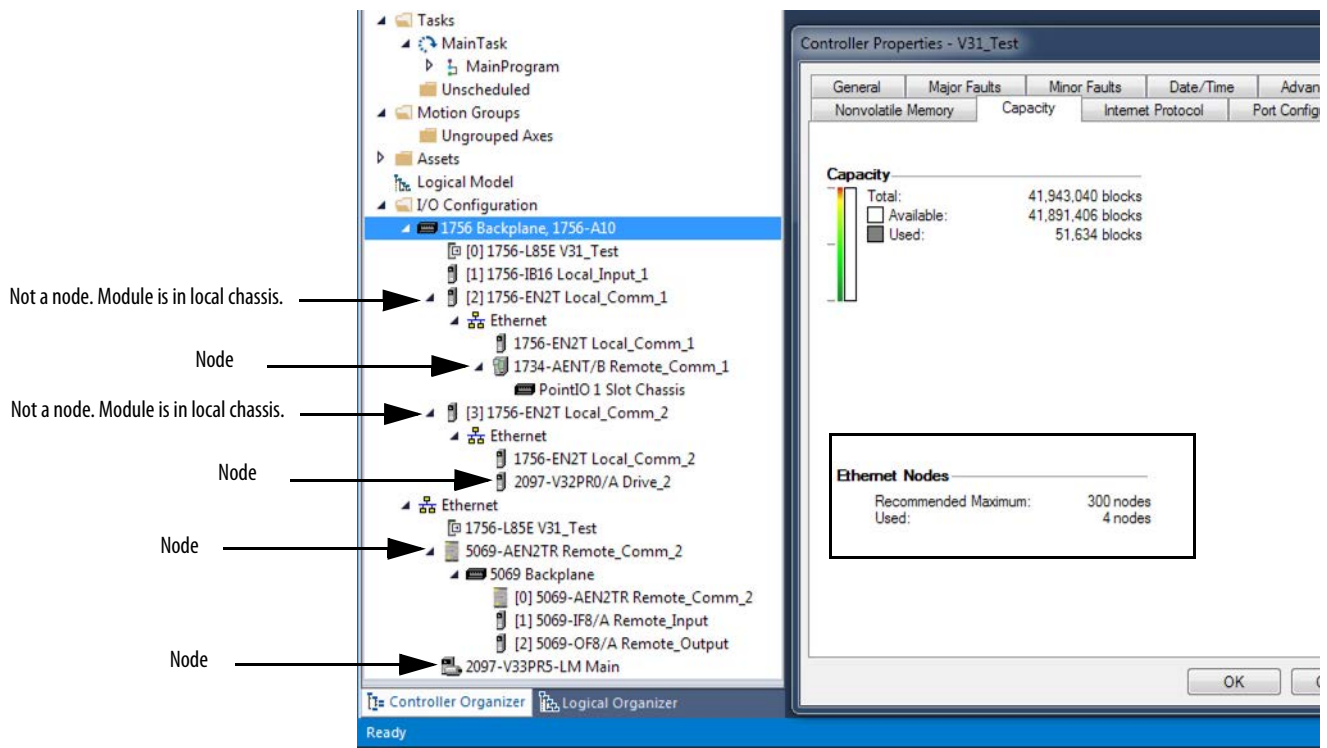

Controller Communication Interaction with Control Data

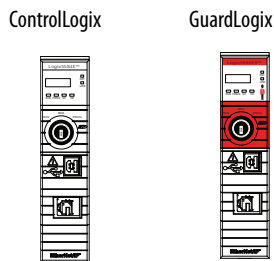

The controller runs the communications task separately from the application code. The controller runs communications asynchronously to the application. Therefore, it is important to make sure communications that are delivered to the controller are complete before the application executes on the newly delivered data. This applies to data that is coming into the controller and data that is going out from the controller.

For example, if an HMI device writes a large block of recipe data to the controller, the application code can start to execute on that data before the data is written. This action results in half of the current recipe and half of the last recipe in the application space.

Traditionally, programmers have used the following to control the effects of asynchronous communications:

- UID/UIE pairs
- Periodic tasks
- Moving data with CPS instructions.

These options rely on controlling when the main core can switch tasks. As a result, the communication task cannot change data when the control task is using it. Because the controller processes communications on an independent CPU core, these methods are no longer effective in all cases.

[Table 19](#) highlights the controllers behavior.

Table 19 - ControlLogix 5580 and GuardLogix 5580 Controller Behavior

Application Construct	Tag Access					
	HMI	MSG	I/O Update	Produce/Consume	Other User Tasks	Motion Planner
UID/UIE	Allows	Allows	Allows	Allows	Blocks	Allows
CPS	Blocks	Blocks	Blocks	Blocks	Allows	Allows
Periodic Tasks	Allows	Allows	Allows	Allows	Allows	Allows

Blocks - HelOps to prevents source data values from change by communications during application execution.

Allows - Communications can change source data values during application execution.

Because the controllers have 32-bit data integrity, this only applies to data structures larger than 32 bits. If word-level integrity is your primary concern, the 32-bit data integrity does not impact your data use.

Good programming practice dictates the use of two unique words at the beginning and the end of data. The controller validates the words to assure the entire structure has data integrity. We recommend that the handshake data is changed and the application code validates it every transaction before the controller application code or higher-level system reading controller data acts on it.

Table 20 shows two data elements added to a structure for data integrity checking: Start Data and End Data. We recommend that the controller validates the Start Data value and the End Data value match before the controller acts on My_Recipe1.

If the Start Data and End Data values do not match, it is likely communications is in the process of filling the structure. The same applies to higher-level systems that are receiving data from the controller.

Table 20 - Data Elements

Structure	My_Recipe1	My_Recipe2	My_Recipe3
Start Data	101	102	103
Sugar	3	4	8
Flour	4	3	9
Chocolate	2	2	4
Oil	6	7	2
End Data	101	102	103

TIP We recommend that you perform this test on a buffered copy of the data and not the actual data element being written to by the communications core. If you use buffered data, you help prevent the risk of the communication core changing data after you have passed the data valid test.

Produce and Consume (Interlock) Data

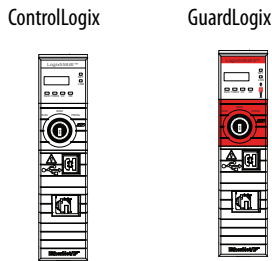

The controllers let you produce (transmit) and consume (receive) controller-scoped tags. ControlLogix 5580 controllers and GuardLogix 5580 controllers produce the same standard tag through both the Ethernet port and the backplane, and consumer counts apply to the total consumers from both ports.

Figure 23 - Illustration of Produced and Consumed Tags

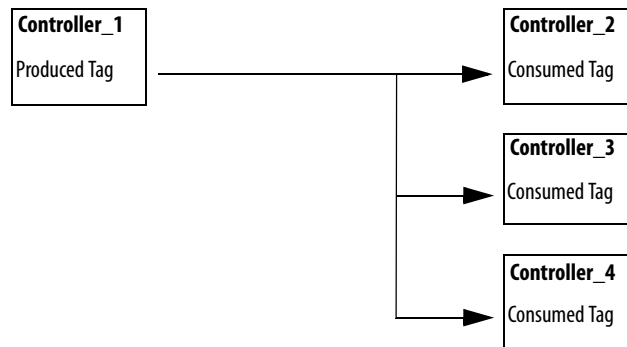

[Table 21](#) describes the system-shared tags.

Table 21 - Produced and Consumed Tag Definitions

Tag	Definition
Produced tag	A tag that a controller makes available for use by other controllers. Multiple controllers can simultaneously consume (receive) the data. A produced tag sends its data to one or more consumed tags (consumers) without using logic.
Consumed tag	A tag that receives the data of a produced tag. The data type of the consumed tag must match the data type (including any array dimensions) of the produced tag. The RPI of the consumed tag determines the period at which the data updates.

For two controllers to share produced or consumed tags, the controllers must be attached to the same network. You cannot bridge produced and consumed tags over two networks.

Produced and consumed tags use connections of the controller and the communication modules being used. For information on Produced/Consumed Safety Tags for GuardLogix 5580 controllers, see [Produced/Consumed Safety Tags on page 179](#).

For a ControlNet network, produced and consumed tags use scheduled connections.

Table 22 - ControlNet Connections

Connection	Definition
Scheduled (unique to a ControlNet network)	<p>A scheduled connection is unique to ControlNet communication. A scheduled connection lets you send and receive data repeatedly at a predetermined interval, which is the requested packet interval (RPI). For example, a connection to an I/O module is a scheduled connection because you repeatedly receive data from the module at a specified interval.</p> <p>Other scheduled connections include connections to the following:</p> <ul style="list-style-type: none"> • Communication devices • Produced/consumed tags <p>On a ControlNet network, you must use RSNetWorx™ for ControlNet software to enable all scheduled connections and establish a network update time (NUT). A scheduled connection reserves network bandwidth specifically to handle the connection.</p>
Unscheduled	<p>An unscheduled connection is a message transfer between devices that the requested packet interval (RPI) or the program, such as a MSG instruction, triggers. Unscheduled messaging lets you send and receive data as you need.</p> <p>Unscheduled connections use the remainder of network bandwidth after scheduled connections are allocated.</p>

Requested Packet Interval (RPI) of Multicast Tags

The first consumer of a multicast produced tag on any given communications port establishes the RPI value for that port. All subsequent consumers using the same port must request the same RPI value as the first consumer, otherwise they will fail to connect. Controllers with backplane and EtherNet/IP ports can produce data at an independent RPI value on each port.

For more information about produced/consumed tags, see the Logix5000™ Controllers Produced and Consumed Tags Programming Manual, publication [1756-PM011](#).

Send and Receive Messages

ControlLogix



GuardLogix



Messages transfer standard or safety data to other devices, such as other controllers or operator interfaces. The MSG instruction is a ladder logic output instruction that asynchronously reads or writes a block of data to or from another module over the backplane or a network. The size of the instruction depends on the data types and message command that you program.

Messages use connection resources to send or receive data. Messages can leave the connection open (cached) or can close the connection when the message is done transmitting.

Messages can be either unconnected or connected. Unconnected messages are dependent upon the availability of unconnected buffers in all of the devices through which the message passes. Connected messages begin with a request to allocate connection buffers in all of those devices, before sending the actual message. Choosing to cache a connected message instructs the controller to keep the connection open after the message has been completed - this improves efficiency if the message is intended to be sent repeatedly.

Connected messages use connection resources. If the connected message is uncached, the resources are used temporarily each time the message is triggered. As long as a cached connected message remains in the cache, the resources remain allocated and are not available for other messages. Messages can get pushed from the cache if the application exceeds the cache capacity of the controller.

Each message uses one connection out of the controller, regardless of how many devices are in the message path.

Table 23 - Message Types

Message Type	Communication Method	Connected Message	Message Can Be Cached
CIP data table read or write	N/A	Configurable	Yes ⁽²⁾
PLC-2 [®] , PLC-3 [®] , PLC-5 [®] , or SLC™ (all types)	CIP	No	No
	CIP with Source ID	No	No
	DH+™	Yes	Yes ⁽²⁾
CIP generic	N/A	Optional ⁽¹⁾	Yes ⁽²⁾
Block-transfer read or write	N/A	Yes	Yes ⁽²⁾

(1) You can connect CIP generic messages. However, for most applications we recommend that you leave CIP generic messages unconnected.

(2) Connected messages that occur more frequently than once every 60 seconds should be cached if possible.

For more information about using messages, see the Logix5000 Controllers Messages Programming Manual, publication [1756-PM012](#).

Determine Whether to Cache Message Connections

When you configure a MSG instruction, you can choose whether to cache the connection. Use [Table 24](#) to determine options for caching connections.

Table 24 - Options for Caching Connections

If the message executes	Then
Repeatedly	Cache the connection. This keeps the connection open and optimizes execution time. Opening a connection each time the message executes increases execution time.
Infrequently	Do not cache the connection. This closes the connection upon completion of the message, which frees up that connection for other uses.

TIP Cashed connections transfer data faster than uncashed connections. The controllers can cache 256 messages and trigger 256 messages simultaneously.

Socket Interface

ControlLogix



GuardLogix



The controller can use socket interfaces to communicate with Ethernet devices that do not support the EtherNet/IP application protocol. The socket interface is implemented via the Socket Object. The controller communicates with the Socket Object via MSG instructions. MSG instructions that configure and operate the socket interface must be configured as Unconnected, and use the Message to Self path. To communicate with another device, you must understand the application protocol of the other device.

The controllers support up to 32 socket instances on a per-module basis; 32 sockets for the embedded Ethernet port, plus 32 more for each Ethernet bridge module in the local chassis.

For more information on the socket interface, see EtherNet/IP Socket Interface Application Technique, publication [ENET-AT002](#).

Standard I/O Modules

Topic	Page
Selecting ControlLogix I/O Modules	119
Local I/O Modules	121
Remote I/O Modules	126
Add to the I/O Configuration While Online	133
Determine When Data is Updated	135

Selecting ControlLogix I/O Modules

ControlLogix



GuardLogix



Rockwell Automation offers many I/O modules for use in ControlLogix® controller systems. For a list of all I/O product lines that are compatible with the ControlLogix controllers, see the 1756 ControlLogix Controllers Technical Data, publication [1756-TD001](#).

When you select I/O modules, remember the following:

- A wide variety of digital, analog, and specialty I/O modules are available from Rockwell Automation. A number of these I/O modules support the following features:
 - Field-side diagnostics
 - Electronic fusing
 - Individually isolated inputs/outputs
 - Timestamping of inputs
 - Scheduling of outputs
 - Event detection of specific input patterns
- Removable terminal blocks (RTBs) or 1492 wiring systems are required for use with I/O modules, and you may have to order these separately.
- 1492 PanelConnect™ modules and cables can be used to connect input modules to sensors.

Electronic Keying

Electronic Keying reduces the possibility that you use the wrong device in a control system. It compares the device that is defined in your project to the installed device. If keying fails, a fault occurs. These attributes are compared.

Attribute	Description
Vendor	The device manufacturer.
Device Type	The general type of the product, for example, digital I/O module.
Product Code	The specific type of the product. The Product Code maps to a catalog number.
Major Revision	A number that represents the functional capabilities of a device.
Minor Revision	A number that represents behavior changes in the device.

The following Electronic Keying options are available.

Keying Option	Description
Compatible Module	<p>Lets the installed device accept the key of the device that is defined in the project when the installed device can emulate the defined device. With Compatible Module, you can typically replace a device with another device that has the following characteristics:</p> <ul style="list-style-type: none"> • Same catalog number • Same or higher Major Revision • Minor Revision as follows: <ul style="list-style-type: none"> – If the Major Revision is the same, the Minor Revision must be the same or higher. – If the Major Revision is higher, the Minor Revision can be any number.
Disable Keying	<p>Indicates that the keying attributes are not considered when attempting to communicate with a device. With Disable Keying, communication can occur with a device other than the type specified in the project.</p> <p>ATTENTION: Be cautious when using Disable Keying; if used incorrectly, this option can lead to personal injury or death, property damage, or economic loss.</p> <p>We strongly recommend that you do not use Disable Keying.</p> <p>If you use Disable Keying, you must take full responsibility for understanding whether the device being used can fulfill the functional requirements of the application.</p>
Exact Match	Indicates that all keying attributes must match to establish communication. If any attribute does not match precisely, communication with the device does not occur.

Carefully consider the implications of each keying option when selecting one.

IMPORTANT When you change Electronic Keying parameters online, it interrupts connections to the device and any devices that are connected through the device. Connections from other controllers can also be broken.

If an I/O connection to a device is interrupted, the result can be a loss of data.

More Information

For more detailed information on Electronic Keying, see Electronic Keying in Logix5000 Control Systems Application Technique, publication [LOGIX-AT001](#).

Local I/O Modules

ControlLogix



GuardLogix



The ControlLogix chassis that you choose affects how many local I/O modules you can use. Several ControlLogix chassis sizes are available to suit your configuration requirements. You can fill the slots of your chassis with any combination of controllers, communication modules, and I/O modules.

[Table 25](#) lists the available ControlLogix chassis and the number of slots available with each.

Table 25 - ControlLogix and ControlLogix- Chassis and Slots

Chassis	Slots
1756-A4	4
1756-A4LXT	
1756-A5XT	5
1756-A7	7
1756-A7LXT	
1756-A7XT	
1756-A10	10
1756-A13	13
1756-A17	17

If you have empty slots in your chassis, you can use the 1756-N2 or 1756-N2XT slot-filler module.

Add Local I/O to the I/O Configuration

If you are adding local I/O, add the I/O module to the backplane with the controller. To add an I/O module to the local chassis, complete these steps.

There are two methods to add local I/O modules to the project:

- [Discover Modules on page 122](#)
- [New Module on page 124](#)

Discover Modules

To use Discover Modules to add a local I/O module, complete these steps.

1. Go online with your Studio 500 Logix Designer® application.
2. Right-click the 1756 Backplane, and choose Discover Modules.

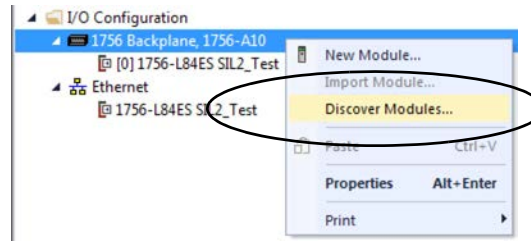

The Logix Designer application automatically detects available modules that are installed in the system.

3. At the Select Module Type window, click Create to add a discovered module to your project.

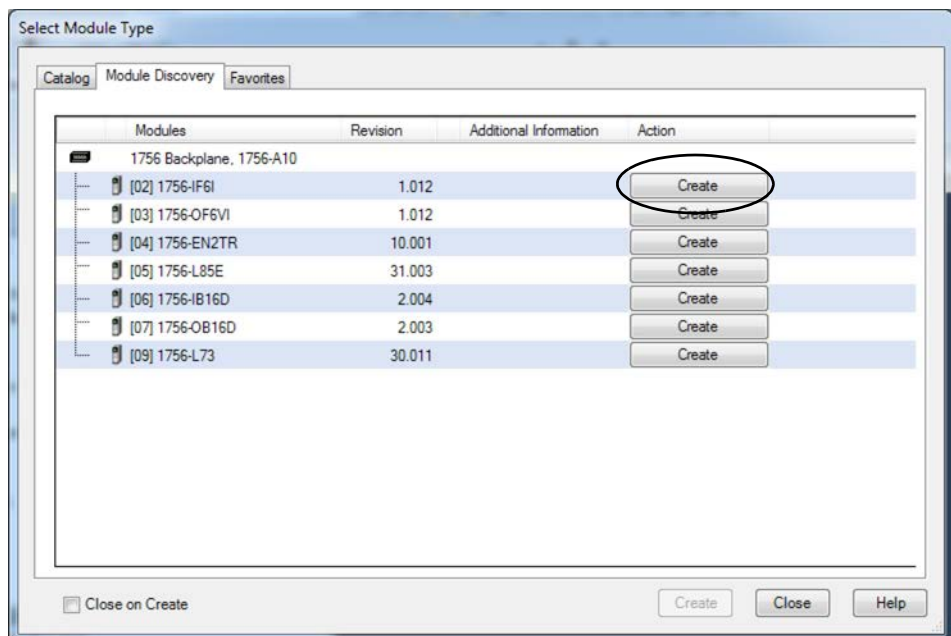

- At the New Module window, configure the module properties and click OK.

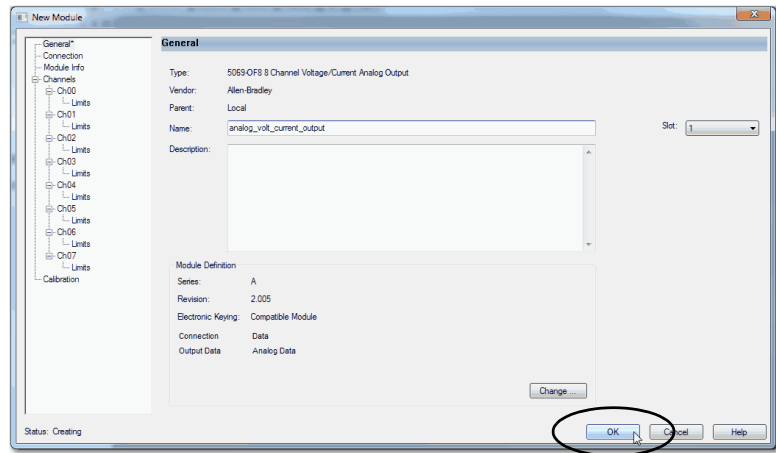

- At the warning dialog box, click Yes.

TIP If you inhibit the module connection, you must remember to uninhibit the connection later.

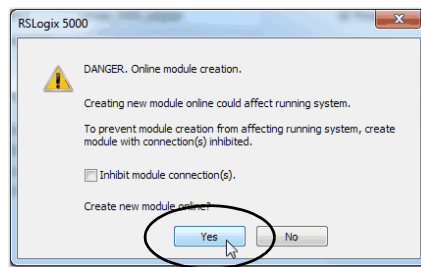

- Close the Select Module Type dialog box.

To add additional local I/O modules, complete one of the following:

- If you cleared the Close on Create checkbox when you created the first I/O module, repeat steps [3...6](#).
- If you did not clear the Close on Create checkbox when you created the first I/O module, repeat steps [2...6](#).

New Module

1. Right-click the backplane, and choose New Module.

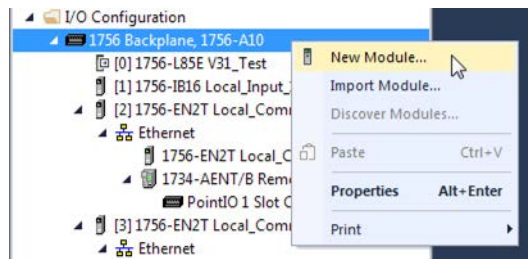

2. Select the I/O module and click Create.

TIP Use the filters to reduce the list of modules to choose from.

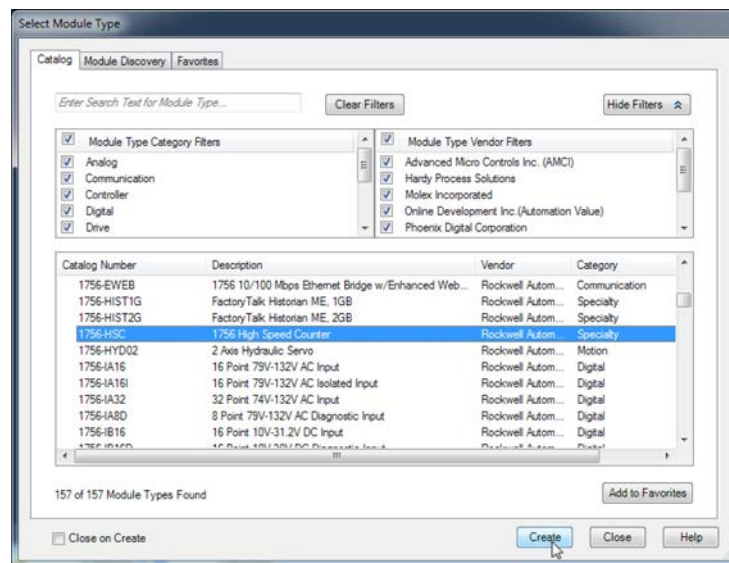

The New Module dialog box appears.

3. Configure the module and click OK.

TIP Remember, if the Series and Revision parameter values do not match those of the module for which this configuration is intended, your project can experience module faults.

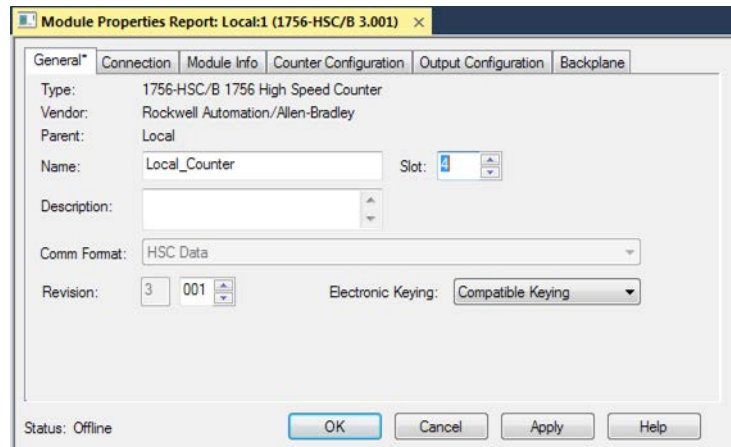

To add additional local I/O modules, complete one of the following:

- If you cleared the Close on Create checkbox when you created the first I/O module, repeat steps [2...3](#).
- If you did not clear the Close on Create checkbox when you created the first I/O module, repeat steps [1...3](#).

See the [Additional Resources](#) section in the preface for more information if you are designing your ControlLogix System for any of the following modules:

- Analog I/O
- Configurable flowmeter
- Digital I/O
- HART analog I/O
- High-speed analog I/O
- High-speed counter
- Low-speed counter
- Programmable limit switch

Remote I/O Modules

ControlLogix



GuardLogix



Remote I/O refers to I/O that is not in the local chassis and connects to the controller via a communication network. There are several families of I/O that are remote from the controller:

- COMPACT 5000™ I/O modules in a remote bank using a 5069-AEN2TR or similar adapter
- 1756 I/O in a remote chassis via a Network Bridge Module
- Distributed I/O families such as Point or Block I/O™
- On-machine™ I/O families such as ArmorPOINT® or ArmorBlock® I/O

The ControlLogix controller supports the use of remote I/O via these networks:

- EtherNet/IP
- ControlNet
- DeviceNet
- Universal remote I/O

For more information about the network configurations that can be used to connect remote I/O, see [Communication Networks on page 31](#).

Figure 24 - ControlLogix 5580 Controller and Remote I/O on a 1 Gbps EtherNet/IP Network

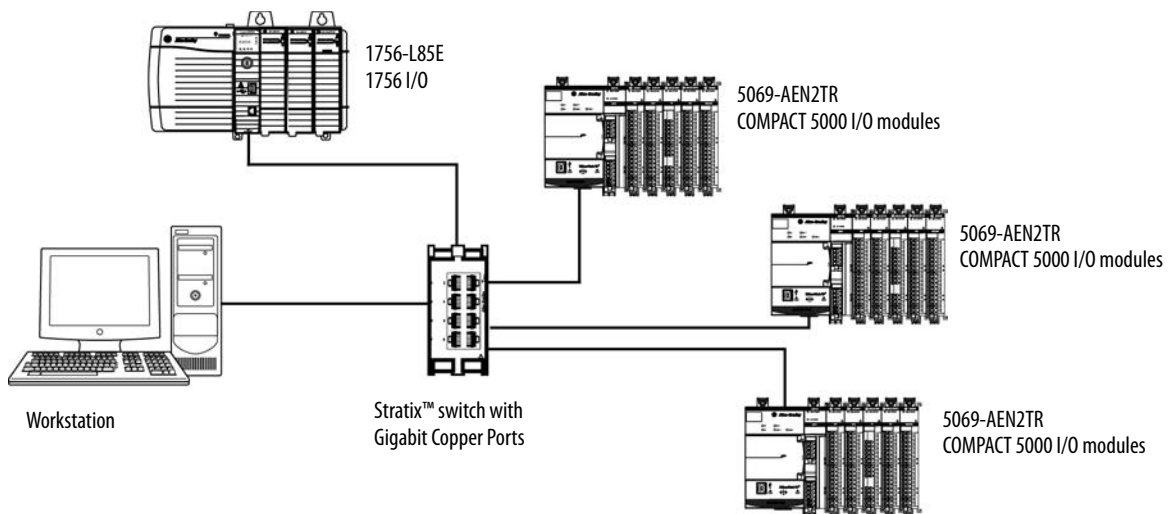

Add Remote I/O to the Ethernet Port on the Controller

If you are adding remote I/O, you can add the I/O modules to the Ethernet port of the controller. To add remote I/O to the I/O Configuration folder in the Logix Designer application, complete these steps.

IMPORTANT You cannot bridge through the Ethernet (front) port of another controller to add remote I/O.

1. In the I/O Configuration tree, right-click Ethernet and choose New Module.

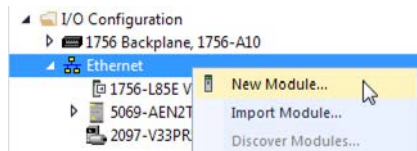

2. Select the remote communication module or EtherNet/IP device.

TIP Use the filters to reduce the list of modules to choose from.

For some modules, the Select Major Revision dialog box can appear. If the dialog box appears, choose the major revision of the module and click OK.

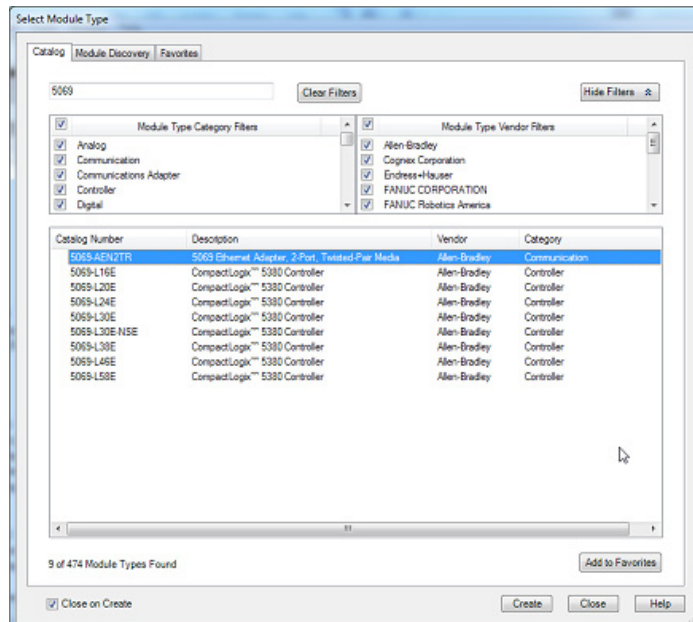

3. Make sure Close on Create is checked.
4. Click Create.
5. Specify the communication module properties according to your network configuration.

For more information about the communication module and network properties, see the [Additional Resources](#) section in the Preface.

- Right-click the backplane of the newly added communication module, and choose New Module.

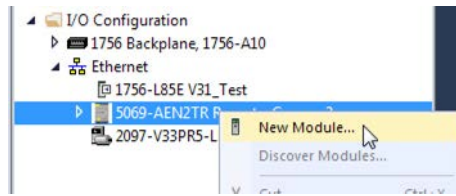

- Select the I/O module that you want to add and click OK.

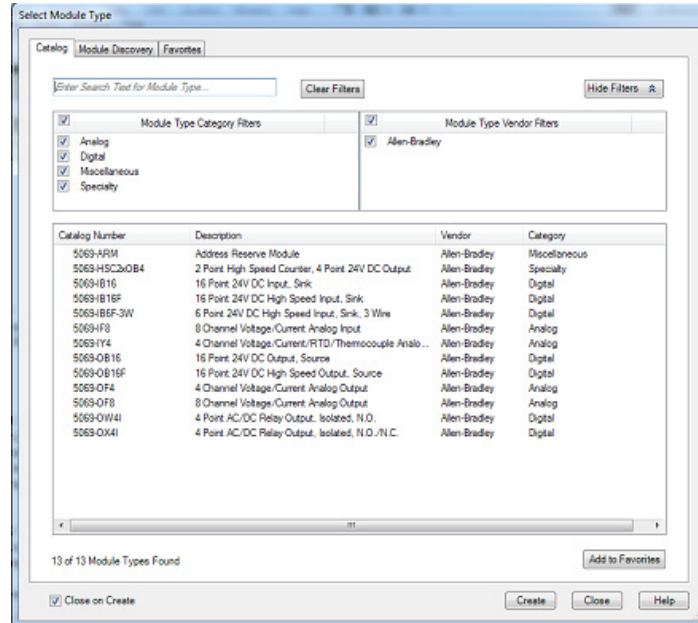

- Make sure Close on Create is checked.
- Click Create.
- Specify the Module Properties according to your module and application.

See the [Additional Resources](#) section in the Preface for more information about the module configuration properties for any of the following modules:

- Analog I/O
- Configurable flowmeter
- Digital I/O
- HART analog I/O
- High-speed analog I/O
- High-speed counter
- Low-speed counter
- Programmable limit switch

11. Add any other I/O modules that you are using in the remote chassis.

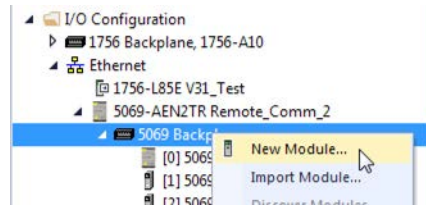

12. Complete steps 1...11 until your remote I/O network and I/O modules are configured.

Add Remote I/O to a Local Communication Module

If you are using local communication modules that are connected to the controller, then add the I/O modules to the backplane of the communication module. To add remote I/O to the I/O Configuration tree in the Logix Designer application, complete these steps.

1. Right-click the backplane of the local chassis, and choose New Module.

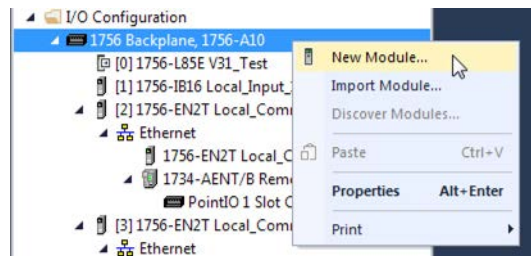

2. Select a communication module.

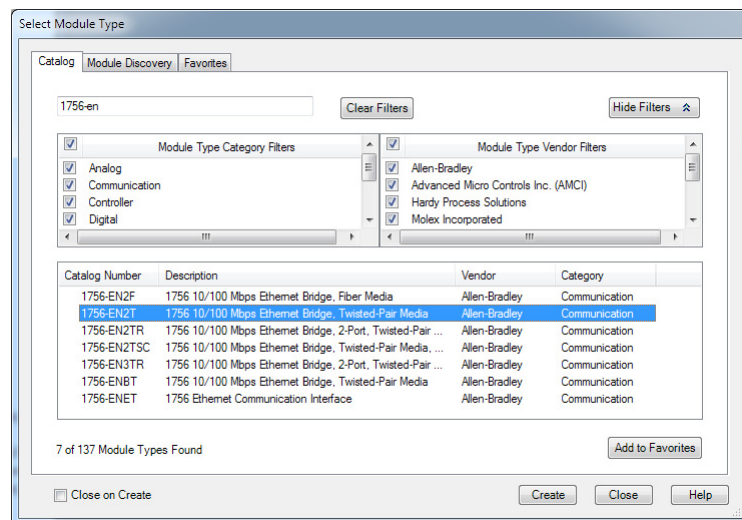

3. Click Create.

- Specify the communication module properties according to your network configuration.

For more information about the communication module and network properties, see the [Additional Resources](#) section in the Preface.

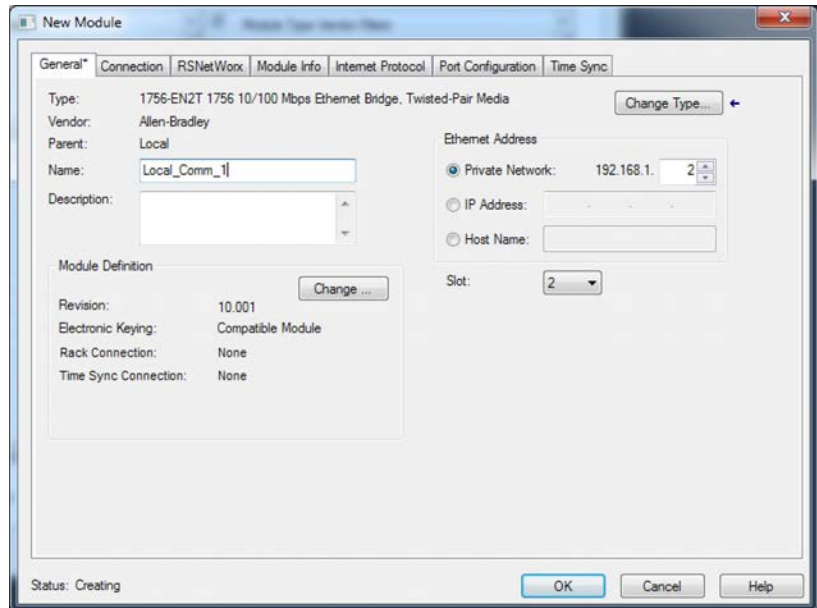

- Click OK.
- Click Close on the Select Module Type dialog box.
- Right-click the communication network under the communication module, and choose New Module.

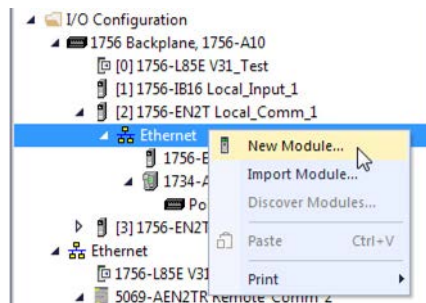

8. Select the communication adapter for the I/O platform that you are using.

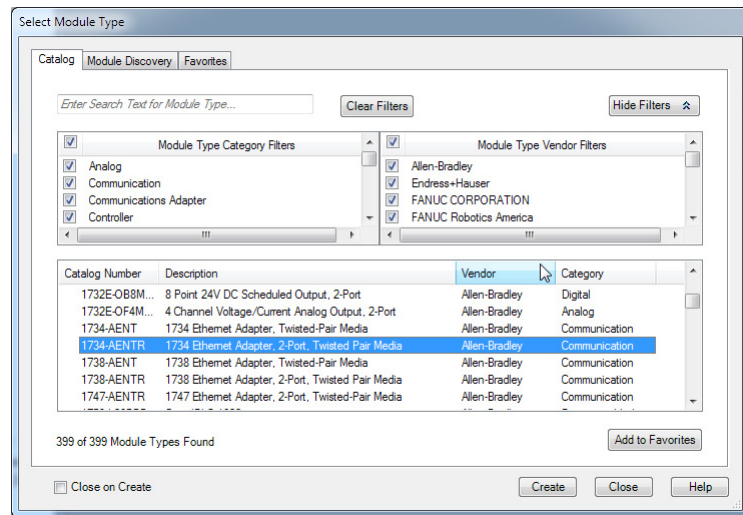

9. Click Create.
10. Specify the module and connection properties according to your network configuration.

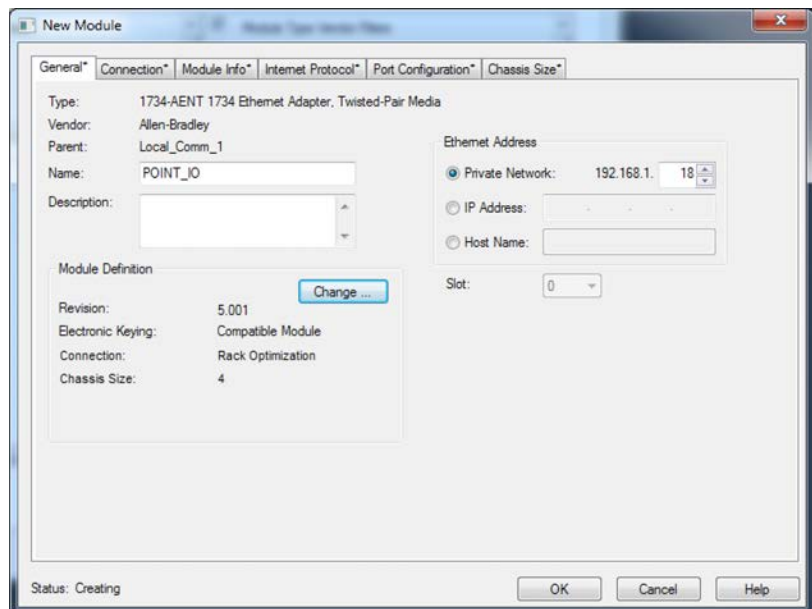

11. Click OK.
12. Click Close on the Select Module Type dialog box.

- Right-click the backplane of the newly added communication adapter and choose New Module.

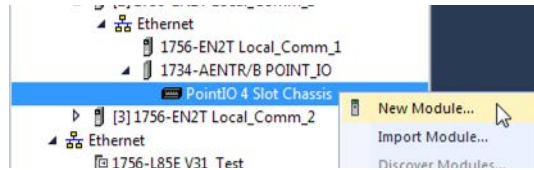

- Select the I/O module that you want to add, and click Create.

TIP Use the filters to reduce the list of modules to choose from.

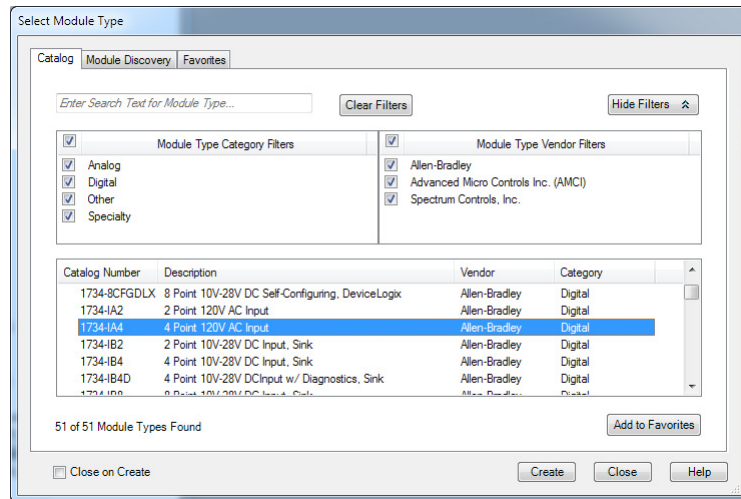

- Specify the Module Properties according to your module and application. For more information about the module configuration properties, see the user manual for the I/O module you are adding.

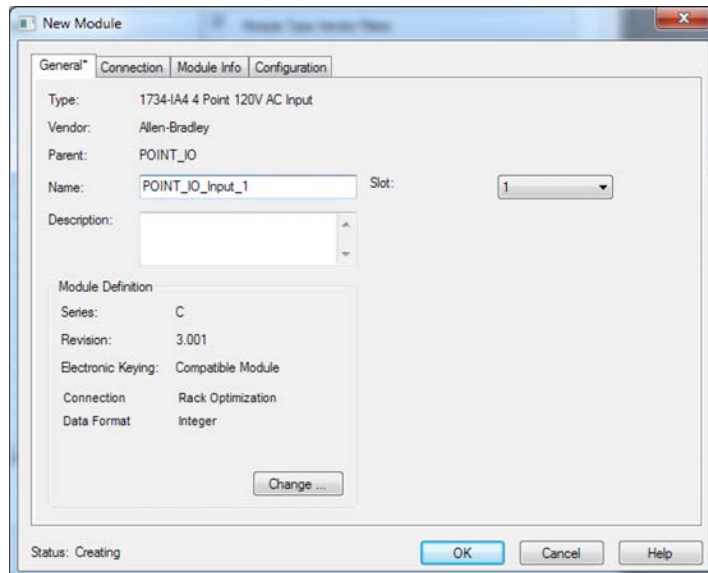

- Add any other I/O modules that you are using in this bus.
- Complete steps 1...16 until your remote I/O network and I/O modules are configured.

Add to the I/O Configuration While Online

You can add I/O and other devices to the controller configuration while you are online, and the mode switch is in either the REM or PROG positions.

ControlLogix



GuardLogix



IMPORTANT To add I/O modules when the controller is online, the controller mode switch must be in the REM or PROG position.

The I/O modules must already be installed in the system. You cannot install the I/O modules when the system is powered.

The modules and devices you can add while online depends on the version of the software you are using. Later versions have more modules and devices that can be added while online.

Add-on Profiles (AOP) for modules are made available between releases of different Logix Designer application versions. There are cases in which, after you download and install the AOP file for a module, you can add the module to a project while online.

To see a list of the available AOP files, go to:

<https://download.rockwellautomation.com/csd/download.aspx?downloadid=addonprofiles>

You can add modules and devices to the local or remote chassis via an EtherNet/IP network, or via the unscheduled portion of a ControlNet network.

For information on the number of nodes you can have for an EtherNet/IP network, see [Nodes on an EtherNet/IP Network on page 112](#).

For more information about adding to the I/O Configuration while online, see the Logix5000 Controllers Design Considerations Reference Manual, publication [1756-RM094](#).

Modules and Devices that Can be Added While Online

You can add these modules and devices to the I/O configuration while online with Logix Designer, version 28.00.00 or later.

- 1756 controllers
- 1756 ControlNet modules
- 1756 DeviceNet bridges
- 1756 EtherNet/IP modules
- 5069 EtherNet/IP adapters
- COMPACT 5000 I/O modules
- 1756 I/O and specialty modules
- 1756-DHRIO
- 1756-DHRIOXT

IMPORTANT These ControlLogix modules **cannot** be added while online:

- Motion modules (1756-M02AE, 1756-HYD02, 1756-M02AS, 1756-M03SE, 1756-M08SE, 1756-M08SEG, 1756-M16SE)
 - 1756-RIO
 - 1756-SYNCH
 - Safety I/O
-

Determine When Data is Updated

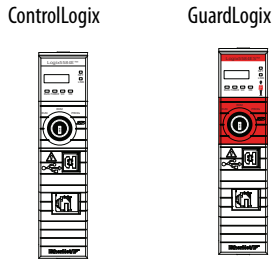

ControlLogix controllers update data asynchronously with the execution of logic. See these flowcharts to determine when a controller, input module, or bridge sends data:

- [Input Data Update Flowchart](#) on this page
- [Output Data Update Flowchart on page 136](#)

Input Data Update Flowchart

IMPORTANT Safety Consideration

GuardLogix standard inputs are updated just like ControlLogix standard inputs, but GuardLogix safety input tags (inputs, consumed, and mapped) are updated and frozen at the beginning of safety task execution. See [Safety Task Execution on page 176](#).

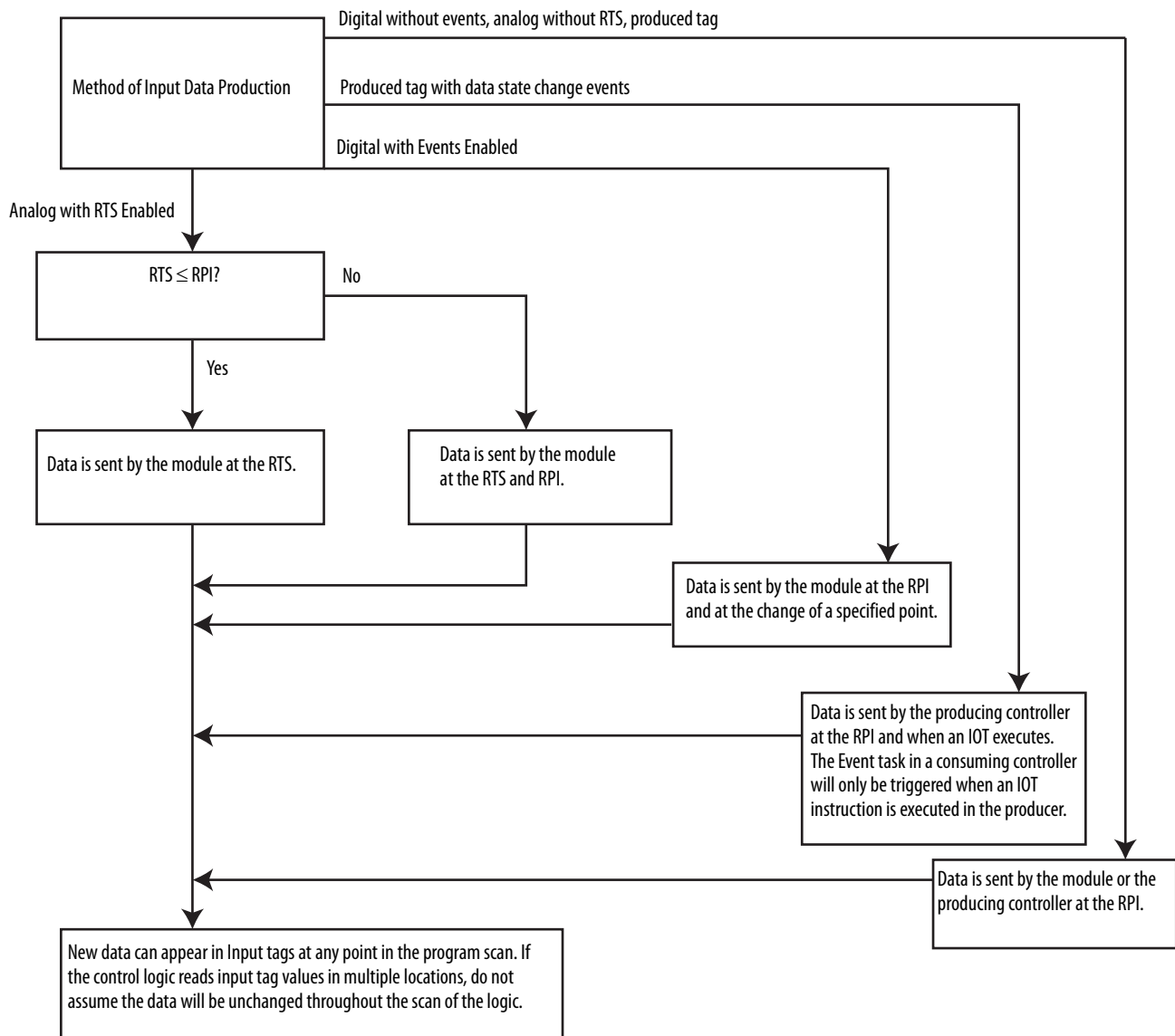

Output Data Update Flowchart

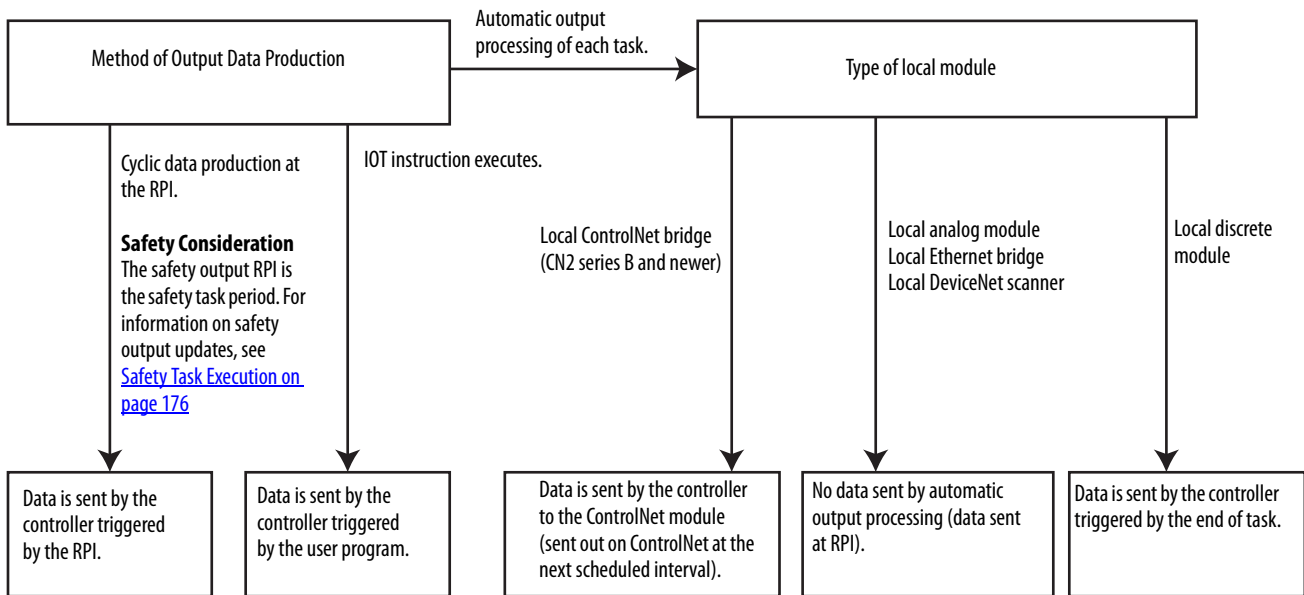

Safety I/O Devices

Topic	Page
Add Safety I/O Devices	137
Configure Safety I/O Devices	138
Using Network Address Translation (NAT) with CIP Safety Devices	140
Set the Safety Network Number (SNN)	141
Connection Reaction Time Limit	142
Safety I/O Device Signature	143
I/O Device Address Format	146
Monitor Safety I/O Device Status	146
Replace a Safety I/O Device	147
Reset Safety I/O Device to Out-of-box Condition	145

Add Safety I/O Devices

GuardLogix



When you add a safety I/O device to the system, you must define a configuration for the device, including the following:

- Node address for DeviceNet networks
- IP address for EtherNet/IP networks
- Safety network number (SNN). To set the SNN, see page [141](#).
- Configuration signature. See page [143](#) for information on when the configuration signature is set automatically and when you need to set it.
- Reaction time limit. To set the reaction time limit, see page [142](#).
- Safety input, output, and test parameters complete the module configuration.

IMPORTANT You cannot add Safety I/O Devices while online with the controller.

Configure Safety I/O Devices

Add the safety I/O device to the communication module under the I/O Configuration folder of the controller project.

TIP Some safety I/O devices support both standard and safety data. The Module Definition defines what data is available.

1. Right-click the network, and choose New Module.

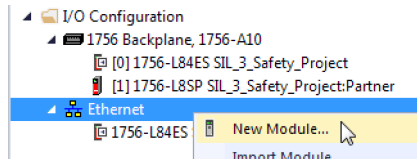

2. From the Catalog tab, select the safety I/O device.

TIP Use the filters to reduce the list of modules to choose from.

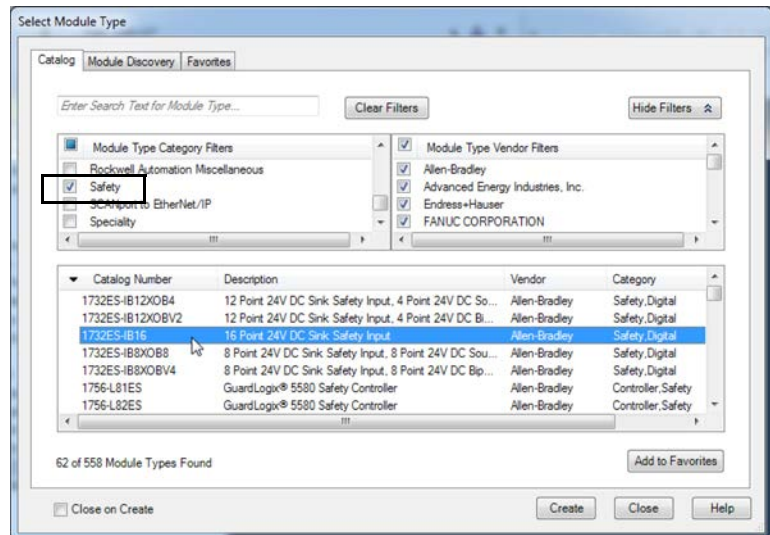

3. Click Create.
4. Type a name for the new device.

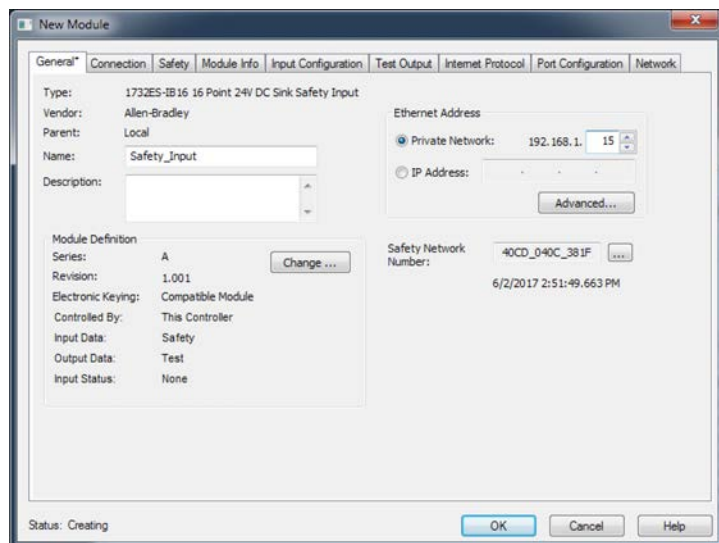

5. To modify the Module Definition settings, click Change (if required).

IMPORTANT For safety I/O devices, do not use Disable Keying. See [Electronic Keying on page 120](#).

6. Enter the node address for DeviceNet networks, or the IP address for EtherNet/IP networks.

Only unused node numbers are included in the pull-down menu.

If your network uses network address translation (NAT), see [Using Network Address Translation \(NAT\) with CIP Safety Devices on page 140](#).

7. To modify the Safety Network Number, click the  button.

See page [141](#) for details.

8. Set the Connection Reaction Time Limit by using the Safety tab.

See page [142](#) for details.

9. To complete configuration of the safety I/O device, refer to the user documentation and the Studio 5000 Logix Designer® application's online help.

Using Network Address Translation (NAT) with CIP Safety Devices

GuardLogix



NAT translates one IP address to another IP address via a NAT-configured router or switch. The router or switch translates the source and destination addresses within data packets as traffic passes between subnets.

This service is useful if you need to reuse IP addresses throughout a network. For example, NAT makes it possible for devices to be segmented into multiple identical private subnets while maintaining unique identities on the public subnet, such as for multiple identical machines or lines.

This section only applies to safety users where the controller and the devices it talks to are on separate sides of the NAT-configured router or switch.

With CIP Safety, the IP address of the device is part of the unique node reference that is part of the protocol. The device compares the IP address portion of the unique node reference in CIP safety packets to its own IP address, and rejects any packets where they do not match. The IP address in the unique node reference must be the NAT'ed IP address. The controller uses the translated address, but the CIP safety protocol requires the actual address of the device.

If you are using NAT to communicate with a CIP Safety device, follow these steps to set the IP address.

1. In the IP Address field, type the IP address that the controller will use.

This is usually the IP address on the public network when using NAT.

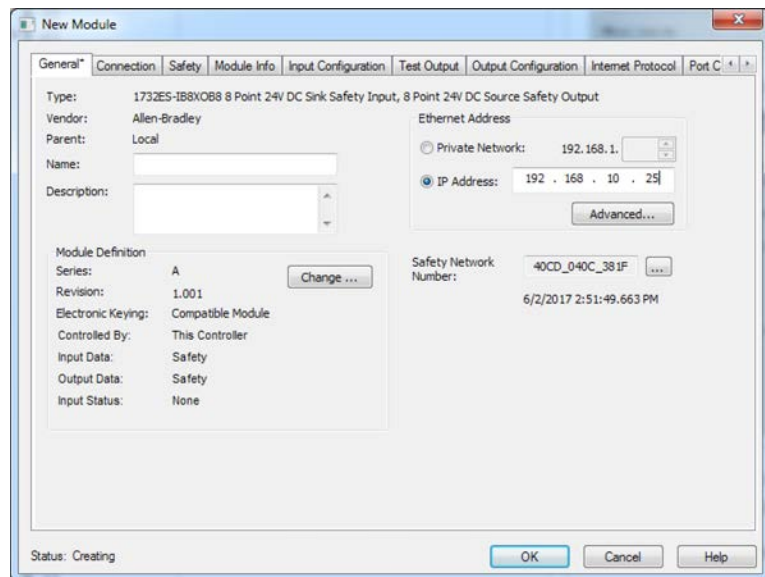

- Click Advanced to open the Advanced Ethernet Settings dialog box.

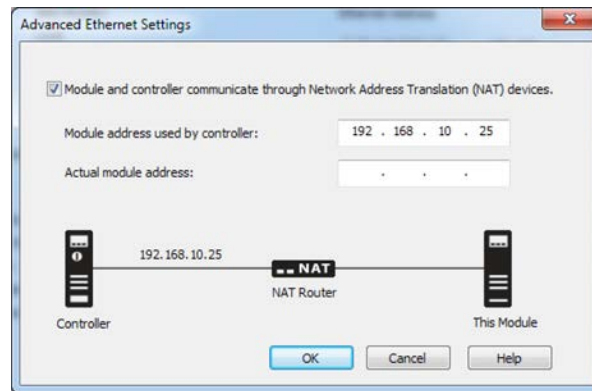

- Check the checkbox to indicate that this module and the controller communicate through NAT devices.
- Type the Actual module address.

TIP If you configured the IP address using the rotary switches, this is the address you set on the device. Alternately, the Actual module address is the same address shown on the device's Internet Protocol tab.

- Click OK.

Set the Safety Network Number (SNN)

A time-based SNN is automatically assigned when you add new safety I/O devices. When subsequent safety devices are added to the same network, they are assigned the same SNN as defined in the lowest address on that CIP safety network.

For most applications, the automatic, time-based SNN is sufficient. However, there are cases when the manipulation of an SNN is required.

See [Assign the Safety Network Number \(SNN\) on page 75](#).

For an explanation on Safety Network Number, see the GuardLogix 5580 and Compact GuardLogix 5380 Controller Systems Safety Reference Manual, publication [1756-RM012](#).

Connection Reaction Time Limit

The Connection Reaction Time Limit (CRTL) is defined by these three values.

Value	Default	Description
Requested Packet Interval (RPI)	10 ms (Input RPI)	How often the input and output packets are placed on the wire (network).
Timeout Multiplier	2	The Timeout Multiplier is essentially the number of retries before timing out.
Network Delay Multiplier	200	The Network Delay Multiplier accounts for any known delays on the wire. When these delays occur, timeouts can be avoided using this parameter.

If you adjust these values, then you can adjust the connection reaction time limit. If a valid packet is not received within the CRTL, the safety connection times out, and the input and output data is placed in the safe state (OFF).

IMPORTANT The default values generate an Input connection reaction time limit of 40 ms. If no edits are made to the defaults, verify this connection reaction time limit is used in the safety reaction time calculations.

IMPORTANT For applications with safety I/O, especially large banks of POINT Guard Safety I/O, the default connection reaction time limit can result in connection loss to the safety I/O modules. In these cases, it may be necessary to increase the values from their defaults. Make sure the new connection reaction time limit is used in the safety reaction time calculations.

For an explanation on reaction times, see the GuardLogix 5580 and Compact GuardLogix 5380 Controller Systems Safety Reference Manual, publication [1756-RM012](#).

Safety I/O Device Signature

Each safety device has a configuration signature that uniquely identifies the module configuration. The configuration signature is composed of an ID number, date, and time, and is used to verify a module's configuration.

Configuration via the Logix Designer Application

When the I/O device is configured by using the Logix Designer application, the configuration signature is generated automatically. You can view and copy the configuration signature via the Safety tab on the Module Properties dialog box.

Figure 25 - View and Copy the Configuration Signature

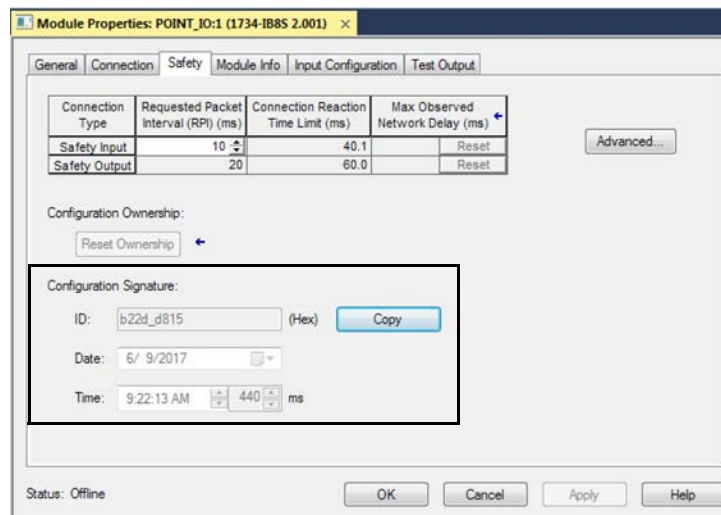

Different Configuration Owner (data-only connection)

When the I/O device configuration is owned by another controller, you need to copy the module configuration signature from its owner's project and paste it into the Safety tab of the Module Properties dialog box.

TIP If the device is only configured for inputs, you can copy and paste the configuration signature. If the device has safety outputs, they are owned by the controller that owns the configuration, and the configuration signature text box is unavailable.

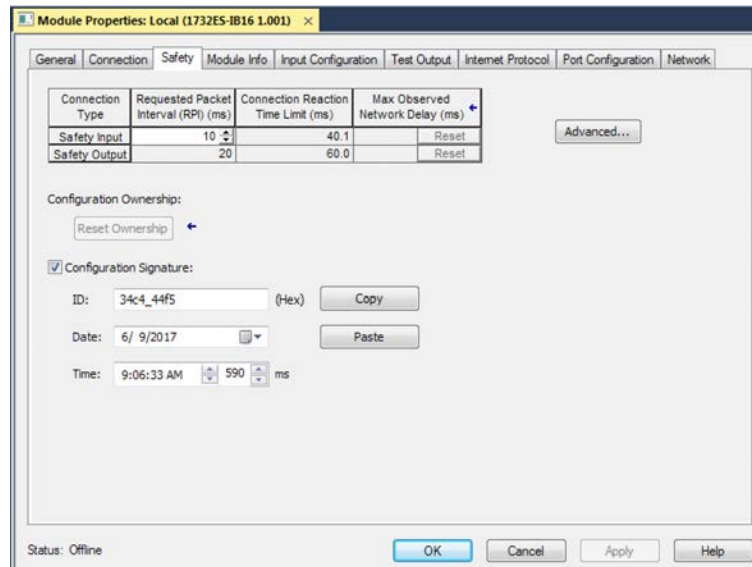

Reset Safety I/O Device to Out-of-box Condition

If a Guard I/O™ module was used previously, clear the existing configuration before installing it on a safety network by resetting the module to its out-of-box condition.

When the controller project is online, the Safety tab of the Module Properties dialog box displays the current configuration ownership. When the opened project owns the configuration, Local is displayed. When a second device owns the configuration, Remote is displayed, along with the safety network number (SNN), and node address or slot number of the configuration owner. Communication error is displayed if the module read fails.

If the connection is Local, you must inhibit the module connection before resetting ownership. Follow these steps to inhibit the module.

1. Right-click the module and choose Properties.
2. Click the Connection tab.
3. Check Inhibit Connection.
4. Click Apply and then OK.

Follow these steps to reset the module to its out-of-box configuration when online.

1. Right-click the module and choose Properties.
2. Click the Safety tab.
3. Click Reset Ownership.

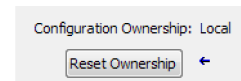

TIP You cannot reset ownership when there are pending edits to the module properties, when a safety signature exists, or when safety-locked.

I/O Device Address Format

When you add a device to the I/O configuration folder, the Logix Designer application automatically creates controller-scoped tags for the device.

I/O information is presented as a set of tags. Each tag uses a structure of data, depending on the type and features of the I/O device. The name of a tag is based on the device's name in the system.

A Safety I/O module address follows this example.

EXAMPLE Modulename.Type.Member

Table 26 - Safety I/O Device Address Format

Where	Is	
Modulename	The name of the safety I/O device	
Type	Type of data	Input: I Output: O
Member	Specific data from the I/O device	
	Input-only module	Modulename:I.RunMode ⁽¹⁾ Modulename:I.ConnectionFaulted ⁽¹⁾ Modulename:I.Input Members
	Output-only module	Modulename:I.RunMode ⁽¹⁾ Modulename:I.ConnectionFaulted ⁽¹⁾ Modulename:O.Output Members
	Combination I/O	Modulename:I.RunMode ⁽¹⁾ Modulename:I.ConnectionFaulted ⁽¹⁾ Modulename:I.Input Members Modulename:O.Output Members

(1) This member is required.

Table 27 - More Resources

Resource	Description
Logix5000 Controllers I/O and Tag Data Programming Manual, publication 1756-PM004	Provides information on addressing standard I/O devices

Monitor Safety I/O Device Status

You can monitor safety I/O device status via Explicit Messaging or via the status indicators on the device. For more information, see the product documentation for the device.

Replace a Safety I/O Device

This chapter provides information on replacing safety I/O devices when they are connected to GuardLogix® controllers.

Configuration Ownership

When the controller project is online, the Safety tab of the Module Properties dialog box displays the current configuration ownership.

- When the opened project owns the configuration, Local is displayed.
- When a second device owns the configuration, Remote is displayed, along with the safety network number (SNN), and node address or slot number of the configuration owner.
- If the module read fails, Communication error is displayed.

If the connection is Local, you must inhibit the module connection before resetting ownership. Follow these steps to inhibit the module.

1. Right-click the module and choose Properties.
2. Click the Connection tab.
3. Check Inhibit Connection.
4. Click Apply and then OK.

Replacement Configuration

You can use the Logix Designer application to replace a safety I/O device on an Ethernet network.

To replace a Guard I/O module on a DeviceNet network, your choice depends on the type of module.

Table 28 - Software

If you are using a	Use	See
Safety I/O device on EtherNet/IP network.	The Logix Designer application	Below
1791DS Guard I/O module with a 1756-DNB adapter	The Logix Designer application	Below

- If you are relying on a portion of the CIP safety system to maintain SIL 2/PLD or SIL 3/PLe behavior during device replacement and functional testing, the Configure Always feature cannot be used.

Go to [Replacement with ‘Configure Only When No Safety Signature Exists’ Enabled on page 149.](#)

- If the entire routable CIP safety control system is not being relied on to maintain SIL 2/PLD or SIL 3/PLe behavior during the replacement and functional testing of a device, the Configure Always feature can be used.

Go to [Replacement with ‘Configure Always’ Enabled on page 154.](#)

Safety I/O device replacement is configured on the Safety tab of the GuardLogix 5380 controller.

Figure 26 - Safety I/O Device Replacement

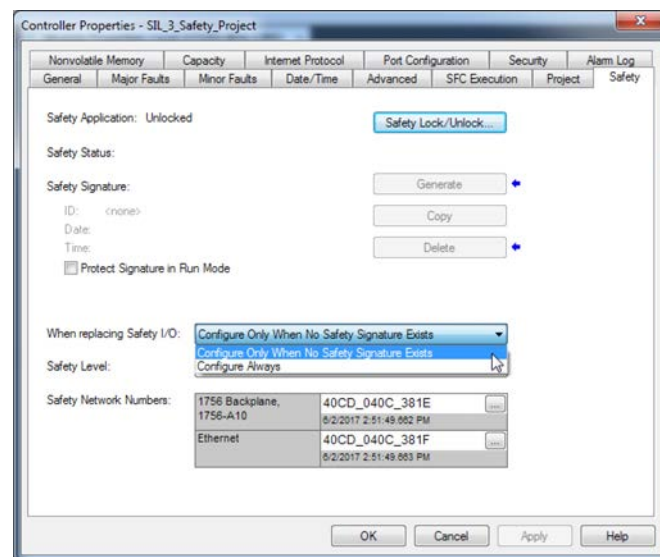

Replacement with 'Configure Only When No Safety Signature Exists' Enabled

When a safety I/O device is replaced, the configuration is downloaded from the safety controller if the DeviceID of the new device matches the original. The DeviceID is a combination of the node/IP address and the Safety Network Number (SNN) and is updated whenever the SNN is set.

If the project is configured as 'Configure Only When No Safety Signature Exists', follow the appropriate steps in [Table 29](#) to replace a safety I/O device based on your scenario. After you complete the steps, the DeviceID matches the original, enabling the safety controller to download the proper device configuration, and re-establish the safety connection.

Table 29 - Replacing a Module

GuardLogix® Safety Signature Exists	Replacement Module Condition	Action Required
No	No SNN (Out-of-box)	None. The device is ready for use.
Yes or No	Same SNN as original safety task configuration	None. The device is ready for use.
Yes	No SNN (Out-of-box)	See Scenario 1 - Replacement Device is Out-of-box and Safety Signature Exists on page 149.
Yes	Different SNN from original safety task configuration	See Scenario 2 - Replacement Device SNN is Different from Original and Safety Signature Exists on page 151.
No		See Scenario 3 - Replacement Device SNN is Different from Original and No Safety Signature Exists on page 153.

Scenario 1 - Replacement Device is Out-of-box and Safety Signature Exists

1. Remove the old I/O device and install the new device.
2. Right-click the replacement safety I/O device and choose Properties.
3. Click  to the right of the safety network number to open the Safety Network Number dialog box.

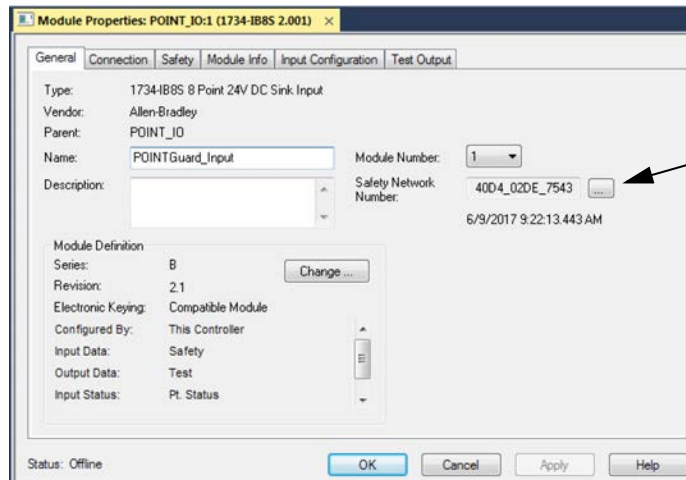

4. Click Set.

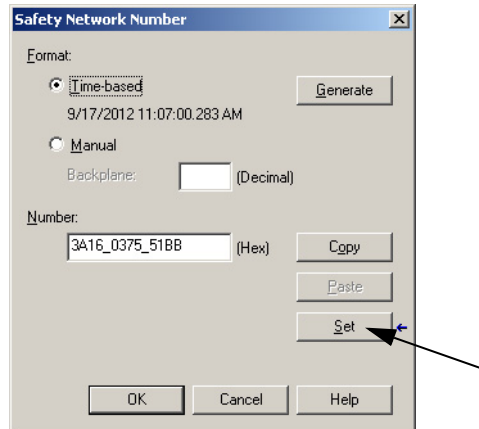

5. Verify that the Network Status (NS) status indicator is alternating red/green on the correct device before clicking Yes on the confirmation dialog box to set the SNN and accept the replacement device.

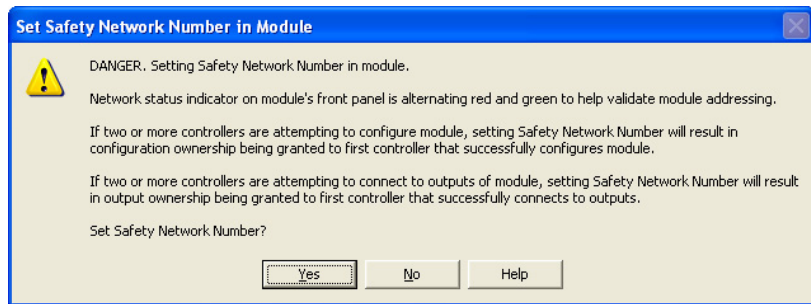

6. Follow your company-prescribed procedures to functionally test the replaced I/O device and system and to authorize the system for use.

Scenario 2 - Replacement Device SNN is Different from Original and Safety Signature Exists

1. Remove the old I/O device and install the new device.
2. Right-click your safety I/O device and choose Properties.
3. Click the Safety tab.
4. Click Reset Ownership.

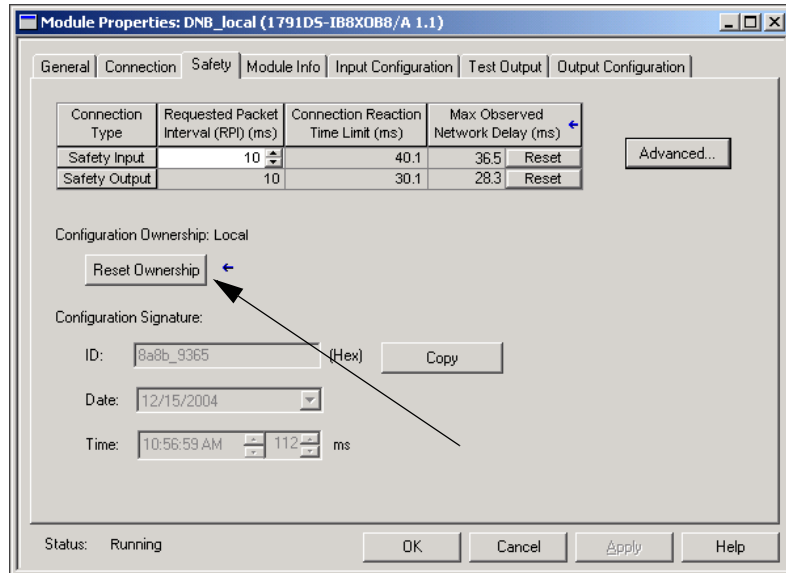

5. Click OK.
6. Right-click the device and choose Properties.
7. Click ... to the right of the safety network number to open the Safety Network Number dialog box.

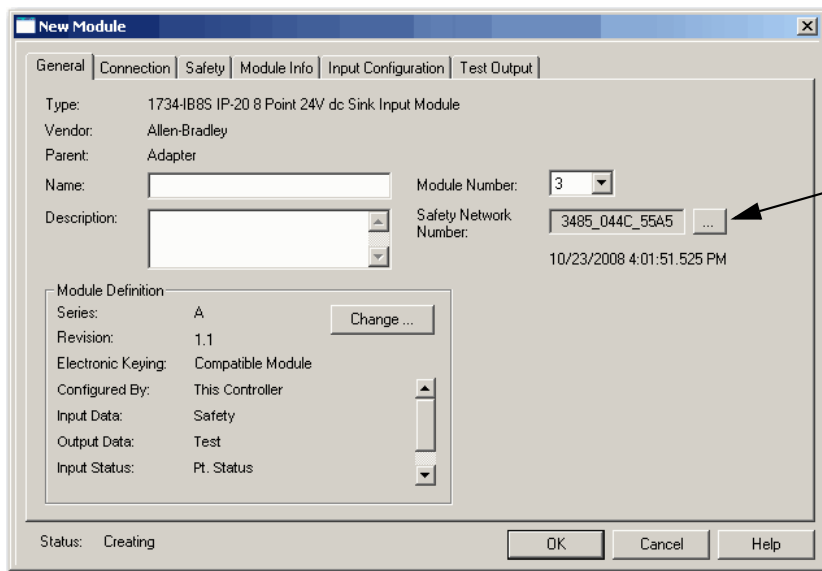

8. Click Set.

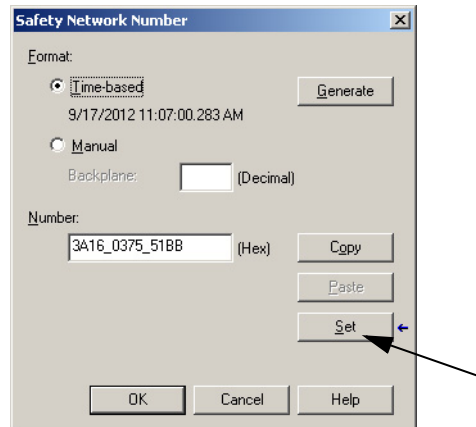

9. Verify that the Network Status (NS) status indicator is alternating red/green on the correct device before clicking Yes on the confirmation dialog box to set the SNN and accept the replacement device.

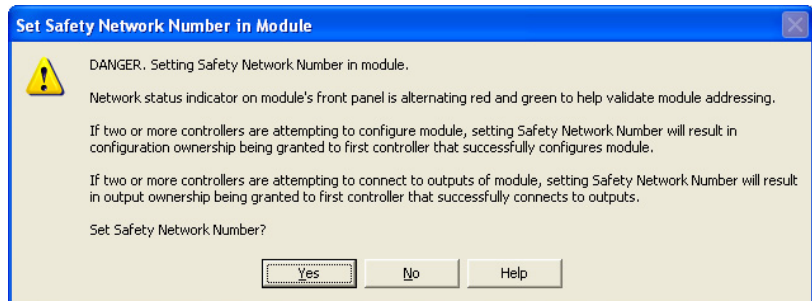

10. Follow your company-prescribed procedures to functionally test the replaced I/O device and system and to authorize the system for use.

Scenario 3 - Replacement Device SNN is Different from Original and No Safety Signature Exists

1. Remove the old I/O device and install the new device.
2. Right-click your safety I/O device and choose Properties.
3. Click the Safety tab.

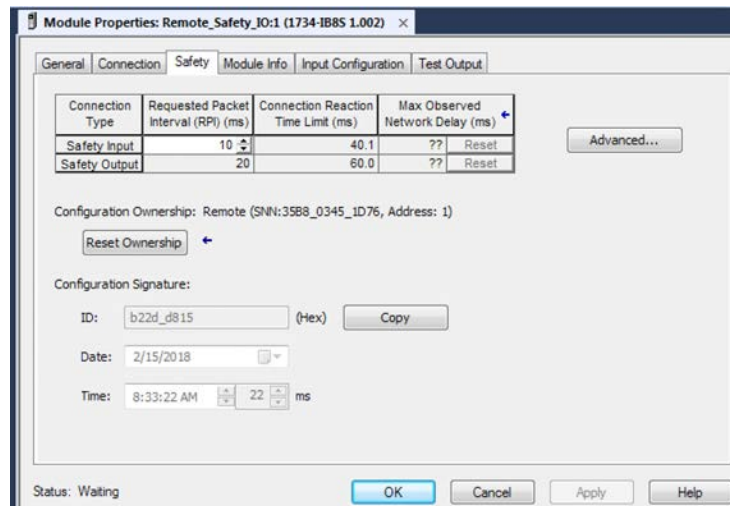

4. Click Reset Ownership.
5. Click OK.
6. Follow your company-prescribed procedures to functionally test the replaced I/O device and system and to authorize the system for use.

Replacement with 'Configure Always' Enabled



ATTENTION: Enable the 'Configure Always' feature only if the entire CIP safety Control System is **not** being relied on to maintain SIL 2/PLd or SIL 3/PLE behavior during the replacement and functional testing of a device.

Do not place devices that are in the out-of-box condition on a CIP safety network when the Configure Always feature is enabled, except while following this replacement procedure.

When the 'Configure Always' feature is enabled in the controller project, the controller automatically checks for and connects to a replacement device that meets all of the following requirements:

- The controller has configuration data for a compatible device at that network address.
- The device is in out-of-box condition or has an SNN that matches the configuration.

If the project is configured for 'Configure Always', follow the appropriate steps to replace a safety I/O device.

1. Remove the old I/O device and install the new device.
 - a. If the device is in out-of-box condition, go to step 6. No action is needed for the GuardLogix controller to take ownership of the device.
 - b. If an SNN mismatch error occurs, go to the next step to reset the device to out-of-box condition.
2. Right-click your safety I/O device and choose Properties.
3. Click the Safety tab.
4. Click Reset Ownership.

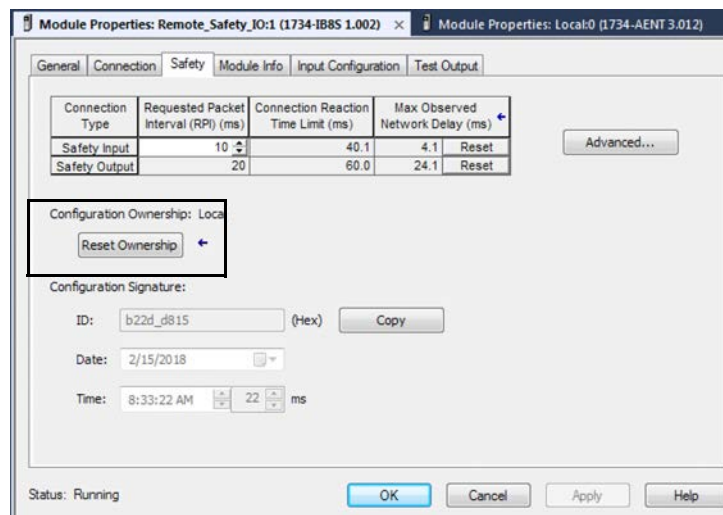

5. Click OK.
6. Follow your company-prescribed procedures to functionally test the replaced I/O device and system and to authorize the system for use.

Develop Standard Applications

Topic	Page
Elements of a Control Application	155
Tasks	157
Programs	159
Routines	162
Parameters and Local Tags	163
Programming Languages	164
Add-On Instructions	165
Extended Properties	166
Access the Module Object from an Add-On Instruction	167
Monitor Controller Status	168
Monitor I/O Connections	169

Elements of a Control Application

ControlLogix



GuardLogix



A control application consists of several elements that require planning for efficient application execution. Application elements include the following:

- Tasks
- Programs
- Routines
- Parameters and Local Tags
- Add-On Instructions

Figure 27 - Elements of a Control Application

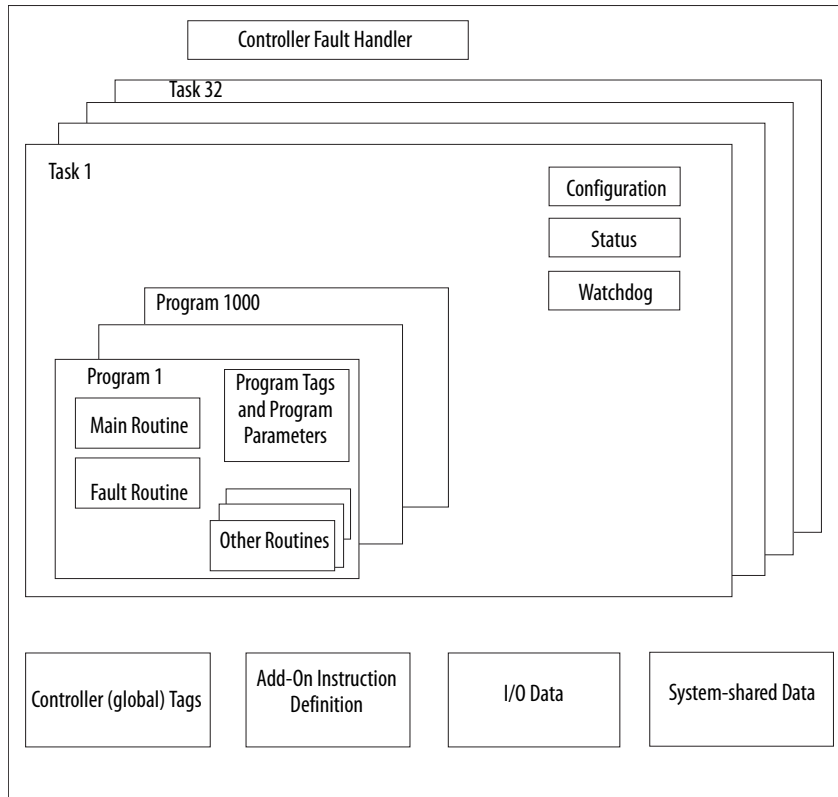

Tasks

The controller lets you use multiple tasks to schedule and prioritize the execution of your programs based on criteria. This multitasking allocates the processing time of the controller among the operations in your application:

- The controller executes only one task at a time.
- One task can interrupt the execution of another and take control based on its priority.
- In any given task, multiple programs can be used. However, only one program executes at a time.
- You can display tasks in the Controller or Logical Organizer views, as necessary.

Figure 28 - Task Within a Control Application

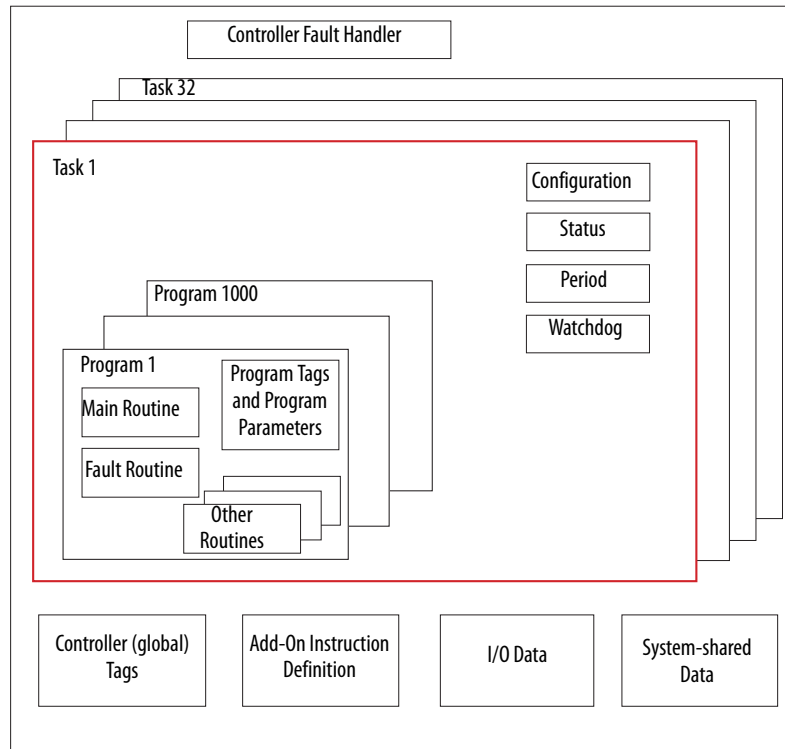
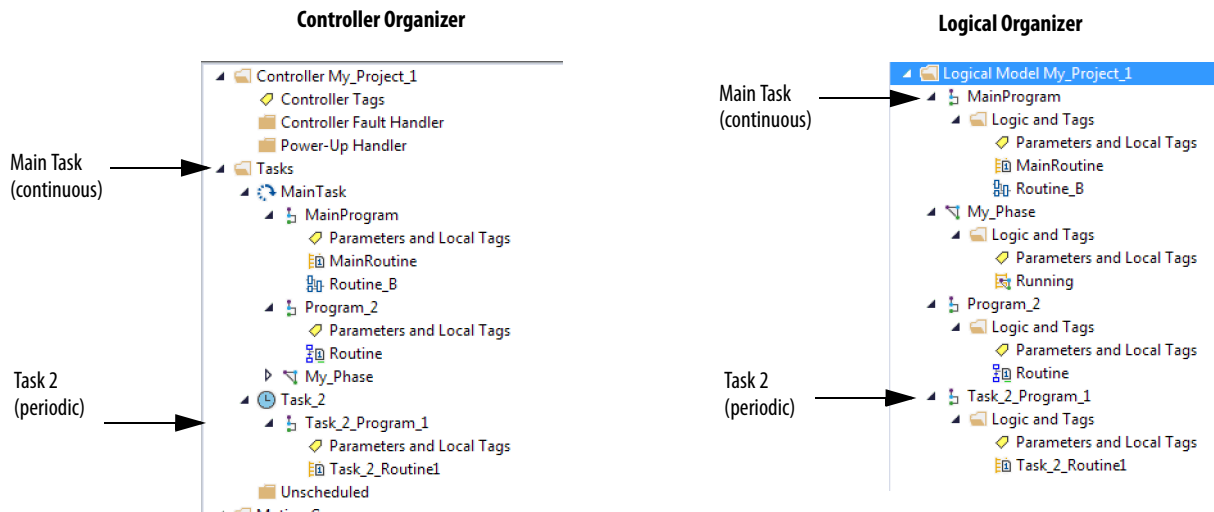
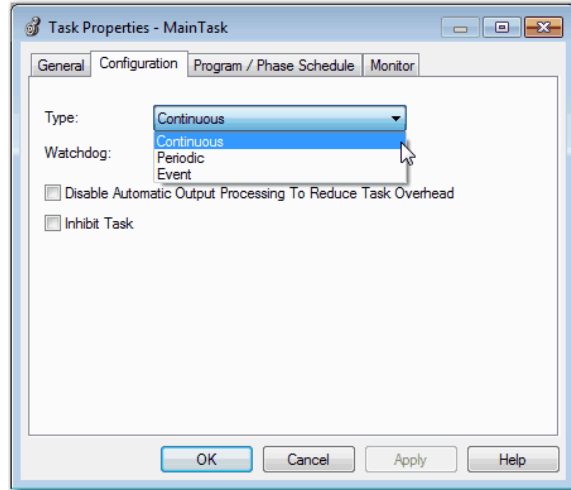

Figure 29 - Tasks



A task provides scheduling and priority information for a set of one or more programs. Configure tasks as continuous, periodic, or event by using the Task Properties dialog box.

Figure 30 - Configuring the Task Type



[Table 30](#) explains the types of tasks you can configure.

Table 30 - Task Types and Execution Frequency

Task Type	Task Execution	Description
Continuous	Constant	The continuous task runs in the background. Any CPU time that is not allocated to other operations (such as motion and other tasks) is used to execute the programs in the continuous task. <ul style="list-style-type: none"> The continuous task runs constantly. When the continuous task completes a full scan, it restarts immediately. A project does not require a continuous task. If used, there can be only one continuous task.
Periodic	At a set interval, such as each 100 ms	A periodic task performs a function at an interval. <ul style="list-style-type: none"> Whenever the time for the periodic task expires, the task interrupts any lower priority tasks, executes once, and returns control to where the previous task left off. You can configure the time period from 0.1...2,000,000.00 ms. The default is 10 ms. It is also controller and configuration dependent.
Event	Immediately when an event occurs	An event task performs a function when an event (trigger) occurs. The trigger for the event task can be the following: <ul style="list-style-type: none"> Module input data change of state A consumed tag trigger An EVENT instruction An axis trigger A motion event trigger You can configure an optional timeout interval for missed event triggers, which causes the event tasks to execute even in the absence of the trigger. Set the Check the Execute Task If No Event Occurs Within <timeout period> check box for task.

The ControlLogix™ 5580 and GuardLogix® 5580 controllers support up to 32 tasks. Only one of the tasks can be continuous.

A task can have up to 1000 programs, each with its own executable routines and program-scoped tags. Once a task is triggered (activated), the programs that are assigned to the task execute in the order in which they are grouped. Programs can appear only once in the Controller Organizer and multiple tasks cannot share them.

Task Priority

Each task in the controller has a priority level. The operating system uses the priority level to determine which task to execute when multiple tasks are triggered. A higher priority task interrupts any lower priority task. The continuous task has the lowest priority, and a periodic or event task interrupts it.

You can configure periodic and event tasks to execute from the lowest priority of 15 up to the highest priority of 1. Configure the task priority by using the Task Properties dialog box.

Figure 31 - Configure Task Priority

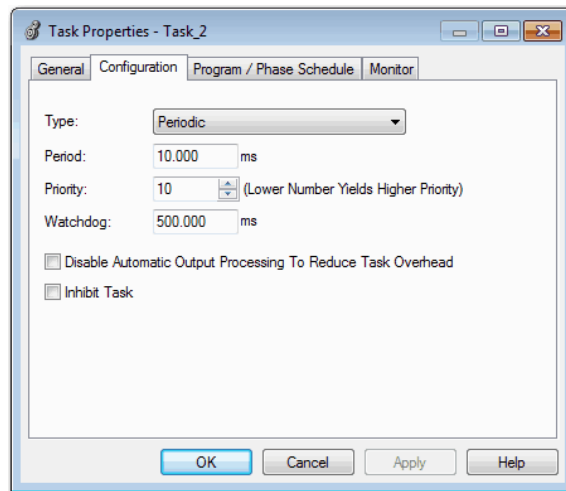

Programs

The controller operating system is a pre-emptive multitasking system that is in compliance with IEC 61131-3. This system provides the following:

- Programs to group data and logic
- Routines to encapsulate executable code that is written in one programming language

Each program contains the following:

- Local Tags
- Parameters
- A main executable routine
- Other routines
- An optional fault routine

Figure 32 - Program Within a Control Application

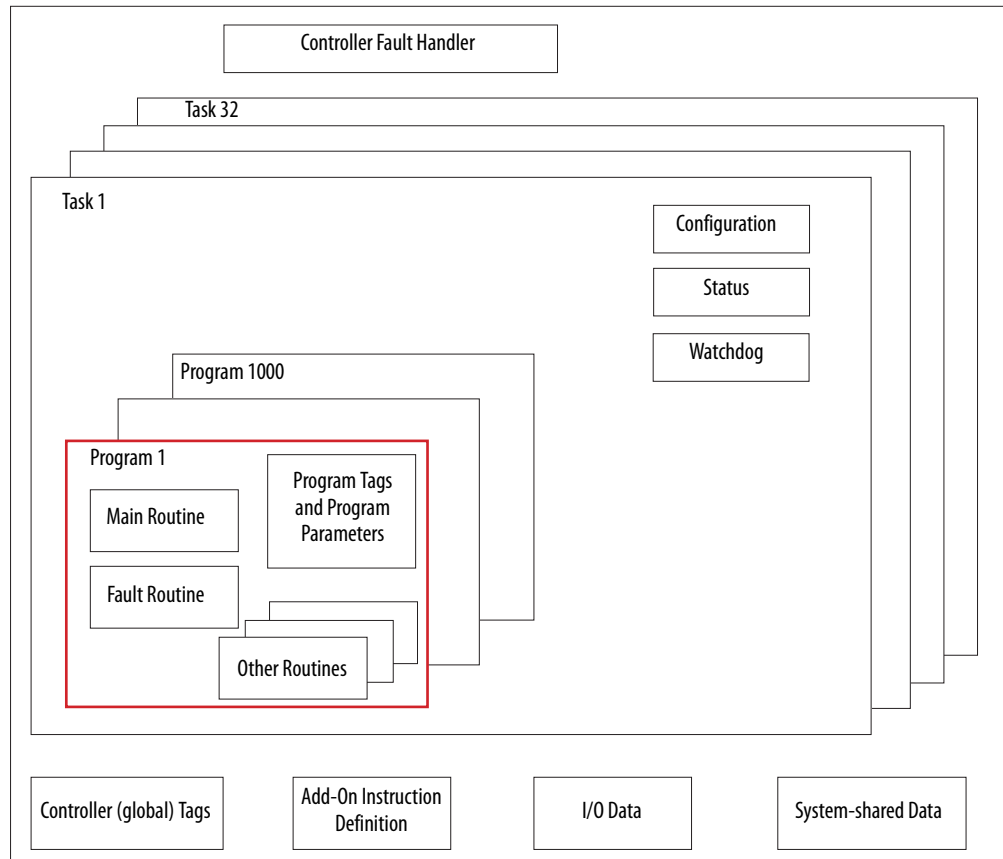
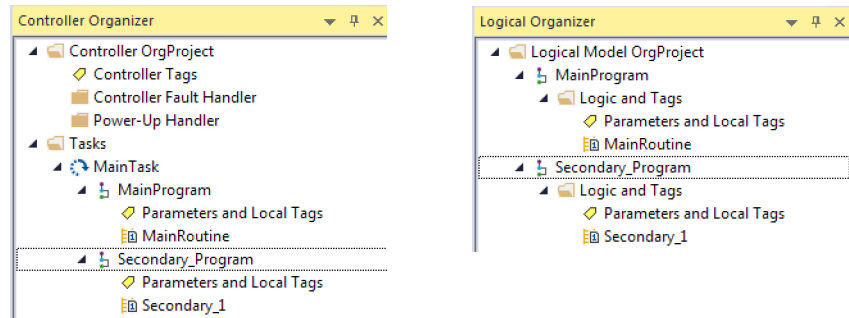

Figure 33 - Programs



Scheduled and Unscheduled Programs

The scheduled programs within a task execute to completion from first to last. Programs that are not attached to any task show up as unscheduled programs.

Unscheduled programs within a task are downloaded to the controller with the entire project. The controller verifies unscheduled programs but does not execute them.

You must schedule a program within a task before the controller can scan the program. To schedule an unscheduled program, use the Program/Phase Schedule tab of the Task Properties dialog box.

Figure 34 - Scheduling an Unscheduled Program

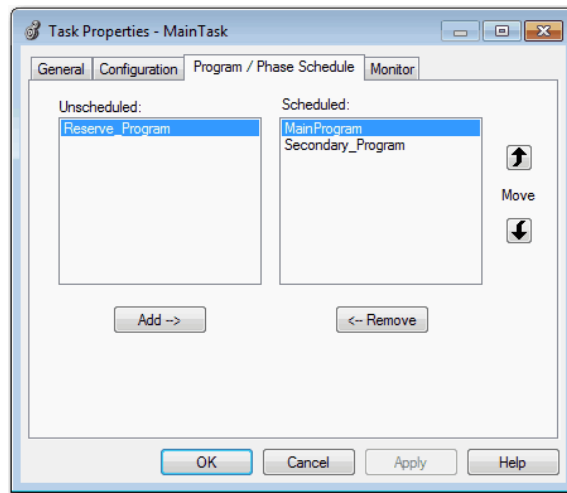

Routines

A routine is a set of logic instructions in one programming language, such as Ladder Diagram (ladder logic). Routines provide the executable code for the project in a controller.

Each program has a main routine. The main is the first routine to execute when the controller triggers the associated task and calls the associated program. Use logic, such as the Jump to Subroutine (JSR) instruction, to call other routines.

You can also specify an optional program fault routine. The controller executes this routine if it encounters an instruction-execution fault within any of the routines in the associated program.

Figure 35 - Routines in a Control Application

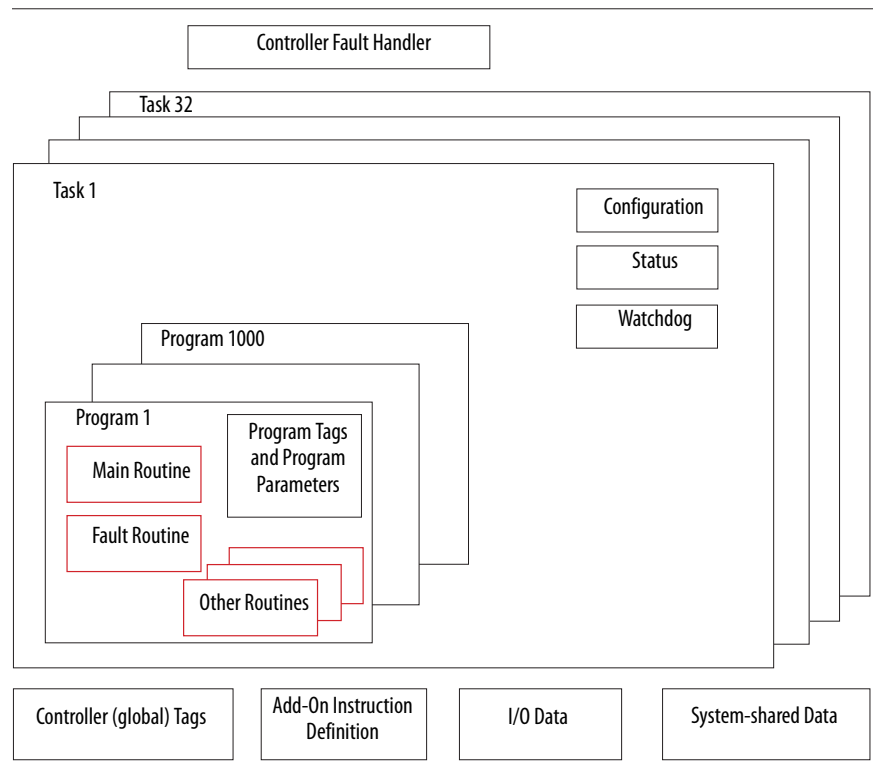
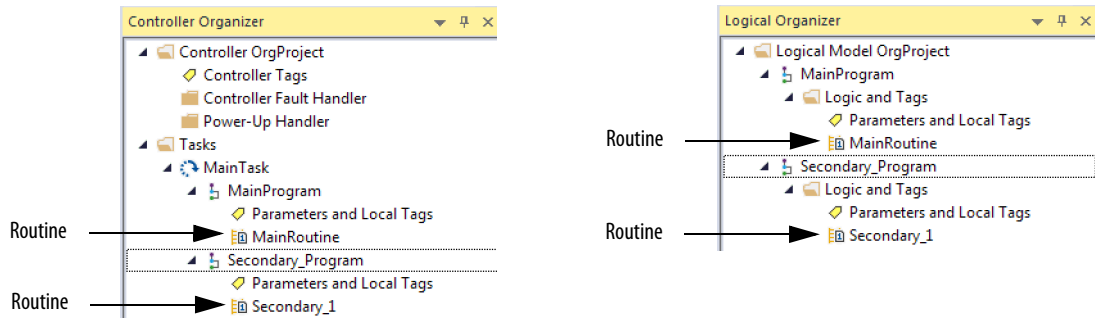

Figure 36 - Routines



Parameters and Local Tags

With a Logix 5000™ controller, you use a tag (alphanumeric name) to address data (variables). In Logix 5000 controllers, there is no fixed, numeric format. The tag name identifies the data and lets you do the following:

- Organize your data to mirror your machinery.
- Document your application as you develop it.

This example shows data tags that are created within the scope of the Main Program of the controller.

Controller Organizer —Main Program Parameters and Local Tags

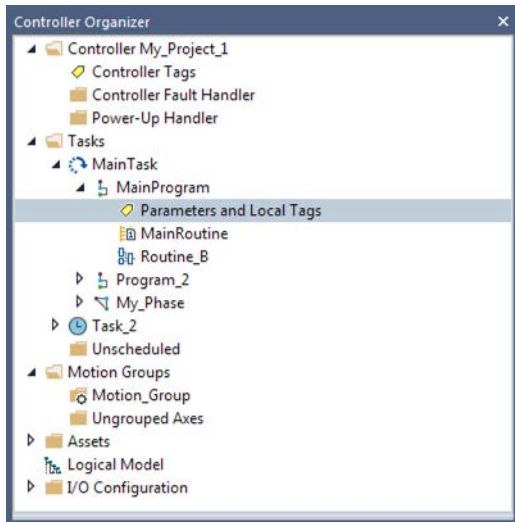

Logical Organizer —Main Program Parameters and Local Tags

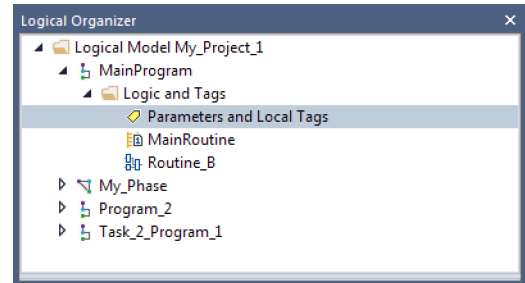

Program Parameters and Local Tags Window

Name	Usage	Value	Style	Data Type	Description	Constant	Alias For
ADD_01	Local	{...}		FBD_MATH		<input type="checkbox"/>	
ADD_02	Local	{...}		FBD_MATH		<input type="checkbox"/>	
Disabled	Local	0 Decimal		BOOL		<input type="checkbox"/>	
Motor_Starter_01	Local	{...}		Motor_Starter	Starts the motor.	<input type="checkbox"/>	

There are several guidelines for how to create and configure parameters and local tags for optimal task and program execution. For more information, see the Logix5000 Controllers and I/O Tag Data Programming Manual, publication [1756-PM004](#).

Program Parameters

Program parameters define a data interface for programs to facilitate data sharing. Data sharing between programs can be achieved either through pre-defined connections between parameters or directly through a special notation.

Unlike local tags, all program parameters are publicly accessible outside of the program. Additionally, HMI external access can be specified on individual basis for each parameter.

There are several guidelines for creating and configuring parameters and local tags for optimal task and program execution:

- Logix5000 Controllers and I/O Tag Data Programming Manual, publication [1756-PM004](#)
- Logix5000 Controllers Program Parameters Programming Manual, publication [1756-PM021](#)
- Logix5000 Controllers Design Considerations Reference Manual, publication [1756-RM094](#)

Programming Languages

The Studio 5000 Logix Designer® application supports these programming languages.

Language	Is best used in programs with
Ladder Diagram (LD)	Continuous or parallel execution of multiple operations (not sequenced)
	Boolean or bit-based operations
	Complex logical operations
	Message and communication processing
	Machine interlocking
	Operations that service or maintenance personnel have to interpret to troubleshoot the machine or process
	IMPORTANT: Ladder Diagram is the only programming language that can be used with the Safety Task on GuardLogix® 5580 controllers.
Function Block Diagram (FBD)	Continuous process and drive control
	Loop control
	Calculations in circuit flow
Sequential Function Chart (SFC)	High-level management of multiple operations
	Repetitive sequence of operations
	Batch process
	Motion control that uses structured text
	State machine operations
Structured Text (ST)	Complex mathematical operations
	Specialized array or table loop processing
	ASCII string handling or protocol processing

For more information, see the Logix5000 Controllers Common Procedures Programming Manual, publication [1756-PM001](#).

Add-On Instructions

With the Logix Designer application, you can design and configure sets of commonly used instructions to increase project consistency. Similar to the built-in instructions that are contained in the controllers, these instructions you create are called Add-On Instructions.

Add-On Instructions reuse common control algorithms. With them, you can do the following:

- Ease maintenance by creating logic for one instance.
- Apply source protection to help protect intellectual property.
- Reduce documentation development time.

You can use Add-On Instructions across multiple projects. You can define your instructions, obtain them from somebody else, or copy them from another project. [Table 31](#) explains some of the capabilities and advantages of use Add-On Instructions.

Table 31 - Add-On Instruction Capabilities

Capability	Description
Save Time	With Add-On Instructions, you can combine your most commonly used logic into sets of reusable instructions. You save time when you create instructions for your projects and share them with others. Add-On Instructions increase project consistency because commonly used algorithms all work in the same manner, regardless of who implements the project.
Use Standard Editors	You create Add-On Instructions by using one of three editors: <ul style="list-style-type: none"> • Ladder Diagram • Function Block Diagram • Structured Text
Export/Import Add-On Instructions	You can export/import Add-On Instructions to other projects and copy and paste them from one project to another. Give each instruction a unique, descriptive name to make it easier to manage and reuse your collection of Add-On Instructions.
Use Context Views	Context views let you visualize the logic of an instruction for instant, simplified online troubleshooting of your Add-On Instructions.
Document the Instruction	When you create an instruction, you enter information for the description fields. Each instruction definition includes revision, change history, and description information. The description text also becomes the help topic for the instruction. You can also generate a signature for the AOI, and include the AOI in a tracking group.
Apply Source Protection	When you create Add-On Instructions, you can limit users of your instructions to read-only access, or you can bar access to the internal logic or local parameters that are used by the instructions. This source protection lets you stop unwanted changes to your instructions and helps protect your intellectual property. You can pre-compile and encrypt your AOI for better Intellectual property protection. Using this feature has less of a performance impact than the Logix-designer source protection

Once defined in a project, Add-On Instructions behave similarly to the built-in instructions in the controllers. With Studio 5000 Logix Designer Version 31 and greater, Add-On Instructions appear under the Assets folder in the organizer. They also appear on the instruction tool bar for easy access along with internal instructions.

Figure 37 - Add-On Instructions (Studio 5000 Logix Designer Version 31 example)

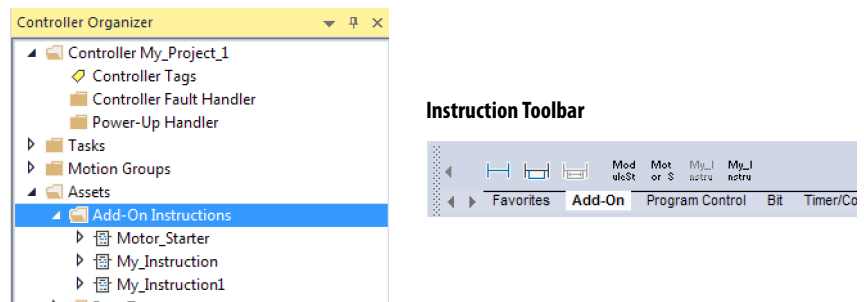

Extended Properties

The Extended Properties feature lets you define more information, such as limits, engineering units, or state identifiers for various components within your controller project.

Component	Extended Properties
Tag	In the tag editor, add extended properties to a tag.
User-defined data type	In the data type editor, add extended properties to data types.
Add-On Instructions	In the properties that are associated with the Add-On Instruction definition, add extended properties to Add-On Instructions.

Pass-through behavior is the ability to assign extended properties at a higher level of a structure or Add-On Instruction and have that extended property automatically available for all members. Pass-through behavior is available for descriptions, state identifiers, and engineering units and you can configure it.

Configure pass-through behavior on the Project tab of the Controller Properties dialog box. If you choose not to show pass-through properties, only extended properties that have been configured for a given component are displayed.

Pass-through behavior is **not** available for limits. When an instance of a tag is created, if limits are associated with the data type, the instance is copied.

Use the `.@Min` and `.@Max` syntax to define tags that have limits, as there is no indication in the tag browser that limit extended properties are defined for a tag. If you try to use extended properties that have not been defined for a tag, the editors show a visual indication and the routine does not verify. Visual indicators include:

- A rung error in Ladder Logic.
- A verification error X in Function Block Diagrams.
- The error underlined in Structured Text.

You can access limit extended properties that `.@Min` and `.@Max` syntax defines. However, you cannot write to extended properties values in logic.

For more information on Extended Properties, see the Logix5000 Controllers I/O and Tag Data Programming Manual, publication [1756-PM004](#).

Access the Module Object from an Add-On Instruction

The MODULE object provides status information about a module. To select a particular module object, set the Object Name operand of the GSV/SSV instruction to the module name. The specified module must be present in the I/O Configuration section of the controller organizer and must have a device name.

You can access a MODULE object directly from an Add-On Instruction. Previously, you could access the MODULE object data but not from within an Add-On Instruction.

You must create a Module Reference parameter when you define the Add-On Instruction to access the MODULE object data. A Module Reference parameter is an InOut parameter of the MODULE data type that points to the MODULE Object of a hardware module. You can use module reference parameters in both Add-On Instruction logic and program logic.

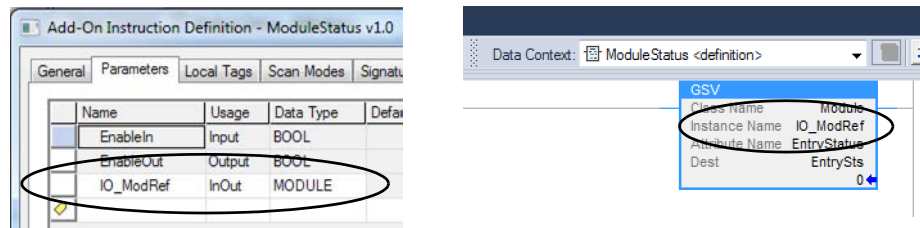

For more information on the Module Reference parameter, see the Logix Designer application online help and the Logix5000 Controllers Add-On Instructions Programming Manual, publication [1756-PM010](#).

The MODULE object uses the following attributes to provide status information:

- EntryStatus
- FaultCode
- FaultInfo
- FWSupervisorStatus
- ForceStatus
- Instance
- LEDStatus
- Mode
- Path

Monitor Controller Status

The ControlLogix controller uses Get System Value (GSV) and Set System Value (SSV) instructions to get and set (change) controller data. The controller stores system data in objects.

The GSV instruction retrieves the specified information and places it in the destination. The SSV instruction sets the specified attribute with data from the source. Both instructions are available from the Input/Output tab of the Instruction toolbar.

Figure 38 - GSV and SSV Instructions for Monitoring and Setting Attributes

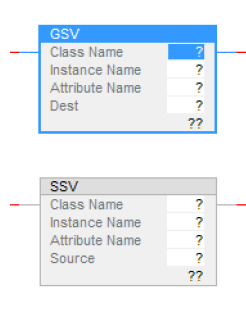

When you add a GSV/SSV instruction to the program, the object classes, object names, and attribute names for the instruction are shown. For the GSV instruction, you can get values for the available attributes. For the SSV instruction, only the attributes you can set are shown.

Some object types appear repeatedly, so you have to specify the object name. For example, there can be several tasks in your application. Each task has its own Task object that you access by the task name.

The GSV and SSV instructions monitor and set many objects and attributes. See the online help for the GSV and SSV instructions.

Monitor I/O Connections

If communication with a device in the I/O configuration of the controller does not occur in an application-specific period, the communication times out and the controller produces warnings.

The minimum timeout period that, once expired without communication, causes a timeout is 100 ms. The timeout period can be greater, depending on the RPI of the application. For example, if your application uses the default RPI = 20 ms, the timeout period is 160 ms.

For more information on how to determine the time for your application, see the Rockwell Automation® Knowledgebase for answer ID 38535:

<http://www.rockwellautomation.com/knowledgebase>.

When a timeout does occur, the controller produces these warnings;

- I/O Fault status information scrolls across the 4-character status display of the controller.
- A  shows over the I/O configuration folder and over the devices that have timed out.
- A module fault code is produced, which you can access via the following:
 - The Module Properties dialog box
 - A GSV instruction

For more information about I/O faults, see the Logix5000 Controllers Major, Minor, and I/O Faults Programming Manual, publication [1756-PM014](#).

Determine If I/O Communication Has Timed Out

This example can be used with the ControlLogix 5580 or GuardLogix 5580 controllers, and help determine if controller communication has timed out:

- The GSV instruction gets the status of the I/O status indicator (via the LEDStatus attribute of the Module object) and stores it in the IO_LED tag.
- IO_LED is a DINT tag that stores the status of the I/O status indicator or status display on the front of the controller.
- If IO_LED equals 2, then at least one I/O connection has been lost and the Fault_Alert is set.

Figure 39 - GSV Used to Identify I/O Timeout

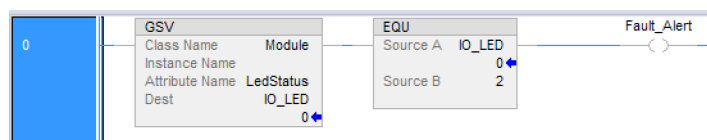

IMPORTANT Safety Consideration

Safety controllers have individual connection status on each safety I/O module as part of the input tag.

Determine if I/O Communication to a Specific I/O Module has Timed Out

If communication times out with a device (module) in the I/O configuration of the controller, the controller produces a fault code and fault information for the module. You can use GSV instructions to get fault code and information via the FaultCode and FaultInfo attributes of the Module object.

For Safety I/O modules, see [Monitor Safety Connections on page 200](#).

Automatic Handling of I/O Module Connection Faults

Depending on your application, you may want an I/O connection error to cause the Controller Fault Handler to execute. To do so, set the module property that causes a major fault to result from an I/O connection error. The major fault causes the execution of the Controller Fault Handler.



ATTENTION: You cannot program Safety I/O module connections or safety produce/consume connections to automatically cause a major fault on the controller. See [Develop Safety Applications on page 173](#).

Depending on your application, you may want an I/O connection error to cause the Controller Fault Handler to execute. To do so, set the module property that causes a major fault to result from an I/O connection error. The major fault causes the execution of the Controller Fault Handler.

If it is important to interrupt your normal program scan to handle an I/O connection fault, set the 'Major Fault On Controller If Connection Fails While In Run Mode' and put the logic in the Controller Fault Handler.

Figure 40 - I/O Connection Fault Causes Major Fault

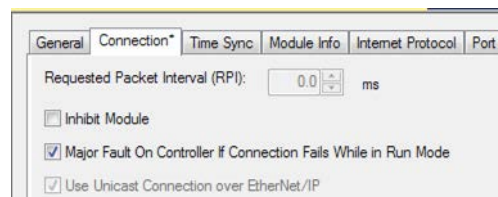

If responding to a failed I/O module connection can wait until the next program scan, put the logic in a normal routine and use the GSV technique that is described on page [169](#) to call the logic.

First, develop a routine in the Controller Fault Handler that can respond to I/O connection faults. Then, in the Module Properties dialog box of the I/O module or parent communication module, check Major Fault On Controller If Connection Fails While in Run Mode.

TIP It takes at least 100 milliseconds to detect an I/O connection loss, even if the Controller Fault Handler is used.

For more information about programming the Controller Fault Handler, see the Logix5000 Major, Minor, and I/O Faults Programming Manual, publication [1756-PM014](#).

Sample Controller Projects

Logix Designer includes sample projects that you can copy and modify to fit your application. To access the sample projects, choose Sample Project in the Studio 5000® interface.

Figure 41 - Opening Sample Projects



Notes:

Develop Safety Applications

Topic	Page
Safety Task	174
Safety Programs	176
Safety Routines	176
Safety Add-On Instructions	177
Produced/Consumed Safety Tags	179
Safety Tag Mapping	188
Safety Application Protection	191
Programming Restrictions	196
Monitor Safety Status	197
Safety Faults	203
Develop a Fault Routine for Safety Applications	206
Use GSV/SSV Instructions in a Safety Application	207

This chapter explains the components that make up a safety project and provides information on using features that help protect safety application integrity, such as the safety signature and safety-locking.

The GuardLogix 5580 and Compact GuardLogix 5380 Controller Systems Safety Reference Manual, publication [1756-RM012](#) addresses the following topics:

- Guidelines and requirements for developing and commissioning SIL 2/PLD and SIL 3/PLC safety applications
- Writing, documenting, and testing the application
- Creating a detailed project specification
- Generating the safety signature to identify and protect the project
- Confirming the project by printing or displaying the uploaded project and manually comparing the configurations, safety data, and safety program logic
- Verifying the project through test cases, simulations, functional verification tests, and an independent safety review, if required
- Locking the safety application
- Calculating system reaction time

GuardLogix





ATTENTION: Performing an on-line modification (to logic, data, or configuration) can affect the Safety Function(s) of the system if the modification is performed while the application is running. A modification should only be attempted if absolutely necessary. Also, if the modification is not performed correctly, it can stop the application. Therefore, when the safety signature is deleted to make an online edit to the safety task, before performing an online modification alternative safety measures must be implemented and be present for the duration of the update.

Safety Task

When you create a safety controller project, the Studio 5000 Logix Designer application automatically creates a safety task with a safety program and a main (safety) routine.

Figure 42 - Safety Task in the Controller Organizer and Logical organizer

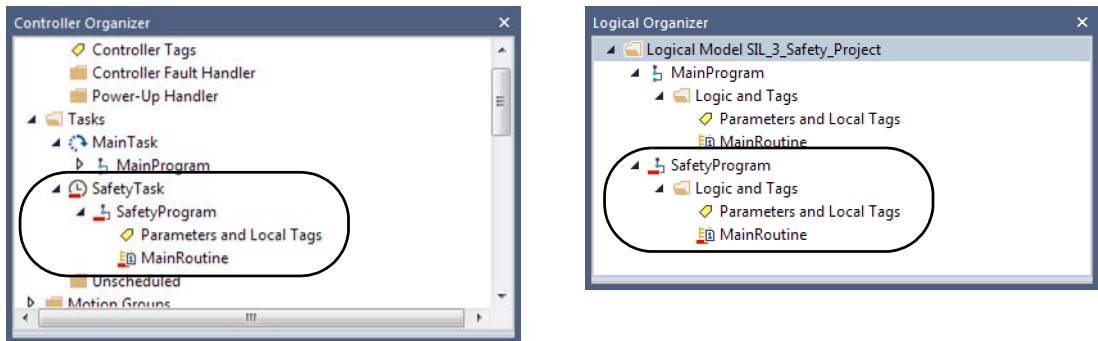

Within the safety task, you can use multiple safety programs, composed of multiple safety routines. The GuardLogix® 5580 controllers supports one safety task. The safety task cannot be deleted.

You cannot schedule standard programs or execute standard routines within the safety task.

Safety Task Period

The safety task is a periodic timed task. You set the task priority and watchdog time via the Task Properties - Safety Task dialog box. To open the dialog box, right-click the Safety Task and choose Properties.

Figure 43 - Configure the Safety Task Period

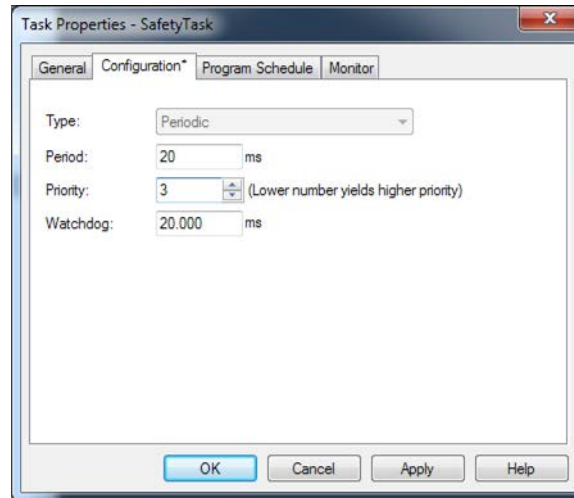

To get the most consistent safety task execution time, and to minimize safety task watchdog faults, we recommend running the safety task as the highest priority user task.

You specify the safety task period (in ms) and the safety task watchdog (in ms). The safety task period is the elapsed time between successive starting times for the safety task. The safety task watchdog is the maximum time allowed from the start of safety task execution to its completion.

The safety task period is limited to a maximum of 500 ms and cannot be modified online. Be sure that the safety task has enough time to finish logic execution before it is triggered again. If a safety task watchdog timeout occurs, a nonrecoverable safety fault is generated in the safety controller.

The safety task period directly affects system reaction time.

For information on calculating system reaction time, see the GuardLogix 5580 and Compact GuardLogix 5380 Controller Systems Safety Reference Manual, publication [1756-RM012](#).

Safety Task Execution

The safety task executes in the same manner as a standard periodic task, with the following exceptions:

- For a SIL 3/PLe application, the safety task does not begin executing until the primary controller and safety partner establish their control partnership. Standard tasks begin executing as soon as the controller transitions to Run mode.
- All safety input tags (inputs, consumed, and mapped) are updated and frozen at the beginning of safety task execution. See page 188 for information on safety tag mapping.
- Safety output packets (produced tags and output modules) are generated at the conclusion of safety task execution.
- When the controller does not have a safety signature and is not safety locked, the safety task can be held off until a communications update completes.

Safety Programs

Safety programs have all attributes of standard programs, except that they can only be scheduled in the safety task and can only contain safety components. Safety programs can only contain safety routines. One safety routine must be designated as the main routine, and another safety routine can be designated as the fault routine.

Safety programs cannot contain standard routines or standard tags.

Safety Routines

Safety routines have all the attributes of standard routines, except that they exist only in a safety program. At this time, only ladder diagram is supported for safety routines.

TIP A watermark feature visually distinguishes a safety routine from a standard routine.

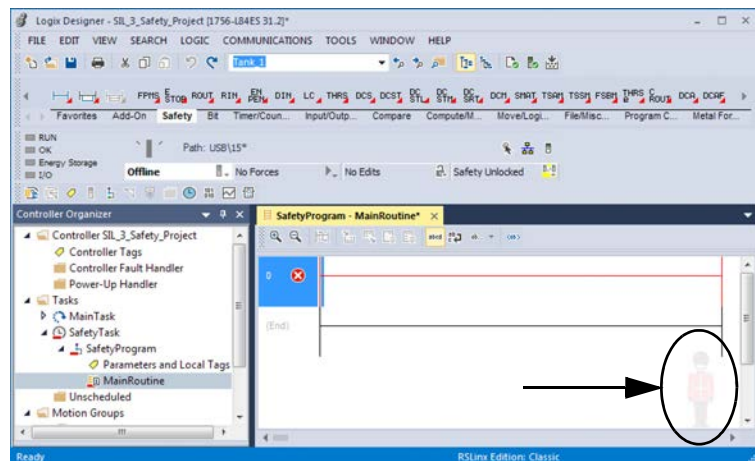

Safety Add-On Instructions

You can create safety Add-On Instructions to be used in Safety applications. Safety Add On Instructions feature a safety instruction signature for use in safety-related applications up to and including SIL 2-rated applications.

For more information, see the Logix5000 Controllers Add On Instructions Programming Manual, publication [1756-PM010](#).

Safety Tags

Safety tags have all the attributes of standard tags with the addition of mechanisms certified to provide SIL 2/PLd and SIL 3/PLe data integrity.

When you create a tag, you assign the following properties:

- Name
- Description (optional)
- Tag type
- Data type
- Scope
- Class
- Style
- External Access
- If the tag value is a constant

IMPORTANT You cannot create a standard alias tag of a safety tag. Instead, standard tags can be mapped to safety tags using safety tag mapping. See [Safety Tag Mapping on page 188](#).

The Logix Designer application can write to safety tags directly via the Tag Monitor when the GuardLogix 5580 controller is safety-unlocked, does not have a safety signature, and is operating without safety faults.

The controller does not allow writes to safety tag data from external human machine interface (HMI) devices or via message instructions from peer controllers. HMI devices may have read-only access to safety tags (depending on the External Access setting).

Valid Data Types

The data type defines the type of data that the tag stores, such as bit or integer.

Data types can be combined to form structures. A structure provides a unique data type that matches a specific need. Within a structure, each individual data type is called a member. Like tags, members have a name and data type. You can create your own structures, such as arrays or user-defined data types.

Logix controllers contain predefined data types for use with specific instructions. Safety tags can be composed of the following:

- All primitive data types (for example, BOOL, SINT, INT, DINT, LINT, REAL)
- Predefined types used for safety application instructions
- User-defined types or arrays composed of the two types above

Scope

The scope of a tag determines where you can access the tag data. When you create a tag, you define it as a controller tag (global data) or a program tag for a specific safety or standard program (local data). Safety tags can be controller-scoped or safety program-scoped.

Controller-scoped safety tags can be read by either standard or safety logic or external communication devices, but can be written by only safety logic or another GuardLogix safety controller. Program-scoped safety tags can be read by external communication devices, but only local safety routines can write to them. These are routines that reside within the safety program.

When you create program-scoped tags, the class is automatically specified, depending on whether you created the tag in a standard or a safety program. When you create controller-scoped tags, you must manually select the tag class.

When safety tags are controller-scoped, all programs have access to the safety data. Tags must be controller-scoped if they are used in the following ways:

- More than one program in the project
- To produce or consume data
- In safety tag mapping

See [Safety Tag Mapping on page 188](#) for more information.

Controller-scoped safety tags can be read, but not written to, by standard routines.

Program Parameters

For program parameters, a safety parameter cannot be connected with or bound to a standard parameter or controller-scoped tag.

For information on program parameters, see [Program Parameters on page 164](#).

Produced/Consumed Safety Tags

To transfer safety data between GuardLogix controllers, you use produced and consumed safety tags.

Tags associated with safety I/O and produced or consumed safety data must be controller-scoped safety tags. For produced/consumed safety tags, you must create a user-defined data type with the first member of the tag structure reserved for the status of the connection. This member is a predefined data type called CONNECTION_STATUS.

Table 32 - Produced and Consumed Connections

Tag	Connection Description
Produced	GuardLogix 5580 controllers can produce (send) safety tags to other GuardLogix controllers. <ul style="list-style-type: none"> GuardLogix 5580 controllers only support unicast produced tags. GuardLogix 5580 controllers do support producing a tag to up to 15 consumers if all consumers are configured to consume the tag unicast. The producing controller uses a single connection for each consumer. The consuming controller needs to be at firmware revision 19 or later. Unicast was not added to safety produced/consumed tags until firmware revision 19.
Consumed	GuardLogix 5580 controllers can consume (receive) safety tags from other GuardLogix controllers in these configurations: <ul style="list-style-type: none"> If you have a GuardLogix 5580 controller (the producer) in the I/O tree of another GuardLogix 5580 controller (the consumer), then the consumer can only consume a tag from the producer if the tag is unicast. If the producer controller is a GuardLogix 5570 controller, then a GuardLogix 5580 consumer controller can consume multicast or unicast tags. Each consumed tag consumes one connection.

Produced and consumed safety tags are subject to the following restrictions:

- Only controller-scoped safety tags can be shared.
- Produced and consumed safety tags are limited to 128 bytes.
- Produced/consumed tag pairs must be of the same user-defined data type.
- The first member of that user-defined data type must be the predefined CONNECTION_STATUS data type.
- The requested packet interval (RPI) of the consumed safety tag must match the safety task period of the producing GuardLogix controller.

To properly configure produced and consumed safety tags to share data between peer safety controllers, you must properly configure the peer safety controllers, produce a safety tag, and consume a safety tag, as described below.

Configure the SNN for a Peer Safety Controller Connection

The peer safety controller is subject to the same configuration requirements as the local safety controller. The peer safety controller must also have a safety network number (SNN).

The safety application that is downloaded into the peer safety controller configures SNN values for each CIP Safety port on the controller.

Table 33 - SNN and Controller Placement

Peer Safety Controller Location	SNN
Placed in the local chassis	The user application on the peer controller generates an SNN value for the local backplane port of the controller.
Placed in another chassis	The controller must have a unique SNN.

For an explanation of the Safety Network Number, see the GuardLogix 5580 and Compact GuardLogix 5380 Controller Systems Safety Reference Manual, publication [1756-RM012](#).

If the automatically assigned SNN of the producer controller does not match the SNN the controller actually uses, you can follow these steps to copy and paste the SNN.

TIP Setting the correct SNNs of the controller as described in [Assign the Safety Network Number \(SNN\) on page 75](#) usually results in the producer controller being assigned the correct SNN. In these cases you need not perform this procedure.

1. Add the producer controller to the consumer controller's I/O tree.

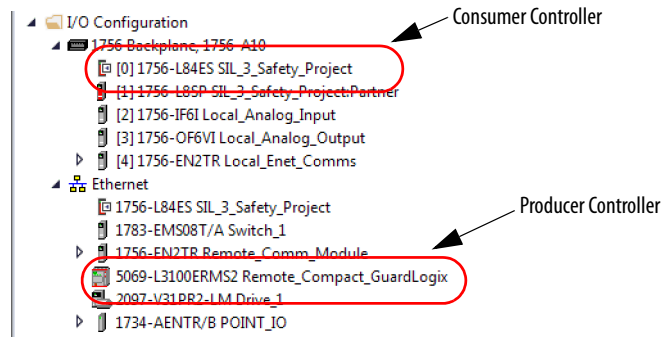

2. In the producer controller's project, right-click the producer controller and choose Controller Properties.

- On the Safety tab, click the  next to the port (Ethernet or Backplane) that communicates with the consumer controller. This opens the Safety Network Number dialog box.

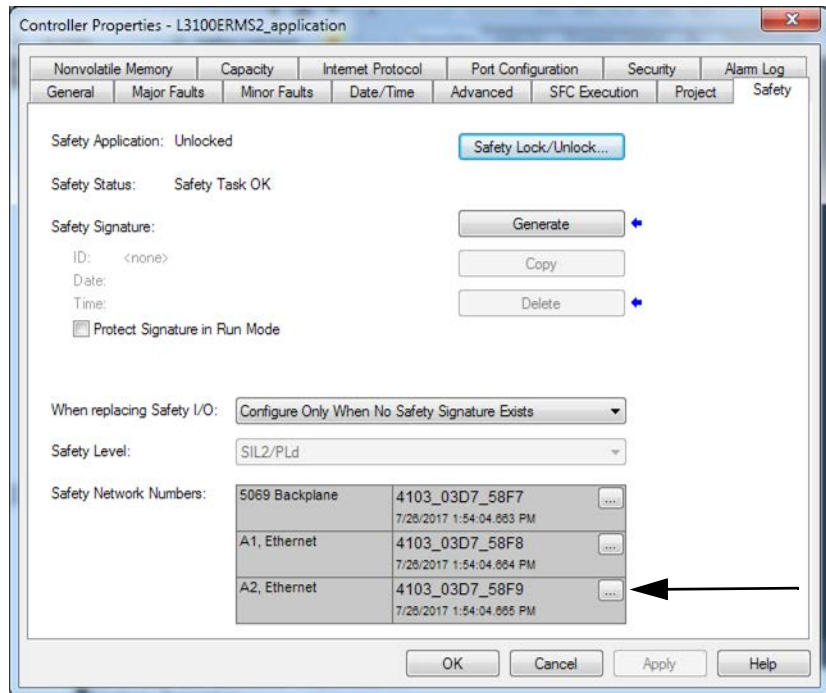

- Copy the producer controller's SNN.

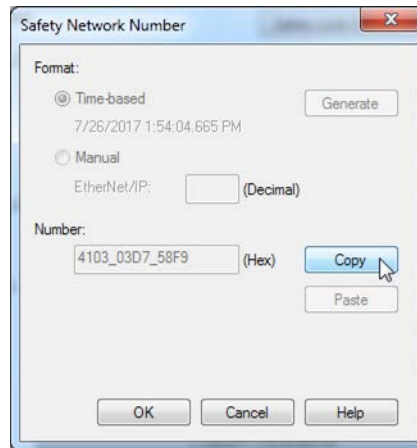

- In the I/O tree of the consumer controller's project, right-click on the module that represents the producing controller, and choose Module Properties.

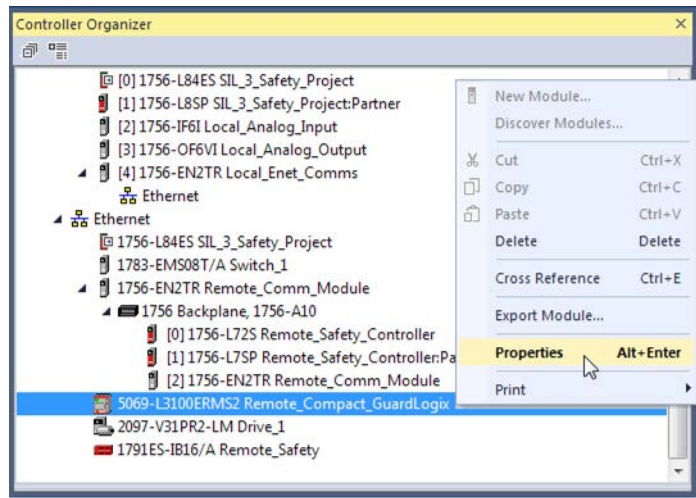

- On the Module Properties General tab, click  to open the Safety Network Number dialog.

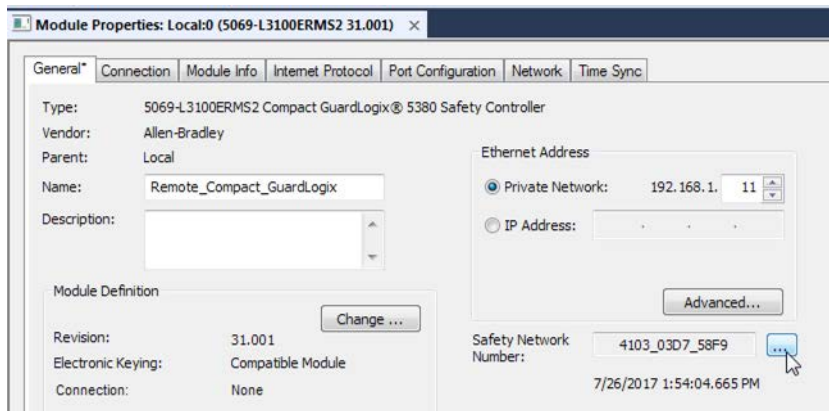

7. Paste the producer controller's SNN into the SNN field and click OK.

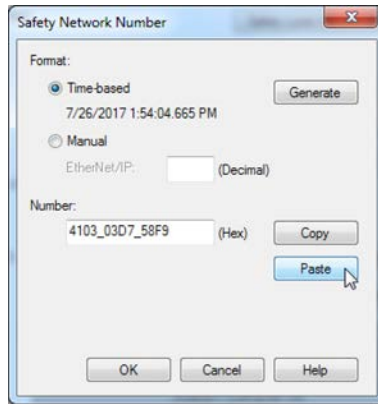

The safety network numbers match.

Producer Controller Properties Dialog Box in Producer Project

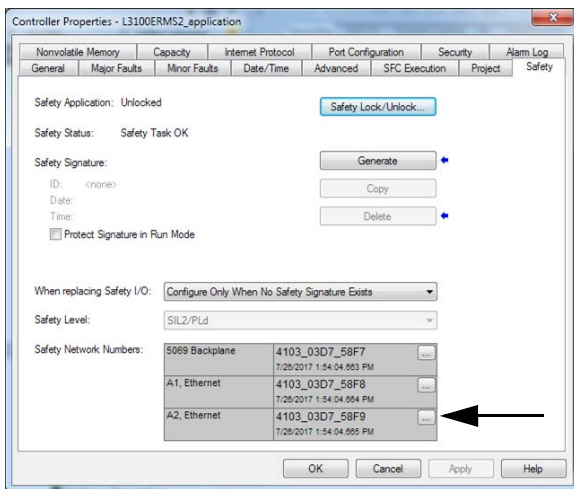

Module Properties Dialog Box in Consumer Project

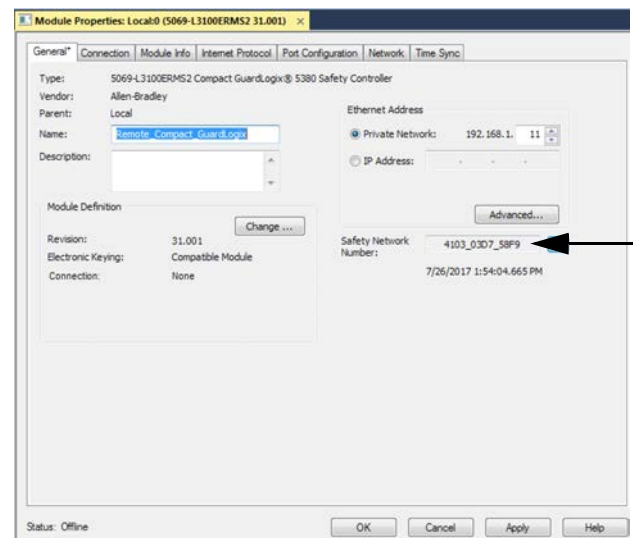

Produce a Safety Tag

Complete these steps to produce a safety tag.

1. In the producing controllers project, create a user-defined data type defining the structure of the data to be produced.
 Make sure that the first data member is of the CONNECTION_STATUS data type.
2. Right-click Controller Tags and choose New Tag.
3. Set the type as Produced, the class as Safety, and the Data Type to the user-defined type you created in step 1.
4. Click Connection and enter the max limit on the number of consumers (1 through 15).

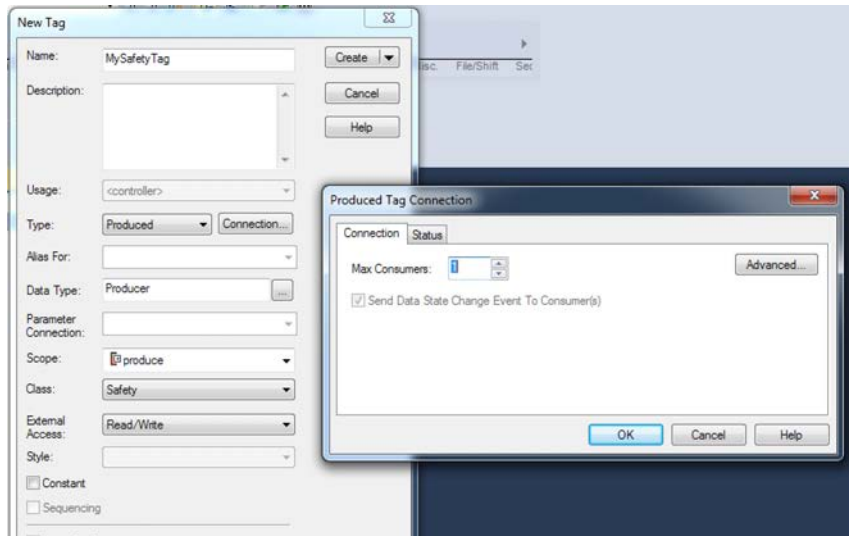

5. Click OK.
6. Click Create.

Consume Safety Tag Data

Follow these steps to consume data produced by another controller.

1. In the consumer controller's project, create a user-defined data type identical to the one created in the producer project (the names of the user-defined data types must match).

TIP The user-defined type can be copied from the producer project and pasted into the consumer project.

2. Right-click Controller Tags and choose New Tag.
3. Set the Type as Consumed, the Class as Safety, and the Data Type to the user-defined data type you created in step 1.

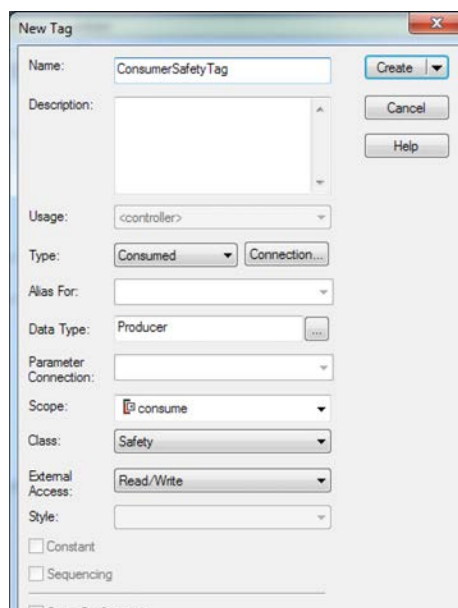

4. Click Connection to open the Consumed Tag Connection dialog box.

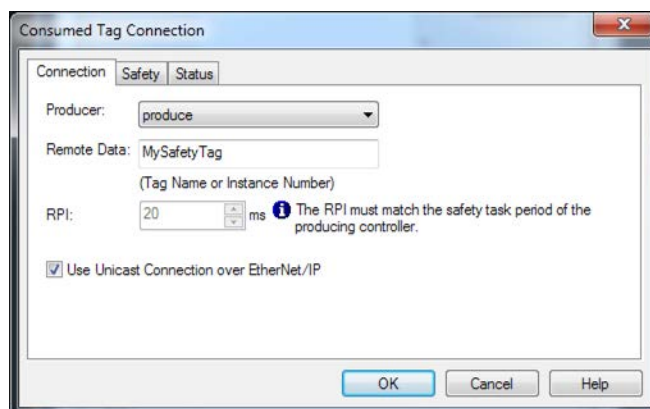

5. From the Producer pull-down menus, select the controller that produces the data.
6. In the Remote Data field, enter the name of the produced tag.

7. Click the Safety tab.
8. In the Requested Packet Interval (RPI) field, enter the RPI for the connection in 1 ms increments. The default is 20 ms.
 - The RPI specifies the period when data updates over a connection. The RPI of the consumed safety tag must match the safety task period of the producing safety project.

Consumer's Project

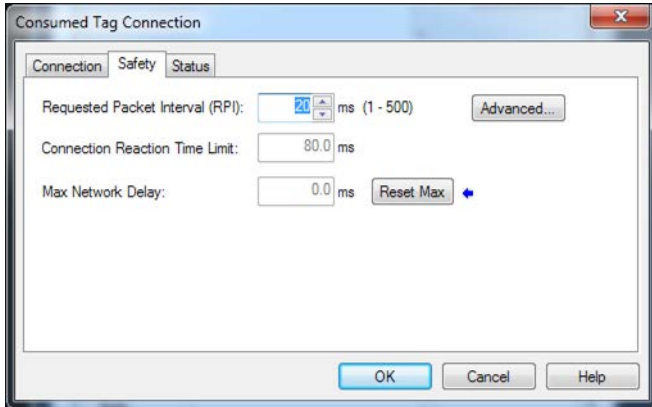

Producer's Project

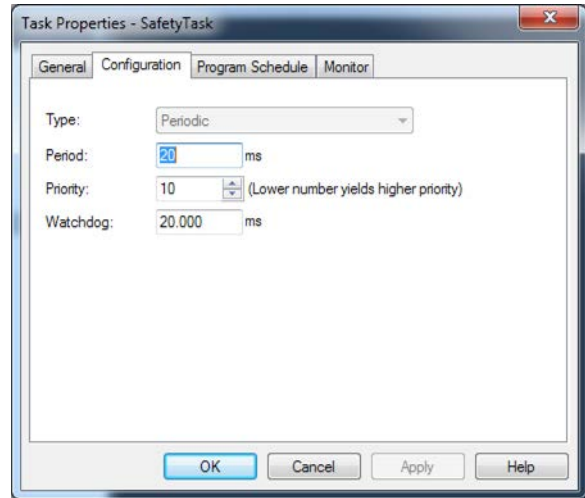

- The Connection Reaction Time Limit is the maximum age of safety packets on the associated connection. For simple timing constraints, you can achieve an acceptable Connection Reaction Time Limit by adjusting the safety task period of the producing controller which adjusts the RPI.
 - The Max Network Delay is the maximum observed transport delay from the time the data was produced until the time the data was received. When online, click Reset Max to reset the Max Network Delay.
9. If the Connection Reaction time limit is acceptable, click OK.

TIP If a safety consumed tag has the error code: "16#0111 Requested Packet Interval (RPI) out of range," check that the consumed tag RPI matches the producer's safety task period.

10. If your application has more complex requirements, click Advanced on the Safety tab to access the Advanced Connection Reaction Time Limit parameters.

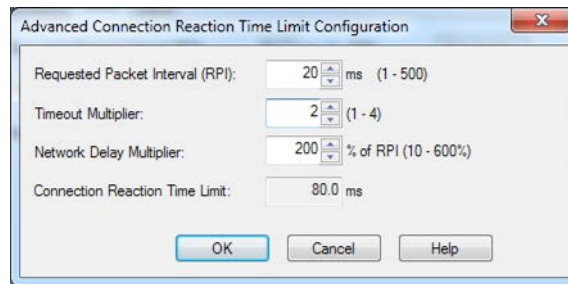

- The Timeout Multiplier determines the number of RPIs to wait for a packet before declaring a connection timeout.
- The Network Delay Multiplier defines the message transport time that is enforced by the CIP Safety protocol. The Network Delay Multiplier specifies the round-trip delay from the producer to the consumer and back to the producer.

You can use the Network Delay Multiplier to increase or decrease the Connection Reaction Time Limit.



ATTENTION: If you decrease the timeout multiplier or network delay multiplier below the defaults, this could cause nuisance safety connection losses. If you use wireless networks, you may need to increase the values above the default.

Table 34 - More Resources

Resource	Description
Connection Reaction Time Limit on page 142	Provides more information on setting the RPI and understanding how the Max. Network Delay, Timeout Multiplier, and Network Delay Multipliers affect the Connection Reaction Time
Monitor Safety Connections on page 200	Contains information on the CONNECTION_STATUS predefined data type
Logix5000 Controllers Produced and Consumed Tags Programming Manual, publication 1756-PM011	Provides detailed information on using produced and consumed tags

Safety Tag Mapping

A safety routine cannot directly access standard tags. To allow standard tag data to be used within safety task routines, the GuardLogix controllers provide a safety tag mapping feature that lets standard tag values be copied into safety task memory.

Mapped tags are copied from the standard tags to their corresponding safety tags at the beginning of the safety task. This can increase the safety task scan time.

TIP Standard task routines can directly read safety tags.

Restrictions

Safety tag mapping is subject to these restrictions:

- The safety tag and standard tag pair must be controller-scoped.
- The data types of the safety and standard tag pair must match.
- Alias tags are not allowed.
- Mapping must take place at the whole tag level. For example, myTimer.pre is not allowed if myTimer is a TIMER tag.
- A mapping pair is one standard tag mapped to one safety tag.
- You cannot map a standard tag to a safety tag that has been designated as a constant.
- Tag mapping cannot be modified when any of the following are true:
 - The project is safety-locked.
 - A safety signature exists.
 - The key switch is in RUN position.
 - A nonrecoverable safety fault exists.
 - An invalid partnership exists between the primary controller and safety partner.



ATTENTION: When using standard data in a safety routine, you must verify that the data is used in an appropriate manner. Using standard data in a safety tag does not make it safety data. You must not directly control a SIL 2/PLd or SIL 3/PLe safety output with standard tag data.

For more information, see the GuardLogix 5580 and Compact GuardLogix 5380 Controller Systems Safety Reference Manual, publication [1756-RM012](#).

Create Tag Mapping Pairs

1. Choose Map Safety Tags from the Logic menu to open the Safety Tag Mapping dialog box.

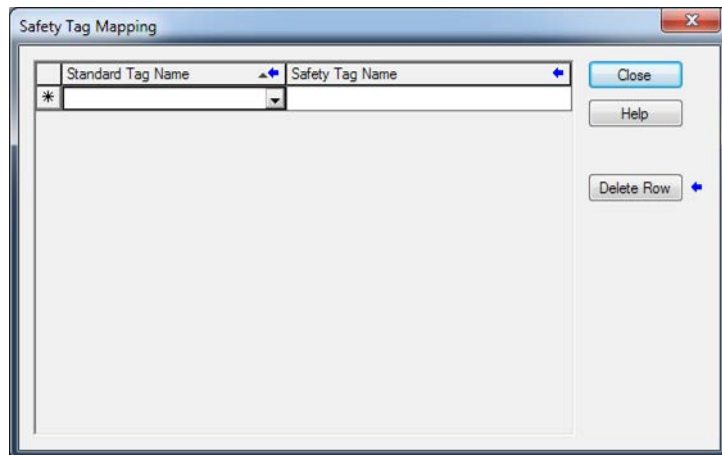

2. Add an existing tag to the Standard Tag Name or Safety Tag Name column by typing the tag name into the cell or choosing a tag from the pull-down menu.

Click the arrow to display a filtered tag browser dialog box. If you are in the Standard Tag Name column, the browser shows only controller-scoped standard tags. If you are in the Safety Tag Name column, the browser shows controller-scoped safety tags.

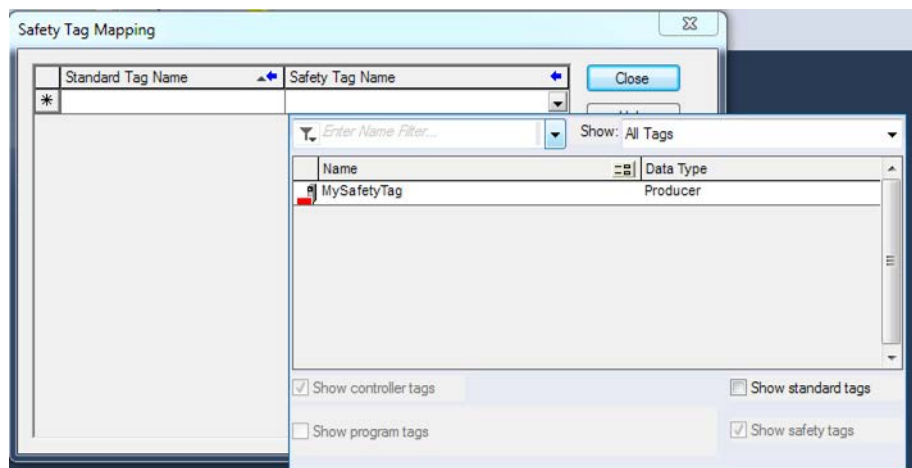





3. Add a new tag to the Standard Tag Name or Safety Tag Name column by right-clicking in the empty cell and selecting New Tag and typing the tag name into the cell.
4. Right-click in the cell and choose New tagname, where tagname is the text you entered in the cell.

Monitor Tag Mapping Status

The leftmost column of the Safety Tag Mapping dialog box indicates the status of the mapped pair.

Table 35 - Tag Mapping Status Icons

Cell Contents	Description
Empty	Tag mapping is valid.
	When offline, the X icon indicates that tag mapping is invalid. You can move to another row or close the Safety Tag Mapping dialog box. ⁽¹⁾ When online, an invalid tag map results in an error message explaining why the mapping is invalid. You cannot move to another row or close the Safety Tag Mapping dialog box if a tag mapping error exists.
	Indicates the row that currently has the focus.
	Represents the Create New Mapped Tag row.
	Represents a pending edit.

(1) Tag mapping is also checked during project verification. Invalid tag mapping results in a project verification error.

For more information, see the tag mapping restrictions on page [188](#).

Safety Application Protection

You can protect your application program from unauthorized changes by generating a safety signature, setting passwords, and safety-locking the controller.

Safety-lock the Controller



ATTENTION: Safety-locking alone does not satisfy SIL 2/PLd or SIL 3/PLe requirements.

You can safety-lock the GuardLogix 5580 controller to protect safety-related control components from modification, and prevent the safety signature from being deleted accidentally.

The safety-lock feature applies only to safety components, such as the safety task, safety programs, safety routines, safety Add-On Instructions, safety tags, safety I/O, and the safety signature.

TIP There are multiple ways to view the safety lock status of the controller:

- The 4-character display on the controller indicates lock status.
- In the Logix Designer application, the text of the online bar's safety status button indicates the safety-lock status.



- The Logix Designer application tray also displays the following icons to indicate the safety controller's safety-lock status.



= controller safety-locked



= controller safety-unlocked

You can safety-lock the controller project regardless of whether you are online or offline and regardless of whether you have the original source of the program. However, no safety forces or pending online safety edits can be present.

You cannot change the Safety-locked or -unlocked status when the controller mode switch is in the RUN position.

TIP Safety-lock or -unlock actions are logged in the controller log.

For more information on accessing the controller log, refer to Logix5000 Controllers Controller Information and Status Programming Manual, publication [1756-PM015](#).

You can safety-lock and -unlock the controller from the Safety tab of the Controller Properties dialog box.

Figure 44 - Safety-lock the Controller

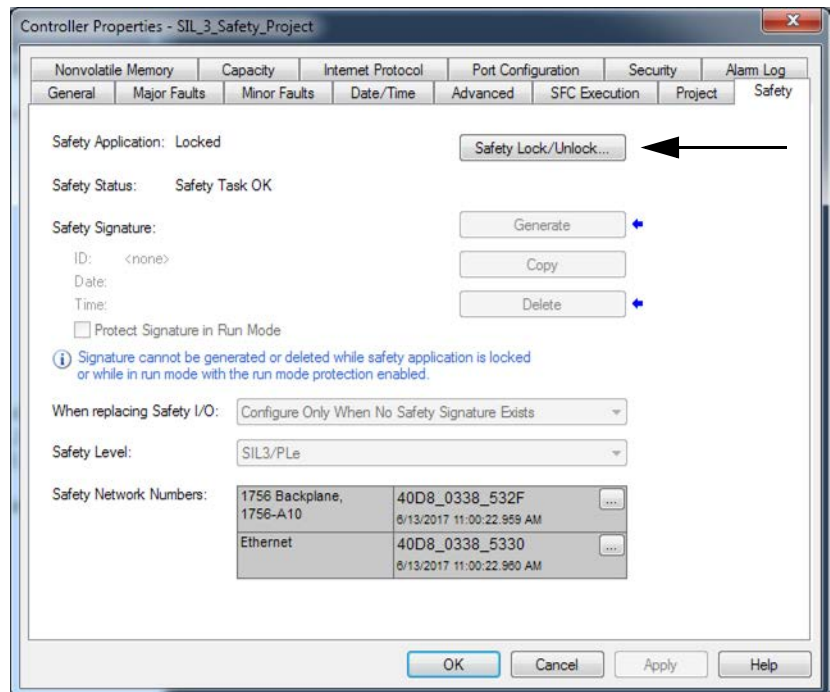

TIP In the Logix Designer application, you can also choose Tools > Safety > Safety Lock/Unlock.

If you set a password for the safety-lock feature, you must type it in the Enter Password field. Otherwise, click Lock.

Figure 45 - Safety-locking the Controller



You can also set or change the password from the Safety Lock dialog box. See [Set Passwords for Safety-locking and Unlocking on page 193](#).

The safety-lock feature, described in this section, and standard security measures in the Logix Designer application are applicable to GuardLogix controller projects.

Refer to the Logix5000 Controllers Security Programming Manual, publication [1756-PM016](#), for information on Logix Designer security features.

Set Passwords for Safety-locking and Unlocking

The safety-lock and -unlock feature uses two separate passwords. Passwords are optional.

Follow these steps to set passwords.

1. On the Logix Designer menu bar, click Tools > Safety > Change Passwords.
2. From the What Password pull-down menu, choose either Safety Lock or Safety Unlock.

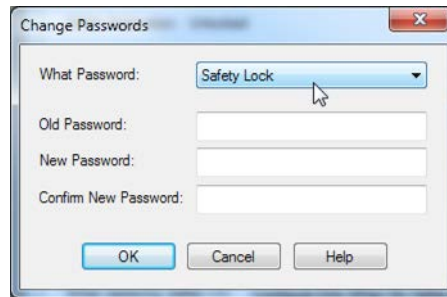

3. Type the old password, if one exists.
4. Type and confirm the new password.
5. Click OK.

TIP Passwords can be from 1...40 characters in length and are not case-sensitive. Letters, numerals, and the following symbols can be used: ' ~ ! @ # \$ % ^ & * () _ + , - = { } | [] \ ; : ? / .

To clear an existing password, enter a new password of zero length.

IMPORTANT Rockwell Automation does not provide any form of password or security override services. When products and passwords are configured, Rockwell Automation encourages customers to follow good security practices and to plan accordingly for password management.

Generate a Safety Signature

IMPORTANT To generate a signature, the controller must be in Program mode.

Before verification testing, you must generate the safety task signature. You can generate the safety task signature only when these conditions exist:

- The safety-unlocked GuardLogix 5580 controller project is online.
- There are no safety forces, pending online safety edits, or safety faults.
- The safety status must be Safety Task OK.

TIP You can view the safety status via the safety status button on the online bar, or on the Safety tab of the Controller Properties dialog box.

To generate the safety signature from the Safety tab of the Controller Properties dialog box, click Generate.

Figure 46 - Generate Safety Signature

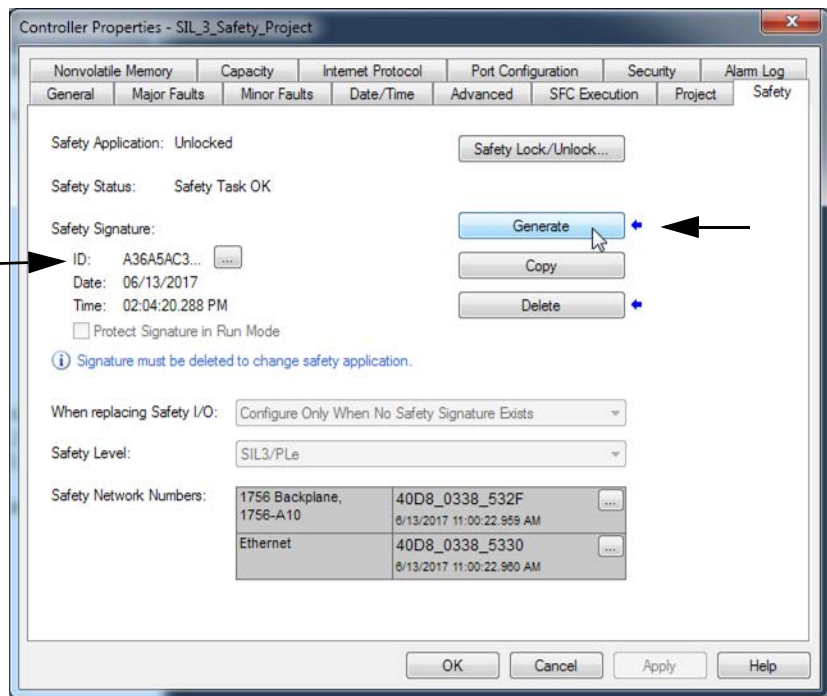

For the safety signature, GuardLogix 5580 controllers have a 32 byte ID. Only the first 4 bytes of the ID display on the tab. To view and copy the entire 32 byte ID, click [...] to open the Safety Signature ID dialog box.

TIP In the Logix Designer application, you can also choose Tools > Safety > Generate Signature.

If a previous signature exists, you are prompted to overwrite it.

TIP Safety signature creation and deletion is logged in the controller log. For more information on accessing the controller log, refer to Logix5000 Controllers Controller Information and Status Programming Manual, publication [1756-PM015](#).

When a safety signature exists, the following actions are not permitted in the safety portion of the application:

- Online/offline programming or editing (including safety Add-On Instructions)
- Force safety I/O
- Change the inhibit state of safety I/O or producer controllers
- Safety data manipulation (except by safety routine logic)
- Download a new safety application

Copy the Safety Signature

You can use the Copy button to create a record of the safety signature for use in safety project documentation, comparison, and validation.

Click Copy to copy the ID, Date, and Time components to the Windows clipboard.

Delete the Safety Signature

Click Delete to delete the safety signature. The safety signature cannot be deleted when the following is true:

- The controller is safety-locked.
- The controller is in Run mode with the mode switch in RUN.
- The controller is in Run or Remote Run mode with Protect Signature in Run Mode enabled.



ATTENTION: If you delete the safety signature, you must retest and re-validate your system to meet SIL2/PLd or SIL 3/PLe.

For more information on Safety Integrity Level (SIL) and Performance Level (PL) requirements, see the GuardLogix 5580 and Compact GuardLogix 5380 Controller Systems Safety Reference Manual, publication [1756-RM012](#).

Programming Restrictions

Restrictions limiting the availability of some menu items and features (that is, cut, paste, delete, and replace) are imposed by the Logix Designer application to protect safety components from being modified whenever any of these are true:

- The controller is safety-locked.
- A safety signature exists.
- Safety faults are present.
- Safety status is in any of these states when online:
 - Partner missing
 - Partner unavailable
 - Hardware incompatible
 - Firmware incompatible

IMPORTANT The maximum and last scan times of the safety task and safety programs can be reset when online.

If even one of these conditions apply, you cannot do the following:

- Create or modify safety objects, including safety programs, safety routines, safety tags, safety Add-On Instructions, and safety I/O devices.
- Apply forces to safety tags.
- Create new safety tag mappings.
- Modify or delete tag mappings.
- Modify or delete user-defined data types that are used by safety tags.
- Modify the controller name, description, chassis type, slot, and safety network number.
- Create, modify, or delete a safety connection.

When the controller is safety-locked, you cannot modify or delete the safety signature.

Monitor Safety Status

You can use the following to monitor the controller status:

- The Online bar in the Logix Designer application.
- The Safety tab in the Controller Properties dialog box.

View Status via the Online Bar

The online bar displays project and controller information, including the controller status, force status, online edit status, and safety status.

Figure 47 - Status Buttons



Controller Status

When the Controller Status button  is selected as shown above, the online bar shows the controller's mode (Remote Program) and status (OK). The Energy Storage OK indicator combines the status of the primary controller and the safety partner.

If either or both have an energy storage fault, the status indicator illuminates. The I/O indicator combines the status of standard and safety I/O. The I/O with the most significant error status is displayed next to the status indicator.

Forces status

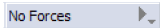
The Forces Status button  indicates Forces or No Forces. When the button is selected, the online bar shows whether I/O or SFC forces is enabled or disabled and installed or not installed. The ForcesStatus menu contains commands to remove, enable, or disable all forces.

Online Edit status

The Online Edit Status button  indicates whether edits or no edits exist in the online ladder routine or function block diagram. When the button is selected, the online bar shows the edit state of the controller. If edits are made by another user, this area will also show a textual description of the edits.

Safety Status

When you click the Safety Status button , the online bar displays the safety signature.

Figure 48 - Safety Signature Online Display



The Safety Status button itself indicates whether the controller is safety-locked or -unlocked, or faulted. It also displays an icon that shows the safety status.



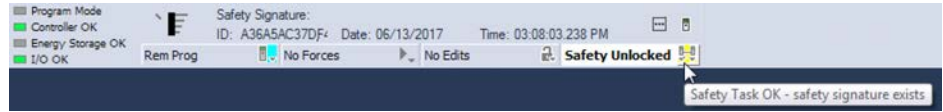









When a safety signature exists, the icons include a small check mark. 

Table 36 - Safety Status Icon

If the safety status is	This icon appears	
	SIL 2/PLd Application, both online and offline	SIL 3/PLe Application
Safety Unlocked		 The controller is not safety locked and online.  The controller is not safety locked and offline.
Safety Locked		 The controller is safety locked and online.  The controller is safety locked and offline.
Safety Faulted		
Safety Task Inoperable	 The controller is not safety locked and the safety task is inoperable  The controller is safety locked and the safety task is inoperable.  There is a safety fault and the safety task is inoperable.	

View Status via the Safety Tab

View controller safety status information on the safety status button on the online bar and on the Safety tab of the Controller Properties dialog box.

Figure 49 - Safety Task Status

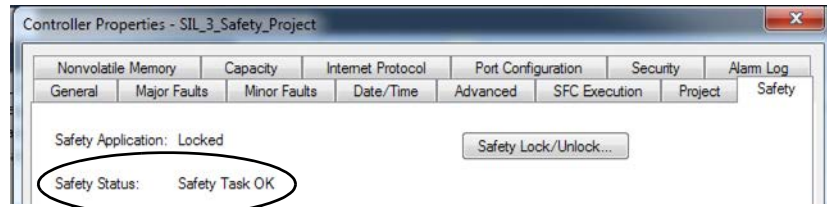

- Safety partner is missing or unavailable (SIL 3).
- Safety partner hardware is incompatible with primary controller.
- Safety partner firmware is incompatible with the primary controller.
- Safety task inoperable.
- Safety task OK.

With the exception of safety task OK, the descriptions indicate that nonrecoverable safety faults exist.

See [Major Safety Faults \(Type 14\) on page 205](#) for fault codes and corrective actions.

The status of the safety partner can be viewed on the Connections tab of its Module Properties dialog box.

Figure 50 - Safety Partner Status

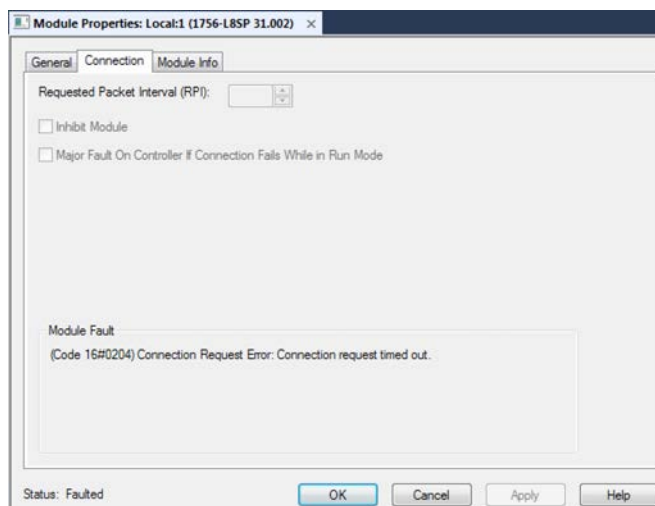

Monitor Safety Connections

For tags associated with consumed safety data, you can monitor the status of safety connections by using the CONNECTION_STATUS member. For monitoring input and output connections, safety I/O tags have a connection status member called SafetyStatus. Both data types contain two bits: ConnectionFaulted and RunMode.

The ConnectionFaulted value indicates whether the safety connection between the safety producer and the safety consumer is Valid (0) or Faulted (1). If ConnectionFaulted is set to Faulted (1) for any reason, the safety data is reset to zero and the RunMode value is set to Idle State (0).

The RunMode value indicates if consumed data is actively being updated by a device that is in the Run Mode (1) or Idle State (0). Idle state is indicated if the connection is closed, the safety task is faulted, or the remote controller or device is in Program mode or Test mode. For safety I/O connections, the RunMode is always inverse the ConnectionFaulted status. It does not provide unique data.

The following table describes the combinations of the ConnectionFaulted and RunMode states.

Table 37 - Safety Connection Status

ConnectionFaulted Status	RunMode Status	Safety Connection Operation
0 = Valid	1 = Run	Data is actively being controlled by the producing device. The producing device is in Run mode.
0 = Valid	0 = Idle	The connection is active and the producing device is in the Idle state. The safety data is reset to zero. This applies to consumed connections only.
1 = Faulted	0 = Idle	The safety connection is faulted. The state of the producing device is unknown. The safety data is reset to zero and the RunMode value is set to Idle State (0).
1 = Faulted	1 = Run	Invalid state.

If a device is inhibited, the ConnectionFaulted bit is set to Faulted (1) and the RunMode bit is set to Idle (0) for each connection associated with the device. As a result, safety consumed data is reset to zero.

Utilizing Status

Connection Status(.ConnectionFaulted) is the status of the safety connection between the safety controller and safety I/O module. When the connection is operating properly, this bit will be LO (0). When the connection is NOT operating properly, this bit will be HI (1). When the connection status is HI (connection not operating properly), all of the other module defined tags are LO, and should be considered 'invalid' data.

Point Status is available for both safety inputs (.PtxxInputStatus) and safety outputs (.PtxxOutputStatus). When a point status tag is HI (1), it indicates that individual channel is functioning and wired correctly, and that the safety connection between the safety controller and the safety I/O module on which this channel resides is operating properly.

Combined Status is also available for both safety inputs (.CombinedInputStatus) and safety outputs (.CombinedOutputStatus). When the combined status tag is HI (1), it indicates that all input or output channels on the module are functioning and wired correctly, and that the safety connection between the safety controller and the safety I/O module on which these channels reside is operating properly.

Whether combined status or point status is used is application dependent. Point status simply provides more granular status.

The dual-channel safety instructions have built in safety I/O status monitoring. Input status and Output status are parameters for the safety input and output instructions. The DCS instruction (and other dual-channel safety instructions) has input status for input channels A and B. The CROUT instruction has input status for Feedbacks 1 and 2, and has output status for the output channels driven by the CROUT outputs O1 and O2. The status tags used in these instructions must be HI (1) for the safety instruction output tag(s) (O1 for input instructions and O1/O2 for CROUT) to be energized.

For proper safety instruction operation, it is important to drive the input status and output status tags BEFORE/ABOVE the safety instruction as shown in [Figure 51](#).

Figure 51 - Instruction Examples

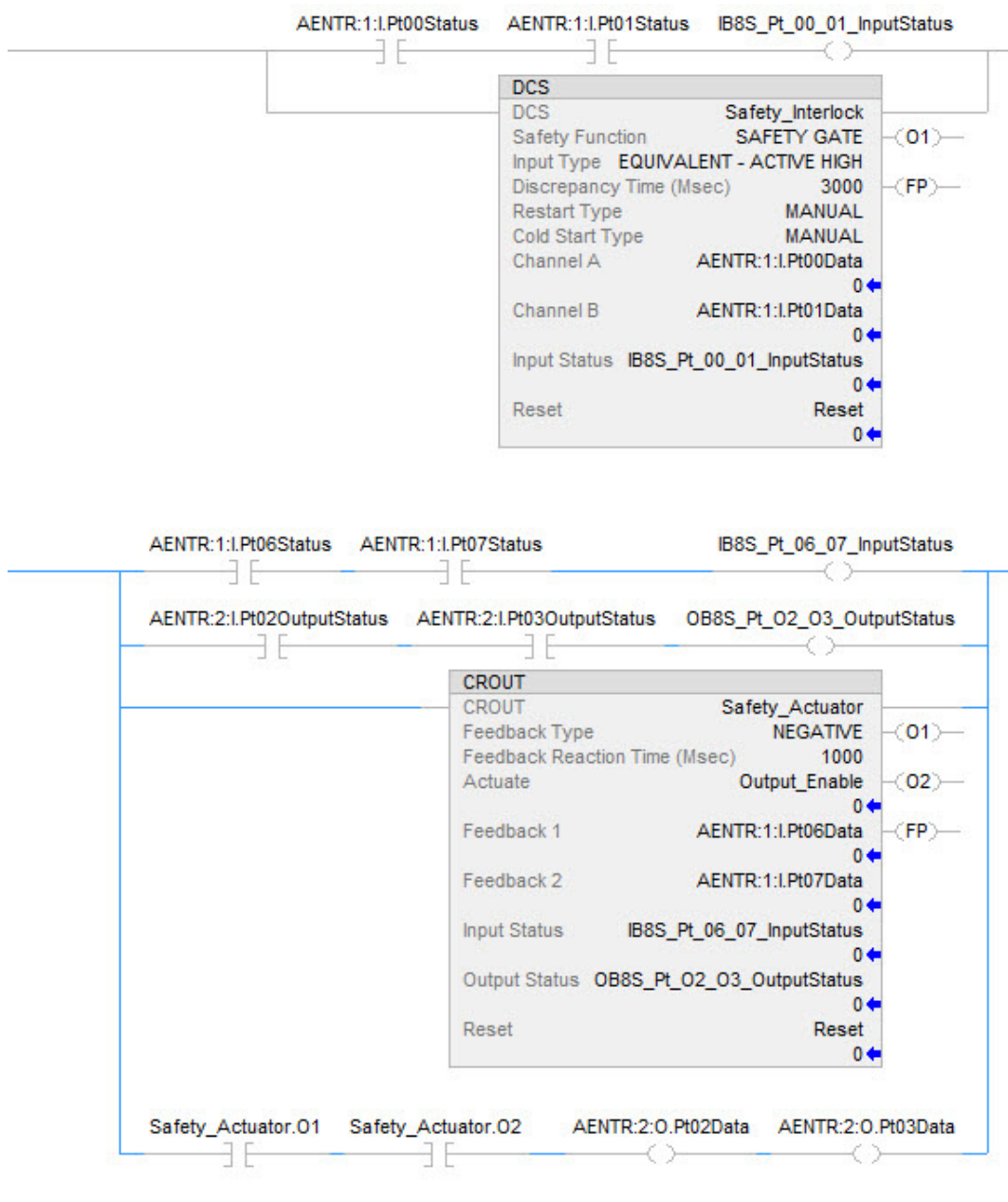

Safety I/O status should be interrogated when using instructions such as XIC and OTE. The responsibility for this falls to the user. The user should verify safety input channel status is HI (1) before using a safety input channel as an interlock. The user should verify safety output channel status is HI (1) before energizing a safety output channel.

Safety Faults

Major Faults in the GuardLogix system can be:

- Recoverable controller faults
- Nonrecoverable controller faults
- Nonrecoverable safety faults in the safety application
- Recoverable safety faults in the safety application

Nonrecoverable Controller Faults

These occur when the controller's internal diagnostics fail. If a nonrecoverable controller fault occurs, standard and safety task execution stops and outgoing connections stop. Safety I/O devices respond to the loss of output data by transitioning to the safe state. Recovery requires that you download the application program again.

If a fault occurs, diagnostic data is automatically written to the SD card. Rockwell Automation can then use the data to help investigate the cause of the fault. Contact Technical Support.

Nonrecoverable Safety Faults in the Safety Application

If a nonrecoverable safety fault occurs in the safety application, safety logic and the safety protocol are terminated. Safety task watchdog and control partnership faults fall into this category.

When the safety task encounters a nonrecoverable safety fault, a standard major recoverable fault is also logged, and the controller proceeds to execute the controller fault handler, if one exists. If the controller fault handler handles this fault, then the standard tasks continue to run, even though the safety task remains faulted.



ATTENTION: Overriding a safety fault does not clear the fault. If you override a safety fault it is your responsibility to prove that operation of your system is still safe.

You must provide proof to your certifying agency that your system can continue to operate safely after an override of a safety fault.

If a safety signature exists, you can clear the fault to enable the safety task to run. If no safety signature exists, the safety task cannot run again until the entire application is downloaded again.

- If you use the Clear Majors button or Clear Faults menu item in Logix Designer to clear the fault, the standard application should continue to run while the safety application is recovered from the snapshot.
- If you use the mode switch method (turn the mode switch to Program, then back to Run), the safety application is recovered from the snapshot, but the standard application briefly transitions out of Run mode.

Recoverable Faults in the Safety Application

If a recoverable fault occurs in the safety application, the system can halt the execution of the safety task, depending upon whether or not the fault is handled by Program Fault Routines in the safety application.

When a recoverable fault is cleared programmatically, the safety task continues without interruption.

When a recoverable fault in the safety application is not cleared programmatically, a Type 14, Code 2 recoverable safety fault occurs. The safety program execution is stopped, and safety protocol connections are closed and reopened to re-initialize them. Safety outputs are placed in the safe state and the producer of safety-consumed tags commands the consumers to place them in a safe state, as well.

If the recoverable safety fault is not handled, a standard major recoverable fault is also logged, and the controller proceeds to execute the controller fault handler, if one exists. If the controller fault handler handles this fault, then the standard tasks continue to run, even though the safety task remains faulted.

The occurrence of recoverable faults is an indication that the application code is not protecting itself from invalid data values or conditions. Consider modifying the application to eliminate these faults, rather than handling them at run-time.



ATTENTION: Overriding a safety fault does not clear the fault. If you override a safety fault it is your responsibility to prove that operation of your system is still safe.

You must provide proof to your certifying agency that your system can continue to operate safely after an override of a safety fault.

View Faults

The Recent Faults dialog box on the Major Faults tab of the Controller Properties dialog box contains two sub-tabs, one for standard faults and one for safety faults.

The status display on the controller also shows fault codes with a brief status message, as described beginning on page [207](#).

Fault Codes

[Table 38](#) shows the fault codes specific to GuardLogix controllers. The type and code correspond to the type and code displayed on the Major Faults tab of the Controller Properties dialog box and in the PROGRAM object, MAJORFAULTRECORD (or MINORFAULTRECORD) attribute.

Table 38 - Major Safety Faults (Type 14)

Code	Cause	Status	Corrective Action
01	Task watchdog expired. User task has not completed in a specified period of time. A program error caused an infinite loop, the program is too complex to execute as quickly as specified, a higher priority task is keeping this task from finishing, or the safety partner has been removed.	Nonrecoverable	Clear the fault. If a safety signature exists, safety memory is re-initialized and the safety task begins executing. If a safety signature does not exist, you must re-download the program so the safety task can run. Reinsert the safety partner, if it was removed.
02	An error exists in a routine of the safety task.	Recoverable	Correct the error in the user-program logic.
03	Safety partner is missing.	Nonrecoverable	Install a compatible safety partner.
04	Safety partner is unavailable.	Nonrecoverable	Install a compatible safety partner.
05	Safety partner hardware is incompatible.	Nonrecoverable	Install a compatible safety partner.
06	Safety partner firmware is incompatible.	Nonrecoverable	Update the safety partner so that the firmware major and minor revision matches the primary controller.
07	Safety task is inoperable. This fault occurs when the safety logic is invalid, for example a mismatch in logic exists between the primary controller and safety partner, a watchdog timeout occurred, or memory is corrupt.	Nonrecoverable	Clear the fault. If a safety signature exists, safety memory is re-initialized via the safety signature and the safety task begins executing. If a safety signature does not exist, you must download the program again so the safety task can run.
09	Safety partner nonrecoverable controller fault.	Nonrecoverable	Clear the fault and download the program. If the problem persists, replace the safety partner.

The Logix5000 Controllers Major and Minor Faults Programming Manual, publication [1756-PM014](#), contains descriptions of the fault codes common to Logix controllers.

Develop a Fault Routine for Safety Applications

If a fault condition occurs that is severe enough for the controller to shut down, the controller generates a major fault and stops the execution of logic.

Some applications do not want all safety faults to shut down the entire system. In those situations, use a fault routine to clear a specific fault and let the standard control portion of your system continue to operate or configure some outputs to remain ON.



ATTENTION: You must provide proof to your certifying agency that your system can continue to operate safely after an override of a safety fault.

The occurrence of recoverable faults is an indication that the application code is not protecting itself from invalid data values or conditions. Consider modifying the application to eliminate these faults, rather than handling them at run-time.

The controller supports two levels for handling major faults in a safety application:

- Safety Program Fault Routine
- Controller Fault Handler

Both routines can use the GSV and SSV instructions as described on page [207](#).

Each safety program can have its own fault routine. The controller executes the program's fault routine when an instruction fault occurs. If the program's fault routine does not clear the fault, or if a program fault routine does not exist, the safety task faults and shuts down.

When the safety task faults, a standard major recoverable fault is also logged, and the controller proceeds to execute the controller fault handler, if one exists. If the controller fault handler handles this fault, then the standard tasks continue to run, even though the safety task remains faulted.

The controller fault handler is an optional component that executes when the program fault routine cannot clear the fault or does not exist.

You can create one program for the controller fault handler. After you create that program, you must configure a routine as the main routine.

The Logix5000 Controllers Major and Minor Faults Programming Manual, publication [1756-PM014](#), provides details on creating and testing a fault routine.

Use GSV/SSV Instructions in a Safety Application

For standard tasks, you can use the GSV instruction to get values for the available attributes. When using the SSV instruction, the software displays only the attributes that you can set.

For the safety task, the GSV and SSV instructions are more restricted. Note that SSV instructions in safety and standard tasks cannot set bit 0 (major fault on error) in the mode attribute of a safety I/O device.



ATTENTION: Use the SSV instruction carefully. Making changes to objects can cause unexpected controller operation or injury to personnel.

Access FaultRecord Attributes

Create a user-defined structure to simplify access to the MajorFaultRecord and SafetyTaskFaultRecord attributes.

Table 39 - Parameters for Accessing FaultRecord Attributes

Name	Data Type	Style	Description
TimeLow	DINT	Decimal	Lower 32 bits of the fault timestamp value
TimeHigh	DINT	Decimal	Upper 32 bits of the fault timestamp value
Type	INT	Decimal	Fault type (program, I/O, or other)
Code	INT	Decimal	Unique code for this fault (dependent on fault type)
Info	DINT[8]	Hexadecimal	Fault-specific information (dependent on fault type and code)

Capture Fault Information

The SafetyStatus and SafetyTaskFaultRecord attributes can capture information about non-recoverable faults. Use a GSV instruction in the controller fault handler to capture and store fault information. The GSV instruction can be used in a standard task in conjunction with a controller fault handler routine that clears the fault and lets the standard tasks continue executing.

For more information on using the GSV and SSV instructions in safety applications, refer to the Input/Output Instructions chapter of the Logix5000 Controllers General Instructions Reference Manual, publication [1756-RM003](#).

Notes:

ControlLogix



GuardLogix



Develop Motion Applications

Topic	Page
Motion Overview	210
Obtain Axis Information	213
Program Motion Control	211

The controllers support these motion interfaces:

- Integrated Motion on an EtherNet/IP network.
- Digital drive interfaces include EtherNet/IP connected drives and Sercos interface connected drives.
- Analog drives support $\pm 10V$ analog output and can interface with various feedback device types including quadrature encoder, SSI, and LVDT feedback.

For more information, see these publications:

- Integrated Motion on the EtherNet/IP Network Configuration and Startup User Manual, publication [MOTION-UM003](#).
- Integrated Motion on the EtherNet/IP Network Reference Manual, Publication [MOTION-RM003](#).
- SERCOS and Analog Motion Configuration and Startup User Manual, publication [MOTION-UM001](#)

Motion Overview

The controllers support up to 256 axes of integrated motion. The 256 axes can be any combination of CIP, Virtual, and Consumed axes. You can add all axes to one Motion Group, and you can assign any combination of axes to different axis update schedules.

TIP Rockwell Automation recommends using the built-in EtherNet/IP port for high-performance motion applications.

You can associate Integrated Motion axes to any appropriate drive, regardless of whether the communications path to the drive is via the embedded Ethernet port, or over the 1756 backplane (through an Ethernet bridge such as a 1756-EN2T).

The configuration process varies, depending on your application and your drive selection. The following are general steps to configure a motion application.

1. Create a controller project.
2. Select the type of drive.

Drive Type	Requirements
CIP Motion	<ul style="list-style-type: none"> • EtherNet/IP communication module • Digital drive with an EtherNet/IP connection
Sercos interface	Select a Sercos interface module: <ul style="list-style-type: none"> • 1756-M03SE • 1756-M08SE • 1756-M16SE
Analog interface	Select an analog interface module: <ul style="list-style-type: none"> • 1756-HYD02 • 1756-M02AE • 1756-M02AS

3. Create axis tags as needed.
4. Configure the drive.
5. Create axes as needed.

Program Motion Control

The controller provides a set of motion control instructions for your axes:

- The controller uses these instructions just like the rest of the Logix 5000™ instructions.
- Each motion instruction works on one or more axes.
- You can program by using motion control instructions in these programming languages:
 - Ladder Diagram (LD)
 - Structured Text (ST)
 - Sequential Function Chart (SFC)
- Each motion instruction needs a motion control tag. The tag uses a MOTION_INSTRUCTION data type and stores the information status of the instruction.

For more information, see the Logix5000 Controller Motion Instructions Reference Manual, publication [MOTION-RM002](#).



ATTENTION: Use each motion control tag in only one motion instruction. Unintended operation can result if you reuse the same motion control tag in other motion instructions, or if you write to any of the motion control tag elements.

In this example, a simple ladder diagram that homes, jogs, and moves an axis.

If Initialize_Pushbutton = on and the axis = off (My_Axis_X.ServoActionStatus = off) then the MSO instruction turns on the axis.

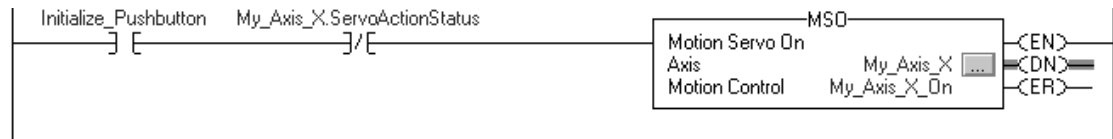

If Home_Pushbutton = on and the axis hasn't been homed (My_Axis_X.AxisHomedStatus = off) then the MAH instruction homes the axis.

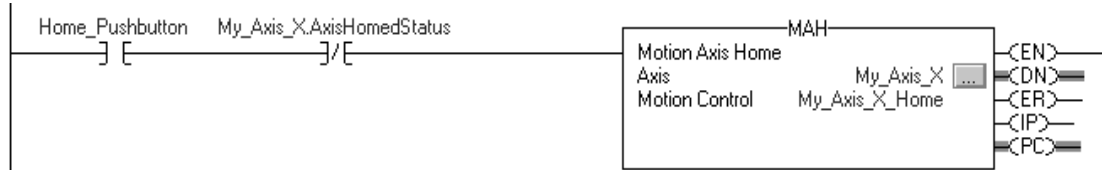

If Jog_Pushbutton = on and the axis = on (My_Axis_X.ServoActionStatus = on) then the MAJ instruction jogs the axis forward at 8 units/second.

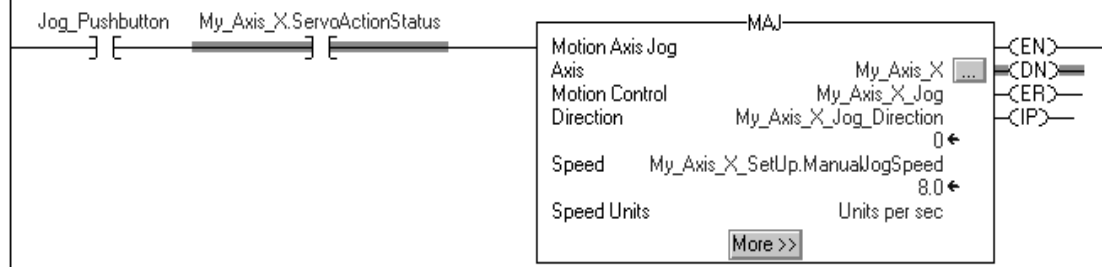

If Jog_Pushbutton = off then the MAS instruction stops the axis at 100 units/second². Make sure that Change Decel is Yes. Otherwise, the axis decelerates at its maximum speed.

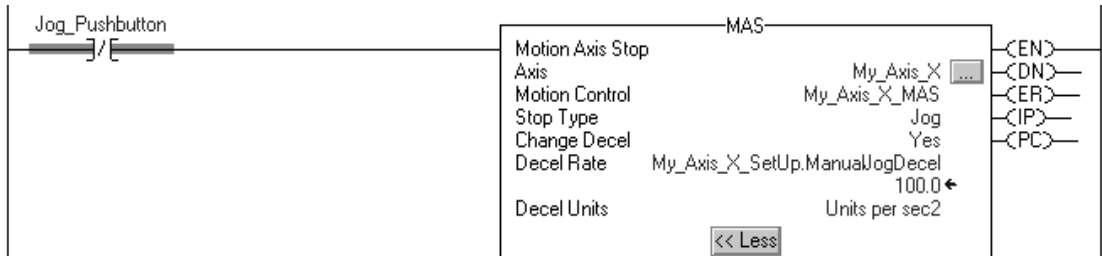

If Move_Command = on and the axis = on (My_Axis_X.ServoActionStatus = on) then the MAM instruction moves the axis. The axis moves to the position of 10 units at 1 unit/second.

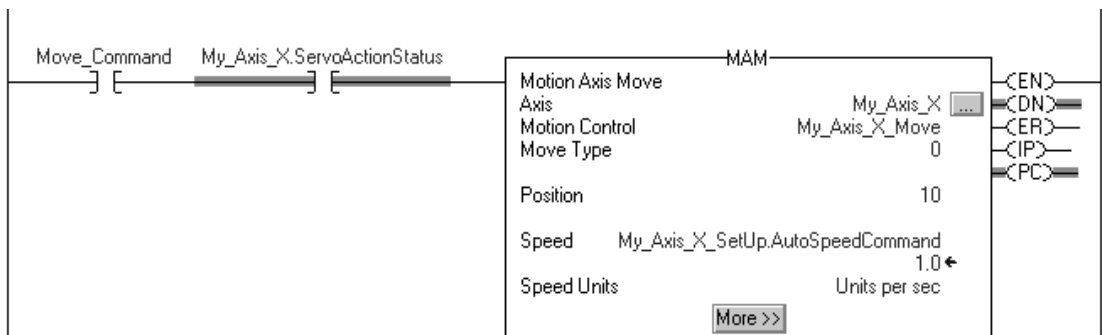

Obtain Axis Information

You can obtain axis information by using these methods:

- Double-click the axis to open the Axis Properties dialog box.
- Use a Get System Value (GSV) or Set System Value (SSV) instruction to read or change the configuration at runtime.
- View the QuickView™ pane to see the state and faults of an axis.
- Use an axis tag for status and faults.

Figure 52 - Obtain Axis Information

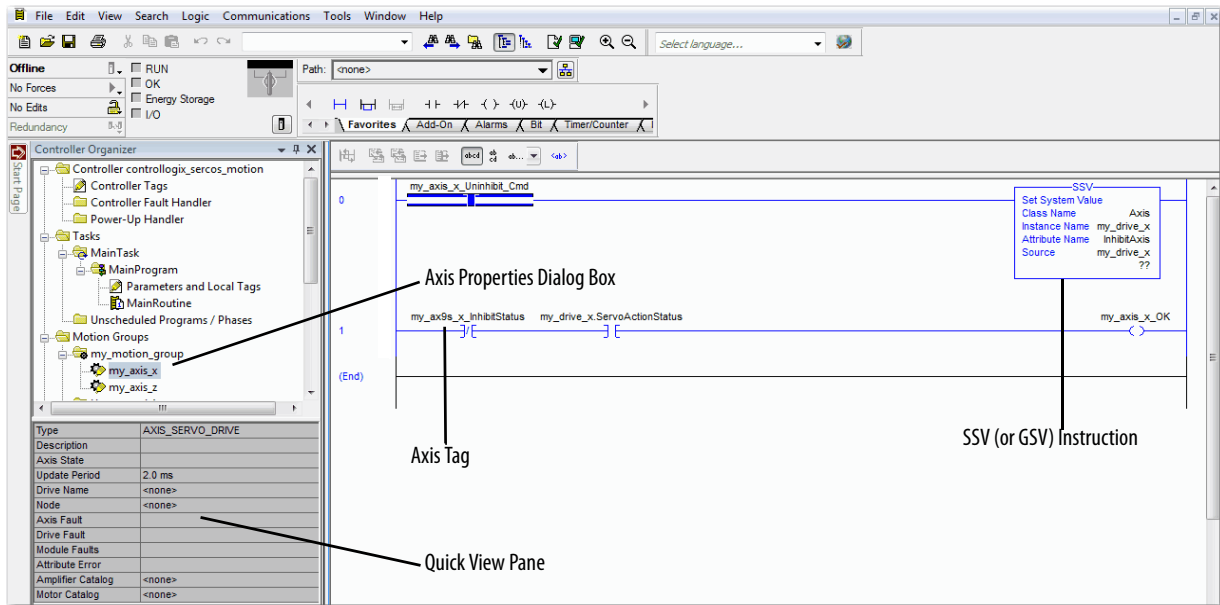

Notes:

ControlLogix



GuardLogix



Troubleshoot the Controller

Topic	Page
Controller Diagnostics with Logix Designer	215
Controller Diagnostics with Linx-based Software	224
Controller Web Pages	225

This chapter describes how to troubleshoot the controller if issues occur during normal operation. In addition to the ways described in this chapter, you can use messages on the 4-character display to troubleshoot the controller. For more information, [Status Indicators on page 307](#).

Controller Diagnostics with Logix Designer

A warning symbol appears in the controller organizer next to the I/O module. This occurs when there are faults or other conditions in the I/O module, or if the connection to the I/O module fails while in run mode.

- If you have set a standard I/O module to fault the controller when the connection fails, then the controller state indicates Faulted and the controller status displays Controller Fault and is lit solid red. I/O Not Responding blinks green.
- If you have set a standard I/O module to not fault the controller when the connection fails, or there is a safety connection fault, then the controller status displays Controller OK and is lit solid green. I/O Not Responding blinks green.

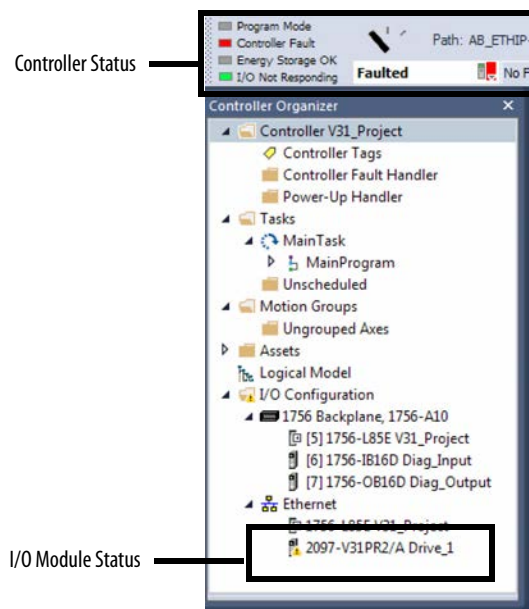

I/O Module set to fault controller

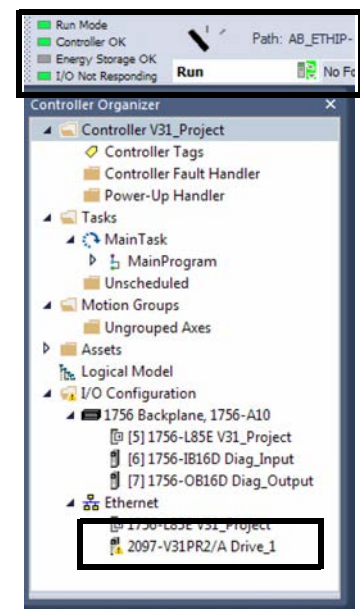

I/O Module set to not fault controller

IMPORTANT Safety Consideration

You cannot configure safety connections to automatically fault the controller.

I/O Module Properties Tab

The General, Connection, and Module Info tabs show fault information.

- Message in the status line on the General Tab of an I/O module Properties.

ControlLogix



GuardLogix

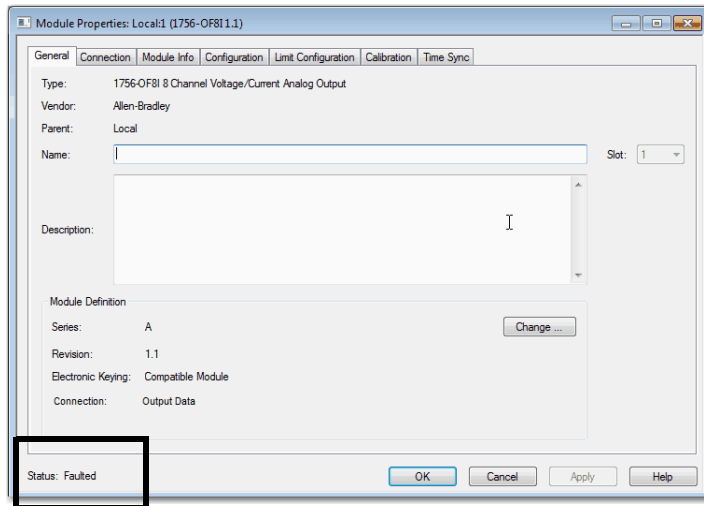

- The Connection tab shows the module fault. This example shows a communications fault.

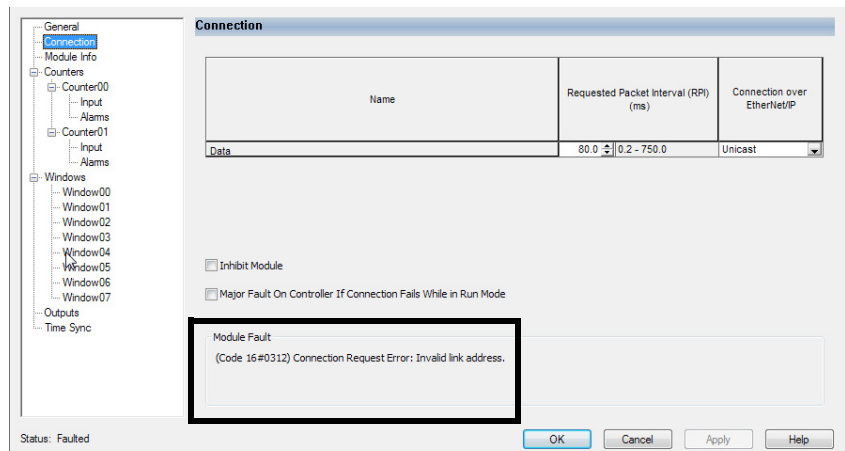

- On the Module Info tab, the Status section lists the Major and Minor Faults along with the Internal State of the module.

The Module Info tab requires successful communications. If communication to the I/O module is OK, but the module itself is faulted, then the Module Info tab helps in troubleshooting the fault. If there is a communication fault, then the Connection Tab would be of more use.

If communications are faulted, and you try to view the Module Info Tab, a dialog box appears that shows the module reported general error status and the fault code.

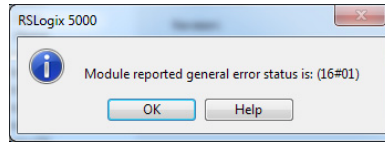

Notification in the Tag Monitor

ControlLogix



GuardLogix



General module faults are also reported in the Tag Monitor. Diagnostic faults are reported only in the Tag Monitor. When the Value field is set to 1, a fault is present.

Figure 53 - I/O Module Fault

Name	Value	Force Mask	Style	Data Type
Local:1:C	{...}	{...}		AB:1756_OF8I:C:0
Local:1:I	{...}	{...}		AB:1756_OF8I:I:0
Local:1:I.Fault	2#1111_11...		Binary	DINT
Local:1:I.Fault.0	1		Decimal	BOOL
Local:1:I.Fault.1	1		Decimal	BOOL
Local:1:I.Fault.2	1		Decimal	BOOL
Local:1:I.Fault.3	1		Decimal	BOOL
Local:1:I.Fault.4	1		Decimal	BOOL

Figure 54 - Safety I/O Connection Fault

Name	Value	Force Mas	Style	Data Type
Remote_Safety_Input_2:I	{...}	{...}		AB:1732ES_IB12XOB4_Safe
Remote_Safety_Input_2:I.ConnectionFaulted	1		Decimal	BOOL
Remote_Safety_Input_2:I.Pt00Data	0		Decimal	BOOL
Remote_Safety_Input_2:I.Pt01Data	0		Decimal	BOOL
Remote_Safety_Input_2:I.Pt02Data	0		Decimal	BOOL
Remote_Safety_Input_2:I.Pt03Data	0		Decimal	BOOL

Enable Major Fault on Controller

ControlLogix



To display recent I/O fault information in the Major Faults tab of the Controller Properties screen, you must first check the Major Fault on Controller option on the I/O Properties Connection tab.



WARNING: If you select this option, a connection fault on the I/O module can cause a major fault on the controller. A major fault on the controller causes the outputs to go to their configured fault state.

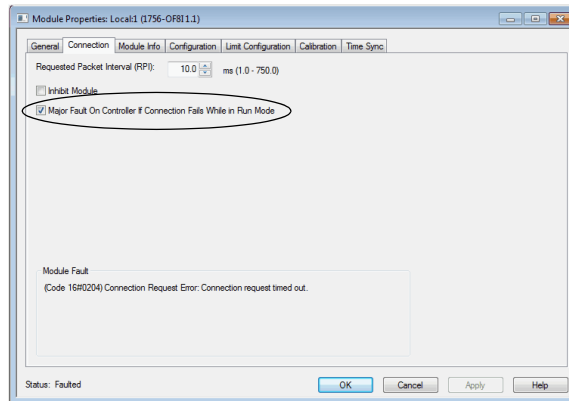

When you are monitoring the configuration properties of a module in the Logix Designer application and receive a Communication fault message, the Major Faults tab indicates the type of fault under Recent Faults.

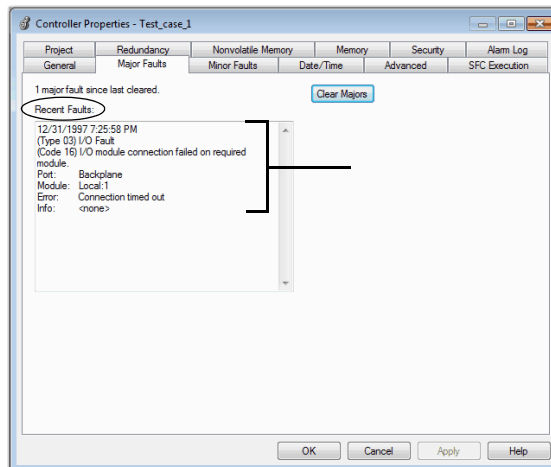

Port Diagnostics

When your project is online, you can view the status of the embedded Ethernet port on the controller.

ControlLogix



GuardLogix



1. In the I/O Configuration, double-click on the controller to display the Controller Properties.
2. Click the Port Configuration tab.
3. On the Port Configuration tab, click the Port Diagnostics button.

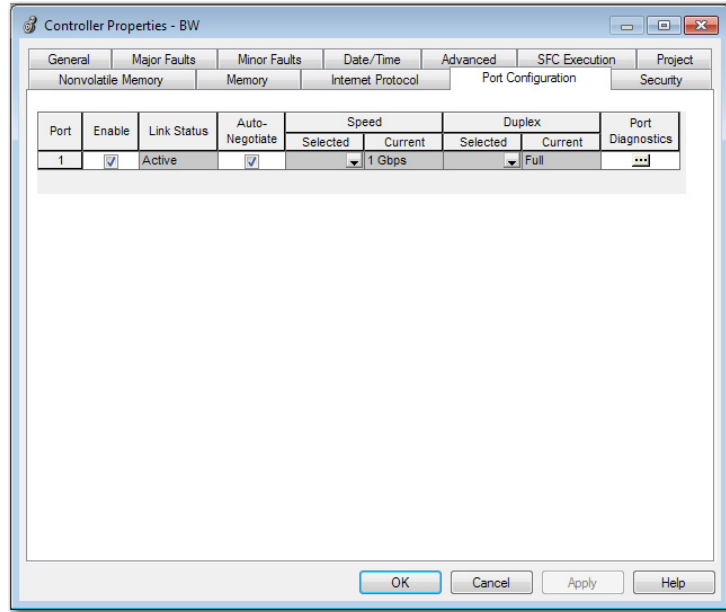

The Port Diagnostics page, displays information for the port. See [Table 40 on page 220](#) for parameter descriptions.

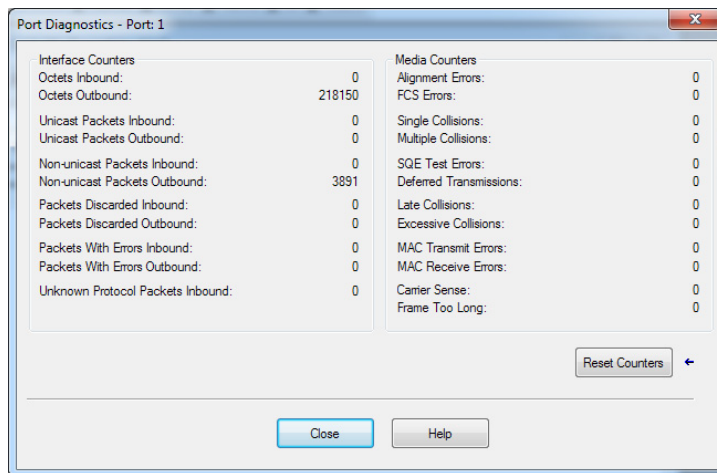

Table 40 - Port Diagnostics Parameters - Logix Designer Application

Parameter	Description
Interface Counters	The Interface Counters values have no value when you are offline or online and there is a communication error.
Octets Inbound	Displays the number of octets that are received on the interface.
Octets Outbound	Displays the number of octets that are transmitted to the interface.
Unicast Packets Inbound	Displays the number of unicast packets that are received on the interface.
Unicast Packets Outbound	Displays the number of unicast packets that are transmitted on the interface.
Non-unicast Packets Inbound	Displays the number of non-unicast packets that are received on the interface.
Non-unicast Packets Outbound	Displays the number of non-unicast packets that are transmitted on the interface.
Packets Discarded Inbound	Displays the number of inbound packets that are received on the interface but discarded.
Packets Discarded Outbound	Displays the number of outbound packets that are transmitted on the interface but discarded.
Packets With Errors Inbound	Displays the number of inbound packets that contain errors (excludes discarded inbound packets).
Packets With Errors Outbound	Displays the number of outbound packets that contain errors (excludes discarded outbound packets).
Unknown Protocol Packets Inbound	Displays the number of inbound packets with unknown protocol.
Media Counters	The Media Counters values have no value when you are offline or online and there is a communication error.
Alignment Errors	Displays the number of frames received that are not an integral number of octets in length.
FCS Errors	Displays the number of frames received that do not pass the FCS check.
Single Collisions	Displays the number of successfully transmitted frames that experienced exactly one collision.
Multiple Collisions	Displays the number of successfully transmitted frames that experienced multiple collisions.
SQE Test Errors	Displays the number of times an SQE test error message was generated.
Deferred Transmissions	Displays the number of frames for which the first transmission attempt is delayed because the medium is busy.
Late Collisions	Displays the number of times a collision is detected later than 512 bit-times into the transmission of a packet.
Excessive Collisions	Displays the number of frames for which transmission fails due to excessive collisions.
MAC Transmit Errors	Displays the number of frames for which transmission fails due to an internal MAC sub layer transmit error.
MAC Receive Errors	Displays the number of frames for which reception on an interface fails due to an internal MAC sub layer receive error.
Carrier Sense	Displays the number of times that the carrier sense condition was lost or never asserted when attempting to transmit a frame.
Frame Too Long	Displays the number of frames received that exceed the maximum permitted frame size.
Reset Counters	Click Reset Counter to cause the interface and media counter values on the module to set to zero, and the values in the dialog to update to the current counter values. Reset Counter appears dimmed when: <ul style="list-style-type: none"> • offline • online and a communication error has occurred

Advanced Time Sync

ControlLogix



GuardLogix



The Advanced Time Sync dialog displays information that is related to CIP Sync time synchronization. The information appears only if the project is online, and Time Synchronization is enabled on the Date/Time tab.

1. On the Date/Time, click the Advanced button.

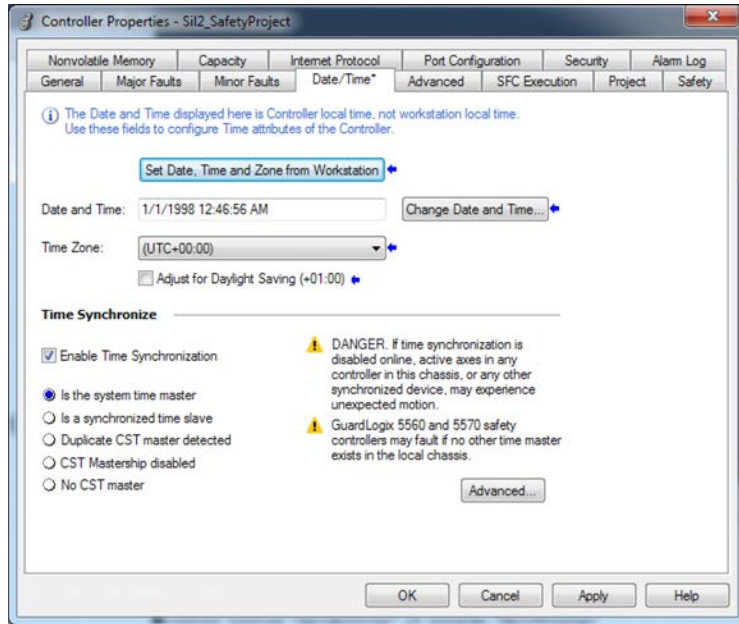

The Advanced Time Sync dialog box opens. See [Table 41 on page 222](#) for parameter descriptions.

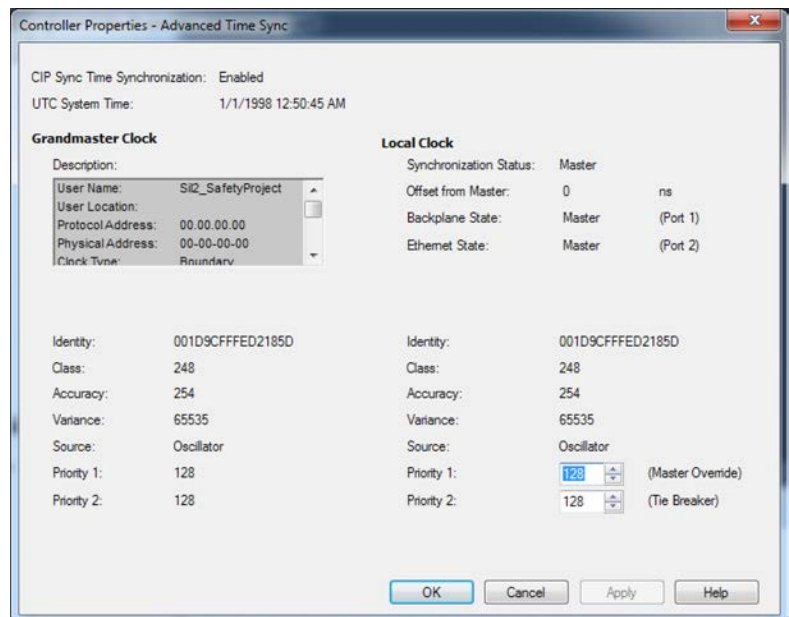

Table 41 - Time Sync Parameters

Grandmaster Clock	
Description	Displays information about the Grandmaster clock. The vendor of the Grandmaster device controls this information. The following information is specified: <ul style="list-style-type: none"> • User Name • User Location • Protocol Address • Physical Address • Clock Type • Manufacturer Name • Model • Serial Number • Hardware Revision • Firmware Revision • Software Revision • Profile Identity • Physical Protocol • Network Protocol • Port Number Use the vertical scroll bar to view the data.
Identity	Displays the unique identifier for the Grandmaster clock. The format depends on the network protocol. Ethernet network encodes the MAC address into the identifier.
Class	Displays a measure of the quality of the Grandmaster clock. Values are defined from 0...255 with zero as the best clock.
Accuracy	Indicates the expected absolute accuracy of the Grandmaster clock relative to the PTP epoch. The accuracy is specified as a graduated scale that starts at 25 nsec and ends at greater than 10 seconds or unknown. The lower the accuracy value, the better the clock.
Variance	Displays the measure of inherent stability properties of the Grandmaster clock. The value is represented in offset scaled log units. The lower the variance, the better the clock.
Source	Displays the time source of the Grandmaster clock. The available values are: <ul style="list-style-type: none"> • Atomic Clock • GPS • Radio • PTP • NTP • HAND set • Other • Oscillator
Priority 1 / Priority 2	Displays the relative priority of the Grandmaster clock to other clocks in the system. The priority values range from 0...255. The highest priority is zero. The default value for both settings is 128.
Local Clock	
Synchronization Status	Displays whether the local clock is synchronized or not synchronized with the Grandmaster reference clock. A clock is synchronized if it has one port in the slave state and is receiving updates from the time master.
Offset to Master	Displays the amount of deviation between the local clock and the Grandmaster clock in nanoseconds.
Backplane State	Displays the current state of the backplane. The available values are: Initializing, Faulty, Disabled, Listening, PreMaster, Master, Passive, Uncalibration, Slave, or None.
Ethernet State	Displays the state of the Ethernet port. The available values are: Initializing, Faulty, Disabled, Listening, PreMaster, Master, Passive, Uncalibration, Slave, or None.
Identity	Displays the unique identifier for the local clock. The format depends on the network protocol. Ethernet network encodes the MAC address into the identifier.
Class	Displays a measure of quality of the local clock. Values are defined from 0...255, with zero as the best clock.

Table 41 - Time Sync Parameters (continued)

Accuracy	Indicates the expected absolute accuracy of the local clock relative to the PTP epoch. The accuracy is specified as a graduated scale that starts at 25 nsec and ends at greater than 10 seconds or unknown. The lower the accuracy value, the better the clock.
Variance	Displays the measure of inherent stability properties of the local clock. The value is represented in offset scaled log units. The lower the variance, the better the clock.
Source	<p>Displays the time source of the local clock. The available values are:</p> <ul style="list-style-type: none"> • Atomic Clock • GPS • Terrestrial Radio • PTP • NTP • HAND set • Other • Oscillator

Controller Diagnostics with Linx-based Software

You can also view diagnostic information in Linx-based software.

ControlLogix



GuardLogix



1. From the Communications menu, choose RSWho.

The RSWho dialog box appears.

2. Navigate to the Ethernet network.
3. Right-click the controller and choose Module Statistics.

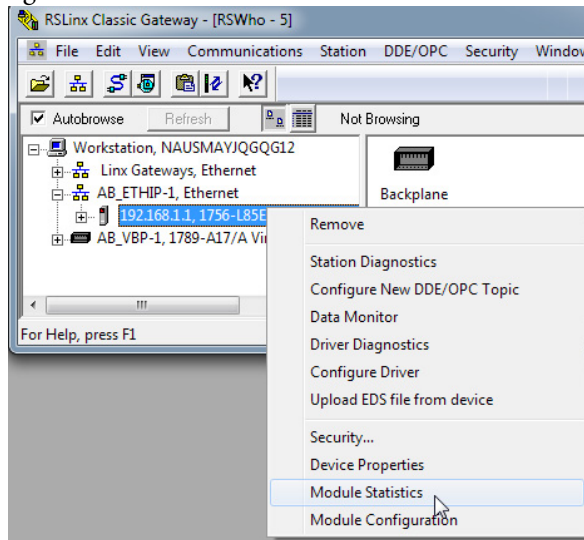

The Module Statistics dialog provides this information:

- The General tab shows device information, and any faults on the controller.
- The Port Diagnostics tab shows information for the EtherNet/IP port.
- The Connection Manager Tab shows information on connection requests.
- The Backplane tab shows general status and diagnostic-related information about the ControlLogix® backplane.
- The USB tab shows information about the USB port.

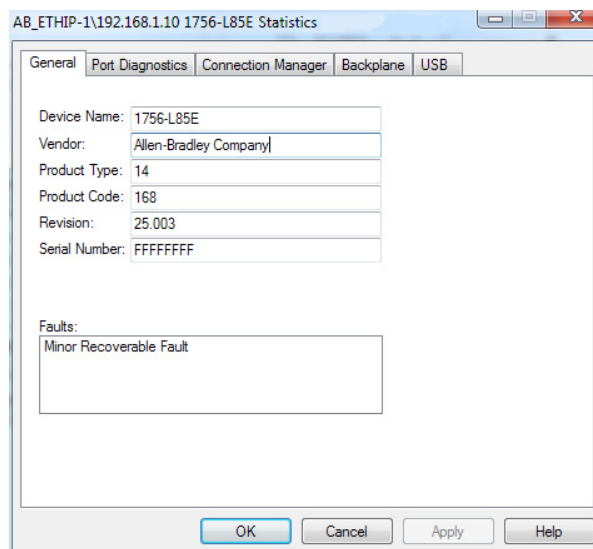

Controller Web Pages

ControlLogix



GuardLogix



The controller provides diagnostic web pages that track controller performance, network performance, and backplane performance.

To access the diagnostic web pages, follow these steps.

1. Open your web browser.
2. In the Address field, type the IP address of the controller and press Enter.

To access the diagnostic web pages, open the Diagnostics folder in the left-most navigation bar, and click the link for each diagnostic web page you need to monitor.

- The Home page provides device information and controller status.

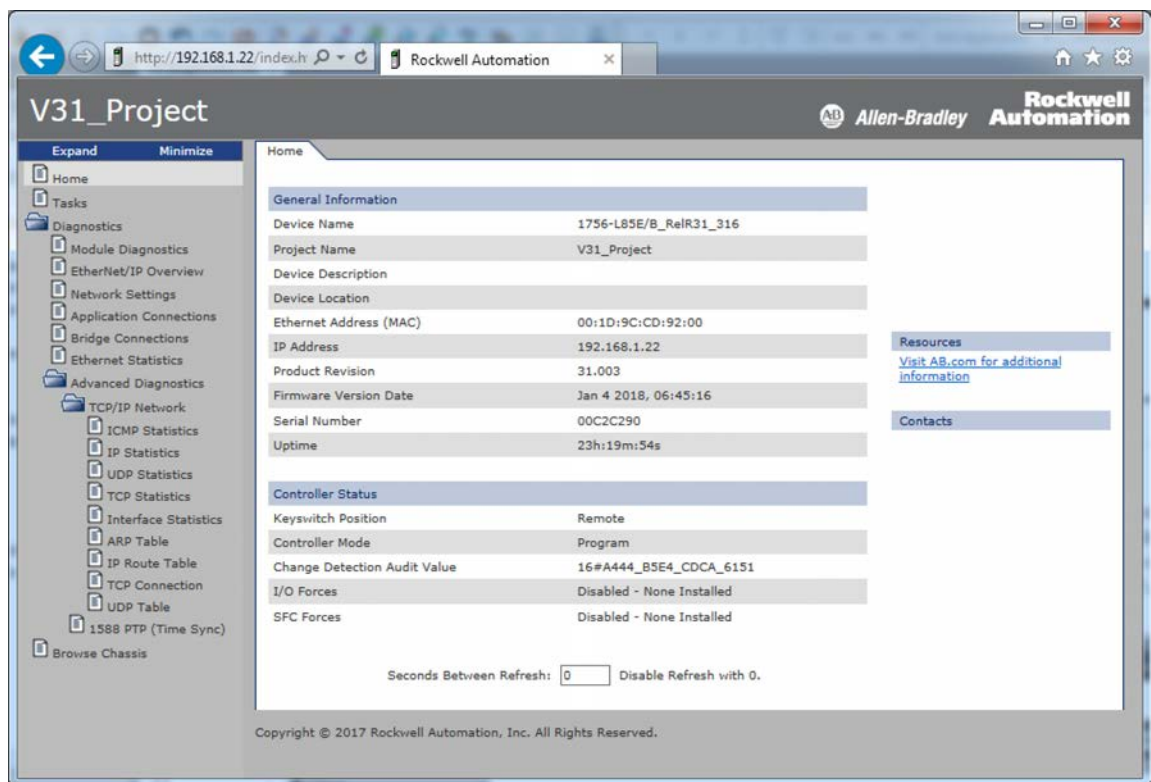

- The Diagnostics web pages provide communications and messaging data for the controller.
- The Advanced diagnostics web pages provide data about the TCP/IP Network and Precision Time Protocol.

Also see:

- [Tasks Webpage on page 226](#)
- [Browse Chassis Webpage on page 227](#)

Tasks Webpage

On the Tasks webpage, the pie chart shows the percentage of the control core's CPU consumed by the tasks that are on that core. The gauges show the CPU utilization of the control and communications cores. The table shows the tasks that are running on the control core (all system tasks are summarized as one task).

This example shows the Tasks webpage from a GuardLogix 5580 controller:

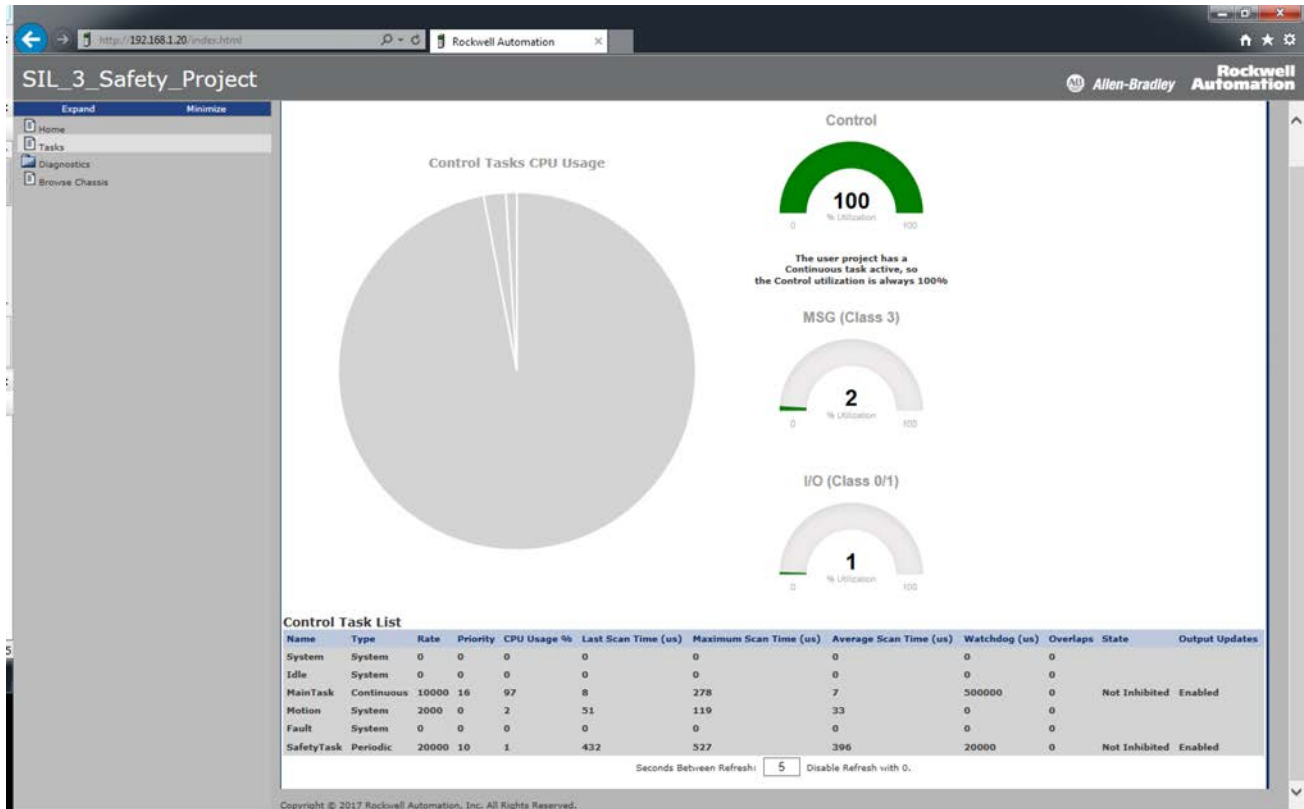

Browse Chassis Webpage

Browse Chassis lets you view module information, backplane statistics, and connection statistics for modules in the local chassis.

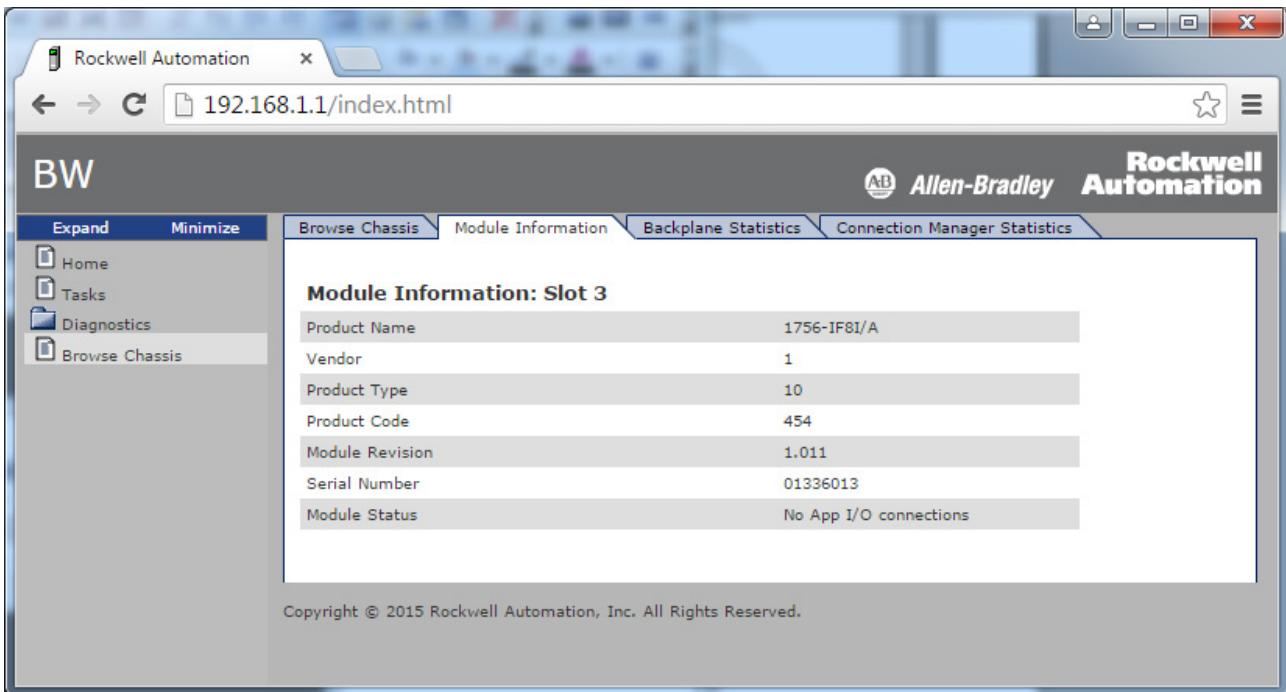
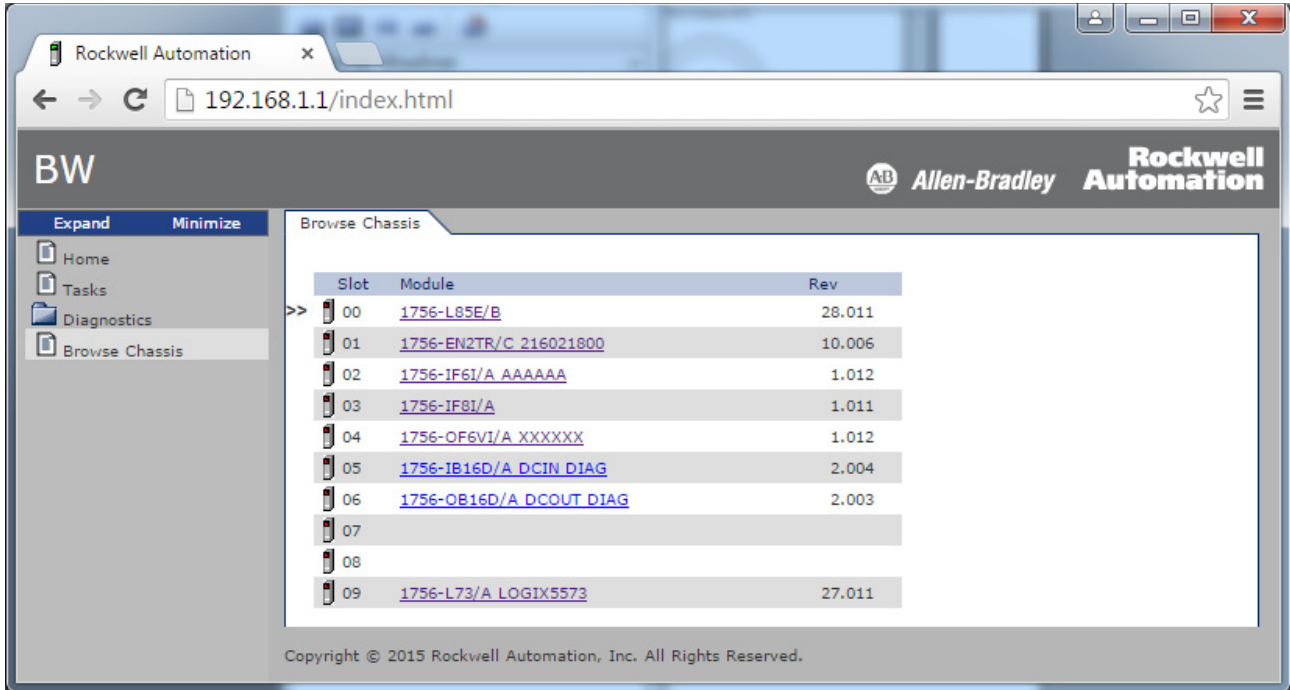

Notes:

Status Indicators

The controller has six status indicators and one four-character scrolling status display. The 1756-L8SP safety partner has the four-character scrolling status display and the OK status indicator.

Topic	Page
Status Display and Indicators	230
General Status Messages	231
GuardLogix Status Messages	232
Safety Partner Status Messages	233
Fault Messages	233
Major Fault Messages	234
I/O Fault Codes	236
Controller Status Indicators	239
Safety Partner OK Indicator	241
EtherNet/IP Indicators	241
Thermal Monitoring and Thermal Fault Behavior	242

Status Display and Indicators

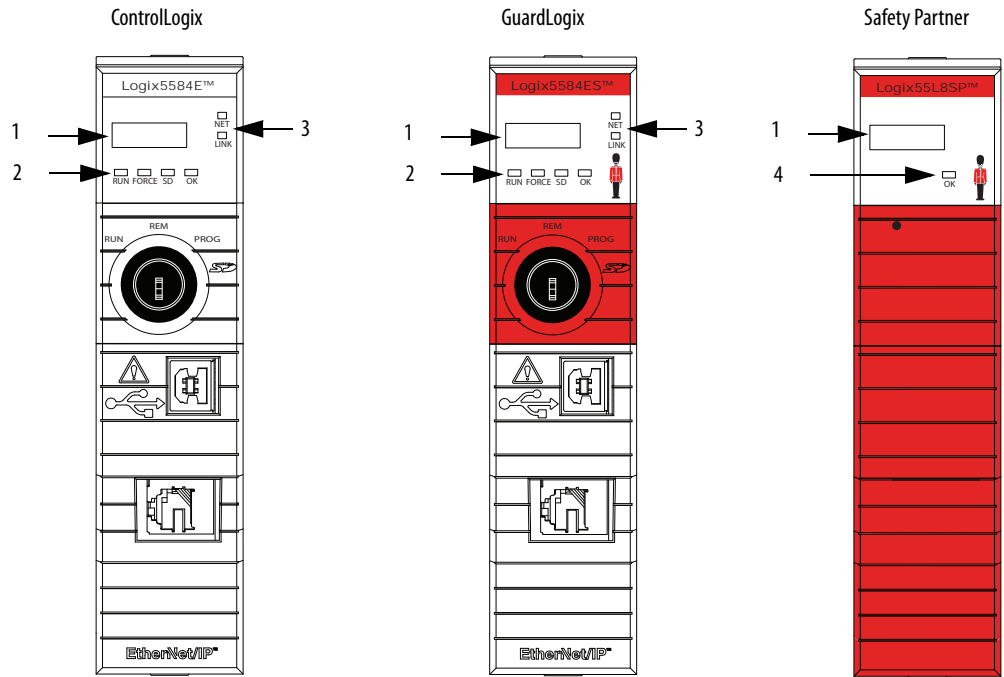

Item	Description
1	4-Character Scrolling Status Display You can disable some of these messages, see Security Options on page 243 .
2	Controller Status Indicators, see page 239
3	EtherNet/IP Status Indicators, see page 241
4	Safety Partner OK Status Indicator, see page 241

General Status Messages

ControlLogix



GuardLogix



The scrolling messages that are described in [Table 42](#) are typically indicated upon powerup, powerdown, and while the controller is running to show the status of the controller.

Table 42 - Controller General Status Messages

Message	Interpretation
No message is indicated	The controller is Off. Check the OK indicator to determine if the controller is powered and determine the state of the controller.
TEST	The controller is conducting power-up tests.
CHRG	The embedded energy storage circuit is charging.
PASS	Power-up tests have been successfully completed.
Saving... Do Not Remove SD Card	The controller is about to save an image to the SD card.
SAVE	A project is being saved to the SD card. You can also view the SD Indicator (see page 240) for more status information. Allow the save to complete before: <ul style="list-style-type: none"> Removing the SD card. Disconnecting the power. <p>IMPORTANT: Do not remove the SD card while the controller is saving to the SD card. Allow the save to complete without interruption. If you interrupt the save, data corruption or loss can occur.</p>
LOAD	A project is being loaded from the SD card. You can also view the SD Indicator (see page 240) for more status information. Allow the load to complete before doing the following: <ul style="list-style-type: none"> Removing the SD card Disconnecting the power <p>IMPORTANT: Do not remove the SD card while the controller is loading from the SD card. Allow the load to complete without interruption. If you interrupt the load, data corruption or loss can occur.</p>
UPDT	A firmware update is being conducted from the SD card upon powerup. You can also view the SD Indicator (see page 240) for more status information. If you do not want the firmware to update upon powerup, change the Load Image property of the controller.
Rev XX.xxx	The major and minor revision of the firmware of the controller.
1756-L8XX	The controller catalog number and series.
Link Down	Message appears when the EtherNet/IP port does not have a connection. Message scrolls continuously during operation.
Link Disabled	Message appears when you have disabled the EtherNet/IP port. Message scrolls continuously during operation.
DHCP-00:00:XX:XX:XX:XX	Message appears when the controller is set for DHCP, but not configured on a network. The message shows the MAC address of the controller. Message scrolls continuously during operation if no IP address is set.
Ethernet Port Rate/Duplex State	The current port rate and duplex state when the EtherNet/IP port has a connection. Message scrolls continuously during operation.
IP Address	The IP address of the controller. Appears on powerup, then scrolls continuously during operation. If the IP address is not yet set, then the MAC address appears.
Duplicate IP - 00:00:XX:XX:XX:XX	Message appears when the controller detects a device on the network that has the same IP Address as the controller Ethernet port. The message shows the MAC address of the device with the duplicate IP Address. Message scrolls continuously during operation.
No Project	No project is loaded on the controller. To load a project, do one of the following: <ul style="list-style-type: none"> Use the Studio 5000 Logix Designer® application to download a project to the controller Use an SD card to load a project to the controller
Project Name	The name of the project that is loaded on the controller.

Table 42 - Controller General Status Messages (continued)

Message	Interpretation
BUSY	The I/O modules that are associated with the controller are not yet fully powered. Allow time for powerup and I/O module self-testing.
Corrupt Certificate Received	The security certificate that is associated with the firmware is corrupted. Go to http://www.rockwellautomation.com/support/ and download the firmware revision you are trying to update to. Replace the firmware revision that you have previously installed with that posted on the Technical Support website.
Corrupt Image Received	The firmware file is corrupted. Go to http://www.rockwellautomation.com/support/ and download the firmware revision you are trying to update to. Replace the firmware revision that you have previously installed with that posted on the Technical Support website.
Backup Energy HW Failure - Save Project	A failure with the embedded storage circuit has occurred, and the controller is incapable of saving the program in the event of a powerdown. If you see this message, then save your program to the SD card before you remove power, and then replace the controller.
Backup Energy Low - Save Project	The embedded storage circuit does not have sufficient energy to enable the controller to save the program in the event of a powerdown. If you see this message, then save your program to the SD card before you remove power, and then replace the controller.
Flash in Progress	A firmware update that is initiated via ControlFLASH™ or AutoFlash software is in progress. Allow the firmware update to complete without interruption.
Firmware Installation Required	The controller is using boot firmware (revision 1.xxx) and requires a firmware update.
SD Card Locked	An SD card that is locked is installed.
Download in Progress	An active download is occurring
Aborting Download	An active download is being canceled. This may be due to a user initiated cancel, a download failure, or connection loss. After completion, the No Project status message displays.

GuardLogix Status Messages

GuardLogix



The GuardLogix® 5580 controller display can show these scrolling messages.

Table 43 - Safety Controller Status Messages

Message	Interpretation
No Safety Signature	Safety Task is in Run mode without a safety signature. Generate a safety signature.
Safety Unlocked	The controller is in Run mode with a safety signature, but is not safety-locked. Safety lock the controller.
Safety Partner Missing	The safety partner is missing or unavailable. Make sure the safety partner is seated properly in the slot that is immediately to the right of the safety controller. The controller displays this message only in a SIL 3/PLe configuration.
Hardware Incompatible	The safety partner and primary controller hardware is incompatible. You must use the 1756-L8SP safety partner with GuardLogix 5580 Controllers. The controller displays this message only in a SIL 3/PLe configuration.
Firmware Incompatible	The safety partner and primary controller firmware revision levels are incompatible. Update the modules to the correct firmware revision. The controller displays this message only in a SIL 3/PLe configuration.
Safety Task Inoperable	The safety logic is invalid. For example, a mismatch occurred between the primary controller and the safety partner, a watchdog timeout occurred, or memory is corrupt.

Safety Partner Status Messages

GuardLogix



The safety partner display can show these scrolling messages.

Table 44 - Safety Partner Status Messages

Message	Interpretation
L8SP	Standard display text. If there is a major non-recoverable fault, then the fault code scrolls across the display.
Flash in Progress	A firmware update that is initiated via ControlFLASH or AutoFlash software is in progress. Allow the firmware update to complete without interruption.

Fault Messages

ControlLogix



GuardLogix



If the controller displays a fault, these scrolling messages can appear on the status display.

Table 45 - Fault Messages

Message	Interpretation
Major Fault TXX:CXX message	A major fault of Type <i>XX</i> and Code <i>XX</i> has been detected. For example, if the status display indicates Major Fault T04:C42 Invalid JMP Target, a JMP instruction is programmed to jump to an invalid LBL instruction. For details about major recoverable faults, see the Logix5000 Major, Minor, and I/O Fault Codes Programming Manual, publication 1756-PM014 .
I/O Fault Local:X #XXXX message	An I/O fault has occurred on a module in the local chassis. The slot number and fault code are indicated along with a brief description. For example, I/O Fault Local:3 #0107 Connection Not Found indicates that a connection to the local I/O module in slot three is not open. Take corrective action specific to the type of fault indicated. For details about each I/O fault code, see the Logix5000 Major, Minor, and I/O Fault Codes Programming Manual, publication 1756-PM014 .
I/O Fault ModuleName #XXXX message	An I/O fault has occurred on a module in a remote chassis. The name of the faulted module is indicated with the fault code and brief description of the fault. For example, I/O Fault My_Module #0107 Connection Not Found indicates that a connection to the module named My_Module is not open. Take corrective action specific to the type of fault indicated. For details about each I/O fault code, see the Logix5000 Major, Minor, and I/O Fault Codes Programming Manual, publication 1756-PM014 .
I/O Fault ModuleParent:X #XXXX message	An I/O fault has occurred on a module in a remote chassis. The parent name of the module is indicated because no module name is configured in the I/O Configuration tree of Logix Designer application. In addition, the fault code is indicated with a brief description of the fault. For example, I/O Fault My_CNet:3 #0107 Connection Not Found indicates that a connection to a module in slot 3 of the chassis with the communication module named My_CNet is not open. Take corrective action specific to the type of fault indicated. For details about each I/O fault code, see the Logix5000 Major, Minor, and I/O Fault Codes Programming Manual, publication 1756-PM014 .
X I/O Faults	I/O faults are present and <i>X</i> = the number of I/O faults present. If there are multiple I/O faults, the controller indicates the first fault reported. As each I/O fault is resolved, the number of indicated faults decreases and the I/O Fault message indicates the next reported fault. Take corrective action specific to the type of fault indicated. For details about each I/O fault code, see the Logix5000 Major, Minor, and I/O Fault Codes Programming Manual, publication 1756-PM014 .

Major Fault Messages

ControlLogix



GuardLogix



The Major Fault *TXX:CXX message* on the controller scrolling display indicates major faults. [Table 46](#) lists fault types, codes, and the associated messages as they are shown on the status display.

For detailed descriptions and suggested recovery methods for major faults, see the Logix5000 Major, Minor, and I/O Fault Codes Programming Manual, publication [1756-PM014](#).

Table 46 - Major Fault Status Messages

Type	Code	Message
1	1	Run Mode Powerup
1	60	Nonrecoverable
1	61	Nonrecoverable – Diagnostics Saved on SD Card
1	62	Nonrecoverable – Diagnostics and Program Saved on SD card
3	16	I/O Connection Failure
3	20	Chassis Failure
3	21	
3	23	Connection Failure
4	16	Unknown Instruction
4	20	Invalid Array Subscript
4	21	Control Structure LEN or POS < 0
4	31	Invalid JSR Parameter
4	34	Timer Failure
4	42	Invalid JMP Target
4	82	SFC Jump Back Failure
4	83	Value Out of Range
4	84	Stack Overflow
4	89	Invalid Target Step
4	90	Invalid Instruction
4	91	Invalid Context
4	92	Invalid Action
4	990	User-defined
4	991	
4	992	
4	993	
4	994	
4	995	
4	996	
4	997	
4	998	
4	999	
6	1	Task Watchdog Expired
7	40	Save Failure
7	41	Bad Restore Type
7	42	Bad Restore Revision

Table 46 - Major Fault Status Messages (continued)

Type	Code	Message
7	43	Bad Restore Checksum
7	44	Failed to Restore Processor Memory
8	1	Keyswitch Change Ignored
11	1	Positive Overtravel Limit Exceeded
11	2	Negative Overtravel Limit Exceeded
11	3	Position Error Tolerance Exceeded
11	4	Encoder Channel Connection Fault
11	5	Encoder Noise Event Detected
11	7	Synchronous Connection Fault
11	8	Servo Module Fault
11	9	Asynchronous Connection Fault
11	10	Motor Fault
11	11	Motor Thermal Fault
11	12	Drive Thermal Fault
11	14	Inactive Drive Enable Input Detected
11	15	Drive Phase Loss Detected
11	16	DriveGuard® Fault
11	32	Motion Task Overlap Fault
11	33	CST Reference Loss Detected
14	1	Safety Task Watchdog Expired
14	2	Error In Routine of Safety Task
14	3	Safety Partner Missing
14	4	Safety Partner Unavailable
14	5	Safety Partner Hardware Incompatible
14	6	Safety Partner Firmware Incompatible
14	7	Safety Task Inoperable
14	9	Safety Partner Nonrecoverable Controller Fault
18	1	CIP Motion Initialization Fault
18	2	CIP Motion Initialization Fault Mfg
18	3	CIP Motion Axis Fault
18	4	CIP Motion Axis Fault Mfg
18	5	CIP Motion Fault
18	6	CIP Module Fault
18	7	Motion Group Fault
18	8	CIP Motion Configuration Fault
18	9	CIP Motion APR Fault
18	10	CIP Motion APR Fault Mfg
18	128	CIP Motion Guard Fault

I/O Fault Codes

ControlLogix



GuardLogix



The controller indicates I/O faults on the status display in one of these formats:

- I/O Fault Local:*X* #XXXX *message*
- I/O Fault *ModuleName* #XXXX *message*
- I/O Fault *ModuleParent:X* #XXXX *message*

The first part of the format is used to indicate the location of the module with a fault. How the location is indicated depends on your I/O configuration and the properties of the module that are specified in Logix Designer application.

The latter part of the format, #XXXX message, can be used to diagnose the type of I/O fault and potential corrective actions. For details about each I/O fault code, see the Logix5000 Major, Minor, and I/O Fault Codes Programming Manual, publication [1756-PM014](#).

Table 47 - I/O Fault Messages

Code	Message
#0001	Connection Failure
#0002	Insufficient Resource
#0003	Invalid Value
#0004	IOI Syntax
#0005	Destination Unknown
#0006	Partial Data Transferred
#0007	Connection Lost
#0008	Service Unsupported
#0009	Invalid Attribute Value
#000A	Attribute List Error
#000B	State Already Exists
#000C	Object Mode Conflict
#000D	Object Already Exists
#000E	Attribute Not Settable
#000F	Permission Denied
#0010	Device State Conflict
#0011	Reply Too Large
#0012	Fragment Primitive
#0013	Insufficient Command Data
#0014	Attribute Not Supported
#0015	Data Too Large
#0100	Connection In Use
#0103	Transport Not Supported
#0106	Ownership Conflict
#0107	Connection Not Found
#0108	Invalid Connection Type
#0109	Invalid Connection Size
#0110	Module Not Configured

Table 47 - I/O Fault Messages (continued)

Code	Message
#0111	RPI Out of Range
#0113	Out of Connections
#0114	Wrong Module
#0115	Wrong Device Type
#0116	Wrong Revision
#0117	Invalid Connection Point
#0118	Invalid Configuration Format
#0119	Module Not Owned
#011A	Out of Connection Resources
#0203	Connection Timeout
#0204	Unconnected Message Timeout
#0205	Invalid Parameter
#0206	Message Too Large
#0301	No Buffer Memory
#0302	Bandwidth Not Available
#0303	No Bridge Available
#0304	ControlNet Schedule Error
#0305	Signature Mismatch
#0306	CCM Not Available
#0311	Invalid Port
#0312	Invalid Link Address
#0315	Invalid Segment Type
#0317	Connection Not Scheduled
#0318	Invalid Link Address
#0319	No Secondary Resources Available
#031E	No Available Resources
#031F	No Available Resources
#0800	Network Link Offline
#0801	Incompatible Multicast RPI
#0814	Data Type Mismatch
#FD01	Bad Backplane EEPROM
#FD02	No Error Code
#FD03	Missing Required Connection
#FD04	No CST Master
#FD05	Axis or GRP Not Assigned
#FD0A	Axis Attribute Reject
#FD1F	Safety I/O
#FD20	No Safety Task
#FE01	Invalid Connection Type
#FE02	Invalid Update Rate

Table 47 - I/O Fault Messages (continued)

Code	Message
#FE03	Invalid Input Connection
#FE04	Invalid Input Data Pointer
#FE05	Invalid Input Data Size
#FE06	Invalid Input Force Pointer
#FE07	Invalid Output Connection
#FE08	Invalid Output Data Pointer
#FE09	Invalid Output Data Size
#FE0A	Invalid Output Force Pointer
#FE0B	Invalid Symbol String
#FE0C	Invalid Scheduled Personal Computer Instance
#FE0D	Invalid Symbol Instance
#FE0E	Module Firmware Updating
#FE0F	Invalid Firmware File Revision
#FE10	Firmware File Not Found
#FE11	Firmware File Invalid
#FE12	Automatic Firmware Update Failed
#FE13	Update Failed - Active Connection
#FE14	Searching Firmware File
#FE22	Invalid Connection Type
#FE23	Invalid Unicast Allowed
#FF00	No Connection Instance
#FF01	Path Too Long
#FF04	Invalid State
#FF08	Invalid Path
#FF0B	Invalid Config
#FF0E	No Connection Allowed

Controller Status Indicators

The status indicators are below the status display on the controller. They indicate the state of the controller as described in these tables.

ControlLogix



GuardLogix



IMPORTANT Safety Consideration

Status indicators are not reliable indicators for safety functions. Use them only for general diagnostics during commissioning or troubleshooting. Do not attempt to use status indicators to determine operational status.

RUN Indicator

The RUN indicator shows the current mode of the controller.

To change the controller mode, you can use the mode switch on the front of the controller or the Controller Status menu in the Logix Designer application.

Table 48 - RUN Indicator

State	Description
Off	The controller is in Program or Test mode.
Steady green	The controller is in Run mode.

FORCE Indicator

The Force indicator shows if I/O forces are enabled on the controller.

Table 49 - FORCE Indicator

State	Description
Off	No tags contain I/O force values, and I/O force values are not enabled.
Solid amber	I/O forces enabled. If any I/O force values exist they are active. IMPORTANT: Use caution if you change any force values. In this state, the changes take effect immediately.
Flashing amber	I/O forces exist in the application, but are not active because I/O forces are not enabled. IMPORTANT: Use caution if you enable I/O forces. All existing I/O force values take effect immediately.

SD Indicator

The SD indicator shows if the SD card is in use.

Table 50 - SD Indicator

State	Description
Off	No activity is occurring with the SD card.
Flashing green	The controller is reading from or writing to the SD card.
Solid green	IMPORTANT: Do not remove the SD card while the controller is reading or writing. Allow the read/write to complete without interruption. If you interrupt the read/write, data corruption or loss can occur.
Flashing red	The SD card does not have a valid file system.
Solid red	The controller does not recognize the SD card.

OK Indicator

The OK indicator shows the state of the controller.

Table 51 - ControlLogix® and GuardLogix Controllers OK Indicator

State	Description
Off	No power is applied to the controller.
Flashing red	One of the following is true: <ul style="list-style-type: none"> It is a new controller, out of the box, and it requires a firmware update. If a firmware update is required, the status display indicates Firmware Installation Required. To update firmware, see Update Controller Firmware on page 63. It is a previously used or in-use controller and a major fault has occurred. All user tasks, standard and safety, are stopped. For details about major recoverable and nonrecoverable faults, see the Logix5000 Major, Minor, and I/O Fault Codes Programming Manual, publication 1756-PM014.
Solid red	One of the following is true: <ul style="list-style-type: none"> The controller is completing power-up diagnostics. The charge of the capacitor in the ESM is being discharged upon powerdown. The controller is powered, but is inoperable. The controller is loading a project to nonvolatile memory. The controller is experiencing a Hardware Preservation Fault due to a high internal module temperature. In this condition, only the status indicator receives power. Once the controller cools down to an acceptable temperature, then full power is applied.
Solid green	The controller is operating normally.

Safety Partner OK Indicator

The safety partner has an OK status indicator.

GuardLogix



Table 52 - 1756-L8SP Safety Partner OK Indicator

Sate	Description
Off	No power is applied.
Green	The safety partner is operating with no faults.
Red	One of the following is true: <ul style="list-style-type: none"> The safety partner is completing power-up diagnostics. The charge of the capacitor in the ESM is being discharged upon powerdown. The safety partner is powered, but is inoperable. The safety partner is loading a project to nonvolatile memory. The safety partner is experiencing a Hardware Preservation Fault due to a high internal module temperature. In this condition, only the status indicator receives power. Once the safety partner cools down to an acceptable temperature, then full power is applied.
Flashing Red	Controller is configured for SIL 2 operation but a safety partner is installed.

EtherNet/IP Indicators

The EtherNet/IP indicators show the state of the EtherNet/IP port and communications activity.

ControlLogix



GuardLogix



Indicator	State	Description
NET	Off	<ul style="list-style-type: none"> The controller is not configured, or does not have an IP address. The port is administratively disabled.
	Flashing green	The controller has an IP address, but no active connections are established.
	Steady green	The controller has an IP address and at least one established active connection.
	Steady red	Duplicate IP Address or invalid configuration.
LINK	Off	No activity. One of these conditions exists: <ul style="list-style-type: none"> No link exists on the port. Verify that the RJ45 cables are properly seated in the adapter and connected devices. The port is administratively disabled.
	Flashing green	Activity exists on the port.

Thermal Monitoring and Thermal Fault Behavior

The controllers can monitor internal module temperatures, and take actions as the temperature increases, as in this graphic.

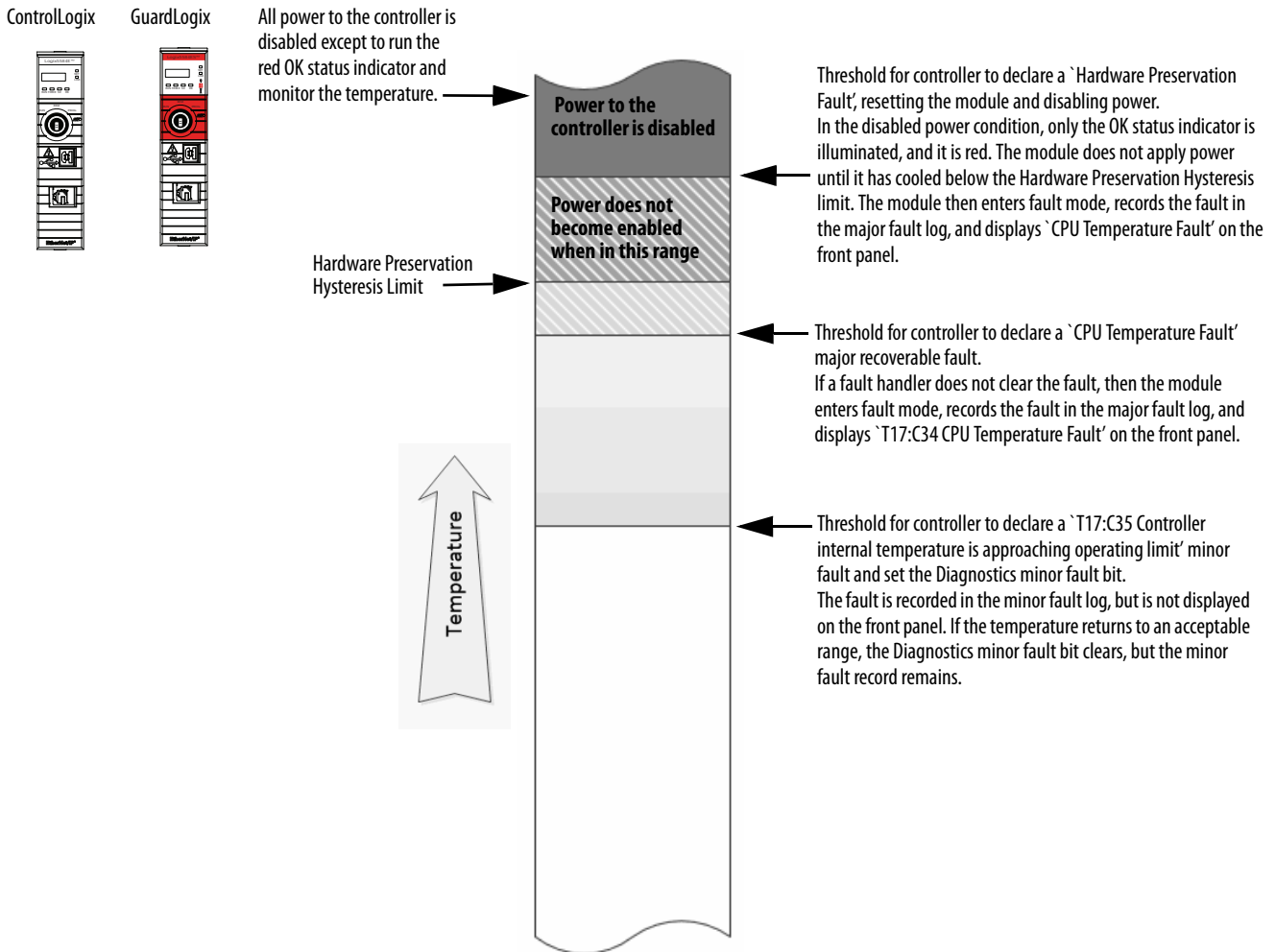

IMPORTANT If you follow the recommended limits for ambient (inlet) temperature and apply the required clearances around the chassis, the controller should not reach the initial warning (minor fault) temperature. See the 1756 ControlLogix Controllers Technical Data, publication [1756-TD001](#).

IMPORTANT The presence of any temperature warning indicates that measures need be taken to reduce the ambient temperature of the module. Instructions for using relay ladder logic to check for a minor fault can be found in the Logix5000 Controllers Major, Minor, and I/O Faults Programming Manual, publication [1756-PM014](#). A GSV instruction can be used to read the MinorFaultBits attribute of the FaultLog class name. If the Diagnostics minor fault bit (Bit 17) is set, then a temperature minor fault can be present. Check the Minor Faults tab of the Controller Properties dialog box in the Logix Designer application to see if the minor fault is a temperature warning.

Security Options

Topic	Page
Disable the Ethernet Port	243
Disable the 4-character Status Display	246
Disable the Controller Web Pages	250

For enhanced security, you can disable functionality on your controller.

Disable the Ethernet Port

You can disable the controller Ethernet port with the Studio 5000 Logix Designer® application, version 28.00.00 or later.

ControlLogix



GuardLogix



IMPORTANT Remember the following:

- Once a port is disabled, you lose any connection that is established through the controller Ethernet port.
 - You cannot disable Ethernet ports if the controller mode switch is in Run mode or if the FactoryTalk® Security settings deny this editing option.
-

Ethernet ports return to the default setting after one of these actions occur on the controller:

- Stage 1 reset
- Stage 2 reset
- New project is downloaded - In this case, the settings in the new project take effect.
- Program is cleared from the controller - These examples clear the program from a controller:
 - Major non-recoverable fault occurs.
 - Firmware update occurs.

You must reconfigure the settings to disable an Ethernet port after the port returns to its default settings.

There are two ways to disable the Ethernet port:

- [Disable the Ethernet Port on the Port Configuration Tab on page 244](#)
- [Disable the Ethernet Port With a MSG Instruction on page 245](#)

Disable the Ethernet Port on the Port Configuration Tab

You can disable the embedded Ethernet port on the controller. This method retains the setting in the project, so every time you download the project to the controller, the Ethernet port is disabled.

1. In the I/O Configuration, double-click on the controller to display the Controller Properties.

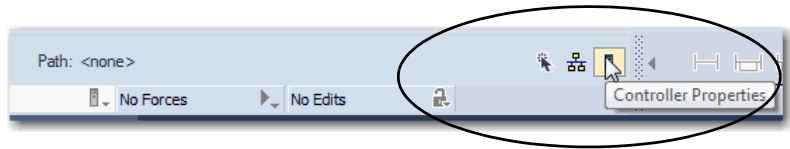

2. On the Controller Properties dialog box, click the Port Configuration tab.
3. On the Port Configuration tab, clear the Enable checkbox.

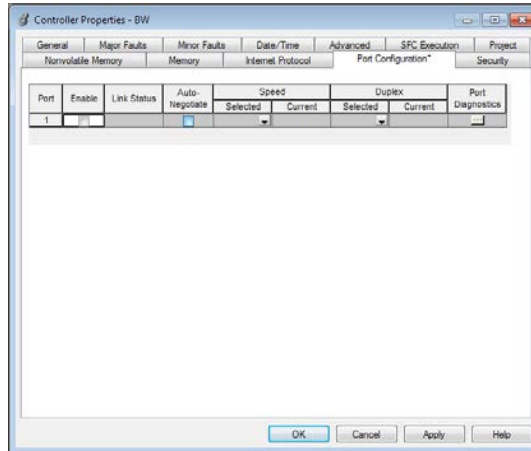

4. On the Port Configuration tab, click Apply.
 - If you are online when you make this change, then an Alert dialog box appears. On the dialog box, click Yes. The change takes effect immediately.

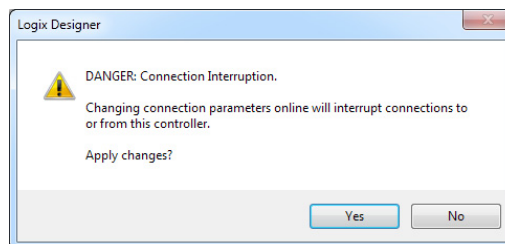

- If you are offline, then the change takes effect when you download the program to the controller.
5. On the Port Configuration tab, click OK.

Disable the Ethernet Port With a MSG Instruction

You use a CIP Generic MSG with a Path of THIS to execute this option. You cannot use this MSG instruction to disable the Ethernet port on a different controller.

1. Add a MSG instruction to your program.

This message only needs to execute once, it does not need to execute with every program scan.

IMPORTANT You cannot add a MSG instruction to your program if the controller mode switch is in Run mode, or if the FactoryTalk Security settings deny this editing option.

2. Configure the Configuration tab on the Message Configuration dialog box as follows:

IMPORTANT These values are stored to NVS memory in such a way that the MSG instruction is not required to execute each time the controller powers up.

- Message Type - CIP Generic
- Service Type - Set Attribute Single
- Instance - 1
- Class - f6
- Attribute - 9
- Source Element - Controller tag of SINT data type

In this example, the controller tag is named Port_Configuration.

- Source Length - 1

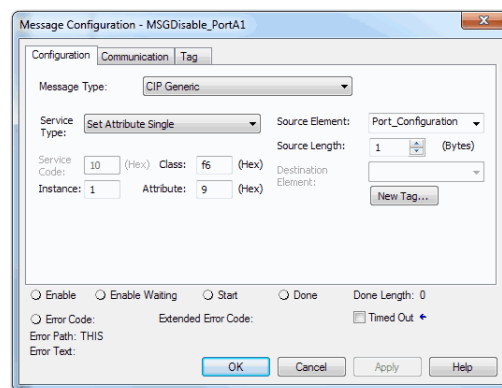

3. Configure the Communication tab to use a Path of THIS.

IMPORTANT Messages to THIS must be unconnected messages.

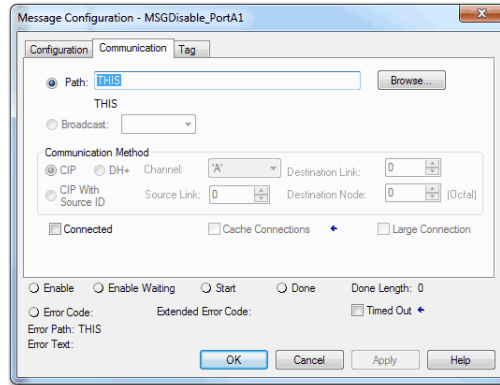

4. Before you enable the MSG instruction, make sure that the Source Element tag value is 2.

IMPORTANT You can re-enable an Ethernet port after it is disabled. To re-enable the port, complete the steps that are described in this section. Before you enable the MSG instructions, however, make sure that the Source Element tag value is 1.

Disable the 4-character Status Display

ControlLogix



GuardLogix



With the Studio 5000 Logix Designer application, version 29.00.00 or later, you can disable certain categories of messages on the 4-character status display:

- [Disable All Categories of Messages on page 247](#)
- [Disable Individual Categories of Messages on page 249](#)

You use a CIP Generic MSG to execute each option.

IMPORTANT These system messages will always be displayed and cannot be disabled:

- Powerup messages (TEST, PASS, CHRG, etc.)
- Catalog number message
- Firmware revision message
- Major / Critical failure messages

The 4-character status display returns to the default setting after one of these actions occur on the controller:

- Stage 1 reset
- Stage 2 reset
- New project is downloaded - In this case, the settings in the new project take effect.
- Program is cleared from the controller - these examples can clear the program from a controller:
 - Major non-recoverable fault occurs.
 - Firmware update occurs.

You must reconfigure the settings to disable the 4-character status display after it returns to its default settings.

Disable All Categories of Messages

When you disable all categories of messages, this information no longer shows:

- Project name
- Link status
- Port status
- IP address

Complete these steps.

1. Add a MSG instruction to your program.
2. Configure the Configuration tab on the Message Configuration dialog box:
 - Message Type - CIP Generic
 - Service Type - Set Attribute Single
 - Instance - 1
 - Class - 3a5
 - Attribute - 1
 - Source Element - Controller tag of SINT data type
In this example, the controller tag is named LCD_SINT.
 - Source Length - 1

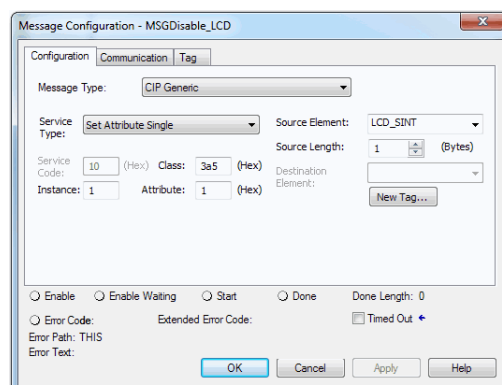

3. Configure the Communication tab to use a Path of THIS.

IMPORTANT Messages to THIS must be unconnected messages.

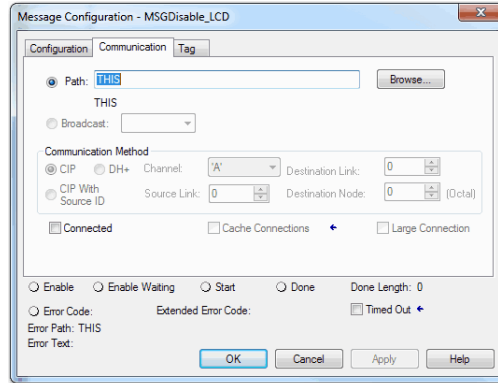

4. Before you enable the MSG instruction, make sure that the Source Element tag value is 1.

IMPORTANT You can re-enable the 4-character display after it is disabled.

To re-enable the 4-character display, complete the steps that are described in this section. Before you enable the MSG instructions, however, make sure that the Source Element tag value is 0.

Disable Individual Categories of Messages

You can disable a subset of the information that scrolls across the controller 4-character display. You can disable these subsets:

- Project name and link status
- Port status and IP address

Complete these steps.

1. Add a MSG instruction to your program.

This message only needs to execute once, it does not need to execute with every program scan.

IMPORTANT You cannot add a MSG instruction to your program if the controller mode switch is in Run mode, or if the FactoryTalk Security settings deny this editing option.

2. Configure the Configuration tab on the Message Configuration dialog box as follows:
 - Message Type - CIP Generic
 - Service Type - Set Attribute Single
 - Instance - 1
 - Class - 3a5
 - Attribute - 2
 - Source Element - Controller tag of DINT data type
In this example, the controller tag is named Line_MASK.
 - Source Length - 4

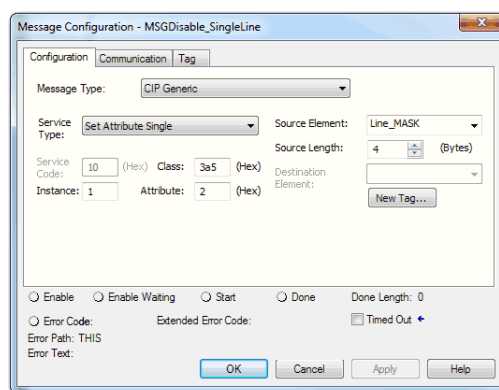

3. Configure the Communication tab to use a Path of THIS.

IMPORTANT Messages to THIS must be unconnected messages.

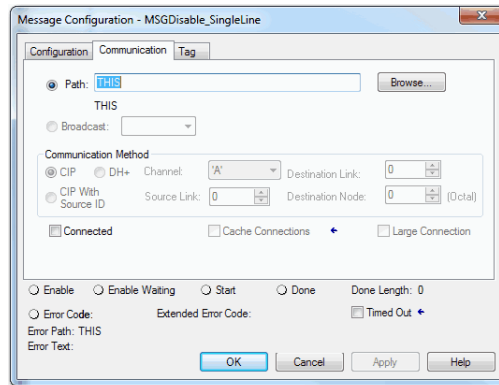

4. Before you enable the MSG instruction, make sure that the Source Element uses one of the following tag values, based on what information that you want to disable:
- Project name and link status - Bit 0 of the Source Element = 1
 - Port status and IP address - Bit 1 of the Source Element = 1

IMPORTANT You can re-enable the subsets of information on the 4-character display after they are disabled.

To re-enable the subsets, complete the steps that are described in this section. Before you enable the MSG instructions, however, make sure the appropriate bit in the Source Element tag value is 0.

Disable the Controller Web Pages

ControlLogix



GuardLogix



You can disable the controller web pages with the Studio 5000 Logix Designer application, version 28.00.00 or later.

You use a CIP Generic MSG to execute this option.

Controller web pages return to the default setting after the following occur on the controller:

- Stage 1 reset
- Stage 2 reset
- New project is downloaded - In this case, the settings in the new project take effect.
- Program is cleared from the controller - The following are examples of what clears the program from a controller:
 - Major non-recoverable fault occurs.
 - Firmware update occurs.

You must reconfigure the settings to disable the controller web page after it returns to its default settings.

1. Add a MSG instruction to your program.

IMPORTANT You cannot add a MSG instruction to your program if the controller mode switch is in RUN mode, or if the FactoryTalk Security settings deny this editing option.

2. Configure the Configuration tab on the Message Configuration dialog box as follows:

- Message Type - CIP Generic
- Service Type - Custom
- Service Code - 4c
- Instance - 1
- Class - f5
- Attribute - 0
- Source Element - Controller tag of SINT[5] data type.

In this example, the controller tag is named WP_Disable and must match the following graphic.

IMPORTANT The Source Element tag in your Logix Designer application project must match the values shown in the graphic.

If you use values that are different than the ones shown, the controller web pages are not disabled.

▲ WP_Disable	{...}	{...}	Hex	SINT[5]
▶ WP_Disable[0]	16#00		Hex	SINT
▶ WP_Disable[1]	16#50		Hex	SINT
▶ WP_Disable[2]	16#00		Hex	SINT
▶ WP_Disable[3]	16#06		Hex	SINT
▶ WP_Disable[4]	16#00		Hex	SINT

- Source Length - 5

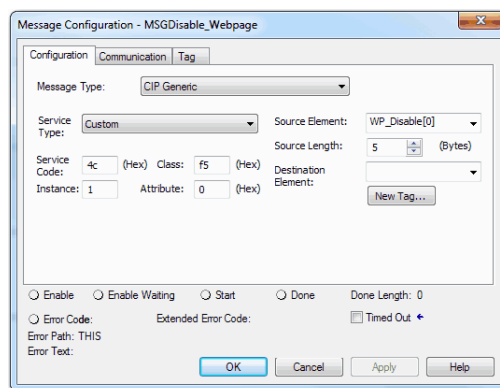

3. Configure the Communication tab to use a Path of THIS.

IMPORTANT Messages to THIS must be unconnected messages.

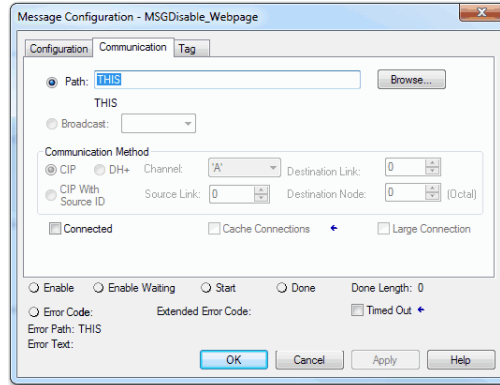

4. Before you enable the MSG instruction, consider the following:

- To disable the controller web page, the last element in the SINT array for the Source Element must be 0.

WP_Disable	{...}	{...}	Hex	SINT[5]
WP_Disable[0]	16#00		Hex	SINT
WP_Disable[1]	16#50		Hex	SINT
WP_Disable[2]	16#00		Hex	SINT
WP_Disable[3]	16#06		Hex	SINT
WP_Disable[4]	16#00		Hex	SINT

- To enable the controller web page, the last element in the SINT array for the Source Element must be 1.

WP_Disable	{...}	{...}	Hex	SINT[5]
WP_Disable[0]	16#00		Hex	SINT
WP_Disable[1]	16#50		Hex	SINT
WP_Disable[2]	16#00		Hex	SINT
WP_Disable[3]	16#06		Hex	SINT
WP_Disable[4]	16#01		Hex	SINT

Change Controller Type

Topic	Page
Change from a Standard to a Safety Controller	253
Change from a Safety to a Standard Controller	254
Change Safety Controller Types	254

Because safety controllers have special requirements and do not support certain standard features, you must understand the behavior of the system when changing the controller type from standard to safety or from safety to standard in your controller project.

Changing controller type affects the following:

- Supported features
- Physical configuration of the project (safety partner and safety I/O)
- Controller properties
- Project components such as tasks, programs, routines, and tags
- Safety Add-On Instructions

Change from a Standard to a Safety Controller

Upon confirmation of a change from a standard controller to a safety controller project, safety components are created to meet the minimum requirements for a safety controller:

ControlLogix



GuardLogix



- The safety task is created only if the maximum number of downloadable tasks has not been reached. The safety task is initialized with its default values.

TIP If your project already contains 32 tasks, and you request a change from a standard to a safety controller, the project does not convert and stays with the standard controller.

- Safety components are created (safety task, safety program, and so forth).
- The safety project defaults to safety level SIL 2/PLd.
- A time-based safety network number (SNN) is generated for the local chassis.
- A time-based safety network number (SNN) is also generated for the embedded EtherNet/IP port.
- Standard controller features that are not supported by the safety controller, such as redundancy, are removed from the Controller Properties dialog box (if they existed).

Change from a Safety to a Standard Controller

ControlLogix



GuardLogix



Upon confirmation of a change from a safety controller project to a standard controller, some components are changed and others are deleted, as described below:

- The safety partner is deleted from the I/O chassis if it existed.
- Safety I/O devices and their tags are deleted.
- The safety task, programs, and routines are changed to a standard task, programs, and routines.
- All safety tags, except safety consume tags, are changed to standard tags. Safety consume tags are deleted.
- Safety tag mappings are deleted.
- The safety network numbers (SNN) are deleted.
- Safety-lock and -unlock passwords are deleted.
- If the standard controller supports features that were not available to the safety controller, those new features are visible in the Controller Properties dialog box.

TIP Peer safety controllers are not deleted, even if they have no connections remaining.

- Instructions can still reference modules that have been deleted and can produce verification errors.
- Consumed tags are deleted when the producing module is deleted.
- As a result of the above changes to the system, safety-specific instructions and safety I/O tags do not verify.

If the safety controller project contains safety Add-On Instructions, you must remove them from the project or change their class to standard before changing the controller type.

Change Safety Controller Types

When you change from one safety controller type to another, class of tags, routines, and programs remain unaltered. Any I/O devices that are no longer compatible with the target controller are deleted.

The representation of the safety partner is updated to appear appropriately for the target controller.

Numerics

10/100/1000 55

1756-CN2
uses 40

1756-CN2R
uses 40

1756-CN2RXT
uses 40

1756-CNB
uses 40

1756-CNBR
uses 40

1756-DHRIO 43
communication via 44
uses
remote I/O 45

1756-DHRIOXT
uses 43, 45

1756-DNB
uses 42

1756-EN2F
uses 36

1756-EN2T
uses 36

1756-EN2TR
uses 36

1756-EN2TRXT
uses 36

1756-EN2TSC
uses 36

1756-EN2TXT
uses 36

1756-EN3TR
uses 36

1756-ENBT
uses 36

1756-EWEB
uses 36

1756-IF8H
uses 48

1756-N2 121

1756-N2XT 121

1756-RIO
uses 45

1784-SD1
load from 108

1784-SD2
load from 108

1788-CN2DN
uses 42

1788-CN2FFR
uses 47

1788-EN2DNR
uses 42

1788-EN2FFR
uses 47

A

add
local I/O 121
remote I/O 127, 129

Add-On Instructions 23, 254
in project 165

allow communication 114

application
elements 155
networks and 31

AutoFlash
update 68

axes
consumed 210
virtual 210

axis
obtain information 213

B

behavior
thermal fault 242

block communication 114

BOOTP/DHCP server
setting IP network address 56 - 58

C

cache
message options 118
messages
about 117

changing controllers 254

chassis
ControlLogix
list 121

CIP Safety 29, 154

CIP Safety I/O
adding 137
node address 137

clear
faults 203

communication
allow 114
block 114
Data Highway Plus 43, 44
Foundation Fieldbus 47
HART 48
network options 21, 22
path
set 81
universal remote I/O 45

configuration owner 144
resetting 145, 147

configuration signature
components 143
copy 143

configure
motion 210

- configure always** 154
 - conformal coated controllers** 13
 - connection**
 - DeviceNet
 - network 42
 - EtherNet/IP 112
 - message, required 117
 - scheduled
 - ControlNet 116
 - status 200
 - unscheduled
 - ControlNet 116
 - connection reaction time limit** 186
 - CONNECTION_STATUS** 179, 200
 - ConnectionFaulted bit** 200
 - consume**
 - data 115
 - consume tag data** 185
 - consumed tag** 179
 - continuous task** 158
 - control data** 114
 - ControlFLASH software** 64, 84
 - controller**
 - available modes 93
 - behavior 114
 - catalog numbers
 - conformal coated controllers 13
 - safety controllers 13
 - standard controllers 13
 - change type 253 - ??
 - communication path
 - set 81
 - ControlLogix 5580
 - communication options 21, 22
 - design system with 20
 - fault handler 206
 - firmware 63
 - obtain 63
 - go online 81
 - logging
 - safety lock, unlock 191
 - safety signature 194
 - match 83
 - monitor
 - connections 169
 - operation mode
 - change with Logix Designer 95
 - change with mode switch 94
 - program 159
 - routine 162
 - serial number 83
 - serial number mismatch 86, 89
 - status indicators 239
 - tags 163
 - tasks 157
 - upload a project 90
 - ControlLogix**
 - chassis
 - list 121
 - design system 20
 - I/O
 - selection 119
 - remote I/O
 - local 121
 - slot filler 121
 - ControlLogix system**
 - minimum requirements 13
 - ControlLogix-XT**
 - chassis
 - list 121
 - ControlNet**
 - example 39
 - module 39
 - network 38
 - scheduled connection
 - scheduled connection 116
 - unscheduled connection
 - unscheduled connection 116
 - copy**
 - safety task signature 195
- ## D
- Data Highway Plus** 43
 - data types**
 - CONNECTION_STATUS 179
 - data-only connection** 144
 - delete**
 - safety task signature 195
 - design**
 - system 20
 - develop**
 - applications 155
 - motion applications 209
 - DeviceNet**
 - connection use 42
 - module
 - memory 42
 - network 41
 - software for 42
 - DH+** 43
 - DHCP** 56
 - diagnostic coverage** 29
 - diagnostics**
 - with Logix Designer 215
 - port configuration category 219
 - time sync category 221
 - with RSLinx software 224
 - disable the 4-character status display** 246
 - disable the controller web pages** 250
 - disable the Ethernet port** 243
 - disable the Ethernet ports** 98
 - DNS addressing** 56, 61
 - EtherNet/IP network parameters 56
 - domain name** 56
 - double data rate (DDR)** 37
 - download**
 - effect of controller match 83
 - effect of firmware revision match 84
 - effect of safety status 84

duplicate IP address

- detection 60
- resolution 60

E**editing** 195**electronic keying**

- about 120

elements

- control application 155

error

- script file 66

Ethernet 55**Ethernet port**

- diagnostics
 - Logix Designer 219
- disable 244, 245

Ethernet ports

- disable 98

EtherNet/IP

- communication driver 50
- connections 112
- link speeds 33
- network 33
- nodes 112
- software for 37

EtherNet/IP network

- connect to network 55
- integrated motion 21, 22
- network communication rates 33
- number of nodes supported 22
- optimize network performance 33
- parameters for DNS addressing 56

event task 158**external access** 177**F****fault**

- clear 203
- cpu temperature 242
- hardware preservation 242
- nonrecoverable controller 203
- nonrecoverable safety 199, 203
- recoverable 204, 242
- routines 206

fault code

- use GSV to get 170

fault codes

- major safety faults 205
- status display 204

fault handler

- execute at I/O fault 170

fault messages 233

- I/O 236

features 21

- controller
 - communication 21
 - programming 21

filler slot

- slot filler 121

firmware

- controller 63
- obtain 63
- required 63
- security certificate, error 66
- update with AutoFlash, use 68
- update with ControlFlash 64

firmware revision

- match 84
- mismatch 86, 89

firmware upgrade kit 84**FORCE indicator** 239**forcing** 195**Foundation Fieldbus** 47**G****gateway** 55**general status messages** 231**GSV**

- fault code 170
- monitor
 - connection 169

H**handshake** 114**HART. See Highway Addressable Remote Transducer.****Highway Addressable Remote Transducer** 48**host name** 56**I****I/O**

- connection error 170
- ControlLogix
 - remote 126
 - selection 119
- determine data update 135
- fault codes 236
- remote 126

I/O configuration

- add
 - local I/O 121
 - remote I/O 127, 129
 - while online 133

indicator 239

- FORCE 239
- OK 240
- SD 240

instruction

- motion 211

integrated motion

- on the EtherNet/IP network 21, 22

integrated STO mode 18, 19**IP addresses**

- definition 55
- duplicate address detection 60
- duplicate address resolution 60

L

- link speeds**
 - EtherNet/IP 33
- load**
 - from memory card 108
- load a project**
 - on corrupt memory 105
 - on power up 105
 - user initiated 105
- local**
 - I/O
 - add 121
 - remote I/O 121
- lock**
 - See safety-lock.
- Logix Designer**
 - change controller operation mode 95
- Logix Designer application**
 - Add-On Instructions 165
 - program 159
 - routine 162
 - tags 163
 - tasks 157

M

- major faults tab** 204, 205
- major safety faults** 205
- MajorFaultRecord** 207
- match project to controller** 83
- maximum observed network delay**
 - reset 186
- memory**
 - DeviceNet module 42
- memory card** 104
 - load from 108
 - other tasks 110
- message**
 - about 117
 - cache 118
 - determine if 118
 - fault 233
 - status display 231
- messages**
 - safety status 232, 233
- minimum requirements** 13
- minor faults tab** 205
- mode switch**
 - change controller operation mode 94
 - position 93
- Monitor Safety I/O Device Status** 146
- motion**
 - about 210
 - application 209
 - instructions 211
 - program 211
- MVI56-HART**
 - uses 48

N

- network**
 - application and 31
 - controller options 21, 22
 - ControlNet 38
 - Data Highway Plus 44
 - DeviceNet 41
 - DH+. See Data Highway Plus.
 - EtherNet/IP 33
 - Foundation Fieldbus 47
 - HART 48
 - universal remote I/O 45
- network address**
 - DNS addressing 61
- network address translation (NAT)**
 - set the IP address 140
- network communication rates**
 - on an EtherNet/IP network 33
- network delay multiplier** 187
- network parameters**
 - DNS addressing 56
 - domain name 56
 - gateway 55
 - host name 56
 - IP addresses 55
 - subnet mask 55
- network status**
 - indicator 150, 152
- node address** 137
- nodes on an EtherNet/IP network** 112
- nonrecoverable controller fault** 203
- nonrecoverable safety fault** 199, 203
 - re-starting the safety task 203
- nonvolatile memory**
 - tab 102

O

- obtain**
 - axis information 213
 - firmware 63
- OK indicator** 240
- online**
 - add
 - to I/O configuration 133
 - go 81
- online bar** 197
- optimize EtherNet/IP network performance**
 - 33
- out-of-box** 149
 - reset module 145

P

- password**
 - set 73, 193
- path**
 - set
 - communication 81

peer safety controller
 location 180
 sharing data 179
 SNN 180

Performance Level 29

periodic task 158

port diagnostics 219

primary controller
 description 17

priority
 task 159

probability of failure on demand (PFD)
 definition 29

probability of failure per hour (PFH)
 definition 29

produce
 data 115

produce a tag 184

produce/consume
 data 115

produced tag 179

program
 in project 159
 scheduled 161
 unscheduled 161

program fault routine 206

programming 195

programming languages 164

programming restrictions 196

project
 Add-On Instructions 165
 elements 155
 go online 81
 program 159
 routine 162
 tags 163
 tasks 157
 upload 90

protect signature in run mode 74

protecting the safety application 191 - 195
 safety task signature 194
 safety-lock 191
 security 192

R

reaction time 175

receive
 messages 117

recoverable fault 204
 clear 204

remote
 I/O 126

remote I/O 43
 add 127, 129
 ControlLogix
 local 121
 universal 45

replace
 configure always enabled 154
 configure only... enabled 149
 Guard I/O module 148

requested packet interval 179
 consumed tag 186

required
 connections
 messages 117

reset
 module 145
 ownership 145

reset button 96
 safety partner reset 99
 stage 1 reset 97
 stage 2 reset 98

reset module 145, 147

restrictions
 programming 196
 safety tag mapping 188
 software 196
 when safety signature exists 195

RIO. See universal remote I/O

routine
 in project 162

RSLinx software
 controller diagnostics 224

RSLogix 5000 software
 restrictions 196

RSWho
 set
 path 81

RunMode bit 200

S

safe torque-off
 configurations
 integrated 18, 19

safety controller catalog numbers 13

safety network number
 automatic assignment 76
 changing controller SNN 78
 changing I/O SNN 79
 copy 80
 definition 29
 description 26, 75
 managing 75
 manual assignment 76
 modification 78
 paste 80
 set 141

safety partner
 status 199

safety programs 176

safety routine 176
 using standard data 188

- safety status**
 - button 194, 198
 - effect on download 84
 - programming restrictions 196
 - safety task signature 194
 - view 84, 197, 199
 - safety tab** 192, 194, 199
 - configuration signature 143
 - generate safety task signature 194
 - module replacement 148
 - safety-lock 192
 - safety-lock controller 192
 - unlock 192
 - view safety status 84, 199
 - safety tags**
 - controller-scoped 178
 - description 177
 - mapping 188 - 190
 - safety task** 174
 - execution 176
 - priority 175
 - watchdog time 175
 - safety task period** 175, 179
 - safety task signature**
 - copy 195
 - delete 195
 - description 26
 - effect on download 85
 - effect on upload 85
 - generate 194
 - restricted operations 195
 - restrictions 196
 - storing a project 103
 - view 198
 - safety-lock** 191
 - controller 192
 - effect on download 85
 - effect on upload 85
 - icon 191
 - password 192
 - SafetyTaskFaultRecord** 207
 - safety-unlock**
 - controller 192
 - icon 191
 - scan times**
 - reset 196
 - scheduled**
 - program 161
 - script file**
 - error 66
 - SD card** 24
 - other tasks 110
 - SD indicator** 240
 - Secure Digital (SD) card** 24, 104
 - load from 108
 - security certificate**
 - error 66
 - security options** 243
 - disable the 4-character status display 246
 - disable the controller web pages 250
 - disable the Ethernet port 243
 - selection**
 - I/O 119
 - send**
 - messages 117
 - serial number** 83
 - set IP network address**
 - BOOTP/DHCP server 56 - 58
 - software**
 - DeviceNet and 42
 - EtherNet/IP and 37
 - required
 - USB 62
 - restrictions 196
 - specifications** 9, 20, 242
 - standard controller catalog numbers** 13
 - standard data in a safety routine** 188
 - status**
 - fault messages 233
 - indicators 239
 - messages 232, 233
 - display 231
 - monitor
 - connections 169
 - safety partner 199
 - store a project** 103
 - subnet mask** 55
 - system** 21
- T**
- tag**
 - consume 115
 - in project 163
 - produce 115
 - tags**
 - controller-scoped 178
 - data type 178
 - external access 177
 - naming 146
 - produced/consumed safety data 179
 - safety I/O 179
 - scope 178
 - task**
 - continuous 158
 - event 158
 - in project 157
 - periodic 158
 - priority 159
 - temperature**
 - limit 242
 - warning 242
 - terminology** 29
 - timeout multiplier** 187
- U**
- universal remote I/O** 45
 - communicate via 46
 - unlock controller** 192
 - unscheduled**
 - program 161
 - update**
 - determine frequency 135

update firmware

AutoFlash, use 68

upload

effect of controller match 83
effect of safety task signature 85
effect of safety-lock 85
project 90

USB

communication driver 53
connect cable 62
software required 62

V**view**

safety status 84

W

watchdog time 175

Notes:

Rockwell Automation Support

Use the following resources to access support information.

Technical Support Center	Knowledgebase Articles, How-to Videos, FAQs, Chat, User Forums, and Product Notification Updates.	https://rockwellautomation.custhelp.com/
Local Technical Support Phone Numbers	Locate the phone number for your country.	http://www.rockwellautomation.com/global/support/get-support-now.page
Direct Dial Codes	Find the Direct Dial Code for your product. Use the code to route your call directly to a technical support engineer.	http://www.rockwellautomation.com/global/support/direct-dial.page
Literature Library	Installation Instructions, Manuals, Brochures, and Technical Data.	http://www.rockwellautomation.com/global/literature-library/overview.page
Product Compatibility and Download Center (PCDC)	Get help determining how products interact, check features and capabilities, and find associated firmware.	http://www.rockwellautomation.com/global/support/pcdc.page

Documentation Feedback

Your comments will help us serve your documentation needs better. If you have any suggestions on how to improve this document, complete the How Are We Doing? form at http://literature.rockwellautomation.com/idc/groups/literature/documents/du/ra-du002_-en-e.pdf.

Rockwell Automation maintains current product environmental information on its website at <http://www.rockwellautomation.com/rockwellautomation/about-us/sustainability-ethics/product-environmental-compliance.page>.

Allen-Bradley, ArmorBlock, Armor GuardLogix, ArmorPOINT, Block I/O, Compact 5000, CompactLogix, ControlBus, ControlFLASH, ControlLogix, ControlLogix-XT, Data Highway Plus, DH+, DriveGuard, DriveLogix, FactoryTalk, FLEX, Flex I/O, Guard I/O, GuardLogix, Integrated Architecture, Kinetix, Logix 5000, On-Machine, PanelView, PLC-2, PLC-5, POINT I/O, POINT Guard I/O, PowerFlex, QuickView, Rockwell Automation, Rockwell Software, RSFieldbus, RSLinx, RSNetWorx, RSView, SLC, SLC 500, Stratix, Studio 5000, Studio 5000 Logix Designer, and SynchLink are trademarks of Rockwell Automation.

Trademarks not belonging to Rockwell Automation are property of their respective companies.

Rockwell Otomasyon Ticaret A.Ş., Kar Plaza İş Merkezi E Blok Kat:6 34752 İçerenköy, İstanbul, Tel: +90 (216) 5698400

www.rockwellautomation.com

Power, Control and Information Solutions Headquarters

Americas: Rockwell Automation, 1201 South Second Street, Milwaukee, WI 53204-2496 USA, Tel: (1) 414.382.2000, Fax: (1) 414.382.4444

Europe/Middle East/Africa: Rockwell Automation NV, Pegasus Park, De Kleetlaan 12a, 1831 Diegem, Belgium, Tel: (32) 2 663 0600, Fax: (32) 2 663 0640

Asia Pacific: Rockwell Automation, Level 14, Core F, Cyberport 3, 100 Cyberport Road, Hong Kong, Tel: (852) 2887 4788, Fax: (852) 2508 1846

Publication 1756-UM543F-EN-P - February 2018

Supersedes Publication 1756-UM543E-EN-P - December 2017

Copyright © 2018 Rockwell Automation, Inc. All rights reserved. Printed in the U.S.A.