

ControlLogix EtherNet/IP Module

Catalog Number 1756-EN2T

Topic	Page
About This Publication	1
Before You Begin	7
Determine Module Slot Location	8
Set the Network Address	9
Install the Module	11
Connect the Module to the EtherNet/IP Network	12
Program the Module via the USB Port	14
Configure the Module	15
Apply Chassis Power	15
Check Power Supply and Module Status	16
Install or Remove the Module Under Power	17
Interpret the Status Indicators	19
Specifications	22

About This Publication

Use this publication as a guide to install the module. This publication describes hardware installation only. For configuration information, refer to the EtherNet/IP Modules in Logix5000 Control Systems User Manual, publication [ENET-UM001](#). View or download this publication at <http://www.rockwellautomation.com/literature>.

Important User Information

Solid-state equipment has operational characteristics differing from those of electromechanical equipment. Safety Guidelines for the Application, Installation and Maintenance of Solid State Controls (Publication [SGI-1.1](#) available from your local Rockwell Automation sales office or online at <http://www.rockwellautomation.com/literature/>) describes some important differences between solid-state equipment and hard-wired electromechanical devices. Because of this difference, and also because of the wide variety of uses for solid-state equipment, all persons responsible for applying this equipment must satisfy themselves that each intended application of this equipment is acceptable.





In no event will Rockwell Automation, Inc. be responsible or liable for indirect or consequential damages resulting from the use or application of this equipment.

The examples and diagrams in this manual are included solely for illustrative purposes. Because of the many variables and requirements associated with any particular installation, Rockwell Automation, Inc. cannot assume responsibility or liability for actual use based on the examples and diagrams.



No patent liability is assumed by Rockwell Automation, Inc. with respect to use of information, circuits, equipment, or software described in this manual.

Reproduction of the contents of this manual, in whole or in part, without written permission of Rockwell Automation, Inc., is prohibited.

Throughout this manual, when necessary, we use notes to make you aware of safety considerations.

	WARNING: Identifies information about practices or circumstances that can cause an explosion in a hazardous environment, which may lead to personal injury or death, property damage, or economic loss.
	ATTENTION: Identifies information about practices or circumstances that can lead to personal injury or death, property damage, or economic loss. Attentions help you identify a hazard, avoid a hazard and recognize the consequences.
	SHOCK HAZARD: Labels may be on or inside the equipment, for example, drive or motor, to alert people that dangerous voltage may be present.
	BURN HAZARD: Labels may be on or inside the equipment, for example, drive or motor, to alert people that surfaces may reach dangerous temperatures.
IMPORTANT	Identifies information that is critical for successful application and understanding of the product.

North American Hazardous Location Approval

The following information applies when operating this equipment in hazardous locations.	Informations sur l'utilisation de cet équipement en environnements dangereux.
<p>Products marked "CL I, DIV 2, GP A, B, C, D" are suitable for use in Class I Division 2 Groups A, B, C, D, Hazardous Locations and nonhazardous locations only. Each product is supplied with markings on the rating nameplate indicating the hazardous location temperature code. When combining products within a system, the most adverse temperature code (lowest "T" number) may be used to help determine the overall temperature code of the system. Combinations of equipment in your system are subject to investigation by the local Authority Having Jurisdiction at the time of installation.</p>	<p>Les produits marqués "CL I, DIV 2, GP A, B, C, D" ne conviennent qu'à une utilisation en environnements de Classe I Division 2 Groupes A, B, C, D dangereux et non dangereux. Chaque produit est livré avec des marquages sur sa plaque d'identification qui indiquent le code de température pour les environnements dangereux. Lorsque plusieurs produits sont combinés dans un système, le code de température le plus défavorable (code de température le plus faible) peut être utilisé pour déterminer le code de température global du système. Les combinaisons d'équipements dans le système sont sujettes à inspection par les autorités locales qualifiées au moment de l'installation.</p>
<div style="display: flex; align-items: center;">  <div> <p>WARNING: Explosion Hazard -</p> <ul style="list-style-type: none"> • Do not disconnect equipment unless power has been removed or the area is known to be nonhazardous. • Do not disconnect connections to this equipment unless power has been removed or the area is known to be nonhazardous. Secure any external connections that mate to this equipment by using screws, sliding latches, threaded connectors, or other means provided with this product. • Substitution of components may impair suitability for Class I, Division 2. • If this product contains batteries, they must only be changed in an area known to be nonhazardous. </div> </div>	<div style="display: flex; align-items: center;">  <div> <p>AVERTISSEMENT: Risque d'Explosion –</p> <ul style="list-style-type: none"> • Couper le courant ou s'assurer que l'environnement est classé non dangereux avant de débrancher l'équipement. • Couper le courant ou s'assurer que l'environnement est classé non dangereux avant de débrancher les connecteurs. Fixer tous les connecteurs externes reliés à cet équipement à l'aide de vis, filets coulissants, connecteurs filetés ou autres moyens fournis avec ce produit. • La substitution de composants peut rendre cet équipement inadapté à une utilisation en environnement de Classe I, Division 2. • S'assurer que l'environnement est classé non dangereux avant de changer les piles. </div> </div>

Environment and Enclosure



ATTENTION: This equipment is intended for use in a Pollution Degree 2 industrial environment, in overvoltage Category II applications (as defined in IEC 60664-1), at altitudes up to 2000 m (6562 ft) without derating.

This equipment is considered Group 1, Class A industrial equipment according to IEC/CISPR 11. Without appropriate precautions, there may be difficulties with electromagnetic compatibility in residential and other environments due to conducted and radiated disturbances.

This equipment is supplied as open-type equipment. It must be mounted within an enclosure that is suitably designed for those specific environmental conditions that will be present and appropriately designed to prevent personal injury resulting from accessibility to live parts. The enclosure must have suitable flame-retardant properties to prevent or minimize the spread of flame, complying with a flame spread rating of 5VA, V2, V1, V0 (or equivalent) if non-metallic. The interior of the enclosure must be accessible only by the use of a tool. Subsequent sections of this publication may contain additional information regarding specific enclosure type ratings that are required to comply with certain product safety certifications.

In addition to this publication, see:

- Industrial Automation Wiring and Grounding Guidelines, Rockwell Automation publication [1770-4.1](#), for additional installation requirements.
 - NEMA Standard 250 and IEC 60529, as applicable, for explanations of the degrees of protection provided by different types of enclosure.
-

Prevent Electrostatic Discharge



ATTENTION: This equipment is sensitive to electrostatic discharge, which can cause internal damage and affect normal operation. Follow these guidelines when you handle this equipment:

- Touch a grounded object to discharge potential static.
 - Wear an approved grounding wriststrap.
 - Do not touch connectors or pins on component boards.
 - Do not touch circuit components inside the equipment.
 - Use a static-safe workstation, if available.
 - Store the equipment in appropriate static-safe packaging when not in use.
-

About the Module

Use this figure to identify the external features of the module.

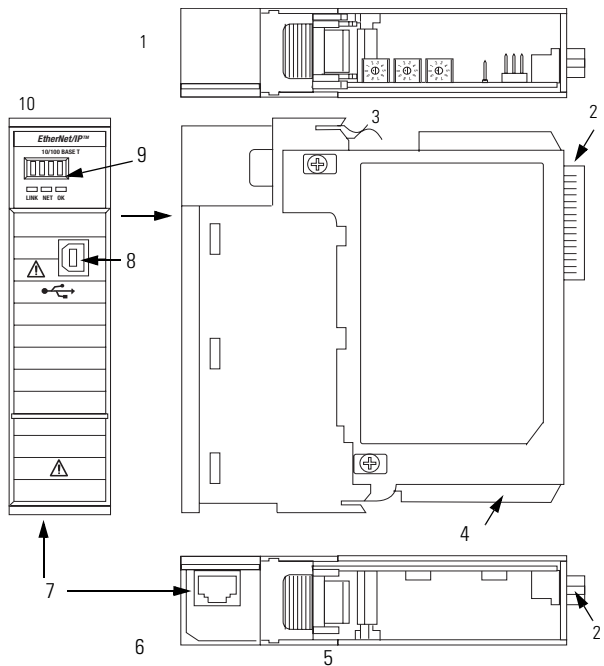

Item	Description	Item	Description
1	Top view	6	Front of module
2	Backplane connector	7	RJ45 cable connector (on underside of module)
3	Side view	8	USB port
4	MAC ID label (on opposite side of circuit board)	9	Front panel
5	Bottom view	10	Front view

Before You Begin

Before you install the module, you must install and connect a ControlLogix chassis and power supply.

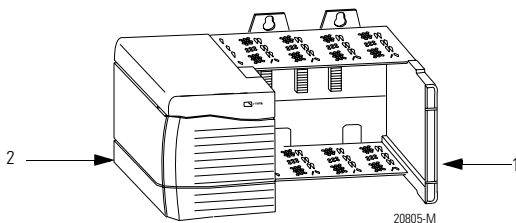

Item	Description	Item	Description
1	1756-A4 chassis	2	Power supply

To install these products, refer to these publications.

Chassis Type	Chassis Installation	Power Supply	Power Supply Installation
Series B: 1756-A4, 1756-A7, 1756-A10, 1756-A13	Publication 1756-IN080	1756-PA72/C	Publication 1756-IN078
		1756-PB72/B	
		1756-PA75/B	Publication 1756-IN596
		1756-PB75/B	

Determine Module Slot Location

Install the module in any slot in the ControlLogix chassis. You can install multiple 1756-EN2T modules in the same chassis. The following figure shows chassis slot numbering in a four-slot chassis. Slot 0 is the first slot and is always the leftmost slot in the rack.

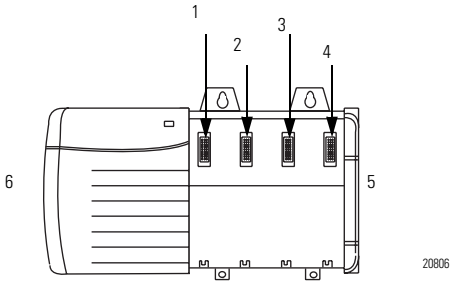

Item	Description	Item	Description
1	Slot 0	4	Slot 3
2	Slot 1	5	Chassis
3	Slot 2	6	Power supply

Set the Network Address

The module ships with the rotary switches set to 999 and BOOTP enabled. You can set the network Internet Protocol (IP) address three ways.

- Use the rotary switches on the top of the module.
- Use a BOOTP server or Dynamic Host Configuration Protocol (DHCP) server, such as Rockwell Automation BOOTP/DHCP.
- Use the Rockwell Automation RSLinx or RSLogix 5000 software.

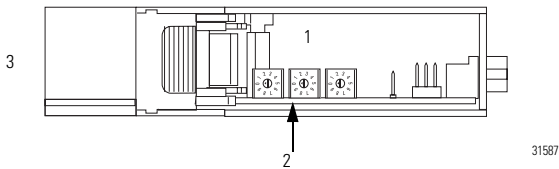

Item	Description
1	Top of module
2	Rotary switches
3	Front of module

The module reads the rotary switches first to determine if they are set to a valid number for the last portion of the IP address. Valid numbers range from 001...254. When the switches are set to a valid number, the module's IP address is 192.168.1.xxx (where xxx represents the number set on the switches). The module's subnet mask is 255.255.255.0 and the gateway address is set to 0.0.0.0. The module does not have a host name assigned, or use any Domain Name System when using the rotary switch settings.

10 ControlLogix EtherNet/IP Module

To reset the module to its initial out-of-the-box settings, reset the switches to 888 and cycle power.

IMPORTANT Do not use the 888 switch setting during normal module operation.

After cycling power with the switches set to 888, remove the module and set the switches to their final value. When you set the rotary switches to a value other than 888, or to the valid IP address values 001...254, the software configuration determines the IP address.

Determining the Module IP Address

If BOOTP/DHCP is	The module
Enabled	Asks for an address from a BOOTP/DHCP server. The server also assigns other Transport Control Protocol (TCP) parameters.
Not enabled	Uses the IP address (along with other TCP configurable parameters) stored in nonvolatile memory.

Install the Module

Follow this procedure to install the module.

1. Align the circuit board with top and bottom guides in the chassis.

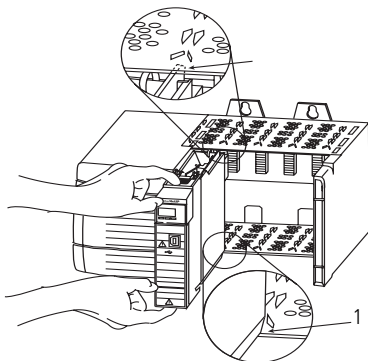

Item	Description
1	Circuit board

2. Slide the module into the chassis.

Make sure that the module backplane connector properly connects to the chassis backplane.

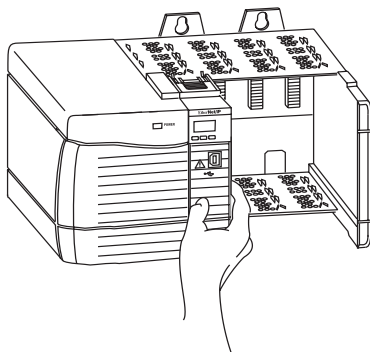

TIP The module is properly installed when it is flush with the power supply or other installed modules.

Connect the Module to the EtherNet/IP Network



WARNING: If you connect or disconnect the communication cable with power applied to this module or any device on the network, an electrical arc can occur. This could cause an explosion in hazardous location installations.

1. Be sure that power is removed or the area is nonhazardous before proceeding.
2. Attach the RJ45 connector to the Ethernet port on the bottom of the module as shown.

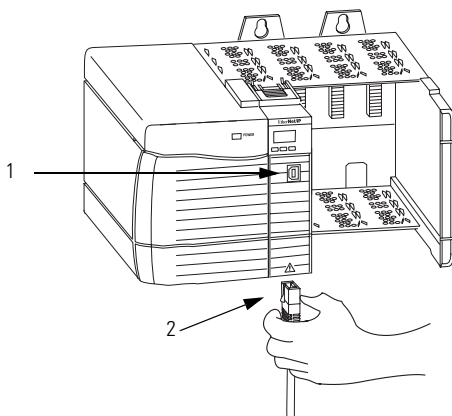

Item	Description	Item	Description
1	USB port	2	RJ45 connector (underneath module)

IMPORTANT

We recommend connecting the module to the network via a 100 MB Ethernet switch, which will reduce collisions and lost packets and increase network bandwidth. For detailed EtherNet/IP connection information, see the following publications:

- EtherNet/IP Performance and Application Guide, publication [ENET-AP001](#)
- EtherNet/IP Media Planning and Installation Guide, publication [ENET-IN001](#)

Program the Module via the USB Port



WARNING: The USB port is intended for temporary local programming purposes only and is not intended for permanent connection. If you connect or disconnect the USB cable with power applied to this module or any device on the USB network, an electrical arc can occur. This could cause an explosion in hazardous location installations.

Be sure that power is removed or the area is nonhazardous before proceeding.

A Samtec Inc. RSP-119350 USB cable is required to maintain hazardous location certifications.

Be sure that power is removed or the area is nonhazardous before proceeding.

The module has a USB device port that uses a series B receptacle. To use the USB port, you must have RSLinx software, version 2.51 or later installed on your computer. Use a USB cable to connect your computer to the USB port. The connection lets you download programs to controllers and to configure Ethernet modules directly from your computer.



ATTENTION:

- The USB port is designed for a temporary connection only.
 - The USB cable is not to exceed 3.0 m (9.84 ft) and must not contain hubs.
 - To maintain product certification integrity, you must use SAMTEC cable, part number RSP-119350.
-

Configure the Module

Follow these steps to configure the module.

1. In RSLogix 5000 software, from the Controller Organizer, select New Module.
2. Select the module you want to configure.

For more configuration information, refer to the EtherNet/IP Modules in Logix5000 Control Systems User Manual, publication [ENET-UM001](#). View or download this publication at <http://www.rockwellautomation.com/literature>.

Apply Chassis Power

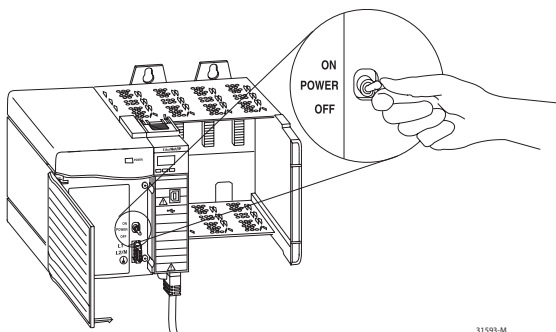

31593-M

Check Power Supply and Module Status

Check the status indicators and alphanumeric display to determine whether the power supply and module are operating properly.

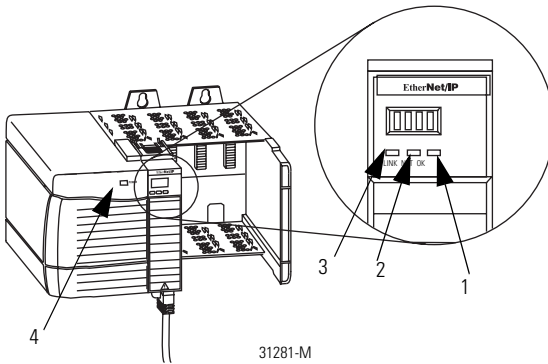

31281-M

Item	Description	Item	Description
1	OK indicator is red during self-test, then green	3	NET status indicator
2	LINK status indicator	4	Power supply indicator is green

The alphanumeric display should cycle through these states:

- TEST
- PASS
- OK
- REV *x.x*

where *x.x* is the module's firmware revision.

The display then alternates between OK and the module's EtherNet/IP address.

Install or Remove the Module Under Power

You can install or remove this module while chassis power is applied.



WARNING: When you insert or remove the module while backplane power is on, an electrical arc can occur. This could cause an explosion in hazardous location installations. Be sure that power is removed or the area is nonhazardous before proceeding. Repeated electrical arcing causes excessive wear to contacts on both the module and its mating connector. Worn contacts may create electrical resistance that can affect module operation.

1. Push on upper and lower module tabs to disengage them.

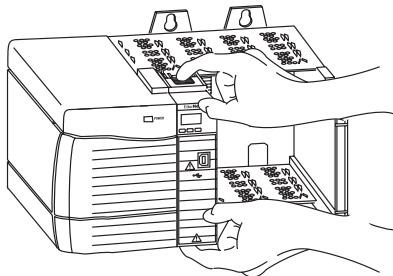

2. Slide the module out of the chassis.

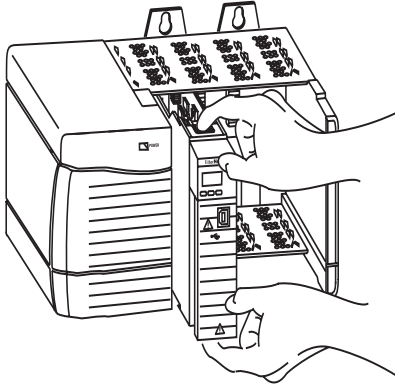

IMPORTANT

If you want to replace an existing module with an identical one, and you want to resume identical system operation, you must install the new module in the same slot.

Interpret the Status Indicators

If the alphanumeric display and status indicators do not sequence through the expected states, refer to these tables. The three bi-color (red/green) status indicators on the module provide diagnostic information about the module and its connections to the network.

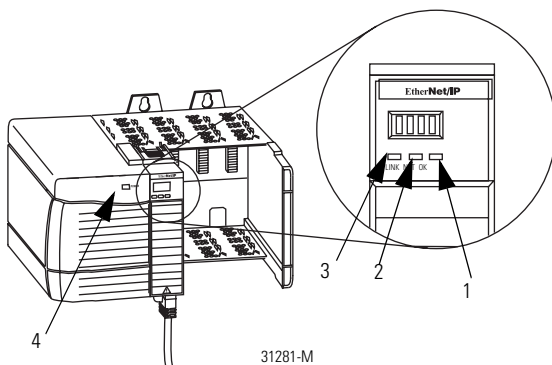

Item	Description	Item	Description
1	OK indicator is red during self-test, then green	3	LINK status indicator
2	NET status indicator	4	Power supply indicator is green

Status Indicators

Indicator	Status	Description
NET	Off	The module is not powered. Verify that there is chassis power and that the module is completely inserted into the chassis and backplane. The module does not have a valid IP address. Make sure the module has been configured with a valid IP address.
	Flashing green	The module has an IP address, but has no established connections.
	Green	The module has an IP address and at least one established connection.
	Red	The module is attempting to use an IP address already in use on the network. Assign a unique IP address to the module.
Link	Off	The module is not ready to communicate. Verify that the module has power.
	Green	The module is ready to communicate.
	Flashing green	The module is communicating over the network.

Status Indicators

Indicator	Status	Description
OK	Off	Verify that the module has 24V DC chassis power and that the module is completely inserted into chassis and backplane.
	Flashing green	The module is not configured.
	Green	The module is operating correctly.
	Flashing red	The module detected a recoverable fault. A configuration error may have caused the fault. Check the module configuration. If necessary, reconfigure the module.
	Red	The module detected an unrecoverable fault. Cycle power to the module. If this does not clear the fault, replace the module.
	Red and alphanumeric display scrolls 'Image Update Needed'	Update the firmware image. Once the image is updated, cycle power. If this does not clear the fault, replace the module.
	Flashing red and green	The module is performing a power-up self-test.

Specifications

Technical Specifications - 1756-EN2T

Attribute	1756-EN2T
Enclosure type rating	None (open-style)
Module location	Any slot in the ControlLogix chassis
Backplane current	1 A at 5.1V DC
Backplane current	3 mA at 24V DC
Isolation voltage	30V (continuous), Basic Insulation Type, Ethernet to backplane No isolation between USB and backplane Type tested at 510V AC for 60 s
Power dissipation, max.	5.1 W
Wire size	Ethernet connections: RJ45 connector according to IEC 60603-7, 2 or 4 pair Category 5e minimum cable according to TIA 568-B.1 or Category 5 cable according to ISO/IEC 24702
Wiring category	2 - on Ethernet ports ⁽¹⁾
Temperature, surrounding air	60 °C (140 °F)
North American temp code	Series A: T5 Series B and C: T4A
Recommended USB cable for USB port	Samtec cable, PN RSP-119350
USB port	USB 1.1 USB device USB series B receptacle

⁽¹⁾ Use this Conductor Category information for planning conductor routing. Refer to Industrial Automation Wiring and Grounding Guidelines, publication [1770-4.1](#).

Environmental Specifications - 1756-EN2T

Attribute	1756-EN2T
Temperature, operating <ul style="list-style-type: none"> • IEC 60068-2-1 (Test Ad, Operating Cold) • IEC 60068-2-2 (Test Bd, Operating Dry Heat) • IEC 60068-2-14 (Test Nb, Operating Thermal Shock) 	0...60 °C (32...140 °F)
Temperature, nonoperating <ul style="list-style-type: none"> • EC 60068-2-1 (Test Ab, Unpackaged Nonoperating Cold) • IEC 60068-2-2 (Test Bb, Unpackaged Nonoperating Dry Heat) • IEC 60068-2-14 (Test Na, Unpackaged Nonoperating Thermal Shock) 	40...85 °C (-40...185 °F)
Relative humidity <ul style="list-style-type: none"> • IEC 60068-2-30 (Test Db, Unpackaged Damp Heat) 	5...95% noncondensing
Vibration <ul style="list-style-type: none"> • IEC 60068-2-6 (Test Fc, Operating) 	2 g @ 10...500 Hz
Shock, operating IEC 60068-2-27 (Test Ea, Unpackaged Shock)	30 g
Shock, nonoperating IEC 60068-2-27 (Test Ea, Unpackaged Shock)	50 g
Emissions <ul style="list-style-type: none"> • CISPR 11 	Group 1, Class A
Immunity, ESD <ul style="list-style-type: none"> • IEC 61000-4-2 	6 kV contact discharges 8 kV air discharges
Immunity, radiated RF <ul style="list-style-type: none"> • IEC 61000-4-3 	10V/m with 1 kHz sine-wave 80%AM from 80...2000 MHz 10V/m with 200 Hz 50% Pulse 100%AM at 900 MHz 10V/m with 200 Hz 50% Pulse 100%AM at 1890 MHz 3V/m with 1 kHz sine-wave 80% AM from 2000...2700 MHz
Immunity, EFT/B <ul style="list-style-type: none"> • IEC 61000-4-4 	±2 kV at 5 kHz on Ethernet port
Immunity, surge transient <ul style="list-style-type: none"> • IEC 61000-4-5 	±2 kV line-earth(CM) on Ethernet port

Environmental Specifications - 1756-EN2T

Attribute	1756-EN2T
Immunity, conducted RF <ul style="list-style-type: none"> • IEC 61000-4-6 	10V rms with 1 kHz sine-wave 80%AM from 150 kHz...80 MHz

Certifications - 1756-EN2T

Certifications⁽¹⁾ (when product is marked)	1756-EN2T
c-UL-us	<ul style="list-style-type: none"> • UL Listed Industrial Control Equipment, certified for US and Canada. See UL File E65584. • UL Listed for Class I, Division 2 Group A,B,C,D Hazardous Locations, certified for U.S. and Canada. See UL File E194810.
CSA	<ul style="list-style-type: none"> • CSA Certified Process Control Equipment. See CSA File LR54689C. • CSA Certified Process Control Equipment for Class I, Division 2 Group A,B,C,D Hazardous Locations. See CSA File LR69960C.
FM	<ul style="list-style-type: none"> • FM Approved Equipment for use in Class I Division 2 Group A,B,C,D Hazardous Locations
CE	European Union 2004/108/EC EMC Directive, compliant with: <ul style="list-style-type: none"> • EN 61326-1; Meas./Control/Lab., Industrial Requirements • EN 61000-6-2; Industrial Immunity • EN 61000-6-4; Industrial Emissions • EN 61131-2; Programmable Controllers (Clause 8, Zone A & B)
C-Tick	Australian Radiocommunications Act, compliant with: <ul style="list-style-type: none"> • AS/NZS CISPR 11; Industrial Emissions
EtherNet/IP	<ul style="list-style-type: none"> • ODVA conformance tested to EtherNet/IP specifications

⁽¹⁾ See the Product Certification link at <http://www.ab.com> for Declarations of Conformity, Certificates, and other certification details.

Additional Resources

These documents contain additional information concerning related Rockwell Automation products.

Resource	Description
Industrial Automation Wiring and Grounding Guidelines, publication 1770-4.1	Provides general guidelines for installing a Rockwell Automation industrial system
EtherNet/IP Modules in Logix5000 Control Systems User Manual, publication ENET-UM001	Contains information about how to use EtherNet/IP modules with various Logix5000 controllers
EtherNet/IP Performance and Application Guide, publication ENET-AP001	Provides detailed EtherNet/IP connection information
EtherNet/IP Media Planning and Installation Guide, publication ENET-IN001	Provides detailed EtherNet/IP connection information
ControlLogix Chassis Installation Instructions, publication 1756-IN080	Contains information about how to install a ControlLogix chassis
ControlLogix Power Supplies Installation Instructions, publication 1756-IN078	Contains information about how to install ControlLogix power supplies
ControlLogix Power Supplies Installation Instructions, publication 1756-IN596	Contains information about how to install ControlLogix power supplies
Open DeviceNet Vendor Association (ODVA) website, http://www.odva.org	Provides information about implementing EtherNet/IP technology

You can view or download publications at <http://www.rockwellautomation.com/literature>. To order paper copies of technical documentation, contact your local Rockwell Automation distributor or sales representative.

Notes:

Notes:

Rockwell Automation Support

Rockwell Automation provides technical information on the Web to assist you in using its products. At <http://www.rockwellautomation.com/support/>, you can find technical manuals, a knowledge base of FAQs, technical and application notes, sample code and links to software service packs, and a MySupport feature that you can customize to make the best use of these tools.

For an additional level of technical phone support for installation, configuration, and troubleshooting, we offer TechConnect support programs. For more information, contact your local distributor or Rockwell Automation representative, or visit <http://www.rockwellautomation.com/support/>.

Installation Assistance

If you experience a problem within the first 24 hours of installation, please review the information that's contained in this manual. You can also contact a special Customer Support number for initial help in getting your product up and running.

United States or Canada	1.440.646.3434
Outside United States or Canada	Use the Worldwide Locator at http://www.rockwellautomation.com/support/americas/phone_en.html , or contact your local Rockwell Automation representative.

New Product Satisfaction Return

Rockwell Automation tests all of its products to ensure that they are fully operational when shipped from the manufacturing facility. However, if your product is not functioning and needs to be returned, follow these procedures.

United States	Contact your distributor. You must provide a Customer Support case number (call the phone number above to obtain one) to your distributor to complete the return process.
Outside United States	Please contact your local Rockwell Automation representative for the return procedure.

Documentation Feedback

Your comments will help us serve your documentation needs better. If you have any suggestions on how to improve this document, complete this form, publication [RA-DU002](#), available at <http://www.rockwellautomation.com/literature>.

Allen-Bradley, ControlLogix, Rockwell Software, Rockwell Automation, and TechConnect are trademarks of Rockwell Automation, Inc.

Trademarks not belonging to Rockwell Automation are property of their respective companies.

Rockwell Otomasyon Ticaret A.Ş., Kar Plaza İş Merkezi E Blok Kat:6 34752 İçerenköy, İstanbul, Tel: +90 (216) 5698400

www.rockwellautomation.com

Power, Control and Information Solutions Headquarters

Americas: Rockwell Automation, 1201 South Second Street, Milwaukee, WI 53204 USA, Tel: (1) 414.382.2000, Fax: (1) 414.382.4444

Europe/Middle East/Africa: Rockwell Automation, Vorstlaan/Boulevard du Souverain 36, 1170 Brussels, Belgium, Tel: (32) 2 663 0600, Fax: (32) 2 663 0640

Asia Pacific: Rockwell Automation, Level 14, Core F, Cyberport 3, 100 Cyberport Road, Hong Kong, Tel: (852) 2887 4788, Fax: (852) 2508 1846

Publication 1756-IN603C-EN-P - April 2010

PN-74517

Supersedes Publication 1756-IN603B-EN-P - January 2009

Copyright © 2010 Rockwell Automation, Inc. All rights reserved. Printed in the U.S.A.