

1732E ArmorBlock Dual-Port EtherNet/IP 4-Point Isolated Thermocouple and RTD Input Modules

Catalog Numbers 1732E-IT4IM12R, 1732E-IR4IM12R



Important User Information

Solid-state equipment has operational characteristics differing from those of electromechanical equipment. Safety Guidelines for the Application, Installation and Maintenance of Solid State Controls (publication [SGL-1.1](#) available from your local Rockwell Automation sales office or online at <http://www.rockwellautomation.com/literature/>) describes some important differences between solid-state equipment and hard-wired electromechanical devices. Because of this difference, and also because of the wide variety of uses for solid-state equipment, all persons responsible for applying this equipment must satisfy themselves that each intended application of this equipment is acceptable.

In no event will Rockwell Automation, Inc. be responsible or liable for indirect or consequential damages resulting from the use or application of this equipment.

The examples and diagrams in this manual are included solely for illustrative purposes. Because of the many variables and requirements associated with any particular installation, Rockwell Automation, Inc. cannot assume responsibility or liability for actual use based on the examples and diagrams.

No patent liability is assumed by Rockwell Automation, Inc. with respect to use of information, circuits, equipment, or software described in this manual.

Reproduction of the contents of this manual, in whole or in part, without written permission of Rockwell Automation, Inc., is prohibited.

Throughout this manual, when necessary, we use notes to make you aware of safety considerations.



WARNING: Identifies information about practices or circumstances that can cause an explosion in a hazardous environment, which may lead to personal injury or death, property damage, or economic loss.



ATTENTION: Identifies information about practices or circumstances that can lead to personal injury or death, property damage, or economic loss. Attentions help you identify a hazard, avoid a hazard, and recognize the consequence



SHOCK HAZARD: Labels may be on or inside the equipment, for example, a drive or motor, to alert people that dangerous voltage may be present.



BURN HAZARD: Labels may be on or inside the equipment, for example, a drive or motor, to alert people that surfaces may reach dangerous temperatures.

IMPORTANT Identifies information that is critical for successful application and understanding of the product.

Allen-Bradley, Rockwell Automation, ArmorBlock, RSLogix 5000, and TechConnect are trademarks of Rockwell Automation, Inc.

Trademarks not belonging to Rockwell Automation are property of their respective companies.

Read this preface to familiarize yourself with the rest of the manual. It provides information concerning:

- who should use this manual
- the purpose of this manual
- related documentation
- conventions used in this manual

Who Should Use this Manual

Use this manual if you are responsible for designing, installing, programming, or troubleshooting control systems that 1732E ArmorBlock™ EtherNet/IP Dual Port 4-Point Thermocouple and RTD Modules.

You should have a basic understanding of electrical circuitry and familiarity with relay logic. If you do not, obtain the proper training before using this product.

Purpose of this Manual

This manual is a reference guide for the 1732E-IT4IM12R, 1732E-IR4IM12R modules. It describes the procedures you use to install, wire, troubleshoot, and use your module.

Related Documentation

The following documents contain additional information concerning Rockwell Automation products. To obtain a copy, contact your local Rockwell Automation office or distributor.

Resource	Description
1732E ArmorBlock Dual-Port EtherNet/IP 4-Point Analog Modules 1732E-WD003	Information on wiring the ArmorBlock Dual-Port EtherNet/IP 4-Point Analog Modules (1732E-IF4M12R, 1732E-OF4M12R, 1732E-IT4IM12R, 1732E-IR4IM12R).
1732E ArmorBlock Dual-Port EtherNet/IP 4-Point Thermocouple and RTD Input Modules Installation Instructions, publication 1732E-IN005	Information on installing the ArmorBlock EtherNet/IP module.
EtherNet/IP Embedded Switch Technology Application Guide, publication ENET-AP005	A manual on how to install, configure and maintain linear and Device-level Ring (DLR) networks using Rockwell Automation EtherNet/IP devices with embedded switch technology.
EtherNet/IP Modules in Logix5000 Control Systems User Manual, publication ENET-UM001	A manual on how to use EtherNet/IP modules with Logix5000 controllers and communicate with various devices on the Ethernet network.
Getting Results with RSLogix 5000, publication 9399-RLD300GR	Information on how to install and navigate RSLogix 5000. The guide includes troubleshooting information and tips on how to use RSLogix 5000 effectively.
Allen-Bradley Industrial Automation Glossary, AG-7.1	A glossary of industrial automation terms and abbreviations.

Common Techniques Used in this Manual

The following conventions are used throughout this manual:

- Bulleted lists such as this one provide information, not procedural steps.
- Numbered lists provide sequential steps or hierarchical information.
- *Italic* type is used for emphasis.

Notes:

	Preface	
	Who Should Use this Manual	iii
	Purpose of this Manual	iii
	Related Documentation	iii
	Common Techniques Used in this Manual	iii
	Chapter 1	
Overview of the 1732E ArmorBlock Thermocouple and RTD Input Modules	Overview	1
	Module Features	1
	Physical Features of Your Module	2
	Types of Modules	3
	Hardware/Software Compatibility	3
	Thermocouple Types	3
	Cold Junction Compensation	3
	RTD Sensor Types	4
	Module Alarms	5
	Overrange Alarm	5
	Underrange Alarm	5
	Level Alarms	6
	Digital Filters	6
	Chapter Summary	6
	Chapter 2	
Install Your ArmorBlock Module	Overview	7
	Install the Module	7
	Set the Network Address	7
	Mount the Module	9
	Wire the Module	10
	Chapter Summary	12
	Chapter 3	
Configure Your Thermocouple and RTD Input Modules with RSLogix 5000 Software	Introduction	13
	Set Up the Hardware	14
	Create the Example Application	15
	Configure Your I/O Module	16
	RSLogix 5000 Configuration Software	16
	Overview of the Configuration Process through RSLogix 5000	16
	Add a New Bridge and Module to Your RSLogix 5000 Project	16
	Add the Local EtherNet/IP Bridge to the I/O Configuration	17
	Add the I/O module as a child of the 1756-EN2T module	18
	Download the Program to Your Controller	20

Edit Your Module Configuration	21
General Tab	22
Connection Tab	23
Configuration Tab for 1732E-IR4IM12R	24
Configuration Tab for 1732E-IT4IM12R	26
Alarm Configuration Tab	28
Internet Protocol Tab	30
Calibration Tab	31
Status and Monitoring Tabs	32
Chapter Summary	33

Chapter 4

Configurable Features for the Thermocouple and RTD Input Modules

Overview	35
Configure Your Input Modules	35
Configurable Options and Their Effect on the Channels	36
Sensor Type	36
Temperature Units	37
Notch Filter	37
Digital Filter	38
Cold Junction Compensation (1732E-IT4IM12R only)	38
Data Tables	39
Chapter Summary	44

Chapter 5

Calibrate Your Modules

Overview	45
Calibrate the Thermocouple Module	46
Calibrate the RTD Module	49
Chapter Summary	51

Chapter 6

Troubleshoot the Module

Interpret Status Indicators	53
Check for Faults	54

Appendix A

Specifications

General Specifications	57
Input Specifications	57
Environmental Specifications	60
Certifications	60

	Appendix B	
1732E ArmorBlock Embedded Web Server	Introduction.....	63
	Typical Applications	63
	Browser Requirements.....	63
	Access the Home Page of the Web Server.....	64
	Log On to the Web Server	64
	Navigate the 1732E ArmorBlock I/O.....	65
	Access Diagnostic Information	66
	Access Configuration Information.....	66
	Appendix C	
Module Tag Definitions	Module Tags for 1732E-IT4IM12R	67
	Module Tags for 1732E-IR4IM12R	69
	Access the Module Tags	71
Index		

Notes:

Overview of the 1732E ArmorBlock Thermocouple and RTD Input Modules

Overview

This chapter provides an introduction to the features and functionalities of the 1732E ArmorBlock Thermocouple and RTD Input Modules. It includes the following sections.

Topic	Page
Module Features	1
Physical Features of Your Module	2
Types of Modules	3
Hardware/Software Compatibility	3
Thermocouple Types	3
RTD Sensor Types	4
Digital Filters	6
Module Alarms	5

Module Features

The 1732E-IT4IM12R and 1732E-IR4IM12R modules let you configure a sensor type for each of four input channels that linearizes analog signal into a temperature value. The RTD module, 1732E-IR4IM12R, linearizes ohms into temperature and the Thermocouple module, 1732E-IT4IM12R, linearizes millivolts into temperature.

The modules have the following features:

- Sensor type
- Preset temperature selection
- Fault mode
- Level alarms
- overrange and underrange detection

To learn more about module features, see [Configurable Features for the Thermocouple and RTD Input Modules on page 35](#).

You must use RSLogix 5000 to configure these features. For a detailed how-to-configure instructional guide, see the chapter, [Configure Your Thermocouple and RTD Input Modules with RSLogix 5000 Software on page 13](#).

Physical Features of Your Module

The modules have the following components:

- Node address switches
- Connectors (two EtherNet/IP D-code M12 connectors, two micro-style Power in/out connectors, four I/O M12 connectors)
- Status indicators (Link, I/O, Module, Network, and Auxiliary power status indicators)
- Functional earth ground

Physical Features of 1732E-IT4IM12R and 1732E-IR4IM12R Modules

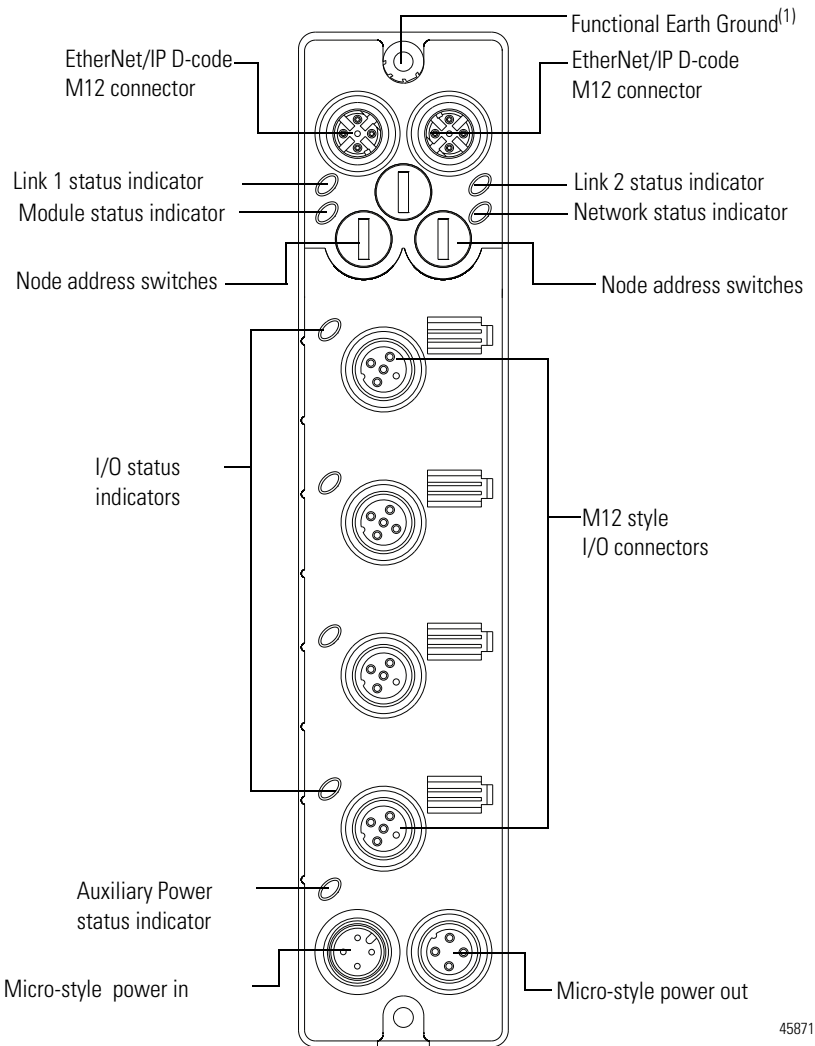

45871

⁽¹⁾ Functional Earth grounds the I/O block's EtherNet/IP communication circuitry which is designed to mitigate the effect of noise on the network. The device requires a solid earth ground connection, either through a metal screw to a grounded metal panel or through a wire.

Types of Modules

The Thermocouple and RTD modules are as follows.

Catalog Number	Description	Network Connector	Power Connector
1732E-IT4IM12R	24V DC power, 4-Point Isolated Thermocouple Input, Dual-Port EtherNet/IP Module	Dual D-code M12	Dual 4-pin micro
1732E-IR4IM12R	24V DC power, 4-Point Isolated RTD Input, Dual-Port EtherNet/IP Module		

Hardware/Software Compatibility

The module and the applications described in this manual are compatible with the following firmware versions and software releases.

Product	Firmware Version / Software Release
1732E-IT4IM12R and 1732E-IR4IM12R	Firmware rev. 1.1 or later
1756-EN2T, 1756-EN2TR, 1756-EN3TR	3.x version when using RSLogix 5000 v20 or later
RSLogix 5000 software	20 or later
RSLinx software	2.56 or later

Thermocouple Types

The 1732E-IT4IM12R module supports the following thermocouples.

Supported Thermocouple Types

Type	Material	Temperature Range °C (°F)	Voltage Range
B	Pt /30% Rh vs. Pt/5% Rh	40...1820 (104...3308)	0.000...13.820 mV
C	W/5% Re vs. W/26% Re	0...2320 (32...4208)	0.000...37.107 mV
E	Ni/Cr vs. Cu/Ni	-270...1000 (-454...1832)	-9.835...76.373 mV
J	Fe vs. Cu/Ni	-210...1200 (-346...2192)	-8.095...69.553 mV
K	Ni/Cr vs. Ni/Al	-270...1372 (-454...2501.6)	-6.458...54.886 mV
N	Ni/14.2%Cr/1.4%Si vs. Ni/4.4%Si/0.1%Mg	-270...1300 (-454...2372)	-4.345...47.513 mV
R	Pt/13%Rh vs. Pt	-50...1768 (-58...3214.4)	-0.226...21.101 mV
S	Pt/10%Rh vs. Pt	-50...1768 (-58...3214.4)	-0.236...18.693 mV
T	Cu vs. Cu/Ni	-270...400 (-454...752)	-6.258...20.872 mV

Cold Junction Compensation

When using thermocouples, cold junction compensation is required at the termination of the thermocouple wire. The actual cold junction exists outside of the module at the wiring block internal to the CJC module and is representative of the ambient temperature.

Accomplish a cold junction in the following ways:

- Enter an estimated temperature (Cold Junction Compensation Offset).
- Use external cold junction compensators to measure the cold junction temperature directly.

To compensate for cold junction temperature voltage, the 1732E-IT4IM12R Thermocouple module has to determine actual cold junction temperature. If the module is configured to provide cold junction compensation, then the user must use a CJC Terminal Chamber (such as Allen-Bradley 871A-TS4CJC-DM or 871A-TR4CJC-DM⁽¹⁾ as shown in the next diagram).

The module uses this thermistor(s) resistance to deduce the cold junction generated voltage to be applied to accurately measure the hot junction absolute temperature.

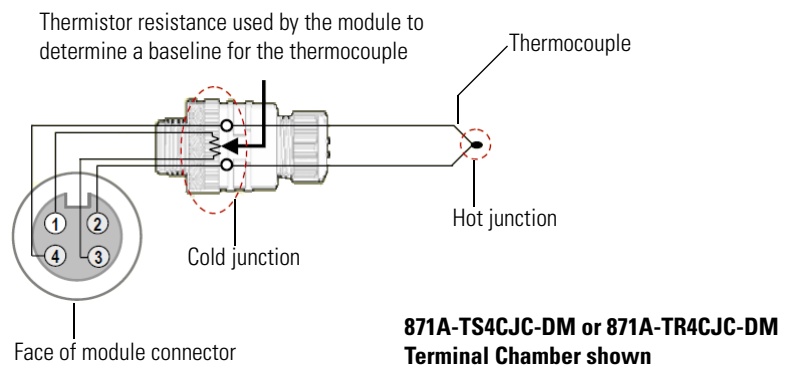

The compensation voltage to be applied can also be estimated by applying fixed cold junction correction using a fixed offset directly through the RSLogix 5000 software. The module supports thermistor compensation range at 0...70 °C.

The Thermocouple module also supports CJC error detection if a channel CJC module is selected but is not correctly connected to the correct channel. The module detects open circuit condition and triggers the warning status bit and fault LED.

Cold junction compensation is supported on all four channels of the 1732E-IT4IM12R module.

RTD Sensor Types

The 1732E-IR4IM12R module supports 100Ω- 200Ωμ = 0.00385/0.003916 Pt RTDs, 100/120Ω Ni RTDs, and a 10Ω Cu α = 0.00427 RTD.

(1) The Allen-Bradley 871A-TS4CJC-DM or 871A-TR4CJC-DM terminal chamber has an embedded thermistor, which facilitates thermocouple-based temperature measurement. The thermistor types supported are Thermometrics MF65F302V/W, or DC95F302V/W.

It supports 3-wire and 2-wire RTDs using a jumper in the wiring at the input connector of the module. The following RTD input types are supported.

Supported RTD Types

RTD type	Temperature Range °C (°F)	Voltage Range
100 Ω Pt 385 0...390.48 Ω	-200...850 °C (-328...1562 °F)	0...150 mV
200 Ω Pt 385 0...781 Ω	-200...650 °C (-328...1202 °F)	0...300 mV
100 Ω Pt 3916 0...337.03 Ω	-200...630 °C (-328...1166 °F)	0...156.25 mV
200 Ω Pt 3916 0...674.06 Ω	-200...630 °C (-328...1166 °F)	0...312.5 mV
10 Ω Cu 427 0...19.116 Ω	-320...500 °C (-544...932 °F)	0...19.47 mV
120 Ω Ni 672 0...445.10 Ω	-70...445 °C (-94...833 °F)	0...156.25 mV
100 Ω Ni 618 0...198.88 Ω	-60...180 °C (-76...356 °F)	0...75 mV
120 Ω Ni 618 0...238.65 Ω	-90...140 °C (-130...284 °F)	0...75 mV

The module uses a third sensor wire to measure and correct for the cable lead resistance for each RTD type. The compensation circuit depends on an outside module jumper to connect the third wire if the compensating lead wire is not available (that is, if a 2-wire RTD is connected to the I/O connector).

If the lead resistance is not directly measured with the third lead wire, the user can specify a lead wire resistance offset to be applied to the data for direct compensation via RSLogix 5000.

Module Alarms

The ArmorBlock Thermocouple and RTD modules are capable of generating the following alarms.

- Overrange
- Underrange
- Level (low, low-low, high, high-high)
- Open-wire detection

Overrange Alarm

The channel overrange alarm is set if the input is greater than the maximum temperature (thermocouple or RTD range dependent), millivolt (+78 mV) or resistance (600 Ω) range value, or above the maximum range of the thermocouple or RTD.

Underrange Alarm

The channel underrange alarm is set if the input is less than the minimum temperature (thermocouple or RTD range dependent), millivolt (-78 mV) or

resistance ($10\ \Omega$) range value, or below the minimum range of the thermocouple or RTD.

Level Alarms

The following level alarms are available.

- Low
- Low-Low
- High
- High-High

When the channel input goes below a low alarm or above a high alarm, a bit is set in the data table. All Alarm Status bits can be read individually or by reading the Channel Status Byte (see [page 35](#)).

You can configure each channel alarm individually.

Digital Filters

The modules also support a digital filter to smooth input data noise transients on each input channel. This value specifies the time constant for a digital first order lag filter on the input. It is specified in units of milliseconds. A value of 0 disables the filter.

To learn how to configure digital filters, see [page 21](#).

Chapter Summary

In this chapter, you were introduced to the ArmorBlock Thermocouple and RTD input modules.

Install Your ArmorBlock Module

Overview

This chapter shows you how to install and wire the 1732E ArmorBlock EtherNet/IP Dual Port 4-Point Thermocouple and RTD Input modules. The only tools you require are a flat or Phillips head screwdriver and drill. This chapter includes the following topics:

Topics	Page
Install the Module	7
Set the Network Address	7
Mount the Module	9
Wire the Module	10

Install the Module

To install the module:

- Set the network address
- Mount the module
- Connect the I/O, Network, and Auxiliary cables to the module.

Set the Network Address

The I/O block ships with the rotary switches set to 999 and DHCP enabled. To change the network address, you can do one of the following:

- adjust the node address switches on the front of the module.
- use a Dynamic Host Configuration Protocol (DHCP) server, such as Rockwell Automation BootP/DHCP.
- retrieve the IP address from nonvolatile memory.

The I/O block reads the switches first to determine if the switches are set to a valid number. To set the network address:

1. Remove power.
2. Remove the switch dust caps.
3. Rotate the three (3) switches on the front of the module using a small blade screwdriver.
4. Line up the small notch on the switch with the number setting you wish to use.
Valid settings range from 001...254.

5. Replace switch dust caps. Make sure not to over tighten.
6. Reapply power.
7. Record IP address on product label found on the side of enclosure.

Set Network Address

Example shows network switches set at 163, which sets the module IP address to 192.168.1.**163**.

Note: You need to remove the protective switch dust caps before you can adjust the address settings.

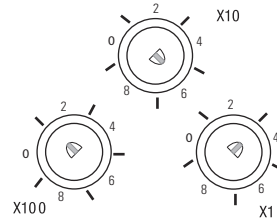

44233

When the switches are set to a valid number, the I/O block’s IP address is 192.168.1.xxx, where xxx represents the number set on the switches. The I/O block’s subnet mask is 255.255.255.0 and default gateway address is set to 192.168.1.1.

When the I/O block uses the network address set on the switches, the I/O block does not have a host name assigned to it or use any Domain Name Server.

If the switches are set to an invalid number (for example, 000 or a value greater than 254 excluding 888), the I/O block checks to see if DHCP is enabled. If DHCP is enabled, the I/O block asks for an address from a DHCP server. The DHCP server also assigns other Transport Control Protocol (TCP) parameters. (The modules are shipped with the network switches set to 999.)

If DHCP is not enabled, the I/O block uses the IP address (along with other TCP configurable parameters) stored in nonvolatile memory.

Network Address Switch value 001

The module IP address cannot be the same as the gateway address. If the address switches are set to 001, the module IP address becomes 192.168.1.1, which is the same as the default gateway address. In this case, the module gateway address will be set to 0.0.0.0.

Default Factory Configuration

The switch value 888 resets the module to default factory configuration on power up. The module will not operate properly when powered up with this setting. The switches must be set to a different (and valid) value and then power cycled after a reset.

While in reset state, the module LED flashes red and the network LED goes off.

Mount the Module

To mount the module on a wall or panel, use the screw holes provided in the module. Refer to the drilling dimensions illustration to guide you in mounting the module.

Mounting Dimensions

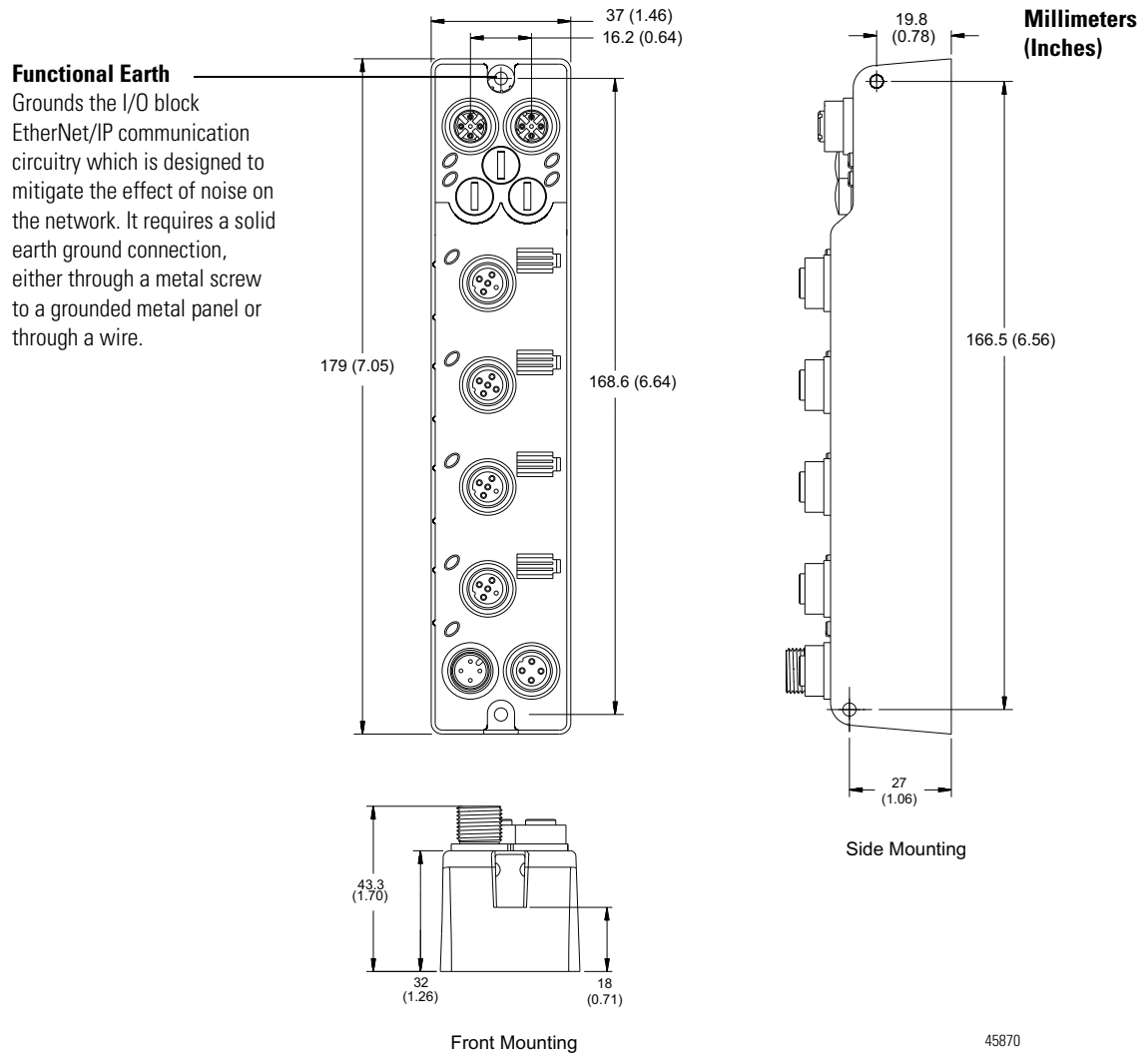

Install the mounting base as follows:

1. Lay out the required points as shown above in the drilling dimension drawing.
2. Drill the necessary holes for #6 (M3) pan head screws.
3. Mount the module using #6 (M3) screws.

Mount the Module in High Vibration Areas

If you mount the module in an area that is subject to shock or vibration, we recommend you use a flat and a lock washer to mount the module. Mount the flat

and the lock washer as shown in the mounting illustration. Torque the mounting screws to 0.68 Nm (6 lb-in.).

High Vibration Area Mounting

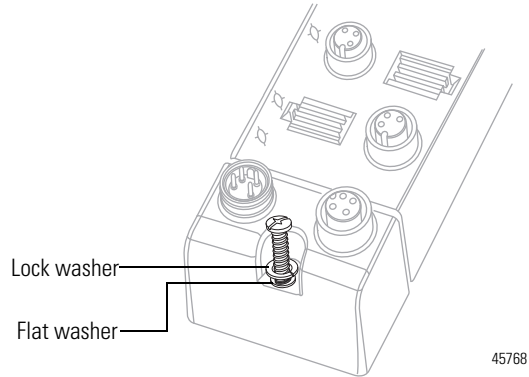

Wire the Module

The 1732E-IT4IM12R and 1732E-IR4IM12R modules have 5-pin micro-style M12 I/O connectors. We provide caps to cover the unused connectors on your module. Connect the quick-disconnect cord sets you selected for your module to the appropriate ports.

I/O Connectors⁽¹⁾

Micro-style M12 5-Pin Input Female Connector – 1732E-IT4IM12R

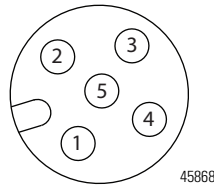

(View into connector)

- Pin 1CJC +
- Pin 2TC +
- Pin 3CJC -
- Pin 4TC -
- Pin 5No Connect

Micro-style M12 5-Pin Input Female Connector – 1732E-IR4IM12R

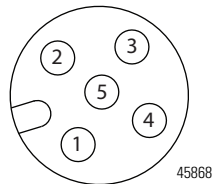

(View into connector)

- Pin 1No Connect
- Pin 2A
- Pin 3B
- Pin 4C
- Pin 5No Connect

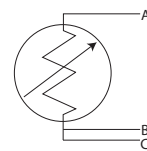

(1) Only 4 of the 5 pins are active. The center pin (5) is internally tied to signal ground to minimize external noise pickup.

Ethernet Connector

D-Code Micro Network Female Connector

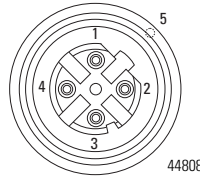

(View into connector 1)
 Pin 1 M12_Tx+
 Pin 2 M12_Rx+
 Pin 3 M12_Tx-
 Pin 4 M12_Rx-
 Pin 5 Connector shell shield GND

IMPORTANT

Use the 1585D–M4DC–H: Polyamide small body unshielded mating connectors for the D-Code M12 female network connector.

Note that the distance between the center of each Ethernet connector is 16.2 mm (see Mounting Dimensions on page 9). Rockwell Automation recommends the use of suitable cable based on this measurement. Some of the recommended cables are 1585D-M4TBJM-x and 1585D-M4TBDM-x for daisychains.

IMPORTANT

Use two twisted pair CAT5E UTP or STP cables.

D-Code M12 Pin	Wire Color	Signal	8-way Modular RJ45 Pin
1	White-orange	TX+	1
2	White-green	RX+	3
3	Orange	TX-	2
4	Green	RX-	6

Power Connectors

Attach the micro-style 4-pin connector to the micro-style 4-pin receptacle as shown below.

Micro-style 4-Pin Input Male Receptacle

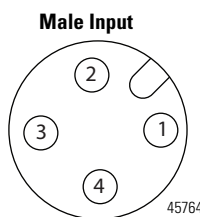

(View into receptacle)
 Pin 1 Auxiliary power+
 Pin 2 Module power+
 Pin 3 Module power-
 Pin 4 Auxiliary power-

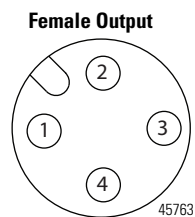

The power required by the module is based on a 4-pin micro-style connector system. Power can be daisy chained through the module either left to right or right to left. The standard configuration is with Module/Auxiliary power entering the module on the left connector.

Both modules require two 24V DC (nominal) supplies. These supplies are called the Module Power and the Auxiliary Power. The Module power supplies the microprocessor and Ethernet portions of the module, while Auxiliary power supplies the I/O circuits.

Internally, the Module Power and Auxiliary Power are electrically isolated.

IMPORTANT The maximum current that any pin on the power connectors can carry is 4 A.



ATTENTION: To comply with the CE Low Voltage Directive (LVD), this equipment and all connected I/O must be powered from a source compliant with the following:
Safety Extra Low Voltage (SELV) or Protected Extra Low Voltage (PELV).



ATTENTION: To comply with UL restrictions, this equipment must be powered from a source compliant with the following: Limited Voltage/
Limited Current.

ATTENTION: The device meets UL Type 1 Enclosure rating.

Chapter Summary

In this chapter, you learned how to install and wire your module.

Configure Your Thermocouple and RTD Input Modules with RSLogix 5000 Software

Introduction

This chapter guides you through the steps required to configure your modules using the RSLogix 5000 software. Note that the modules presented in this chapter can be configured using RSLogix 5000 software, version 20, or later.

Topic	Page
Set Up the Hardware	14
Create the Example Application	15
Configure Your I/O Module	16
Overview of the Configuration Process through RSLogix 5000	16
Add a New Bridge and Module to Your RSLogix 5000 Project	16
Download the Program to Your Controller	20
Edit Your Module Configuration	21
Chapter Summary	33

Configuring the two modules through RSLogix 5000 involve the same general procedure. Note, however, that the two modules do not have exactly similar Module Definition properties. These are distinctly covered in this chapter.

Set Up the Hardware

In this example, a ControlLogix chassis contains the Logix5565 processor in slot 1 and a 1756-EN2T bridge module in slot 3. The 1732E ArmorBlock module is mounted remotely.

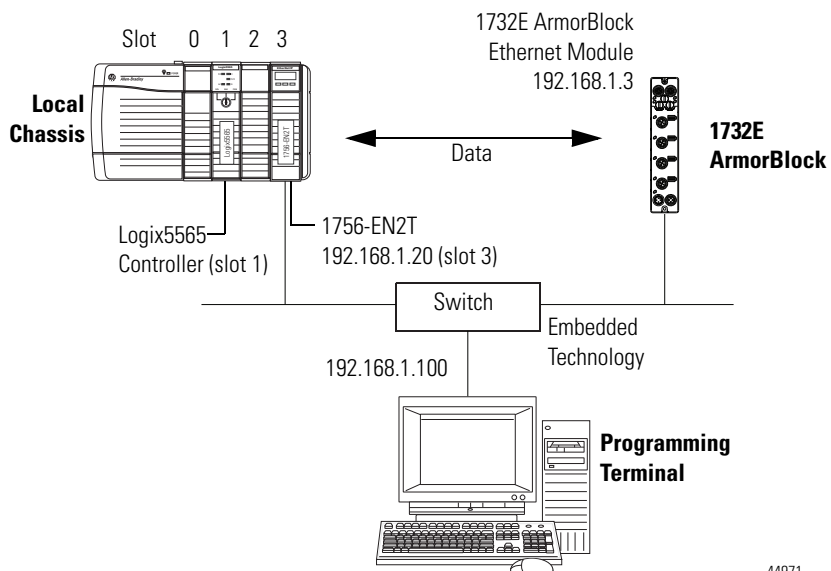

44971

To work along with this example set up your system as shown.

- Note that in the example application, the Logix5565 controller and 1756-EN2TR module (firmware version 2.3 or higher) are assumed to be in the slots shown.
- Verify the IP addresses for your programming terminal, 1756-EN2TR module and 1732E ArmorBlock Ethernet module.
- Verify that you connected all wiring and cabling properly.
- Be sure you configured your communication driver (for example, AB_ETH-1 or AB-ETHIP-1) in RSLinx software.

Create the Example Application

Perform the following steps to create the example application:

1. From the File menu, select New.

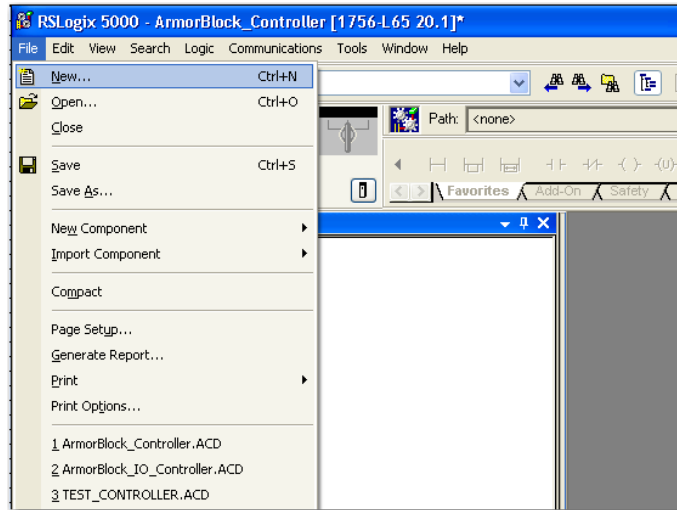

The New Controller dialog opens.

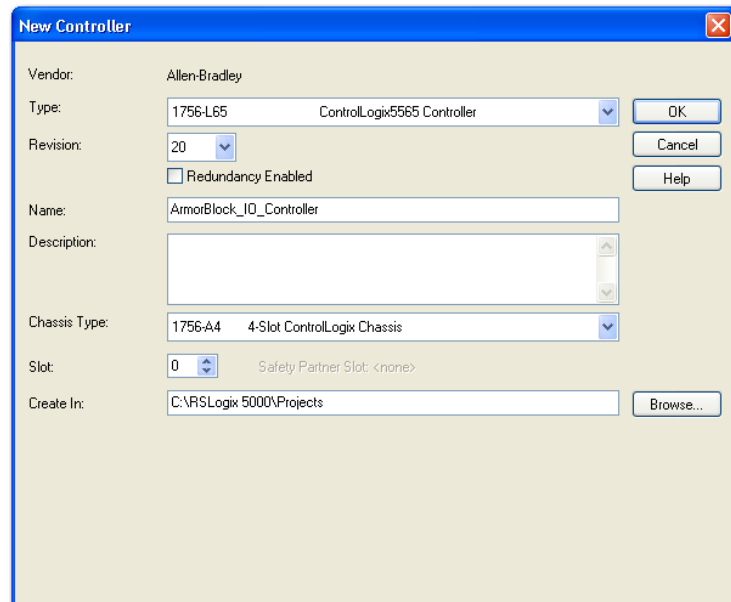

2. Enter an appropriate name for the Controller, for example, ArmorBlock_IO_Controller.
3. Select the correct version, chassis type, and slot number of the controller, and the folder where you want to save the RSLogix 5000 software file (Create In). The Description is optional.

To use redundancy in your system, select the Redundancy Enabled checkbox.

4. Click OK.

Configure Your I/O Module

You must configure your module upon installation. The module will not work until it has been configured with at least the default configuration.

RSLogix 5000 Configuration Software

You must use **RSLogix 5000, version 20 or later**, to configure your module. You have the option of accepting default configuration for your module or writing point-level configuration specific to your application.

Both options are explained in detail, including views of software screens, in this chapter.

Overview of the Configuration Process through RSLogix 5000

When you use the RSLogix 5000 software to configure a module, you must perform the following steps:

1. Add the Local EtherNet/IP Bridge (1756-EN2T, 1756-EN2TR, or 1756-EN3TR) to your project's I/O Configuration.
2. Add the 1732E-IT4IM12R or 1732E-IR4IM12R module as a child of the 1756-EN2T module.
3. Accept the default configuration or change it to specific configuration for the module.
4. Edit configuration for a module when changes are needed.

Add a New Bridge and Module to Your RSLogix 5000 Project

After you have started RSLogix 5000 software and created a controller, you must add a new bridge and a new module to your project. The bridge allows your module to communicate with the controller.

The wizard allows you to create a new module and write configuration. You can use default configuration or write specific configuration for your application.

IMPORTANT

Click Help on the configuration dialogs shown in this section if you need assistance in selecting and setting the parameters.

Add the Local EtherNet/IP Bridge to the I/O Configuration

1. If necessary, go offline.

If you are not offline, use this pull-down menu to go offline.

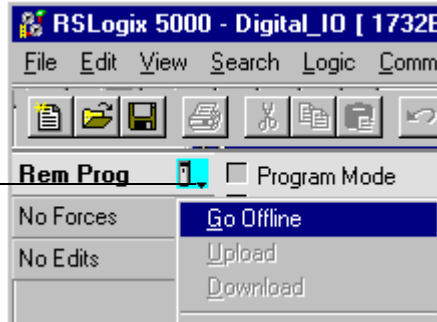

2. Add the EtherNet/IP Bridge to your RSLogix 5000 project.

A. Right-click 1756 Backplane.

B. Select New Module.

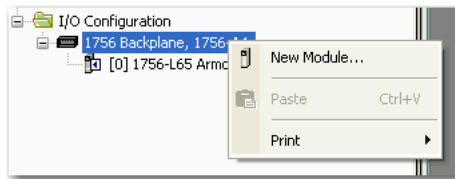

3. Expand Communications and select the new module in the Select Module dialog that appears. Select the 1756-EN2T EtherNet/IP Bridge.

A. Select the 1756-EN2T EtherNet/IP Bridge.

B. Click OK.

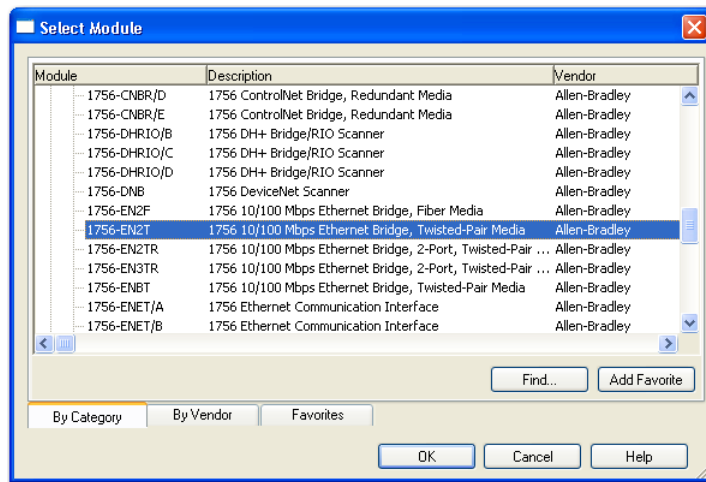

- The New Module dialog opens. Configure the bridge module as illustrated below.

- Name the bridge.
- Enter the IP address.
- Select slot 3 for the EtherNet/IP bridge.
- Make sure the Minor Revision number matches your module revision number.
- Choose an Electronic Keying method. For more information, see [page 22](#).
- Click OK.

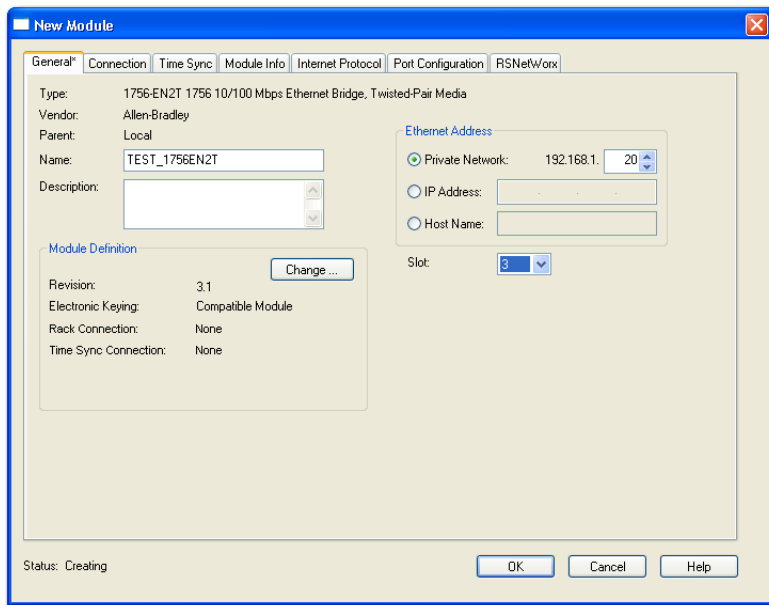

Note that we have entered the following properties in this example:

Name	TEST_1756EN2T
IP address	192.168.1.20
Slot	3
Revision	3.1
Electronic Keying	Compatible Module

The local 1756-EN2T communication module will communicate with the 1732E ArmorBlock module on Ethernet. Before you can communicate with your module, you need to add it as a *child* of the 1756-EN2T communication module. For more information about using 1756 controller and EtherNet/IP products, see publication [ENET-UM001](#).

Add the I/O module as a child of the 1756-EN2T module

- Right-click the Ethernet folder that appears below the 1756-EN2T bridge you added to the I/O Configuration tree and select New Module.

- On the Select Module Type dialog that appears, select the 1732E-IT4IM12R module. Click Create.
To look for the 1732E-IT4IM12R module in the list, you can type the catalog number in the search box or use the filters. To do so, click Clear Filters and check Analog in the Module Type Category Filters.

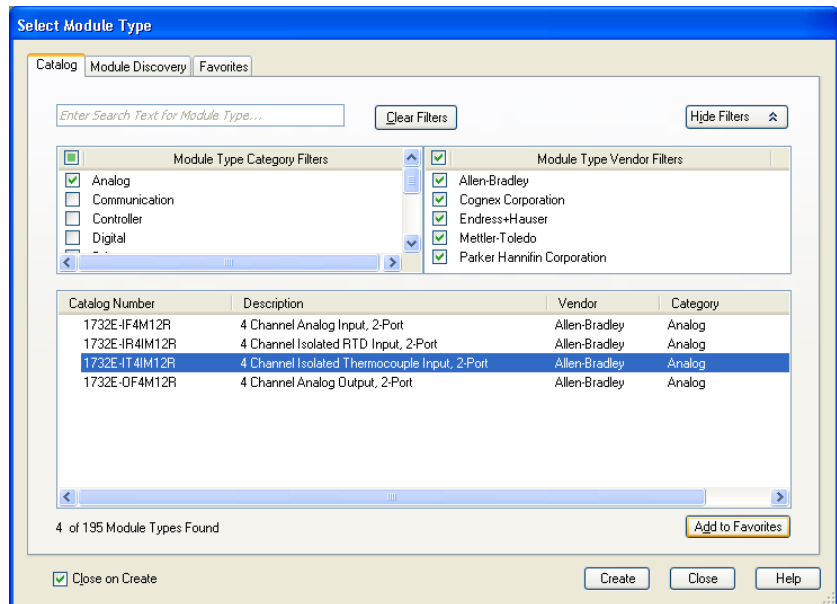
**TIP**

If the 1732E-IT4IM12R, 1732E-IR4IM12R modules are not listed under the analog category of the Select Module Type dialog you may need to download the Add-On Profile (AOP) for the 1732E ArmorBlock 2-Port and install it as an add-on to RSLogix 5000. The AOP file can be downloaded from:

support.rockwellautomation.com/controlflash/LogixProfiler.asp

- The New Module dialog appears.
Fill in the Module Properties information as shown, and then click OK.

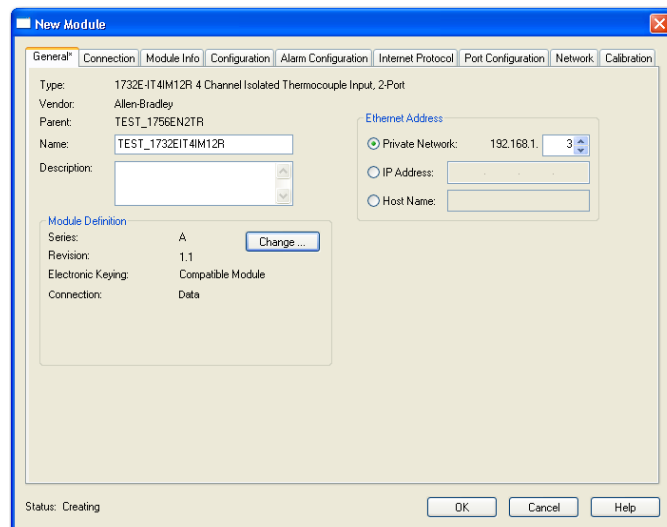

Note that we have used the following properties in this example:

Field Name	Value
Name	TEST_1732EIT4IM12R
IP address	192.168.1.3
Electronic keying	Compatible Module
Revision	1.1
Connection	Input Only

To add the 1732E-IR4IM12R RTD module, follow the same steps. After adding the modules to your project, the I/O Configuration tree should appear as follows:

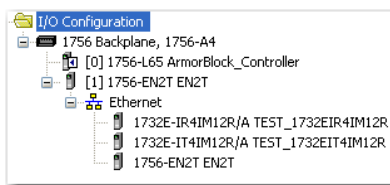

This example uses default Module Definition and configuration properties. To edit your configuration, see [Edit Your Module Configuration on page 21](#).

Download the Program to Your Controller

After you write configuration for your module, the module does not use this configuration until you download it to the owner-controller. The download transfers the entire program to the controller, overwriting any existing program.

Download module configuration as shown below:

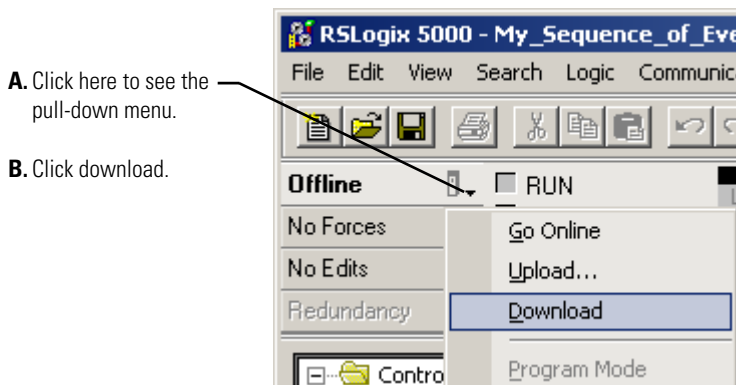

Depending on your application, a variety of RSLogix 5000 software screens may appear to choose a path to your ControlLogix controller and to verify the download. Navigate those screens as best fits your application.

This completes the download process.

Edit Your Module Configuration

RSLogix 5000 programming software automatically creates module-defined data types and tags when a module is created. This section describes how to modify the default configuration for input modules.

Data types symbolically name module configuration, input and output data. Tags let you provide each a unique name, such as where the user-defined data type and slot reside on the controller. This information is used to communicate data between the controller and module.

After you have set configuration for a module, you can review and change your choices. You can change configuration data and download it to the controller while online. This is called **dynamic reconfiguration**.

Your freedom to change some configurable features, though, depends on whether the controller is in Remote Run Mode or Program Mode.

IMPORTANT Although you can change configuration while online, you must go offline to add or delete modules from the project.

The editing process begins on the main page of RSLogix 5000 software.

1. On the I/O Configuration tree for your project in RSLogix 5000, right-click the name of your module.

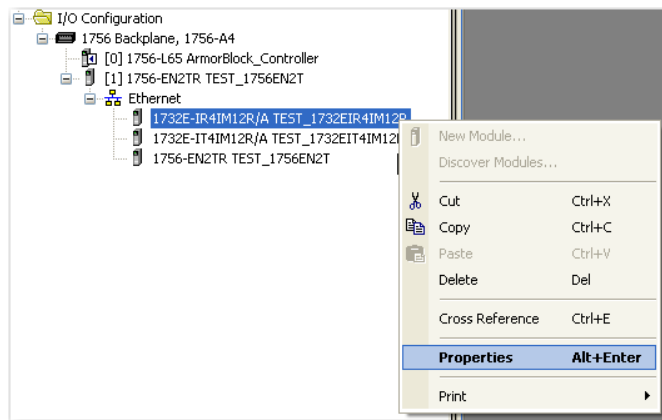

2. Select Properties. The Module Properties dialog appears and has the following tabs available for configuration.



3. Click any of the tabs to edit the parameters for your module. The next sections show you how to edit the different tabs in the Module Properties dialog.

TIP Tabs can be selected in any order. The following examples are for instructional purposes.

General Tab

The General tab allows you to edit general properties such as Name, IP Address, and Description for your module.

You also can edit Module Definition properties such as revision, electronic keying, and data. To do so, click Change.

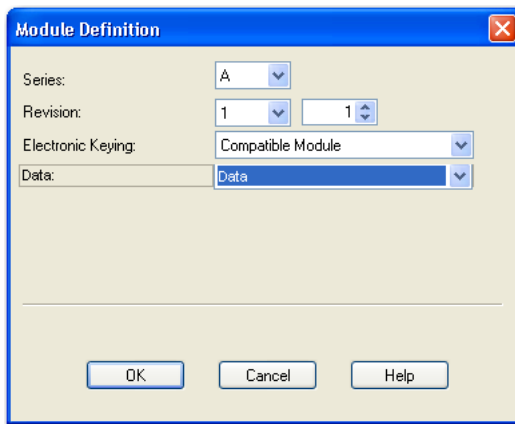

Module Definition Fields

Field Name	Description
Series	Specifies the module series.
Revision	Specifies the module's major and minor revision.
Electronic Keying	<p>The electronic keying feature automatically compares the expected module, as shown in the RSLogix 5000 I/O Configuration tree, to the physical module before I/O communication begins. You can use electronic keying to help prevent communication to a module that does not match the type and revision expected.</p> <p>For each module in the I/O Configuration tree, the user-selected keying option determines if, and how, an electronic keying check is performed. Typically, three keying options are available:</p> <ul style="list-style-type: none"> • Exact Match • Compatible Module (default value) • Disable Keying <p>Exact Match is an electronic keying protection mode that requires the physical module and the module configured in the software to match according to vendor, catalog number, major revision and minor revision.</p> <p>Compatible Module indicates that the module determines whether to accept or reject communication. Compatible Keying is the default setting. It allows the physical module to accept the key of the module configured in the software, provided that the configured module is one the physical module is capable of emulating. The exact level of emulation required is product and revision specific.</p> <p>Disable Keying indicates the keying attributes are not considered when attempting to communicate with a module. Other attributes, such as data size and format, are considered and must be acceptable before I/O communication is established. With Disabled Keying, I/O communication may occur with a module other than the type specified in the I/O configuration tree with unpredictable results. We generally do not recommend using Disabled Keying.</p>

Module Definition Fields

Field Name	Description
Connection	<p>Available options are Data, Input Only, Exclusive Owner, and Listen Only. Calibration and Configuration options are not available for Listen Only option.</p> <p>Input Only specifies an independent connection where a device receives inputs from the target device and sends configuration data to the target device. An Input Only connection does not send outputs; it only receives inputs. You can specify multiple Input Only connections to the target device from different originators.</p> <p>Exclusive Owner specifies an independent connection where a single device controls the output states in the target device. If you have an existing Exclusive Owner connection to a target device, you cannot specify another Exclusive Owner or Redundant connection to that same target device.</p> <p>Listen Only specifies a dependent connection where a device receives inputs from the target device, but does not send configuration data with the target device. A Listen Only connection only functions properly when another non-Listen Only connection exists to the same target device. A Listen Only connection does not send outputs; it only receives inputs. You can specify multiple Listen Only connections to the target device from different originators.</p>

Connection Tab

The Connection tab on the Module Properties dialog box lets you enter a requested packet interval (RPI), inhibit a module, and set a connection fault when the controller is in Run mode. The RPI provides a defined, maximum period of time when data is transferred to the owner-controller.

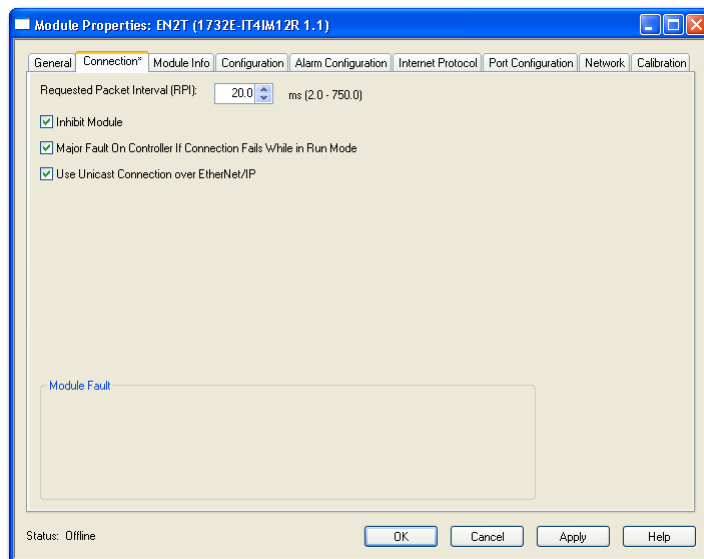

1. Choose from the options on the Connection tab.

Connection Tab Fields

Field	Description
Requested Packet Interval (RPI) (ms)	A user-defined rate at which the module updates the information sent to its owner-controller. This interval defines the slowest rate at which a module sends its data to the owner-controller. The time ranges from 2.0...750 ms and is sent to the module with all other configuration parameters.
Inhibit Module	Check the box to prevent communication between the ownercontroller and the module. This option allows for maintenance of the module without faults being reported to the controller.
Major fault On Controller If Connection Fails While in Run Mode	Check the box to create a major fault if there is a connection failure with the controller while in Run mode.
Use Unicast Connection over EtherNet/IP	This option is enabled by default. Unicast connections are point to point transmissions between a source node and destination node on the network. A Frame is sent to a single destination.
Module Fault	The fault box is empty if you are offline. The type of connection fault appears in the text box if a fault occurs when the module is online.

2. Do one of the following:

- Click Apply to store a change but stay on the dialog box to choose another tab.
- Click OK if you are finished making changes.

Configuration Tab for 1732E-IR4IM12R

The Configuration tab on the Module Properties dialog box lets you program information on each of the four channels on the 1732E-IR4IM12R module.

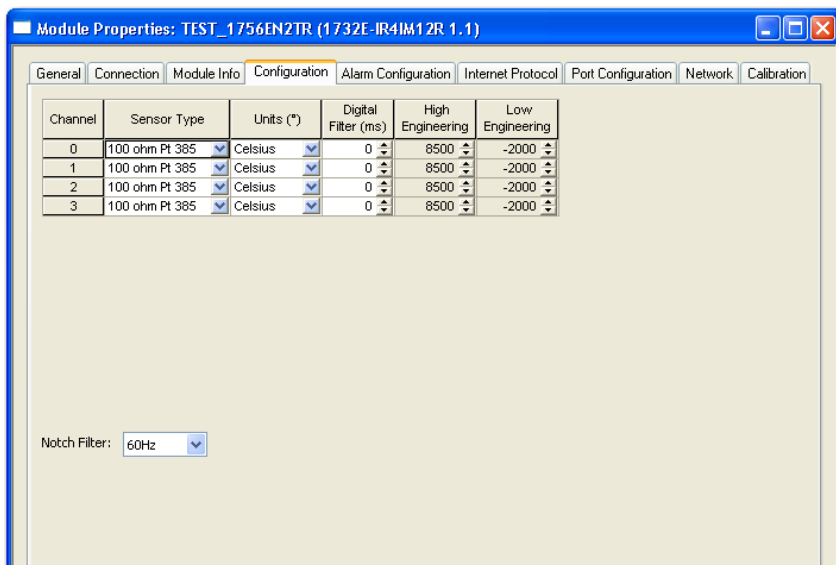

1. Choose from the options on the Configuration tab.

Configuration tab

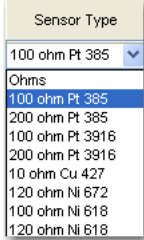
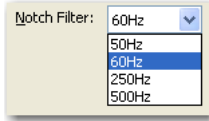
Field	Description
Channel	Indicates the four input channels 0...3.
Sensor Type	<p>Specifies the sensor type for each channel.</p>  <p>To learn more about sensor types, see Sensor Type on page 36.</p>
Units	<p>Refers to the temperature unit that will be used. Available in °C and °F. When the RTD sensor type is set to Ohms, the temperature unit field is not available.</p>
Digital Filter	Choose a value in milliseconds that specifies the time constant for a digital first order lag filter on the input. A value of 0 disables the filter. Valid filter range is 1...10000.
Notch Filter	 <p>Default value: 60 Hz</p> <p>An analog-to-digital converter (ADC) filter removes line noise in your application for each channel. Choose a notch filter that most closely matches the anticipated noise frequency in your application. Remember that each filter time affects the response time of your module. Also, the highest frequency notch filter settings also limit the effective resolution of the channel.</p>
High Engineering Low Engineering	High Engineering and Low Engineering values are determined by the Sensor Type selected for each channel. The corresponding values for each sensor type are listed in the table, High Engineering and Low Engineering Values for 1732E-IR4IM12R on page 25 .

2. Do one of the following:

- Click Apply to store a change but stay on the dialog box to choose another tab.
- Click OK if you are finished making changes.

High Engineering and Low Engineering Values for 1732E-IR4IM12R

RTD Sensor Type	Units	Low Engineering	High Engineering
Ohms	N/A	0	5000
100 ΩPt 385	°C	-2000	8500
	°F	-3280	15620

High Engineering and Low Engineering Values for 1732E-IR4IM12R

RTD Sensor Type	Units	Low Engineering	High Engineering
200 ΩPt 385	°C	-2000	6300
	°F	-3280	11660
100 ΩPt 3916	°C	-2000	6500
	°F	-3280	12020
200 ΩPt 3916	°C	-2000	6500
	°F	-3280	12020
10 ΩCu 427	°C	-1000	2600
	°F	-1480	5000
120 ΩNi 672	°C	-800	2600
	°F	-1120	5000
100 ΩNi 618	°C	-600	1800
	°F	-760	3560
120 ΩNi 618	°C	-900	1400
	°F	-1300	2840

Configuration Tab for 1732E-IT4IM12R

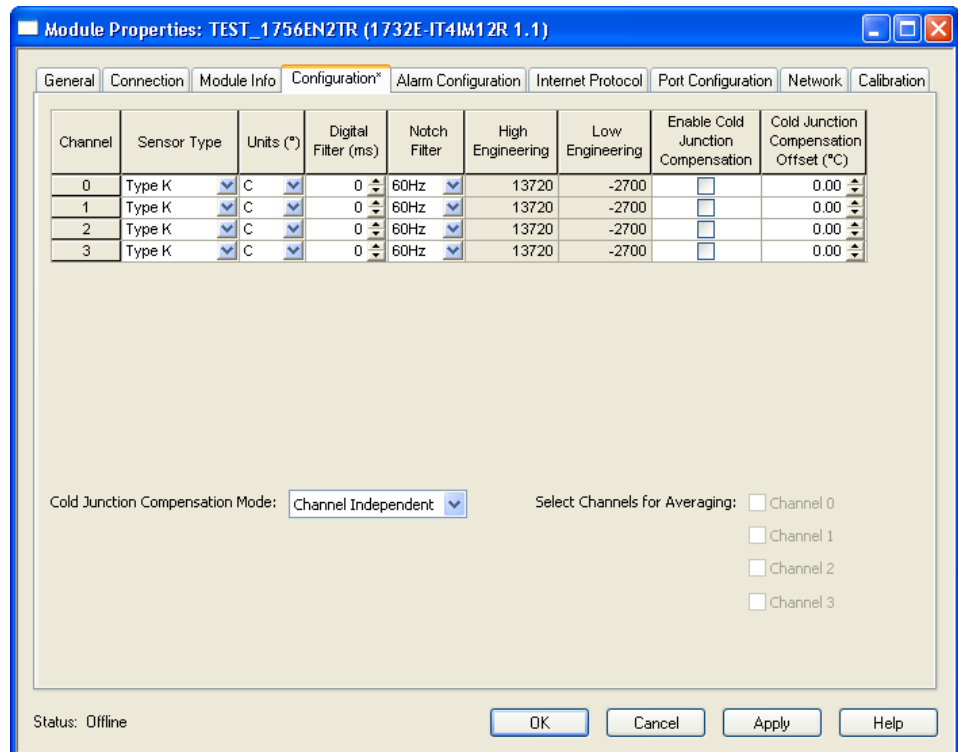

1. Choose from the options on the Configuration tab.

Configuration tab

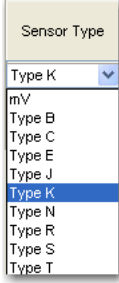
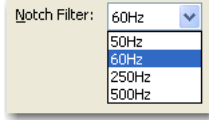
Field	Description
Channel	Indicates the four input channels 0...3.
Sensor Type	<p>Specifies the sensor type for each channel.</p>  <p>To learn more about sensor types, see Sensor Type on page 36.</p>
Units	<p>Refers to the temperature unit that will be used. Available in °C and °F. When the Thermocouple sensor type is set to mV, the temperature unit field is not available.</p>
Digital Filter	Choose a value in milliseconds that specifies the time constant for a digital first order lag filter on the input. A value of 0 disables the filter. Valid filter range is 1...10000.
Notch Filter	 <p>Default value: 60 Hz</p> <p>Use the default (60 Hz) or choose a frequency that attenuates the input signal at this specified frequency. See Notch Filter on page 37 for more information.</p>
High Engineering Low Engineering	High Engineering and Low Engineering values are determined by the Sensor Type selected for each channel.
Enable Cold Junction Compensation	<p>This parameter enables or disables the use of the external cold junction compensation for the channel. If enabled, the proper cold junction compensation value is applied to the selected thermocouple as determined by the external thermistor. If disabled, the data (cold junction temperature) is still available but not applied to the input. A cold junction value can be added using the Cold Junction Offset parameter.</p> <p>Cold Junction Compensation is supported on all four channels of the thermocouple module.</p> <p>For more information, see Cold Junction Compensation (1732E-IT4IM12R only) on page 38.</p>

Configuration tab

Field	Description
Cold Junction Compensation Offset	Cold Junction Compensation Offset lets you manually enter a cold junction temperature. This can only be done if the external cold junction compensation is disabled. If there is no thermistor available, and the ambient temperature is known to be, for example, 28.00 °C (82.40 °F), you can type the value into the box to provide the cold junction compensation. For more information, see Cold Junction Compensation (1732E-IT4IM12R only) on page 38 .
Cold Junction Compensation Mode	When the cold junction is enabled, the mode determines where the temperature measurement source (the thermistor) is located. Valid values are Channel Independent, or Average Selected. See Cold Junction Compensation (CJC) Mode on page 39 to learn more about the CJC modes.
Select Channels for Averaging	This option is only available if the Cold Junction Compensation Mode is Average Selected. It allows you to select all the channels that have a thermistor attached. When a single channel is selected, the thermistor attached to that channel provides the compensation temperature for all channels. When more than one channel is selected, the temperature used by the selected channels is averaged across all selected channels that have a valid thermistor detected.

Alarm Configuration Tab

The Alarm Configuration tab on the Module Properties dialog box lets you program high and low limits, and disable and latch alarms per channel.

Click Channel button to set limits and alarm configuration for each of the 4 channels.

Use the sliders to set limits. HH slider sets High High limits; HI sets High limits; LL for Low Low; and LO for Low.

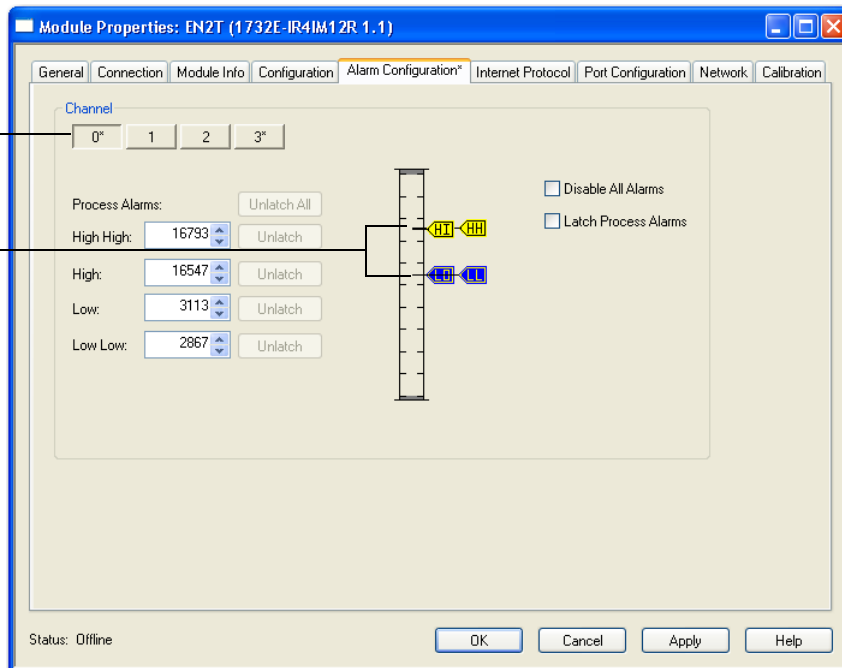

1. Choose from the options on the Alarm Configuration tab.

Alarm Configuration tab

Field	What to do	Description
Channel	Select a push button to correspond to a channel (0...3)	Click the channel that is being configured.
Process Alarms		Type a value for each of the four alarm trigger points that alert you when the module has exceeded these limitations. You also can use the respective slider icon to set a trigger value. The Unlatch buttons are enabled only when the module is online.
High-High	Set from -32,768...32,767	Select a value so that any value out of range in this field causes a profile validation error. This value also appears in the HH slider on this dialog.
High	Set from -32,768...32,767	Select a value so that any value out of range in this field causes a profile validation error. This value also appears in the HI slider on this dialog.
Low	Set from -32,768...32,767	Select a value so that any value out of range in this field causes a profile validation error. This value also appears in the LO slider on this dialog.
Low-Low	Set from -32,768...32,767	Select a value so that any value out of range in this field causes a profile validation error. This value also appears in the LL slider on this dialog.
Disable All Alarms	Click to check the checkbox	Check the box to disable all alarms. Important: When you disable all alarms, you disable process, and channel diagnostic alarms (for example, underrange and overrange). We recommend that you disable only unused channels so extraneous alarm bits are not set.
Latch Process Alarms	Click to check the checkbox	Check the box to latch an alarm in the set position even if the condition that causes the alarm disappears. Click to unlatch all alarms together. This feature is disabled when offline

2. After the channels are configured, do one of the following:

- Click Apply to store a change but stay on the dialog box to choose another tab.
- Click OK to apply the change and close the dialog box.
- Click Cancel to close the dialog box without applying changes.

Internet Protocol Tab

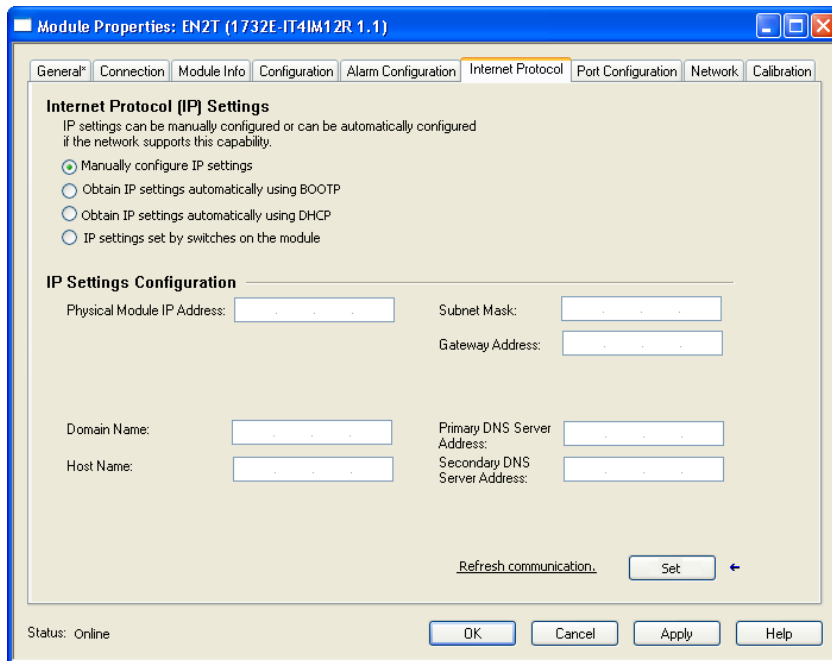

1. To configure your IP settings, click the Internet Protocol tab. This tab is only available for editing when the device is online. To manually configure your IP settings, specify the IP address in the Physical Module IP Address field.
2. On the other fields (Domain Name, Host Name, Primary DNS Server Address, Secondary DNS Server Address), specify the corresponding parameter. Click Set and then click OK.

Port Configuration Tab

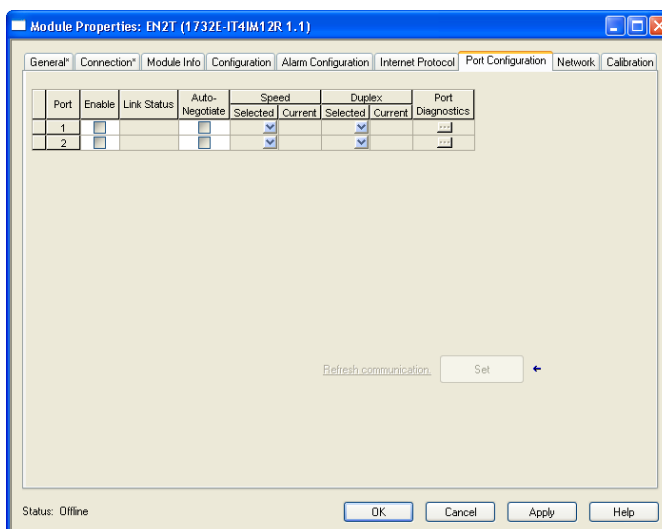

To configure the Ethernet ports, click the Port Configuration tab. This tab is only available for editing when the device is online.

To configure the ports:

To	Then
Use the default port speed and duplex settings	Leave Auto-negotiate port speed and duplex checked. This setting determines the actual speed and duplex setting.
Manually configure your port's speed and duplex settings	Follow these steps. <ol style="list-style-type: none"> 1. Clear the Auto-negotiate port speed and duplex checkbox. 2. From the Current Port Speed pull-down menu, choose a port speed. 3. From the Current Duplex pull-down menu, choose the appropriate Duplex value, that is, Half Duplex or Full Duplex.

IMPORTANT Consider the following when you configure the module's port settings:

- If the module is connected to an unmanaged switch, leave Auto-negotiate port speed and duplex checked or the module will fail.
- If you are forcing the port speed and duplex with a managed switch, the corresponding port of the managed switch must be forced to the same settings or the module will fail.

Calibration Tab

The Calibration tab on the Module Properties dialog box lets you recalibrate the module, if necessary. Calibration corrects any hardware inaccuracies on a particular channel.

Calibration is available on a per-channel basis for both Thermocouple and RTD modules. Calibration points for the Thermocouple module is 0 and 78.125 mV for each channel. For the RTD module, calibration endpoints are dependent on the sensor type configured for each channel.

For a step-by-step guide on how to calibrate your modules, see [Calibrate Your Modules on page 45](#).

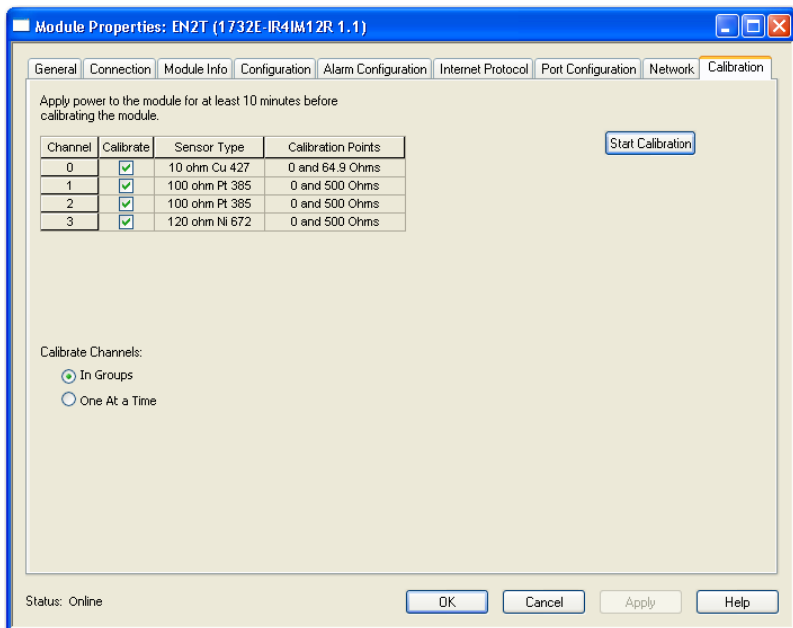
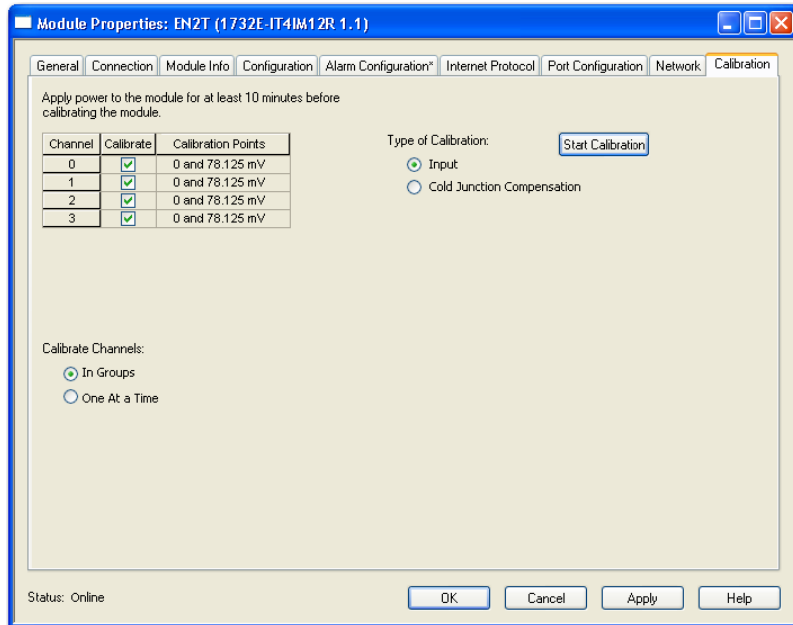

Status and Monitoring Tabs

Although each dialog box maintains importance during online monitoring, some of the tabs, such as the Module Info and Network, are blank during the initial module configuration. You can refer to these tabs

Check the status of your module using these tabs.

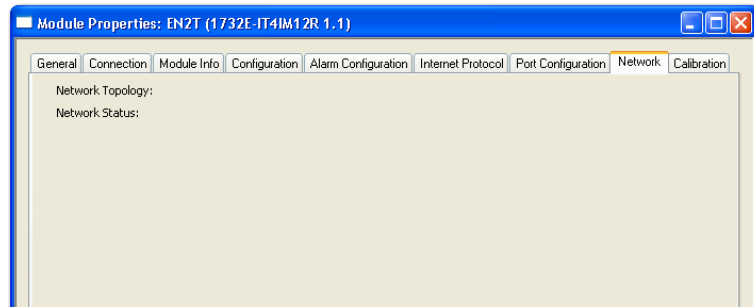
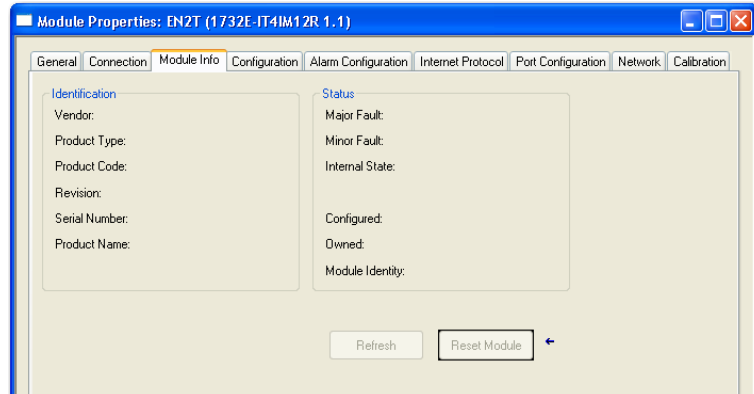

Chapter Summary

This chapter provided instructions on how to configure the 1732E ArmorBlock Thermocouple and RTD modules through the RSLogix 5000 software.

Notes:

Configurable Features for the Thermocouple and RTD Input Modules

Overview

This chapter describes how the different configuration parameters affect the Thermocouple and RTD input channels. It also includes the data structure for both modules.

Topic	Page
Configure Your Input Modules	36
Configurable Options and Their Effect on the Channels	36
Data Tables	39
Chapter Summary	44

The parameters discussed in this chapter can be set through the RSLogix 5000 software. See the previous chapter, *Configure Your Thermocouple and RTD Input Modules with RSLogix 5000 Software*, to learn more about the step-by-step I/O configuration and setup process.

Configure Your Input Modules

The modules are configured using a group of data table words mapped by the processor that is used when the connection to the module is established.

The software configurable features available are:

- sensor type
- temperature units reported in °C, °F
- cold junction compensation enable, mode, and offset (for 1732E-IT4IM12R)
- digital filters

Configurable Options and Their Effect on the Channels

The following features affect the four input channels for the Thermocouple and RTD Input modules.

- Sensor Type
- Temperature Units
- Digital Filter
- Notch Filter⁽¹⁾
- CJC Enable⁽²⁾
- CJC Offset⁽²⁾
- CJC Mode⁽²⁾

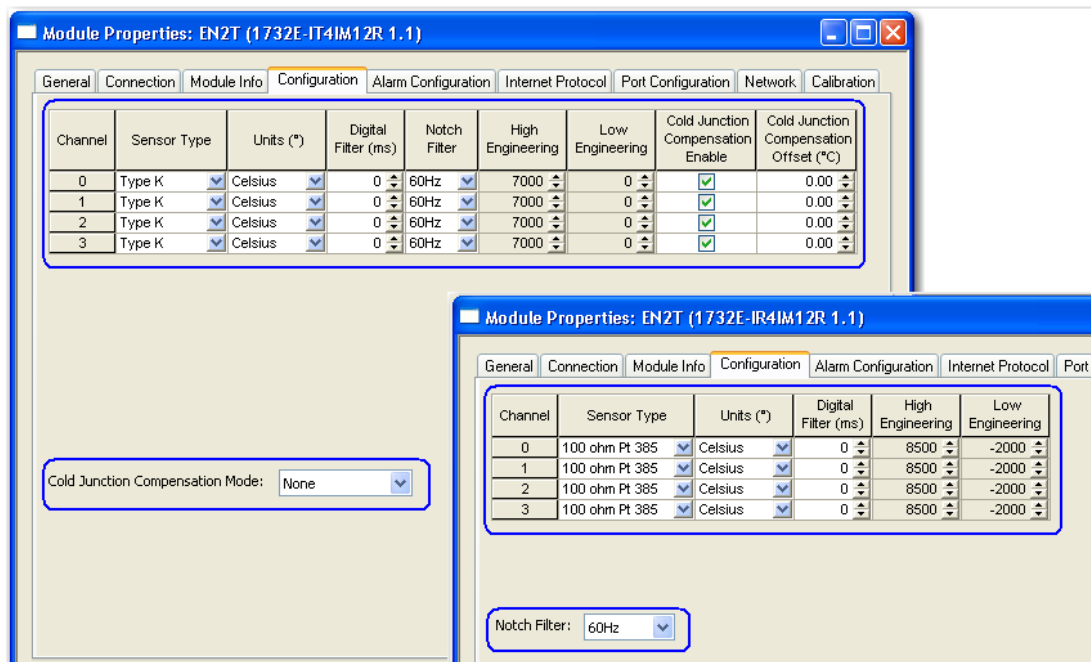

- (1) Notch Filter can be set per channel on the Thermocouple module, and module-wide on the RTD module.
- (2) Available on the 1732E-IT4IM12R Thermocouple module only.

Unless otherwise specified, the following features apply to both 1732E-IT4IM12R and 1732E-IR4IM12R modules.

Sensor Type

This set of bits allows you to select one of nine types for the thermocouple module or one of ten RTD types.

The following sensor type options are available for the Thermocouple and RTD modules.

Supported Sensor Types – 1732E-IT4IM12R

Type	Material	Temperature Range °C (°F)	Voltage Range (mV)
B	Pt /30% Rh vs. Pt/5% Rh	40...1820 °C (104...3308 °F)	0...13.820
C	W/5% Re vs. W/26% Re	0...2320 °C (32...4208 °F)	0...37.107
E	Ni/Cr vs. Cu/Ni	-270...1000 °C (-454...1832 °F)	-9.835...76.373
J	Ni/Cr vs. Cu/Ni	-210...1200 °C (-346...2192 °F)	-8.095...69.553
K	Ni/Cr vs. Ni/Al	-270...1372 °C (-454...2501.6 °F)	-6.458...54.886

Supported Sensor Types – 1732E-IT4IM12R

Type	Material	Temperature Range °C (°F)	Voltage Range (mV)
N	Ni/14.2%Cr/1.4%Si vs. Ni/4.4%Si/0.1%Mg	-270...1300 °C (-454...2372 °F)	-4.345...47.513
R	Pt/13%Rh vs. Pt	-50...1768 °C (-58...3214.4 °F)	-0.226...21.101
S	Pt/10%Rh vs. Pt	-50...1768 °C (-58...3214.4 °F)	-0.236...18.693
T	Cu vs. Cu/Ni	-270...400 °C (-454...752 °F)	-6.258...20.872

Supported Sensor Types – 1732E-IR4IM12R

RTD Type	Temperature Range °C (°F)	Voltage range
100 Ω Pt 385 0...390.48Ω	-200...850 °C (392...1562 °F)	0...156.25 mV
200 Ω Pt 385 0...781Ω	-200...850 °C (-328...1562 °F)	0...312.5 mV
100 Ω Pt 3916 0...337.03Ω	-200...630 °C (-328...1166 °F)	0...156.25 mV
200 Ω Pt 3916 0...674.06Ω	-200...630 °C (-328...1166 °F)	0...312.5 mV
10 Ω Cu 427 0...19.116Ω	-320...500 °C (392...932 °F)	0...19.53 mV
120 Ω Ni 672 0...445.10Ω	-70...445 °C (-94...833 °F)	0...156.25 mV
100 Ω Ni 618 0...198.88Ω	-60...180 °C (-76...356 °F)	0...78.125 mV
120 Ω Ni 618 0...238.65Ω	-90...140 °C (-130...284 °F)	0...78.125mV

Temperature Units

This set of bits allows you to select one of these two formats:

- Degree C (default)
- Degree F

When the Thermocouple sensor type is set to mV or the RTD sensor type is set to Ohms, the temperature unit field is not available.

Notch Filter

An analog-to-digital converter (ADC) filter that removes line noise in your application for each channel.

Choose a notch filter that most closely matches the anticipated noise frequency in your application. Remember that each filter time affects the response time of your module. Also, the highest frequency notch filter settings also limit the effective resolution of the channel.

The following notch filter values can be set per channel on the 1732E-IT4IM12R Thermocouple module and module-wide on the 1732E-IR4IM12R RTD module:

- 50 Hz
- 60 Hz (default)
- 250 Hz
- 500 Hz

Digital Filter

A digital filter can be configured for each of the four channels for both Thermocouple and RTD modules based on a configurable time constant set by the user. The time constant value can be configured up to 10,000 ms. A value of 0 disables the filter and is the default value. The minimum digital filter value is dependent on the selected Notch Filter as shown in the table below.

Minimum and Maximum Digital Filter Values

Notch Filter	Minimum Digital Filter Value (ms) ⁽¹⁾	Maximum Digital Filter Value (ms)
50 Hz 60 Hz	20	10,000
250 Hz	2	10,000
500 Hz	1	10,000

(1) Setting the value as 0 disables the filter. It is the default value.

Cold Junction Compensation (1732E-IT4IM12R only)

Cold junction compensation (CJC) is the temperature at the cold, or reference, point. This value helps determine the temperature at the hot, or measured, point. Two mechanisms can help derive CJC:

- From a user-entered value
- From one or more thermistors attached to the module

In RSLogix 5000, the following parameters configure CJC behavior:

- Cold Junction Compensation Enable (available for each of the 4 channels)
- Cold Junction Compensation Mode (module-wide setting)
- Cold Junction Compensation Offset (available for each of the 4 channels)

TIP Cold Junction Compensation feature is only available for a channel when it is configured as a Thermocouple type. If a channel is set as mV (no linearization), CJC Enable and CJC Offset are not available.

Cold Junction Compensation Enable

The Cold Junction Compensation Enable box on the Module Properties Configuration tab enables cold junction compensation on each of the four

channels. Typically, this option should always be enabled except for systems that have no thermoelectric effect, such as test equipment in a controlled lab.

When this parameter is set for a channel, compensation is derived from one or more thermistors attached to the module. If not set (disabled), compensation will come from a user-entered value (CJC Offset).

In most applications, we recommend that you use the cold junction compensation enable option with the recommended thermistor based terminal blocks attached to the module..

Cold Junction Compensation (CJC) Mode

When CJC is enabled, CJC Mode determines where the temperature measurement source (thermistor) is located. The following options are available for the user:

- Average Selected
- Channel Independent

When CJC Mode is Average Selected, all sensor channels will use an average of the compensation determined by thermistor(s) attached to the user-selected channel(s).

When CJC Mode is Channel Independent, each sensor channel uses the compensation derived from a thermistor attached to the channel.

The produced cold junction compensation data is the temperature value read by the thermistor(s), in °C, which is being applied to the reading on any channel configured for thermistor compensation.

IMPORTANT If a thermistor is not detected from the specified channel(s), the produced cold junction data indicates an error (0x8000) and no compensation is applied.

Cold Junction Compensation Offset

When no thermistor is attached to the module or channel, the user can specify the CJC Offset value to be added to the CJC input during temperature calculation. CJC Offset compensates for any inaccuracies of the CJC sensor. Valid values range from 0...70 °C, with 0 °C as default value.

CJC Offset parameter is enabled for configuration when the CJC Enable parameter is not checked for that channel.

Data Tables

The data structure of each Assembly instance used by the Thermocouple and RTD Input modules is defined in the tables below.

1732E-IT4IM12R – Configuration Data Structure for Thermocouple Input

Configuration Byte	Bit 7	Bit 6	Bit 5	Bit 4	Bit 3	Bit 2	Bit 1	Bit 0
4	Cold Junction Mode ⁽¹⁾							
5...7	Reserved (Ignore)							
8...9	Channel 0 Low Engineering							
10...11	Channel 0 High Engineering							
12	Channel 0 Disable Alarms							
13	Channel 0 Enable Alarm Latch							
14	Channel 0 Notch Filter							
15	Channel 0 Thermocouple Type							
16...17	Channel 0 Digital Filter							
18...19	Channel 0 Low Alarm							
20...21	Channel 0 High Alarm							
22...23	Channel 0 Low Low Alarm							
24...25	Channel 0 High High Alarm							
26	Channel 0 Temperature Units							
27	Channel 0 Cold Junction Compensation Enable							
28...29	Channel 0 Cold Junction Compensation Offset							
30...31	Reserved (Ignore)							
32...33	Channel 1 Low Engineering							
34...35	Channel 1 High Engineering							
36	Channel 1 Disable Alarms							
37	Channel 1 Enable Alarm Latch							
38	Channel 1 Notch Filter							
39	Channel 1 Thermocouple Type							
40...41	Channel 1 Digital Filter							
42...43	Channel 1 Low Alarm							
44...45	Channel 1 High Alarm							
46...47	Channel 1 Low Low Alarm							
48...49	Channel 1 High High Alarm							
50	Channel 1 Temperature Units							
51	Channel 1 Cold Junction Compensation Enable							
52...53	Channel 1 Cold Junction Compensation Offset							
54...55	Reserved (Ignore)							
56...57	Channel 2 Low Engineering							
58...59	Channel 2 High Engineering							
60	Channel 2 Disable Alarms							
61	Channel 2 Enable Alarm Latch							

1732E-IT4IM12R – Configuration Data Structure for Thermocouple Input

Configuration Byte	Bit 7	Bit 6	Bit 5	Bit 4	Bit 3	Bit 2	Bit 1	Bit 0
62	Channel 2 Notch Filter							
63	Channel 2 Thermocouple Type							
64...65	Channel 2 Digital Filter							
66...67	Channel 2 Low Alarm							
68...69	Channel 2 High Alarm							
70...71	Channel 2 Low Low Alarm							
72...73	Channel 2 High High Alarm							
74	Channel 2 Temperature Units							
75	Channel 2 Cold Junction Enable							
76...77	Channel 2 Cold Junction Offset							
78...79	Reserved (Ignore)							
80...81	Channel 3 Low Engineering							
82...83	Channel 3 High Engineering							
84	Channel 3 Disable Alarms							
85	Channel 3 Enable Alarm Latch							
86	Channel 3 Notch Filter							
87	Channel 3 Thermocouple Type							
88...89	Channel 3 Digital Filter							
90...91	Channel 3 Low Alarm							
92...93	Channel 3 High Alarm							
94...95	Channel 3 Low Low Alarm							
96...97	Channel 3 High High Alarm							
98	Channel 3 Temperature Units							
99	Channel 3 Cold Junction Enable							
100...101	Channel 3 Cold Junction Offset							

- (1) Cold Junction Compensation Mode values are:
0 = None, 1 = Channel 1, 2 = Channel 2, 3 = Channel 3, 4 = Channel 4, 5 = Average of all channels with thermistor attached.

1732E-IR4IM12R – Configuration Data Structure for RTD Input

Configuration Byte	Bit 7	Bit 6	Bit 5	Bit 4	Bit 3	Bit 2	Bit 1	Bit 0
4...5	Channel 0 Low Engineering							
6...7	Channel 0 High Engineering							
8...9	Channel 0 Digital Filter							
10...11	Channel 0 Low Alarm							
12...13	Channel 0 High Alarm							
14...15	Channel 0 Low Low Alarm							

1732E-IR4IM12R – Configuration Data Structure for RTD Input

Configuration Byte	Bit 7	Bit 6	Bit 5	Bit 4	Bit 3	Bit 2	Bit 1	Bit 0
16...17	Channel 0 High High Alarm							
18	Channel 0 Enable Alarm Latch							
19	Channel 0 Disable Alarms							
20	Channel 0 RTD Type							
21	Channel 0 Temperature Scale							
22...23	Reserved (Ignore)							
24...25	Channel 1 Low Engineering							
26...27	Channel 1 High Engineering							
28...29	Channel 1 Digital Filter							
30...31	Channel 1 Low Alarm							
32...33	Channel 1 High Alarm							
34...35	Channel 1 Low Low Alarm							
36...37	Channel 1 High High Alarm							
38	Channel 1 Enable Alarm Latch							
39	Channel 1 Disable Alarms							
40	Channel 1 RTD Type							
41	Channel 1 Temperature Scale							
42...43	Reserved (Ignore)							
44...45	Channel 2 Low Engineering							
46...47	Channel 2 High Engineering							
48...49	Channel 2 Digital Filter							
50...51	Channel 2 Low Alarm							
52...53	Channel 2 High Alarm							
54...55	Channel 2 Low Low Alarm							
56...57	Channel 2 High High Alarm							
58	Channel 2 Enable Alarm Latch							
59	Channel 2 Disable Alarms							
60	Channel 2 RTD Type							
61	Channel 2 Temperature Scale							
62...63	Reserved (Ignore)							
64...65	Channel 3 Low Engineering							
66...67	Channel 3 High Engineering							
68...69	Channel 3 Digital Filter							
70...71	Channel 3 Low Alarm							
72...73	Channel 3 High Alarm							
74...75	Channel 3 Low Low Alarm							
76...77	Channel 3 High High Alarm							

1732E-IR4IM12R – Configuration Data Structure for RTD Input

Configuration Byte	Bit 7	Bit 6	Bit 5	Bit 4	Bit 3	Bit 2	Bit 1	Bit 0
78	Channel 3 Enable Alarm Latch							
79	Channel 3 Disable Alarms							
80	Channel 3 RTD Type							
81	Channel 3 Temperature Scale							
82...83	Reserved (Ignore)							
84	Notch Filter							
85	Reserved (Ignore)							

1732E-IT4IM12R – Produced Data Structure for Thermocouple Input

Configuration Byte	Bit 7	Bit 6	Bit 5	Bit 4	Bit 3	Bit 2	Bit 1	Bit 0
0...3	Reserved (must be zero)							
4...5	Channel 0 Data							
6...7	Channel 1 Data							
8...9	Channel 2 Data							
10...11	Channel 3 Data							
12	Channel 0 Status ⁽¹⁾							
13	Channel 1 Status ⁽¹⁾							
14	Channel 2 Status ⁽¹⁾							
15	Channel 3 Status ⁽¹⁾							
16	Cold Junction Temperature Channel 0 (low byte)							
17	Cold Junction Status Channel 0 ⁽²⁾		Cold Junction Temperature Channel 0 (high byte, low 6 bits)					
18	Cold Junction Temperature Channel 1 (low byte)							
19	Cold Junction Status Channel 1 ⁽²⁾		Cold Junction Temperature Channel 2 (high byte, low 6 bits)					
20	Cold Junction Temperature Channel 2 (low byte)							
21	Cold Junction Status Channel 2 ⁽²⁾		Cold Junction Temperature Channel 2 (high byte, low 6 bits)					
22	Cold Junction Temperature Channel 3 (low byte)							
23	Cold Junction Status Channel 3 ⁽²⁾		Cold Junction Temperature Channel 3 (high byte, low 6 bits)					

(1) This parameter is in Byte and has the following structure:

Bit 0 = Fault; Bit 1 = Calibration; Bit 2 = Low Alarm; Bit 3 = High Alarm; Bit 4 = Low Low Alarm; Bit 5 = High High Alarm; Bit 6 = Underrange; Bit 7 = Overrange

(2) Cold junction status is defined below. When a fault is detected, the Cold Junction Temperature is set to zero (thus, a word value of 0xC000 indicates that the cold junction is enabled, but no thermistor data is available).
00 = No fault; 01 = Underrange; 02 = Overrange; 03 = No thermistor detected

1732E-IR4IM12R – Produced Data Structure for RTD Input

Configuration Byte	Bit 7	Bit 6	Bit 5	Bit 4	Bit 3	Bit 2	Bit 1	Bit 0
0...3	Reserved (must be zero)							
4...5	Channel 0 Data							
6...7	Channel 1 Data							
8...9	Channel 2 Data							
10...11	Channel 3 Data							
12	Channel 0 Status ⁽¹⁾							
13	Channel 1 Status ⁽¹⁾							
14	Channel 2 Status ⁽¹⁾							
15	Channel 3 Status ⁽¹⁾							

(1) This parameter is in Byte and has the following structure:
 Bit 0 = Fault; Bit 1 = Calibration; Bit 2 = Low Alarm; Bit 3 = High Alarm; Bit 4 = Low Low Alarm; Bit 5 = High High Alarm; Bit 6 = Underrange; Bit 7 = Overrange

Chapter Summary

This chapter discussed the different configurable features and their effect on all input channels for both Thermocouple and RTD modules.

Calibrate Your Modules

Overview

The Thermocouple and RTD modules are shipped to you calibrated but calibration is also made available through the RSLogix 5000 software should you choose to recalibrate your module to increase accuracy for your specific application.

This chapter shows you how to calibrate your modules through the RSLogix 5000 software. It includes the following topics.

Topic	Page
Calibrate the Thermocouple Module	46
Calibrate the RTD Module	49

IMPORTANT Analog I/O modules can be calibrated on a channel-by-channel basis or with the channels grouped together. Regardless of which option you choose, we recommend you calibrate all channels on your module each time you calibrate. This will help you maintain consistent calibration readings and improve module accuracy.

Calibration is meant to correct any hardware inaccuracies that may be present on a particular channel. The calibration procedure compares a known standard, either input signal or recorded output, with the channel's performance and then calculating a linear correction factor between the measured and the ideal.

The linear calibration correction factor is applied on every input or output same to obtain maximum accuracy.

To maintain your module's accuracy specifications, we recommend you use calibration instruments with specific ranges. The table lists the recommended instruments for the two modules.

Module	Recommended Instrument Range
1732E-IT4IM12R	0 mV...78.125 mV source $\pm 0.3 \mu\text{V}$
1732E-IR4IM12R	0...1000 Ω resistors ⁽¹⁾ $\pm 0.01\%$

(1) We suggest you use these precision resistors.
 KRL Electronics - 534A1-1R0T 1.0 Ohm 0.01% / 534A1-487R0T 487 Ohm 0.01%
 A precision decade resistor box also can be used that meets or exceeds the required accuracy specifications. You are responsible for assuring that the decade box maintains accuracy by periodic calibration.

Calibrate the Thermocouple Module

The 1732E-IT4IM12R module only calibrates in millivolts. You can calibrate the module to a 0...78.125 mV range.

IMPORTANT Apply power to the power supply and module for at least 10 minutes before calibrating the module.

Perform the calibration process through the RSLogix 5000 software.

While you are online, you must access the Calibration tab on the Module Properties dialog box.

1. Click Calibration Tab on the Module Properties dialog box.

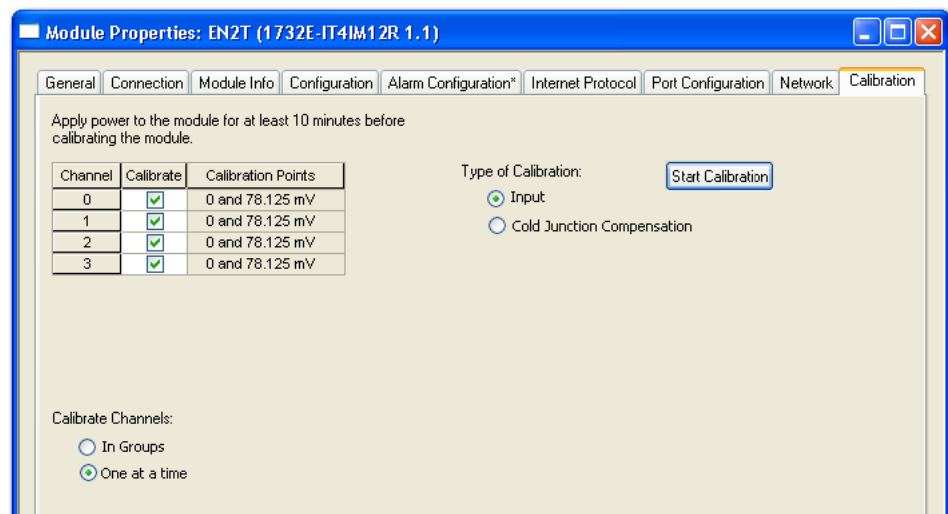

2. Check the Calibrate checkbox to specify which channel to calibrate. In this example, check all channels. Calibration points are automatically set to 0 and 78.125 mV.
3. Under Calibrate Channels select One at a time.
4. Under Type of Calibration, select Input.
5. Click Start Calibration, which is active when:
 - the system is online, and
 - you selected at least one of the channels.

TIP Note that you can press the F1 button on your keyboard or click Help from the wizard and warning message that appear to get detailed information about the procedures for calibration.

6. After clicking Start Calibration, a warning dialog appears notifying you of the risk involved in calibrating an active system and gives you the option to quit.

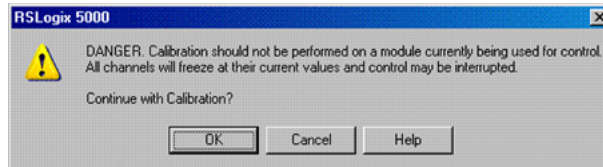

If at least one channel has been selected and there is a mismatch between the device in the RSLogix 5000 I/O Configuration and the actual physical device, another warning dialog comes up. It informs you that this is dangerous with an active system and there is a mismatch. This message box gives you an option to quit. Help is provided to you more information.

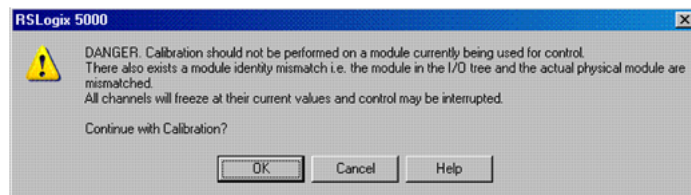

From the Danger dialog, for a module not currently used for control, click OK to continue.

7. The Input Calibration - Low Value dialog appears. Set the calibrator for the low reference and apply it to the module.

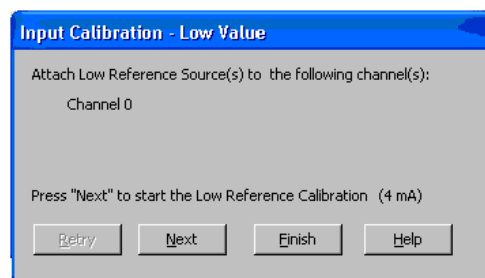

Click Next to start low reference calibration.

- TIP** If several channels have been selected for calibration with One At a Time option enabled, only one channel will appear in the list at the first round (low reference and high reference) of calibration.
- TIP** If calibration is configured to be done In Groups, the Low Value dialog box shows all the channels enabled for calibration.

8. Set the calibrator for the high reference voltage and apply it to the module. The Input Calibration - High Value dialog appears.

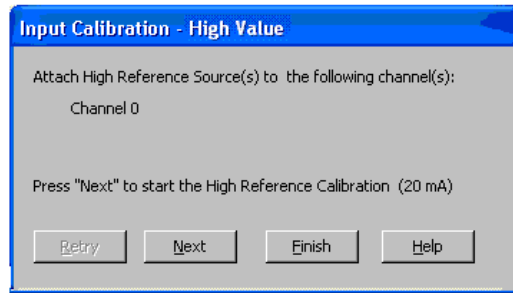

TIP If several channels have been selected for calibration with One At a Time option enabled, only one channel will appear in the list at the first round (low reference and high reference) of calibration.

TIP If calibration is configured to be done In Groups, the High Value dialog box shows all the channels enabled for calibration.

9. From the High Value dialog, click Next to start calibration. The Input Calibration - Results dialog appears. It shows you the results of calibration.

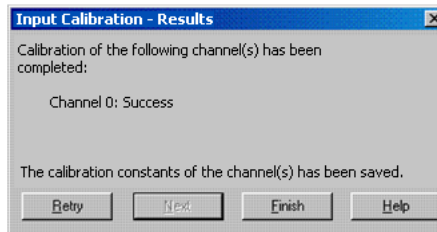

- For failed calibration, go to step [10](#).
- For successful calibration, go to step [11](#).

10. If the calibration failed, click Retry to recalibrate the same channel. This takes you back to steps [6...9](#) until you get successful calibration on the channel.
11. If the calibration is successful, click Next to start calibration on the next channel (in this example, channel 1). This takes you back to steps [6...9](#).
12. After successful calibration on the channel(s), click Finish to close the Calibration Wizard.

TIP Cold junction compensation calibration follows the same steps, with resistance used on the thermistor connections.

Calibrate the RTD Module

The 1732E-IR4IM12R does not calibrate for voltage or current. It uses two precision resistors to calibrate the channels in ohms. The module has a preset calibration points for the sensor type configured for each input channel,

Calibration Points for the RTD Module

RTD Sensor Type	Calibration Points
Ohms	0 and 500 Ohms
100 Ω Pt 385	0 and 500 Ohms
200 Ω Pt 385	0 and 1000 Ohms
100 Ω Pt 3916	0 and 500 Ohms
200 Ω Pt 3916	0 and 1000 Ohms
10 Ω Cu 427	0 and 64.9 Ohms
120 Ω Ni 672	0 and 500 Ohms
100 Ω Ni 618	0 and 250 Ohms
120 Ω Ni 618	0 and 250 Ohms

Perform the calibration process through the RSLogix 5000 software.

While you are online, you must access the Calibration tab on the Module Properties dialog box. See [Edit Your Module Configuration on page 21](#).

1. Click Calibration Tab on the Module Properties dialog box.

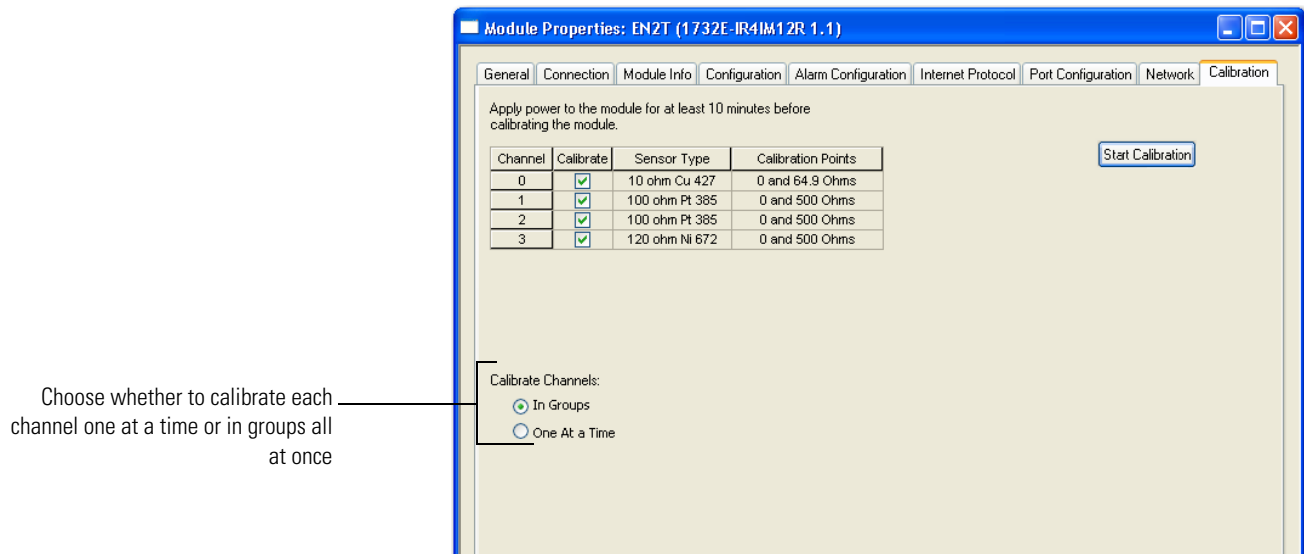

2. Check the Calibrate checkbox to specify which channel to calibrate. In this example, check Channels 0...3.
3. Under Calibrate Channels select One At a Time.
4. Click Start Calibration, which is active when:
 - the system is online, and
 - you selected at least one of the channels.

Note that you can press the F1 button on your keyboard or click Help from the wizard and warning message that appear to get detailed information about the procedures for calibration.

5. After clicking Start Calibration, a warning dialog appears notifying you of the risk involved in calibrating an active system and gives you the option to quit.

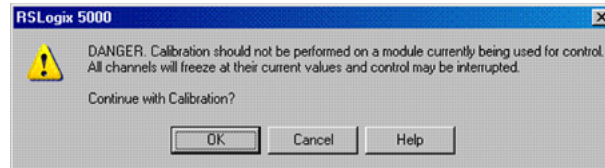

If at least one channel has been selected and there is a mismatch between the device in the RSLogix 5000 I/O Configuration and the actual physical device, another warning dialog comes up. It informs you that this is dangerous with an active system and there is a mismatch. This message box gives you an option to quit. Help is provided to you more information.

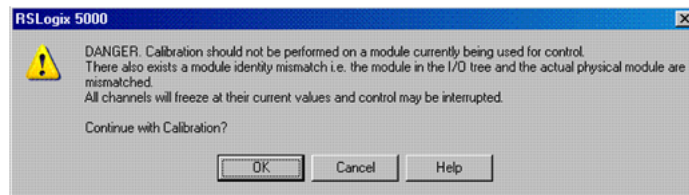

From the Danger dialog, for a module not currently used for control, click OK to continue.

6. The Low Value dialog appears. Set the calibrator for the low reference and apply it to the module.

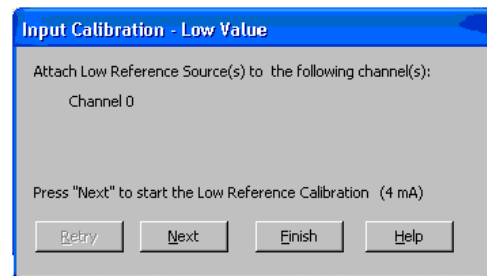

Click Next to start low reference calibration.

TIP If several channels have been selected for calibration with One At a Time option enabled, only one channel will appear in the list at the first round (low reference and high reference) of calibration.

TIP If calibration is configured to be done In Groups, the Low Value dialog box shows all the channels enabled for calibration.

7. Set the calibrator for the high reference voltage and apply it to the module. The High Value dialog appears.

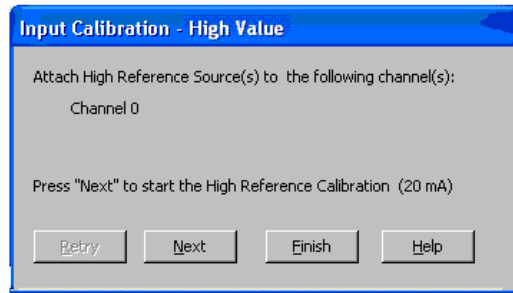

- TIP** If several channels have been selected for calibration with One At a Time option enabled, only one channel will appear in the list at the first round (low reference and high reference) of calibration.
- TIP** If calibration is configured to be done In Groups, the High Value dialog box shows all the channels enabled for calibration.
8. From the High Value dialog, click Next to start calibration. The Input Calibration - Results dialog appears. It shows you the results of calibration.

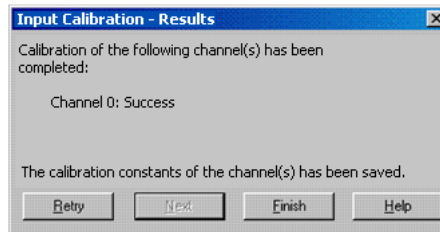

- For failed calibration, go to step [9](#).
 - For successful calibration, go to step [11](#).
9. If the calibration failed, click Retry to recalibrate the same channel. This takes you back to steps [6...8](#) until you get successful calibration on the channel.
 10. If the calibration is successful, click Next to start calibration on the next channel (in this example, channel 1). This takes you back to steps [6...8](#). You will have to go through the same cycle of steps for each of the next channels lined up for calibration.
 11. After successful calibration on the channel(s), click Finish to close the Calibration Wizard.

Chapter Summary

This chapter provided instructions on how to calibrate the ArmorBlock Thermocouple and RTD modules.

Notes:

Troubleshoot the Module

This chapter describes the different status indicators available in the 1732E-IT4IM12R and 1732E-IR4IM12R modules and how to interpret these indicators to help troubleshoot the modules. It also includes a section on how to check your module for faults through the RSLogix 5000 software.

Interpret Status Indicators

The 1732E-IT4IM12R and 1732E-IR4IM12R modules have the following status indicators:

- Network, Module, and Link status indicators for EtherNet/IP
- Auxiliary power status indicator
- Individual I/O status indicators for inputs

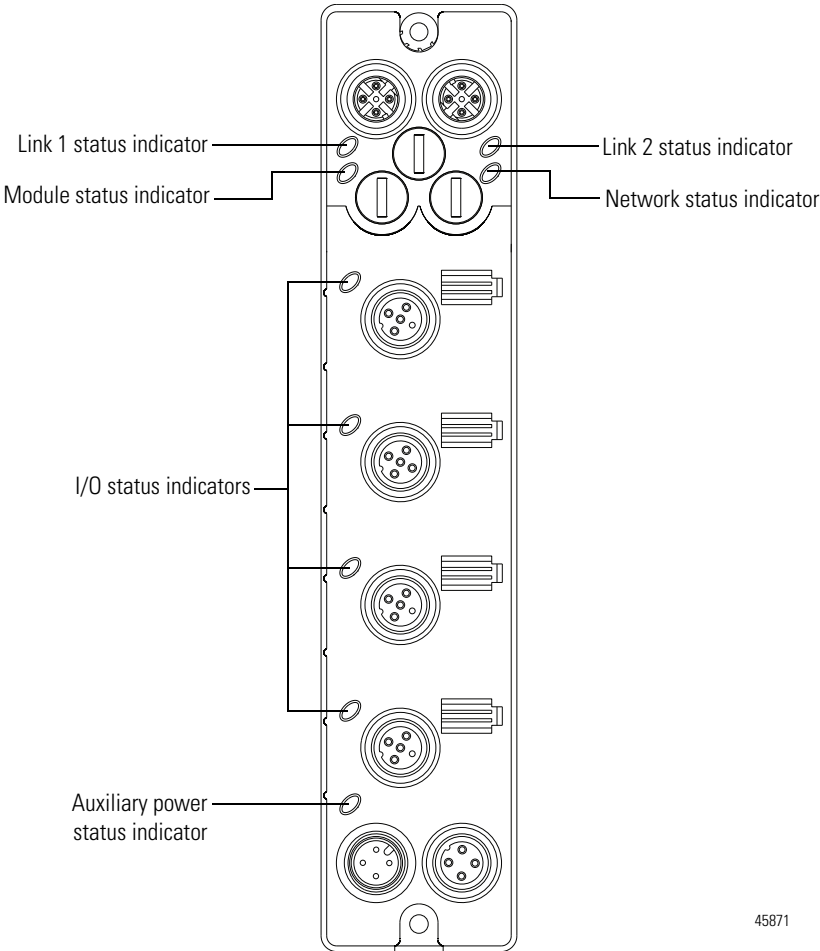

45871

Indicator Status for the Modules

Indicator	Status	Description
Module status	Off	No power applied to the device.
	Flashing red/green	The module is performing POST (Power-On Self Test), which completes within 30 s.
	Green	Device operating normally.
	Flashing red	Module has experienced a recoverable fault. Possible minor faults include the following: <ul style="list-style-type: none"> • IP Address switches do not match configuration in use. • The device has completed a reset to factory default request due to the switches being set to 888 at power up, and a power cycle is required. • The device is performing a firmware flash update. • Channel fault • No auxiliary power
	Red	Unrecoverable fault – may require device replacement.
Network status	Off	The device is not initialized or the module does not have an IP address.
	Flashing green	The device has no CIP connections. The device has an IP address, but no CIP connections are established.
	Green	Device is online, has an IP address. CIP connections are established.
	Flashing red	One or more connections have timed out.
	Red	The module has detected that its IP address is already in use.
	Flashing red/green	The module is performing a power-on self test (POST).
Network link status (Link 1/Link 2)	Off	No link established.
	Green	Link established on indicated port at 100 Mbps.
	Flashing green	Link activity present on indicated port at 100 Mbps.
	Yellow	Link established on indicated port at 10 Mbps.
	Flashing yellow	Link activity present on indicated port at 10 Mbps.
Auxiliary Power status	Off	Auxiliary power off or not connected.
	Green	Auxiliary Power applied to device.
I/O status	Off	The input channel is inactive, can be calibrated.
	Flashing Green	Channel is calibrating.
	Green	Normal operation, inputs being scanned.
	Flashing Yellow	Thermistor fault.
	Flashing Red	Fault. Overrange, underrange, or process alarm is present.
	Red	No power is detected.

Check for Faults

In addition to the status indicators on the module, RSLogix 5000 software alerts you to fault and other conditions in one of three ways:

- Warning signal on the main screen next to the module – This occurs when the connection to the module is broken.



Warning icon appears when a communications fault occurs or if the module is inhibited

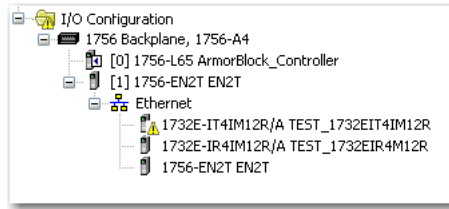

Warning signal – The module has a communications fault

- Message in a screen's status line.

Status line provides information on the module fault and on the connection to the module

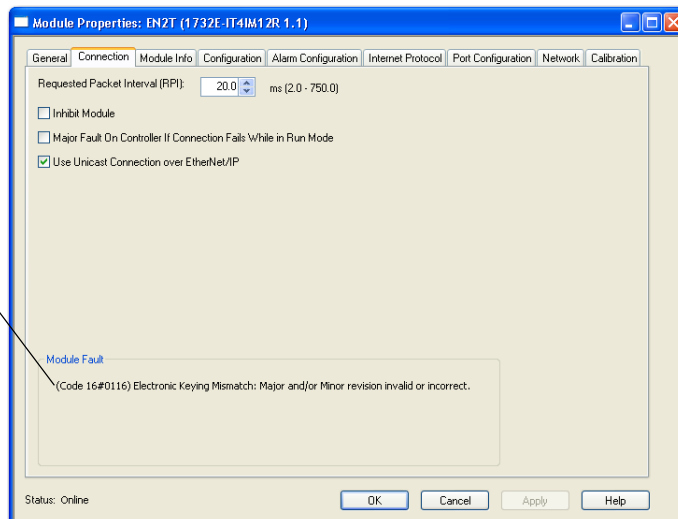

- Notification in the Tag Monitor – General module faults are also reported in the Tag Monitor. Communication faults are reported in the input tags.

RSLogix 5000 software generates 1 s in response to a module communication fault. In this example, a communication fault occurred between the controller and the module, so the controller automatically writes 1 s for all bits in the word.

Name	Value	Force Mask
TEST_1732EIT4IM12R:I	{...}	{...}
TEST_1732EIT4IM12R:I.Ch0Calibration	0	
TEST_1732EIT4IM12R:I.Ch0Data	2#0000_0000_0000_0000_0000	
TEST_1732EIT4IM12R:I.Ch0Fault	2#0000_0000_0000_0000_0000_0000	
TEST_1732EIT4IM12R:I.Ch0HAlarm	0	
TEST_1732EIT4IM12R:I.Ch0HAlarm	0	
TEST_1732EIT4IM12R:I.Ch0LAlarm	0	
TEST_1732EIT4IM12R:I.Ch0LLAlarm	0	
TEST_1732EIT4IM12R:I.Ch0Verrange	0	
TEST_1732EIT4IM12R:I.Ch0Underange	0	
TEST_1732EIT4IM12R:I.Ch1Calibration	0	
TEST_1732EIT4IM12R:I.Ch1Data	0	
TEST_1732EIT4IM12R:I.Ch1Fault	0	
TEST_1732EIT4IM12R:I.Ch1HAlarm	0	
TEST_1732EIT4IM12R:I.Ch1HAlarm	0	
TEST_1732EIT4IM12R:I.Ch1LAlarm	0	
TEST_1732EIT4IM12R:I.Ch1LLAlarm	0	
TEST_1732EIT4IM12R:I.Ch1Verrange	0	

Notes:

Specifications

General Specifications

The 1732E ArmorBlock Thermocouple and RTD Input Modules have the following general specifications.

General Specifications

Attributes	Value
Voltage, power, max	30V DC
Voltage, power, min	12V DC
Module power	12...30V DC @ 300 mA
Power consumption	3 W @ 24V DC, typical 3.5 W, max (module unloaded)
Isolation voltage	50V (continuous), Basic Insulation Type Type tested @ 707V DC for 60 s
Communication rate	EtherNet/IP 10/100 Mbps Full or half-duplex 100 meter per segment
Status indicators	Module status – red/green Network status – red/green Link status – green/yellow Auxiliary power status – green I/O LED – red/green
Dimensions, approx., HxWxD	179 x 37 x 27 mm (7.05 x 1.46 x 1.06 in.)
Weight, approx.	0.34 kg (0.75 lb)
Wiring category ⁽¹⁾	1 – on signal ports 1 – on power ports 1 – on communication ports

(1) Use this Conductor Category information for planning conductor routing. Refer to publication [1770-4.1](#), Industrial Automation Wiring and Grounding Guidelines.

Input Specifications

The 1732E-IT4IM12R Thermocouple input module has the following input specifications.

Input Specifications – 1732E-IT4IM12R

Attributes	Value
Number of inputs	4, isolated
Resolution, min	16 bits
Data format	Signed integer

Input Specifications – 1732E-IT4IM12R

Attributes	Value																																								
Thermocouple types	<table border="1"> <thead> <tr> <th>Type</th> <th>Material</th> <th>Temperature Range °C (°F)</th> <th>Voltage Range (mV)</th> </tr> </thead> <tbody> <tr> <td>B</td> <td>Pt /30% Rh vs. Pt/ 5% Rh</td> <td>40...1820 (104...3308)</td> <td>0...13.820</td> </tr> <tr> <td>C</td> <td>W/5% Re vs. W/ 26% Re</td> <td>0...2320 (32...4208)</td> <td>0...37.107</td> </tr> <tr> <td>E</td> <td>Ni/Cr vs. Cu/Ni</td> <td>-270...1000 (-454...1832)</td> <td>-9.835...76.373</td> </tr> <tr> <td>J</td> <td>Ni/Cr vs. Cu/Ni</td> <td>-210...1200 (-346...2192)</td> <td>-8.095...69.553</td> </tr> <tr> <td>K</td> <td>Ni/Cr vs. Ni/Al</td> <td>-270...1372 (-454...2501.6)</td> <td>-6.458...54.886</td> </tr> <tr> <td>N</td> <td>Ni/14.2%Cr/1.4%Si vs. Ni/4.4%Si/ 0.1%Mg</td> <td>-270...1300 (-454...2372)</td> <td>-4.345...47.513</td> </tr> <tr> <td>R</td> <td>Pt/13%Rh vs. Pt</td> <td>-50...1768 (-58...3214.4)</td> <td>-0.226...21.101</td> </tr> <tr> <td>S</td> <td>Pt/10%Rh vs. Pt</td> <td>-50...1768 (-58...3214.4)</td> <td>-0.236...18.693</td> </tr> <tr> <td>T</td> <td>Cu vs. Cu/Ni</td> <td>-270...400 (-454...752)</td> <td>-6.258...20.872</td> </tr> </tbody> </table>	Type	Material	Temperature Range °C (°F)	Voltage Range (mV)	B	Pt /30% Rh vs. Pt/ 5% Rh	40...1820 (104...3308)	0...13.820	C	W/5% Re vs. W/ 26% Re	0...2320 (32...4208)	0...37.107	E	Ni/Cr vs. Cu/Ni	-270...1000 (-454...1832)	-9.835...76.373	J	Ni/Cr vs. Cu/Ni	-210...1200 (-346...2192)	-8.095...69.553	K	Ni/Cr vs. Ni/Al	-270...1372 (-454...2501.6)	-6.458...54.886	N	Ni/14.2%Cr/1.4%Si vs. Ni/4.4%Si/ 0.1%Mg	-270...1300 (-454...2372)	-4.345...47.513	R	Pt/13%Rh vs. Pt	-50...1768 (-58...3214.4)	-0.226...21.101	S	Pt/10%Rh vs. Pt	-50...1768 (-58...3214.4)	-0.236...18.693	T	Cu vs. Cu/Ni	-270...400 (-454...752)	-6.258...20.872
Type	Material	Temperature Range °C (°F)	Voltage Range (mV)																																						
B	Pt /30% Rh vs. Pt/ 5% Rh	40...1820 (104...3308)	0...13.820																																						
C	W/5% Re vs. W/ 26% Re	0...2320 (32...4208)	0...37.107																																						
E	Ni/Cr vs. Cu/Ni	-270...1000 (-454...1832)	-9.835...76.373																																						
J	Ni/Cr vs. Cu/Ni	-210...1200 (-346...2192)	-8.095...69.553																																						
K	Ni/Cr vs. Ni/Al	-270...1372 (-454...2501.6)	-6.458...54.886																																						
N	Ni/14.2%Cr/1.4%Si vs. Ni/4.4%Si/ 0.1%Mg	-270...1300 (-454...2372)	-4.345...47.513																																						
R	Pt/13%Rh vs. Pt	-50...1768 (-58...3214.4)	-0.226...21.101																																						
S	Pt/10%Rh vs. Pt	-50...1768 (-58...3214.4)	-0.236...18.693																																						
T	Cu vs. Cu/Ni	-270...400 (-454...752)	-6.258...20.872																																						
Cold junction compensation	Rockwell Automation 871A-TS4CJC-DM, 871A-TR4CJC-DM																																								
Cold junction compensation range	0...70 °C (32...158 °F) for 302 type thermistors																																								
Thermistor types supported	Thermometrics MF65F302V/W or DC95F302V/W																																								
Input voltage range	±78 mV, 1 mW																																								
Accuracy	0.1% Full Scale @ 25 °C (77 °F)																																								
Accuracy drift with temperature	30 ppm % Full Scale /°C @ 25 °C (77 °F)																																								
Calibration	Factory calibrated. Calibration is also supported through RSLogix 5000.																																								
Common mode rejection rate	120 dB @ 50/60 Hz																																								
Normal mode rejection rate	100 dB @ 50/60 Hz																																								
Sample Rate Filters ⁽¹⁾	50 Hz 60 Hz 250 Hz 500 Hz																																								

(1) Sample Rate/Notch Filter Frequency, selectable per channel.

The 1732E-IR4IM12R RTD input module has the following input specifications.

Input Specifications – 1732E-IR4IM12R

Attributes	Value
Number of inputs	4, isolated
Resolution, min	16 bits

Input Specifications – 1732E-IR4IM12R

Attributes	Value																																				
Data format	16-bit sign magnitude																																				
Sensors supported	100...200 Ω $\alpha=0.00385/0.003916$ Pt RTD 100/120 Ω Ni RTD 10 Ω Cu $\alpha=0.00427$ RTD																																				
Sensor Types	100 Ω Pt 385 200 Ω Pt 385 100 Ω Pt 3916 200 Ω Pt 3916 10 Ω Cu 427 120 Ω Ni 672 100 Ω Ni 618 120 Ω Ni 618																																				
Input range	<table border="1"> <thead> <tr> <th>RTD type</th> <th></th> <th>Temperature Range (°C)</th> <th>Voltage Range</th> </tr> </thead> <tbody> <tr> <td>100 Ω Pt 385</td> <td>0...390.48 Ω</td> <td>-200...850 °C</td> <td>0...156.25 mV</td> </tr> <tr> <td>200 Ω Pt 385</td> <td>0...781 Ω</td> <td>-200...850 °C</td> <td>0...312.5 mV</td> </tr> <tr> <td>100 Ω Pt 3916</td> <td>0...337.03 Ω</td> <td>-200...630 °C</td> <td>0...156.25 mV</td> </tr> <tr> <td>200 Ω Pt 3916</td> <td>0...674.06 Ω</td> <td>-200...630 °C</td> <td>0...312.5 mV</td> </tr> <tr> <td>10 Ω Cu 427</td> <td>0...19.116 Ω</td> <td>-320...500 °C</td> <td>0...19.53 mV</td> </tr> <tr> <td>120 Ω Ni 672</td> <td>0...445.10 Ω</td> <td>-70...445 °C</td> <td>0...156.25 mV</td> </tr> <tr> <td>100 Ω Ni 618</td> <td>0...198.88 Ω</td> <td>-60...180 °C</td> <td>0...78.125 mV</td> </tr> <tr> <td>120 Ω Ni 618</td> <td>0...238.65 Ω</td> <td>-90...140 °C</td> <td>0...78.125mV</td> </tr> </tbody> </table>	RTD type		Temperature Range (°C)	Voltage Range	100 Ω Pt 385	0...390.48 Ω	-200...850 °C	0...156.25 mV	200 Ω Pt 385	0...781 Ω	-200...850 °C	0...312.5 mV	100 Ω Pt 3916	0...337.03 Ω	-200...630 °C	0...156.25 mV	200 Ω Pt 3916	0...674.06 Ω	-200...630 °C	0...312.5 mV	10 Ω Cu 427	0...19.116 Ω	-320...500 °C	0...19.53 mV	120 Ω Ni 672	0...445.10 Ω	-70...445 °C	0...156.25 mV	100 Ω Ni 618	0...198.88 Ω	-60...180 °C	0...78.125 mV	120 Ω Ni 618	0...238.65 Ω	-90...140 °C	0...78.125mV
RTD type		Temperature Range (°C)	Voltage Range																																		
100 Ω Pt 385	0...390.48 Ω	-200...850 °C	0...156.25 mV																																		
200 Ω Pt 385	0...781 Ω	-200...850 °C	0...312.5 mV																																		
100 Ω Pt 3916	0...337.03 Ω	-200...630 °C	0...156.25 mV																																		
200 Ω Pt 3916	0...674.06 Ω	-200...630 °C	0...312.5 mV																																		
10 Ω Cu 427	0...19.116 Ω	-320...500 °C	0...19.53 mV																																		
120 Ω Ni 672	0...445.10 Ω	-70...445 °C	0...156.25 mV																																		
100 Ω Ni 618	0...198.88 Ω	-60...180 °C	0...78.125 mV																																		
120 Ω Ni 618	0...238.65 Ω	-90...140 °C	0...78.125mV																																		
Input resistance	0...1000 Ω 300 mV, 5 mW																																				
Accuracy	0.1% Full Scale @ 25 °C (77 °F)																																				
Accuracy drift with temperature	30 ppm % Full Scale /°C @ 25 °C (77 °F)																																				
Calibration	Factory calibrated. Calibration is also supported through RSLogix 5000.																																				
Sample Rate Filters ⁽¹⁾	50 Hz 60 Hz 250 Hz 500 Hz																																				
Common Mode Rejection Ratio	120 dB @ 50/60 Hz																																				
Normal Mode Rejection Ratio	100 dB @ 50/60 Hz																																				

(1) Sample rate filter selectable on a module basis only.

Environmental Specifications

The 1732E ArmorBlock Thermocouple and RTD Input Modules have the following environmental specifications.

Environmental Specifications

Attribute	Value
Temperature, operating	IEC 60068-2-1 (Test Ad, Operating Cold), IEC 60068-2-2 (Test Bd, Operating Dry Heat), IEC 60068-2-14 (Test Nb, Operating Thermal Shock): -20...60 °C (-4...140 °F)
Temperature, nonoperating	IEC 60068-2-1 (Test Ab, Unpackaged Nonoperating Cold), IEC 60068-2-2 (Test Bb, Unpackaged Nonoperating Dry Heat), IEC 60068-2-14 (Test Na, Unpackaged Nonoperating Thermal Shock): -40...85 °C (-40...185 °F)
Temperature, ambient, max	60 °C (140 °F)
Relative humidity	IEC 60068-2-30 (Test Db, Unpackaged Damp Heat): 5...95% noncondensing
Vibration	IEC60068-2-6 (Test Fc, Operating): 5 g @ 10...500 Hz
Shock, operating	IEC60068-2-27 (Test Ea, Unpackaged Shock): 30 g
Shock, nonoperating	IEC60068-2-27 (Test Ea, Unpackaged Shock): 50 g
Emissions	CISPR 11: Group 1, Class A
ESD immunity	IEC 61000-4-2: 6 kV contact discharges 8 kV air discharges
Radiated RF immunity	IEC 61000-4-3: 10V/m with 1 kHz sine-wave 80% AM from 80...2000 MHz 10V/m with 200 Hz 50% Pulse 100% AM @ 900 MHz 10V/m with 200 Hz 50% Pulse 100% AM @ 1890 MHz 10V/m with 1 kHz sine-wave 80% AM from 2000...2700 MHz
EFT/B immunity	IEC 61000-4-4: ±3 kV @ 5 kHz on power ports ±3 kV @ 5 kHz on signal ports ±3 kV @ 5 kHz on communication ports
Surge transient immunity	IEC 61000-4-5: ±2 kV line-line (DM) and ±2 kV line-earth (CM) on power ports ±500V line-line (DM) and ±1 kV line-earth (CM) on signal ports ±2 kV line-earth (CM) on communication ports
Conducted RF immunity	IEC 61000-4-6: 10V rms with 1 kHz sine-wave 80% AM from 150 kHz...80 MHz
Enclosure type rating	Meets IP65/66/67/69K (when marked)

Certifications

The 1732E ArmorBlock Thermocouple and RTD Input Modules have the following certifications.

Certifications

Certification (when product is marked)⁽¹⁾	Value
c-UR-us	UL Recognized Component Industrial Control Equipment, certified for US and Canada. See UL File E322657.
CE	European Union 2004/108/EC EMC Directive, compliant with: EN 61326-1; Meas./Control/Lab., Industrial Requirements EN 61000-6-2; Industrial Immunity EN 61000-6-4; Industrial Emissions EN 61131-2; Programmable Controllers (Clause 8, Zone A & B)
C-Tick	Australian Radiocommunications Act, compliant with: AS/NZS CISPR 11; Industrial Emissions
KC	Korean Registration of Broadcasting and Communications Equipment, compliant with: Article 58-2 of Radio Waves Act, Clause 3
EtherNet/IP	ODVA conformance tested to EtherNet/IP specifications.

(1) See the Product Certification link at <http://www.ab.com> for Declarations of Conformity, Certificates, and other certification details.

Notes:

1732E ArmorBlock Embedded Web Server

Introduction

Rockwell Automation offers enhanced 1732E ArmorBlock for your EtherNet/IP control systems so you can monitor data remotely via web pages.

This chapter shows how you can use the module's web server.

Topic	Page
Typical Applications	63
Browser Requirements	63
Access the Home Page of the Web Server	64
Log On to the Web Server	64
Navigate the 1732E ArmorBlock I/O	65

Typical Applications

The module provides access to internal and network diagnostics. This access opens up different, remote access applications to control systems. Use the ArmorBlock I/O web browser to remotely access module data. Use a web browser to monitor live module data and access diagnostic information.

Browser Requirements

You can access the 1732E ArmorBlock I/O web pages only with Internet Explorer 6.0 or higher. To access data view pages, the browser requires Javascript support.

The supported display size is 640 x 480 or greater. Smaller display sizes work but might require extensive scrolling to view the information.

Access the Home Page of the Web Server

From your web browser, enter the IP address of the 1732E ArmorBlock module. The module displays its home page.

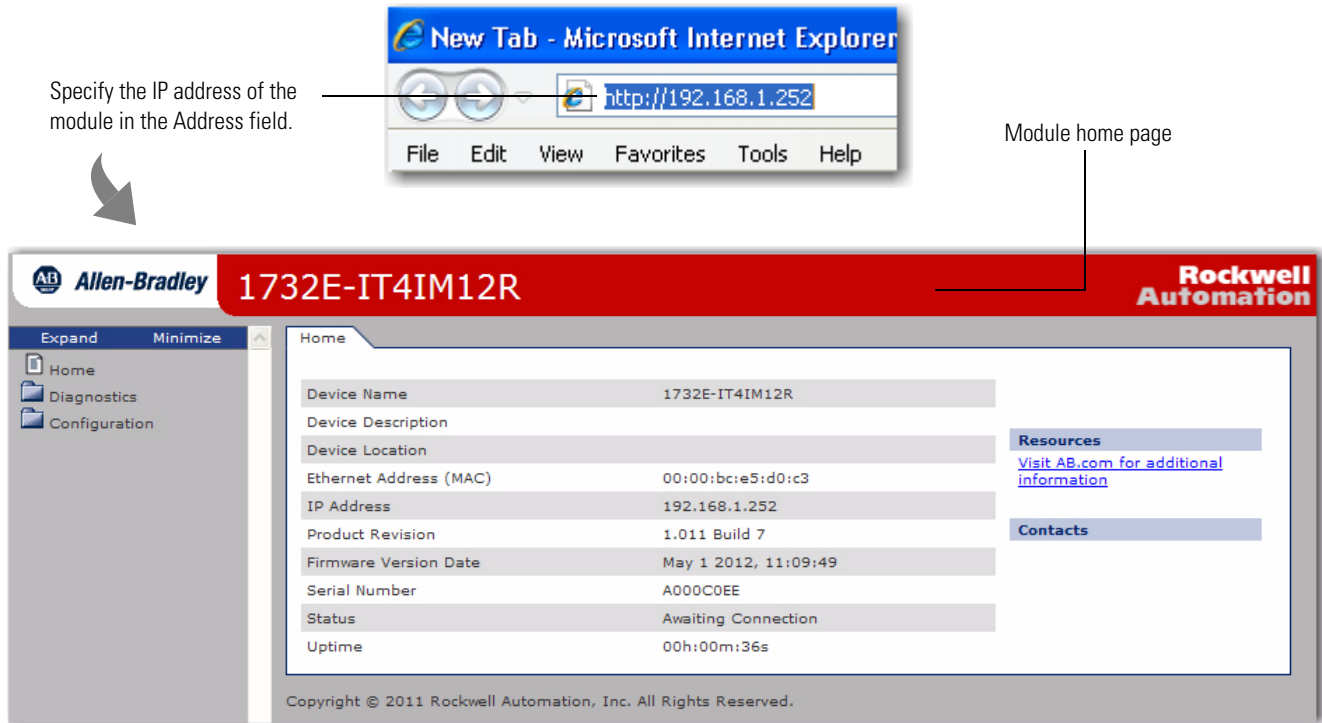

Log On to the Web Server

Many of the features of the 1732E ArmorBlock I/O require you to log on with appropriate access. If you select a feature, such as Configuration, the 1732E ArmorBlock I/O prompts you to enter your user name and password. The user name is Administrator. The default password is blank. Both are case sensitive.

Default Access
 User Name: administrator
 Password: <blank>

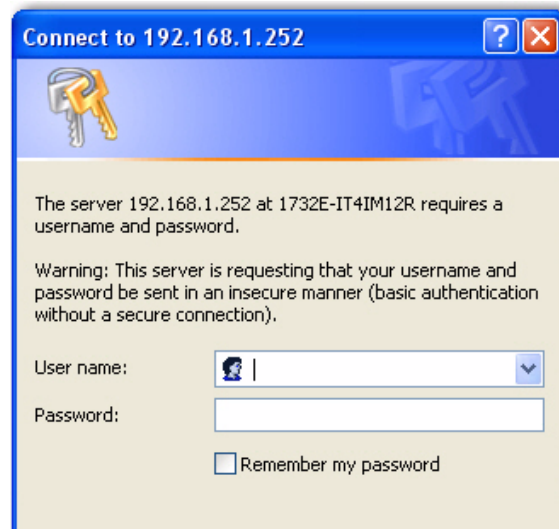

Navigate the 1732E ArmorBlock I/O

You navigate the web server pages by using the navigation panel on the left of the screen. There are also tabs across the top you can use to navigate the sections within folders.

Tabs across the top match the documents within a folder, as shown in the left navigation panel.

Click folders to open and close additional levels of information.

Click a document to display a web page showing specific information.

The screenshot displays the Allen-Bradley 1732E-IT4IM12R web server interface. The top navigation bar includes tabs for 'Diagnostic Overview', 'Network Settings', 'Ethernet Statistics', and 'I/O Connections'. The left navigation panel shows a tree structure with folders and documents. The main content area is divided into several sections:

Ring Status		Module Settings	
Network Topology	Linear	Switches	252
Network Status	Normal		
Ring Supervisor	0.0.0.0 00:00:00:00:00:00		

System Resource Utilization	
CPU Utilization	6%
Module Uptime	00h:05m:01s

CIP Connection Statics	
Current CIP Msg Connections	0
CIP Msg Connection Limit	10
Max Msg Connections Observed	0
Current CIP I/O Connections	0
CIP I/O Connection Limit	15
Max I/O Connections Observed	0
Conn Opens	0
Open Errors	0
Conn Closes	0
Conn Timeouts	0

Seconds Between Refresh: Disable Refresh with 0.

Access Diagnostic Information

You can view specific diagnostic information by clicking Diagnostic Overview on the navigational panel on the left.

Click the Diagnostics folder to expand the navigation, then click the Diagnostic Overview page.

View diagnostic information such as Ring Status, System Resource Utilization, and CIP Connection Statistics.

The screenshot shows the Allen-Bradley 1732E-IT4IM12R diagnostic overview page. The left navigation pane has 'Diagnostics' expanded, with 'Diagnostic Overview' selected. The main content area displays the following information:

Ring Status		Module Settings	
Network Topology	Linear	Switches	252
Network Status	Normal		
Ring Supervisor	0.0.0.0 00:00:00:00:00:00		

System Resource Utilization	
CPU Utilization	6%
Module Uptime	00h:05m:01s

CIP Connection Statics	
Current CIP Msg Connections	0
CIP Msg Connection Limit	10
Max Msg Connections Observed	0
Current CIP I/O Connections	0
CIP I/O Connection Limit	15
Max I/O Connections Observed	0
Conn Opens	0
Open Errors	0
Conn Closes	0
Conn Timeouts	0

Seconds Between Refresh: Disable Refresh with 0.

Access Configuration Information

You can also view configuration information through the Web Server pages. Click Configuration folder.

Click the Configuration folder to expand the navigation.

You can view and edit Device Identity, Network Configuration and Device Services information.

The screenshot shows the Allen-Bradley 1732E-IT4IM12R configuration page. The left navigation pane has 'Configuration' expanded, with 'Device Identity', 'Network Configuration', and 'Device Services' visible. The main content area displays the following information:

Device Information	
Device Name	<input type="text" value="1732E-IT4IM12R"/>
Device Description	<input type="text"/>
Device Location	<input type="text"/>

Note: Values on this page are in non-volatile memory. Changes to these parameters do not take effect until this device has been reset or powered up.

Copyright © 2011 Rockwell Automation, Inc. All Rights Reserved.

Module Tag Definitions

The 1732E-IT4IM12R and 1732E-IR4IM12R modules have two sets of tags:

- Configuration
- Input

Module Tags for 1732E-IT4IM12R

Input Tags (1732E-IT4IM12R)

Tag Name	Data Type	Definition
I.Fault	DINT	Collection of all module level fault bits
I.Ch0Data I.Ch1Data I.Ch2Data I.Ch3Data	INT	The channel input signal represented in counts where -32,768 counts is the minimum detectable input signal and 32,767 counts is the maximum detectable.
I.Ch0Fault I.Ch1Fault I.Ch2Fault I.Ch3Fault	BOOL	Individual channel fault status bit. Indicates a 'hard' fault has occurred on the channel that means: calibration is ongoing; or if an input, an overrange or underrange condition is present. These bits also are set by the controller if communication is lost with the I/O module.
I.Ch0Calibration I.Ch1Calibration I.Ch2Calibration I.Ch3Calibration	BOOL	Indicates if calibration is currently in progress on a channel.
I.Ch0LAlarm I.Ch1LAlarm I.Ch2LAlarm I.Ch3LAlarm	BOOL	Low alarm bits that set when the input signal moves beneath the configured low alarm trigger point, Ch<0...3>LAlarmLimit. Remains set until the input signal moves above the trigger point, unless latched via Ch<0...3>LimitAlarmLatch.
I.Ch0HAlarm I.Ch1HAlarm I.Ch2HAlarm I.Ch3HAlarm	BOOL	High alarm bit that sets when the input signal moves above the configured high alarm trigger point, HAlarmLimit. Remains set until the input signal moves below the trigger point, unless latched via Ch0LimitAlarmLatch of the high alarm trigger point.
I.Ch0LLAlarm I.Ch1LLAlarm I.Ch2LLAlarm I.Ch3LLAlarm	BOOL	Low low alarm bit that sets when the input signal moves beneath the configured low low alarm trigger point, Ch<0...3>LLAlarmLimit. Remains set until the input signal moves above the trigger point, unless latched via Ch<0...3>LimitAlarmLatch.
I.Ch0HHAAlarm I.Ch0HHAAlarm I.Ch0HHAAlarm I.Ch0HHAAlarm	BOOL	High high alarm bit that sets when the input signal moves above the configured high high alarm trigger point, Ch<0...3>HAlarmLimit. Remains set until the input signal moves below the trigger point.
I.Ch0Underrange I.Ch1Underrange I.Ch1Underrange I.Ch1Underrange	BOOL	Alarm bits indicating the channel's input is less than the minimum detectable input signal.
I.Ch0Overrange I.Ch1Overrange I.Ch2Overrange I.Ch3Overrange	BOOL	Alarms bit indicating the channel's input is greater than the maximum detectable input signal.

Input Tags (1732E-IT4IM12R)

Tag Name	Data Type	Definition
I.CJData	INT	The cold junction sensor temperature in counts where -32,768 counts is 0 °C (32 °F) and 32,767 counts is 86 °C (186 °F).

Configuration Tags (1732E-IT4IM12R)

Tag Name	Data Type	Definition
C.Ch0CJMode C.Ch1CJMode C.Ch2CJMode C.Ch3CJMode	SINT	See Cold Junction Compensation (CJC) Mode on page 39 .
C.CJModeIndependent	SINT	See Cold Junction Compensation (CJC) Mode on page 39 .
C.Ch0LEngineering C.Ch1LEngineering C.Ch2LEngineering C.Ch3LEngineering	INT	One of four points used in scaling. The low engineering helps determine the engineering units the signal values scale into. The low engineering term corresponds to the low signal value. The scaling equation used is as follows: $\text{Data} = \frac{(\text{Signal} - \text{LowSignal})(\text{HighEngineering} - \text{LowEngineering})}{\text{High Signal} - \text{Low Signal}} + \text{Low Engineering}$
C.Ch0HEngineering C.Ch1HEngineering C.Ch2HEngineering C.Ch3HEngineering	INT	One of four points used in scaling. The high engineering helps determine the engineering units the signal values scale into. The high engineering term corresponds to the high signal value. The scaling equation used is as follows: $\text{Data} = \frac{(\text{Signal} - \text{LowSignal})(\text{HighEngineering} - \text{LowEngineering})}{\text{High Signal} - \text{Low Signal}} + \text{Low Engineering}$
C.Ch0AlarmDisable C.Ch1AlarmDisable C.Ch2AlarmDisable C.Ch3AlarmDisable	SINT	Disables all alarms for the channel: 0 - Alarms are not disabled 1 - Alarms are disabled
C.Ch0LimitAlarmLatch C.Ch1LimitAlarmLatch C.Ch2LimitAlarmLatch C.Ch3LimitAlarmLatch	SINT	Enables latching for all four process alarms: low, low low, high and high high. Latching causes the process alarm to remain set until an unlatch service is explicitly sent to the channel or alarm.
C.Ch0NotchFilter C.Ch1NotchFilter C.Ch2NotchFilter C.Ch3NotchFilter	SINT	Configures the channel's notch filter settings. See Notch Filter on page 37 for list of valid input values.
C.Ch0SensorType C.Ch1SensorType C.Ch2SensorType C.Ch3SensorType	SINT	Configures the channel's sensor type settings. See Sensor Type on page 36 for list of valid sensor types.
C.Ch0DigitalFilter C.Ch1DigitalFilter C.Ch2DigitalFilter C.Ch3DigitalFilter	INT	A non-zero value enables the filter. The value serves as a time constant in milliseconds that can be used in a first order lag filter to smooth the input signal.
C.Ch0LAlarmLimit C.Ch1LAlarmLimit C.Ch2LAlarmLimit C.Ch3LAlarmLimit	INT	The low alarm trigger point. This value causes the Ch<0...3>LAlarm bit to trigger when the input signal moves beneath the configured trigger point, in engineering units.

Configuration Tags (1732E-IT4IM12R)

Tag Name	Data Type	Definition
C.Ch0HAlarmLimit C.Ch1HAlarmLimit C.Ch2HAlarmLimit C.Ch3HAlarmLimit	INT	The high alarm trigger point. This value causes the Ch<0...3>HAlarm bit to trigger when the input signal moves above the configured trigger point, in engineering units.
C.Ch0LLAlarmLimit C.Ch1LLAlarmLimit C.Ch2LLAlarmLimit C.Ch3LLAlarmLimit	INT	The low low alarm trigger point. This value causes the Ch<0...3>LLAlarm bit to trigger when the input signal moves beneath the configured trigger point, in engineering units.
C.Ch0HHAAlarmLimit C.Ch0HHAAlarmLimit C.Ch0HHAAlarmLimit C.Ch0HHAAlarmLimit	INT	The high high alarm trigger point. This value causes the Ch<0...3>HHAAlarm bit to trigger when the input signal moves above the configured trigger point, in engineering units.
Ch0TempMode Ch1TempMode Ch2TempMode Ch3TempMode	SINT	Controls the temperature scale to use on the module. 0 = Celsius 1 = Fahrenheit
Ch0CJEn Ch0CJEn Ch0CJEn Ch0CJEn	SINT	Enables the cold junction sensor that turns on cold junction compensation to linearize thermocouple inputs.
Ch0CJOffset Ch1CJOffset Ch2CJOffset Ch3CJOffset	INT	Provides a user-defined offset to add into the read cold-junction sensor value. Allows a sensor with a built-in bias to be compensated for.

Module Tags for 1732E-IR4IM12R**Input Tags (1732E-IR4IM12R)**

Tag Name	Data Type	Definition
I.Fault	DINT	Collection of all module level fault bits
I.Ch0Data I.Ch1Data I.Ch2Data I.Ch3Data	INT	The channel input signal represented in counts where -32,768 counts is the minimum detectable input signal and 32,767 counts is the maximum detectable.
I.Ch0Fault I.Ch1Fault I.Ch2Fault I.Ch3Fault	BOOL	Individual channel fault status bit. Indicates a 'hard' fault has occurred on the channel that means: calibration is ongoing; or if an input, an overrange or underrange condition is present. These bits also are set by the controller if communication is lost with the I/O module.
I.Ch0Calibration I.Ch1Calibration I.Ch2Calibration I.Ch3Calibration	BOOL	Indicates if calibration is currently in progress on a channel.
I.Ch0LAlarm I.Ch1LAlarm I.Ch2LAlarm I.Ch3LAlarm	BOOL	Low alarm bits that set when the input signal moves beneath the configured low alarm trigger point, Ch<0...3>LAlarmLimit. Remains set until the input signal moves above the trigger point, unless latched via Ch<0...3>LimitAlarmLatch, of the low alarm trigger point.
I.Ch0HAlarm I.Ch1HAlarm I.Ch2HAlarm I.Ch3HAlarm	BOOL	High alarm bit that sets when the input signal moves above the configured high alarm trigger point, Ch<0...3>HAlarmLimit. Remains set until the input signal moves below the trigger point, unless latched via Ch<0...3>LimitAlarmLatch.
I.Ch0LLAlarm I.Ch1LLAlarm I.Ch2LLAlarm I.Ch3LLAlarm	BOOL	Low low alarm bit that sets when the input signal moves beneath the configured low low alarm trigger point, Ch<0...3>LLAlarmLimit. Remains set until the input signal moves above the trigger point, unless latched via Ch<0...3>LimitAlarmLatch.

Input Tags (1732E-IR4IM12R)

Tag Name	Data Type	Definition
I.Ch0HHAAlarm I.Ch0HHAAlarm I.Ch0HHAAlarm I.Ch0HHAAlarm	BOOL	High high alarm bit that sets when the input signal moves above the configured high high alarm trigger point, Ch0HHAAlarmLimit. Remains set until the input signal moves below the trigger point.
I.Ch0Underrange I.Ch1Underrange I.Ch1Underrange I.Ch1Underrange	BOOL	Alarm bits indicating the channel's input is less than the minimum detectable input signal.
I.Ch0Ovrange I.Ch1Ovrange I.Ch2Ovrange I.Ch3Ovrange	BOOL	Alarms bit indicating the channel's input is greater than the maximum detectable input signal.

Configuration Tags (1732E-IR4IM12R)

Tag Name	Data Type	Definition
C.Ch0LEngineering C.Ch1LEngineering C.Ch2LEngineering C.Ch3LEngineering	INT	One of four points used in scaling. The low engineering helps determine the engineering units the signal values scale into. The low engineering term corresponds to the low signal value. The scaling equation used is as follows: $\text{Data} = \frac{(\text{Signal} - \text{LowSignal})(\text{HighEngineering} - \text{LowEngineering})}{\text{High Signal} - \text{Low Signal}} + \text{Low Engineering}$
C.Ch0HEngineering C.Ch1HEngineering C.Ch2HEngineering C.Ch3HEngineering	INT	One of four points used in scaling. The high engineering helps determine the engineering units the signal values scale into. The high engineering term corresponds to the high signal value. The scaling equation used is as follows: $\text{Data} = \frac{(\text{Signal} - \text{LowSignal})(\text{HighEngineering} - \text{LowEngineering})}{\text{High Signal} - \text{Low Signal}} + \text{Low Engineering}$
C.Ch0DigitalFilter C.Ch1DigitalFilter C.Ch2DigitalFilter C.Ch3DigitalFilter	INT	A non-zero value enables the filter. The value serves as a time constant in milliseconds that can be used in a first order lag filter to smooth the input signal.
C.Ch0LAlarmLimit C.Ch1LAlarmLimit C.Ch2LAlarmLimit C.Ch3LAlarmLimit	INT	The low alarm trigger point. This value causes the Ch<0...3>LAlarm bit to trigger when the input signal moves beneath the configured trigger point, in engineering units.
C.Ch0HAlarmLimit C.Ch1HAlarmLimit C.Ch2HAlarmLimit C.Ch3HAlarmLimit	INT	The high alarm trigger point. This value causes the Ch<0...3>HAlarm bit to trigger when the input signal moves above the configured trigger point, in engineering units.
C.Ch0LLAlarmLimit C.Ch1LLAlarmLimit C.Ch2LLAlarmLimit C.Ch3LLAlarmLimit	INT	The high high alarm trigger point. This value causes the Ch<0...3>HHAAlarm bit to trigger when the input signal moves above the configured trigger point, in engineering units.
C.Ch0HHAAlarmLimit C.Ch1HHAAlarmLimit C.Ch2HHAAlarmLimit C.Ch3HHAAlarmLimit	INT	The high high alarm trigger point. This value causes the Ch<0...3>HHAAlarm bit to trigger when the input signal moves above the configured trigger point, in engineering units.
C.Ch0LimitAlarmLatch C.Ch1LimitAlarmLatch C.Ch2LimitAlarmLatch C.Ch3LimitAlarmLatch	SINT	Enables latching for all four process alarms: low, low low, high and high high. Latching causes the process alarm to remain set until an unlatch service is explicitly sent to the channel or alarm.

Configuration Tags (1732E-IR4IM12R)

Tag Name	Data Type	Definition
C.Ch0AlarmDisable C.Ch1AlarmDisable C.Ch2AlarmDisable C.Ch3AlarmDisable	SINT	Disables all alarms for the channel: 0 - Alarms are not disabled 1 - Alarms are disabled
C.Ch0SensorType C.Ch1SensorType C.Ch2SensorType C.Ch3SensorType	SINT	Configures the channel's sensor type settings. See Sensor Type on page 36 for list of valid input values.
Ch0TempMode Ch1TempMode Ch2TempMode Ch3TempMode	SINT	Controls the temperature scale to use on the module. 0 = Celsius 1 = Fahrenheit

Access the Module Tags

When you access tags, you have two options. You can:

- monitor tags – this option allows you to view tags and change their values
- edit tags – this option allows you to add or delete tags but not to change their values

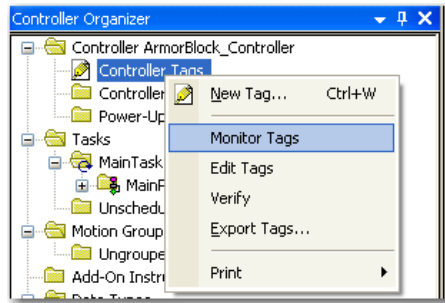

When you click Edit Tags or Monitor Tags, you can view and/or edit the tags through the following screen that shows all the tags for your modules:

Name	Alias For	Base Tag	Data Type
TEST_1732EIR4M12R:C			AB:1732_IR4:C:0
TEST_1732EIR4M12R:C.Ch0AlarmDisable			SINT
TEST_1732EIR4M12R:C.Ch0AlarmDisable.0			BOOL
TEST_1732EIR4M12R:C.Ch0AlarmDisable.1			BOOL
TEST_1732EIR4M12R:C.Ch0AlarmDisable.2			BOOL
TEST_1732EIR4M12R:C.Ch0AlarmDisable.3			BOOL
TEST_1732EIR4M12R:C.Ch0AlarmDisable.4			BOOL
TEST_1732EIR4M12R:C.Ch0AlarmDisable.5			BOOL
TEST_1732EIR4M12R:C.Ch0AlarmDisable.6			BOOL
TEST_1732EIR4M12R:C.Ch0AlarmDisable.7			BOOL
TEST_1732EIR4M12R:C.Ch0DigitalFilter			INT
TEST_1732EIR4M12R:C.Ch0HAlarmLimit			INT
TEST_1732EIR4M12R:C.Ch0HEngineering			INT
TEST_1732EIR4M12R:C.Ch0HAlarmLimit			INT
TEST_1732EIR4M12R:C.Ch0LAlarmLimit			INT
TEST_1732EIR4M12R:C.Ch0LEngineering			INT
TEST_1732EIR4M12R:C.Ch0LimitAlarmLatch			SINT
TEST_1732EIR4M12R:C.Ch0LLAlarmLimit			INT

Notes:

Numerics

1732E ArmorBlock

- embedded web server 63
- navigate 65

1732E-IR4IM12R 1

- configurable features 36
- configuration 24
- configuration data 41
- connectors 3
- I/O Configuration 16
- input specifications 58
- input tags 69
- RTD sensor types 4
- supported sensor types 37
- troubleshooting 53
- wiring 10

1732E-IT4IM12R 1

- configurable features 36
- configuration 26
- configuration data 40
- configuration tags 68
- connectors 3
- I/O Configuration 16
- input tags 67
- produced data 43
- supported sensor types 36
- supported thermocouples 3
- troubleshooting 53
- wiring 10

1756-EN2T 3, 14, 16

1756-EN2TR 3, 16

1756-EN3TR 3, 16

871A-TR4CJC-DM 58

871A-TS4CJC-DM 58

A

accuracy 58, 59

alarms 1, 5, 28

- high 29
- low 29
- low-low 29
- process 29

Allen-Bradley 871A-TR4CJC-DM 4

Allen-Bradley 871A-TS4CJC-DM 4

analog signal 1

auxiliary power 2, 11, 53

B

bridge

- add new 16
- new 16

browser requirements

- embedded web server 63

C

calibration 31, 59

- process 45
- recommended instrument range 45

CE 61

CE Low Voltage Directive 12

certifications 61

channel 25, 27, 29

CJC error detection 4

CJC Terminal Chamber 4

cold junction compensation 3, 27, 35, 38, 58

- Average Selected 39
- Channel Independent 39
- enable 35
- mode 28, 35, 38, 39
- offset 28, 35, 38, 39

common mode rejection rate 58, 59

common techniques used in this manual iii

communication rate 57

compensation voltage 4

conducted RF immunity 60

configuration

- bridge 18
- default 16
- edit 21
- I/O 16
- port 31
- process 16
- software 16

connections

- input only 23
- unicast 24

connectors 2

- EtherNet/IP D-code M12 2
- I/O M12 2, 10
- micro-style power in/out 2
- power 11

controller

- download program 20

ControlLogix 14

conventions iii

C-Tick 61

c-UR-us 61

D

data

- access 63
- format 57, 59
- module 63
- monitor 63

default configuration 16

- use 16

default gateway 8

defaults 7

DHCP 7

diagnostic

- information 66

digital filters 6, 35, 25, 27, 38
dimensions 57
DNS Server Address
 primary 30
 secondary 30
domain name 30
dynamic reconfiguration 21

E

EFT/B immunity 60
electronic keying 22
 choosing in RSLogix 5000 18
 compatible module 22
 disable keying 22
 exact match 22
embedded web server
 1732E Armorblock 63
 browser requirements 63
emissions 60
enclosure type rating 60
ESD immunity 60
EtherNet/IP 61
exclusive owner 23

F

factory defaults 8
fault 24, 54
 communication 55
 general module 55
 LED 4
 mode 1
 notification 55
 warning signal 55
features
 configurable 35
 fault mode 1
 overview 1
 physical 2
 preset temperature selection 1
 sensor type 1
filters 58, 59
firmware version 3
Functional Earth 9
functional earth ground 2

G

gateway 8

H

hardware
 set up 14

hardware/software compatibility 3
high alarms 6
high engineering 25, 27
high vibration 9
high-high alarms 6, 5
home page
 web server 64
host name 30

I

I/O Configuration 13, 16
 tree 21
indicators
 status 54
Inhibit Module 24
input resistance 59
input specifications 58
input tags 67
input voltage range 58
installation 7
 connect cables 7
 mount module 7
 set network address 7

IP

 address 20
 settings 30
isolation voltage 57

K

KC 61
keying
 electronic 18

L

latch alarms 28, 29
LED
 flashing red 54
 flashing red/green 54
 flashing yellow 54
 green 54
 red 54
level alarms 1, 5
 low 6
link 53
listen only 23
Logix5565 14
low alarms 5
low engineering 25, 27
low-low 6
low-low alarms 5
LVD 12

M**manuals**

related iii

millivolt 5**minor revision**

setting in RSLogix 5000 18

module

data 63

LED 8

mount 9

power 11, 57

properties 21

revision 22

series 22

tags 67

monitoring 63**mounting 9**

dimensions 9

module 9

N**network**

address 7

LED 8

node address switches 2**noise transients 6****normal mode rejection rate 58, 59****notch filter 25, 27, 37****O****open-wire detection 5****overrange detection 1, 5****P****pan head screws 9****PELV 12****physical features 2****port configuration 30****port speed**

configure 31

power

connectors 11

consumption 57

publications

related iii

purpose of this manual iii**R****radiated RF immunity 60****redundancy**

use 15

related documentation iii**relative humidity 60****requested packet interval (RPI) 23****resistance 5****resolution 58****RSLinx software 3, 14****RSLogix 5000 3, 4, 5, 13, 15, 16, 20, 45, 53, 54**

Calibration tab 31

choosing an electronic keying method 18

Configuration tab 24

Connection tab 23

General tab 22

I/O Configuration 13

Internet Protocol tab 30

Port Configuration tab 30

setting the minor revision 18

use 16

RTD

sensor type 4, 25

S**screws 9****SELV 12****sensor types 1, 25, 27, 35, 36****set up**

hardware 14

setting 7**shock**

nonoperating 60

operating 60

software

configuration 16

specifications 57

general 57

resolution 57

voltage 57

weight 57

status indicators 2, 53, 57

auxiliary power 2, 54

I/O 2, 54

link 2, 54

module 2, 53, 54

network 2, 53, 54

status monitoring 32**surge transient immunity 60****switches 2, 7**

001 8

888 8

T**temperature**

ambient 60

nonoperating 60

operating 60

units 27, 35, 37

thermistor 39
thermistors 4
thermocouple types 3
Thermometrics DC95F302V/W 58
Thermometrics MF65F302V/W 58
torque 10
troubleshooting 53, 54
troubleshoot module 54

U

UL Type 1 enclosure 12
underrange detection 1, 5
use
 default configuration 16
 redundancy 15
 RSLogix 5000 16
 screw holes 9

V

vibration 9, 60

W

web server 63, 64
 home page 64
 log in 64
wiring 10

Rockwell Automation Support

Rockwell Automation provides technical information on the Web to assist you in using its products.

At <http://www.rockwellautomation.com/support/>, you can find technical manuals, a knowledge base of FAQs, technical and application notes, sample code and links to software service packs, and a MySupport feature that you can customize to make the best use of these tools.

For an additional level of technical phone support for installation, configuration, and troubleshooting, we offer TechConnect support programs. For more information, contact your local distributor or Rockwell Automation representative, or visit <http://www.rockwellautomation.com/support/>.

Installation Assistance

If you experience a problem within the first 24 hours of installation, review the information that is contained in this manual. You can contact Customer Support for initial help in getting your product up and running.

United States or Canada	1.440.646.3434
Outside United States or Canada	Use the Worldwide Locator at http://www.rockwellautomation.com/support/americas/phone_en.html , or contact your local Rockwell Automation representative.

New Product Satisfaction Return

Rockwell Automation tests all of its products to ensure that they are fully operational when shipped from the manufacturing facility. However, if your product is not functioning and needs to be returned, follow these procedures.

United States	Contact your distributor. You must provide a Customer Support case number (call the phone number above to obtain one) to your distributor to complete the return process.
Outside United States	Please contact your local Rockwell Automation representative for the return procedure.

Documentation Feedback

Your comments will help us serve your documentation needs better. If you have any suggestions on how to improve this document, complete this form, publication [RA-DU002](#), available at <http://www.rockwellautomation.com/literature/>.

Rockwell Otomasyon Ticaret A.Ş., Kar Plaza İş Merkezi E Blok Kat:6 34752 İçerenköy, İstanbul, Tel: +90 (216) 5698400

www.rockwellautomation.com

Power, Control and Information Solutions Headquarters

Americas: Rockwell Automation, 1201 South Second Street, Milwaukee, WI 53204-2496 USA, Tel: (1) 414.382.2000, Fax: (1) 414.382.4444

Europe/Middle East/Africa: Rockwell Automation NV, Pegasus Park, De Kleetlaan 12a, 1831 Diegem, Belgium, Tel: (32) 2 663 0600, Fax: (32) 2 663 0640

Asia Pacific: Rockwell Automation, Level 14, Core F, Cyberport 3, 100 Cyberport Road, Hong Kong, Tel: (852) 2887 4788, Fax: (852) 2508 1846

Rockwell Automation Publication 1732E-UM004A-EN-E - July 2012