



DeviceNet 1732 ArmorBlock 16-Point I/O, Series A

Catalog numbers 1732D-IB16M12M12, 1732D-OB16M12M12, 1732D-16CFGM12M12, 1732D-IB16M12MINI, 1732D-OB16M12MINI, 1732D-16CFGM12MN, 1732D-IB161212W

Table of Contents

Topic	Page
Important User Information	2
Environment and Enclosure	3
Preventing Electrostatic Discharge	3
About the Module	4
Install the Module	5
Mount the Module	6
Wire the Module	13
Interpret the Status Indicators	15
Specifications	16

Important User Information

Solid-state equipment has operational characteristics differing from those of electromechanical equipment. Safety Guidelines for the Application, Installation and Maintenance of Solid State Controls (Publication [SGI-1.1](#) available from your local Rockwell Automation sales office or online at <http://www.rockwellautomation.com/literature/>) describes some important differences between solid-state equipment and hard-wired electromechanical devices. Because of this difference, and also because of the wide variety of uses for solid-state equipment, all persons responsible for applying this equipment must satisfy themselves that each intended application of this equipment is acceptable.





In no event will Rockwell Automation, Inc. be responsible or liable for indirect or consequential damages resulting from the use or application of this equipment.

The examples and diagrams in this manual are included solely for illustrative purposes. Because of the many variables and requirements associated with any particular installation, Rockwell Automation, Inc. cannot assume responsibility or liability for actual use based on the examples and diagrams.

No patent liability is assumed by Rockwell Automation, Inc. with respect to use of information, circuits, equipment, or software described in this manual.

Reproduction of the contents of this manual, in whole or in part, without written permission of Rockwell Automation, Inc., is prohibited.

Throughout this manual, when necessary, we use notes to make you aware of safety considerations.

	WARNING: Identifies information about practices or circumstances that can cause an explosion in a hazardous environment, which may lead to personal injury or death, property damage, or economic loss.
	ATTENTION: Identifies information about practices or circumstances that can lead to personal injury or death, property damage, or economic loss. Attentions help you identify a hazard, avoid a hazard and recognize the consequences.
	SHOCK HAZARD: Labels may be on or inside the equipment (for example, drive or motor) to alert people that dangerous voltage may be present.
	BURN HAZARD: Labels may be on or inside the equipment (for example, drive or motor) to alert people that surfaces may reach dangerous temperatures.
IMPORTANT	Identifies information that is critical for successful application and understanding of the product.

Environment and Enclosure



ATTENTION: This equipment is intended for use in overvoltage Category II applications (as defined in IEC 60664-1), at altitudes up to 2000 m (6562 ft) without derating.

This equipment is considered Group 1, Class A industrial equipment according to IEC/CISPR 11. Without appropriate precautions, there may be difficulties with electromagnetic compatibility in residential and other environments due to conducted and radiated disturbances.

This equipment is supplied as enclosed equipment. It should not require additional system enclosure when used in locations consistent with the enclosure type ratings stated in the Specifications section of this publication. Subsequent sections of this publication may contain additional information regarding specific enclosure type ratings, beyond what this product provides, that are required to comply with certain product safety certifications.

In addition to this publication, see:

- Industrial Automation Wiring and Grounding Guidelines, Rockwell Automation publication [1770-4.1](#), for additional installation requirements.
- NEMA Standard 250 and IEC 60529, as applicable, for explanations of the degrees of protection provided by different types of enclosure.

Preventing Electrostatic Discharge



ATTENTION: This equipment is sensitive to electrostatic discharge, which can cause internal damage and affect normal operation. Follow these guidelines when you handle this equipment

- Touch a grounded object to discharge potential static.
 - Wear an approved grounding wriststrap.
 - Do not touch connectors or pins on component boards.
 - Do not touch circuit components inside the equipment.
 - Use a static-safe workstation, if available.
 - Store the equipment in appropriate static-safe packaging when not in use.
-

About the Module

The DeviceNet 1732D ArmorBlock I/O family consists of stand-alone 24V DC I/O modules that communicate via the DeviceNet network. The sealed IP67 housing of these modules requires no enclosure. Note that environmental requirements other than IP67 may require an additional appropriate enclosure. I/O connectors are sealed M12 style.

Module Identification

1732D-IB16M12M12 shown

1732D-IB16M12MINI shown

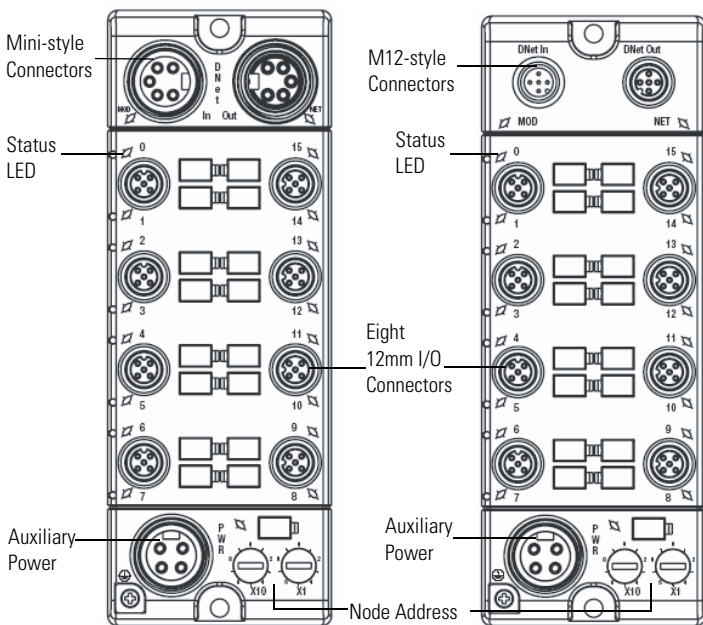

43966

43967

The DeviceNet network uses advanced network technology, producer/consumer communication, to increase network functionality and throughput. Visit our web site at www.ab.com/Networks-and-Communications/DeviceNet-Network for information and updates.

Catalog Number Explanation

Refer to the table for a description of the modules' catalog numbers.

Catalog Number	Description	Network Connector
1732D-IB16M12M12	DeviceNet 24V DC 16 Input	M12 pass-through
1732D-OB16M12M12	DeviceNet 24V DC 16, 2 A Output	
1732D-16CFGM12M12	DeviceNet 24V DC 16 Selectable Points	
1732D- IB161212W	DeviceNet 24V DC 16 Input M12 Weldblock	
1732D-IB16M12MINI	DeviceNet 24V DC 16 Input	Mini pass-through
1732D-OB16M12MINI	DeviceNet 24V DC 16, 2 A Output	
1732D-16CFGM12MN	DeviceNet 24V DC 16 Selectable Points	

Install the Module

To install the module:

- Set the node address
- Mount the module
- Connect the cord sets

Set the Node Address

Valid node addresses are 00 through 63.

Set the node address using either the rotary switches, RSNetWorx for DeviceNet, DeviceNetManager, or another software configuration tool. Setting the switches at any number from 64 through 99 lets the software have address control.

Each module is shipped set for node address 63. Remove the caps on the front of the module to access the switches. The two switches are:

- X10 (most significant digit) – left side of module
- X1 (least significant digit) – right side of module

To reset the node address:

1. Rotate the switches using a small blade screwdriver.
2. Line up the small black dot on the switch with the number setting you wish to use.
3. Cycle power.

Set Node Address

Example shows default node address set at 63.

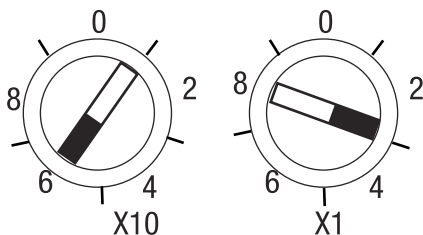

43968

The rotary switches are read periodically. If the switches have been changed since the last time they were read and they no longer match the online address, a minor fault occurs, which is indicated by a flashing red Module Indicator.

Settings of 64 through 99 cause the module to use the last valid node address stored internally. For example, the last setting internally was 40. If a change is made to 68, and then you power up, the address defaults to 40.

The module is equipped with AutoBaud detect. AutoBaud lets the module read the settings already in use on your DeviceNet network and automatically adjusts to those settings.

Mount the Module

Two sets of mounting holes are used to mount the module directly to a panel or machine. Mounting holes accommodate #6 (M3) pan head screws. The torque specification is 0.64 Nm (6 in-lb).

Product Dimensions

Refer to the mounting dimensions illustration to help you mount the module.

Module Dimensions

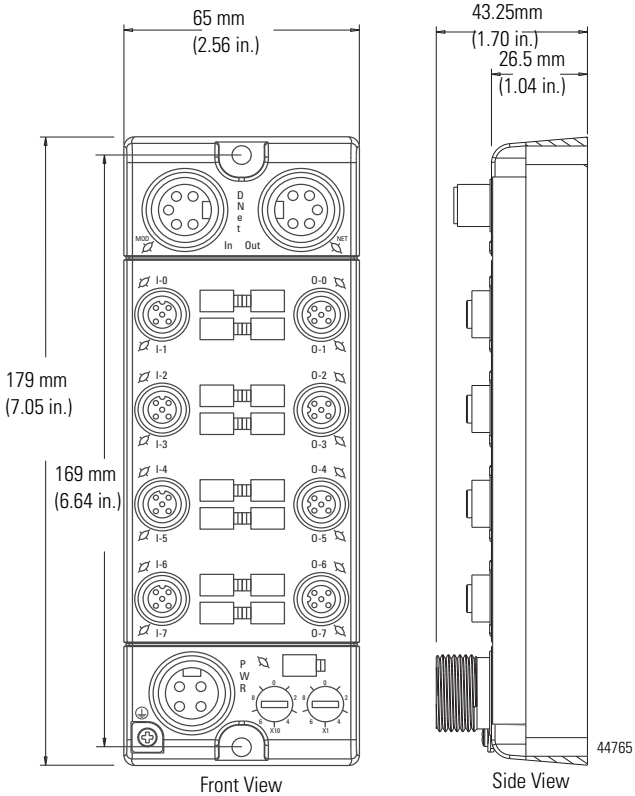

Install the mounting as follows:

If you mount the module in an area that is subject to shock or vibration, we recommend that you use a flat and a lock washer to mount the module. Mount the flat and the lock washer as shown in the mounting illustration. Torque the mounting screws to 0.64 Nm (6 in-lb).

Mount in High Vibration Areas

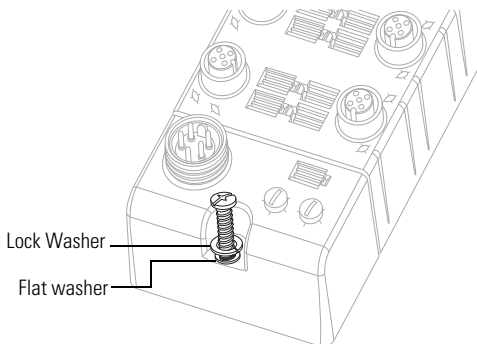

44766

Connect the I/O Cord Sets to the ArmorBlock Module

The ArmorBlock DeviceNet family has 5-pin micro-style connectors.

We provide caps to cover the unused connectors on your module. Connect the quick-disconnect cord sets you selected for your module to the appropriate ports



ATTENTION: If any I/O devices connected to this equipment requires Class 2 power to operate, this equipment and all connected I/O must be powered by a Class 2 source.



ATTENTION: To comply with the CE Low Voltage Directive (LVD), this equipment and all connected I/O must be powered from a source compliant with the following:
Safety Extra Low Voltage (SELV) or Protected Extra Low Voltage (PELV).

Network Connector

Refer to the pinout diagram for the network connector.

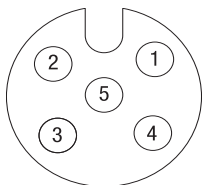
Micro-style Input Male Connector

43584

(View into connector)

Pin 1	Drain
in 2	V+
Pin 3	V-
Pin 4	CAN_H
Pin 5	CAN_L

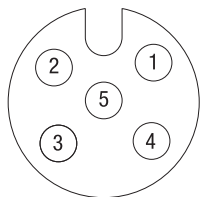
Micro-style Output Female Connector

43584

(View into connector)

Pin 1	Drain
in 2	V+
Pin 3	V-
Pin 4	CAN_H
Pin 5	CAN_L

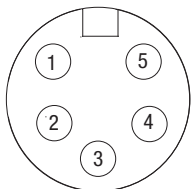
Mini-style Input Male Connector

43901

(View into connector)

Pin 1	Drain
in 2	V+
Pin 3	V-
Pin 4	CAN_H
Pin 5	CAN_L

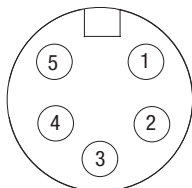
Mini-style Output Male Connector

43902

(View into connector)

Pin 1	Drain
in 2	V+
Pin 3	V-
Pin 4	CAN_H
Pin 5	CAN_L

To terminate the module, use the second network connector and a Rockwell Automation terminator resistor (Catalog Number 1485A-T1D5).

I/O Connectors

Refer to the pinout diagrams for the I/O connectors.

Micro-style 5-pin Female Input Connector

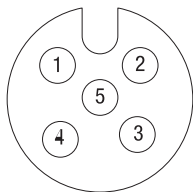

41452

(View into connector)

Pin 1	Sensor Source Voltage
Pin 2	Input B
Pin 3	Return
Pin 4	Input A
Pin 5	PE

Micro-style 5-pin Female Output Connector

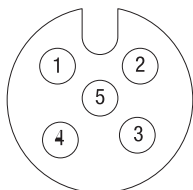

41452

(View into connector)

Pin 1	Not used
Pin 2	Output B
Pin 3	Return
Pin 4	Output A
Pin 5	PE

Self-configuring Connector

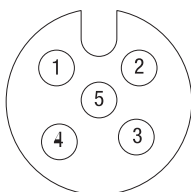

41452

(View into connector)

Pin 1	Sensor Source Voltage
Pin 2	Input or Output B
Pin 3	Return
Pin 4	Input or Output A
Pin 5	PE



ATTENTION: Make sure all connectors and caps are securely tightened to properly seal the connections against leaks and maintain IP enclosure type requirements.

The 1732D-16CFGM12y (y indicates all 1732D catalog numbers) self-configuring module contains both input and output functionality.

If an I/O point is to be an output, dedicate that point as an output with a wired load and energize it through a control program. Energized outputs show an associated active input that can be used as a feedback mechanism to make certain that the output is on.

If an I/O point is to be an input, wire the input device as normal and leave the associated output un-energized at all times.

I/O Self-configure Circuitry

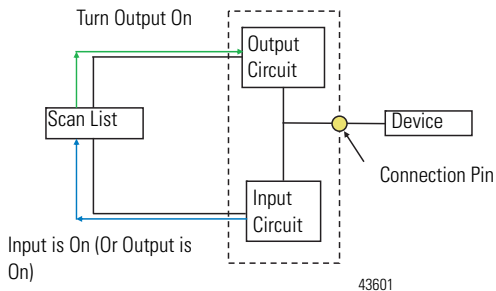

Refer to the illustration for configuration operations.

Configure Operations

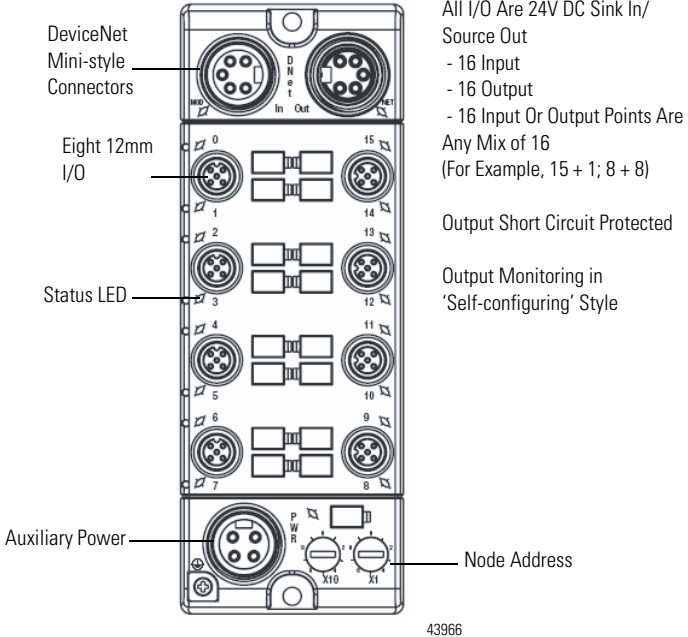

Auxiliary Power Cable

Refer to the pinout diagram to attach auxiliary power.

Mini-style 4-pin Male Connector

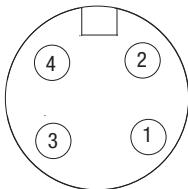

(view into connector)

- Pin 1 Output Power+
- Pin 2 Sensor/MDL Power+
- Pin 3 Sensor/MDL Power-
- Pin 4 Output Power-

43906

Input devices are powered from the DeviceNet power. Output devices are powered from the module's auxiliary power connector. Removing auxiliary power will deactivate all

actuators and output devices, however, input devices will remain powered as long as the DeviceNet power is on.

Refer to publication M115-CA001 for Rockwell Automation cable and cord set offerings or access the Connection Systems website at:

www.ab.com/sensors/products/connection_systems/index.html.

Wire the Module

Follow the wiring instructions for the ArmorBlock I/O modules.

Communicate with Your Module

This module's I/O is exchanged with the master through a cyclic, polled, or change-of-state connection.

Cyclic - allows configuration of the block as an I/O client. The block will produce and consume its I/O cyclically at the rate configured.

Polled - a master initiates communication by sending its polled I/O message to the module. The module consumes the message, updates outputs, and produces a response. The response has input data.

Change-of-State - productions occur when an input changes or a fault condition occurs. If no input or fault condition change occurs within the expected packet rate, a heartbeat production occurs. This heartbeat production tells the scanner module that the I/O module is alive and ready to communicate. Consumption occurs when data changes and the master produces new output data to the I/O block.

Refer to the Module Data Definitions table for more information. Note that the y indicates all 1732D catalog numbers

1732D-IB16M12y Data Definitions

Byte	Bit 7	Bit 6	Bit 5	Bit 4	Bit 3	Bit 2	Bit 1	Bit 0
Produce 0	17	16	15	14	13	12	11	10
Produce 1	115	114	113	112	111	110	19	18

Where: I = Input data

1732D-0B16M12y Data Definitions

Byte	Bit 7	Bit 6	Bit 5	Bit 4	Bit 3	Bit 2	Bit 1	Bit 0
Consume 0	07	06	05	04	03	02	01	00
Consume 1	015	014	013	012	011	010	09	08

Where: 0 = Output data

1732D-16CFGM12y Data Definitions

Byte	Byte 7	Byte 6	Byte 5	Byte 4	Byte 3	Byte 2	Byte 1	Byte 0
Produce 0	17	16	15	14	13	12	11	10
Produce 1	115	114	113	112	111	110	19	18
Consume 0	07	06	05	04	03	02	01	00
Consume 1	015	014	013	012	011	010	09	08

Where 1 = Input data 0 = Output data

The 1732D-16CFGM12y self-configuring module contains input and output functionality. These modules do not need to be configured.

If an I/O point is to be an output, dedicate that point as an output with a wired load and energize it through a control program.

If an I/O point is to be an input, wire the input device as normal and leave the associated output un-energized at all times.

Interpret the Status Indicators

This module has the following indicators:

- Network and Module status indicator for DeviceNet
- Auxiliary Power indicator
- Individual I/O status indicators for inputs and outputs

Device Status Indicators

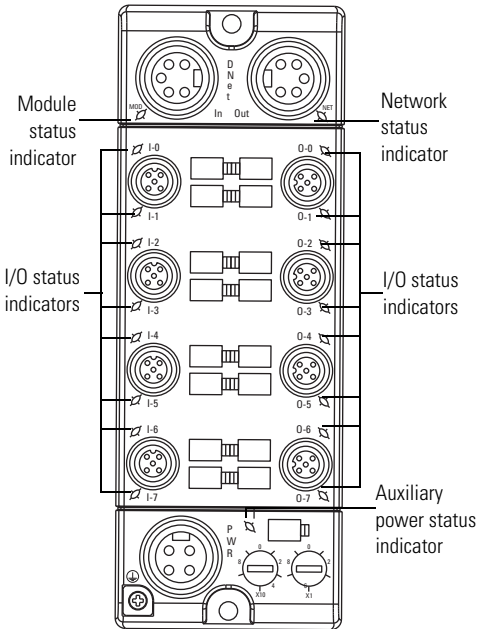

44764

16 DeviceNet 1732 ArmorBlock 16-Point I/O, Series A

Refer to the device status indicator table for a description of the status indicators

Device Status Indicators

Indicator	Status	Description
Network status	Off	Device is not online: - Device has not completed dup_MAC-id test. - Device not powered – check module status indicator.
	Green	Device operating normally. As a Group 2 module, it means that the module is allocated to a master.
	Flashing green	Device is online with no connections in the established state
	Red	Critical link failure – failed communications module
	Flashing red	Recoverable fault – an I/O connection has timed out
Module status	Off	No power applied to the device
	Green	Device is online and has one or more I/O connections in established state
	Flashing green	Device needs commissioning due to missing, incomplete, or incorrect configuration
	Red	Critical fault – Device timed out or has an unrecoverable fault
	Flashing red	Recoverable fault – input or output short circuit
Auxiliary status	Off	No auxiliary power applied to the device
	Green	Auxiliary power is applied to the device
I/O status	Off	I/O is not energized or is not valid
	Yellow	I/O is energized and valid

Specifications

DeviceNet 1732 ArmorBlock 16-Point I/O, Series A - 1732D-IB16M12M12, 1732D-IB16M12MINI, 1732D-16CFGM12M12, 1732D-16CFGM12MINI

Attribute	Value
Number of Inputs	16
Input type	61131-2 Type 3 compatible
Off-state input voltage, max	5V DC
Voltage, on-state input, max	30V DC
Voltage, on-state input, nom	24V DC
Voltage, on-state input, min	11V DC

DeviceNet 1732 ArmorBlock 16-Point I/O, Series A - 1732D-IB16M12M12, 1732D-IB16M12MINI, 1732D-16CFGM12M12, 1732D-16CFGM12MINI

Attribute	Value
Voltage, sensor source, max	30V DC
Voltage, sensor source, min	11V DC
Current, off-state input, max	1.5 mA @ 5V DC
Current, on-state input, max	5 mA @ 25V DC
Isolation voltage	50V (continuous), Basic Insulation Type, Inputs and Sensor Power to Network, Type tested at 707V DC for 60 s
Input delay time ⁽¹⁾ OFF to ON ON to OFF	0...16000 ms

⁽¹⁾ Input OFF to ON or ON to OFF delay is time from a valid input signal to recognition by the module.

DeviceNet 1732 ArmorBlock 16-Point I/O, Series A - 1732D-OB16M12M12, 1732D-OB16M12MINI 1732D-16CFGM12M12, 1732D-16CFGM12MINI

Attribute	Value
Number of Outputs	16
Output type	61131-2 compatible
Voltage drop, on-state output, max	0.5V DC
Voltage drop, off-peak blocking, min	30V DC
Voltage, on-state output, max	30V DC
Voltage, on-state output, nom	24V DC
Voltage, on-state output, min	11V DC
Current, on-state output, max	0.5 A (1732D-16CFGM12y) 2 A (1732D-OB16M12y)
Current per module, max	4 A (all outputs)
Leakage current, off-state output, max	50 mA

DeviceNet 1732 ArmorBlock 16-Point I/O, Series A - 1732D-OB16M12M12, 1732D-OB16M12MINI 1732D-16CFGM12M12, 1732D-16CFGM12MINI

Attribute	Value
Isolation voltage	50V (continuous), Basic Insulation Type, Outputs and Output Power to Network No isolation between individual Outputs or between Outputs and Output power Type tested at 707V DC for 60 s
Surge current per output, max	1.2 A for 10 ms, repeatable every 2 s (1732D-16CFGM12y) 4.8 A for 10 ms, repeatable every 2 s (1732D-OB16M12y)
Pilot duty rating	Not rated

General Specifications

Attribute	Value
Voltage, auxiliary power, max	30V DC
Voltage, auxiliary power, min	12V DC
Voltage, DeviceNet power, max	25V DC
Voltage, DeviceNet power, min	11V DC
Current, auxiliary power input, max	900 mA
Current, auxiliary power, max	8 A
Current, sensor source, per input, max	50 mA
Current, sensor source, per module, max	800 mA
Communication rate	125 Kbps @ 500 m (1640 ft) for thick cable, flat media length 375 m (1230 ft) 250 Kbps @ 200 m (600 ft) for thick cable, flat media length 150 m (492 ft) 500 Kbps @ 100 m (330 ft) for thick cable, flat media length 75 m (246 ft)
DeviceNet current	100 mA (75 mA for 1732E-IB16M12y)
Indicators	1 green/red module status 1 green/red network status 1 green auxiliary power 16 yellow input/output status
Enclosure type rating	Meets IP65/66/67/69K (when marked), and NEMA 4X/6P with receptacle dust caps or cable termination

General Specifications

Attribute	Value
Wiring category ⁽¹⁾	1 – on signal ports 1 – on power ports 1 – on communications ports
Dimensions (HxWxD), approx.	179 x 65 x 43.25 mm (7.05 x 2.56 x 1.70 in.)
Weight, approx.	M12 connectors – 340 g (12 oz) Mini connectors – 392 g (13.83 oz)

⁽¹⁾ Use this Conductor Category information for planning conductor routing. Refer to Industrial Automation Wiring and Grounding Guidelines, publication [1770-4.1](#).

Environmental Specifications

Attribute	Value
Temperature, operating	IEC60068-2-1 (Test Ad, Operating Cold), IEC60068-2-2, (Test Bd, Operating Dry Heat), IEC 60068-2-14 (Test Nb, Operating Thermal Shock): -20...60 °C (-4...140 °F)
Temperature, storage	IEC 60068-2-1 (Test Ab, Unpackaged Non-operating Cold), IEC 60068-2-2 (Test Bb, Unpackaged Non-operating Dry Heat), IEC 60068-2-14 (Test Na, Unpackaged Non-operating Thermal Shock): -45...85 °C (-49...185 °F)
Relative humidity	IEC 60068-2-30 (Test Db, Un-packaged Damp Heat): 5...95% non-condensing
Vibration	IEC 60068-2-6 (Test Fc, Operating): 5 g @ 10...500 Hz
Shock, operating	IEC 60068-2-27 (Test Ea, Unpackaged Shock): 30 g
Shock, nonoperating	IEC 60068-2-27 (Test Ea, Unpackaged Shock): 50 g
Emissions	CISPR 11: Group 1, Class A
ESD immunity	IEC 61000-4-2: 8 kV contact discharges 8 kV air discharges
Radiated RF immunity	IEC 61000-4-3: 10V/m with 1 kHz sine-wave 80% AM from 80...2000 MHz 10V/m with 200 Hz 50% Pulse 100% AM @ 900 MHz 10V/m with 200 Hz 50% Pulse 100% AM @ 1890 MHz 3V/m with 1 kHz sine-wave 80% AM from 2000...2700 MHz

Environmental Specifications

Attribute	Value
EFT/B immunity	IEC 61000-4-4: ±3 kV at 5 kHz on power ports ±3 kV at 5 kHz on signal ports ±3 kV at 5 kHz on communications ports
Surge transient immunity	IEC 61000-4-5: ±1 kV line-line(DM) and ±2 kV line-earth(CM) on power ports ±1 kV line-line(DM) and ±2 kV line-earth(CM) on signal ports ±2 kV line-earth(CM) on communications ports
Conducted RF immunity	IEC 61000-4-6: 10V rms with 1 kHz sine-wave 80% AM from 150 kHz...80 MHz

Certifications

Certification (when product is marked) ⁽¹⁾	Value
c-UL-us	UL Listed Industrial Control Equipment, certified for US and Canada. See UL File E322657.
CE	European Union 2004/108/EC EMC Directive, compliant with: EN 61326-1; Meas./Control/Lab., Industrial Requirements EN 61000-6-2; Industrial Immunity EN 61000-6-4; Industrial Emissions EN 61131-2; Programmable Controllers (Clause 8, Zone A & B)
C-Tick	Australian Radiocommunications Act, compliant with: AS/NZS CISPR 11; Industrial Emissions
ODVA	ODVA conformance tested to DeviceNet specifications.

⁽¹⁾ See the Product Certification link at <http://www.ab.com> for Declaration of Conformity, Certificates, and other certification details.

Notes:

Notes:

Notes:

Rockwell Automation Support

Rockwell Automation provides technical information on the Web to assist you in using its products. At <http://www.rockwellautomation.com/support/>, you can find technical manuals, a knowledge base of FAQs, technical and application notes, sample code and links to software service packs, and a MySupport feature that you can customize to make the best use of these tools.

For an additional level of technical phone support for installation, configuration and troubleshooting, we offer TechConnect support programs. For more information, contact your local distributor or Rockwell Automation representative, or visit <http://www.rockwellautomation.com/support/>.

Installation Assistance

If you experience a problem within the first 24 hours of installation, please review the information that's contained in this manual. You can also contact a special Customer Support number for initial help in getting your product up and running.

United States or Canada	1.440.646.3434
Outside United States or Canada	Use the Worldwide Locator at http://www.rockwellautomation.com/support/americas/phone_en.html , or contact your local Rockwell Automation representative.

New Product Satisfaction Return

Rockwell Automation tests all of its products to ensure that they are fully operational when shipped from the manufacturing facility. However, if your product is not functioning and needs to be returned, follow these procedures.

United States	Contact your distributor. You must provide a Customer Support case number (call the phone number above to obtain one) to your distributor to complete the return process.
Outside United States	Please contact your local Rockwell Automation representative for the return procedure.

Documentation Feedback

Your comments will help us serve your documentation needs better. If you have any suggestions on how to improve this document, complete this form, publication [RA-DU002](#), available at <http://www.rockwellautomation.com/literature/>.

Allen-Bradley, Rockwell Automation, ArmorBlock, and TechConnect are trademarks of Rockwell Automation, Inc.

Trademarks not belonging to Rockwell Automation are property of their respective companies.

Rockwell Otomasyon Ticaret A.Ş., Kar Plaza İş Merkezi E Blok Kat:6 34752 İçerenköy, İstanbul, Tel: +90 (216) 5698400

www.rockwellautomation.com

Power, Control and Information Solutions Headquarters

Americas: Rockwell Automation, 1201 South Second Street, Milwaukee, WI 53204-2496 USA, Tel: (1) 414.382.2000, Fax: (1) 414.382.4444
Europe/Middle East/Africa: Rockwell Automation, Voorlaan/Boulevard du Souverain 36, 1170 Brussels, Belgium, Tel: (32) 2 663 0600, Fax: (32) 2 663 0640
Asia Pacific: Rockwell Automation, Level 14, Core F, Cyberport 3, 100 Cyberport Road, Hong Kong, Tel: (852) 2887 4788, Fax: (852) 2508 1846

Publication 1732D-IN002B-EN-P - January 2013

Supersedes Publication 1732D-IN002A-EN-P - April 2001

Copyright © 2013 Rockwell Automation, Inc. All rights reserved.