



SMC™-3 and SMC Flex Smart Motor Controllers



LISTEN.
THINK.
SOLVE.™

Bulletin 150 — Solid-State Reduced Voltage Starters

The Allen-Bradley SMC™ Smart Motor Controller product line offers a broad range of products for starting and stopping standard 3-phase squirrel-cage induction motors and wye-delta motors.

		
Features	SMC™ Flex 200...690V 1...1250 A	SMC™-3 200...600V 1...480 A
Soft Start	S	S
Kickstart	S	S
Current Limit	S	S
Dual Ramp Start	S	—
Full Voltage	S	—
Energy Saver	—	—
Soft Stop	S	S
Pump Control	O	—
Preset Slow Speed	S	—
Linear Acceleration/Deceleration	S	—
Torque Control	—	—
SMB™ Smart Motor Braking	O	—
Accu-Stop™	O	—
Slow Speed with Braking	O	—
Integrated Bypass Contactor	S	S
Integrated Motor Overload Protection	S	S
Single-phase Operation	—	—
DPI Communication	S	—
Metering	S	—
Real Time Clock	—	—
Motor Winding Heater Function	‡	—
Diagnostic Faults and Alarms	S	—
Motor and Starter	—	—
Individual Bit Enable of Faults and Alarms	—	—
Automatic Tuning of Motor Parameters	—	—
Parameter Configuration/Programming	S	—
Human Interface Module (HIM)	O	—
Parameter Configuration Module	—	—
Configuration Software: Drives Explorer and Drives Executive	O	—
Digital I/O Expansion Module§♣	—	—
Ground Fault/CT/PTC Module§	—	—
Network Communications	O	—
Inside Delta Connection	S	S
Standards Compliance: CE Marked per Low Voltage Directive 73/23/EEC, 93/68/EEC CSA Certified (File No. LR 1234) UL Listed (File No. E96956)	S	S
Product Selection	Page 6	Page 30

S = Standard Feature
 O = Optional Feature

★ Starter does not include a configuration device as standard.

‡ Option using a Bulletin 1410 motor winding heater.

§ With removable terminal block.

♣ Starter ships with 2 DC inputs and 2 relay outputs as standard.

♠ The starter is fully solid-state (no integral bypass). An external bypass contactor can be added as an option.

& Note: Information for this product line is available on the Industrial Controls catalog web site: www.ab.com/catalogs.

△ Note: Information for this product line is available in publication 150-SG010* or on the Industrial Controls catalog web site: www.ab.com/catalogs.

Reduced Voltage Starters

Modes of Operation

Modes of Operation

The SMC controllers provide the following modes of operation:

Soft Start

This method covers the most general applications. The motor is given an initial torque setting, which is user adjustable. From the initial torque level, the output voltage to the motor is steplessly increased during the acceleration ramp time, which is user adjustable.

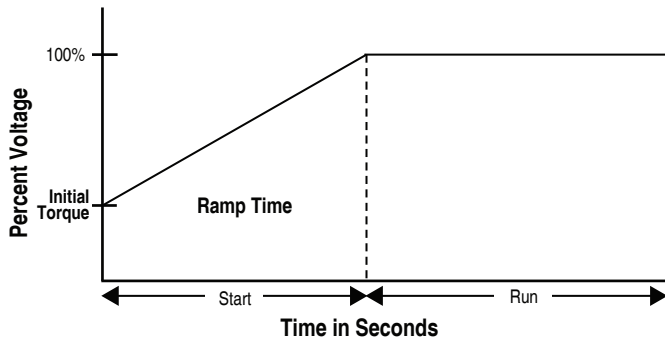

Selectable Kickstart

The kickstart feature provides a boost at startup to break away loads that may require a pulse of high torque to get started. It is intended to provide a current pulse, for a selected period of time.

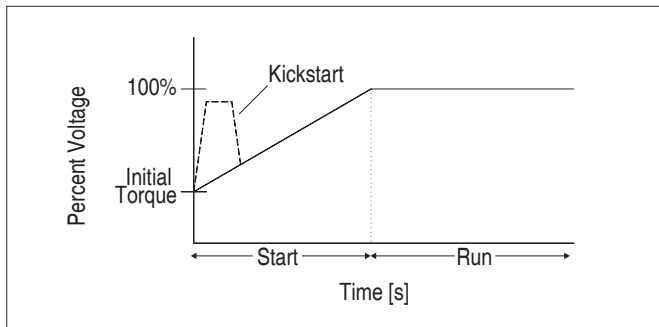

Current Limit Start

This method provides current limit start and is used when it is necessary to limit the maximum starting current. The starting current is user adjustable. The current limit starting time is user adjustable.

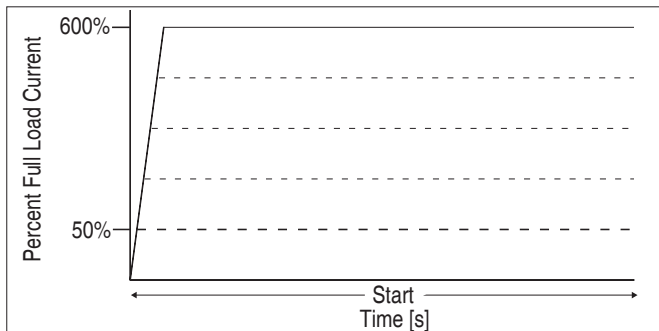

Dual Ramp Start

This starting method is useful on applications with varying loads, starting torque, and start time requirements. Dual Ramp Start offers the user the ability to select between two separate start profiles with separately adjustable ramp times and initial torque settings.

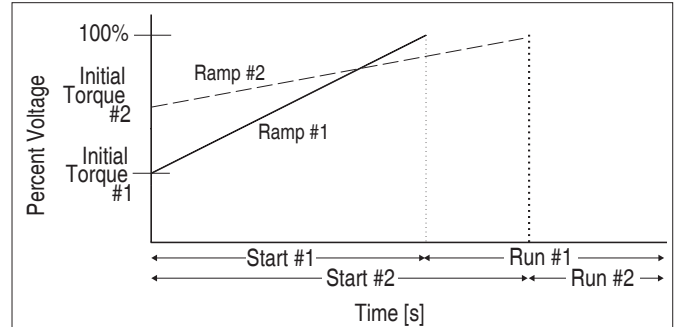

Full Voltage Start

This method is used in applications requiring across-the-line starting. The SMC controller performs like a solid-state contactor. Full inrush current and locked-rotor torque are realized. The SMC may be programmed to provide full voltage start in which the output voltage to the motor reaches full voltage.

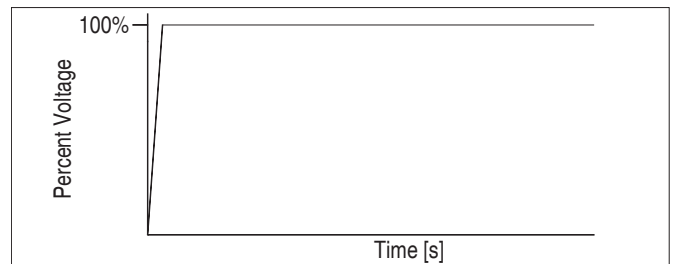

Linear Speed Acceleration

With this type of acceleration mode, a closed-loop feedback system maintains the motor acceleration at a constant rate. The required feedback signal is provided by a DC tachometer coupled to the motor (tachometer supplied by user 0...5V DC, 4.5V DC = 100% speed). Kickstart is available with this mode.

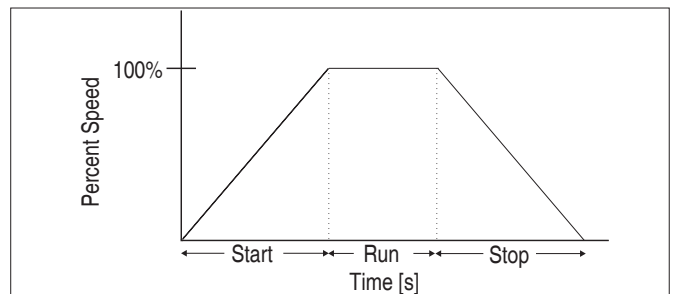

Preset Slow Speed

This method can be used on applications that require a slow speed for positioning material. The Preset Slow Speed can be set for either Low, 7% of base speed, or High, 15% of base speed. Reversing is also possible through programming. Speeds provided during reverse operation are (low) 10% of base speed, or (high) 20% of base speed.

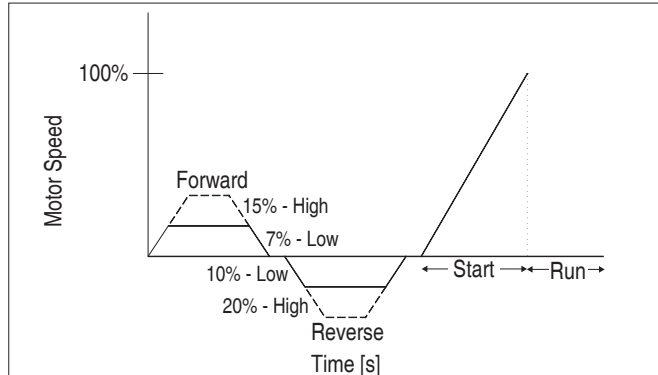

Soft Stop‡

The Soft Stop option can be used in applications requiring an extended coast-to-rest. The voltage ramp down time is user adjustable. The load will stop when the voltage drops to a point where the load torque is greater than the motor torque.

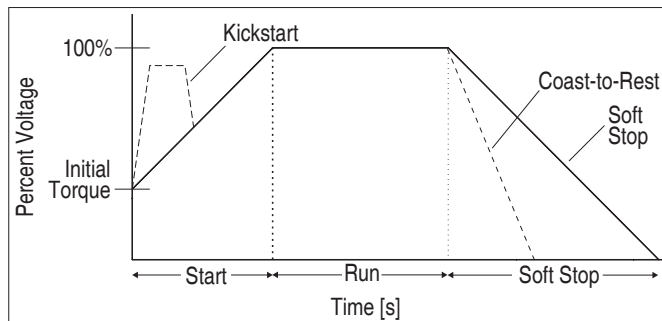

Pump Control Start and Stop‡

This option is used to reduce surges during the starting and stopping of a centrifugal pump by smoothly accelerating and decelerating the motor. The microprocessor analyzes the motor variables and generates commands which control motor torque and reduce the possibility of surges occurring in the system.

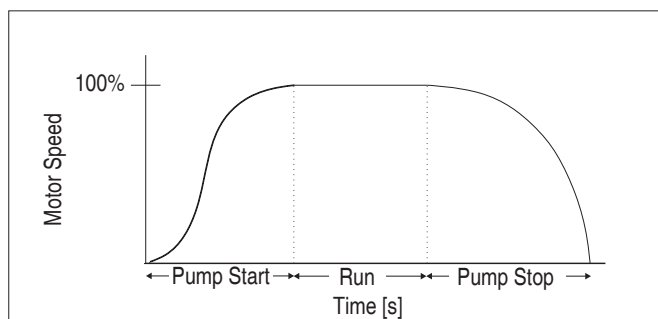

SMB Smart Motor Braking‡

This option provides motor braking for applications that require the motor to stop faster than a coast to rest. Braking control, with automatic zero speed shut off, is fully integrated into the compact design of the SMC controller. This design facilitates a clean, straight forward installation and eliminates the requirement for additional hardware such as braking contactors, resistors, timers, and speed sensors. The microprocessor based braking system applies braking current to a standard squirrel-cage induction motor. The strength of the braking current is user programmable.

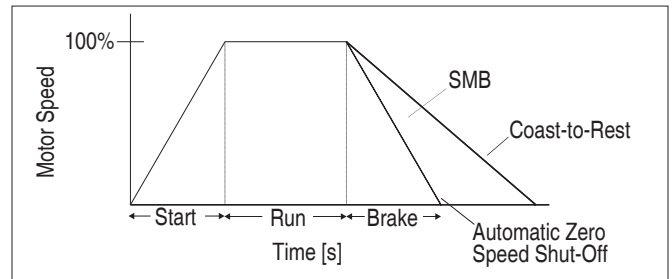

Accu-Stop‡

This option is used in applications requiring controlled position stopping. During stopping, braking torque is applied to the motor until it reaches preset slow speed (7% or 15% of rated speed) and holds the motor at this speed until a stop command is given. Braking torque is then applied until the motor reaches zero speed. Braking current and slow speed current are user programmable. Slow speed can be programmed for either 7% (low) or 15% (high).

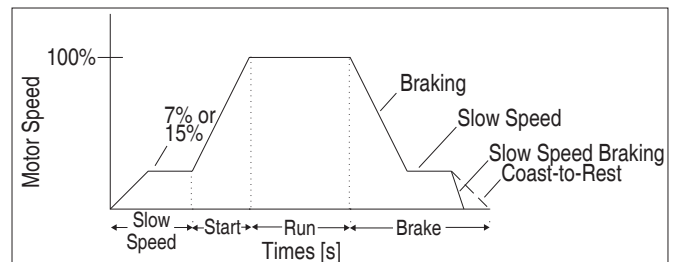

Slow Speed with Braking‡

Slow Speed with Braking is used on applications that require slow speed (in the forward direction) for positioning or alignment and also require braking control to stop. Slow speed adjustments are 7% (low) or 15% (high) of rated speed. Slow speed acceleration current, slow speed running current, and braking current are all adjustable.

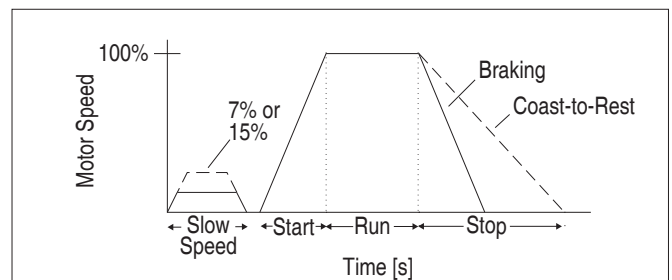

‡ Not intended to be used as an emergency stop. Refer to the applicable standards for emergency stop requirements.



Bulletin 150 — SMC™ Flex Smart Motor Controller

The SMC Flex controller provides microprocessor controlled starting for standard 3-phase squirrel-cage induction or Wye-Delta (6-lead) motors. Seven standard modes of operation are available within a single controller.

- 1...1250 A Range
- Seven Standard Start Modes
- Options Include Pump Control and Braking Control

Features

- Built in SCR Bypass/Run Contactor
- Built in Electronic Motor Overload Protection
- CT on each Phase
- Metering
- DPI Communication
- LCD Display
- Keypad Programming
- Four Programmable Auxiliary Contacts

The SMC Flex controller is available for motors rated 1...1250 A; 200...480V AC, 200...600V AC, or 230...690V AC, 50/60 Hz. In addition to motors, the SMC Flex controller can be used to control resistive loads.

Table of Contents

Features..... this page
 Cat. No. Explanation 8
 Product Selection..... 9
 Options 19
 Accessories..... 20
 Specifications..... 22
 Approx. Dims. 27

This catalog is based on the **minimum** information needed to select an SMC soft starter for applications with low starting torque requirements. For product selection involving loads with high starting torque requirements (large fan, rock crusher, chipper, etc.), use of the free tools available from the Rockwell Automation Website is recommended:

http://www.ab.com/industrialcontrols/products/solid-state_motor_control/software/

Standards Compliance

- UL 508
- CSA C22.2 No.14
- EN/IEC 60947-1
- EN/IEC 60947-4-2

Certifications

- cULus Listed (Open Type) (File No. E96956, Guides NMFT, NMFT7)
- CSA Certified (File No. LR 1234)
- CE Marked
- CCC Certified

Modes of Operation

The SMC Flex controller provides the following modes of operation as standard:

- Soft Start
- Selectable Kickstart
- Current Limit Start
- Dual Ramp Start
- Full Voltage Start
- Linear Speed Acceleration
- Preset Slow Speed
- Soft Stop

Optional Modes of Operation

Pump Control

- Start and Stop

Braking Control

- SMB — Smart Motor Braking
- Accu-Stop
- Slow Speed with Braking

Note: For detailed information about the different modes of operation, see page 4.

Description of Features

Electronic Motor Overload Protection

The SMC Flex controller incorporates, as standard, electronic motor overload protection. This overload protection is accomplished electronically with an I^2t algorithm.

When coordinated with the proper short-circuit protection, overload protection is intended to protect the motor, motor controller, and power wiring against overheating caused by excessive overcurrent. The SMC Flex controller meets applicable requirements as a motor overload protective device.

The controller's overload protection is programmable, providing the user with flexibility. The overload trip class consists of either OFF, 10, 15, 20, or 30 protection. The trip current is programmed by entering the motor full-load current rating, service factor, and selecting the trip class.

Thermal memory is included to accurately model motor operating temperature. Ambient temperature insensitivity is inherent in the electronic design of the overload.

Undervoltage Protection

The SMC Flex controller's undervoltage protection will halt motor operation if a drop in the incoming line voltage is detected. The undervoltage trip level is adjustable as a percentage of the programmed line voltage, from 0...99%. To eliminate nuisance trips, a programmable undervoltage trip delay time of 0...99 seconds can also be programmed. The line voltage must remain below the undervoltage trip level during the programmed delay time.

Overvoltage Protection

If a rise in the incoming line voltage is detected, the SMC Flex controller's overvoltage protection will halt motor operation. The overvoltage trip level is adjustable as a percentage of the programmed line voltage, from 0...199%. To eliminate nuisance trips, a programmable overvoltage trip delay time of 0...99 seconds can also be programmed. The line voltage must remain above the overvoltage trip level during the programmed delay time.

Stall Protection and Jam Detection

Motors can experience locked-rotor currents and develop high torque levels in the event of a stall or a jam. These conditions can result in winding insulation breakdown or mechanical damage to the connected load. The SMC Flex controller provides both stall protection and jam detection for enhanced motor and system protection. Stall protection allows the user to program a maximum stall protection delay time from 0...10 seconds. The stall protection delay time is in addition to the programmed start time and begins only after the start time has timed out. If the controller senses that the motor is stalled, it will shut down after the delay period has expired. Jam detection allows the user to determine the motor jam detection level as a percentage of the motor's full-load current rating. To prevent nuisance tripping, a jam detection delay time, from 0.0...99.0 seconds, can be programmed. This allows the user to select the time delay required before the SMC Flex controller will trip on a motor jam condition. The motor current must remain above the jam detection level during the delay time. Jam detection is active only after the motor has reached full speed.

Underload Protection

Utilizing the underload protection of the SMC Flex controller, motor operation can be halted if a drop in current is sensed. The SMC Flex controller provides an adjustable underload trip setting from 0...99% of the programmed motor full-load current rating with an adjustable trip delay time of 0...99 seconds.

Voltage Unbalance Protection

Voltage unbalance is detected by monitoring the 3-phase supply voltage magnitudes in conjunction with the rotational relationship of the three phases. The controller will halt motor operation when the calculated voltage unbalance reaches the user-programmed trip level.

The voltage unbalance trip level is programmable from 0...25% unbalance.

Excessive Starts Per Hour

The SMC Flex controller allows the user to program the allowed number of starts per hour (up to 99). This helps eliminate motor stress caused by repeated starting during a short time period.

Metering

Power monitoring parameters include:

- 3-phase current
- 3-phase voltage
- Power in kW or MW
- Power usage in kWh or MWh
- Power Factor
- Motor thermal capacity usage
- Elapsed time

Note: The motor thermal capacity usage allows the user to monitor the amount of overload thermal capacity usage before the SMC Flex controller's built-in electronic overload trips.

Built-in DPI Communication Capabilities

A serial interface port is provided as standard, which allows connection to a Bulletin 20 Human Interface Module and a variety of Bulletin 20-COMM Communication Modules. This includes Allen-Bradley Remote I/O, DeviceNet, ControlNet, Ethernet, ProfiBUS, Interbus, and RS485-DF1.

LCD Display

The SMC Flex controller's three-line 16-character backlit LCD display provides parameter identification using clear, informative text. Controller set up can be performed quickly and easily without the use of a reference manual. Parameters are arranged in an organized four-level menu structure for ease of programming and fast access to parameters.

Keypad Programming

Programming of parameters is accomplished through a five-button keypad on the front of the SMC Flex controller. The five buttons include up and down arrows, an Enter button, a Select button, and an Escape button. The user needs only to enter the correct sequence of keystrokes for programming the SMC Flex controller.

Auxiliary Contacts

Four fully programmable hard contacts are furnished as standard with the SMC Flex controller:

Aux #1, Aux #2, Aux #3, Aux #4

- N.O./N.C.
- Normal/Up-to-Speed/External Bypass/Fault/Alarm/Network

Network I/O

The SMC Flex can have up to two inputs and four outputs controlled via a communication network. The output contacts use the auxiliary contacts.

Ground Fault Input

The SMC Flex can monitor for ground fault conditions. An external core balance current transformer is required for this function. See SMC Flex User Manual for additional information.

Tach Input

A motor tachometer is required for the Linear Speed Start mode. Please see the Specifications section on page 22 for tachometer characteristics.

PTC Input

A motor PTC input can be monitored by the SMC Flex. In the event of a fault, the SMC Flex will shut down and indicate a motor PTC fault.



Open and Non-Combination

150 – F135 F B D B – 8L
a b c d e f g

a

Bulletin Number	
Code	Description
150	Solid-State Controller
150B	Enclosed Solid-State Controller with Isolation Contactor

c

Enclosure Type	
Code	Description
F	NEMA Type 4/12 (IP65) (Non-Combination Only)
J	NEMA Type 12 (IP54)
N	Open

e

Control Voltage	
Code	Description
D	100...240V AC (5...480 A units)
R	24V AC/DC (5...480 A units) (Open Only)
E	110/120V AC (625...1250 A units)
A	230/240V AC (625...1250 A units)

b

Controller Ratings	
Code	Description
F5	5 A, 3 Hp @ 460V AC
F25	25 A, 15 Hp @ 460V AC
F43	43 A, 30 Hp @ 460V AC
F60	60 A, 40 Hp @ 460V AC
F85	85 A, 60 Hp @ 460V AC
F108	108 A, 75 Hp @ 460V AC
F135	135 A, 100 Hp @ 460V AC
F201	201 A, 150 Hp @ 460V AC
F251	251 A, 200 Hp @ 460V AC
F317	317 A, 250 Hp @ 460V AC
F361	361 A, 300 Hp @ 460V AC
F480	480 A, 400 Hp @ 460V AC
F625	625 A, 500 Hp @ 460V AC
F780	780 A, 600 Hp @ 460V AC
F970	970 A, 800 Hp @ 460V AC
F1250	1250 A, 1000 Hp @ 460V AC

d

Input Line Voltage	
Open Type	
Code	Description
B	200...460V AC, 3-phase, 50 and 60 Hz
C	200...575V AC, 3-phase, 50 and 60 Hz
Z	230...690V AC, 3-phase, 50 and 60 Hz (Open Only, 108 A and above)
Non-Combination Enclosed Only	
H	200...208V AC, 3-phase, 50 and 60 Hz
A	230V AC, 3-phase, 50 and 60 Hz
B	400...460V AC, 3-phase, 50 and 60 Hz
C	500...575V AC, 3-phase, 50 and 60 Hz

f

Options (Select Only One)	
Code	Description
Blank	Standard
B	Pump Control
D	Braking Control

g

Options (Non-Combination only) (see page 19 for a full listing)	
Code	Description
8L	Line-Mounted Protective Module (enclosed only)
8M	Load-Mounted Protective Module (enclosed only)
8B	Line- and Load-Mounted Protective Modules (enclosed only)

Load-side MOVs are not available with Pump and Braking options, or on delta-connected motors. MOVs can be field installed for open type units.

Combination

152H – F480 F BD B – 59 – 8B
a b c d e f g

a

Bulletin Number	
Code	Description
152H	Solid-State Controller with Fusible Disconnect
152B	Solid-State Controller with Fusible Disconnect and Isolation Contactor
153H	Solid-State Controller with Circuit Breaker
153B	Solid-State Controller with Circuit Breaker and Isolation Contactor

c

Enclosure Type	
Code	Description
F	NEMA Type 4/12 (IP65)
J	NEMA Type 12 (IP54)

e

Control Options	
Code	Description
Blank	Standard
B	Pump Control
D	Braking Control

b

Controller Ratings	
Code	Description
F5	5 A, 3 Hp @ 460V AC
F25	25 A, 15 Hp @ 460V AC
F43	43 A, 30 Hp @ 460V AC
F60	60 A, 40 Hp @ 460V AC
F85	85 A, 60 Hp @ 460V AC
F108	108 A, 75 Hp @ 460V AC
F135	135 A, 100 Hp @ 460V AC
F201	201 A, 150 Hp @ 460V AC
F251	251 A, 200 Hp @ 460V AC
F317	317 A, 250 Hp @ 460V AC
F361	361 A, 300 Hp @ 460V AC
F480	480 A, 400 Hp @ 460V AC
F625	625 A, 500 Hp @ 460V AC
F780	780 A, 600 Hp @ 460V AC

d

Line Voltage, 120V AC Control Voltage	
Code	Description
HD	200...208V AC, 3-phase, 50 and 60 Hz
AD	230V AC, 3-phase, 50 and 60 Hz
BD	400...460V AC, 3-phase, 50 and 60 Hz
CD	500...575V AC, 3-phase, 50 and 60 Hz

g

Options (see page 19 for a full listing)	
Code	Description
8L	Line-Mounted Protective Module
8M	Load-Mounted Protective Module
8B	Line- and Load-Mounted Protective Modules

Load-side MOVs are not available with Pump and Braking options, or when used with inside-the-delta connections.

f

Horsepower									
Cat. No.	Hp Rating	Cat. No.	Hp Rating	Cat. No.	Hp Rating	Cat. No.	Hp Rating	Cat. No.	Hp Rating
33	0.5	39	5	46	40	52	150	60	450
34	0.75	40	7.5	47	50	54	200	61	500
35	1	41	10	48	60	56	250	62	600
36	1.5	42	15	49	75	57	300	63	700
37	2	43	20	50	100	58	350	65	800
38	3	44	25	51	125	59	400	67	1000
—	—	45	30	—	—	—	—	—	—

Open Type and Non-Combination Enclosed (IP65, Type 4/12) Controllers — For use with Line-Connected Motors

Enclosures other than those listed are available; consult your local Rockwell Automation sales office or Allen-Bradley distributor.

Rated Voltage [V AC]	Motor Current [A]‡	Max. kW, 50 Hz	Max. Hp, 60 Hz	Control Power	Open Type — Line-Connected Motors★	IP65 (Type 4/12) Enclosed Non-Combination Controllers♣♦
					Cat. No.	Cat. No.
200/208	1...5	—	1	100...240V AC, 50/60 Hz	150-F5NBD	150-F5FHD
				24V AC/DC△	150-F5NBR	—
	5...25	—	5	100...240V AC, 50/60 Hz	150-F25NBD	150-F25FHD
				24V AC/DC△	150-F25NBR	—
	8.6...43	—	10	100...240V AC, 50/60 Hz	150-F43NBD	150-F43FHD
				24V AC/DC△	150-F43NBR	—
	12...60	—	15	100...240V AC, 50/60 Hz	150-F60NBD	150-F60FHD
				24V AC/DC△	150-F60NBR	—
	17...85	—	25	100...240V AC, 50/60 Hz	150-F85NBD	150-F85FHD
				24V AC/DC△	150-F85NBR	—
	27...108	—	30	100...240V AC, 50/60 Hz	150-F108NBD	150-F108FHD
				24V AC/DC△	150-F108NBR	—
	34...135	—	40	100...240V AC, 50/60 Hz	150-F135NBD	150-F135FHD
				24V AC/DC△	150-F135NBR	—
	67...201	—	60	100...240V AC, 50/60 Hz	150-F201NBD	150-F201FHD
				24V AC/DC△	150-F201NBR	—
	84...251	—	75	100...240V AC, 50/60 Hz	150-F251NBD	150-F251FHD
				24V AC/DC△	150-F251NBR	—
	106...317	—	100	100...240V AC, 50/60 Hz	150-F317NBD	150-F317FHD
				24V AC/DC△	150-F317NBR	—
120...361	—	125	100...240V AC, 50/60 Hz	150-F361NBD	150-F361FHD	
			24V AC/DC△	150-F361NBR	—	
160...480	—	150	100...240V AC, 50/60 Hz	150-F480NBD	150-F480FHD	
			24V AC/DC△	150-F480NBR	—	
208...625	—	200	110/120V AC, 50/60 Hz	150-F625NBE	♣ 150-F625JHE	
			230/240V AC, 50/60 Hz	150-F625NBA	♣ 150-F625JHA	
260...780	—	250	110/120V AC, 50/60 Hz	150-F780NBE	♣ 150-F780JHE	
			230/240V AC, 50/60 Hz	150-F780NBA	♣ 150-F780JHA	
323...970	—	350	110/120V AC, 50/60 Hz	150-F970NBE	—	
			230/240V AC, 50/60 Hz	150-F970NBA	—	
416...1250	—	400	110/120V AC, 50/60 Hz	150-F1250NBE	—	
			230/240V AC, 50/60 Hz	150-F1250NBA	—	

★ Controllers rated 108 A and greater are not equipped with line and load terminal lugs. See page 20 for terminal lug kits.

‡ Motor FLA rating should fall within specified current range for unit to operate properly. Special consideration should be given when using a motor with a potentially high starting current (greater than ten times motor FLA) with the SMC Flex in the "Full Voltage" starting mode. Contact Rockwell Automation technical support for further guidance.

♣ These controllers require a separate 100...240V, 50/60 Hz single-phase control source. To add a control circuit transformer to the enclosure, add the appropriate option code to the catalog string.

△ Separate 120V or 240V single-phase power supply is required for fan operation.

♦ Line and load termination are provided as standard.

♣ Available in IP54 (Type 12) enclosure only.

SMC™ Flex Smart Motor Controllers

Product Selection

Open Type and Non-Combination Enclosed (IP65, Type 4/12) Controllers — For use with Line-Connected Motors, Continued

Enclosures other than those listed are available; consult your local Rockwell Automation sales office or Allen-Bradley distributor.

Rated Voltage [V AC]	Motor Current [A]‡	Max. kW, 50 Hz	Max. Hp, 60 Hz	Control Power	Open Type — Line-Connected Motors ★	IP65 (Type 4/12) Enclosed Non-Combination Controllers ★♦
					Cat. No.	Cat. No.
230	1...5	1.1	1	100...240V AC, 50/60 Hz	150-F5NBD	150-F5FAD
				24V AC/DC△	150-F5NBR	—
	5...25	5.5	7.5	100...240V AC, 50/60 Hz	150-F25NBD	150-F25FAD
				24V AC/DC△	150-F25NBR	—
	8.6...43	11	15	100...240V AC, 50/60 Hz	150-F43NBD	150-F43FAD
				24V AC/DC△	150-F43NBR	—
	12...60	15	20	100...240V AC, 50/60 Hz	150-F60NBD	150-F60FAD
				24V AC/DC△	150-F60NBR	—
	17...85	22	30	100...240V AC, 50/60 Hz	150-F85NBD	150-F85FAD
				24V AC/DC△	150-F85NBR	—
	27...108	30	40	100...240V AC, 50/60 Hz	150-F108NBD	150-F108FAD
				24V AC/DC△	150-F108NBR	—
	34...135	37	50	100...240V AC, 50/60 Hz	150-F135NBD	150-F135FAD
				24V AC/DC△	150-F135NBR	—
	67...201	55	75	100...240V AC, 50/60 Hz	150-F201NBD	150-F201FAD
				24V AC/DC△	150-F201NBR	—
	84...251	75	100	100...240V AC, 50/60 Hz	150-F251NBD	150-F251FAD
				24V AC/DC△	150-F251NBR	—
	106...317	90	125	100...240V AC, 50/60 Hz	150-F317NBD	150-F317FAD
				24V AC/DC△	150-F317NBR	—
	120...361	110	150	100...240V AC, 50/60 Hz	150-F361NBD	150-F361FAD
				24V AC/DC△	150-F361NBR	—
	160...480	132	200	100...240V AC, 50/60 Hz	150-F480NBD	150-F480FAD
				24V AC/DC△	150-F480NBR	—
208...625	200	250	110/120V AC, 50/60 Hz	150-F625NBE	▲ 150-F625JAE	
			230/240V AC, 50/60 Hz	150-F625NBA	▲ 150-F625JAA	
260...780	250	300	110/120V AC, 50/60 Hz	150-F780NBE	▲ 150-F780JAE	
			230/240V AC, 50/60 Hz	150-F780NBA	▲ 150-F780JAA	
323...970	315	400	110/120V AC, 50/60 Hz	150-F970NBE	—	
			230/240V AC, 50/60 Hz	150-F970NBA	—	
416...1250	400	500	110/120V AC, 50/60 Hz	150-F1250NBE	—	
			230/240V AC, 50/60 Hz	150-F1250NBA	—	

★ Controllers rated 108 A and greater are not equipped with line and load terminal lugs. See page 20 for terminal lug kits.

‡ Motor FLA rating should fall within specified current range for unit to operate properly. Special consideration should be given when using a motor with a potentially high starting current (greater than ten times motor FLA) with the SMC Flex in the "Full Voltage" starting mode. Contact Rockwell Automation technical support for further guidance.

✦ These controllers require a separate 100...240V, 50/60 Hz single-phase control source. To add a control circuit transformer to the enclosure, add the appropriate option code to the catalog string.

△ Separate 120V or 240V single-phase power supply is required for fan operation.

♦ Line and load termination are provided as standard.

▲ Available in IP54 (Type 12) enclosure only.

Open Type and Non-Combination Enclosed (IP65, Type 4/12) Controllers — For use with Line-Connected Motors, Continued

Enclosures other than those listed are available; consult your local Rockwell Automation sales office or Allen-Bradley distributor.

Rated Voltage [V AC]	Motor Current [A]‡	Max. kW, 50 Hz	Max. Hp, 60 Hz	Control Power	Open Type — Line-Connected Motors★	IP65 (Type 4/12) Enclosed Non-Combination Controllers♣♠
					Cat. No.	Cat. No.
400/415/460	1...5	2.2	3	100...240V AC, 50/60 Hz	150-F5NBD	150-F5FBD
				24V AC/DC△	150-F5NBR	—
	5...25	11	15	100...240V AC, 50/60 Hz	150-F25NBD	150-F25FBD
				24V AC/DC△	150-F25NBR	—
	8.6...43	22	30	100...240V AC, 50/60 Hz	150-F43NBD	150-F43FBD
				24V AC/DC△	150-F43NBR	—
	12...60	30	40	100...240V AC, 50/60 Hz	150-F60NBD	150-F60FBD
				24V AC/DC△	150-F60NBR	—
	17...85	45	60	100...240V AC, 50/60 Hz	150-F85NBD	150-F85FBD
				24V AC/DC△	150-F85NBR	—
	27...108	55	75	100...240V AC, 50/60 Hz	150-F108NBD	150-F108FBD
				24V AC/DC△	150-F108NBR	—
	34...135	75	100	100...240V AC, 50/60 Hz	150-F135NBD	150-F135FBD
				24V AC/DC△	150-F135NBR	—
	67...201	110	150	100...240V AC, 50/60 Hz	150-F201NBD	150-F201FBD
				24V AC/DC△	150-F201NBR	—
	84...251	132	200	100...240V AC, 50/60 Hz	150-F251NBD	150-F251FBD
				24V AC/DC△	150-F251NBR	—
	106...317	160	250	100...240V AC, 50/60 Hz	150-F317NBD	150-F317FBD
				24V AC/DC△	150-F317NBR	—
120...361	200	300	100...240V AC, 50/60 Hz	150-F361NBD	150-F361FBD	
			24V AC/DC△	150-F361NBR	—	
160...480	250	400	100...240V AC, 50/60 Hz	150-F480NBD	150-F480FBD	
			24V AC/DC△	150-F480NBR	—	
208...625	355	500	110/120V AC, 50/60 Hz	150-F625NBE	♠ 150-F625JBE	
			230/240V AC, 50/60 Hz	150-F625NBA	♠ 150-F625JBA	
260...780	450	600	110/120V AC, 50/60 Hz	150-F780NBE	♠ 150-F780JBE	
			230/240V AC, 50/60 Hz	150-F780NBA	♠ 150-F780JBA	
323...970	560	800	110/120V AC, 50/60 Hz	150-F970NBE	—	
			230/240V AC, 50/60 Hz	150-F970NBA	—	
416...1250	710	1000	110/120V AC, 50/60 Hz	150-F1250NBE	—	
			230/240V AC, 50/60 Hz	150-F1250NBA	—	

★ Controllers rated 108 A and greater are not equipped with line and load terminal lugs. See page 20 for terminal lug kits.

‡ Motor FLA rating should fall within specified current range for unit to operate properly. Special consideration should be given when using a motor with a potentially high starting current (greater than ten times motor FLA) with the SMC Flex in the "Full Voltage" starting mode. Contact Rockwell Automation technical support for further guidance.

♣ These controllers require a separate 100...240V, 50/60 Hz single-phase control source. To add a control circuit transformer to the enclosure, add the appropriate option code to the catalog string.

△ Separate 120V or 240V single-phase power supply is required for fan operation.

♠ Line and load termination are provided as standard.

♠ Available in IP54 (Type 12) enclosure only.



SMC™ Flex Smart Motor Controllers

Product Selection

Open Type and Non-Combination Enclosed (IP65, Type 4/12) Controllers — For use with Line-Connected Motors, Continued

Enclosures other than those listed are available; consult your local Rockwell Automation sales office or Allen-Bradley distributor.

Rated Voltage [V AC]	Motor Current [A]‡	Max. kW, 50 Hz	Max. Hp, 60 Hz	Control Power	Open Type — Line-Connected Motors ★	IP65 (Type 4/12) Enclosed Non-Combination Controllers ♦♦
					Cat. No.	Cat. No.
500/575	1...5	2.2	3	100...240V AC, 50/60 Hz	150-F5NCD	150-F5FCD
				24V AC/DC△	150-F5NCR	—
	5...25	15	20	100...240V AC, 50/60 Hz	150-F25NCD	150-F25FCD
				24V AC/DC△	150-F25NCR	—
	8.6...43	22	40	100...240V AC, 50/60 Hz	150-F43NCD	150-F43FCD
				24V AC/DC△	150-F43NCR	—
	12...60	37	50	100...240V AC, 50/60 Hz	150-F60NCD	150-F60FCD
				24V AC/DC△	150-F60NCR	—
	17...85	55	75	100...240V AC, 50/60 Hz	150-F85NCD	150-F85FCD
				24V AC/DC△	150-F85NCR	—
	27...108	75	100	100...240V AC, 50/60 Hz	150-F108NCD	150-F108FCD
				24V AC/DC△	150-F108NCR	—
	34...135	90	125	100...240V AC, 50/60 Hz	150-F135NCD	150-F135FCD
				24V AC/DC△	150-F135NCR	—
	67...201	132	200	100...240V AC, 50/60 Hz	150-F201NCD	150-F201FCD
				24V AC/DC△	150-F201NCR	—
	84...251	160	250	100...240V AC, 50/60 Hz	150-F251NCD	150-F251FCD
				24V AC/DC△	150-F251NCR	—
	106...317	200	300	100...240V AC, 50/60 Hz	150-F317NCD	150-F317FCD
				24V AC/DC△	150-F317NCR	—
120...361	250	350	100...240V AC, 50/60 Hz	150-F361NCD	150-F361FCD	
			24V AC/DC△	150-F361NCR	—	
160...480	315	500	100...240V AC, 50/60 Hz	150-F480NCD	150-F480FCD	
			24V AC/DC△	150-F480NCR	—	
208...625	450	600	110/120V AC, 50/60 Hz	150-F625NCE	▲ 150-F625JCE	
			230/240V AC, 50/60 Hz	150-F625NCA	▲ 150-F625JCA	
260...780	560	800	110/120V AC, 50/60 Hz	150-F780NCE	▲ 150-F780JCE	
			230/240V AC, 50/60 Hz	150-F780NCA	▲ 150-F780JCA	
323...970	710	1000	110/120V AC, 50/60 Hz	150-F970NCE	—	
			230/240V AC, 50/60 Hz	150-F970NCA	—	
416...1250	900	1300	110/120V AC, 50/60 Hz	150-F1250NCE	—	
			230/240V AC, 50/60 Hz	150-F1250NCA	—	

Rated Voltage [V AC]	Motor Current [A]‡	Max. kW, 50 Hz	Max. Hp, 60 Hz	Control Power	Open Type — Line-Connected Motors ★
					Cat. No.
690/Y§	27...108	90	100	100...240V AC, 50/60 Hz	150-F108N2D
				110/120V AC, 50/60 Hz	150-F108N2E
	34...135	132	175	100...240V AC, 50/60 Hz	150-F135N2D
				110/120V AC, 50/60 Hz	150-F135N2E
	67...201	160	200	100...240V AC, 50/60 Hz	150-F201N2D
				110/120V AC, 50/60 Hz	150-F201N2E
	84...251	200	250	100...240V AC, 50/60 Hz	150-F251N2D
				110/120V AC, 50/60 Hz	150-F251N2E
	106...317	315	400	100...240V AC, 50/60 Hz	150-F317N2D
				110/120V AC, 50/60 Hz	150-F317N2E
	120...361	355	450	100...240V AC, 50/60 Hz	150-F361N2D
				110/120V AC, 50/60 Hz	150-F361N2E
	160...480	450	600	100...240V AC, 50/60 Hz	150-F480N2D
				110/120V AC, 50/60 Hz	150-F480N2E
	208...625	630	800	110/120V AC, 50/60 Hz	150-F625N2E
				230/240V AC, 50/60 Hz	150-F625N2A
260...780	800	1000	110/120V AC, 50/60 Hz	150-F780N2E	
			230/240V AC, 50/60 Hz	150-F780N2A	
323...970	1000	1300	110/120V AC, 50/60 Hz	150-F970N2E	
			230/240V AC, 50/60 Hz	150-F970N2A	
416...1250	1200	1600	110/120V AC, 50/60 Hz	150-F1250N2E	
			230/240V AC, 50/60 Hz	150-F1250N2A	

★ Controllers rated 108 A and greater are not equipped with line and load terminal lugs. See page 20 for terminal lug kits.

‡ Motor FLA rating should fall within specified current range for unit to operate properly. Special consideration should be given when using a motor with a potentially high starting current (greater than ten times motor FLA) with the SMC Flex in the "Full Voltage" starting mode. Contact Rockwell Automation technical support for further guidance.

▲ These controllers require a separate 100...240V, 50/60 Hz single-phase control source. To add a control circuit transformer to the enclosure, add the appropriate option code to the catalog string.

△ Separate 120V or 240V single-phase power supply is required for fan operation.

♦ Line and load termination are provided as standard.

§ To be used only in a Y-type system.

▲ Available in IP54 (Type 12) enclosure only.

Open Type Controllers — For use with Delta-Connected Motors

Rated Voltage [V AC]	Motor Current [A]‡	Max. kW, 50 Hz	Max. Hp, 60 Hz	Control Power	Open Type ★
					Cat. No.
200/208	1.7...8.7	—	2	100...240V AC, 50/60 Hz	150-F5NBD
				24V AC/DC△	150-F5NBR
	8.7...43	—	10	100...240V AC, 50/60 Hz	150-F25NBD
				24V AC/DC△	150-F25NBR
	14.9...74	—	20	100...240V AC, 50/60 Hz	150-F43NBD
				24V AC/DC△	150-F43NBR
	20.8...104	—	30	100...240V AC, 50/60 Hz	150-F60NBD
				24V AC/DC△	150-F60NBR
	29.4...147	—	40	100...240V AC, 50/60 Hz	150-F85NBD
				24V AC/DC△	150-F85NBR
	47...187	—	60	100...240V AC, 50/60 Hz	150-F108NBD
				24V AC/DC△	150-F108NBR
	59...234	—	75	100...240V AC, 50/60 Hz	150-F135NBD
				24V AC/DC△	150-F135NBR
	116...348	—	100	100...240V AC, 50/60 Hz	150-F201NBD
				24V AC/DC△	150-F201NBR
	145...435	—	150	100...240V AC, 50/60 Hz	150-F251NBD
				24V AC/DC△	150-F251NBR
	183...549	—	200	100...240V AC, 50/60 Hz	150-F317NBD
				24V AC/DC△	150-F317NBR
208...625	—	200	100...240V AC, 50/60 Hz	150-F361NBD	
			24V AC/DC△	150-F361NBR	
277...831	—	300	100...240V AC, 50/60 Hz	150-F480NBD	
			24V AC/DC△	150-F480NBR	
283...850	—	300	110/120V AC, 50/60 Hz	150-F625NBE	
			230/240V AC, 50/60 Hz	150-F625NBA	
300...900	—	300	110/120V AC, 50/60 Hz	150-F780NBE	
			230/240V AC, 50/60 Hz	150-F780NBA	
400...1200	—	400	110/120V AC, 50/60 Hz	150-F970NBE	
			230/240V AC, 50/60 Hz	150-F970NBA	
533...1600	—	500	110/120V AC, 50/60 Hz	150-F1250NBE	
			230/240V AC, 50/60 Hz	150-F1250NBA	

★ Controllers rated 108 A and greater are not equipped with line and load terminal lugs. See page 20 for terminal lug kits.

‡ Motor FLA rating should fall within specified current range for unit to operate properly. Special consideration should be given when using a motor with a potentially high starting current (greater than ten times motor FLA) with the SMC Flex in the "Full Voltage" starting mode. Contact Rockwell Automation technical support for further guidance.

△ Separate 120V or 240V single-phase power supply is required for fan operation.

Bulletin 150
SMC™ Flex Smart Motor Controllers
 Product Selection

Open Type Controllers — For use with Delta-Connected Motors, Continued

Rated Voltage [V AC]	Motor Current [A]‡	Max. kW, 50 Hz	Max. Hp, 60 Hz	Control Power	Open Type ★
					Cat. No.
230	1.7...8.7	2.2	2	100...240V AC, 50/60 Hz	150-F5NBD
				24V AC/DC△	150-F5NBR
	8.7...43	11	15	100...240V AC, 50/60 Hz	150-F25NBD
				24V AC/DC△	150-F25NBR
	14.9...74	22	25	100...240V AC, 50/60 Hz	150-F43NBD
				24V AC/DC△	150-F43NBR
	20.8...104	30	40	100...240V AC, 50/60 Hz	150-F60NBD
				24V AC/DC△	150-F60NBR
	29.4...147	45	50	100...240V AC, 50/60 Hz	150-F85NBD
				24V AC/DC△	150-F85NBR
	47...187	55	60	100...240V AC, 50/60 Hz	150-F108NBD
				24V AC/DC△	150-F108NBR
	59...234	75	75	100...240V AC, 50/60 Hz	150-F135NBD
				24V AC/DC△	150-F135NBR
	116...348	110	125	100...240V AC, 50/60 Hz	150-F201NBD
				24V AC/DC△	150-F201NBR
	145...435	132	150	100...240V AC, 50/60 Hz	150-F251NBD
				24V AC/DC△	150-F251NBR
	183...549	160	200	100...240V AC, 50/60 Hz	150-F317NBD
				24V AC/DC△	150-F317NBR
208...625	200	250	100...240V AC, 50/60 Hz	150-F361NBD	
			24V AC/DC△	150-F361NBR	
277...831	250	350	100...240V AC, 50/60 Hz	150-F480NBD	
			24V AC/DC△	150-F480NBR	
283...850	250	350	110/120V AC, 50/60 Hz	150-F625NBE	
			230/240V AC, 50/60 Hz	150-F625NBA	
300...900	250	350	110/120V AC, 50/60 Hz	150-F780NBE	
			230/240V AC, 50/60 Hz	150-F780NBA	
400...1200	400	400	110/120V AC, 50/60 Hz	150-F970NBE	
			230/240V AC, 50/60 Hz	150-F970NBA	
533...1600	500	600	110/120V AC, 50/60 Hz	150-F1250NBE	
			230/240V AC, 50/60 Hz	150-F1250NBA	

★ Controllers rated 108 A and greater are not equipped with line and load terminal lugs. See page 20 for terminal lug kits.
 ‡ Motor FLA rating should fall within specified current range for unit to operate properly. Special consideration should be given when using a motor with a potentially high starting current (greater than ten times motor FLA) with the SMC Flex in the "Full Voltage" starting mode. Contact Rockwell Automation technical support for further guidance.
 △ Separate 120V or 240V single-phase power supply is required for fan operation.

Open Type Controllers — For use with Delta-Connected Motors, Continued

Rated Voltage [V AC]	Motor Current [A]‡	Max. kW, 50 Hz	Max. Hp, 60 Hz	Control Power	Open Type ★
					Cat. No.
400/415/460	1.7...8.7	4	5	100...240V AC, 50/60 Hz	150-F5NBD
				24V AC/DC△	150-F5NBR
	8.7...43	22	30	100...240V AC, 50/60 Hz	150-F25NBD
				24V AC/DC△	150-F25NBR
	14.9...74	37	50	100...240V AC, 50/60 Hz	150-F43NBD
				24V AC/DC△	150-F43NBR
	20.8...104	55	75	100...240V AC, 50/60 Hz	150-F60NBD
				24V AC/DC△	150-F60NBR
	29.4...147	75	100	100...240V AC, 50/60 Hz	150-F85NBD
				24V AC/DC△	150-F85NBR
	47...187	90	150	100...240V AC, 50/60 Hz	150-F108NBD
				24V AC/DC△	150-F108NBR
	59...234	132	150	100...240V AC, 50/60 Hz	150-F135NBD
				24V AC/DC△	150-F135NBR
	116...348	160	250	100...240V AC, 50/60 Hz	150-F201NBD
				24V AC/DC△	150-F201NBR
	145...435	250	350	100...240V AC, 50/60 Hz	150-F251NBD
				24V AC/DC△	150-F251NBR
	183...549	315	450	100...240V AC, 50/60 Hz	150-F317NBD
				24V AC/DC△	150-F317NBR
208...625	355	500	100...240V AC, 50/60 Hz	150-F361NBD	
			24V AC/DC△	150-F361NBR	
277...831	450	700	100...240V AC, 50/60 Hz	150-F480NBD	
			24V AC/DC△	150-F480NBR	
283...850	500	700	110/120V AC, 50/60 Hz	150-F625NBE	
			230/240V AC, 50/60 Hz	150-F625NBA	
300...900	500	700	110/120V AC, 50/60 Hz	150-F780NBE	
			230/240V AC, 50/60 Hz	150-F780NBA	
400...1200	710	1000	110/120V AC, 50/60 Hz	150-F970NBE	
			230/240V AC, 50/60 Hz	150-F970NBA	
533...1600	900	1400	110/120V AC, 50/60 Hz	150-F1250NBE	
			230/240V AC, 50/60 Hz	150-F1250NBA	

★ Controllers rated 108 A and greater are not equipped with line and load terminal lugs. See page 20 for terminal lug kits.

‡ Motor FLA rating should fall within specified current range for unit to operate properly. Special consideration should be given when using a motor with a potentially high starting current (greater than ten times motor FLA) with the SMC Flex in the "Full Voltage" starting mode. Contact Rockwell Automation technical support for further guidance.

△ Separate 120V or 240V single-phase power supply is required for fan operation.

Bulletin 150
SMC™ Flex Smart Motor Controllers
 Product Selection

Open Type Controllers — For use with Delta-Connected Motors, Continued

Rated Voltage [V AC]	Motor Current [A]‡	Max. kW, 50 Hz	Max. Hp, 60 Hz	Control Power	Open Type ★
					Cat. No.
500/575	1.7...8.7	5.5	7.5	100...240V AC, 50/60 Hz	150-F5NCD
				24V AC/DC△	150-F5NCR
	8.7...43	15	40	100...240V AC, 50/60 Hz	150-F25NCD
				24V AC/DC△	150-F25NCR
	14.9...74	45	60	100...240V AC, 50/60 Hz	150-F43NCD
				24V AC/DC△	150-F43NCR
	20.8...104	55	100	100...240V AC, 50/60 Hz	150-F60NCD
				24V AC/DC△	150-F60NCR
	29.4...147	90	150	100...240V AC, 50/60 Hz	150-F85NCD
				24V AC/DC△	150-F85NCR
	47...187	132	150	100...240V AC, 50/60 Hz	150-F108NCD
				24V AC/DC△	150-F108NCR
	59...234	160	200	100...240V AC, 50/60 Hz	150-F135NCD
				24V AC/DC△	150-F135NCR
	116...348	250	300	100...240V AC, 50/60 Hz	150-F201NCD
				24V AC/DC△	150-F201NCR
	145...435	315	400	100...240V AC, 50/60 Hz	150-F251NCD
				24V AC/DC△	150-F251NCR
	183...549	400	500	100...240V AC, 50/60 Hz	150-F317NCD
				24V AC/DC△	150-F317NCR
208...625	450	600	100...240V AC, 50/60 Hz	150-F361NCD	
			24V AC/DC△	150-F361NCR	
277...831	560	900	100...240V AC, 50/60 Hz	150-F480NCD	
			24V AC/DC△	150-F480NCR	
283...850	560	900	110/120V AC, 50/60 Hz	150-F625NCE	
			230/240V AC, 50/60 Hz	150-F625NCA	
300...900	630	900	110/120V AC, 50/60 Hz	150-F780NCE	
			230/240V AC, 50/60 Hz	150-F780NCA	
400...1200	800	1300	110/120V AC, 50/60 Hz	150-F970NCE	
			230/240V AC, 50/60 Hz	150-F970NCA	
533...1600	1100	1600	110/120V AC, 50/60 Hz	150-F1250NCE	
			230/240V AC, 50/60 Hz	150-F1250NCA	

★ Controllers rated 108 A and greater are not equipped with line and load terminal lugs. See page 20 for terminal lug kits.
 ‡ Motor FLA rating should fall within specified current range for unit to operate properly. Special consideration should be given when using a motor with a potentially high starting current (greater than ten times motor FLA) with the SMC Flex in the "Full Voltage" starting mode. Contact Rockwell Automation technical support for further guidance.
 △ Separate 120V or 240V single-phase power supply is required for fan operation.

Combination Line-Connected Controllers — IP65 (Type 4/12) Enclosed with Fusible Disconnect or Circuit Breaker

Rated Voltage [V AC]	kW, 50 Hz	Hp, 60 Hz	Controller Current Rating [A] ‡	IP65 (Type 4/12) Enclosed Combination Controllers with Fusible Disconnect★		IP65 (Type 4/12) Enclosed Combination Controllers with Circuit Breaker★	
				Cat. No.♣		Cat. No.	
200	—	0.5	5		152H-F5FHD-33		153H-F5FHD-33
	—	0.75	5		152H-F5FHD-34		153H-F5FHD-34
	—	1	5		152H-F5FHD-35		153H-F5FHD-35
	—	1.5	25		152H-F25FHD-36		153H-F25FHD-36
	—	2	25		152H-F25FHD-37		153H-F25FHD-37
	—	3	25		152H-F25FHD-38		153H-F25FHD-38
	—	5	25		152H-F25FHD-39		153H-F25FHD-39
	—	5	25		152H-F25FHD-40		153H-F25FHD-40
	—	10	43		152H-F43FHD-41		153H-F43FHD-41
	—	15	60		152H-F60FHD-42		153H-F60FHD-42
	—	20	85		152H-F85FHD-43		153H-F85FHD-43
	—	25	85		152H-F85FHD-44		153H-F85FHD-44
	—	30	108		152H-F108FHD-45		153H-F108FHD-45
	—	40	135		152H-F135FHD-46		153H-F135FHD-46
	—	50	201		152H-F201FHD-47		153H-F201FHD-47
	—	60	201		152H-F201FHD-48		153H-F201FHD-48
	—	75	251		152H-F251FHD-49		153H-F251FHD-49
	—	100	317		152H-F317FHD-50		153H-F317FHD-50
	—	125	361		152H-F361FHD-51		153H-F361FHD-51
	—	150	480		152H-F480FHD-52		153H-F480FHD-52
—	200	625	Δ	152H-F625JHD-54	Δ	153H-F625JHD-54	
—	250	780	Δ	152H-F780JHD-56	Δ	153H-F780JHD-56	
230	0.37	0.5	5		152H-F5FAD-33		153H-F5FAD-33
	0.55	0.75	5		152H-F5FAD-34		153H-F5FAD-34
	0.75	1	5		152H-F5FAD-35		153H-F5FAD-35
	1.1	1.5	25		152H-F25FAD-36		153H-F25FAD-36
	1.5	2	25		152H-F25FAD-37		153H-F25FAD-37
	2.2	3	25		152H-F25FAD-38		153H-F25FAD-38
	3.7	5	25		152H-F25FAD-39		153H-F25FAD-39
	5.5	7.5	25		152H-F25FAD-40		153H-F25FAD-40
	7.5	10	43		152H-F43FAD-41		153H-F43FAD-41
	11	15	43		152H-F43FAD-42		153H-F43FAD-42
	15	20	60		152H-F60FAD-43		153H-F60FAD-43
	18.5	25	85		152H-F85FAD-44		153H-F85FAD-44
	22	30	85		152H-F85FAD-45		153H-F85FAD-45
	30	40	108		152H-F108FAD-46		153H-F108FAD-46
	37	50	135		152H-F135FAD-47		153H-F135FAD-47
	45	60	201		152H-F201FAD-48		153H-F201FAD-48
	55	75	201		152H-F201FAD-49		153H-F201FAD-49
	75	100	251		152H-F251FAD-50		153H-F251FAD-50
	90	125	317		152H-F317FAD-51		153H-F317FAD-51
	110	150	361		152H-F361FAD-52		153H-F361FAD-52
132	200	480	Δ	152H-F480JAD-54		153H-F480FAD-54	
185	250	625	Δ	152H-F625JAD-56	Δ	153H-F625JAD-56	
220	300	780	Δ	152H-F780JAD-57	Δ	153H-F780JAD-57	

★ These controllers require a separate 100...240V, 50/60 Hz single-phase control source. To add a control circuit transformer to the enclosure, add the appropriate option code to the catalog string.
 ‡ The nominal current rating for the combination package may differ from the controller, based on the horsepower. Consult your local Rockwell Automation sales office or Allen-Bradley distributor.
 ♣ Provided with Class J or L fuse clips as standard.
 Δ Available in IP54 (Type 12) enclosure only.

SMC™ Flex Smart Motor Controllers

Product Selection

Combination Line-Connected Controllers — IP65 (Type 4/12) Enclosed with Fusible Disconnect or Circuit Breaker, Cont.

These controllers include line and load terminations. Enclosures other than those listed are available; consult your local Rockwell Automation sales office or Allen-Bradley distributor. All Bulletin 153 catalog numbers are supplied with thermal magnetic circuit breakers.

The fusible disconnects do not come with fuses.

Rated Voltage [V AC]	kW, 50 Hz	Hp, 60 Hz	Controller Current Rating [A] ‡	IP65 (Type 4/12) Enclosed Combination Controllers with Fusible Disconnect ★		IP65 (Type 4/12) Enclosed Combination Controllers with Circuit Breaker ★	
				Cat. No. ⚡		Cat. No.	
400/460	0.37	0.5	5		152H-F5FBD-33		153H-F5FBD-33
	0.55	0.75	5		152H-F5FBD-34		153H-F5FBD-34
	0.75	1	5		152H-F5FBD-35		153H-F5FBD-35
	1.1	1.5	5		152H-F5FBD-36		153H-F5FBD-36
	1.5	2	5		152H-F5FBD-37		153H-F5FBD-37
	2.2	3	5		152H-F5FBD-38		153H-F5FBD-38
	3.7	5	25		152H-F25FBD-39		153H-F25FBD-39
	5.5	7.5	25		152H-F25FBD-40		153H-F25FBD-40
	7.5	10	25		152H-F25FBD-41		153H-F25FBD-41
	11	15	25		152H-F25FBD-42		153H-F25FBD-42
	15	20	43		152H-F43FBD-43		153H-F25FBD-43
	18.5	25	43		152H-F43FBD-44		153H-F43FBD-44
	22	30	43		152H-F43FBD-45		153H-F43FBD-45
	30	40	60		152H-F60FBD-46		153H-F60FBD-46
	37	50	85		152H-F85FBD-47		153H-F85FBD-47
	45	60	85		152H-F85FBD-48		153H-F85FBD-48
	55	75	108		152H-F108FBD-49		153H-F108FBD-49
	75	100	135		152H-F135FBD-50		153H-F135FBD-50
	90	125	201		152H-F201FBD-51		153H-F201FBD-51
	110	150	201		152H-F201FBD-52		153H-F201FBD-52
132	200	251		152H-F251FBD-54		153H-F251FBD-54	
160	250	317		152H-F317FBD-56		153H-F317FBD-56	
200	300	361		152H-F361FBD-57		153H-F361FBD-57	
250	350	480		152H-F480FBD-58		153H-F480FBD-58	
250	400	480	Δ	152H-F480JBD-59		153H-F480FBD-59	
355	500	625	Δ	152H-F625JBD-61	Δ	153H-F625JBD-61	
450	600	780	Δ	152H-F780JBD-62	Δ	153H-F780JBD-62	
500/575	0.55	0.75	5		152H-F5FCD-34		153H-F5FCD-34
	0.75	1	5		152H-F5FCD-35		153H-F5FCD-35
	1.1	1.5	5		152H-F5FCD-36		153H-F5FCD-36
	1.5	2	5		152H-F5FCD-37		153H-F5FCD-37
	2.2	3	5		152H-F5FCD-38		153H-F5FCD-38
	3.7	5	25		152H-F25FCD-39		153H-F25FCD-39
	5.5	7.5	25		152H-F25FCD-40		153H-F25FCD-40
	7.5	10	25		152H-F25FCD-41		153H-F25FCD-41
	11	15	25		152H-F25FCD-42		153H-F25FCD-42
	15	20	43		152H-F43FCD-43		153H-F43FCD-43
	18.5	25	43		152H-F43FCD-44		153H-F43FCD-44
	22	30	43		152H-F43FCD-45		153H-F43FCD-45
	22	40	43		152H-F43FCD-46		153H-F43FCD-46
	37	50	60		152H-F60FCD-47		153H-F60FCD-47
	45	60	85		152H-F85FCD-48		153H-F85FCD-48
	55	75	85		152H-F85FCD-49		153H-F85FCD-49
	75	100	108		152H-F108FCD-50		153H-F108FCD-50
	90	125	135		152H-F135FCD-51		153H-F135FCD-51
	110	150	201		152H-F201FCD-52		153H-F201FCD-52
	132	200	201		152H-F201FCD-54		153H-F201FCD-54
160	250	251		152H-F251FCD-56		153H-F251FCD-56	
200	300	317		152H-F317FCD-57		153H-F317FCD-57	
250	350	361		152H-F361FCD-58		153H-F361FCD-58	
295	400	480	Δ	152H-F480JCD-59		153H-F480FCD-59	
315	450	480	Δ	152H-F480JCD-60		153H-F480FCD-60	
315	500	480	Δ	152H-F480JCD-61		153H-F480FCD-61	
450	600	625	Δ	152H-F625JCD-62	Δ	153H-F625JCD-62	
560	800	780	Δ	152H-F780JCD-65	Δ	153H-F780JCD-65	

★ These controllers require a separate 100...240V, 50/60 Hz single-phase control source. To add a control circuit transformer to the enclosure, add the appropriate option code to the catalog string.

‡ The nominal current rating for the combination package may differ from the controller, based on the horsepower. Consult your local Rockwell Automation sales office or Allen-Bradley distributor.

⚡ Provided with Class J or L fuse clips as standard.

Δ Available in IP54 (Type 12) enclosure only.

Control Options (open and enclosed)

Option	Description	Cat. No. Modification
Pump Control	Provides smooth motor acceleration and deceleration, reducing surges caused by the starting and stopping of centrifugal pumps. Starting time is adjustable from 0...30 s, and stopping time is adjustable from 0...120 s.	B★
Braking Control	Provides Smart Motor Braking (SMB), Accu-Stop, and Slow Speed with Braking.	D★

Enclosed Options

Option	Description	Cat. No. Modification
Push Buttons	Start-Stop Push Button	-1
	Start-Stop Push Button with H-O-A Selector Switch	-1F
	Soft Stop Push Button‡	1XA
	Pump Stop Push Button‡	1XB
	Slow Speed Push Button‡	1XC
	Brake Push Button‡	1XD
	Accu-Stop/Slow Speed Push Button‡	1XE
Selector Switch	Hand-Off-Auto Selector Switch	-3
	SMC-Off-Bypass Selector Switch	-3B ▽
Pilot Lights	Transformer Pilot Light - Green Power On Indicator	-4G
	Transformer Pilot Light - Red Run Indicator	-4R
	Push-to-Test Pilot Light - Red Run Indicator	-5R
Control Circuit Transformer	Control Circuit Transformer (fused primary and secondary)	-6P
	Additional 100VA Control Circuit Transformer (fused primary and secondary)	-6PX
	1000VA Control Circuit Transformer (fused primary and secondary)	-6PK
	1600VA Control Circuit Transformer (fused primary and secondary)	-6PL
	2000VA Control Circuit Transformer (fused primary and secondary)	-6PM
Protective Modules	480V Line Side Protective Module	-8L
	600V Line Side Protective Module	
	480V Load Side Protective Module	-8M
	600V Load Side Protective Module	
	480V Both Line and Load Side Protective Modules	-8B
	600V Both Line and Load Side Protective Modules	
Human Interface Module	Door-mounted, Full Numeric (Type 4/12)	-HC3
Communication Module	RS-485	-20S
	DeviceNet	-20D
	Ethernet/IP	-20E
	Control Net	-20C
	Profibus	-20P
Disconnect Auxiliary	N.O. disconnect auxiliary mounted on operating mechanism	-98
	N.C. disconnect auxiliary mounted on operating mechanism	-99
Circuit Breaker Auxiliary	Internal N.O. circuit breaker auxiliary	-98X
	Internal N.C. circuit breaker auxiliary	-99X
Service Entrance Label	Service Entrance Label	-SEL
Oil Pump Starter	Bulletin 509 NEMA Size 1 starter and Bulletin 592 solid-state overload	-OPS

★ Add the designated letter to the end of the cat. no. Example: To add the Pump Control option: **Cat. No. 150-F361NBDB** or **Cat. No. 152H-F361FBDB-57**.

‡ Option push buttons are available only when the corresponding option module is selected. Example: **Cat. No. 150-F108FBDB-1XB**.

▽ Bypass contactor and overload are not included with this option. A **-NB** or **-BP** needs to be added to the catalog string to add these devices.

Bulletin 150
SMC™ Flex Smart Motor Controllers
 Modifications/Accessories

Enclosed Options, Continued

Option	Description	Cat. No. Modification
NEMA Bypass Contactor and Overload Relay	5...43 A	-NB
	60...85 A	
	108...135 A	
	201...251 A	
	317...361 A	
	480 A	
NEMA Isolation Contactor	5...43 A	-NI
	60...85 A	
	108...135 A	
	201...251 A	
	317...361 A	
	480 A	
MCS Bypass Contactor and Overload Relay	5...43 A	-BP
	60...85 A	
	108...135 A	
	201...251 A	
	317...361 A	
	480 A	

Accessories

Protective Modules★

Protective modules must not be placed on the load side of a device when using an inside-the-delta connection or with Pump, Braking, or Linerar Speed control.

	Current Rating [A]	Description	Field Modification Cat. No.
	5...85	480V Protective Module	
90...520	150-F84L		
5...85	600V Protective Module		150-F86
90...520			150-F86L

★ The same protective module mounts on the line or load side of the SMC Flex. For applications requiring both line and load side protection, two protective modules must be ordered.

Terminal Lug Kits (108...1250 A)

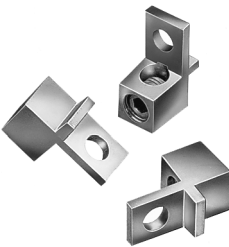
	Current Rating [A] ‡	Wire Size	Total No. of Line Controller Terminal Lugs Possible Each Side		Pkg. Qty.	Cat. No.	
			Line Side	Load Side			
	108...135Δ	#6...250 MCM AWG 16 mm ² ...120 mm ²	3	3	3	199-LF1	
	201...251Δ		6	6			
	317...480Δ	#4...500 MCM AWG 25 mm ² ...240 mm ²	6	6		3	199-LG1
	625...780		2/0...500 MCM AWG	6			6
	970	4/0...500 MCM AWG	3	3			100-DL860
	1250♣	2/0...500 MCM AWG	3	3			100-DL630
		4/0...500 MCM AWG	3	3	100-DL860		

Line and Load terminals are provided as standard on enclosed SMCs.

‡ 5...85 A units have box lugs standard. No additional lugs are required.

♣ The 1250 A device requires (1) 100-DL630 and (1) 100-DL860 per connection.



Δ When a multi-conductor lug is required, refer to the User Manual for appropriate lug catalog number.

IEC Terminal Covers

	Description§	Package Quantity	Field Modification Cat. No.
	IEC line or load terminal covers for 108 and 135 A devices. Dead front protection	1	150-TC1
	IEC line or load terminal covers for 201...251 A devices. Dead front protection	1	150-TC2
	IEC line or load terminal covers for 317...480 A devices. Dead front protection	1	150-TC3

§ 5...85 A units have terminal guards standard. No additional terminal guards are required.

Human Interface and Communication Modules

Description			Cat. No.
	Hand-Held Human Interface Modules	LCD Display, Full Numeric Keypad★	20-HIM-A3
		LCD Display, Programmer Only★	20-HIM-A5
	Door-Mounted Human Interface Modules	Remote (Panel Mount) LCD Display, Full Numeric Keypad	20-HIM-C3S
		LCD Display, Programmer Only HIM (includes 3 m cable)	20-HIM-C5S
	Human Interface Module Interface Cables	PowerFlex HIM Interface Cable, 1 m (39 in)	20-HIM-H10
		Cable Kit (Male-Female) 0.33 m (1.1 ft)	1202-H03
		Cable Kit (Male-Female) 1 m (3.3 ft)	1202-H10
		Cable Kit (Male-Female) 3 m (9.8 ft)	1202-H30
		Cable Kit (Male-Female) 9 m (29.5 ft)	1202-H90
		DPI/SCANport™ One to Two Port Splitter Cable	1203-S03
Description (IP30/Type 1)		For Use With	
	Communication Modules	RS485 DF1 Communication Adapter	20-COMM-S
		PROFIBUS™ DP Communication Adapter	20-COMM-P
		ControlNet™ Communication Adapter (Coax)	20-COMM-C
		Interbus™ Communication Adapter	20-COMM-I
		Modbus/TCP Communication Adapter	20-COMM-M
		DeviceNet™ Communication Adapter	20-COMM-D
		EtherNet/IP™ Communication Adapter	20-COMM-E
		HVAC Communication Adapter	20-COMM-H
		ControlNet™ Communication Adapter (Fiber)	20-COMM-Q
Bulletin 150 SMC-Flex			
DriveTools™	Programming Software	WIN NT/2000/XP	9303-4DTE01ENE
DriveTools™ Sp	Programming Software	WIN NT/2000/XP	9303-4DTS01ENE
AnaCANda™ RS-232 to DPI	PC Interface	Serial	1203-SSS
DPI to USB	PC Interface	USB	1203-USB

★ Requires a 20-HIM-H10 cable to connect to the SMC Flex.

Specifications

Functional Design Specifications			
Standard Features	Installation	Power Wiring	Standard squirrel-cage induction motor or a Wye-Delta, six-lead motor.
		Control Wiring	2- and 3-wire control for a wide variety of applications.
	Setup	Keypad	Front keypad and backlit LCD display.
		Software	Parameter values can be downloaded to the SMC-Flex Controller with DriveTools programming software and the Cat. No. 20-COMM... DPI communication module.
	Communications		One DPI provided for connection to optional human interface and communication modules.
	Starting and Stopping Modes		Soft Start Current Limit Start Dual Ramp Full Voltage Linear Speed Acceleration Preset Slow Speed Soft Stop
	Protection and Diagnostics		Power loss, line fault, voltage unbalance, excessive starts/hour, phase reversal, undervoltage, overvoltage, controller temp, stall, jam, open gate, overload, underload, communication fault.
	Metering		Amps, volts, kW, kWh, MW, MWh, elapsed time, power factor, motor thermal capacity usage.
	Alarm Contact		Overload, underload, undervoltage, overvoltage, unbalance, jam, stall, and ground fault
	Status Indication		Stopped, starting, stopping, at speed, alarm, and fault.
Auxiliary Contacts		Four fully programmable contacts as normal/up-to-speed/fault/alarm/network (N.O./N.C.), or external bypass (N.O. only).	
Optional Features	Pump Control		Helps reduce fluid surges in centrifugal pumping systems during starting and stopping period. Starting time is adjustable from 0...30 s. Stopping time is adjustable from 0...120 s.
	Braking Control	SMB Smart Motor Braking	Provides motor braking without additional equipment for applications that require the motor to stop quickly. Braking current is adjustable from 0...400% of the motor's full-load current rating.
		Accu-Stop	Provides controlled position stopping. During stopping, braking torque is applied to the motor until it reaches preset slow speed (7% or 15% of rated speed) and holds the motor at this speed until a stop command is given. Braking torque is then applied until the motor reaches zero speed. Braking current is programmable from 0...450% of full-load current.
		Slow Speed with Braking	Used on applications that require slow speed (in the forward direction) for positioning or alignment and also require braking control to stop.

Wiring Diagram — Line Controller

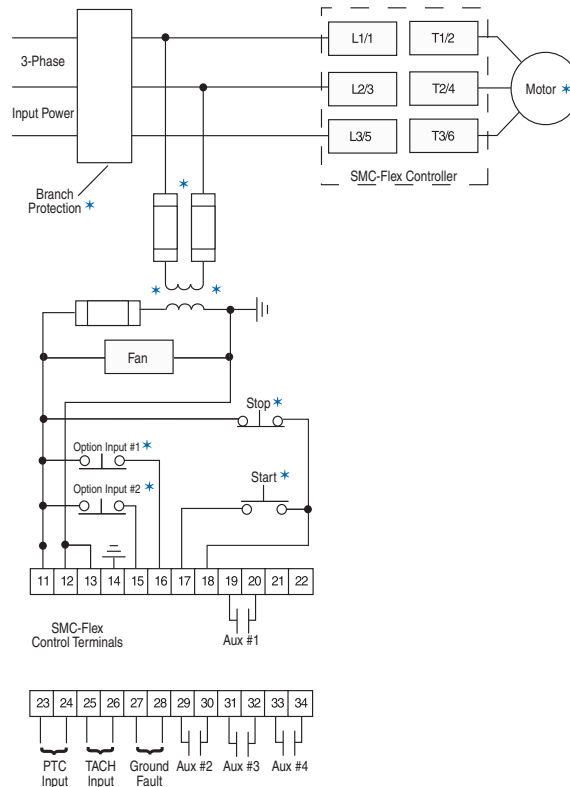

* Customer supplied.

Electrical Ratings				
		Device Rating	UL/CSA/NEMA	IEC
Power Circuit	Rated Operation Voltage	480V	200...480V AC (-15%, +10%)	200...415V
		600V	200...600V AC (-15%, +10%)	200...500V
		690V	230...600V AC (-15%, +10%)	230...690V/Y (-15%, +10%)
	Rated Insulation Voltage	480V	N/A	500V
		600V		500V
		690V		690V
	Rated Impulse Voltage	480V	N/A	6000V
		600V		
		690V		
	Dielectric Withstand	480V	2200V AC	2500V
		600V		
		690V		
	Repetitive Peak Inverse Voltage Rating	480V	1400V	1400V
		600V	1600V	1600V
		690V	1800V	1800V
	Operating Frequency	All	50/60 Hz	
	Utilization Category	5...480 A	MG 1	AC-53B:3.0-50:1750
		625...1250 A	MG 1	AC-53B:3.0-50:3550
	Protection Against Electrical Shock	5...85 A	N/A	IP20
		108...480 A		IP2X (with terminal covers)
625...1250 A		IP00 (open device)		
DV/DT Protection	480V & 600V	RC Snubber Network		
	690V	None		
Transient Protection	480V & 600V	Metal Oxide Varistors: 220 Joules		
	690V	None		
Control Circuit	Rated Operational Voltage♣	5...480 A	100...240V AC or 24V AC/DC	
		625...1250 A	110/120V AC and 230/240V AC	
	Rated Insulation Voltage	All	N/A	240V
	Rated Impulse Voltage	All	N/A	3000V
	Dielectric Withstand	All	1600V AC	2000V
	Operating Frequency	All	50/60 Hz	
	Input onstate voltage minimum	85V AC, 19.2V DC / 20.4V AC		
	Input onstate current	20 mA @120V AC / 40 mA @ 240V AC, 7.6 mA @ 24V AC/DC		
	Input offstate voltage maximum	50V AC, 10V DC / 12V AC		
	Input offstate current @ input offstate voltage	<10 mA AC, <3 mA DC		

♣ 690V power is only available with 100...240V control.

Bulletin 150
SMC™ Flex Smart Motor Controllers
 Specifications

Electrical Ratings								
Short-Circuit Protection	SCPD Performance 200...600V		Type 1♣Δ					
	SCCR List★		Max. Standard Available Fault	Max. Standard Fuse [A]‡	Max. Standard Available Fault	Max. Circuit Breaker [A]	Max. High Fault	Max. Fuse [A]§
	Line Device Operational Current Rating [A]	5	5 kA	20	5 kA	20	70 kA	10
		25	5 kA	100	5 kA	100	70 kA	50
		43	10 kA	150	10 kA	150	70 kA	90
		60	10 kA	225	10 kA	225	70 kA	125
		85	10 kA	300	10 kA	300	70 kA	175
		108	10 kA	400	10 kA	300	70 kA	200
		135	10 kA	500	10 kA	400	70 kA	225
		201	18 kA	600	18 kA	600	70 kA	350
		251	18 kA	700	18 kA	700	70 kA	400
		317	30 kA	800	30 kA	800	69 kA	500
		361	30 kA	1000	30 kA	1000	69 kA	600
		480	42 kA	1200	42 kA	1200	69 kA	800
		625	42 kA	1600	42 kA	1600	74 kA	1600
		780	42 kA	1600	42 kA	2000	74 kA	1600
	970	85 kA	2500	85 kA	2500	85 kA	2500	
	1250	85 kA	3000	85 kA	3200	85 kA	3000	
	Delta Device Operational Current Rating [A]	8.7	5 kA	35	5 kA	35	70 kA	17.5
		43	5 kA	150	5 kA	150	70 kA	90
		74	10 kA	300	10 kA	300	70 kA	150
		104	10 kA	400	10 kA	400	70 kA	200
		147	10 kA	400	10 kA	400	70 kA	200
		187	10 kA	600	10 kA	500	70 kA	300
		234	10 kA	700	10 kA	700	70 kA	400
		348	18 kA	1000	18 kA	1000	70 kA	600
435		18 kA	1200	18 kA	1200	70 kA	800	
549		30 kA	1600	30 kA	1600	69 kA	1000	
625		30 kA	1600	30 kA	1600	69 kA	1200	
831		42 kA	1600	30 kA	1600	69 kA	1600	
850	42 kA	1600	42 kA	2000	74 kA	1600		
900	42 kA	1600	42 kA	2000	74 kA	1600		
1200	85 kA	3000	85 kA	3200	85 kA	3000		
1600	85 kA	3000	85 kA	3200	85 kA	3000		
SCPD Performance 690V		Type 1♣						
SCCR List★	Device Rating	Max. Standard Available Fault	Max. Ampere Tested — North American Style		Max. Ampere Tested — European Style			
Maximum FLC	108	70 kA	A070URD33xxx500		6,9 gRB 73xxx400 6,6URD33xxx500			
	135	70 kA	A070URD33xxx500		6,9 gRB 73xxx400 6,6URD33xxx500			
	201	70 kA	A070URD33xxx700		6,9 gRB 73xxx630 6,6URD33xxx700			
	251	70 kA	A070URD33xxx700		6,9 gRB 73xxx630 6,6URD33xxx700			
	317	70 kA	A070URD33xxx900		6,9 gRB 73xxx800 6,6URD33xxx900			
	361	70 kA	A070URD33xxx900		6,9 gRB 73xxx800 6,6URD33xxx900			
	480	70 kA	A070D33xxx1250 A100URD73xxx1250		9 URD 73xxx1250 6,6URD33xxx1250			
	625	70 kA	A070URD33xxx1400		6,6URD33xxx1400			
	780	70 kA	A070URD33xxx1400		6,6URD33xxx1400			
	970	85 kA	Two fuses in parallel A070URD33xxx1250		Two fuses in parallel 6,6URD33xxx1250			
1250	85 kA	Two fuses in parallel A070URD33xxx1250		Two fuses in parallel 6,6URD33xxx1250				

★ Consult local codes for proper sizing of short circuit protection.

‡ Non-time delay fuses (K5 — 5...480V (8.7...831 A) devices; Class L — 625...1250V (850...1600 A) devices).

§ High capacity fault rating when used with time delay class CC, J, or L fuses.

♣ Type 1 performance/protection indicates that, under a short-circuit condition, the fused or circuit breaker-protected starter shall cause no danger to persons or installation but may not be suitable for further service without repair or replacement.

Δ For short-circuit current rating (SCCR) for enclosed panel with external bypass or isolation contactor, see the Industrial Controls catalog website: www.ab.com/catalogs.

SMC™ Flex Smart Motor Controllers

Specifications

Electrical Ratings						
Power Requirements	Control Module	1...480 A	120...240V AC	Transformer	75 VA	
			24V AC	Transformer	130 VA	
			24V DC	Inrush Current	5 A	
				Inrush Time	250 ms	
				Transient Watts	60 W	
				Transient Time	500 ms	
				Steady State Watts	24 W	
				Minimum Allen-Bradley Power Supply	1606-XLP50E	
			625...1250 A	751 VA (recommended 800 VA)		
			Heatsink Fan(s) ^Δ	5...135 A, 20 VA		
201...251 A, 40 VA						
317...480 A, 60 VA						
625...1250 A, 150 VA						
Steady State Heat Dissipation with Control and Fan Power (Watts)	Controller Rating [A]	5	70			
		25	70			
		43	81			
		60	97			
		85	129			
		108	91			
		135	104			
		201	180			
		251	198			
		317	225			
		361	245			
		480	290			
		625	446			
		780	590			
970	812					
1250	1222					
Auxiliary Contacts 19/20 (Aux #1) 29/30 (Aux #2) 31/32 (Aux #3) 33/34 (Aux #4)	Type of Control Circuit		Electromagnetic relay			
	Number of Contacts		1			
	Type of Contacts		programmable N.O./N.C.			
	Type of Current		AC			
	Rated Operational Current		3 A @ 120V AC, 1.5 A @ 240V AC			
	Conventional Thermal Current _{I_{th}} AC/DC		5 A			
	Make/Break VA		3600/360			
	Utilization Category		AC-15/DC			
PTC Input Ratings	Response Resistance		3400 Ω ±150 Ω			
	Reset Resistance		1600 Ω ±100 Ω			
	Short-Circuit Trip Resistance		25 Ω ±10 Ω			
	Max. Voltage at PTC Terminals (R _{PTC} = 4 kΩ)		< 7.5V			
	Max. Voltage at PTC Terminals (R _{PTC} = open)		30V			
	Max. No. of Sensors.		6			
	Max. Cold Resistance of PTC Sensor Chain		1500 Ω			
Response Time		800 ms				
Tach Input			0...5V DC, 4.5V DC = 100% Speed			

^Δ Heatsink fans can be powered by either 110/120V AC or 220/240V AC.



Bulletin 150
SMC™ Flex Smart Motor Controllers
 Specifications

Environmental	
Operating Temperature Range	-5...+50 °C (23...+122 °F) (open) -5...+40 °C (23...+104 °F) (enclosed)
Storage and Transportation Temperature Range	-20...+75 °C (-4...167 °F)
Altitude	2000 m (6560 ft)
Humidity	5...95% (non-condensing)
Pollution Degree	2

Mechanical			
Resistance to Vibration	Operational	All	1.0 G Peak, 0.15 mm (0.006 in.) displacement
	Non-Operational	5...480 A	2.5 G Peak, 0.38 mm (0.015 in.) displacement
		625...1250 A	1.0 G Peak, 0.15 mm (0.006 in.) displacement
Resistance to Shock	Operational	5...85 A	15 G
		108...480 A	5.5 G
		625...1250 A	4 G
	Non-Operational	5...85 A	30 G
		108...480 A	25 G
		625...1250 A	12 G
Construction	Power Poles	5...85 A	Heatsink thyristor modular design
	Power Poles	108...1250 A	Heatsink hockey puck thyristor modular design
	Control Modules		Thermoset and Thermoplastic Moldings
	Metal Parts		Plated Brass, Copper, or Painted Steel
Terminals	Power Terminals	5...85 A	Cable size — Line Upper — 2.5...95 mm ² (14...3/0 AWG) Line Lower — 0.8...2.5 mm ² (18...14 AWG) Load Upper — 2.5...50 mm ² (14...1 AWG) Load Lower — 0.8...2.5 mm ² (18...14 AWG) Tightening torque — 14.7 N•m (130 lb.-in.)
		108...135 A	One M10 x 1.5 diameter hole per power pole
		201...251 A	Two M10 x 1.5 diameter holes per power pole
		317...480 A	Two M12 x 1.75 diameter holes per power pole
		625...1250 A	Two 13.5 mm (0.53 in.) diameter holes per power pole
	Power Terminal Markings		NEMA, CENELEC EN50 012
Control Terminals	M3 screw clamp	Clamping yoke connection	

Other				
EMC Emission Levels	Conducted Radio Frequency Emissions Radiated Emissions		Class A Class A	
EMC Immunity Levels	Electrostatic Discharge Radio Frequency Electromagnetic Field Fast Transient Surge Transient		8 kV Air Discharge Per EN/IEC 60947-4-2 Per EN/IEC 60947-4-2 Per EN/IEC 60947-4-2	
Overload Characteristics	Current Range [A]	5	Line	Delta
			1...5	1.7...9
		25	5...25	8.6...43
		43	8.6...43	14.8...75
		60	12...60	20.8...104
		85	17...85	29.4...147
		108	27...108	47...187
		135	34...135	59...234
		201	67...201	116...348
		251	84...251	145...435
		317	106...317	183...549
		361	120...361	208...625
		480	160...480	277...831
		625	208...625	283...850
780	260...780	300...900		
970	323...970	400...1200		
	1250	416...1250	533...1600	
	Trip Classes Trip Current Rating Number of Poles		10, 15, 20, and 30 117% of Motor FLC 3	
Certifications	Open-Type Controllers		CE Marked Per Low Voltage Directive 73/23/EEC, 93/68/EEC UL Listed (File No. E96956)	

Approximate Dimensions and Shipping Weights
Open Type Controllers

Dimensions are in millimeters (inches).
 Dimensions are not intended for manufacturing purposes.

Rating [A]	Height	Width	Depth	Weight
5...85	321 (12.6)	150 (5.9)	203 (8.0)	5.7 kg (12.6 lbs)
108...135	443.7 (17.47)	196.4 (7.74)	205.2 (8.08)	15.0 kg (33 lbs)
201...251	560 (22.05)	225 (8.86)	253.8 (9.99)	30.4 kg (67 lbs)
317...480	600 (23.62)	290 (11.42)	276.5 (10.89)	45.8 kg (101 lbs)
625...780	1041.1 (41.0)	596.9 (23.5)	346.2 (13.63)	179 kg (395 lbs)
970...1250	1041.1 (41.0)	596.9 (23.5)	346.2 (13.63)	224 kg (495 lbs)

Enclosed-Type Line-Connected Controllers

Factory-installed options may affect enclosure size requirements.
 Exact dimensions can be obtained after order entry. Please consult your local Rockwell Automation sales office or Allen-Bradley distributor.
 Dimensions are in millimeters (inches). Dimensions are not intended for manufacturing purposes.

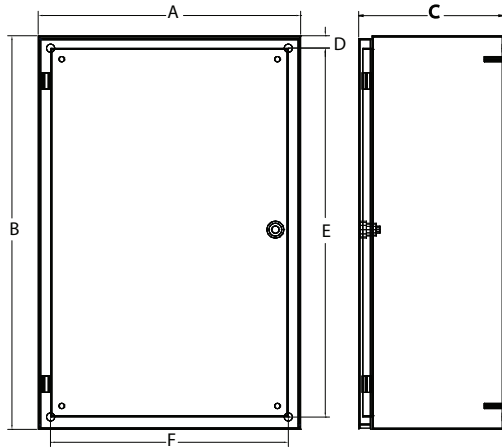

Figure 1 — Wall-Mount

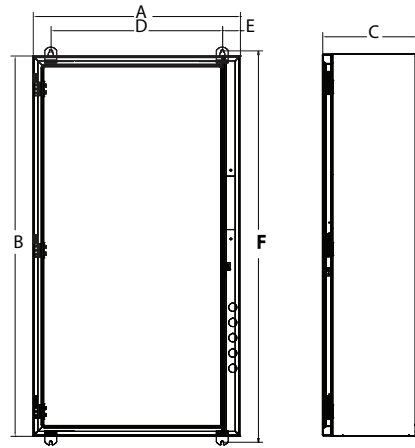

Figure 2 — Wall-Mount

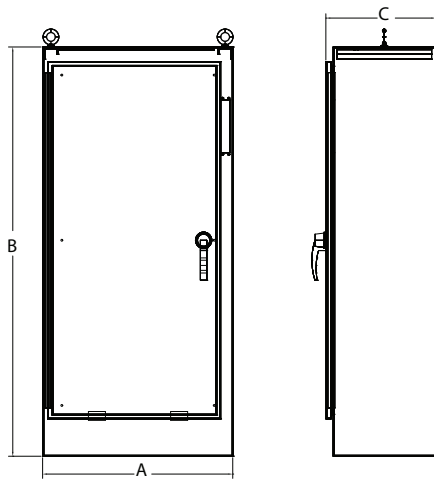

Figure 3 — Floor-Mount

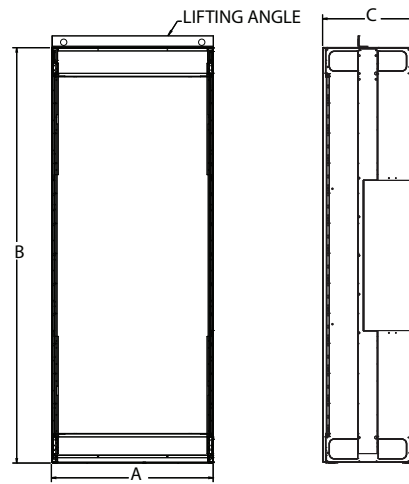

Figure 4 — Floor-Mount

Bulletin 150
SMC™ Flex Smart Motor Controllers
 Approximate Dimensions

Controller Rating [A]	Bulletin	With Option	Dimension Figure No.	Dimensions in inches (mm)					
				A (Width)	B (Height)	C (Depth)	D (Mtg. Dim.)	E (Mtg. Dim.)	F (Mtg. Dim.)
SMC-Flex Combination Controller									
5...25	152H,152B,153H,153B	—	1	16 (406)	24 (610)	10 (254)	0.75 (19)	22.5 (572)	14.5 (368)
		BP,NB,NI,6_		24 (610)	30 (762)	12 (305)		28.5 (724)	22.5 (572)
43	152H,152B,153H,153B	—	1	16 (406)	24 (610)	10 (254)	0.75 (19)	22.5 (572)	14.5 (368)
		BP, 6_		24 (610)	30 (762)	12 (305)		28.5 (724)	22.5 (572)
		NI, NB		30 (762)	38 (965)	14 (356)		36.5 (927)	28.5 (724)
60	153H,153B	—	1	16 (406)	24 (610)	10 (254)	0.75 (19)	22.5 (572)	14.5 (368)
	152H, 153H,153B	6_		24 (610)	30 (762)	12 (305)		28.5 (724)	22.5 (572)
	152H,152B	—		24 (610)	30 (762)	12 (305)		28.5 (724)	22.5 (572)
	152H,152B,153H,153B	NI, NB		30 (762)	38 (965)	14 (356)		36.5 (927)	28.5 (724)
85	153H,153B	—	1	16 (406)	24 (610)	10 (254)	0.75 (19)	22.5 (572)	14.5 (368)
	152H,152B	—		24 (610)	30 (762)	12 (305)		28.5 (724)	22.5 (572)
	152H,153H,153B	6_		24 (610)	30 (762)	12 (305)		28.5 (724)	22.5 (572)
	153H	BP		24 (610)	30 (762)	12 (305)		28.5 (724)	22.5 (572)
		BP, 6_		30 (762)	38 (965)	14 (356)		36.5 (927)	28.5 (724)
	152H,152B,153B	BP,NB,NI		30 (762)	38 (965)	14 (356)		36.5 (927)	28.5 (724)
108	152H,153H	—	1	30 (762)	38 (965)	14 (356)	0.75 (19)	36.5 (927)	28.5 (724)
		6_		30 (762)	38 (965)	14 (356)		36.5 (927)	28.5 (724)
	152H,152B,153H,153B	BP, NB,NI		36 (914)	51 (1295)	14 (356)		49.5 (1257)	34.5 (876)
135	152H,153H	—	1	30 (762)	38 (965)	14 (356)	0.75 (19)	36.5 (927)	28.5 (724)
		6_		30 (762)	38 (965)	14 (356)		36.5 (927)	28.5 (724)
	152H,152B,153H,153B	BP, NB,NI		36 (914)	51 (1295)	14 (356)		49.5 (1257)	34.5 (876)
201	152H,153H	—	1	30 (762)	38 (965)	14 (356)	0.75 (19)	36.5 (927)	28.5 (724)
		6_		30 (762)	38 (965)	14 (356)		36.5 (927)	28.5 (724)
	152H,152B,153H,153B	BP, NB,NI		36 (914)	51 (1295)	14 (356)		49.5 (1257)	34.5 (876)
251	152H,153H	—	1	30 (762)	38 (965)	14 (356)	0.75 (19)	36.5 (927)	28.5 (724)
		6_		30 (762)	38 (965)	14 (356)		36.5 (927)	28.5 (724)
	152H,152B,153H,153B	BP, NB,NI		36 (914)	51 (1295)	14 (356)		49.5 (1257)	34.5 (876)
317	153H	—	1	36 (914)	51 (1295)	14 (356)	0.75 (19)	49.5 (1257)	34.5 (876)
		6_		36 (914)	51 (1295)	14 (356)		49.5 (1257)	34.5 (876)
		BP,NB		36 (914)	60 (1524)	14 (356)		58.5 (1486)	34.5 (876)
	153B	—	2	36 (914)	60 (1524)	14 (356)	33.88 (861)	58.5 (1486)	34.5 (876)
		6_		38 (965)	60 (1524)	17 (431)		1.75 (45)	61.69 (1567)
	152H,152B	—		38 (965)	60 (1524)	17 (431)		1.75 (45)	61.69 (1567)
	152H,152B,153B	NB,NI	3	40 (1016)	84 (2134)	18 (457)	—	—	—
361	153H	—	1	36 (914)	51 (1295)	14 (356)	0.75 (19)	49.5 (1257)	34.5 (876)
		6_		36 (914)	51 (1295)	14 (356)		49.5 (1257)	34.5 (876)
		BP		36 (914)	60 (1524)	14 (356)		58.5 (1486)	34.5 (876)
	153B	—	2	36 (914)	60 (1524)	14 (356)	33.88 (861)	58.5 (1486)	34.5 (876)
		6_		38 (965)	60 (1524)	17 (431)		1.75 (45)	61.69 (1567)
	152H, 152B	—		38 (965)	60 (1524)	17 (431)		1.75 (45)	61.69 (1567)
	152H,152B,153H,153B	NB,NI	3	40 (1016)	84 (2134)	18 (457)	—	—	—
480	153H	—	1	36 (914)	51 (1295)	14 (356)	0.75 (19)	49.5 (1257)	34.5 (876)
		6_		36 (914)	51 (1295)	14 (356)		49.5 (1257)	34.5 (876)
	153H,153B	BP,NI	1‡	36 (914)	60 (1524)	14 (356)	33.88 (861)	58.5 (1486)	34.5 (876)
		—	2*§	38 (965)	60 (1524)	17 (431)		1.75 (45)	61.69 (1567)
		BP	2*§	38 (965)	60 (1524)	17 (431)		1.75 (45)	61.69 (1567)
		NB	3*§	40 (1016)	84 (2134)	18 (457)		—	—
		—	4*♣	20 (508)	91.5 (2324)	20 (508)		—	—
	153H,153B	BP,NB,NI	3*♣	40 (1016)	84 (2134)	18 (457)	—	—	
	152B	BP,NB,NI,6_	3*	40 (1016)	84 (2134)	18 (457)	—	—	
	152H,152B	BP,NB,NI	4	35 (889)	91.5 (2324)	20 (508)	—	—	
625	152B	—	4	55 (1397)	91.5 (2324)	20 (508)	—	—	—
	152H,152B,153H,153B	NB		105 (2664)	91.5 (2324)	20 (508)		—	—
		—		55 (1397)	91.5 (2324)	20 (508)		—	—
	152H	BP		70 (1778)	91.5 (2324)	20 (508)		—	—
	153H,153B	—	4	65 (1651)	91.5 (2324)	20 (508)	—	—	—
	152H,152B	—		55 (1397)	91.5 (2324)	20 (508)		—	—
	152H,152B	BP,NI		70 (1778)	91.5 (2324)	20 (508)		—	—
	152H,152B,153H,153B	NB		105 (2664)	91.5 (2324)	20 (508)		—	—
780	153H,153B	—	4	65 (1651)	91.5 (2324)	20 (508)	—	—	—

* Assumed line voltage to be 480V AC. Different voltage may necessitate a bigger enclosure size. Consult your local Rockwell Automation sales office or Allen-Bradley distributor.

‡ 350 Hp max.

§ 150 Hp @ 208V AC, 350 Hp @480V, 400...450 Hp @ 600V

♣ 200 Hp @ 240V AC, 400 Hp @480V, 500 Hp @ 600V

Controller Rating [A]	Bulletin	With Option	Dimension Figure No.	Dimensions in inches (mm)						
				A (Width)	B (Height)	C (Depth)	D (Mtg. Dim.)	E (Mtg. Dim.)	F (Mtg. Dim.)	
Non-Combination Controller										
5...43	150	—	1	16 (406)	24 (610)	10 (254)	0.75 (19)	22.5 (572)	14.5 (368)	
		6_	1★	16 (406)	24 (610)	10 (254)		22.5 (572)	14.5 (368)	
		BP	1	24 (610)	30 (762)	12 (305)		28.5 (724)	22.5 (572)	
	150, 150B	NB,NI	1	24 (610)	30 (762)	12 (305)		28.5 (724)	22.5 (572)	
	150	NB,6P_	1‡	30 (762)	38 (965)	14 (356)		36.5 (927)	28.5 (724)	
60	150	—	1	16 (406)	24 (610)	10 (254)	0.75 (19)	22.5 (572)	14.5 (368)	
		150B		—	24 (610)	30 (762)		12 (305)	28.5 (724)	22.5 (572)
		BP		—	24 (610)	30 (762)		12 (305)	28.5 (724)	22.5 (572)
	150	6_	1‡	24 (610)	30 (762)	12 (305)		28.5 (724)	22.5 (572)	
		NB	1	24 (610)	30 (762)	12 (305)		28.5 (724)	22.5 (572)	
	150, 150B	NI		30 (762)	38 (965)	14 (356)		36.5 (927)	28.5 (724)	
85	150	—	1	16 (406)	24 (610)	10 (254)	0.75 (19)	22.5 (572)	14.5 (368)	
		150B		—	24 (610)	30 (762)		12 (305)	28.5 (724)	22.5 (572)
		BP		—	24 (610)	30 (762)		12 (305)	28.5 (724)	22.5 (572)
	150	NB	1‡	24 (610)	30 (762)	12 (305)		28.5 (724)	22.5 (572)	
		6_		24 (610)	30 (762)	12 (305)		28.5 (724)	22.5 (572)	
	150, 150B	NB,NI,6P_	1‡	30 (762)	38 (965)	14 (356)		36.5 (927)	28.5 (724)	
108	150	—	1	24 (610)	30 (762)	12 (305)	0.75 (19)	28.5 (724)	22.5 (572)	
		BP		—	30 (762)	38 (965)		14 (356)	36.5 (927)	28.5 (724)
		NB		—	30 (762)	38 (965)		14 (356)	36.5 (927)	28.5 (724)
	150B	—	1	30 (762)	38 (965)	14 (356)		36.5 (927)	28.5 (724)	
		NB,NI		36 (914)	51 (1295)	14 (356)		49.5 (1257)	34.5 (876)	
	135	150	—	1	24 (610)	30 (762)		12 (305)	0.75 (19)	28.5 (724)
BP			—		30 (762)	38 (965)	14 (356)	36.5 (927)		28.5 (724)
150B		—	30 (762)		38 (965)	14 (356)	36.5 (927)	28.5 (724)		
150		NB	30 (762)		38 (965)	14 (356)	36.5 (927)	28.5 (724)		
150B	NB,NI	36 (914)	51 (1295)	14 (356)	49.5 (1257)	34.5 (876)				
201	150	—	1	30 (762)	38 (965)	14 (356)	0.75 (19)	36.5 (927)	28.5 (724)	
	150,150B	NB,NI,BP,6_		36 (914)	51 (1295)	14 (356)		49.5 (1257)	34.5 (876)	
251	150	—	1	30 (762)	38 (965)	14 (356)	0.75 (19)	36.5 (927)	28.5 (724)	
	150,150B	NB,NI,BP,6_		36 (914)	51 (1295)	14 (356)		49.5 (1257)	34.5 (876)	
317	150	NB,NI,BP,6_	1	36 (914)	51 (1295)	14 (356)	0.75 (19)	49.5 (1257)	34.5 (876)	
	150B	NB,NI,BP,6_		36 (914)	60 (1524)	14 (356)		58.5 (1486)	34.5 (876)	
361	150	NB,NI,BP,6_	1	36 (914)	51 (1295)	14 (356)	0.75 (19)	49.5 (1257)	34.5 (876)	
	150B	NB,NI,BP,6_		36 (914)	60 (1524)	14 (356)		58.5 (1486)	34.5 (876)	
480	150	—	1	36 (914)	51 (1295)	14 (356)	0.75 (19)	49.5 (1257)	34.5 (876)	
	150, 150B	BP,NB,NI		36 (914)	60 (1524)	14 (356)		58.5 (1486)	34.5 (876)	
625	150	—	4	35 (889)	91.5 (2324)	20 (508)	—	—	—	
		BP,NB		60 (1524)	91.5 (2324)	20 (508)				
	150B	—		60 (1524)	91.5 (2324)	20 (508)				
		NB		90 (2286)	91.5 (2324)	20 (508)				
780	150	—	4	35 (889)	91.5 (2324)	20 (508)	—	—	—	
		BP,NB		60 (1524)	91.5 (2324)	20 (508)				
	150B	—		60 (1524)	91.5 (2324)	20 (508)				
		NB		90 (2286)	91.5 (2324)	20 (508)				

★ Extra capacity transformer may require a larger enclosure; consult your local Rockwell Automation sales office or Allen-Bradley distributor.

‡ 1 kVA control transformers or larger extra capacity transformers may require a larger enclosure; consult your local Rockwell Automation sales office or Allen-Bradley distributor.



Bulletin 150 — Smart Motor Controllers — SMC™-3 Smart Motor Controller

The SMC-3 is a compact, simple to use, solid-state motor controller designed to operate 3-phase motors. It features a built-in overload relay and a built-in SCR bypass contactor on all three phases, allowing a smaller footprint than other soft starters on the market. This product is designed for many applications, including compressors, chillers, pumps, conveyors, and crushers. Modes of operation for the controller are as follows:

- Soft Start
- Current Limit Start
- Soft Stop
- Kick Start

The controllers offer two voltage ranges: 200...480V AC and 200...600V AC. All voltage ranges will operate at either 50 or 60 Hz.

- 1...480 A Range
- Built-In Electronic Motor Overload Protection
- Built-In SCR/Run Bypass
- Delta Compatibility

Table of Contents

Cat. No. Explanation	31
Product Selection	32
Typical Wiring Diags.	44
Specifications.....	46
Approx. Dimensions .	50
Enclosed Options	42
Accessories.....	42

This catalog is based on the **minimum** information needed to select an SMC soft starter for applications with low starting torque requirements. For product selection involving loads with high starting torque requirements (large fan, rock crusher, chipper, etc.), use of the free tools available from the Rockwell Automation Website is recommended:

http://www.ab.com/industrialcontrols/products/solid-state_motor_control/software/

Standards Compliance

- UL 508
- CSA C22.2 No.14
- EN/IEC 60947-1
- EN/IEC 60947-4-2

Certifications

- cULus Listed (Open Type) (File No. E96956, Guides NMFT, NMFT7)
- CSA Certified (File No. LR 1234)
- CE Marked (Open Type) per EMC and Low Voltage Directive
- CCC Certified

Modes of Operation

- Soft Start
- Current Limit Start
- Selectable Kickstart
- Soft Stop

Note: For detailed information about the different modes of operation, see page 4

Description of Features

Electronic Motor Overload Protection

The SMC-3 controller incorporates, as standard, electronic motor overload protection. This motor overload protection is accomplished electronically with the use of current transformers on each of the three phases. The controller's overload protection is programmable, providing the user with flexibility. The overload trip class selection consists of either OFF, 10, 15, or 20. The trip current is easily selected by adjusting the rotary potentiometer to the motor full-load current rating. Trip reset is selectable to either automatic or manual mode.

Note: Trip rating is 120% of dial setting.

Over-temperature

The SMC-3 monitors the SCR temperature by means of internal thermistors. When the power poles maximum rated temperature is reached, the microcomputer switches off the SMC, a TEMP fault is indicated via LED, and the 97/98 fault contact closes.

Phase Reversal Protection

When enabled via a DIP switch, 3-phase input power will be verified before starting. If input power phasing is detected to be incorrect, the start will be aborted and a fault indicated.

Phase Loss/Open Load

The unit will not attempt a start if there is a single-phase condition on the line. This protects from motor burnout during single-phase starting.

Phase Imbalance

The unit monitors for imbalance between phase currents. To prevent motor damage, the unit will trip if the difference between the minimum phase current and the maximum phase current exceeds 65% for 3 s, and a fault will be indicated.

Shorted SCR

Prior to every start and during starting, the unit will check all SCRs for shorts and unit load connections to the motor. If there is a shorted SCR in the SMC-3 and/or open load, the start will be aborted and a shorted SCR or open load fault will be indicated. This prevents damage from phase imbalance.

Push to Test

The unit with control wiring can be tested for fault conditions by using the Push to Test function. Hold down the Reset button for 7 s to activate the fault Aux (97, 98) and shut down the SMC-3. To clear, either push the Reset button or cycle control power to the device.

LED Description (Number of Flashes)

1. Overload
2. Overtemperature
3. Phase Reversal
4. Phase Loss/Open Load
5. Phase Imbalance
6. Shorted SCR
7. Test

Cat. No. Explanation
 Open and Non-Combination

150 – C 30 F B D – 8L
a b c d e f g

a

Bulletin Number	
Code	Description
150	Solid-State Controller

b

Controller Type	
Code	Description
C	SMC-3

c

Ampere Ratings	
Code	Description
3	3 A
9	9 A
16	16 A
19	19 A
25	25 A
30	30 A
37	37 A
43	43 A
60	60 A
85	85 A
108	108 A
135	135 A
201	201 A
251	251 A
317	317 A
361	361 A
480	480 A

d

Enclosure Type	
Code	Description
N	Open
F	NEMA 4/12 (IP65)

e

Input Line Voltage Open Type	
Code	Description
B	200...460V AC, 3-Phase, 50/60 Hz
C	200...600V AC, 3-Phase, 50/60 Hz
Non-Combination Enclosed Only	
H	200...208V AC, 3-Phase, 50/60 Hz
A	230V AC, 3-Phase, 50/60 Hz
B	400...460V AC, 3-Phase, 50/60 Hz
C	500...575V AC, 3-Phase, 50/60 Hz

f

Control Voltage	
Code	Description
D	100...240V AC
R	24V AC/DC (Open Type only)

g

Options (see page 42 for a full listing)	
Code	Description
8L	Line Mounted Protective Module (Enclosed Type only)

Load-side MOVs are not available when used with inside-the-delta connections. MOVs can be field installed for open type units.

Combination

152H – C 30 F BD 43 – 8L
a b c d e f g

a

Bulletin Number	
Code	Description
152H	Solid-State Controller with Fusible Disconnect
153H	Solid-State Controller with Circuit Breaker

b

Controller Type	
Code	Description
C	SMC-3

c

Ampere Ratings	
Code	Description
3	3 A
9	9 A
16	16 A
19	19 A
25	25 A
30	30 A
37	37 A
43	43 A
60	60 A
85	85 A
108	108 A
135	135 A
201	201 A
251	251 A
317	317 A
361	361 A
480	480 A

e

Input Line Voltage Open Type	
Code	Description
HD	200...208V AC, 3-Phase, 50/60 Hz
AD	230V AC, 3-Phase, 50/60 Hz
BD	400...460V AC, 3-Phase, 50/60 Hz
CD	500...575V AC, 3-Phase, 50/60 Hz

g

Options (see page 42 for a full listing)	
Code	Description
8L	Line Mounted Protective Module (Enclosed Type only)

Load-side MOVs are not available when used with inside-the-delta connections.

d

Enclosure Type	
Code	Description
F	NEMA Type 4/12 (IP65)
J	NEMA Type 12 (IP54)
X	NEMA Type 3R (IP44)

f

Horsepower									
Cat. No.	Hp Rating	Cat. No.	Hp Rating	Cat. No.	Hp Rating	Cat. No.	Hp Rating	Cat. No.	Hp Rating
33	0.5	39	5	46	40	52	150	60	450
34	0.75	40	7.5	47	50	54	200	61	500
35	1	41	10	48	60	56	250	62	600
36	1.5	42	15	49	75	57	300	63	700
37	2	43	20	50	100	58	350	65	800
38	3	44	25	51	125	59	400	67	1000
—	—	45	30	—	—	—	—	—	—

Open Type and Non-Combination Enclosed (IP65, NEMA 4/12) Controllers — For use with Line-Connected Motors

Rated Voltage [V AC]	Motor Current [A]‡	Max. kW, 50 Hz	Max. Hp, 60 Hz	Control Power	Open Type — Line-Connected Motors	IP65 (Type 4/12) Enclosed Non-Combination Controllers*
					Cat. No.	Cat. No.
200/208	1...3	—	0.5	100...240V AC, 50/60 Hz	150-C3NBD	150-C3FHD
		—		24V AC/DC	150-C3NBR	—
	3...9	—	0.75...2	100...240V AC, 50/60 Hz	150-C9NBD	150-C9FHD
		—		24V AC/DC	150-C9NBR	—
	5.3...16	—	1.5...3	100...240V AC, 50/60 Hz	150-C16NBD	150-C16FHD
		—		24V AC/DC	150-C16NBR	—
	6.3...19	—	1.5...3	100...240V AC, 50/60 Hz	150-C19NBD	150-C25FHD
		—		24V AC/DC	150-C19NBR	—
	9.2...25	—	3...7.5	100...240V AC, 50/60 Hz	150-C25NBD	150-C25FHD
		—		24V AC/DC	150-C25NBR	—
	10...30	—	3...7.5	100...240V AC, 50/60 Hz	150-C30NBD	150-C30FHD
		—		24V AC/DC	150-C30NBR	—
	12.3...37	—	5...10	100...240V AC, 50/60 Hz	150-C37NBD	150-C37FHD
		—		24V AC/DC	150-C37NBR	—
	14.3...43	—	5...10	100...240V AC, 50/60 Hz	150-C43NBD	150-C43FHD
		—		24V AC/DC	150-C43NBR	—
	20...60	—	7.5...15	100...240V AC, 50/60 Hz	150-C60NBD	150-C60FHD
		—		24V AC/DC	150-C60NBR	—
	28.3...85	—	10...25	100...240V AC, 50/60 Hz	150-C85NBD	150-C85FHD
		—		24V AC/DC	150-C85NBR	—
27...108	—	20...30	100...240V AC, 50/60 Hz	150-C108NBD	150-C108FHD	
	—		24V AC/DC Δ	150-C108NBR	—	
34...135	—	25...40	100...240V AC, 50/60 Hz	150-C135NBD	150-C135FHD	
	—		24V AC/DC Δ	150-C135NBR	—	
67...201	—	40...60	100...240V AC, 50/60 Hz	150-C201NBD	150-C201FHD	
	—		24V AC/DC Δ	150-C201NBR	—	
84...251	—	50...75	100...240V AC, 50/60 Hz	150-C251NBD	150-C251FHD	
	—		24V AC/DC Δ	150-C251NBR	—	
106...317	—	60...100	100...240V AC, 50/60 Hz	150-C317NBD	150-C317FHD	
	—		24V AC/DC Δ	150-C317NBR	—	
120...361	—	75...125	100...240V AC, 50/60 Hz	150-C361NBD	150-C361FHD	
	—		24V AC/DC Δ	150-C361NBR	—	
160...480	—	100...150	100...240V AC, 50/60 Hz	150-C480NBD	150-C480FHD	
	—		24V AC/DC Δ	150-C480NBR	—	

‡ Motor FLA rating should fall within specified current range for unit to operate properly.

* These controllers require a separate 100...240V, 50/60 Hz single-phase control source. To add a control circuit transformer to the enclosure, add the appropriate option code to the catalog string.

Δ Separate 120V or 240V single phase is required for fan operation.

Open Type and Non-Combination Enclosed (IP65, NEMA 4/12) Controllers — For use with Line-Connected Motors, Continued

Rated Voltage [V AC]	Motor Current [A]‡	Max. kW, 50 Hz	Max. Hp, 60 Hz	Control Power	Open Type — Line-Connected Motors	IP65 (Type 4/12) Enclosed Non-Combination Controllers♣
					Cat. No.	Cat. No.
230	1...3	0.55	0.5	100...240V AC, 50/60 Hz	150-C3NBD	150-C3FAD
				24V AC/DC	150-C3NBR	—
	3...9	2.2	0.75...2	100...240V AC, 50/60 Hz	150-C9NBD	150-C9FAD
				24V AC/DC	150-C9NBR	—
	5.3...16	4	1.5...5	100...240V AC, 50/60 Hz	150-C16NBD	150-C16FAD
				24V AC/DC	150-C16NBR	—
	6.3...19	4	2...5	100...240V AC, 50/60 Hz	150-C19NBD	150-C25FAD
				24V AC/DC	150-C19NBR	—
	9.2...25	5.5	3...7.5	100...240V AC, 50/60 Hz	150-C25NBD	150-C25FAD
				24V AC/DC	150-C25NBR	—
	10...30	7.5	5...10	100...240V AC, 50/60 Hz	150-C30NBD	150-C30FAD
				24V AC/DC	150-C30NBR	—
	12.3...37	7.5	5...10	100...240V AC, 50/60 Hz	150-C37NBD	150-C37FAD
				24V AC/DC	150-C37NBR	—
	14.3...43	11	5...15	100...240V AC, 50/60 Hz	150-C43NBD	150-C43FAD
				24V AC/DC	150-C43NBR	—
	20...60	15	7.5...20	100...240V AC, 50/60 Hz	150-C60NBD	150-C60FAD
				24V AC/DC	150-C60NBR	—
	28.3...85	22	15...30	100...240V AC, 50/60 Hz	150-C85NBD	150-C85FAD
				24V AC/DC	150-C85NBR	—
27...108	30	20...40	100...240V AC, 50/60 Hz	150-C108NBD	150-C108FAD	
			24V AC/DCΔ	150-C108NBR	—	
34...135	37	25...50	100...240V AC, 50/60 Hz	150-C135NBD	150-C135FAD	
			24V AC/DCΔ	150-C135NBR	—	
67...201	55	40...75	100...240V AC, 50/60 Hz	150-C201NBD	150-C201FAD	
			24V AC/DCΔ	150-C201NBR	—	
84...251	75	50...100	100...240V AC, 50/60 Hz	150-C251NBD	150-C251FAD	
			24V AC/DCΔ	150-C251NBR	—	
106...317	90	60...125	100...240V AC, 50/60 Hz	150-C317NBD	150-C317FAD	
			24V AC/DCΔ	150-C317NBR	—	
120...361	110	75...150	100...240V AC, 50/60 Hz	150-C361NBD	150-C361FAD	
			24V AC/DCΔ	150-C361NBR	—	
160...480	132	100...200	100...240V AC, 50/60 Hz	150-C480NBD	150-C480FAD	
			24V AC/DCΔ	150-C480NBR	—	

‡ Motor FLA rating should fall within specified current range for unit to operate properly.

♣ These controllers require a separate 100...240V, 50/60 Hz single-phase control source. To add a control circuit transformer to the enclosure, add the appropriate option code to the catalog string.

Δ Separate 120V or 240V single phase is required for fan operation.

SMC™-3 Smart Motor Controllers

Product Selection

Open Type and Non-Combination Enclosed (IP65, NEMA 4/12) Controllers — For use with Line-Connected Motors, Continued

Rated Voltage [V AC]	Motor Current [A]‡	Max. kW, 50 Hz	Max. Hp, 60 Hz	Control Power	Open Type — Line-Connected Motors	IP65 (Type 4/12) Enclosed Non-Combination Controllers♣
					Cat. No.	Cat. No.
380/400/ 415/460	1...3	1.1	0.5...1.5	100...240V AC, 50/60 Hz	150-C3NBD	150-C3FBD
				24V AC/DC	150-C3NBR	—
	3...9	4	1.5...5	100...240V AC, 50/60 Hz	150-C9NBD	150-C9FBD
				24V AC/DC	150-C9NBR	—
	5.3...16	7.5	5...10	100...240V AC, 50/60 Hz	150-C16NBD	150-C16FBD
				24V AC/DC	150-C16NBR	—
	6.3...19	7.5	5...10	100...240V AC, 50/60 Hz	150-C19NBD	150-C19NBR
				24V AC/DC	150-C19NBR	—
	9.2...25	11	7.5...15	100...240V AC, 50/60 Hz	150-C25NBD	150-C25NBR
				24V AC/DC	150-C25NBR	—
	10...30	15	7.5...20	100...240V AC, 50/60 Hz	150-C30NBD	150-C30FBD
				24V AC/DC	150-C30NBR	—
	12.3...37	18.5	10...25	100...240V AC, 50/60 Hz	150-C37NBD	150-C37FBD
				24V AC/DC	150-C37NBR	—
	14.3...43	22	10...30	100...240V AC, 50/60 Hz	150-C43NBD	150-C43FBD
				24V AC/DC	150-C43NBR	—
	20...60	30	15...40	100...240V AC, 50/60 Hz	150-C60NBD	150-C60FBD
				24V AC/DC	150-C60NBR	—
	28.3...85	45	25...60	100...240V AC, 50/60 Hz	150-C85NBD	150-C85FBD
				24V AC/DC	150-C85NBR	—
27...108	55	50...75	100...240V AC, 50/60 Hz	150-C108NBD	150-C108FBD	
			24V AC/DCΔ	150-C108NBR	—	
34...135	75	60...100	100...240V AC, 50/60 Hz	150-C135NBD	150-C135FBD	
			24V AC/DCΔ	150-C135NBR	—	
67...201	95...110	75...150	100...240V AC, 50/60 Hz	150-C201NBD	150-C201FBD	
			24V AC/DCΔ	150-C201NBR	—	
84...251	95...132	100...200	100...240V AC, 50/60 Hz	150-C251NBD	150-C251FBD	
			24V AC/DCΔ	150-C251NBR	—	
106...317	95...160	125...250	100...240V AC, 50/60 Hz	150-C317NBD	150-C317FBD	
			24V AC/DCΔ	150-C317NBR	—	
120...361	110...200	250...300	100...240V AC, 50/60 Hz	150-C361NBD	150-C361FBD	
			24V AC/DCΔ	150-C361NBR	—	
160...480	160...250	300...400	100...240V AC, 50/60 Hz	150-C480NBD	150-C480FBD	
			24V AC/DCΔ	150-C480NBR	—	

‡ Motor FLA rating should fall within specified current range for unit to operate properly.

♣ These controllers require a separate 100...240V, 50/60 Hz single-phase control source. To add a control circuit transformer to the enclosure, add the appropriate option code to the catalog string.

Δ Separate 120V or 240V single phase is required for fan operation.

Open Type and Non-Combination Enclosed (IP65, NEMA 4/12) Controllers — For use with Line-Connected Motors, Continued

Rated Voltage [V AC]	Motor Current [A]‡	Max. kW, 50 Hz	Max. Hp, 60 Hz	Control Power	Open Type — Line-Connected Motors	IP65 (Type 4/12) Enclosed Non-Combination Controllers♣
					Cat. No.	Cat. No.
500/575	1...3	1.5	0.75...2	100...240V AC, 50/60 Hz	150-C3NCD	150-C3FCD
				24V AC/DC	150-C3NCR	—
	3...9	5.5	3...7.5	100...240V AC, 50/60 Hz	150-C9NCD	150-C9FCD
				24V AC/DC	150-C9NCR	—
	5.3...16	7.5	5...10	100...240V AC, 50/60 Hz	150-C16NCD	150-C16FCD
				24V AC/DC	150-C16NCR	—
	6.3...19	11	7.5...15	100...240V AC, 50/60 Hz	150-C19NCD	150-C25FCD
				24V AC/DC	150-C19NCR	—
	9.2...25	15	7.5...20	100...240V AC, 50/60 Hz	150-C25NCD	150-C25FCD
				24V AC/DC	150-C25NCR	—
	10...30	18.5	10...25	100...240V AC, 50/60 Hz	150-C30NCD	150-C30FCD
				24V AC/DC	150-C30NCR	—
	12.3...37	22	15...30	100...240V AC, 50/60 Hz	150-C37NCD	150-C37FCD
				24V AC/DC	150-C37NCR	—
	14.3...43	22	15...40	100...240V AC, 50/60 Hz	150-C43NCD	150-C43FCD
				24V AC/DC	150-C43NCR	—
	20...60	37	20...50	100...240V AC, 50/60 Hz	150-C60NCD	150-C60FCD
				24V AC/DC	150-C60NCR	—
	28.3...85	55	30...75	100...240V AC, 50/60 Hz	150-C85NCD	150-C85FCD
				24V AC/DC	150-C85NCR	—
27...108	75	60...100	100...240V AC, 50/60 Hz	150-C108NCD	150-C108FCD	
			24V AC/DCΔ	150-C108NCR	—	
34...135	90	75...125	100...240V AC, 50/60 Hz	150-C135NCD	150-C135FCD	
			24V AC/DCΔ	150-C135NCR	—	
67...201	75...132	100...200	100...240V AC, 50/60 Hz	150-C201NCD	150-C201FCD	
			24V AC/DCΔ	150-C201NCR	—	
84...251	90...160	125...250	100...240V AC, 50/60 Hz	150-C251NCD	150-C251FCD	
			24V AC/DCΔ	150-C251NCR	—	
106...317	100...200	200...300	100...240V AC, 50/60 Hz	150-C317NCD	150-C317FCD	
			24V AC/DCΔ	150-C317NCR	—	
120...361	132...250	200...350	100...240V AC, 50/60 Hz	150-C361NCD	150-C361FCD	
			24V AC/DCΔ	150-C361NCR	—	
160...480	200...315	250...500	100...240V AC, 50/60 Hz	150-C480NCD	150-C480FCD	
			24V AC/DCΔ	150-C480NCR	—	

‡ Motor FLA rating should fall within specified current range for unit to operate properly.

♣ These controllers require a separate 100...240V, 50/60 Hz single-phase control source. To add a control circuit transformer to the enclosure, add the appropriate option code to the catalog string.

Δ Separate 120V or 240V single phase is required for fan operation.

Bulletin 150
SMC™-3 Smart Motor Controllers
 Product Selection

Open Type Controllers — For use with Delta-Connected Motors

Rated Voltage [V AC]	Motor Current [A]‡	Max. kW, 50 Hz	Max. Hp, 60 Hz	Control Power	Open Type
					Cat. No.
200/208	1.7...5.1	—	1	100...240V AC, 50/60 Hz	150-C3NBD
		—		24V AC/DC	150-C3NBR
	5.1...16	—	1.5...3	100...240V AC, 50/60 Hz	150-C9NBD
		—		24V AC/DC	150-C9NBR
	9.1...27.6	—	3...7.5	100...240V AC, 50/60 Hz	150-C16NBD
		—		24V AC/DC	150-C16NBR
	10.9...32.8	—	3...10	100...240V AC, 50/60 Hz	150-C19NBD
		—		24V AC/DC	150-C19NBR
	14.3...43	—	3...10	100...240V AC, 50/60 Hz	150-C25NBD
		—		24V AC/DC	150-C25NBR
	17.3...52	—	5...10	100...240V AC, 50/60 Hz	150-C30NBD
		—		24V AC/DC	150-C30NBR
	21...64	—	7.5...20	100...240V AC, 50/60 Hz	150-C37NBD
		—		24V AC/DC	150-C37NBR
	25...74	—	7.5...20	100...240V AC, 50/60 Hz	150-C43NBD
		—		24V AC/DC	150-C43NBR
	34.6...104	—	15...30	100...240V AC, 50/60 Hz	150-C60NBD
		—		24V AC/DC	150-C60NBR
	50...147	—	15...40	100...240V AC, 50/60 Hz	150-C85NBD
		—		24V AC/DC	150-C85NBR
47...187	—	20...60	100...240V AC, 50/60 Hz	150-C108NBD	
	—		24V AC/DC ^Δ	150-C108NBR	
59...234	—	20...75	100...240V AC, 50/60 Hz	150-C135NBD	
	—		24V AC/DC ^Δ	150-C135NBR	
116...348	—	75...100	100...240V AC, 50/60 Hz	150-C201NBD	
	—		24V AC/DC ^Δ	150-C201NBR	
145...435	—	100...150	100...240V AC, 50/60 Hz	150-C251NBD	
	—		24V AC/DC ^Δ	150-C251NBR	
183...549	—	100...200	100...240V AC, 50/60 Hz	150-C317NBD	
	—		24V AC/DC ^Δ	150-C317NBR	
208...625	—	125...200	100...240V AC, 50/60 Hz	150-C361NBD	
	—		24V AC/DC ^Δ	150-C361NBR	
277...831	—	200...300	100...240V AC, 50/60 Hz	150-C480NBD	
	—		24V AC/DC ^Δ	150-C480NBR	

‡ Motor FLA rating should fall within specified current range for unit to operate properly.

Δ Separate 120V or 240V single phase is required for fan operation.

Open Type Controllers — For use with Delta-Connected Motors, Continued

Rated Voltage [V AC]	Motor Current [A]‡	Max. kW, 50 Hz	Max. Hp, 60 Hz	Control Power	Open Type
					Cat. No.
230	1.7...5.1	0.25...1.1	1	100...240V AC, 50/60 Hz	150-C3NBD
				24V AC/DC	150-C3NBR
	5.1...16	1.1...4	1...5	100...240V AC, 50/60 Hz	150-C9NBD
				24V AC/DC	150-C9NBR
	9.1...27.6	2.2...7.5	3...7.5	100...240V AC, 50/60 Hz	150-C16NBD
				24V AC/DC	150-C16NBR
	10.9...32.8	2.2...7.5	3...10	100...240V AC, 50/60 Hz	150-C19NBD
				24V AC/DC	150-C19NBR
	14.3...43	4...11	3...15	100...240V AC, 50/60 Hz	150-C25NBD
				24V AC/DC	150-C25NBR
	17.3...52	4...15	5...15	100...240V AC, 50/60 Hz	150-C30NBD
				24V AC/DC	150-C30NBR
	21...64	5.5...18.5	7.5...20	100...240V AC, 50/60 Hz	150-C37NBD
				24V AC/DC	150-C37NBR
	25...74	5.5...22	7.5...25	100...240V AC, 50/60 Hz	150-C43NBD
				24V AC/DC	150-C43NBR
	34.6...104	7.5...30	15...40	100...240V AC, 50/60 Hz	150-C60NBD
				24V AC/DC	150-C60NBR
	50...147	15...45	20...50	100...240V AC, 50/60 Hz	150-C85NBD
				24V AC/DC	150-C85NBR
47...187	55	20...60	100...240V AC, 50/60 Hz	150-C108NBD	
			24V AC/DC Δ	150-C108NBR	
59...234	75	25...75	100...240V AC, 50/60 Hz	150-C135NBD	
			24V AC/DC Δ	150-C135NBR	
116...348	110	75...125	100...240V AC, 50/60 Hz	150-C201NBD	
			24V AC/DC Δ	150-C201NBR	
145...435	132	100...150	100...240V AC, 50/60 Hz	150-C251NBD	
			24V AC/DC Δ	150-C251NBR	
183...549	160	125...200	100...240V AC, 50/60 Hz	150-C317NBD	
			24V AC/DC Δ	150-C317NBR	
208...625	200	150...250	100...240V AC, 50/60 Hz	150-C361NBD	
			24V AC/DC Δ	150-C361NBR	
277...831	250	200...300	100...240V AC, 50/60 Hz	150-C480NBD	
			24V AC/DC Δ	150-C480NBR	

‡ Motor FLA rating should fall within specified current range for unit to operate properly.

Δ Separate 120V or 240V single phase is required for fan operation.

Bulletin 150
SMC™-3 Smart Motor Controllers
 Product Selection

Open Type Controllers — For use with Delta-Connected Motors, Continued

Rated Voltage [V AC]	Motor Current [A]‡	Max. kW, 50 Hz	Max. Hp, 60 Hz	Control Power	Open Type
					Cat. No.
380/400/415/460	1.7...5.1	0.55...2.2	0.5...2	100...240V AC, 50/60 Hz	150-C3NBD
				24V AC/DC	150-C3NBR
	5.1...16	2.2...7.5	2...7.5	100...240V AC, 50/60 Hz	150-C9NBD
				24V AC/DC	150-C9NBR
	9.1...27.6	4...11	5...15	100...240V AC, 50/60 Hz	150-C16NBD
				24V AC/DC	150-C16NBR
	10.9...32.8	4...15	5...15	100...240V AC, 50/60 Hz	150-C19NBD
				24V AC/DC	150-C19NBR
	14.3...43	5.5...22	7.5...20	100...240V AC, 50/60 Hz	150-C25NBD
				24V AC/DC	150-C25NBR
	17.3...52	7.5...22	7.5...30	100...240V AC, 50/60 Hz	150-C30NBD
				24V AC/DC	150-C30NBR
	21...64	7.5...30	10...40	100...240V AC, 50/60 Hz	150-C37NBD
				24V AC/DC	150-C37NBR
	25...74	11...37	10...50	100...240V AC, 50/60 Hz	150-C43NBD
				24V AC/DC	150-C43NBR
	34.6...104	15...55	20...75	100...240V AC, 50/60 Hz	150-C60NBD
				24V AC/DC	150-C60NBR
	50...147	22...75	25...100	100...240V AC, 50/60 Hz	150-C85NBD
				24V AC/DC	150-C85NBR
47...187	90	40...150	100...240V AC, 50/60 Hz	150-C108NBD	
			24V AC/DC ^Δ	150-C108NBR	
59...234	132	50...150	100...240V AC, 50/60 Hz	150-C135NBD	
			24V AC/DC ^Δ	150-C135NBR	
116...348	160	150...250	100...240V AC, 50/60 Hz	150-C201NBD	
			24V AC/DC ^Δ	150-C201NBR	
145...435	250	200...350	100...240V AC, 50/60 Hz	150-C251NBD	
			24V AC/DC ^Δ	150-C251NBR	
183...549	315	250...450	100...240V AC, 50/60 Hz	150-C317NBD	
			24V AC/DC ^Δ	150-C317NBR	
208...625	355	300...500	100...240V AC, 50/60 Hz	150-C361NBD	
			24V AC/DC ^Δ	150-C361NBR	
277...831	450	350...700	100...240V AC, 50/60 Hz	150-C480NBD	
			24V AC/DC ^Δ	150-C480NBR	

‡ Motor FLA rating should fall within specified current range for unit to operate properly.

Δ Separate 120V or 240V single phase is required for fan operation.

Open Type Controllers — For use with Delta-Connected Motors, Continued

Rated Voltage [V AC]	Motor Current [A]‡	Max. kW, 50 Hz	Max. Hp, 60 Hz	Control Power	Open Type
					Cat. No.
500/575	1.7...5.1	0.75...3	1...3	100...240V AC, 50/60 Hz	150-C3NCD
				24V AC/DC	150-C3NCR
	5.1...16	3...7.5	3...10	100...240V AC, 50/60 Hz	150-C9NCD
				24V AC/DC	150-C9NCR
	9.1...27.6	5.5...15	7.5...20	100...240V AC, 50/60 Hz	150-C16NCD
				24V AC/DC	150-C16NCR
	10.9...32.8	5.5...22	7.5...30	100...240V AC, 50/60 Hz	150-C19NCD
				24V AC/DC	150-C19NCR
	14.3...43	7.5...22	10...40	100...240V AC, 50/60 Hz	150-C25NCD
				24V AC/DC	150-C25NCR
	17.3...52	11...30	15...50	100...240V AC, 50/60 Hz	150-C30NCD
				24V AC/DC	150-C30NCR
	21...64	11...37	15...60	100...240V AC, 50/60 Hz	150-C37NCD
				24V AC/DC	150-C37NCR
	25...74	15...45	20...60	100...240V AC, 50/60 Hz	150-C43NCD
				24V AC/DC	150-C43NCR
	34.6...104	22...55	30...100	100...240V AC, 50/60 Hz	150-C60NCD
				24V AC/DC	150-C60NCR
	50...147	30...90	40...150	100...240V AC, 50/60 Hz	150-C85NCD
				24V AC/DC	150-C85NCR
47...187	132	50...150	100...240V AC, 50/60 Hz	150-C108NCD	
			24V AC/DC Δ	150-C108NCR	
59...234	160	60...200	100...240V AC, 50/60 Hz	150-C135NCD	
			24V AC/DC Δ	150-C135NCR	
116...348	250	250...300	100...240V AC, 50/60 Hz	150-C201NCD	
			24V AC/DC Δ	150-C201NCR	
145...435	315	250...400	100...240V AC, 50/60 Hz	150-C251NCD	
			24V AC/DC Δ	150-C251NCR	
183...549	400	300...500	100...240V AC, 50/60 Hz	150-C317NCD	
			24V AC/DC Δ	150-C317NCR	
208...625	450	350...600	100...240V AC, 50/60 Hz	150-C361NCD	
			24V AC/DC Δ	150-C361NCR	
277...831	560	400...900	100...240V AC, 50/60 Hz	150-C480NCD	
			24V AC/DC Δ	150-C480NCR	

‡ Motor FLA rating should fall within specified current range for unit to operate properly.

Δ Separate 120V or 240V single phase is required for fan operation.

Bulletin 150
SMC™-3 Smart Motor Controllers
 Product Selection

Combination Enclosed (IP65, NEMA 4/12) Controllers with Fusible Disconnect or Circuit Breaker

Rated Voltage [V AC]	Current Rating [A]	kW	Hp	IP65 (Type 4/12) Enclosed Combination Controllers with Fusible Disconnect ‡		IP65 (Type 4/12) Enclosed Combination Controllers with Circuit Breaker ‡	
				Cat. No.		Cat. No.	
200/208	3	—	0.5	152H-C3FHD-33	153H-C3FHD-33	152H-C3FHD-33	153H-C3FHD-33
	9	—	0.75	152H-C9FHD-34	153H-C9FHD-34	152H-C9FHD-34	153H-C9FHD-34
	9	—	1	152H-C9FHD-35	153H-C9FHD-35	152H-C9FHD-35	153H-C9FHD-35
	9	—	1.5	152H-C9FHD-36	153H-C9FHD-36	152H-C9FHD-36	153H-C9FHD-36
	16	—	2	152H-C16FHD-37	153H-C16FHD-37	152H-C16FHD-37	153H-C16FHD-37
	16	—	3	152H-C16FHD-38	153H-C16FHD-38	152H-C16FHD-38	153H-C16FHD-38
	25	—	5	152H-C25FHD-39	153H-C25FHD-39	152H-C25FHD-39	153H-C25FHD-39
	37	—	7.5	152H-C37FHD-40	153H-C37FHD-40	152H-C37FHD-40	153H-C37FHD-40
	43	—	10	152H-C43FHD-41	153H-C43FHD-41	152H-C43FHD-41	153H-C43FHD-41
	60	—	15	152H-C60FHD-42	153H-C60FHD-42	152H-C60FHD-42	153H-C60FHD-42
	85	—	20	152H-C85FHD-43	153H-C85FHD-43	152H-C85FHD-43	153H-C85FHD-43
	85	—	25	152H-C85FHD-44	153H-C85FHD-44	152H-C85FHD-44	153H-C85FHD-44
	108	—	30	152H-C108FHD-45	153H-C108FHD-45	152H-C108FHD-45	153H-C108FHD-45
	135	—	40	152H-C135FHD-46	153H-C135FHD-46	152H-C135FHD-46	153H-C135FHD-46
	201	—	60	152H-C201FHD-48	153H-C201FHD-48	152H-C201FHD-48	153H-C201FHD-48
	251	—	75	152H-C251FHD-49	153H-C251FHD-49	152H-C251FHD-49	153H-C251FHD-49
	317	—	100	152H-C317FHD-50	153H-C317FHD-50	152H-C317FHD-50	153H-C317FHD-50
361	—	125	152H-C361FHD-51	153H-C361FHD-51	152H-C361FHD-51	153H-C361FHD-51	
480	—	150	152H-C480FHD-52	153H-C480FHD-52	152H-C480FHD-52	153H-C480FHD-52	
230	3	0.37	0.5	152H-C3FAD-33	153H-C3FAD-33	152H-C3FAD-33	153H-C3FAD-33
	9	0.55	0.75	152H-C9FAD-34	153H-C9FAD-34	152H-C9FAD-34	153H-C9FAD-34
	9	0.75	1	152H-C9FAD-35	153H-C9FAD-35	152H-C9FAD-35	153H-C9FAD-35
	9	1.1	1.5	152H-C9FAD-36	153H-C9FAD-36	152H-C9FAD-36	153H-C9FAD-36
	9	1.5	2	152H-C9FAD-37	153H-C9FAD-37	152H-C9FAD-37	153H-C9FAD-37
	16	2.2	3	152H-C16FAD-38	153H-C16FAD-38	152H-C16FAD-38	153H-C16FAD-38
	25	3.7	5	152H-C25FAD-39	153H-C25FAD-39	152H-C25FAD-39	153H-C25FAD-39
	30	5.5	7.5	152H-C30FAD-40	153H-C30FAD-40	152H-C30FAD-40	153H-C30FAD-40
	37	7.5	10	152H-C37FAD-41	153H-C37FAD-41	152H-C37FAD-41	153H-C37FAD-41
	43	11	15	152H-C43FAD-42	153H-C43FAD-42	152H-C43FAD-42	153H-C43FAD-42
	60	15	20	152H-C60FAD-43	153H-C60FAD-43	152H-C60FAD-43	153H-C60FAD-43
	85	18.5	25	152H-C85FAD-44	153H-C85FAD-44	152H-C85FAD-44	153H-C85FAD-44
	85	22	30	152H-C85FAD-45	153H-C85FAD-45	152H-C85FAD-45	153H-C85FAD-45
	108	30	40	152H-C108FAD-46	153H-C108FAD-46	152H-C108FAD-46	153H-C108FAD-46
	135	37	50	152H-C135FAD-47	153H-C135FAD-47	152H-C135FAD-47	153H-C135FAD-47
	201	55	75	152H-C201FAD-49	153H-C201FAD-49	152H-C201FAD-49	153H-C201FAD-49
	251	75	100	152H-C251FAD-50	153H-C251FAD-50	152H-C251FAD-50	153H-C251FAD-50
317	90	125	152H-C317FAD-51	153H-C317FAD-51	152H-C317FAD-51	153H-C317FAD-51	
361	110	150	152H-C361FAD-52	153H-C361FAD-52	152H-C361FAD-52	153H-C361FAD-52	
480	147	200	152H-C480JAD-54	153H-C480FAD-54	152H-C480JAD-54	153H-C480FAD-54	

‡ These controllers require a separate 100...240V, 50/60 Hz single-phase control source. To add a control circuit transformer to the enclosure, add the appropriate option code to the catalog string.

♣ Available in IP54 (Type 12) enclosure only.

Combination Enclosed (IP65, NEMA 4/12) Controllers with Fusible Disconnect or Circuit Breaker, Continued

Rated Voltage [V AC]	Current Rating [A]	kW	Hp	IP65 (Type 4/12) Enclosed Combination Controllers with Fusible Disconnect ‡		IP65 (Type 4/12) Enclosed Combination Controllers with Circuit Breaker ‡	
				Cat. No.		Cat. No.	
460	3	0.37	0.5	152H-C3FBD-33	153H-C3FBD-33		
	3	0.55	0.75	152H-C3FBD-34	153H-C3FBD-34		
	3	0.75	1	152H-C3FBD-35	153H-C3FBD-35		
	9	1.1	1.5	152H-C9FBD-36	153H-C9FBD-36		
	9	1.5	2	152H-C9FBD-37	153H-C9FBD-37		
	9	2.2	3	152H-C9FBD-38	153H-C9FBD-38		
	16	3.7	5	152H-C16FBD-39	153H-C16FBD-39		
	16	5.5	7.5	152H-C16FBD-40	153H-C16FBD-40		
	25	7.5	10	152H-C25FBD-41	153H-C25FBD-41		
	30	11	15	152H-C30FBD-42	153H-C30FBD-42		
	37	15	20	152H-C37FBD-43	153H-C37FBD-43		
	43	18.5	25	152H-C43FBD-44	153H-C43FBD-44		
	43	22	30	152H-C43FBD-45	153H-C43FBD-45		
	60	30	40	152H-C60FBD-46	153H-C60FBD-46		
	85	37	50	152H-C85FBD-47	153H-C85FBD-47		
	85	45	60	152H-C85FBD-48	153H-C85FBD-48		
	108	55	75	152H-C108FBD-49	153H-C108FBD-49		
	135	75	100	152H-C135FBD-50	153H-C135FBD-50		
	201	110	150	152H-C201FBD-52	153H-C201FBD-52		
	251	132	200	152H-C251FBD-54	153H-C251FBD-54		
317	160	250	152H-C317FBD-56	153H-C317FBD-56			
361	200	300	152H-C361FBD-57	153H-C361FBD-57			
480	250	400	♣ 152H-C480JBD-59	153H-C480FBD-59			
500/575	3	0.55	0.75	152H-C3FCD-34	153H-C3FCD-34		
	3	0.75	1	152H-C3FCD-35	153H-C3FCD-35		
	9	1.1	1.5	152H-C9FCD-36	153H-C9FCD-36		
	9	1.5	2	152H-C9FCD-37	153H-C9FCD-37		
	9	2.2	3	152H-C9FCD-38	153H-C9FCD-38		
	9	3.7	5	152H-C9FCD-39	153H-C9FCD-39		
	16	5.5	7.5	152H-C16FCD-40	153H-C16FCD-40		
	16	7.5	10	152H-C16FCD-41	153H-C16FCD-41		
	25	11	15	152H-C25FCD-42	153H-C25FCD-42		
	30	15	20	152H-C30FCD-43	153H-C30FCD-43		
	37	18.5	25	152H-C37FCD-44	153H-C37FCD-44		
	43	22	30	152H-C43FCD-45	153H-C43FCD-45		
	43	30	40	152H-C43FCD-46	153H-C43FCD-46		
	60	37	50	152H-C60FCD-47	153H-C60FCD-47		
	85	45	60	152H-C85FCD-48	153H-C85FCD-48		
	85	55	75	152H-C85FCD-49	153H-C85FCD-49		
	108	75	100	152H-C108FCD-50	153H-C108FCD-50		
	135	90	125	152H-C135FCD-51	153H-C135FCD-51		
	201	132	200	152H-C201FCD-54	153H-C201FCD-54		
	251	160	250	152H-C251FCD-56	153H-C251FCD-56		
317	200	300	152H-C317FCD-57	153H-C317FCD-57			
361	250	350	152H-C361FCD-58	153H-C361FCD-58			
480	315	500	♣ 152H-C480JCD-61	153H-C480FCD-61			

‡ These controllers require a separate 100...240V, 50/60 Hz single-phase control source. To add a control circuit transformer to the enclosure, add the appropriate option code to the catalog string.

♣ Available in IP54 (Type 12) enclosure only.

Bulletin 150
SMC™-3 Smart Motor Controllers
 Modifications/Accessories





Enclosed Options

Option	Description	Cat. No. Modification
Push Buttons	Start-Stop Push Button	-1
Selector Switch	Hand-Off-Auto Selector Switch	-3
Pilot Light	Transformer Pilot Light - Red Run Indicator	-4R
Control Circuit Transformer	Control Circuit Transformer (fused primary and secondary)	-6P
Protective Module	480V Line Side Protective Module	3...480 A
	600V Line Side Protective Module	3...480 A
	480V Load Side Protective Module	43...480 A
	600V Load Side Protective Module	43...480 A
	480V Both Line and Load Side Protective Module	43...480 A
	600V Both Line and Load Side Protective Module	43...480 A
Auxiliary Contacts	1 N.O. auxiliary contact	for 3...480 A units
	2 N.O. auxiliary contacts	for 3...480 A units
	1 N.O. and 1 N.C. auxiliary contacts	for 3...480 A units
Disconnect Auxiliary	N.O. disconnect auxiliary mounted on the operating mechanism	-98
	N.C. disconnect auxiliary mounted on the operating mechanism	-99
NEMA Bypass Contactor and Overload Relay	5...43 A§	-NB
	60...85 A§	
	108...135 A§	
	201...251 A	
	317...361 A	
	480 A	
MCS Bypass Contactor and Overload Relay	5...43 A§	-BP
	60...85 A§	
	108...135 A§	
	201...251 A	
	317...361 A	
	480 A	

§ Available only as a modified standard.

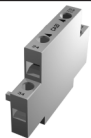
Accessories



Auxiliary Contact Blocks

Description	N.O.	N.C.	Connection Diagram	Cat. No.
 Auxiliary Contact Blocks for side mounting with sequence terminal designations 1- and 2-pole Quick and easy mounting without tools One block per device only	1	0		150-CA10
	2	0		150-CA20
	0	1		150-CA01
	1	1		150-CA11 (Form C)

Fans

Description	Optional	For Use With	Pkg. Qty.	Cat. No.
 Fan Field installed	Replacement	150-C3...37	1	150-CF64
		150-C43...85		150-CF147
		150-C108, 150-C135		41391-801-03
		150-C201, 150-C251		41391-801-01
		150-C317...C480		41391-801-02

Connecting Modules

Description	For Use With	Pkg. Qty.	Cat. No.
 Connecting modules to 140-M Electrical interconnection between SMC-3 and 140-M. Motor protector and SMC must be mounted separately.	Connects 140-M-C to 150-C3...25	1	150-CC25
	Connects 140-M-D to 150-C3...25	1	150-CD25
	Connects 140-M-F to 150-C3...37	1	150-CF45
 Connecting modules to 100-C Electrical interconnection between SMC-3 and 100-C. Contactor and SMC must be mounted separately.	Connects 100-C09...23 to 150-C3...19	1	150-CI23
	Connects 100-C30...37 to 150-C3...37	1	150-CI37

Protective Modules

Protective modules must not be placed on the load side of a device when using an inside-the-delta connection.

Description	For Use With	Pkg. Qty.	Cat. No.
 480V Protective Module	150-C3...37NB	1	150-C84
	150-C43...85NB (line and/or load)	1	150-C84P
	150-C108...480NB (line and/or load)	1	150-F84L
600V Protective Module	150-C3...37NC	1	150-C86
	150-C43...85NC (line and/or load)	1	150-C86P
	150-C108...480NC (line and/or load)	1	150-F86L

IEC Terminal Covers

Description	For Use With	Pkg. Qty.	Cat. No.
 Terminal Cover IEC line or load terminal covers for 108...480 A devices. Dead front protection	150-C108...-C135	1	150-TC1
	150-C201...-C251	1	150-TC2
	150-C317...-C480	1	150-TC3

Terminal Lug Kits (108...480 A)

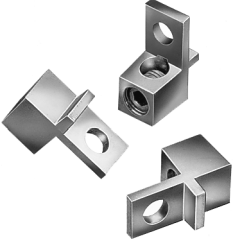
	Current Rating [A] ‡	Wire Size	Total No. of Line Controller Terminal Lugs Possible Each Side		Pkg. Qty.	Cat. No.
			Line Side	Load Side		
	108...135△	#6...250 MCM AWG 16 mm ² ...120 mm ²	3	3	3	199-LF1
	201...251△		6	6		
	317...480△	#4...500 MCM AWG 25 mm ² ...240 mm ²	6	6		199-LG1

Line and Load terminals are provided as standard on enclosed SMCs.

‡ 1...85 A units have box lugs standard. No additional lugs are required.

△ When a multi-conductor lug is required, refer to the Instruction Sheet for appropriate lug catalog number.

Marking Tags and Covers

Description	For Use With	Pkg. Qty.	Cat. No.
 Marking Tag Sheet 160 perforated paper labels each, 6 x 17 mm, to be used with a transparent cover	150-C, 150-D	10	100-FMP
Transparent Cover To be used with marking tag sheets	150-C, 150-D	100	100-FMC

Remote Reset Solenoid

Description	For Use With	Pkg. Qty.	Cat. No.
 Remote Reset Solenoid for remote reset of electronic overload	193-T all, 150-C	1	193-ER1⊗

⊗ Voltage Suffix Code

Available Coil Voltages 12...600V 50 Hz/12...600V 60 Hz

Standard Coil Voltages

Voltage	24	48	110	115	120	220	240
50 Hz	J	—	D	—	—	A	—
60 Hz	J	—	—	—	D	—	A
DC	Z24	Z48	—	Z01	—	—	—

Surcharge for special voltages up to 20 pcs. (no surcharge for quantities greater than 20 pcs.)

Bulletin 150
SMC™-3 Smart Motor Controllers
 Typical Wiring Diagrams

Two-Wire Configuration

IEC

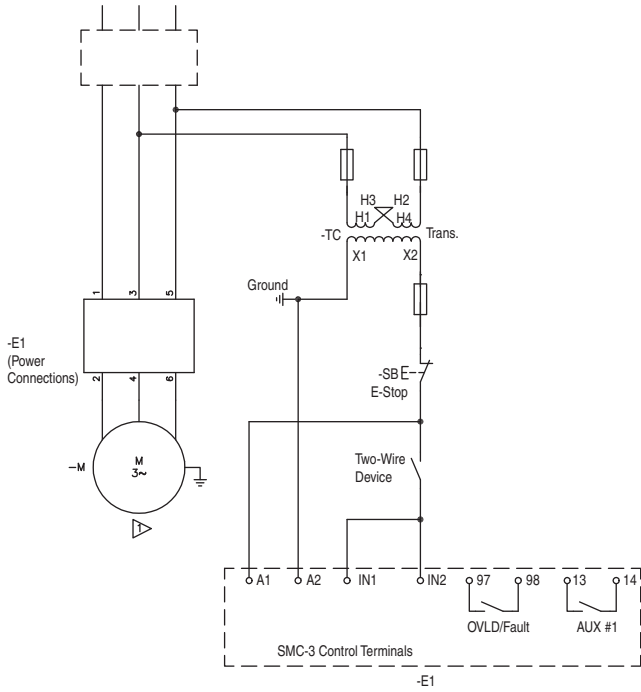

NEMA

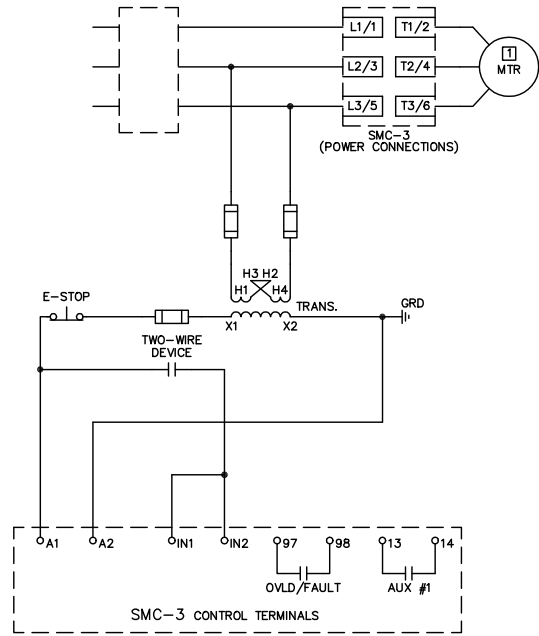

Three-Wire Configuration

IEC

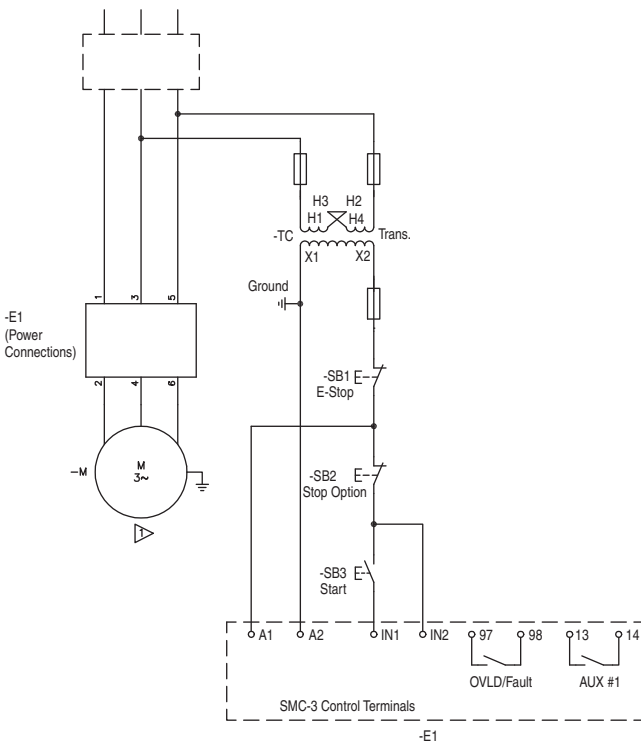

NEMA

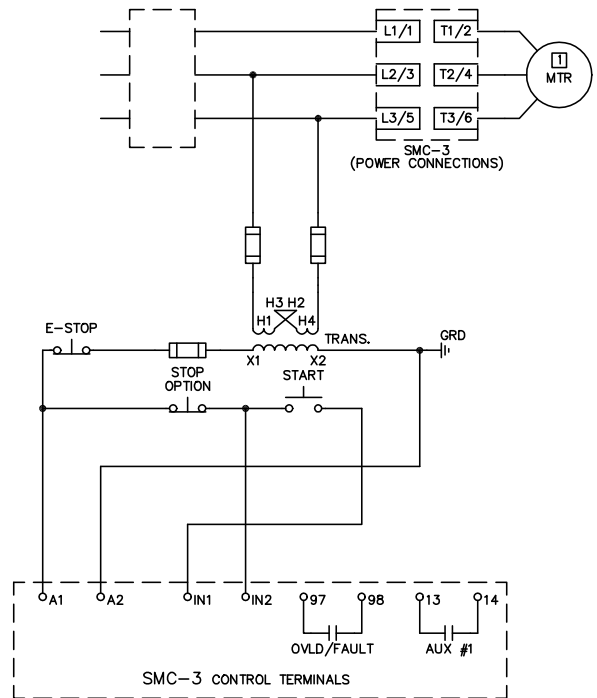

Isolation Contactor Configuration

IEC

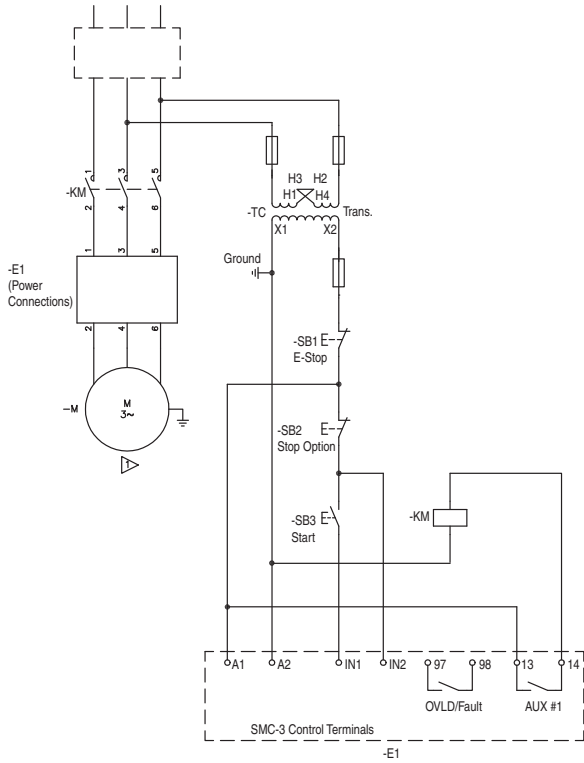

NEMA

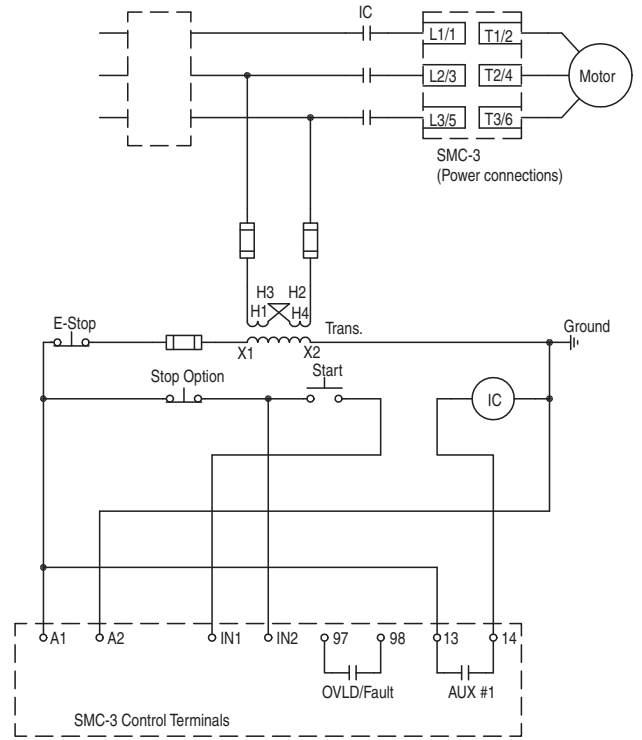

Reversing Configuration

Note: Minimum Off time equals 1.0 s.

IEC

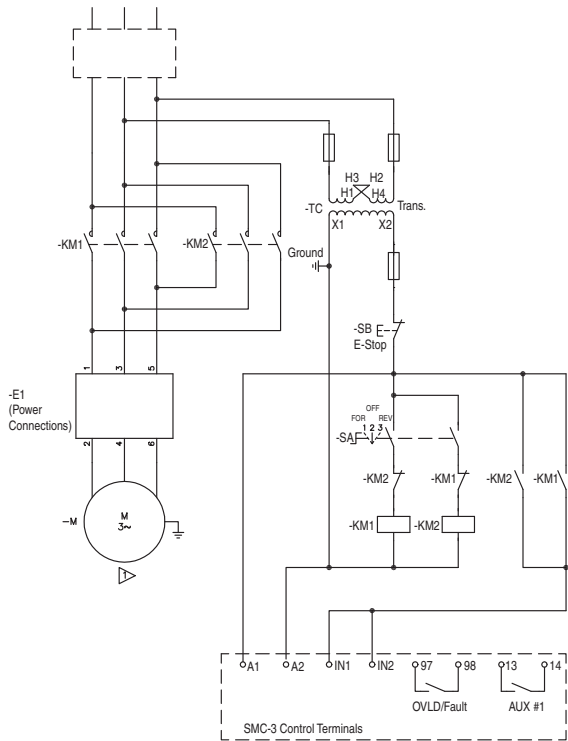

NEMA

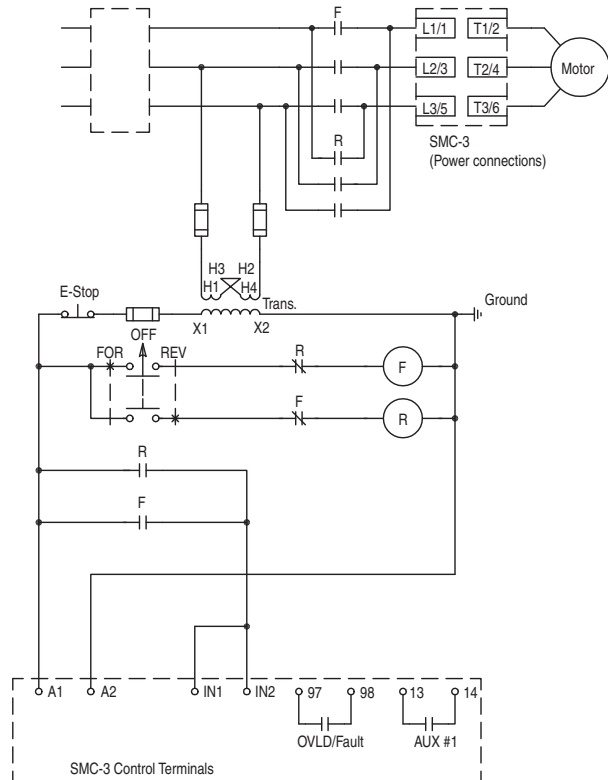

Bulletin 150
SMC™-3 Smart Motor Controllers
Specifications

Standard Features								
Selectable Start Times	2, 5, 10, 15, 20, 25, or 30 s							
Selectable Initial Torque	0%, 25%, 35%, and 65% of locked rotor torque							
Selectable Current Limit	150%, 250%, 350%, and 450% of full load current							
Selectable Kick Start — 450% FLA	0, 0.5, 1.0, or 1.5 s							
Selectable Soft Stop	Off, 100%, 200%, or 300% of the start time setting when wired							
Electrical Ratings								
Power Circuit	UL/CSA/NEMA			IEC				
	Rated Operation Voltage	200...480V AC 200...600V AC			200...480V~ — 400V~ 500V~ — 500V~			
	Rated Insulation Voltage	600V AC			500V~			
	Dielectric Withstand	2200V AC			2500V~			
	Repetitive Peak	200...480V AC: 1400V 200...600V AC: 1600V			200...480V~: 1400V 500V~: 1600V			
	Operating Frequency	50/60 Hz			50/60 Hz			
	Utilization Category	1...37 A	—			AC-53b: 3.5-15:3585		
		43...60 A	—			AC-53b: 4.5-30:1770		
		85 A	—			AC-53b: 4.5-30:3570		
		108 A	—			AC-53b: 4.5-30:1770		
		135 A	—			AC-53b: 3.5-30: 1770		
		201...251 A	—			AC-53b: 3.5-30: 1770		
	317...480 A	—			AC-53b: 3.5-30: 1770			
	Number of Poles	Equipment designed for 3-phase only						
Rated Impulse Voltage	6 kV							
DV/DT Protection	1000V/μs							
Oversoltage Category	III							
Short Circuit Protection	Type 1 ⚡Δ							
	SCPD Performance	Non-Time Delay		Thermal Magnetic Circuit Breaker		High Capacity Time Delay Class CC/J/L		
	SCPD List§	Max. Standard Available Fault	Max. Standard Fuse [A]‡	Max. Standard Available Fault	Max. Circuit Breaker [A]	Max. Standard Available Fault	Max. Fuse [A]	
	Line Device Operational Current Rating [A]	3	5 kA	12	5 kA	15	70 kA	6
		9	5 kA	30	5 kA	30	70 kA	15
		16	5 kA	60	5 kA	60	70 kA	30
		19	5 kA	70	5 kA	70	70 kA	40
		25	5 kA	100	5 kA	100	70 kA	50
		30	10 kA	110	10 kA	110	70 kA	60
		37	10 kA	125	10 kA	125	70 kA	60
		43	10 kA	150	10 kA	150	70 kA	90
		60	10 kA	225	10 kA	225	70 kA	125
		85	10 kA	300	10 kA	300	70 kA	175
		108	10 kA	400	10 kA	300	70 kA	200
135		10 kA	500	10 kA	400	70 kA	250	
201		18 kA	600	18 kA	600	70 kA	350	
251	18 kA	700	18 kA	700	70 kA	400		
317	30 kA	800	30 kA	800	69 kA	500		
361	30 kA	1000	30 kA	1000	69 kA	600		
480	42 kA	1200	42 kA	1200	69 kA	800		
Delta Device Operational Current Rating [A]	5.1	5 kA	15	5 kA	15	70 kA	10	
	16	5 kA	60	5 kA	60	70 kA	30	
	27.6	5 kA	70	5 kA	70	70 kA	60	
	32.8	5 kA	125	5 kA	125	70 kA	70	
	43	5 kA	150	5 kA	150	70 kA	90	
	52	10 kA	200	10 kA	200	70 kA	100	
	64	10 kA	250	10 kA	250	70 kA	100	
	74	10 kA	250	10 kA	250	70 kA	150	
	104	10 kA	400	10 kA	300	70 kA	225	
	147	10 kA	400	10 kA	400	70 kA	300	
	187	10 kA	600	10 kA	500	70 kA	400	
	234	10 kA	700	10 kA	700	70 kA	400	
	348	18 kA	1000	18 kA	1000	70 kA	600	
435	18 kA	1200	18 kA	1200	69 kA	800		
549	30 kA	1600	30 kA	1600	69 kA	1000		
625	30 kA	1600	30 kA	1600	69 kA	1200		
831	42 kA	1600	30 kA	1600	69 kA	1600		
831	42 kA	1600	42 kA	1200	69 kA	1600		

‡ Non-time delay fuses (K5).

§ Consult local codes for proper sizing of short-circuit protection.

⚡ Type 1 performance/protection indicates that, under a short-circuit condition, the fused or circuit breaker-protected starter shall cause no danger to persons or installation but may not be suitable for further service without repair or replacement.

Δ For short-circuit current rating (SCCR) for enclosed panel with external bypass or isolation contactor, see the Industrial Controls catalog website: www.ab.com/catalogs.

Electrical Ratings				
Control Circuit	Rated Operational Voltage (+10%, -15%)		100...240V AC, 24V AC/DC	100...240V~, 24V AC/DC
	Rated Insulation Voltage		250V	250V~
	Rated Impulse Voltage		2.5 kV	4 kV
	Dielectric Withstand		1500V AC	2000V~
	Overvoltage Category		II	III★
	Operating Frequency		50/60 Hz	50/60 Hz
	Input onstate voltage minimum, during start (IN1, IN2)		85V AC, 19.2V DC / 19.2V AC	
	Input onstate current (IN1, IN2)		9.8 mA @120V AC/19.6 mA @ 240V AC, 7.3 mA @ 24V AC/DC	
	Input offstate voltage maximum (IN1, IN2)		40V AC, 17V DC / 12V AC	
	Input offstate current @ input offstate voltage (IN1, IN2)		<10 mA, <12 mA	
	Control Power with Fan, during start	3...37 A	215 mA @ 120V AC / 180 mA @ 240V AC, 800 mA @ 24V DC / 660 mA @ 24V AC	
		43...85 A	200 mA @ 120V AC / 100 mA @ 240V AC, 700 mA @ 24V AC/DC	
			Fan Power	Control Power
		108...135 A	20VA	200 mA @ 120V AC / 120 mA @ 240V AC, 600 mA @ 24V AC/DC
201...251 A		40VA		
317...480 A	60VA			
Control Power without Fan, during start		205 mA @ 120V AC / 145 mA @ 240V AC, 705 mA @ 24V DC / 580 mA @ 24V AC		
Steady State Heat Dissipation and Overload Current Range	Controller Rating [A]	Steady State Heat Dissipation [W]		Overload Current Range [A]
	3	11		1...3
	9	12		3...9
	16	14		5.3...16
	19	15		6.3...19
	25	17		9.2...27.7
	30	19		10...30
	37	24		12.3...37
	43	34		14.3...43
	60	50		20...60
	85	82		28.3...85
	108	62		27...108
	135	75		34...135
	201	129		67...201
	251	147		84...251
317	174		106...317	
361	194		120...361	
480	239		160...480	

Auxiliary Contacts			
Rated Operational Voltage		250V AC/30V DC	250V~/30V DC
Rated Insulation Voltage		250V	250V~
Rated Impulse Voltage		2.5 kV	4 kV
Dielectric Withstand		1500V AC	2000V~
Overvoltage Category		II	III★
Operating Frequency		50/60 Hz	50/60 Hz
Utilization Category		D300/D300	AC-15/DC
TB-97, -98 (OVL/D/Fault)	Type of Control Circuit	Electromagnetic relay	
	Number of Contacts	1	
	Type of Contacts	Normally Open (N.O.)	
	Type of Current	AC/DC	
	Rated Operational Current (max.)	0.6 A @ 120V~ and 0.3 A @ 240V~	
	Conventional Thermal Current I_{th}	1 A	
	Make/Break VA	432/72	
TB-13, -14 Aux 1 (Normal/Up-to-Speed)	Type of Control Circuit	Electromagnetic relay	
	Number of Contacts	1	
	Type of Contacts	Normally Open (N.O.)	
	Type of Current	AC/DC	
	Rated Operational Current (max.)	0.6 A @ 120V~ and 0.3 A @ 240V~	
	Conventional Thermal Current I_{th}	1 A	
	Make/Break VA	432/72	

★ Overvoltage category II, when either control or auxiliary circuit is wired to a SELV or PELV circuit.

Bulletin 150
SMC™-3 Smart Motor Controllers
 Specifications

Electrical Ratings				
Side-Mount Auxiliary Contacts				
		UL/CSA/NEMA	IEC	
Rated Operational Voltage		250V AC/30V DC	250V AC/30V DC	
Rated Insulation Voltage		250V	250V AC	
Rated Impulse Voltage		2.5 kV	4 kV	
Dielectric Withstand		1500V AC	2000V AC	
Overvoltage Category		II	III★	
Operating Frequency		50/60 Hz	50/60 Hz	
TB-23, -24 (Normal/Up-to-Speed) TB-33, -34 (Normal/Up-to-Speed)	Utilization Category	C300/R150	AC-15/DC-13	
	Type of Control Circuit	Electromagnetic relay		
	Number of Contacts	1		
	Type of Contacts	Normally Open (N.O.)		
	Type of Current	AC/DC		
	Rated Operational Current (max.)	1.5 A @ 120V AC, 0.75A @ 240V AC, 1.17 A @ 24V DC		
	Conventional Thermal Current I_{th}	2.5 A		
Make/Break VA		1800/180V AC, 28V DC (resistive)		
TB-11, -12 (Normal/Up-to-Speed)	Type of Control Circuit	B300/R300	AC-15/DC-13	
	Type of Control Circuit	Electromagnetic relay		
	Number of Contacts	1		
	Type of Contacts	Normally Closed (N.C.)		
	Type of Current	AC/DC		
	Rated Operational Current (max.)	3 A @ 120V AC, 1.5A @ 240V AC, 1.17 A @ 24V DC		
	Conventional Thermal Current I_{th}	5 A		
	Make/Break VA		3600/360VA, 28VA (DC resistive)	

★ Overvoltage category II, when either control or auxiliary circuit is wired to a SELV or PELV circuit.

Environmental	
Operating Temperature Range	-5...+50 °C (23...122 °F) (open) -5...+40 °C (23...104 °F) (enclosed)
Storage and Transportation Temperature Range	-25...+85 °C (-13...+185 °F)
Altitude	2000 m (6560 ft)
Humidity	5...95% (non-condensing)
Pollution Degree	2
Type of Protection	IP2X

Mechanical Ratings			
Resistance to Vibration	Operational	1.0 G Peak, 0.15 mm (0.006 in.) displacement	
	Non-Operational	2.5 G Peak, 0.38 mm (0.015 in.) displacement	
Resistance to Shock	Operational	15 G	
	Non-Operational	30 G	
Line Power Terminals	Cable Size Tightening Torque	3...37 A	2.5...25 mm ² (14...4 AWG) 2.3...2.8 N•m (20...25 in•lbs)
		43...85 A	2.5...95 mm ² (14...3/0 AWG) 11.3...12.4 N•m (100...110 in•lbs)
		108...135 A	23 N•m (200 in•lbs)
		201...251 A	Two M10 x 1.5 diameter holes per power pole
		317...480 A	Two M12 x 1.75 diameter holes per power pole
Load Power Terminals	Cable Size Tightening Torque	3...37 A	2.5...16 mm ² (14...6 AWG) 2.3...2.5 N•m (20...22.5 in•lbs)
		43...85 A	2.5...50 mm ² (14...1 AWG) 11.3...12.4 N•m (100...110 in•lbs)
		108...135 A	23 N•m (200 in•lbs)
		201...251 A	Two M10 x 1.5 diameter holes per power pole
		317...480 A	Two M12 x 1.75 diameter holes per power pole
Control Terminals	Cable Size Tightening Torque	All	0.2...2.5 mm ² (24...14 AWG) 0.5...0.9 N•m (4.4...8.0 in•lbs)

Other			
		UL/CSA/NEMA	IEC
EMC Emission Levels	Conducted Radio Frequency Emissions	—	Class A
	Radiated Emissions	—	Class A
EMC Immunity Levels	Electrostatic Discharge	4 kV Contact and 8 kV Air Discharge	8 kV Air Discharge
	Radio Frequency Electromagnetic Field	—	Per EN/IEC 60947-4-2
	Fast Transient	—	Per EN/IEC 60947-4-2
	Surge Transient	—	Per EN/IEC 60947-4-2

SMC-3 Overload Trip Curves

Trip Class 10

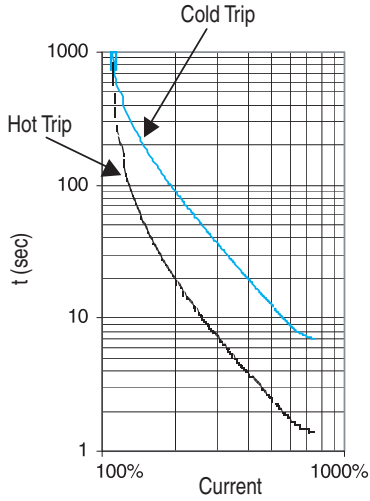

Trip Class 15

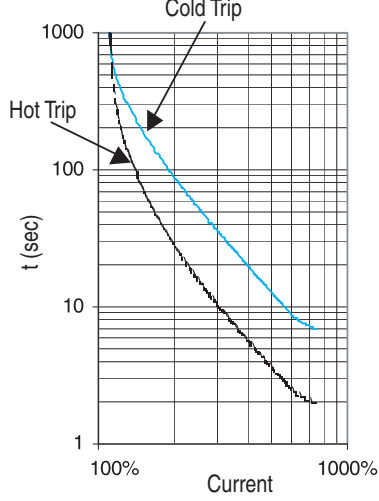

Trip Class 20

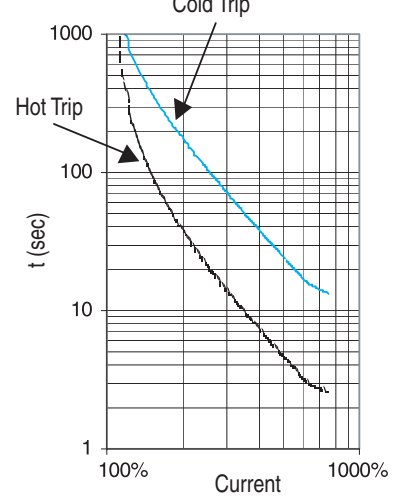

Starts per Hour Curves

SMC-3 Starts per hour (3...37 A)
 40 °C, 100% Duty Cycle, 10 s, 350% No Fan

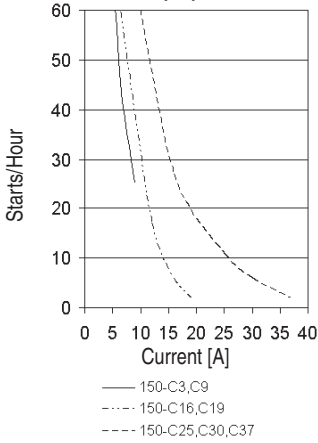

SMC-3 Starts per hour (3...37 A)
 40 °C, 100% Duty Cycle, 10 s, 350% with Fan

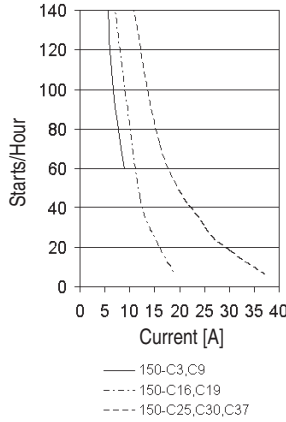

SMC-3 Starts per hour (43...85 A)
 40C, 100% Duty Cycle, 20 sec, 350% (with standard fan)

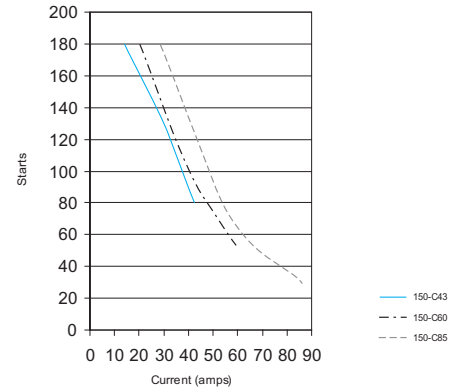

SMC-3 Starts per hour (108...135 A)
 40C, 100% Duty Cycle, 20 sec, 350% (with standard fan)

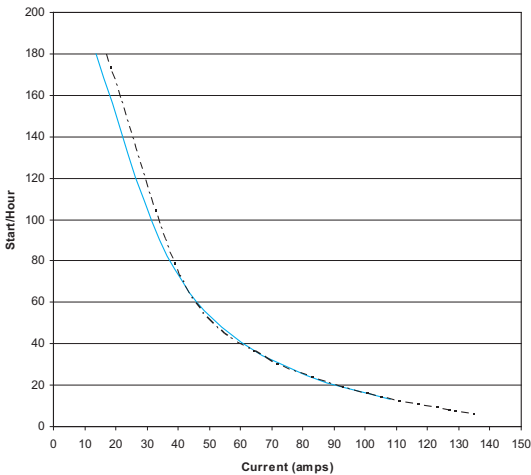

SMC-3 Starts per hour (201...480 A)
 40C, 100% Duty Cycle, 20 sec, 350% (with standard fan)

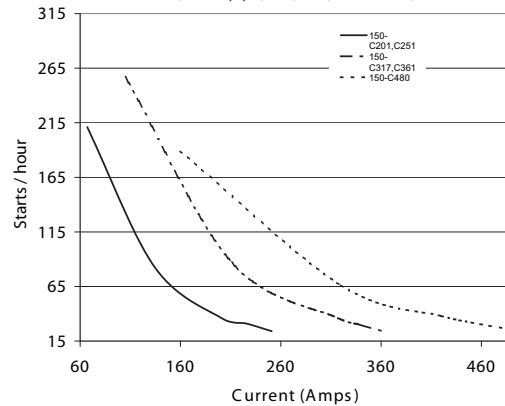

Bulletin 150
SMC™-3 Smart Motor Controllers
 Approximate Dimensions

Dimensions in millimeters (inches). Dimensions are not intended to be used for manufacturing purposes. All dimensions are subject to change.

Open Type

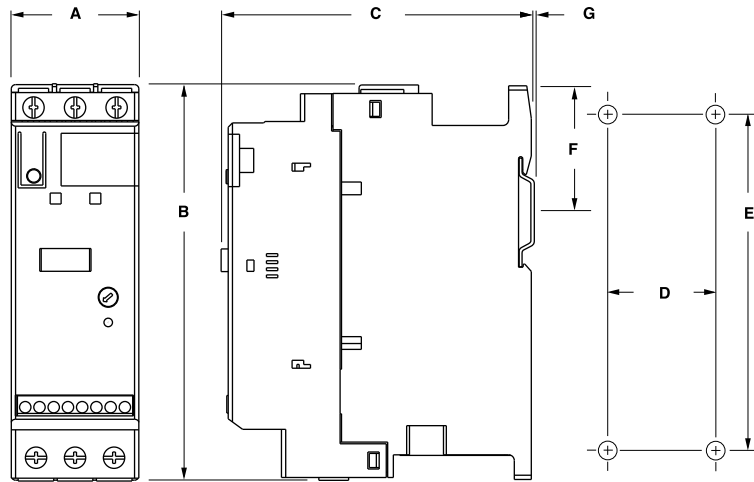

Controller Rating [A]	A	B	C	D	E	F	G	Mounting Hole Size	Weight kg (lbs)
1...37	44.8 (1-49/64)	139.7 (5-1/2)	100 (4-21/64)	35 (1-3/8)	132 (5-13/64)	46.4 (1.81)	2 (1/16)	4.6 (0.18)	0.86 (1.9)
43...85	72 (2.83)	206 (8.11)	130 (5.12)	55 (2.17)	198 (7.8)	102 (4.02)	2 (1/16)	5.3 (0.21)	2.25 (5.0)
108...135	196.4 (7.74)	443.7 (17.47)	205.2 (8.08)	166.6 (6.56)	367 (14.45)	—	—	7.5 (0.295)	15 (33)
201...251	225 (8.86)	560 (22.05)	265.3 (10.45)	150 (5.91)	504.1 (19.85)	—	—	11.5 (0.45)	30.4 (67)
317...480	290 (11.42)	600 (23.62)	298 (11.73)	200 (7.87)	539.2 (21.23)	—	—	11.5 (0.45)	45.8 (101)

Minimum Enclosure Size

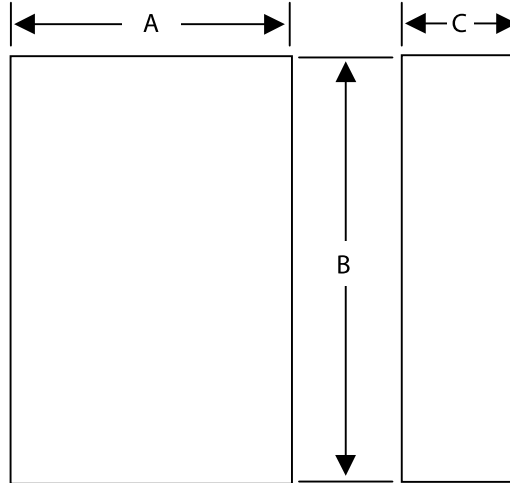

Controller Rating [A]	B Height	A Width	C Depth	Fan Requirements
1...37 A	305 (12)	224 (9)	152 (6)	none
43...85 A	406 (16)	305 (12)	203 (8)	none
108...135 A	762 (30)	610 (24)	305 (12)	none
201...251 A	965 (38)	762 (30)	356 (14)	none
317...480 A	1295 (51)	914 (36)	356 (14)	none

Enclosed Type Line-Connected Controllers

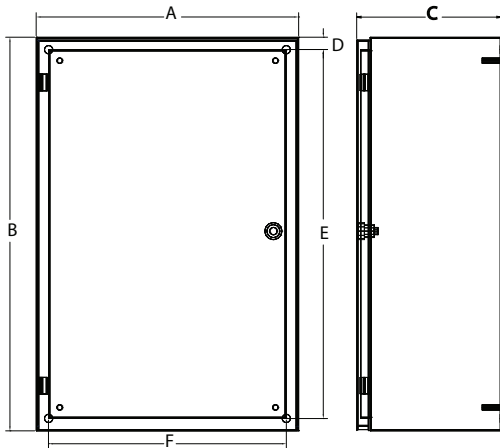

Figure 1 — Wall-Mount

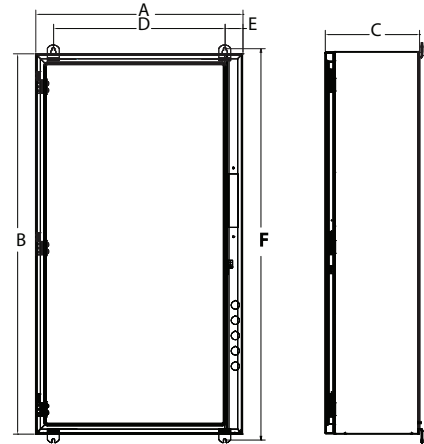

Figure 2 — Wall-Mount

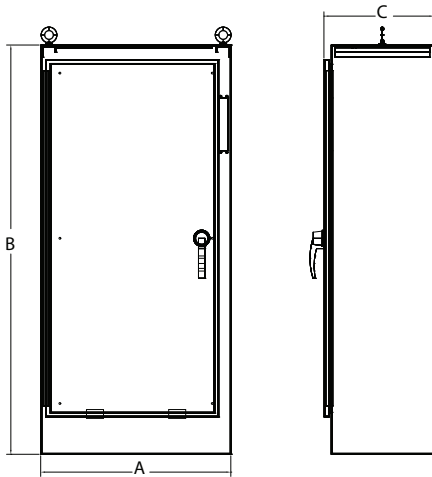

Figure 3 — Floor-Mount

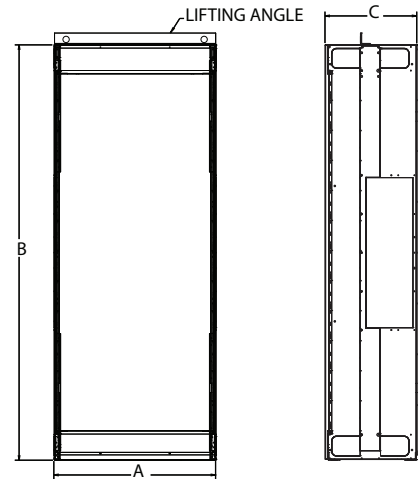

Figure 4 — Floor-Mount

Controller Rating [A]	Bulletin	With Option	Dimension Figure No.	Dimensions in inches (mm)					
				A (Width)	B (Height)	C (Depth)	D (Mtg. Dim.)	E (Mtg. Dim.)	F (Mtg. Dim.)
SMC-3 Non-Combination Controller									
3...37	150	—	1	8 (203)	12 (305)	6 (152)	2.44 (62)	10.43 (265)	3.0 (76)
		6P		12 (305)	12 (305)	6 (152)	2.41 (61)	10.43 (265)	7.0 (178)
43...85	150	—	1	8 (203)	14 (356)	8 (203)	2.44 (62)	12.40 (315)	3.0 (76)
		6P		16 (406)	14 (356)	8 (203)	4.38 (111)	12.40 (315)	7.0 (178)
108...135	150	Any	1	24 (610)	30 (762)	12 (305)	0.75 (19)	28.5 (724)	22.5 (572)
201...251	150	—	1	30 (762)	38 (965)	14 (356)	0.75 (19)	36.5 (927)	28.5 (724)
	150, 150B	BP,NB,NI,6P		36 (914)	51 (1295)	14 (356)	0.75 (19)	49.5 (1257)	34.5 (876)
317...361	150	Any	1	36 (914)	51 (1295)	14 (356)	0.75 (19)	49.5 (1257)	34.5 (876)
		—		36 (914)	51 (1295)	14 (356)	0.75 (19)	49.5 (1257)	34.5 (876)
	150B	NI, 6P		36 (914)	51 (1295)	14 (356)	0.75 (19)	49.5 (1257)	34.5 (876)
		BP,NI, 6P		36 (914)	60 (1524)	14 (356)	0.75 (19)	58.5 (1486)	34.5 (876)
480	150	—	1	36 (914)	51 (1295)	14 (356)	0.75 (19)	49.5 (1257)	34.5 (876)
	150, 150B	BP,NB,NI,6P		36 (914)	60 (1524)	14 (356)	0.75 (19)	58.5 (1486)	34.5 (876)

Bulletin 150
SMC™-3 Smart Motor Controllers
 Approximate Dimensions

Controller Rating [A]	Bulletin	With Option	Dimension Figure No.	Dimensions in inches (mm)					
				A (Width)	B (Height)	C (Depth)	D (Mtg. Dim.)	E (Mtg. Dim.)	F (Mtg. Dim.)
SMC-3 Combination Controller									
3...37	152H,153H	Any	1	16 (406)	14 (356)	8 (203)	4.38 (111)	12.40 (315)	7.0 (178)
43	152H	Any	1	16 (406)	14 (356)	8 (203)	4.38 (111)	12.40 (315)	7.0 (178)
	153H	Any	1	16 (406)	24 (610)	10 (254)	0.75 (19)	22.5 (572)	14.5 (368)
60	152H, 153H	Any	1	16 (406)	24 (610)	9 (229)	0.75 (19)	22.5 (572)	14.5 (368)
	152H	Any	1	24 (610)	30 (762)	12 (305)	0.75 (19)	28.5 (724)	22.5 (572)
85	152H	Any	1★	16 (406)	24 (610)	9 (229)	0.75 (19)	22.5 (572)	14.5 (368)
		Any	1‡	24 (610)	30 (762)	12 (305)	0.75 (19)	28.5 (724)	22.5 (572)
	153H	Any	1	16 (406)	24 (610)	9 (229)	0.75 (19)	22.5 (572)	14.5 (368)
108	152H,153H	Any	1	30 (762)	38 (965)	14 (356)	0.75 (19)	36.5 (927)	28.5 (724)
135	152H,153H	Any	1	30 (762)	38 (965)	14 (356)	0.75 (19)	36.5 (927)	28.5 (724)
201	152H,153H	—	1	30 (762)	38 (965)	14 (356)	0.75 (19)	36.5 (927)	28.5 (724)
	152H,152B,153H,153B	Any	1	36 (914)	51 (1295)	14 (356)	0.75 (19)	49.5 (1257)	34.5 (876)
251	152H,153H	—	1	30 (762)	38 (965)	14 (356)	0.75 (19)	36.5 (927)	28.5 (724)
	152H,152B,153H,153B	Any	1	36 (914)	51 (1295)	14 (356)	0.75 (19)	49.5 (1257)	34.5 (876)
317	153H	—	1	36 (914)	51 (1295)	14 (356)	0.75 (19)	49.5 (1257)	34.5 (876)
		BP,NB	1	36 (914)	60 (1524)	14 (356)	0.75 (19)	58.5 (1486)	34.5 (876)
	153B	—	1	36 (914)	60 (1524)	14 (356)	0.75 (19)	58.5 (1486)	34.5 (876)
	152H,152B	—	2	38 (965)	60 (1524)	17 (431)	33.88 (861)	1.75 (45)	61.69 (1567)
	152H	BP	2	38 (965)	60 (1524)	17 (431)	33.88 (861)	1.75 (45)	61.69 (1567)
	152H,152B,153H,153B	NB,NI	3	40 (1016)	84 (2134)	18 (457)	—	—	—
361	153H	—	1	36 (914)	51 (1295)	14 (356)	0.75 (19)	49.5 (1257)	34.5 (876)
		BP,NB	1	36 (914)	60 (1524)	14 (356)	0.75 (19)	58.5 (1486)	34.5 (876)
	153B	—	1	36 (914)	60 (1524)	14 (356)	0.75 (19)	58.5 (1486)	34.5 (876)
	152H,152B	—	2	38 (965)	60 (1524)	17 (431)	33.88 (861)	1.75 (45)	61.69 (1567)
	152H	BP	2	38 (965)	60 (1524)	17 (431)	33.88 (861)	1.75 (45)	61.69 (1567)
	152H,152B,153H,153B	NB,NI	3	40 (1016)	84 (2134)	18 (457)	—	—	—
480	153H	—	1	36 (914)	51 (1295)	14 (356)	0.75 (19)	49.5 (1257)	34.5 (876)
		BP	3♣	40 (1016)	84 (2134)	18 (457)	—	—	—
	152H,153B	Any	3	40 (1016)	84 (2134)	18 (457)	—	—	—
	152H	—	4♣	20 (508)	91.5 (2324)	20 (508)	—	—	—
	152H,152B	BP,NB	4♣	35 (889)	91.5 (2324)	20 (508)	—	—	—

★ Rating 20 Hp @208V, 25 Hp @240V, 50 Hp @ 480V, 60 Hp @ 600V

‡ Rating 25 Hp @208V, 30 Hp @240V, 60 Hp @ 480V, 75 Hp @ 600V

♣ 200 Hp @ 240V AC, 400 Hp @480V, 500 Hp @ 600V

SMC, Allen-Bradley, Rockwell Software, Rockwell Automation, and LISTEN. THINK. SOLVE are trademarks of Rockwell Automation, Inc. Trademarks not belonging to Rockwell Automation are property of their respective companies.

www.rockwellautomation.com

Power, Control and Information Solutions Headquarters

Americas: Rockwell Automation, 1201 South Second Street, Milwaukee, WI 53204-2496 USA, Tel: (1) 414.382.2000, Fax: (1) 414.382.4444

Europe/Middle East/Africa: Rockwell Automation NV, Pegasus Park, De Kleetlaan 12a, 1831 Diegem, Belgium, Tel: (32) 2 663 0600, Fax: (32) 2 663 0640

Asia Pacific: Rockwell Automation, Level 14, Core F, Cyberport 3, 100 Cyberport Road, Hong Kong, Tel: (852) 2887 4788, Fax: (852) 2508 1846