



# IEC Contactor Specifications

Bulletin Numbers 100/104-K, 100/104-C, 100/104S-C, 100/104-E, 100S-E




| Topic   | Page |
|---|------|
| Summary of Changes                                | 2    |
| Product Line Overview                             | 3    |
| IEC Contactors                                    | 3    |
| Safety Contactors                                 | 4    |
| 100-K/104-K Miniature Contactors                  | 5    |
| Product Selection                                 | 5    |
| Accessories                                       | 8    |
| Specifications                                    | 11   |
| Life-Load Curves                                  | 15   |
| Approximate Dimensions                            | 16   |
| 100-C/104-C, 100S-C/104S-C Contactors             | 17   |
| Product Selection—100-C/104-C Contactors          | 17   |
| Product Selection—100S-C/104S-C Safety Contactors | 23   |
| Accessories                                       | 31   |
| Renewal Parts                                     | 36   |
| Specifications                                    | 38   |
| Life-Load Curves                                  | 49   |
| Approximate Dimensions                            | 56   |
| 100-E/104-E, 100S-E/104S-E Contactors             | 58   |
| Product Selection—100-E/104-E Contactors          | 58   |
| Product Selection—100S-E Safety Contactors        | 61   |
| Assignment of Contacts                            | 65   |
| Renewal Parts                                     | 76   |
| Specifications                                    | 78   |
| Life-Load Curves                                  | 98   |
| Approximate Dimensions                            | 105  |
| Additional Resources                              | 121  |

## Summary of Changes



This publication contains the following new or updated information. This list includes substantive updates only and is not intended to reflect all changes.

| <b>Topic</b>   | <b>Page</b> |
|--|-------------|
| Added tables for Device Combinations in Accordance with IEC 60947-1 / -4-1, update tables and add new figures for safety and safety reversing contactors | Throughout  |

## IEC Contactors

|                          |    |   |    |
|--------------------------|---|--|---|
| Bulletin No.             | 100-K/104-K   | 100-C/104-C  | 100-E/104-E   |
| Screw Terminals          | ✓   | ✓  | ✓ (9...96 A), Thru-hole (116...2650 A)  |
| Spring Terminals         | ✓ (5...9 A)   | ✓ (9...16 A)   | –   |
| Max. Current $I_e$       | 12 A  | 97 A   | 2650 A  |
| Current Rating           | 5...12 A  | 9...97 A   | 9...2650 A  |
| Features                 | <ul style="list-style-type: none"> <li>• Mini contactors</li> <li>• Uniform panel mounting dimensions</li> <li>• Panel mounting or mounting on 35 mm DIN Rail</li> <li>• AC or DC coil control</li> <li>• Made of environmentally friendly materials</li> </ul> | <ul style="list-style-type: none"> <li>• Panel mounting or mounting on 35 mm DIN Rail</li> <li>• AC or DC coil control</li> <li>• Reversible coil terminals (line or load side)</li> <li>• Common accessories</li> <li>• Made of environmentally friendly materials</li> </ul> | <ul style="list-style-type: none"> <li>• Panel mounting or mounting on 35 mm DIN Rail</li> <li>• <b>E09...E370</b> <ul style="list-style-type: none"> <li>– AC/DC electronic coil with built-in surge suppression</li> <li>– optional PLC interface on E116...E370</li> </ul> </li> <li>• <b>E400...E2650</b> <ul style="list-style-type: none"> <li>– AC/DC electronic coil with built-in surge suppression and PLC interface</li> </ul> </li> <li>• Made of environmentally friendly materials</li> </ul> |
| Contacts                 | <ul style="list-style-type: none"> <li>• 3 power poles with internal N.O. or N.C. auxiliary contact, or 4 power poles.</li> <li>• Optional front-mounted 2- or 4-pole external auxiliary contact block.</li> </ul>  | <ul style="list-style-type: none"> <li>• 3 power poles with internal N.O. or N.C. auxiliary contact or 4 power poles (9...23 A).</li> <li>• Optional front- or side-mounted 1-, 2- or 4-pole external auxiliary contact block.</li> </ul>                                      | <ul style="list-style-type: none"> <li>• 3 main poles with 2 auxiliary contacts (1 N.O. and 1 N.C.) on E116...E2650</li> <li>• Optional side- or front-mounted external auxiliary contact block.</li> </ul>   |
| Coil Voltages            | 24...600V AC, 50/60Hz<br>12...250V DC   | 12...480V AC, 50/60Hz<br>9...250V DC   | 20...500V, 50/60 Hz/DC  |
| Optional Overload Relays | Electronic or bimetallic  | Electronic or bimetallic   | Electronic  |
| Optional Accessories     | <ul style="list-style-type: none"> <li>• Front-mount auxiliary contacts</li> <li>• Surge suppressors</li> <li>• Electronic timers</li> <li>• Mechanical interlocks</li> </ul>   | <ul style="list-style-type: none"> <li>• Front or side-mount auxiliary contacts</li> <li>• Surge suppressors</li> <li>• Electronic or pneumatic timers</li> <li>• Mechanical interlocks</li> <li>• Mechanical latches</li> </ul>   | <ul style="list-style-type: none"> <li>• Side- or front-mount auxiliary contacts</li> <li>• Mechanical interlocks</li> <li>• Terminal lugs</li> <li>• Terminal shields</li> <li>• Connecting bars</li> <li>• Electronic timers (9...96 A)</li> <li>• Mechanical latches (9...96 A)</li> </ul>   |
| Standards/Certifications | <ul style="list-style-type: none"> <li>• UL</li> <li>• CSA</li> <li>• IEC</li> <li>• CE Marked</li> <li>• CCC</li> </ul>  | <ul style="list-style-type: none"> <li>• UL</li> <li>• CSA</li> <li>• IEC</li> <li>• CE Marked</li> <li>• CCC</li> </ul>   | <ul style="list-style-type: none"> <li>• EN/IEC</li> <li>• CE Marked</li> <li>• cULus</li> <li>• CCC</li> <li>• EAC</li> <li>• C-tick</li> <li>• KC</li> </ul>  |

# Safety Contactors

|                          |    |   |
|--------------------------|---|--|
| <b>Bulletin No.</b>      | <b>100S-C/104S-C</b>  | <b>100S-E/104S-E</b>   |
| Screw Terminals          | 3   | Thru-hole  |
| Max. Current $I_e$       | 97 A  | 750 A  |
| Current Rating           | 9...97 A  | 9...750 A  |
| Features                 | <ul style="list-style-type: none"> <li>• Positively guided/mechanically linked auxiliary contacts</li> <li>• Front-mounted auxiliary contacts:                             <ul style="list-style-type: none"> <li>- Permanently fixed</li> <li>- Protective cover to prevent manual operation</li> <li>- Red contact housing for easy identification</li> <li>- Incorporates IEC 947-5-1 "Mechanically Linked" symbol</li> <li>- Optional gold-plated bifurcated versions</li> </ul> </li> <li>• AC and DC operating coils</li> <li>• SUVA third-party certification</li> </ul> | <ul style="list-style-type: none"> <li>• Mirror contact performance on auxiliary contacts</li> <li>• Red N.C. low-power auxiliary contacts used for feedback circuit</li> <li>• SUVA third-party certification</li> <li>• AC/ DC operating coils with built-in surge suppression</li> <li>• "Mirror Contact" symbol on front</li> </ul>  |
| Contacts                 | 3 main poles with N.C. mechanically linked or mirror feedback contacts  | 3 main poles with N.C. mirror feedback contacts  |
| Coil Voltages            | 12...480V AC, 50/60Hz<br>12...250V DC   | 20...500V, 50/60 Hz/DC   |
| Optional Overload Relays | Electronic or bimetallic  | Electronic   |
| Optional Accessories     | <ul style="list-style-type: none"> <li>• Side-mount auxiliary contacts</li> <li>• Surge suppressors</li> <li>• Electronic timers</li> <li>• Mechanical interlocks</li> </ul>  | <ul style="list-style-type: none"> <li>• Side-mount auxiliary contacts</li> <li>• Electronic timers (9...96 A)</li> <li>• Mechanical interlocks (9...96 A)</li> <li>• Terminal shields</li> <li>• Terminal lugs</li> <li>• Terminal enlargements</li> <li>• Terminal extensions</li> <li>• Connection bars for 140G molded case circuit breakers, 140MG motor protection circuit breakers, and 140MG motor circuit protectors</li> </ul> |
| Standards Compliance     | <ul style="list-style-type: none"> <li>• EN/IEC 60947-4</li> <li>• IEC 60947-5-1, Annex L – Mechanically Linked Contacts</li> <li>• IEC 60947-4-1, Annex F – Mirror Contacts</li> <li>• UL 508</li> <li>• CSA C22.2 No. 14</li> <li>• EN50205</li> </ul>  | <ul style="list-style-type: none"> <li>• EN/IEC 60947-4-1</li> <li>• IEC 60947-5-1, Annex L – Mechanically Linked Contacts</li> <li>• IEC 60947-4-1, Annex F – Mirror Contacts</li> <li>• UL 60947-4-1</li> <li>• CSA C22.2, No. 60947-4-1</li> </ul>  |
| Certifications           | <ul style="list-style-type: none"> <li>• cULus Listed (File No. E3125; Guide NLDX, NLDX7)</li> <li>• SUVA Third-Party Certified</li> <li>• CE Marked</li> </ul>   | <ul style="list-style-type: none"> <li>• cULus Listed (File No. E41850; Guide No. NLDX, NLDX7)</li> <li>• CE Marked</li> <li>• CCC</li> <li>• UL</li> <li>• CSA</li> <li>• EAC</li> <li>• RCM (C-tick)</li> <li>• SUVA Third-Party Certified</li> <li>• KC</li> </ul>  |



## Product Selection

- 3-Pole AC- and DC-operated contactors
- Compact size
- Same dimensions for AC and DC
- Full-voltage non-reversing and reversing contactors
- 5, 9, and 12 A contactors rated at 690V
- IP2X finger protection
- Optional integrated surge suppressor
- Compatible with Bulletin 193-K bimetallic overload relay
- Mirror contacts per IEC 60947-4-1 and mechanically linked contacts per IEC 60947-5-1 on main unit



100-K Miniature Contactor



104-K Reversing Miniature Contactor

Bulletin 100-K miniature contactors are designed for commercial and light industrial applications where panel space is at a premium. These miniature devices, while 45 mm wide, are shallower and have less panel depth requirements than standard IEC contactors.

The miniature contactors have been designed with flexibility in mind. They are available with AC or DC operating coils, several contact ratings, and optional 2- or 4-pole adder decks in a variety of auxiliary contact configurations.

### 3-Pole AC- and DC-operated Contactors

| Rated Operational Current<br>$I_e$ [A] |      | Ratings for switching AC motors - AC-2, AC-3, AC-4 |          |      |      |            |       |         |       |       |       | Auxiliary Contacts |      | Pkg. Qty. <sup>(1)</sup> | Cat. No.    |
|--|------|--|----------|------|------|------------|-------|---------|-------|-------|-------|--------------------|------|--------------------------|-------------|
|  |      | 3-phase kW (50 Hz)                                 |          |      |      | Hp (60 Hz) |       |         |       |       |       | N.O.               | N.C. |                          |             |
|  |      | 230V   | 400/415V | 500V | 690V | 1-Phase    |       | 3-Phase |       |       |       |                    |      |                          |             |
| 115V                                   | 230V |  |          |      |      | 200V       | 230V  | 460V    | 575V  |       |       |                    |      |                          |             |
| 40 °C (104 °F)                         |      | AC-3   |          | AC-1 |      |            |       |         |       |       |       |                    |      |                          |             |
| <b>Screw Terminals</b>                 |      |  |          |      |      |            |       |         |       |       |       |                    |      |                          |             |
| 5                                      | 20   | 1.5  | 2.2      | 2.2  | 2.2  | 1/2        | 1     | 1-1/2   | 1-1/2 | 3     | 3     | 1                  | 0    | 1                        | 100-K05⊗10  |
|  |      |  |          |      |      |            |       |         |       |       |       | 0                  | 1    |                          |             |
| 9                                      | 20   | 3  | 4        | 4    | 4    | 1/2        | 1-1/2 | 2       | 2     | 5     | 5     | 1                  | 0    | 1                        | 100-K09⊗10  |
|  |      |  |          |      |      |            |       |         |       |       |       | 0                  | 1    |                          |             |
| 12                                     | 20   | 3  | 5.5      | 5.5  | 5.5  | 3/4        | 2     | 3       | 3     | 7-1/2 | 7-1/2 | 1                  | 0    | 1                        | 100-K12⊗10  |
|  |      |  |          |      |      |            |       |         |       |       |       | 0                  | 1    |                          |             |
| <b>Spring Clamp Terminals</b>          |      |  |          |      |      |            |       |         |       |       |       |                    |      |                          |             |
| 5                                      | 10   | 1.5  | 2.2      | 2.2  | 2.2  | 1/3        | 3/4   | 1-1/2   | 1-1/2 | 3     | 3     | 1                  | 0    | 1                        | 100-KR05⊗10 |
|  |      |  |          |      |      |            |       |         |       |       |       | 0                  | 1    |                          |             |
| 9                                      | 10   | 2.2  | 4        | 4    | 4    | 1/3        | 1     | 2       | 2     | 5     | 5     | 1                  | 0    | 1                        | 100-KR09⊗10 |
|  |      |  |          |      |      |            |       |         |       |       |       | 0                  | 1    |                          |             |

(1) May be ordered in package quantities of 20. Add letter M to the end of the cat. no. Example: **100-K09ZJ10M**.

⊗ Coil voltage code — see [page 6](#).

### 4-Pole AC- and DC-operated Contactors

| Rated Operational Current $I_e$ [A] |      | Ratings for switching AC motors - AC-2, AC-3 |      |      |          |            |       |         |       |         |       | Contact Configuration, Main Poles |      | Pkg. Qty. <sup>(1)</sup> | Cat. No.    |
|-------------------------------------|------|--|------|------|----------|------------|-------|---------|-------|---------|-------|-----------------------------------|------|--------------------------|-------------|
|                                     |      | 3-phase kW (50 Hz)                           |      |      |          | Hp (60 Hz) |       |         |       |         |       | N.O.                              | N.C. |                          |             |
|                                     |      | 40 °C (104 °F)                               |      | 230V | 400/415V | 500V       | 690V  | 1-Phase |       | 3-Phase |       |                                   |      |                          |             |
| AC-3                                | AC-1 | 115V   | 230V |      |          |            |       | 200V    | 230V  | 460V    | 575V  |                                   |      |                          |             |
| 5                                   | 20   | 1.5  | 2.2  | 2.2  | 2.2      | 1/2        | 1     | 1-1/2   | 1-1/2 | 3       | 3     | 4                                 | 0    | 1                        | 100-K05⊗400 |
|                                     |      |  |      |      |          |            |       |         |       |         |       | 3                                 | 1    | 1                        | 100-K05⊗300 |
|                                     |      |  |      |      |          |            |       |         |       |         |       | 2                                 | 2    | 1                        | 100-K05⊗200 |
| 9                                   | 20   | 3  | 4    | 4    | 4        | 1/2        | 1-1/2 | 2       | 2     | 5       | 5     | 4                                 | 0    | 1                        | 100-K09⊗400 |
|                                     |      |  |      |      |          |            |       |         |       |         |       | 3                                 | 1    | 1                        | 100-K09⊗300 |
|                                     |      |  |      |      |          |            |       |         |       |         |       | 2                                 | 2    | 1                        | 100-K09⊗200 |
| 12                                  | 20   | 3  | 5.5  | 5.5  | 5.5      | 3/4        | 2     | 3       | 3     | 7-1/2   | 7-1/2 | 4                                 | 0    | 1                        | 100-K12⊗400 |
|                                     |      |  |      |      |          |            |       |         |       |         |       | 3                                 | 1    | 1                        | 100-K12⊗300 |
|                                     |      |  |      |      |          |            |       |         |       |         |       | 2                                 | 2    | 1                        | 100-K12⊗200 |

(1) May be ordered in package quantities of 20. Add letter M to the end of the cat. no. Example: 100-K09ZJ400M.

### Reversing AC- and DC-operated Contactors

| Rated Operational Current $I_e$ [A] |      | Ratings for switching AC motors - AC-2, AC-3, AC-4 |      |      |          |            |      |         |       |         |       | Auxiliary Contacts per Contactor <sup>(1)</sup> |      | Cat. No. <sup>(2)</sup> |
|-------------------------------------|------|--|------|------|----------|------------|------|---------|-------|---------|-------|---|------|-------------------------|
|                                     |      | 3-phase kW (50 Hz)                                 |      |      |          | Hp (60 Hz) |      |         |       |         |       | N.O.  | N.C. |                         |
|                                     |      | 40 °C (104 °F)                                     |      | 230V | 400/415V | 500V       | 690V | 1-Phase |       | 3-Phase |       |   |      |                         |
| AC-3                                | AC-1 | 115V   | 230V |      |          |            |      | 200V    | 230V  | 460V    | 575V  |   |      |                         |
| 5                                   | 20   | 1.5  | 2.2  | 2.2  | 2.2      | —          | —    | 1-1/2   | 1-1/2 | 3       | 3     | 0   | 1    | 104-K05⊗02              |
| 9                                   | 20   | 3  | 4    | 4    | 4        | —          | —    | 2       | 2     | 5       | 5     | 0   | 1    | 104-K09⊗02              |
| 12                                  | 20   | 3  | 5.5  | 5.5  | 5.5      | —          | —    | 3       | 3     | 7-1/2   | 7-1/2 | 0   | 1    | 104-K12⊗02              |

(1) Used for electrical interlocking.

(2) Bulletin 104-K reversing contactors are factory assembled and include contactors, mechanical interlock (Cat. No. 100-KMCH) and wiring kit (Cat. No. 100-KPR) for power and control circuit (electrical interlock).

### Coil Voltage Codes

The Cat. No. as listed is incomplete. Select a coil voltage code from the table below to complete the Cat. No.  
 Example: 120V, 60 Hz: Cat. No. 100-K09⊗10 becomes Cat. No.100-K09D10.

#### Screw type terminal versions

| AC Voltages [V] | 24 | 110 | 120 | 230 | 240 | 400 | 480 | 600 | DC Voltages [V]       | 12 | 24 | 110 | 125 | 220 | 250 |
|-----------------|----|-----|-----|-----|-----|-----|-----|-----|-----------------------|----|----|-----|-----|-----|-----|
| 50 Hz           | —  | D   | —   | —   | —   | —   | —   | —   | Standard              | ZQ | ZJ | ZD  | ZS  | ZA  | ZT  |
| 60 Hz           | —  | —   | D   | —   | —   | —   | B   | VC  | with Integrated Diode | —  | DJ | —   | —   | —   | —   |
| 50/60 Hz        | KJ | —   | —   | KF  | KA  | KN  | —   | —   |                       |    |    |     |     |     |     |

#### Spring clamp type terminal versions

| AC Voltages [V] | 24 | 110 | 120 | 230 | DC Voltages [V]       | 24 | 110 |
|-----------------|----|-----|-----|-----|-----------------------|----|-----|
| 50 Hz           | —  | D   | —   | —   | Standard              | ZJ | ZD  |
| 60 Hz           | —  | —   | D   | —   | with Integrated Diode | DJ | —   |
| 50/60 Hz        | KJ | —   | —   | KF  |                       |    |     |

# Assignment of Contacts

Table valid for: AC / DC = 0.85...1.1 x U<sub>s</sub>, T<sub>amb</sub> = -25 °C...+60 °C (-13...140 °F), normal position (horizontal rail mounting)

## Device Combinations in Accordance with IEC 60947-1 / -4-1

| Auxiliary Contact Blocks <sup>(1)</sup> |         | 100-K Miniature Contactors (AC and DC Control) |  |   |   |   |              |
|---|---------|--|--|---|---|---|--------------|
| Circuit Diagram                         | Control | 100-K05⊗10<br>100-K09⊗10<br>100-K12⊗10         | 100-K05⊗01<br>100-K09⊗01<br>100-K12⊗01 | 100-K05⊗400<br>100-K09⊗400<br>100-K12⊗400 | 100-K05⊗300<br>100-K09⊗300<br>100-K12⊗300 | 100-K05⊗200<br>100-K09⊗200<br>100-K12⊗200 |              |
|   |         |  |  |   |   |   |              |
| 100-KFA02E                              |         | AC/DC  | (2)                                    | 01 + 02 = 03 <sup>(3)</sup>               | (2)                                       | (2)(3)                                    | —            |
| 100-KFC02                               |         | AC/DC  | 10 + 02 = 12                           | —   | 00 + 02 = 02                              | 00 + 02 = 02 <sup>(3)</sup>               | —            |
| 100-KFA11E                              |         | AC/DC  | (2)                                    | 01 + 11 = 12                              | (2)                                       | (2)                                       | (2)          |
| 100-KFB11                               |         | AC/DC  | 10 + 11 = 21                           | —   | 00 + 11 = 11                              | 00 + 11 = 11                              | 00 + 11 = 11 |
| 100-KFC11                               |         | AC/DC  | 10 + 11 = 21                           | (2)                                       | 00 + 11 = 11                              | 00 + 11 = 11                              | 00 + 11 = 11 |
| 100-KFA20E                              |         | AC/DC  | (2)                                    | 01 + 20 = 21                              | (2)                                       | (2)                                       | (2)          |
| 100-KFC20                               |         | AC/DC  | 10 + 20 = 30                           | (2)                                       | 00 + 20 = 20                              | 00 + 20 = 20                              | 00 + 20 = 20 |
| 100-KFA04E                              |         | AC/DC  | (2)(3)                                 | —   | (2)(3)                                    | —   | —            |
| 100-KFC04                               |         | AC/DC  | 10 + 04 = 14 <sup>(3)</sup>            | —   | 00 + 04 = 04 <sup>(3)</sup>               | —   | —            |
| 100-KFA13E                              |         | AC/DC  | (2)                                    | 01 + 13 = 14 <sup>(3)</sup>               | (2)                                       | (2)(3)                                    | —            |
| 100-KFC13                               |         | AC/DC  | 10 + 13 = 23                           | (2)(3)                                    | 00 + 13 = 13                              | 00 + 13 = 13 <sup>(3)</sup>               | —            |
| 100-KFA22Z                              |         | AC/DC  | (2)                                    | 01 + 22 = 23 <sup>(3)</sup>               | (2)                                       | (2)(3)                                    | —            |
| 100-KFB22                               |         | AC/DC  | 10 + 22 = 32                           | —   | 00 + 22 = 22                              | 00 + 22 = 22 <sup>(3)</sup>               | —            |
| 100-KFC22                               |         | AC/DC  | 10 + 22 = 32                           | (2)(3)                                    | 00 + 22 = 22                              | 00 + 22 = 22 <sup>(3)</sup>               | —            |
| 100-KFA31Z                              |         | AC/DC  | (2)                                    | —   | (2)(4)                                    | —   | —            |

Device Combinations in Accordance with IEC 60947-1 / -4-1 (Continued)

| Auxiliary Contact Blocks <sup>(1)</sup> |         | 100-K Miniature Contactors (AC and DC Control) |  |   |   |   |  |
|---|---------|--|--|---|---|---|--|
| Circuit Diagram                         | Control | 100-K05⊗10<br>100-K09⊗10<br>100-K12⊗10         | 100-K05⊗01<br>100-K09⊗01<br>100-K12⊗01 | 100-K05⊗400<br>100-K09⊗400<br>100-K12⊗400 | 100-K05⊗300<br>100-K09⊗300<br>100-K12⊗300 | 100-K05⊗200<br>100-K09⊗200<br>100-K12⊗200 |  |
|   |         |  |  |   |   |   |  |
| 100-KFC31                               | AC/DC   | 10 + 31 = 41 <sup>(4)</sup>                    | —                                      | 00 + 31 = 31 <sup>(4)</sup>               | —   | —   |  |
| 100-KFA40E                              | AC/DC   | (2)  | (2)                                    | (2)                                       | (2)                                       | (2)                                       |  |
| 100-KFC40                               | AC/DC   | 10 + 40 = 50                                   | (2)                                    | 00 + 40 = 40                              | 00 + 40 = 40                              | 00 + 40 = 40                              |  |











- (1) For other operating limits, please contact your local Rockwell Automation sales office or Allen-Bradley distributor.
- (2) Combination possible but not recommended, due to repeating or not consecutive sequence numbering.
- (3) T<sub>amb</sub> max. +40 °C (104 °F).
- (4) T<sub>amb</sub> max. +40 °C (104 °F) and only allowed for coil voltage 24V DC or 230V AC.

# Accessories




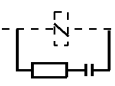
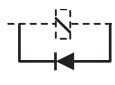
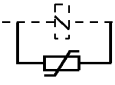
## Auxiliary Contact Blocks

|  | Description   | Connection Diagrams |      |               | For Use With  | Pkg. Qty. | Cat. No.             |                        |
|--|---|---------------------|------|---------------|---------------|-----------|----------------------|------------------------|
|  |   |                     | N.O. | N.C.          |               |           | Screw Type Terminals | Spring Clamp Terminals |
|  | Front-mounted Auxiliary Contacts<br>• Auxiliary contact blocks 2- and 4-pole versions<br>• Choice of contact configurations<br>• Snap on, no tools required<br>• Electronic-compatible bifurcated contacts for signals down to 15V/2 mA<br>• Mirror Contact performance per IEC 60947-4-1 |                     | 0    | 2             | 100-K05...K12 | 1         | 100-KFC02            | 100-KRFC02             |
|  |   |                     | 1    | 1             | 100-K05...K12 | 1         | 100-KFC11            | 100-KRFC11             |
|  |   |                     | 2    | 0             | 100-K05...K12 | 1         | 100-KFC20            | 100-KRFC20             |
|  |   | 0                   | 4    | 100-K05...K12 | 1             | 100-KFC04 | 100-KRFC04           |                        |
|  |   | 1                   | 3    | 100-K05...K12 | 1             | 100-KFC13 | 100-KRFC13           |                        |
|  |   | 3                   | 1    | 100-K05...K12 | 1             | 100-KFC31 | 100-KRFC31           |                        |
|  |   | 2                   | 2    | 100-K05...K12 | 1             | 100-KFC22 | 100-KRFC22           |                        |
|  |   | 4                   | 0    | 100-K05...K12 | 1             | 100-KFC40 | 100-KRFC40           |                        |

**Auxiliary Contact Blocks (Continued)**


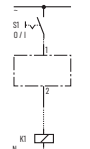
|   | Description   | Connection Diagrams  | N.O. / N.C. |      | For Use With     | Pkg. Qty. | Cat. No.             |                        |
|---|---|--|-------------|------|------------------|-----------|----------------------|------------------------|
|   |   |  | N.O.        | N.C. |                  |           | Screw Type Terminals | Spring Clamp Terminals |
|  | Front-mounted Auxiliary Contacts<br>• Auxiliary contact blocks 2- and 4-pole versions<br>• Choice of contact configurations<br>• Snap on, no tools required<br>• Electronic-compatible bifurcated contacts for signals down to 15V/2 mA<br>• Mirror Contact performance per IEC 60947-4-1 |   | 0           | 2    | 100/104-K, 700-K | 1         | 100-KFA02E           | 100-KRFA02E            |
|   |   |   | 1           | 1    | 100/104-K, 700-K | 1         | 100-KFA11E           | 100-KRFA11E            |
|   |   |   | 2           | 0    | 100/104-K, 700-K | 1         | 100-KFA20E           | 100-KRFA20E            |
|  |   |   | 0           | 4    | 100/104-K, 700-K | 1         | 100-KFA04E           | 100-KRFA04E            |
|   |   |   | 1           | 3    | 100/104-K, 700-K | 1         | 100-KFA13E           | 100-KRFA13E            |
|   |   |   | 2           | 2    | 100/104-K, 700-K | 1         | 100-KFA22Z           | 100-KRFA22Z            |
|   |   |   | 3           | 1    | 100/104-K, 700-K | 1         | 100-KFA31Z           | 100-KRFA31Z            |
|   |   |  | 4           | 0    | 100/104-K, 700-K | 1         | 100-KFA40E           | 100-KRFA40E            |

**Control Modules**



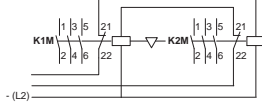


|   | Description   | Connection Diagrams   | For Use With             | Pkg. Qty.        | Cat. No.    |
|---|---|---|--------------------------|------------------|-------------|
|    | Mechanical Interlock<br>• For interlocking of two adjacent contactors No added width to contactor assembly<br>• Front mount plug-in type<br>• Optional auxiliary contact blocks and suppressor modules mount onto the interlock |  | 100/104-K/-KR, 700-K/-KR | 1                | 100-KMCH    |
|    | Surge Suppressor<br>• Plug-in type<br>• Limits surge voltage on coil drop-off   |  | 100/104-K/-KR, 700-K/-KR | 1 <sup>(1)</sup> | 100-KFSC50  |
|   |   |   |                          | 1 <sup>(1)</sup> | 100-KFSC280 |
|   |   |   |                          | 1 <sup>(1)</sup> | 100-KFSC480 |
|   |   |  | 100/104-K/-KR, 700-K/-KR | 1 <sup>(1)</sup> | 100-KFSV55  |
|   |   |   |                          | 1 <sup>(1)</sup> | 100-KFSV136 |
|   |   |   |                          | 1 <sup>(1)</sup> | 100-KFSV277 |
|  | 100/104-K/-KR, 700-K/-KR  | 1 <sup>(1)</sup>  | 100-KFSD250              |                  |             |

(1) May be ordered in package quantities of 10. Add letter M to the end of the cat. no. Example: 100-KFSC50M.

**Timers**




|   | Description  | Connection Diagrams   | For Use With     | Pkg. Qty. | Cat. No.              |
|---|--|---|------------------|-----------|-----------------------|
|  | Solid-State Timing Element<br>• 110...250V AC or DC<br>• Includes 35 mm Hat Rail adapter |  | 100/104-K, 700-K | 10        | 100-KT3S<br>100-KT30S |

### Connecting Components

|   | Description   | For Use With   | Pkg. Qty.       | Cat. No.                         |
|---|---|--|-----------------|----------------------------------|
|  | ECO Connecting Module – 12 A <ul style="list-style-type: none"> <li>For DOL and reversing starters</li> <li>Eco-starters mount on single DIN Rail (140M on DIN Rail)</li> <li>Electrical and mechanical interconnection of 140M and 100-K contactors</li> </ul> | Connects:<br>140M-C circuit breakers with 100-K contactors                         | 140M-C to 100-K | 1 <sup>(1)</sup><br>140M-C-PEK12 |
|  | Power Wiring Kit <ul style="list-style-type: none"> <li>For Reversing and Star/Delta combinations. Star-point bridge not included.</li> <li>Min. interruption time 50 ms</li> </ul>   |  | 100-K           | 1<br>100-KPR                     |
|  | Feeder Terminal for Compact Bus Bars <ul style="list-style-type: none"> <li>Max. current 34 A</li> </ul>  | Supply of compact bus bars   | 100-K           | 1<br>100-KWT                     |
|  | Three-phase Compact Bus Bars <ul style="list-style-type: none"> <li>Max. current 34 A</li> <li>For 100-K, 5...12 A contactors</li> </ul>  | 45 mm spacing (3 connections) <sup>(2)</sup>                                       | 100-K, 5...12 A | 1<br>100-KW453                   |
|   |   | 45 mm spacing (4 connections) <sup>(2)</sup>                                       | 100-K, 5...12 A | 1<br>100-KW454                   |

(1) May be ordered in package quantities of 10. Add letter M to the end of the cat. no. Example: 140M-C-PEK12M.  
 (2) Combinations possible. Example: For 6 contactor connections use one cat. no. 100-KW453 and one cat. no. 100-KW454.

### Marking Systems

|   | Description  | Pkg. Qty.  | Cat. No.            |
|---|--|--|---------------------|
|    | Label Sheet <ul style="list-style-type: none"> <li>105 self-adhesive paper labels each, 6 x 17 mm (0.236 x 0.67 in)</li> </ul>   | 10   | 100-FMS             |
|   | Adhesive labels <ul style="list-style-type: none"> <li>Each label 6 x 17 mm (0.236 x 0.67 in)</li> <li>White, halogen-free polyester, with acrylate adhesive</li> <li>Ambient temperature range -40...+120 °C (-40...+248 °F)</li> <li>Qty: 3000/roll</li> </ul> | Ribbon: Cat. No. 1492-PRILAB<br>Roller: Cat. No. 1492-PROLLLAB | 1<br>1492-MDM6X17-W |
|  | Marking Tag <ul style="list-style-type: none"> <li>Each tag 6 x 12 mm (0.236 x 0.472 in)</li> <li>White, PC-ABS, TPU, halogen-free, clip-in foot</li> <li>Ambient temperature range -50...+90 °C (-58...+194 °F)</li> <li>Qty: 600/roll</li> </ul>               | Ribbon: Cat. No.1492-PRIBTB<br>Roller: Cat. No. 1492-PROLLTB   | 1<br>1492-MT6X12    |

# Specifications

Table 1 - Main Circuits

|  |        | 100-KR |     | 100/104-K |     |      |      |
|--|--------|--------|-----|-----------|-----|------|------|
|  |        | 05     | 09  | 05        | 09  | 12   | 12   |
| <b>AC-1 Active Power Load (50 Hz); Ambient temperature 40 °C (104 °F)</b>                  |        |        |     |           |     |      |      |
| Rated Operational Current, $I_e$   | ≤ 500V | [A]    | 10  | 10        | 20  | 20   | 20   |
|  | 690V   | [A]    | 10  | 10        | 20  | 20   | 20   |
| Rated Operational Power, $P_e$   | 230V   | [kW]   | 4   | 4         | 8   | 8    | 8    |
|  | 240V   | [kW]   | 4   | 4         | 8.3 | 8.3  | 8.3  |
|  | 400V   | [kW]   | 6.9 | 6.9       | 14  | 14   | 14   |
|  | 415V   | [kW]   | 7   | 7         | 14  | 14   | 14   |
|  | 500V   | [kW]   | 8.7 | 8.7       | 17  | 17   | 17   |
|  | 690V   | [kW]   | 12  | 12        | 24  | 24   | 24   |
| <b>AC-1 Active Power Load (50 Hz); Ambient temperature 60 °C (140 °F)</b>                  |        |        |     |           |     |      |      |
| Rated Operational Current, $I_e$   | ≤ 500V | [A]    | 10  | 10        | 16  | 16   | 16   |
|  | 690V   | [A]    | 10  | 10        | 16  | 16   | 16   |
| Rated Operational Power, $P_e$   | 230V   | [kW]   | 4   | 4         | 6.4 | 6.4  | 6.4  |
|  | 240V   | [kW]   | 4   | 4         | 6.7 | 6.7  | 6.7  |
|  | 400V   | [kW]   | 6.9 | 6.9       | 11  | 11   | 11   |
|  | 415V   | [kW]   | 7   | 7         | 12  | 12   | 12   |
|  | 500V   | [kW]   | 8.7 | 8.7       | 14  | 14   | 14   |
|  | 690V   | [kW]   | 12  | 12        | 19  | 19   | 19   |
| <b>Switching of 3-phase Motors; (50 Hz) Ambient temperature 60 °C (140 °F), AC-2, AC-3</b> |        |        |     |           |     |      |      |
| Rated Operational Current, $I_e$   | 230V   | [A]    | 6.3 | 8.5       | 6.3 | 11.3 | 11.3 |
|  | 240V   | [A]    | 6.3 | 8.5       | 6.3 | 11.3 | 11.3 |
|  | 400V   | [A]    | 4.9 | 8.5       | 4.9 | 8.5  | 11.5 |
|  | 415V   | [A]    | 4.9 | 8.5       | 4.9 | 8.5  | 11.5 |
|  | 500V   | [A]    | 3.9 | 6.8       | 3.9 | 6.8  | 9.2  |
|  | 690V   | [A]    | 2.8 | 4.9       | 2.8 | 4.9  | 6.7  |
| Rated Operational Power, $P_e$   | 230V   | [kW]   | 1.5 | 2.2       | 1.5 | 3    | 3    |
|  | 240V   | [kW]   | 1.5 | 2.2       | 1.5 | 3    | 3    |
|  | 400V   | [kW]   | 2.2 | 4         | 2.2 | 4    | 5.5  |
|  | 415V   | [kW]   | 2.2 | 4         | 2.2 | 4    | 5.5  |
|  | 500V   | [kW]   | 2.2 | 4         | 2.2 | 4    | 5.5  |
|  | 690V   | [kW]   | 2.2 | 4         | 2.2 | 4    | 5.5  |
| <b>Load Carrying Capacity per UL/CSA</b>   |        |        |     |           |     |      |      |
| General Purpose Current (enclosed)   |        | [A]    | 9   | 9         | 12  | 15   | 18   |
| Rated current (enclosed), 1-phase  | 115V   | [A]    | 7.2 | 7.2       | 9.8 | 9.8  | 13.8 |
|  | 230V   | [A]    | 6.9 | 8         | 8   | 10   | 12   |
| Rated power (enclosed), 1-phase  | 115V   | [Hp]   | 1/3 | 1/3       | 0.5 | 0.5  | 0.75 |
|  | 230V   | [Hp]   | 3/4 | 1         | 1   | 1.5  | 2    |
| Rated current (enclosed), 3-phase  | 200V   | [A]    | 6.9 | 7.8       | 6.9 | 7.8  | 11   |
|  | 230V   | [A]    | 6   | 6.8       | 6   | 6.8  | 9.6  |
|  | 460V   | [A]    | 4.8 | 7.6       | 4.8 | 7.6  | 11   |
|  | 575V   | [A]    | 3.9 | 6.1       | 3.9 | 6.1  | 9    |
| Rated power (enclosed), 3-phase  | 200V   | [Hp]   | 1.5 | 2         | 1.5 | 2    | 3    |
|  | 230V   | [Hp]   | 1.5 | 2         | 1.5 | 2    | 3    |
|  | 460V   | [Hp]   | 3   | 5         | 3   | 5    | 7.5  |
|  | 575V   | [Hp]   | 3   | 5         | 3   | 5    | 7.5  |

Table 2 - Main Circuits

|   |                     | 100/104-K |      | 05   | 09   | 12 |
|---|---------------------|-----------|------|------|------|----|
| <b>Switching of 3-phase Motors, (50 Hz); Ambient temperature 60 °C (140 °F), AC-4</b> |                     |           |      |      |      |    |
| Rated Operational Current, $I_e$  | 230V                | [A]       | 6.3  | 11.3 | 11.3 |    |
|   | 240V                | [A]       | 6.3  | 11.3 | 11.3 |    |
|   | 400V                | [A]       | 4.9  | 8.5  | 11.5 |    |
|   | 415V                | [A]       | 4.9  | 8.5  | 11.5 |    |
|   | 500V                | [A]       | 3.9  | 6.8  | 9.2  |    |
|   | 690V                | [A]       | 2.8  | 4.9  | 6.7  |    |
| Rated Operational Power, $P_e$  | 230V                | [Hp]      | 1.5  | 3    | 3    |    |
|   | 240V                | [Hp]      | 1.5  | 3    | 3    |    |
|   | 400V                | [Hp]      | 2.2  | 4    | 5.5  |    |
|   | 415V                | [Hp]      | 2.2  | 4    | 5.5  |    |
|   | 500V                | [Hp]      | 2.2  | 4    | 5.5  |    |
|   | 690V                | [Hp]      | 2.2  | 4    | 5.5  |    |
| <b>AC-4 at approximately 200,000 operations</b>                                       |                     |           |      |      |      |    |
| Rated Operational Current, $I_e$  | 230V                | [A]       | 2.3  | 3.9  | 3.9  |    |
|   | 240V                | [A]       | 2.3  | 3.9  | 3.9  |    |
|   | 400/415V            | [A]       | 2    | 3.6  | 3.6  |    |
|   | 500V                | [A]       | 1.9  | 3.2  | 3.2  |    |
| Rated Operational Power, $P_e$  | 230V <sup>(1)</sup> | [Hp]      | 0.37 | 0.75 | 0.75 |    |
|   | 240V <sup>(1)</sup> | [Hp]      | 0.37 | 0.75 | 0.75 |    |
|   | 400V <sup>(1)</sup> | [Hp]      | 0.75 | 1.5  | 1.5  |    |
|   | 415V <sup>(1)</sup> | [Hp]      | 0.75 | 1.5  | 1.5  |    |
|   | 500V <sup>(1)</sup> | [Hp]      | 0.75 | 1.5  | 1.5  |    |
| Max. switching frequency  |                     | Ops/hour  | 250  | 250  | 250  |    |
| <b>Wye-Delta (60 Hz)</b>  |                     |           |      |      |      |    |
| Rated Operational Power, $P_e$  | 200V                | [Hp]      | 2.2  | 3    | 5    |    |
|   | 230V                | [Hp]      | 2.2  | 3    | 5    |    |
|   | 460V                | [Hp]      | 5    | 7.5  | 10   |    |
|   | 575V                | [Hp]      | 5    | 7.5  | 10   |    |
| <b>Star-Delta Starting (50 Hz)</b>  |                     |           |      |      |      |    |
| Rated Operational Current, $I_e$  | ≤ 230V              | [A]       | 11.3 | 20   | 20   |    |
|   | ≤ 240V              | [A]       | 11.3 | 20   | 20   |    |
|   | 400V                | [A]       | 8.5  | 15.5 | 15.5 |    |
|   | 415V                | [A]       | 8.5  | 15.5 | 15.5 |    |
|   | 500V                | [A]       | 6.8  | 12.4 | 12.4 |    |
|   | 690V                | [A]       | 4.9  | 8.9  | 8.9  |    |
| Rated Operational Power, $P_e$  | 230V <sup>(1)</sup> | [kW]      | 3    | 5.5  | 5.5  |    |
|   | 240V <sup>(1)</sup> | [kW]      | 3    | 5.5  | 5.5  |    |
|   | 400V <sup>(1)</sup> | [kW]      | 4    | 7.5  | 7.5  |    |
|   | 415V <sup>(1)</sup> | [kW]      | 4    | 7.5  | 7.5  |    |
|   | 500V <sup>(1)</sup> | [kW]      | 4    | 7.5  | 7.5  |    |
|   | 690V <sup>(1)</sup> | [kW]      | 4    | 7.5  | 7.5  |    |

(1) Power ratings at 50 Hz: Preferred values according to IEC 60072-1

Table 3 - Main Circuits

| 100/104-K  |          | 05    | 09   | 12    |       |
|--|----------|-------|------|-------|-------|
| <b>Switching of Power Transformers, AC-6a (50 Hz)</b>  |          |       |      |       |       |
| Inrush Current _____ = n<br>Rated transformer current  |          |       |      |       |       |
| n= 30  | ≤ 230V   | [A]   | 2.9  | 5.4   | 5.4   |
|  | ≤ 240V   | [A]   | 2.9  | 5.4   | 5.4   |
|  | ≤ 400V   | [A]   | 2.4  | 4.1   | 5.4   |
|  | ≤ 415V   | [A]   | 2.4  | 4.1   | 5.4   |
|  | ≤ 500V   | [A]   | 1.8  | 3.2   | 3.2   |
| Apparent Power   | 230V     | [kVA] | 1.2  | 2     | 2     |
|  | 240V     | [kVA] | 1.2  | 2     | 2     |
|  | 400V     | [kVA] | 1.7  | 2.8   | 3.4   |
|  | 415V     | [kVA] | 1.7  | 2.8   | 3.4   |
|  | 500V     | [kVA] | 1.7  | 2.8   | 3.4   |
|  | 690V     | [kVA] | 2    | 4     | 5     |
| <b>Switching of Lamps</b>  |          |       |      |       |       |
| Gas discharge lamps AC-5a, 40 °C (104 °F)  |          |       |      |       |       |
| open   | [A]      | 18    | 18   | 18    |       |
| enclosed   | [A]      | 14.5  | 14.5 | 14.5  |       |
| Individually compensated:  |          |       |      |       |       |
| Max. capacitance at expected   |          |       |      |       |       |
| Short-circuit current of   | 10 kA    | [μF]  | 750  | 750   | 750   |
|  | 20 kA    | [μF]  | 400  | 400   | 400   |
| Filament AC-5b   | 230/240V | [A]   | 5    | 9     | 9     |
| <b>Switching of Low Inductive Loads in Home Appliances and Similar Applications per IEC 61095 (50 Hz)</b>    |          |       |      |       |       |
| AC-7a  | 230V     | [A]   | 20   | 20    | 20    |
|  | 400V     | [A]   | 20   | 20    | 20    |
| <b>Switching of Motor Load for Home Appliances (50 Hz)</b>   |          |       |      |       |       |
| AC-7b  | 230V     | [A]   | 6    | 11    | 11    |
|  | 400V     | [A]   | 6    | 11    | 11    |
| <b>Switching of Hermetically Sealed Cooling Compressor Motors - manual reset of overload release (50 Hz)</b> |          |       |      |       |       |
| AC-8a  | 400V     | [A]   | 11   | 18    | 18    |
|  | 500V     | [A]   | 10   | 15    | 15    |
| <b>Switching of DC Loads</b>   |          |       |      |       |       |
| Non-inductive or slightly inductive loads or resistance furnaces<br>DC-1, 60 °C (140 °F)                     |          |       |      |       |       |
| 1 pole   | 24V      | [A]   | 6    | 9     | 9     |
|  | 48/60V   | [A]   | 4/1  | 6/1.5 | 6/1.5 |
|  | 110V     | [A]   | 0.6  | 1     | 1     |
|  | 220V     | [A]   | 0.2  | 0.3   | 0.3   |
|  | 440V     | [A]   | 0.08 | 0.1   | 0.1   |
| 2 poles in series  | 24V      | [A]   | 6    | 9     | 9     |
|  | 48/60V   | [A]   | 6    | 8     | 8     |
|  | 110V     | [A]   | 4    | 6     | 6     |
|  | 220V     | [A]   | 0.8  | 1.2   | 1.2   |
|  | 440V     | [A]   | 0.2  | 0.3   | 0.3   |
| 3 poles in series  | 24V      | [A]   | 6    | 9     | 9     |
|  | 48/60V   | [A]   | 6    | 9     | 9     |
|  | 110V     | [A]   | 6    | 9     | 9     |
|  | 220V     | [A]   | 3    | 4     | 4     |
|  | 440V     | [A]   | 0.4  | 0.6   | 0.6   |

Table 3 - Main Circuits (Continued)

| 100/104-K  |                      | 05          | 09          | 12  |     |
|--|----------------------|-------------|-------------|-----|-----|
| <b>Shunt-wound Motors</b>  |                      |             |             |     |     |
| <b>Starting, reverse current braking, reversing, stepping DC-3, 60 °C (140 °F)</b> |                      |             |             |     |     |
| 3 poles in series  | 24V                  | [A]         | 5           | 9   | 9   |
|  | 48/60V               | [A]         | 4           | 6   | 6   |
|  | 110V                 | [A]         | 2           | 3   | 3   |
|  | 220V                 | [A]         | 0.8         | 1.2 | 1.2 |
|  | 440V                 | [A]         | 0.15        | 0.2 | 0.2 |
| <b>Series-wound Motors</b>   |                      |             |             |     |     |
| <b>Starting, reverse current braking, reversing, stepping DC-5, 60 °C (140 °F)</b> |                      |             |             |     |     |
| 3 poles in series  | 24V                  | [A]         | 5           | 9   | 9   |
|  | 48/60V               | [A]         | 2           | 3   | 3   |
|  | 110V                 | [A]         | 0.6         | 1   | 1   |
|  | 220V                 | [A]         | 0.1         | 0.1 | 0.1 |
| Short Time Withstand $I_{CW}$ ,<br>60 °C (140 °F)                                  | 10 s                 | [A]         | 60          | 96  | 96  |
| <b>Resistance and Power Dissipation</b>  |                      |             |             |     |     |
| Main current circuit resistance  | [mΩ]                 | 2.2         | 2.2         | 2.2 |     |
| Power dissipation by all circuits at $I_e$ AC-3/<br>400V                           | [W]                  | 0.3         | 0.9         | 0.9 |     |
| <b>Total power dissipation</b>   |                      |             |             |     |     |
| At $I_e$ AC-3/400V   | AC control           | [W]         | 2.1         | 2.7 | 2.7 |
|  | DC control           | [W]         | 2.9         | 3.5 | 3.5 |
| <b>Lifespan</b>  |                      |             |             |     |     |
| Mechanical AC control  | [Million operations] | 15          | 15          | 15  |     |
| Mechanical DC control  | [Million operations] | 15          | 15          | 15  |     |
| Electrical AC-3 (400 V)  | [Million operations] | 0.7         | 0.7         | 0.7 |     |
| <b>Weight</b>  |                      |             |             |     |     |
| AC   | Non-Rev.             | [kg (lbs.)] | 0.16 (0.35) |     |     |
|  | Rev.                 | [kg (lbs.)] | 0.4 (0.88)  |     |     |
| DC   | Non-Rev.             | [kg (lbs.)] | 0.2 (0.44)  |     |     |
|  | Rev.                 | [kg (lbs.)] | 0.48 (1.06) |     |     |

Table 4 - Conductors

|   | 100-KR       |                        | 100/104-K                 |               |    |
|---|--------------|------------------------|---------------------------|---------------|----|
|   | 05           | 09                     | 05                        | 09            | 12 |
| Conductor Cross Sections - Main Contacts<br>Terminal type |              |                        |                           |               |    |
|   | 1 conductor  | [mm <sup>2</sup> ]     | 0.50...2.5                | 0.75...2.5    |    |
|   | 2 conductors | [mm <sup>2</sup> ]     | 0.50...2.5                | 0.75...2.5    |    |
|   | 1 conductor  | [mm <sup>2</sup> ]     | 0.75...2.5 <sup>(2)</sup> | 1...4         |    |
|   | 2 conductors | [mm <sup>2</sup> ]     | 0.75...2.5 <sup>(2)</sup> | 1...2.5+1...4 |    |
| Recommended torque  | [N·m]        | —                      | 1.2                       |               |    |
| Cross section per UL/CSA                                  | [AWG]        | 18...14 <sup>(2)</sup> | 18...12                   |               |    |
| Recommended torque  | [lb·in]      | —                      | 10.6                      |               |    |

(1) Pozidriv No. 2 / Blade No. 3 screw  
(2) Fine- or coarse-stranded only



**Table 5 - Short-Circuit Coordination Data<sup>(1)</sup>**

| 100/104-K  |     | 05                            | 09 | 12 |
|--|-----|-------------------------------|----|----|
| <b>Short Circuit Coordination (Max. Fuse or Circuit Breaker Rating) Per IEC 60947-4-1 (contactor and fuses only)</b> |     |                               |    |    |
| DIN Fuses- gG, gL  |     | 50 kA Available Fault Current |    |    |
| Type "1" (690V)  | [A] | 35                            | 35 | 35 |
| Type "2" (400V)  | [A] | 16                            | 20 | 20 |
| <b>Per UL 508 and CSA 22.2 No. 14 (contactor and fuses or circuit breaker only)</b>                                  |     |                               |    |    |
| <b>UL Class K5 and RK5 Fuses</b>   |     | 5 kA Available Fault Current  |    |    |
| UL Listed Combination (600V)   | [A] | 40                            | 40 | 40 |
| <b>UL Class CC and CSA HRCI-MISC Fuses</b>   |     | 50 kA Available Fault Current |    |    |
| UL Listed Combination (600V)   | [A] | 30                            | 30 | 30 |
| <b>UL Class J and CSA HRCI-J Fuses</b>   |     | 50 kA Available Fault Current |    |    |
| UL Listed Combination (600V)   | [A] | 30                            | 30 | 30 |



(1) See the Rockwell Automation Global SCCR Tool at [rok.auto/sccr](http://rok.auto/sccr) for complete short-circuit current ratings.

**Table 6 - Coil Data**

| 100/104-K               |               | 05                  | 09                                     | 12 |
|-------------------------|---------------|---------------------|--|----|
| <b>Operating Limits</b> |               |                     |  |    |
| 50 Hz, 60 Hz, 50/60 Hz  | pick-up       | [x U <sub>s</sub> ] | 0.85...1.1                             |    |
|                         | dropout       | [x U <sub>s</sub> ] | 0.2...0.75                             |    |
| DC (conventional)       | pick-up       | [x U <sub>s</sub> ] | 0.8...1.1<br>0.7...1.25 <sup>(1)</sup> |    |
|                         | dropout       | [x U <sub>s</sub> ] | 0.1...0.75                             |    |
| <b>Coil Consumption</b> |               |                     |  |    |
| 50 Hz, 60 Hz, 50/60 Hz  | pick-up       | [VA]                | 35                                     |    |
|                         | hold-in       | [VA/W]              | 5/1.8                                  |    |
| DC (conventional)       | pick-up       | [W]                 | cold 3.0, warm 2.6                     |    |
|                         | hold-in       | [W]                 | cold 3.0, warm 2.6                     |    |
| <b>Operating Times</b>  |               |                     |  |    |
| AC                      | closing delay | [ms]                | 15...40                                |    |
|                         | opening delay | [ms]                | 15...33                                |    |
| With RC module          | closing delay | [ms]                | 15...28                                |    |
| DC (conventional)       | opening delay | [ms]                | 18...40                                |    |
|                         | closing delay | [ms]                | 6...12                                 |    |
| With integrated diode   | opening delay | [ms]                | 8...12                                 |    |
| With external diode     | opening delay | [ms]                | 35...50                                |    |

(1) For 9, 12, 24, and 110V DC coils.

**Table 7 - Auxiliary Contacts and Auxiliary Contact Blocks**

| Conventional Coils   |   | Internal | Front mounted |
|--|---|----------|---------------|
| <b>Switching of AC Loads</b>                                       |   |          |               |
| AC-12 I <sub>th</sub>  | at 40 °C (104 °F)   | [A]      | 10            |
|  | at 60 °C (140 °F)   | [A]      | 6             |
| AC-15 at rated voltage of  | 24V   | [A]      | 6             |
|  | 42/48V  | [A]      | 6             |
|  | 120V  | [A]      | 6             |
|  | 230V  | [A]      | 3             |
|  | 240V  | [A]      | 3             |
|  | 400V  | [A]      | 1.8           |
|  | 415V  | [A]      | 1.8           |
|  | 500V  | [A]      | 1.4           |
|  | 690V  | [A]      | 1.0           |
|  | <b>Switching of DC Loads</b>  |          |               |
| DC-12 L/R < 1 ms resistive loads at                                | 24V DC  | [A]      | 6             |
|  | 48V DC  | [A]      | 4             |
|  | 110V DC   | [A]      | 0.6           |
|  | 220V DC   | [A]      | 0.2           |
|  | 440V DC   | [A]      | 0.08          |
| DC-14L/R <15 ms inductive loads with economy resistor in series at | 24V DC  | [A]      | 4             |
|  | 48V DC  | [A]      | 2.5           |
|  | 110V DC   | [A]      | 0.4           |
|  | 220V DC   | [A]      | 0.12          |
| DC-13 switching electromagnets at                                  | 440V DC   | [A]      | 0.05          |
|  | 24V DC  | [A]      | 2.8           |
|  | 48V DC  | [A]      | 1.2           |
|  | 110V DC   | [A]      | 0.55          |
|  | 220V DC   | [A]      | 0.27          |
| Fuse gG  |  | [A]      | 10            |
|  |  | [A]      | 10            |
|  | Min. switching capacity according to IEC 60947-5-4                                    |          | 15V/ 10 mA    |
| <b>Load Carrying Capacity per UL/CSA</b>                           |   |          |               |
| Rated voltage  | AC  | [V]      | max.600       |
| Continuous rating  | at 40 °C (104 °F)   | [A]      | 10            |
| Switching capacity   | AC  | [A]      | A600 B600     |
| Rated voltage  | DC  | [V]      | max.600       |
| Switching capacity   | DC  | [A]      | Q600          |

**Table 8 - General**

| Attribute  |             | Value   |
|--|-------------|---|
| <b>Rated Isolation Voltage U<sub>i</sub></b>     |             |   |
| IEC  | [V]         | 690   |
| UL, CSA  | [V]         | 600   |
| Rated Impulse Voltage Withstand U <sub>imp</sub> | [kV]        | 6   |
| <b>Rated Voltage U<sub>e</sub></b>               |             |   |
| AC 50/60 Hz                                      | [V]         | 230, 240, 400, 415, 460, 500, 575, 690                          |
| DC   | [V]         | 24, 48, 110, 220, 440   |
| Insulation Class of the Coil                     |             | Class F per IEC 60085<br>Class 105 insulation system per UL 508 |
| Rated coil frequency                             |             | AC 50/60 Hz, DC   |
| Ambient Temperature                              |             |   |
| Storage  | [ °C ( °F)] | -55...+80 (-67...176)   |
| Operation at rated voltage                       | [ °C ( °F)] | -25...+60 (-13...140)   |
| at 70 °C (158 °F)                                |             | 15% current reduction against 60 °C (140 °F) values             |
| Climatic Withstand                               |             | IEC60068-2-30   |
| Max. Altitude of Installation Site               | [m]         | 2000 NN, per IEC60947-4   |
| Protection Class                                 |             | IP2X  |
| Single contactor cover                           |             | –   |
| Contactors with frame terminal block             |             | –   |
| Auxiliary contact                                |             | IP2X  |
| Protection against Accidental Contact            |             | –   |
| Resistance to Shock                              |             | IEC60068-2  |
| Resistance to Vibration                          |             | IEC60068-2  |
| Mechanically Linked Contacts IEC60947-5-1,AnnexL |             | 100-K... (on main device)                                       |
| Mirror Contacts IEC60947-4 Annex F               |             | 100-K...+100-KF...  |

**Table 9 - Standards Compliance and Certifications**

| Standards Compliance   | Certifications                                    |
|--|---|
| IEC/EN 60947-1,-4-1,-5-1,-5-4  | CE Marked   |
| UL 508   | CCC   |
| CSA 22.2. No. 14   | cULus Listed (File No. E41850, Guide NLDX, NLDX7) |
| NF F 62-000  |   |
| Meets the material restrictions for European Directive 2002/95/IEC-EU-RoHS |   |

# Life-Load Curves

Figure 1 - AC-3, Switching of squirrel-cage motors while starting /AC-1, Non- or slightly inductive loads, resistance furnaces

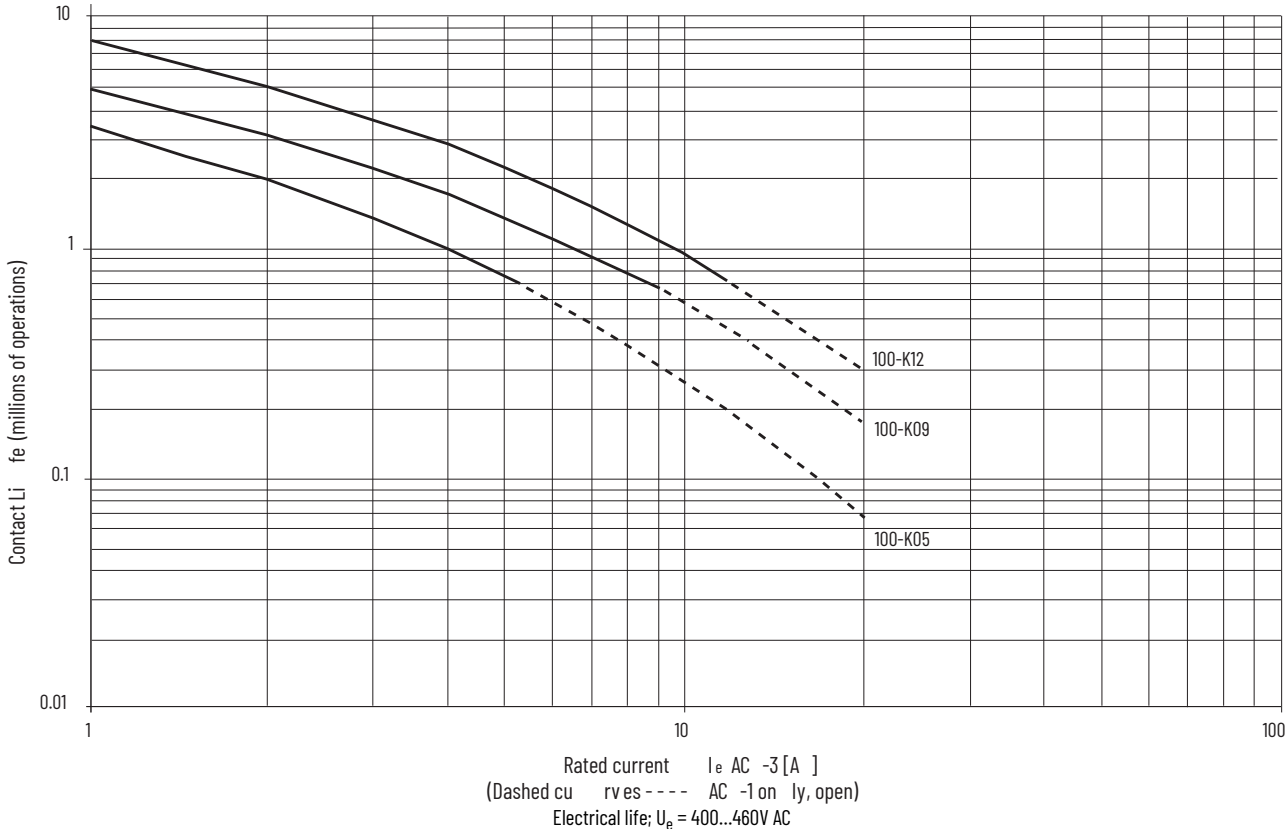
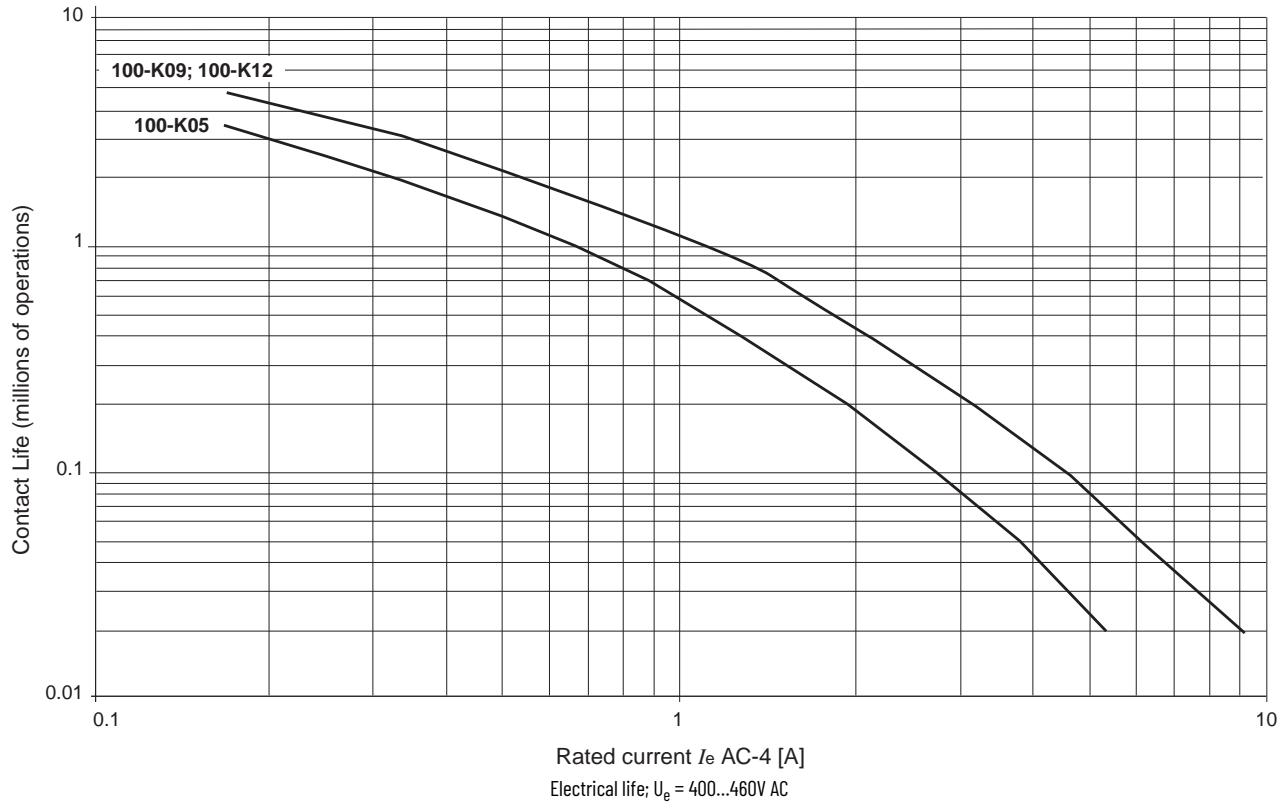


Figure 2 - AC-4, Stepping of squirrel-cage motors



# Approximate Dimensions

Dimensions are shown in millimeters (inches). Dimensions are not intended for manufacturing purposes.

Figure 3 - 100-K Miniature Contactor with 193-K Overload Relay

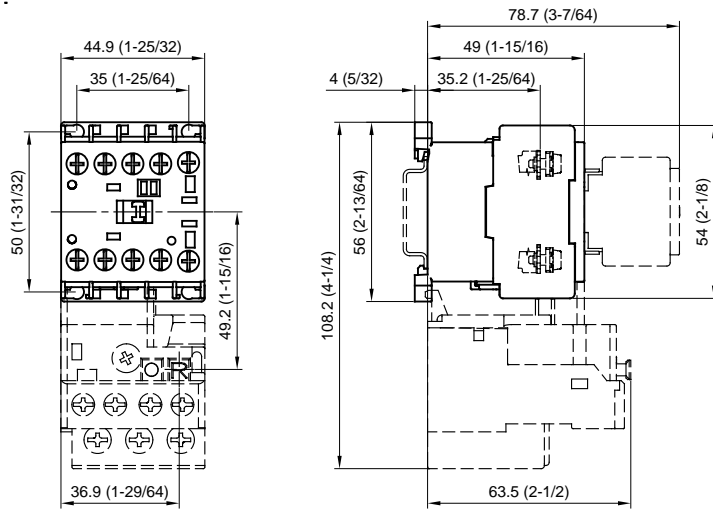
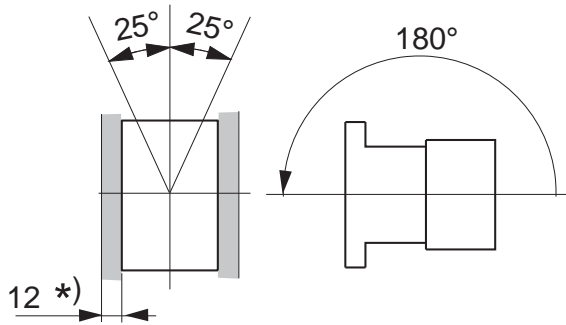


Figure 4 - Mounting Position



\*) - Minimum distance to grounded parts or walls



## Product Selection—100-C/104-C Contactors

- Compact sizes from 4...55 kW/5...75 Hp (9...97 A)
- Common accessories for all contactor sizes
- Front and side mounting of auxiliary contacts
- Electronic and pneumatic timing modules
- Space-saving coil-mounted control modules
- Reversible coil terminations (line or load side)
- All devices can be attached to 35 mm DIN mounting Rail
- Environmentally friendly materials



The Bulletin 100-C/104-C IEC contactor family, along with a wide range of common accessories and Bulletin 193 solid-state overload relays, provides the most compact and flexible starter component system available.

### 3-Pole AC- and DC-operated Contactors



| Rated Operational Current $I_e$ [A] |      | Ratings for switching AC motors - AC-2, AC-3, AC-4 |          |      |      |            |       |         |       |       |       | Auxiliary Contacts  |   | Cat. No.                  |
|-------------------------------------|------|--|----------|------|------|------------|-------|---------|-------|-------|-------|---|---|---------------------------|
|                                     |      | 3-phase kW (50 Hz)                                 |          |      |      | Hp (60 Hz) |       |         |       |       |       |  |  |                           |
| 40 °C (104 °F)                      |      | 230V   | 400/415V | 500V | 690V | 1-Phase    |       | 3-Phase |       |       |       | N.O.  | N.C.  |                           |
| AC-3                                | AC-1 |  |          |      |      | 115V       | 230V  | 200V    | 230V  | 460V  | 575V  |   |   |                           |
| 9                                   | 32   | 3  | 4        | 4    | 4    | 1/2        | 1-1/2 | 2       | 2     | 5     | 7-1/2 | 1   | 0   | 100-C09⊗10                |
|                                     |      |  |          |      |      |            |       |         |       |       |       | 0   | 1   | 100-C09⊗01 <sup>(1)</sup> |
| 12                                  | 32   | 4  | 5.5      | 5.5  | 5.5  | 1/2        | 2     | 3       | 3     | 7-1/2 | 10    | 1   | 0   | 100-C12⊗10                |
|                                     |      |  |          |      |      |            |       |         |       |       |       | 0   | 1   | 100-C12⊗01 <sup>(1)</sup> |
| 16                                  | 32   | 5.5  | 7.5      | 7.5  | 7.5  | 1          | 3     | 5       | 5     | 10    | 15    | 1   | 0   | 100-C16⊗10                |
|                                     |      |  |          |      |      |            |       |         |       |       |       | 0   | 1   | 100-C16⊗01 <sup>(1)</sup> |
| 23                                  | 32   | 7.5  | 11       | 13   | 10   | 2          | 3     | 5       | 7-1/2 | 15    | 15    | 1   | 0   | 100-C23⊗10                |
|                                     |      |  |          |      |      |            |       |         |       |       |       | 0   | 1   | 100-C23⊗01 <sup>(1)</sup> |
| 30                                  | 65   | 10   | 15       | 15   | 15   | 2          | 5     | 7-1/2   | 10    | 20    | 25    | 0   | 0   | 100-C30⊗00                |
|                                     |      |  |          |      |      |            |       |         |       |       |       | 1   | 0   | 100-C30⊗10                |
|                                     |      |  |          |      |      |            |       |         |       |       |       | 0   | 1   | 100-C30⊗01 <sup>(2)</sup> |
|                                     |      |  |          |      |      |            |       |         |       |       |       | 0   | 0   | 100-C37⊗00                |
| 37                                  | 65   | 11   | 18.5/20  | 20   | 18.5 | 3          | 5     | 10      | 10    | 25    | 30    | 1   | 0   | 100-C37⊗10                |
|                                     |      |  |          |      |      |            |       |         |       |       |       | 0   | 1   | 100-C37⊗01 <sup>(2)</sup> |
|                                     |      |  |          |      |      |            |       |         |       |       |       | 0   | 0   | 100-C43⊗00                |
|                                     |      |  |          |      |      |            |       |         |       |       |       | 1   | 0   | 100-C43⊗10                |
| 43                                  | 85   | 13   | 22       | 25   | 22   | 3          | 7-1/2 | 10      | 15    | 30    | 30    | 0   | 1   | 100-C43⊗01 <sup>(2)</sup> |
|                                     |      |  |          |      |      |            |       |         |       |       |       | 1   | 0   | 100-C43⊗10                |
|                                     |      |  |          |      |      |            |       |         |       |       |       | 0   | 0   | 100-C55⊗00                |
| 55                                  | 85   | 15   | 30       | 30   | 30   | 5          | 10    | 15      | 20    | 40    | 40    | 1   | 0   | 100-C55⊗10                |
|                                     |      |  |          |      |      |            |       |         |       |       |       | 0   | 1   | 100-C55⊗01 <sup>(2)</sup> |
|                                     |      |  |          |      |      |            |       |         |       |       |       | 0   | 0   | 100-C60⊗00                |
| 60                                  | 100  | 18.5   | 32       | 37   | 32   | 5          | 10    | 15      | 20    | 40    | 50    | 1   | 0   | 100-C60⊗10                |
|                                     |      |  |          |      |      |            |       |         |       |       |       | 0   | 1   | 100-C60⊗01 <sup>(2)</sup> |
|                                     |      |  |          |      |      |            |       |         |       |       |       | 0   | 0   | 100-C72⊗00                |
| 72                                  | 100  | 22   | 40       | 45   | 40   | 5          | 15    | 20      | 25    | 50    | 60    | 1   | 0   | 100-C72⊗10                |
|                                     |      |  |          |      |      |            |       |         |       |       |       | 0   | 1   | 100-C72⊗01 <sup>(2)</sup> |
|                                     |      |  |          |      |      |            |       |         |       |       |       | 0   | 0   | 100-C85⊗00                |
| 85                                  | 100  | 25   | 45       | 55   | 45   | 7-1/2      | 15    | 25      | 30    | 60    | 60    | 1   | 0   | 100-C85⊗10                |
|                                     |      |  |          |      |      |            |       |         |       |       |       | 0   | 1   | 100-C85⊗01 <sup>(2)</sup> |
|                                     |      |  |          |      |      |            |       |         |       |       |       | 0   | 0   | 100-C97⊗00                |
| 97                                  | 130  | 30   | 55       | 55   | 55   | 10         | 20    | 30      | 30    | 75    | 75    | 1   | 0   | 100-C97⊗10                |
|                                     |      |  |          |      |      |            |       |         |       |       |       | 0   | 1   | 100-C97⊗01 <sup>(2)</sup> |

(1) N.C. auxiliary contact meets mechanically linked performance per IEC 60947-5-1, Annex L.

(2) N.C. auxiliary contact meets mirror contact performance per IEC 60947-4-1, Annex F.

⊗ Coil voltage code and terminal position—see [page 19](#)



4-Pole AC- and DC-Operated Contactors

| Rated Operational Current $I_e$ [A] |      | Ratings for switching AC motors - AC-2, AC-3 |          |      |      |            |       |                        |       |       |       | Contact Configuration, Main Poles   |   | Cat. No.    |
|-------------------------------------|------|--|----------|------|------|------------|-------|------------------------|-------|-------|-------|---|---|-------------|
|                                     |      | 3-phase kW (50 Hz) <sup>(1)</sup>            |          |      |      | Hp (60 Hz) |       |                        |       |       |       |  |  |             |
|                                     |      | 230V   | 400/415V | 500V | 690V | 1-Phase    |       | 3-Phase <sup>(1)</sup> |       |       |       |   |   |             |
| AC-3                                | AC-1 |  |          |      |      | 115V       | 230V  | 200V                   | 230V  | 460V  | 575V  | N.O.  | N.C.  |             |
| 9                                   | 32   | 3  | 4        | 4    | 4    | 1/2        | 1-1/2 | 2                      | 2     | 5     | 7-1/2 | 4   | 0   | 100-C09⊗400 |
|                                     |      |  |          |      |      |            |       |                        |       |       |       | 3   | 1   | 100-C09⊗300 |
|                                     |      |  |          |      |      |            |       |                        |       |       |       | 2   | 2   | 100-C09⊗200 |
| 12                                  | 32   | 4  | 5.5      | 5.5  | 5.5  | 1/2        | 2     | 3                      | 3     | 7-1/2 | 10    | 4   | 0   | 100-C12⊗400 |
|                                     |      |  |          |      |      |            |       |                        |       |       |       | 3   | 1   | 100-C12⊗300 |
|                                     |      |  |          |      |      |            |       |                        |       |       |       | 2   | 2   | 100-C12⊗200 |
| 16                                  | 32   | 5.5  | 7.5      | 7.5  | 7.5  | 1          | 3     | 5                      | 5     | 10    | 10    | 4   | 0   | 100-C16⊗400 |
|                                     |      |  |          |      |      |            |       |                        |       |       |       | 3   | 1   | 100-C16⊗300 |
|                                     |      |  |          |      |      |            |       |                        |       |       |       | 2   | 2   | 100-C16⊗200 |
| 23                                  | 32   | 7.5  | 11       | 13   | 10   | 2          | 3     | 5                      | 7-1/2 | 15    | 15    | 4   | 0   | 100-C23⊗400 |
|                                     |      |  |          |      |      |            |       |                        |       |       |       | 3   | 1   | 100-C23⊗300 |
|                                     |      |  |          |      |      |            |       |                        |       |       |       | 2   | 2   | 100-C23⊗200 |
| 37                                  | 75   | 11   | 18.5/20  | 20   | 18.5 | 3          | 5     | 10                     | 10    | 25    | 30    | 4   | 0   | 100-C40⊗400 |
|                                     |      |  |          |      |      |            |       |                        |       |       |       | 2   | 2   | 100-C40⊗200 |
| 85                                  | 130  | 25   | 45       | 55   | 45   | 7-1/2      | 15    | 25                     | 30    | 60    | 50    | 4   | 0   | 100-C90⊗400 |
|                                     |      |  |          |      |      |            |       |                        |       |       |       | 2   | 2   | 100-C90⊗200 |

(1) Three-phase ratings apply only to contactors with at least three N.O. power poles.

⊗ Coil voltage code and terminal position— see [page 19](#).

Reversing AC- and DC-Operated Contactors

| Rated Operational Current $I_e$ [A] |      | Ratings for switching AC motors - AC-2, AC-3, AC-4 |          |      |      |            |       |         |       |       |       | Auxiliary Contacts per Contactor  |   | Cat. No.   |
|-------------------------------------|------|--|----------|------|------|------------|-------|---------|-------|-------|-------|---|---|------------|
|                                     |      | 3-phase kW (50 Hz)                                 |          |      |      | Hp (60 Hz) |       |         |       |       |       |  |  |            |
|                                     |      | 230V   | 400/415V | 500V | 690V | 1-Phase    |       | 3-Phase |       |       |       |   |   |            |
| AC-3                                | AC-1 |  |          |      |      | 115V       | 230V  | 200V    | 230V  | 460V  | 575V  | N.O.  | N.C. (1)  |            |
| 9                                   | 32   | 3  | 4        | 4    | 4    | 1/2        | 1-1/2 | 2       | 2     | 5     | 7-1/2 | 1   | 1   | 104-C09⊗22 |
| 12                                  | 32   | 4  | 5.5      | 5.5  | 5.5  | 1          | 2     | 3       | 3     | 7-1/2 | 10    | 1   | 1   | 104-C12⊗22 |
| 16                                  | 32   | 5.5  | 7.5      | 7.5  | 7.5  | 1          | 3     | 5       | 5     | 10    | 15    | 1   | 1   | 104-C16⊗22 |
| 23                                  | 32   | 7.5  | 11       | 13   | 10   | 2          | 3     | 5       | 7-1/2 | 15    | 20    | 1   | 1   | 104-C23⊗22 |
| 30                                  | 65   | 10   | 15       | 15   | 15   | 2          | 5     | 7-1/2   | 10    | 20    | 25    | 0   | 1   | 104-C30⊗02 |
|                                     |      |  |          |      |      |            |       |         |       |       |       | 1   | 1   | 104-C30⊗22 |
| 37                                  | 65   | 11   | 18.5/20  | 20   | 18.5 | 3          | 5     | 10      | 10    | 25    | 30    | 0   | 1   | 104-C37⊗02 |
|                                     |      |  |          |      |      |            |       |         |       |       |       | 1   | 1   | 104-C37⊗22 |
| 43                                  | 85   | 13   | 22       | 25   | 22   | 3          | 7.5   | 10      | 15    | 30    | 30    | 0   | 1   | 104-C43⊗02 |
|                                     |      |  |          |      |      |            |       |         |       |       |       | 1   | 1   | 104-C43⊗22 |
| 55                                  | 85   | 15   | 30       | 30   | 30   | 5          | 10    | 15      | 20    | 40    | 40    | 0   | 1   | 104-C55⊗02 |
|                                     |      |  |          |      |      |            |       |         |       |       |       | 1   | 1   | 104-C55⊗22 |
| 60                                  | 100  | 18.5   | 32       | 37   | 32   | 5          | 10    | 15      | 20    | 40    | 50    | 0   | 1   | 104-C60⊗02 |
|                                     |      |  |          |      |      |            |       |         |       |       |       | 1   | 1   | 104-C60⊗22 |
| 72                                  | 100  | 22   | 40       | 45   | 40   | 5          | 15    | 20      | 25    | 50    | 60    | 0   | 1   | 104-C72⊗02 |
|                                     |      |  |          |      |      |            |       |         |       |       |       | 1   | 1   | 104-C72⊗22 |
| 85                                  | 100  | 25   | 45       | 55   | 45   | 7-1/2      | 15    | 25      | 30    | 60    | 60    | 0   | 1   | 104-C85⊗02 |
|                                     |      |  |          |      |      |            |       |         |       |       |       | 1   | 1   | 104-C85⊗22 |
| 97                                  | 130  | 30   | 55       | 55   | 55   | 10         | 15    | 30      | 30    | 75    | 75    | 0   | 1   | 104-C97⊗02 |
|                                     |      |  |          |      |      |            |       |         |       |       |       | 1   | 1   | 104-C97⊗22 |

(1) The N.C. auxiliary contact is supplied as part of the mechanical/electrical interlock.

⊗ Coil voltage code and terminal position— see [page 19](#).

## Coil Voltage Codes

The Cat. No. as listed is incomplete. Select a coil voltage code from the table below to complete the Cat. No. Example: 120V, 60 Hz: Cat. No. 100-C09⊗10 becomes Cat. No.100-C09D10.

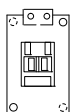
| AC Voltages [V] | 24 | 110 | 120 | 200... 220 | 208... 240 | 230 | 240 | 277 | 400... 415 | 440 | 480 |
|-----------------|----|-----|-----|------------|------------|-----|-----|-----|------------|-----|-----|
| 50 Hz           | —  | D   | —   | L          | —          | —   | T   | —   | G          | B   | —   |
| 60 Hz           | —  | —   | D   | —          | L          | —   | —   | T   | —          | G   | B   |
| 50/60 Hz        | KJ | —   | —   | —          | —          | KF  | —   | —   | —          | —   | —   |

| DC Voltages [V] |                                  | 12 | 24 | 36...48 | 48...72 | 72 | 110 | 110...125 | 220 | 220...250 |
|-----------------|----------------------------------|----|----|---------|---------|----|-----|-----------|-----|-----------|
| 100-C09...C55   | Electronic with Integrated Diode | EQ | EJ | EW      | EY      | —  | —   | ED        | —   | EA        |
| 100-C60...C97   | with Integrated Diode            | —  | DJ | —       | —       | DG | DD  | —         | DA  | —         |

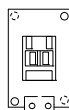
## Coil Terminal Position

All contactors are delivered with the coil terminals located on the line side.

For load-side coil terminations, insert a “U” prior to the coil voltage code. Ordering example: Cat. No. 100-C09UD10.



Cat. No.100-C09⊗10 Line Side



Cat. No.100-C09U⊗10 Load Side

# Assignment of Contacts

Table valid for: AC / DC = 0.85...1.1 x U<sub>s</sub>, T<sub>amb</sub> = -25 °C...+60 °C (-13...140 °F), normal position (horizontal rail mounting)

## Device Combinations in Accordance with IEC 60947-1 / -4-1

| Auxiliary Contact Blocks |         | 100-C Contactors (AC and DC Control)                     |  |  |  |  |  |  |
|--------------------------|---------|--|--|--|--|--|--|--|
| Circuit Diagram          | Control | 100-C09_⊗10<br>100-C12_⊗10<br>100-C16_⊗10<br>100-C23_⊗10 | 100-C09_⊗01<br>100-C12_⊗01<br>100-C16_⊗01<br>100-C23_⊗01 | 100-C30_⊗00<br>100-C37_⊗00<br>100-C43_⊗00<br>100-C55_⊗00<br>100-C60_⊗00<br>100-C72_⊗00<br>100-C85_⊗00<br>100-C97_⊗00 | 100-C09_⊗400<br>100-C12_⊗400<br>100-C16_⊗400<br>100-C23_⊗400<br>100-C40_⊗400<br>100-C90_⊗400 | 100-C09_⊗300<br>100-C12_⊗300<br>100-C16_⊗300<br>100-C23_⊗300 | 100-C09_⊗200<br>100-C12_⊗200<br>100-C16_⊗200<br>100-C23_⊗200<br>100-C40_⊗200<br>100-C90_⊗200 |  |
|                          |         |  |  |  |  |  |  |  |

### Side Mounting <sup>(1)</sup>

|                          |  |       |                               |                               |                |                |                |                |
|--------------------------|--|-------|-------------------------------|-------------------------------|----------------|----------------|----------------|----------------|
| 100-SB01                 |  | AC/DC | 10 + 01 = 11                  | 01 + 01 = 02 <sup>(2)</sup>   | 00 + 01 = 01   | 00 + 01 = 01   | 00 + 01 = 01   | 00 + 01 = 01   |
| 100-SB10                 |  | AC/DC | 10 + 10 = 20 <sup>(2)</sup>   | 01 + 10 = 11                  | 00 + 10 = 10   | 00 + 10 = 10   | 00 + 10 = 10   | 00 + 10 = 10   |
| 100-SB02                 |  | AC/DC | 10 + 02 = 12 <sup>(2)</sup>   | —                             | 00 + 02 = 02   | 00 + 02 = 02   | 00 + 02 = 02   | 00 + 02 = 02   |
| 100-SB11                 |  | AC/DC | 10 + 11 = 21 <sup>(2)</sup>   | 01 + 11 = 12 <sup>(2)</sup>   | 00 + 11 = 11   | 00 + 11 = 11   | 00 + 11 = 11   | 00 + 11 = 11   |
| 100-SB20                 |  | AC/DC | 10 + 20 = 30 <sup>(2)</sup>   | 01 + 20 = 21 <sup>(2)</sup>   | 00 + 20 = 20   | 00 + 20 = 20   | 00 + 20 = 20   | 00 + 20 = 20   |
| 100-SBL11 <sup>(3)</sup> |  | AC/DC | 10 + L11 = L21 <sup>(2)</sup> | 01 + L11 = L12 <sup>(2)</sup> | 00 + L11 = L11 | 00 + L11 = L11 | 00 + L11 = L11 | 00 + L11 = L11 |

(1) Up to 8 auxiliary contacts possible: contactor + front mounted (AC max. 4 N.C. / DC max. 4 N.C.), side mounted (AC max. 2 N.O. / DC max. 2 N.O. and max. 2 N.C.).

(2) Double numbering; because of double numbering only left-side mounting is recommended.

(3) Early make and/or late break.



Device Combinations in Accordance with IEC 60947-1 / -4-1

| Auxiliary Contact Blocks  |         | 100-C Contactors (AC and DC Control)                     |  |  |  |  |  |                |
|---------------------------|---------|--|--|--|--|--|--|----------------|
| Circuit Diagram           | Control | 100-C09_⊗10<br>100-C12_⊗10<br>100-C16_⊗10<br>100-C23_⊗10 | 100-C09_⊗01<br>100-C12_⊗01<br>100-C16_⊗01<br>100-C23_⊗01 | 100-C30_⊗00<br>100-C37_⊗00<br>100-C43_⊗00<br>100-C55_⊗00<br>100-C60_⊗00<br>100-C72_⊗00<br>100-C85_⊗00<br>100-C97_⊗00 | 100-C09_⊗400<br>100-C12_⊗400<br>100-C16_⊗400<br>100-C23_⊗400<br>100-C40_⊗400<br>100-C90_⊗400 | 100-C09_⊗300<br>100-C12_⊗300<br>100-C16_⊗300<br>100-C23_⊗300 | 100-C09_⊗200<br>100-C12_⊗200<br>100-C16_⊗200<br>100-C23_⊗200<br>100-C40_⊗200<br>100-C90_⊗200 |                |
|                           |         |  |  |  |  |  |  |                |
| <b>Front Mounting (1)</b> |         |  |  |  |  |  |  |                |
| 100-FA02,<br>100-FAB02    |         | AC/DC  | 10 + 02 = 12   | 01 + 02 = 03   | 00 + 02 = 02   | 00 + 02 = 02   | 00 + 02 = 02   | 00 + 02 = 02   |
| 100-FA11,<br>100-FAB11    |         | AC/DC  | 10 + 11 = 21   | 01 + 11 = 12   | 00 + 11 = 11   | 00 + 11 = 11   | 00 + 11 = 11   | 00 + 11 = 11   |
| 100-FB11,<br>100-FBB11    |         | AC/DC  | —  | —  | 00 + 11 = 11   | 00 + 11 = 11   | 00 + 11 = 11   | 00 + 11 = 11   |
| 100-FC11,<br>100-FCB11    |         | AC/DC  | 10 + 11 = 21   | —  | —  | —  | —  | —              |
| 100-FA20,<br>100-FAB20    |         | AC/DC  | 10 + 20 = 30   | 01 + 20 = 21   | 00 + 20 = 20   | 00 + 20 = 20   | 00 + 20 = 20   | 00 + 20 = 20   |
| 100-FBL11 (2)             |         | AC/DC  | —  | —  | 00 + L11 = L11   | 00 + L11 = L11   | 00 + L11 = L11   | 00 + L11 = L11 |
| 100-FA22,<br>100-FAB22    |         | AC/DC  | 10 + 22 = 32   | 01 + 22 = 23   | 00 + 22 = 22   | 00 + 22 = 22   | 00 + 22 = 22   | 00 + 22 = 22   |
| 100-FB22,<br>100-FBB22    |         | AC/DC  | —  | —  | 00 + 22 = 22   | 00 + 22 = 22   | 00 + 22 = 22   | 00 + 22 = 22   |
| 100-FC22,<br>100-FCB22    |         | AC/DC  | 10 + 22 = 32   | —  | —  | —  | —  | —              |
| 100-FA31,<br>100-FAB31    |         | AC/DC  | 10 + 31 = 41   | 01 + 31 = 32   | 00 + 31 = 31   | 00 + 31 = 31   | 00 + 31 = 31   | 00 + 31 = 31   |
| 100-FA40,<br>100-FAB40    |         | AC/DC  | 10 + 40 = 50   | 01 + 40 = 41   | 00 + 40 = 40   | 00 + 40 = 40   | 00 + 40 = 40   | 00 + 40 = 40   |
| 100-FAL22 (2)             |         | AC/DC  | 10 + L22 = L32   | 01 + L22 = L23   | 00 + L22 = L22   | 00 + L22 = L22   | 00 + L22 = L22   | 00 + L22 = L22 |
| 100-FA04,<br>100-FAB04    |         | AC/DC  | 10 + 04 = 14   | 01 + 04 = 05   | 00 + 04 = 04   | 00 + 04 = 04   | 00 + 04 = 04   | 00 + 04 = 04   |
| 100-FA13,<br>100-FAB13    |         | AC/DC  | 10 + 13 = 23   | 01 + 13 = 14   | 00 + 13 = 13   | 00 + 13 = 13   | 00 + 13 = 13   | 00 + 13 = 13   |

Device Combinations in Accordance with IEC 60947-1 / -4-1 (Continued)

| Auxiliary Contact Blocks |         | 100-C Contactors (AC and DC Control)                     |  |  |  |  |  |              |
|--------------------------|---------|--|--|--|--|--|--|--------------|
| Circuit Diagram          | Control | 100-C09_⊗10<br>100-C12_⊗10<br>100-C16_⊗10<br>100-C23_⊗10 | 100-C09_⊗01<br>100-C12_⊗01<br>100-C16_⊗01<br>100-C23_⊗01 | 100-C30_⊗00<br>100-C37_⊗00<br>100-C43_⊗00<br>100-C55_⊗00<br>100-C60_⊗00<br>100-C72_⊗00<br>100-C85_⊗00<br>100-C97_⊗00 | 100-C09_⊗400<br>100-C12_⊗400<br>100-C16_⊗400<br>100-C23_⊗400<br>100-C40_⊗400<br>100-C90_⊗400 | 100-C09_⊗300<br>100-C12_⊗300<br>100-C16_⊗300<br>100-C23_⊗300 | 100-C09_⊗200<br>100-C12_⊗200<br>100-C16_⊗200<br>100-C23_⊗200<br>100-C40_⊗200<br>100-C90_⊗200 |              |
|                          |         |  |  |  |  |  |  |              |
| 100-FB02,<br>100-FBB02   |         | AC/DC  | 10 + 02 = 12   | 01 + 02 = 03   | 00 + 02 = 02   | 00 + 02 = 02   | 00 + 02 = 02   | 00 + 02 = 02 |
| 100-FB20,<br>100-FBB20   |         | AC/DC  | 10 + 20 = 30   | 01 + 20 = 21   | 00 + 20 = 20   | 00 + 20 = 20   | 00 + 20 = 20   | 00 + 20 = 20 |
| 100-FC31,<br>100-FCB31   |         | AC/DC  | 10 + 31 = 41   | 01 + 31 = 32   | 00 + 31 = 31   | 00 + 31 = 31   | 00 + 31 = 31   | 00 + 31 = 31 |

(1) Up to 8 auxiliary contacts possible: contactor + front mounted (AC max. 4 N.C. / DC max. 4 N.C.), side mounted (AC max. 2 N.O. / DC max. 2 N.O. and max. 2 N.C.).  
 (2) Early make and/or late break.

# Product Selection—100S-C/104S-C Safety Contactors

- Mechanically linked N.C. auxiliary contacts
- Front-mounted auxiliary contacts
  - Gold bifurcated
  - Permanently fixed
  - “Mechanically Linked” or “Mirror Contact” symbol
- AC and DC operating coils
- SUVA Third-party certification
- Reversing contactors:
  - 3 Main contacts
  - Include reversing power wiring
- Include mechanical/electrical Interlock




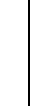
100S-C Safety Contactor



104S-C Reversing Safety Contactor

Bulletin 100S-C/104S-C safety contactors provide mechanically linked positively guided contacts, required in feedback circuits of modern safety applications. The mechanically linked N.C. auxiliary contacts do not change state when a power pole welds. In addition, the gold-plated bifurcated auxiliary contacts are ideally suited for low-energy applications or feedback control circuits with multiple series-connected N.C. auxiliary contacts.

## 3-Pole AC- and DC-operated Contactors

| Rated Operational Current $I_e$ [A] |      | Ratings for switching AC motors - AC-2, AC-3, AC-4 |          |      |      |            |       |                              |       |       |       | Auxiliary Contacts  |   | Cat. No. <sup>(1)</sup> <sup>(2)</sup> |
|-------------------------------------|------|--|----------|------|------|------------|-------|------------------------------|-------|-------|-------|---|---|--|
|                                     |      | 3-phase kW (50 Hz)                                 |          |      |      | Hp (60 Hz) |       |                              |       |       |       |  |  |  |
| 40 °C (104 °F)                      |      | 230V   | 400/415V | 500V | 690V | 1-Phase    |       | 3-Phase                      |       |       |       |   |   |  |
| AC-3                                | AC-1 |  |          |      |      | 115V       | 230V  | 200V                         | 230V  | 460V  | 575V  | N.O.  | N.C.  |  |
| 9                                   | 32   | 3  | 4        | 4    | 4    | 1/2        | 1-1/2 | 2                            | 2     | 5     | 7-1/2 | 0   | 5   | 100S-C09⊗05BC                          |
|                                     |      |  |          |      |      | 1          | 4     | 100S-C09⊗14BC                |       |       |       |   |   |  |
| 12                                  | 32   | 4  | 5.5      | 5.5  | 5.5  | 1/2        | 2     | 3                            | 3     | 7-1/2 | 10    | 0   | 5   | 100S-C12⊗05BC                          |
|                                     |      |  |          |      |      | 1          | 4     | 100S-C12⊗14BC                |       |       |       |   |   |  |
| 16                                  | 32   | 5.5  | 7.5      | 7.5  | 7.5  | 1          | 3     | 5                            | 5     | 10    | 15    | 0   | 5   | 100S-C16⊗05BC                          |
|                                     |      |  |          |      |      | 1          | 4     | 100S-C16⊗14BC                |       |       |       |   |   |  |
| 23                                  | 32   | 7.5  | 11       | 13   | 10   | 2          | 3     | 5                            | 7-1/2 | 15    | 15    | 0   | 5   | 100S-C23⊗05BC                          |
|                                     |      |  |          |      |      | 1          | 4     | 100S-C23⊗14BC                |       |       |       |   |   |  |
| 30                                  | 65   | 10   | 15       | 15   | 15   | 2          | 5     | 7-1/2                        | 10    | 20    | 25    | 0   | 4   | 100S-C30⊗04BC                          |
|                                     |      |  |          |      |      | 1          | 4     | 100S-C30⊗14BC                |       |       |       |   |   |  |
| 37                                  | 65   | 11   | 18.5/20  | 20   | 18.5 | 3          | 5     | 10                           | 10    | 25    | 30    | 0   | 4   | 100S-C37⊗04BC                          |
|                                     |      |  |          |      |      | 1          | 4     | 100S-C37⊗14BC                |       |       |       |   |   |  |
| 43                                  | 85   | 13   | 22       | 25   | 22   | 3          | 7-1/2 | 10                           | 15    | 30    | 30    | 0   | 4   | 100S-C43⊗04BC                          |
|                                     |      |  |          |      |      | 1          | 4     | 100S-C43⊗14BC                |       |       |       |   |   |  |
| 55                                  | 85   | 15   | 30       | 30   | 30   | 5          | 10    | 15                           | 20    | 40    | 40    | 0   | 4   | 100S-C55⊗04BC                          |
|                                     |      |  |          |      |      | 1          | 4     | 100S-C55⊗14BC                |       |       |       |   |   |  |
| 60                                  | 100  | 18.5   | 32       | 37   | 32   | 5          | 10    | 15                           | 20    | 40    | 50    | 0   | 4   | 100S-C60⊗04BC <sup>(3)</sup>           |
|                                     |      |  |          |      |      | 1          | 4     | 100S-C60⊗14BC <sup>(3)</sup> |       |       |       |   |   |  |
| 72                                  | 100  | 22   | 40       | 45   | 40   | 5          | 15    | 20                           | 25    | 50    | 60    | 0   | 4   | 100S-C72⊗04BC <sup>(3)</sup>           |
|                                     |      |  |          |      |      | 1          | 4     | 100S-C72⊗14BC <sup>(3)</sup> |       |       |       |   |   |  |
| 85                                  | 100  | 25   | 45       | 55   | 45   | 7-1/2      | 15    | 25                           | 30    | 60    | 60    | 0   | 4   | 100S-C85⊗04BC <sup>(3)</sup>           |
|                                     |      |  |          |      |      | 1          | 4     | 100S-C85⊗14BC <sup>(3)</sup> |       |       |       |   |   |  |
| 97                                  | 130  | 30   | 55       | 55   | 55   | 10         | 15    | 30                           | 30    | 75    | 75    | 0   | 4   | 100S-C97⊗04BC <sup>(3)</sup>           |
|                                     |      |  |          |      |      | 1          | 4     | 100S-C97⊗14BC <sup>(3)</sup> |       |       |       |   |   |  |





(1) For other contact configurations and full product details, please contact your local Rockwell Automation sales office or Allen-Bradley distributor.

(2) If standard cross-stamped front-mount auxiliary contacts are required, remove the letter “B” before the letter “C” in the cat. no. Example: Cat. No. 100S-C09⊗05BC becomes Cat. No. 100S-C09⊗05C.

(3) Front- and side-mount auxiliary contacts on Cat. Nos. 100S-C60...C97 conform to mirror contact performance only.

⊗ Coil voltage code and terminal position— see [page 26](#).



4-Pole AC- and DC-operated Contactors

| Rated Operational Current $I_e$ [A] |      | Ratings for Switching AC Motors   |           |      |      |            |       |                        |       |       |       | Contact Configuration   |   |   |   | Cat. No. <sup>(1) (2)</sup> |
|-------------------------------------|------|-----------------------------------|-----------|------|------|------------|-------|------------------------|-------|-------|-------|---|---|---|---|-----------------------------|
|                                     |      | AC-2, AC-3, AC-4                  |           |      |      | Hp (60 Hz) |       |                        |       |       |       | Main Pole   |   | Auxiliary Contacts  |   |                             |
|                                     |      | 3-Phase kW (50 Hz) <sup>(3)</sup> |           |      |      | 1-Phase    |       | 3-Phase <sup>(3)</sup> |       |       |       |  |  |  |  |                             |
| AC-3                                | AC-1 | 230V                              | 400V/415V | 500V | 690V | 115V       | 230V  | 200V                   | 230V  | 460V  | 575V  | N.O.  | N.C.  | N.O.  | N.C.  |                             |
| 9                                   | 32   | 3                                 | 4         | 4    | 4    | 1/2        | 1-1/2 | 2                      | 2     | 5     | 7-1/2 | 4   | 0   | 0   | 4   | 100S-C09⊗404BC              |
|                                     |      |                                   |           |      |      |            |       |                        |       |       |       |   |   |   |   | 3                           |
| 12                                  | 32   | 4                                 | 5.5       | 5.5  | 5.5  | 1/2        | 2     | 3                      | 3     | 7-1/2 | 10    | 4   | 0   | 0   | 4   | 100S-C12⊗404BC              |
|                                     |      |                                   |           |      |      |            |       |                        |       |       |       |   |   |   |   | 3                           |
| 16                                  | 32   | 5.5                               | 7.5       | 7.5  | 7.5  | 1          | 3     | 5                      | 5     | 10    | 15    | 4   | 0   | 0   | 4   | 100S-C16⊗404BC              |
|                                     |      |                                   |           |      |      |            |       |                        |       |       |       |   |   |   |   | 3                           |
| 23                                  | 32   | 7.5                               | 11        | 13   | 10   | 2          | 3     | 5                      | 7-1/2 | 15    | 15    | 4   | 0   | 0   | 4   | 100S-C23⊗404BC              |
|                                     |      |                                   |           |      |      |            |       |                        |       |       |       |   |   |   |   | 3                           |

- (1) For other contact configurations and full product details, please contact your local Rockwell Automation sales office or Allen-Bradley distributor.
- (2) If standard cross-stamped front-mount auxiliary contacts are required, remove the letter "B" before the letter "C" in the cat. no. Example: Cat. No. 100S-C09⊗404BC becomes Cat. No. 100S-C09⊗404C.
- (3) Three-phase ratings only apply to contactors with at least three N.O. power poles.

⊗ Coil voltage code and terminal position— see [page 26](#).

## Reversing AC- and DC-operated Contactors

| Rated Operational Current $I_e$ [A] |      | Ratings for switching AC motors - AC-2, AC-3, AC-4 |         |              |      |            |         |       |         |       |       | Auxiliary Contacts  |   | Cat. No. <sup>(1) (2)</sup>   |      |
|-------------------------------------|------|--|---------|--------------|------|------------|---------|-------|---------|-------|-------|---|---|-------------------------------|------|
|                                     |      | 3-phase kW (50 Hz)                                 |         |              |      | Hp (60 Hz) |         |       |         |       |       |  |  |                               |      |
| 40 °C (104 °F)                      | AC-3 | AC-1   | 230V    | 400/<br>415V | 500V | 690V       | 1-Phase |       | 3-Phase |       |       |   |   |                               | N.O. |
|                                     |      |  |         |              |      |            | 115V    | 230V  | 200V    | 230V  | 460V  | 575V  |   |                               |      |
| 9                                   | 32   | 3  | 4       | 4            | 4    | 1/2        | 1-1/2   | 2     | 2       | 5     | 7-1/2 | 0   | 6   | 104S-C09⊗012BC                |      |
|                                     |      |  |         |              |      |            |         |       |         |       |       | 1   | 5   | 104S-C09⊗210BC                |      |
| 12                                  | 32   | 4  | 5.5     | 5.5          | 5.5  | 1/2        | 2       | 3     | 3       | 7-1/2 | 10    | 0   | 6   | 104S-C12⊗012BC                |      |
|                                     |      |  |         |              |      |            |         |       |         |       |       | 1   | 5   | 104S-C12⊗210BC                |      |
| 16                                  | 32   | 5.5  | 7.5     | 7.5          | 7.5  | 1          | 3       | 5     | 5       | 10    | 15    | 0   | 6   | 104S-C16⊗012BC                |      |
|                                     |      |  |         |              |      |            |         |       |         |       |       | 1   | 5   | 104S-C16⊗210BC                |      |
| 23                                  | 32   | 7.5  | 11      | 13           | 10   | 2          | 3       | 5     | 7-1/2   | 15    | 15    | 0   | 6   | 104S-C23⊗012BC                |      |
|                                     |      |  |         |              |      |            |         |       |         |       |       | 1   | 5   | 104S-C23⊗210BC                |      |
| 30                                  | 65   | 10   | 15      | 15           | 15   | 2          | 5       | 7-1/2 | 10      | 20    | 25    | 0   | 5   | 104S-C30⊗010BC                |      |
|                                     |      |  |         |              |      |            |         |       |         |       |       | 1   | 5   | 104S-C30⊗210BC                |      |
| 37                                  | 65   | 11   | 18.5/20 | 20           | 18.5 | 3          | 5       | 10    | 10      | 25    | 30    | 0   | 5   | 104S-C37⊗010BC                |      |
|                                     |      |  |         |              |      |            |         |       |         |       |       | 1   | 5   | 104S-C37⊗210BC                |      |
| 43                                  | 85   | 13   | 22      | 25           | 22   | 3          | 7-1/2   | 10    | 15      | 30    | 30    | 0   | 5   | 104S-C43⊗010BC                |      |
|                                     |      |  |         |              |      |            |         |       |         |       |       | 1   | 5   | 104S-C43⊗210BC                |      |
| 55                                  | 85   | 15   | 30      | 30           | 30   | 5          | 10      | 15    | 20      | 40    | 40    | 0   | 5   | 104S-C55⊗010BC                |      |
|                                     |      |  |         |              |      |            |         |       |         |       |       | 1   | 5   | 104S-C55⊗210BC                |      |
| 60                                  | 100  | 18.5   | 32      | 37           | 32   | 5          | 10      | 15    | 20      | 40    | 50    | 0   | 5   | 104S-C60⊗010BC <sup>(4)</sup> |      |
|                                     |      |  |         |              |      |            |         |       |         |       |       | 1   | 5   | 104S-C60⊗210BC <sup>(4)</sup> |      |
| 72                                  | 100  | 22   | 40      | 45           | 40   | 5          | 15      | 20    | 25      | 50    | 60    | 0   | 5   | 104S-C72⊗010BC <sup>(4)</sup> |      |
|                                     |      |  |         |              |      |            |         |       |         |       |       | 1   | 5   | 104S-C72⊗210BC <sup>(4)</sup> |      |
| 85                                  | 100  | 25   | 45      | 55           | 45   | 7-1/2      | 15      | 25    | 30      | 60    | 60    | 0   | 5   | 104S-C85⊗010BC <sup>(4)</sup> |      |
|                                     |      |  |         |              |      |            |         |       |         |       |       | 1   | 5   | 104S-C85⊗210BC <sup>(4)</sup> |      |
| 97                                  | 130  | 30   | 55      | 55           | 55   | 10         | 15      | 30    | 30      | 75    | 75    | 0   | 5   | 104S-C97⊗010BC <sup>(4)</sup> |      |
|                                     |      |  |         |              |      |            |         |       |         |       |       | 1   | 5   | 104S-C97⊗210BC <sup>(4)</sup> |      |

(1) For other contact configurations and full product details, please contact your local Rockwell Automation sales office or Allen-Bradley distributor.

(2) If standard cross-stamped front-mount auxiliary contacts are required, remove the letter "B" before the letter "C" in the cat. no. Example: Cat. No. 104S-C09⊗05BC becomes Cat. No. 104S-C09⊗05C.

(3) One of the N.C. auxiliary contacts is supplied as part of the mechanical/electrical interlock.

(4) Front- and side-mount auxiliary contacts on Cat. Nos. 104S-C60...C97 conform to mirror contact performance only.

⊗ Coil voltage code and terminal position— see [page 26](#).

## Coil Voltage Codes

The Cat. No. as listed is incomplete. Select a coil voltage code from the table below to complete the Cat. No. Example: 120V, 60 Hz: Cat. No. 100S-C09⊗05BC becomes Cat. No.100S-C09D05BC.

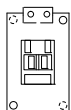
| AC Voltages [V] | 24 | 110 | 120 | 200... 220 | 208... 240 | 230 | 240 | 277 | 400... 415 | 440 | 480 |
|-----------------|----|-----|-----|------------|------------|-----|-----|-----|------------|-----|-----|
| 50 Hz           | —  | D   | —   | L          | —          | —   | T   | —   | G          | B   | —   |
| 60 Hz           | —  | —   | D   | —          | L          | —   | —   | T   | —          | G   | B   |
| 50/60 Hz        | KJ | —   | —   | —          | —          | KF  | —   | —   | —          | —   | —   |

| DC Voltages [V] |                                  | 12 | 24 | 36...48 | 48...72 | 72 | 110 | 110...125 | 220 | 220...250 |
|-----------------|----------------------------------|----|----|---------|---------|----|-----|-----------|-----|-----------|
| 100S-C09...C55  | Electronic with Integrated Diode | EQ | EJ | EW      | EY      | —  | —   | ED        | —   | EA        |
| 100S-C60...C97  | with Integrated Diode            | —  | DJ | —       | —       | DG | DD  | —         | DA  | —         |

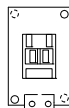
## Coil Terminal Position

All contactors are delivered with the coil terminals located on the line side.

For load side coil terminations, insert a "U" prior to the coil voltage code. Ordering example: Cat. No. 100S-C09UD05BC.



Cat. No.100S-C09⊗05CLine Side



Cat. No.100S-C09U⊗05CLoad Side

## Assignment of Contacts

Figure 5 - Safety Contactors with 3 Main Contacts and Standard Front-mount Auxiliary Contacts

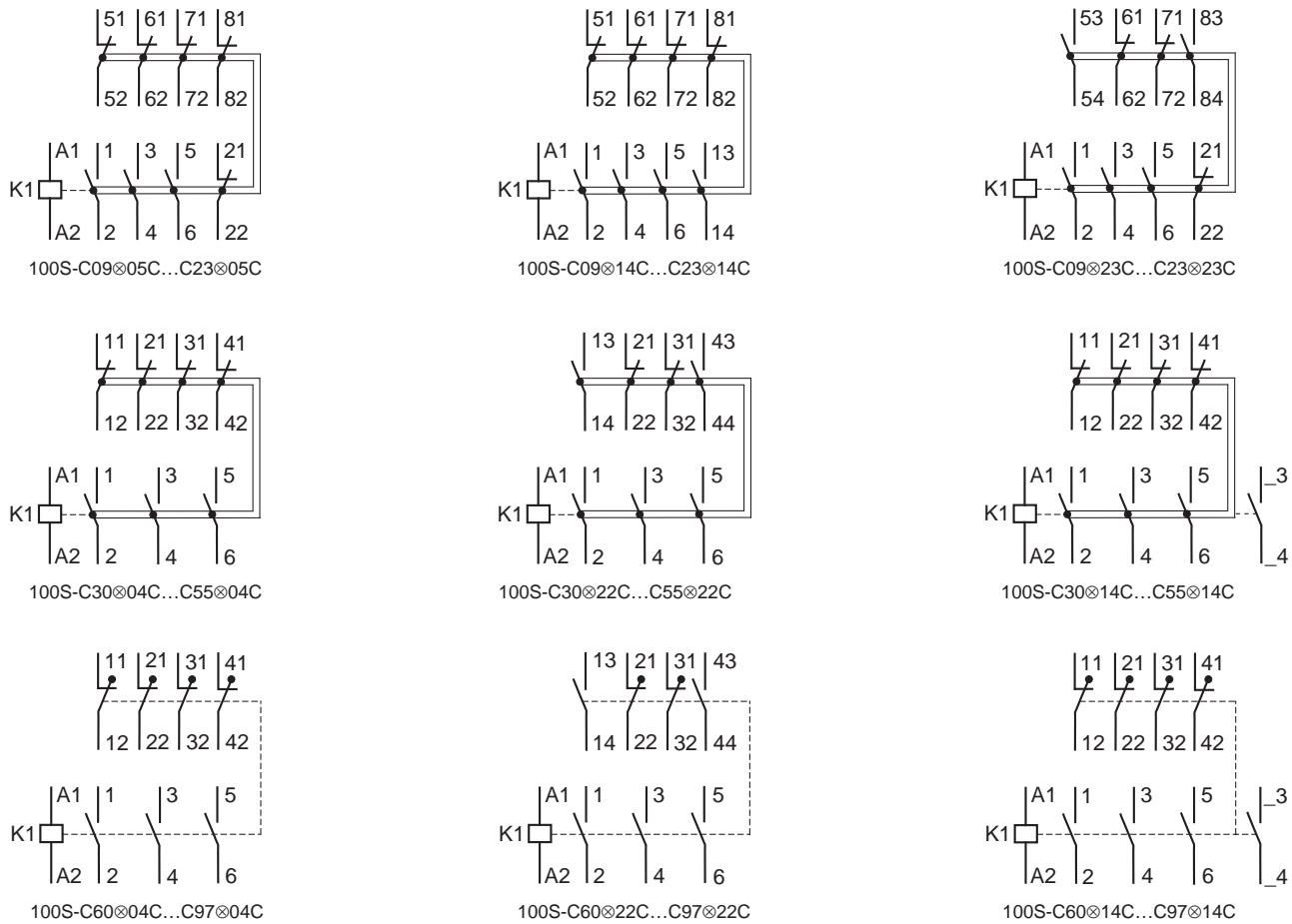


Figure 6 - Safety Contactors with 4 Main Contacts and Standard Front-mount Auxiliary Contacts

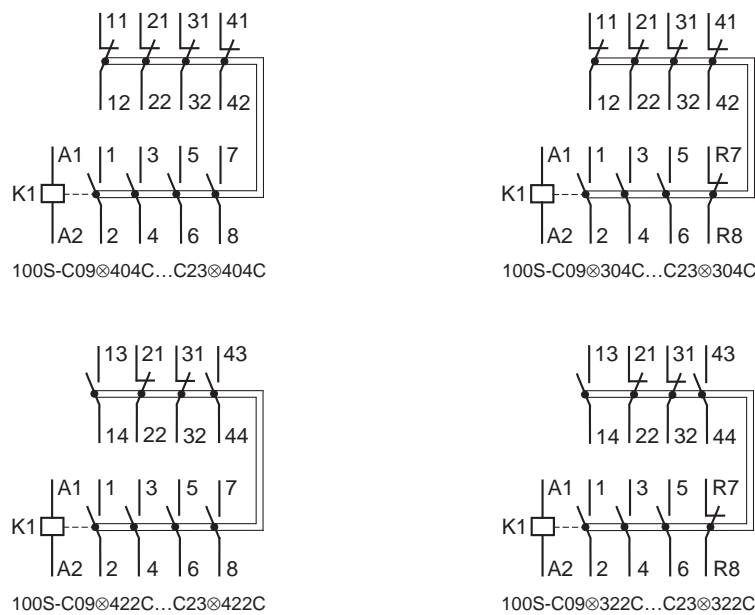


Figure 7 - Safety Reversing Contactors with 3 Main Contacts and Standard Front-mount Auxiliary Contacts

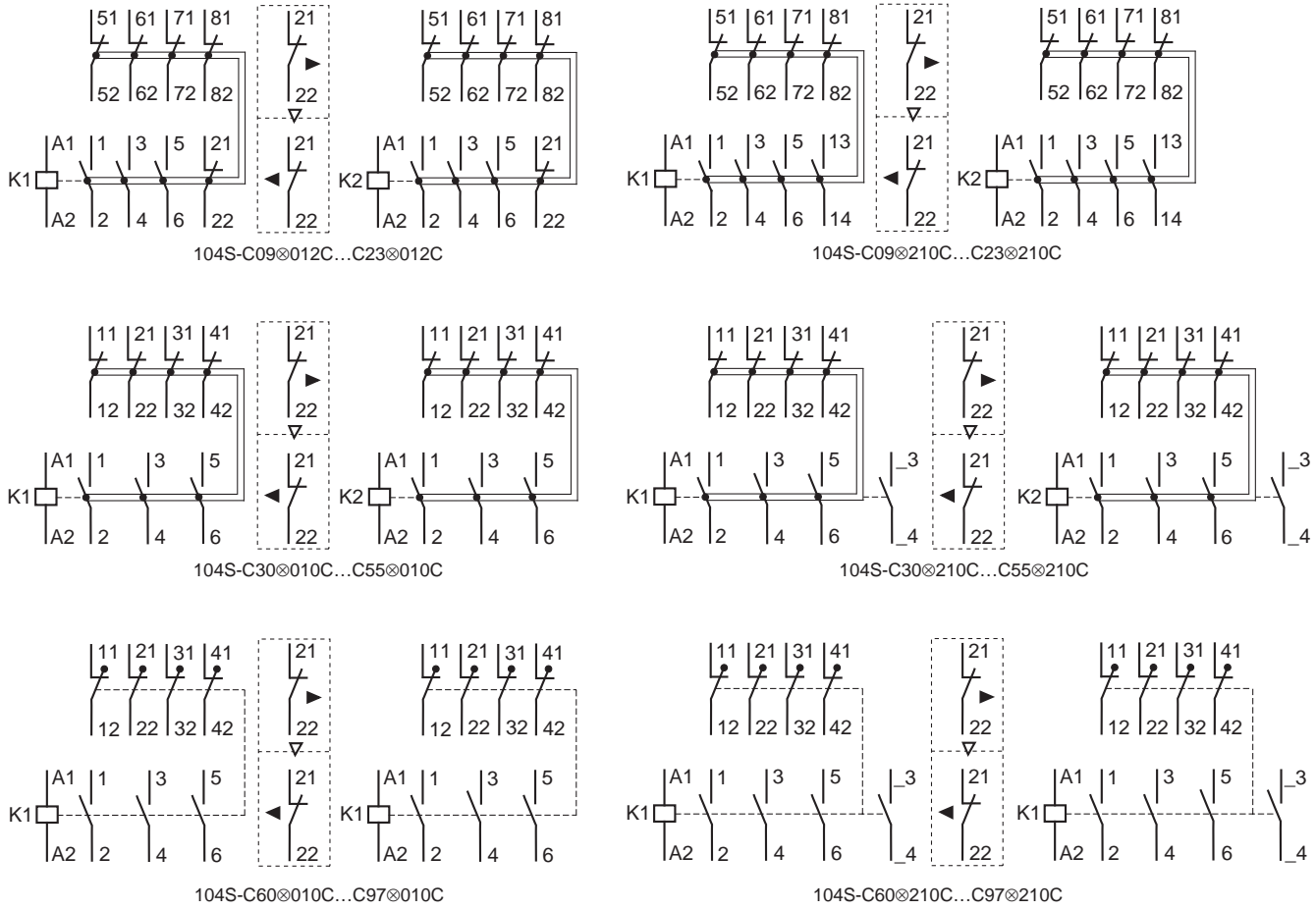
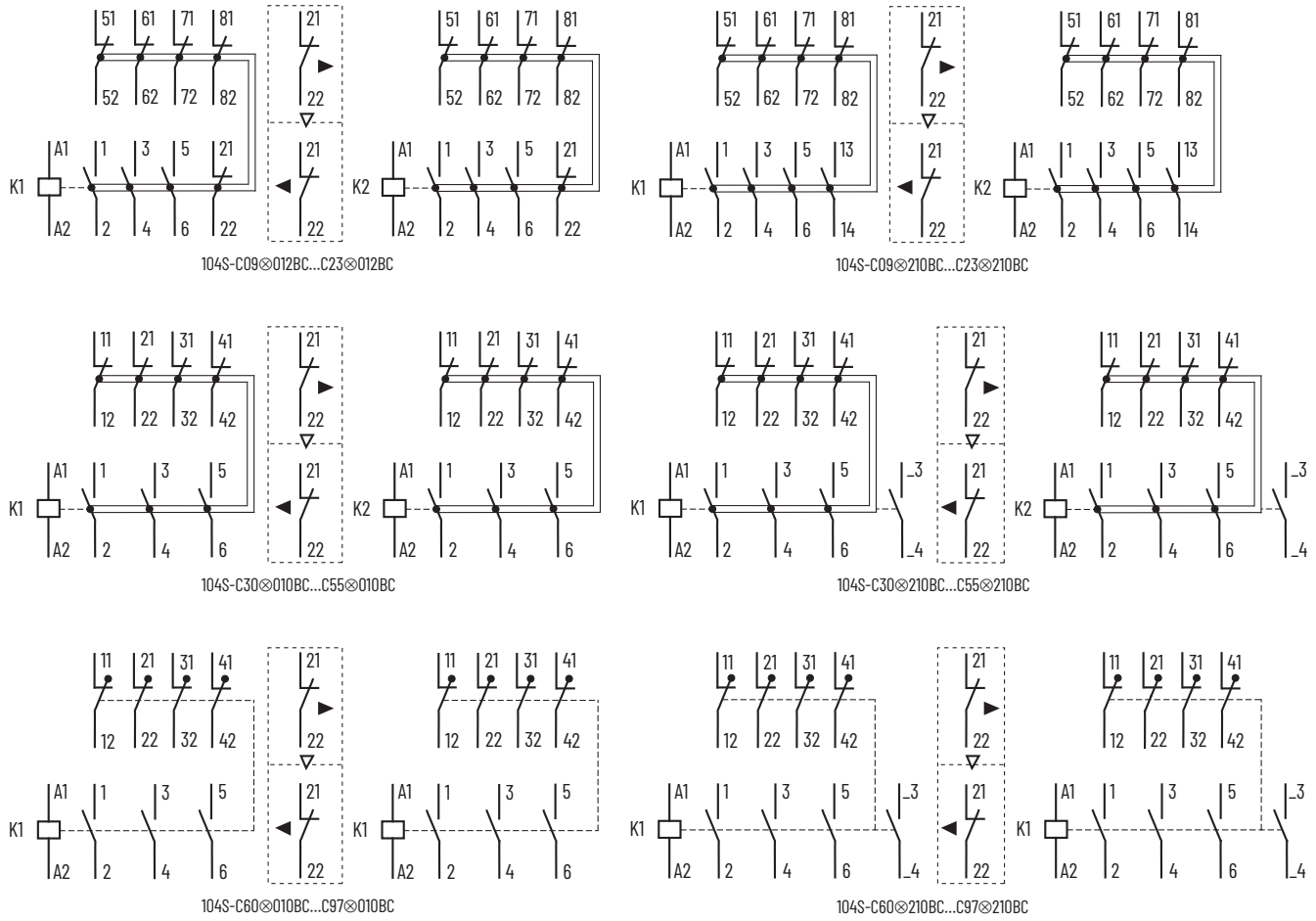





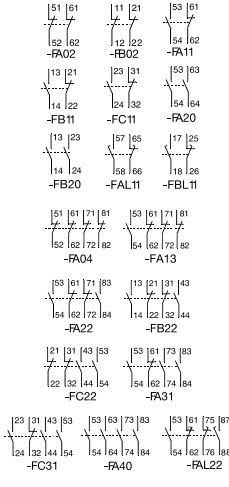

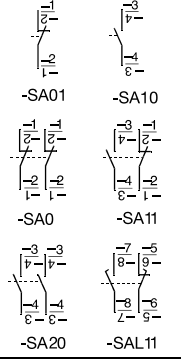

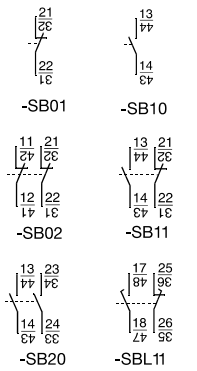


Figure 10 - Safety Reversing Contactors with 3 Main Contacts and Bifurcated Front-mount Auxiliary Contacts



# Accessories











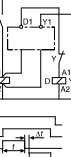




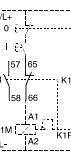
## Auxiliary Contact Blocks

|   | Description <sup>(1)</sup>  | Connection Diagrams |      |           | For Use With    | Cat. No.                                  |                              |           |           |
|---|---|---------------------|------|-----------|-----------------|---|------------------------------|-----------|-----------|
|   |   |                     | N.O. | N.C.      |                 | Standard Auxiliary Contact <sup>(2)</sup> | Bifurcated Auxiliary Contact |           |           |
|  <p><b>Auxiliary Contact Blocks for Front Mounting</b></p> <ul style="list-style-type: none"> <li>• 2- and 4-pole</li> <li>• Quick and easy mounting without tools</li> <li>• Electronic-compatible contacts down to 17V, 5mA</li> <li>• Mechanically linked performance between N.O. and N.C. poles and to the main contactor poles (except for L types)</li> <li>• Models with equal function with several terminal numbering choices</li> <li>• 1L = Late break N.C. / early make N.O.</li> <li>• Bifurcated version for switching down to 5V, 3 mA also available</li> </ul> |    | 0                   | 2    | 100-C all | 100-FA02        | 100-FAB02                                 |                              |           |           |
|   |   |                     |      |           |                 | C30⊗00...C97⊗00                           | 100-FB02                     | 100-FBB02 |           |
|   |   |                     |      |           |                 | 100-C all                                 | 100-FA11                     | 100-FAB11 |           |
|   |   |                     |      |           |                 | C30⊗00...C97⊗00                           | 100-FB11                     | 100-FBB11 |           |
|   |   |                     |      |           |                 | C09⊗10...C23⊗10                           | 100-FC11                     | 100-FCB11 |           |
|   |   |                     |      |           |                 | 100-C all                                 | 100-FA20                     | 100-FAB20 |           |
|   |   |                     |      |           |                 | C30⊗00...C97⊗00                           | 100-FB20                     | 100-FBB20 |           |
|   |   |                     |      |           | 1L              | 1L  | 100-C all                    | 100-FAL11 | —         |
|   |   |                     |      |           |                 |   | C30⊗00...C97⊗00              | 100-FBL11 | —         |
|   |   |                     |      |           |                 |   | 100-C all                    | 100-FA04  | 100-FAB04 |
|   |   |                     |      |           |                 |   | 100-C all                    | 100-FA13  | 100-FAB13 |
|   |   |                     |      |           |                 |   | 100-C all                    | 100-FA22  | 100-FAB22 |
|   |   |                     |      |           |                 |   | C30⊗00...C97⊗00              | 100-FB22  | 100-FBB22 |
|   |   |                     |      |           |                 |   | C09⊗10...C23⊗10              | 100-FC22  | 100-FCB22 |
|   |   |                     |      |           |                 |   | 100-C all                    | 100-FA31  | 100-FAB31 |
|   |   |                     |      |           | C09⊗10...C23⊗10 | 100-FC31                                  | 100-FCB31                    |           |           |
|   |   |                     |      |           | 100-C all       | 100-FA40                                  | 100-FAB40                    |           |           |
|   |   |                     | 1+1L | 1+1L      | 100-C all       | 100-FAL22                                 | —                            |           |           |
|  <p><b>Auxiliary Contact Blocks for Side Mounting without Sequence Terminal Designations</b></p> <ul style="list-style-type: none"> <li>• 1- and 2-pole</li> <li>• Two-way numbering for right or left mounting on the contactor</li> <li>• Quick and easy mounting without tools</li> <li>• Electronic-compatible contacts down to 17V, 10 mA</li> <li>• Mirror contact performance to the main contactor poles</li> <li>• 1L = Late break N.C. / early make N.O.</li> </ul>  |  | 0                   | 1    | 100-C all | 100-SA01        | —   |                              |           |           |
|   |   |                     |      |           |                 | 100-C all                                 | 100-SA10                     | —         |           |
|   |   |                     |      |           |                 | 100-C all                                 | 100-SA02                     | —         |           |
|   |   |                     |      |           |                 | 100-C all                                 | 100-SA11                     | —         |           |
|   |   |                     |      |           |                 | 100-C all                                 | 100-SA20                     | —         |           |
|   |   |                     |      |           | 1L              | 1L  | 100-C all                    | 100-SAL11 | —         |
|   |   |                     |      |           |                 |   | 100-C all                    | 100-SAL11 | —         |
|  <p><b>Auxiliary Contact Blocks for Side Mounting with Sequence Terminal Designations</b></p> <ul style="list-style-type: none"> <li>• 1- and 2-pole</li> <li>• Two-way numbering for right or left mounting on the contactor</li> <li>• Quick and easy mounting without tools</li> <li>• Electronic-compatible contacts down to 17V, 10 mA</li> <li>• Mirror contact performance to the main contactor poles</li> <li>• 1L = Late break N.C. / early make N.O.</li> </ul>   |  | 0                   | 1    | 100-C     | 100-SB01        | —   |                              |           |           |
|   |   |                     |      |           |                 | 100-C <sup>(3)</sup>                      | 100-SB10                     | —         |           |
|   |   |                     |      |           |                 | 100-C <sup>(3)</sup>                      | 100-SB02                     | —         |           |
|   |   |                     |      |           |                 | 100-C <sup>(3)</sup>                      | 100-SB11                     | —         |           |
|   |   |                     |      |           |                 | 100-C <sup>(3)</sup>                      | 100-SB20                     | —         |           |
|   |   |                     |      |           | 1L              | 1L  | 100-C <sup>(3)</sup>         | 100-SBL11 | —         |
|   |   |                     |      |           |                 |   | 100-C <sup>(3)</sup>         | 100-SBL11 | —         |

(1) Max. number of auxiliary contacts that may be mounted:  
 AC and 24V DC electronic coil contactors—max. 4 N.O. contacts on the front of the contactor, 2 N.O. contacts on the side, 4 N.C. front or side, 6 total. DC Coil contactors—max. 4 N.O. contacts on the front of the contactor or max. 2 N.O. contacts on the side, 4 N.C. front or side, 4 total.  
 (2) For screwless terminals (front mount only), insert "CR" after the "100-" in the catalog number. Example: Cat. No. 100-FA02 becomes Cat. No. 100-CRFA02.  
 (3) Double numbering—Left-side mounting only is recommended for Cat. No. 100-C09...100-C23 due to double numbering.

# Control Modules

## Timers

|   |   | Description   | Connection Diagrams   | For Use With  | Cat. No.  |   |              |
|---|---|---|---|---|---|---|--------------|
|    | On-Delay  | Pneumatic Timing Modules<br>• Pneumatic timing element contacts switch after the delay time. The contacts on the main control relay continue to operate without delay   | 0.3...30 s  |    | 100-C or 700-CF with AC or 24V DC electronic coils <sup>(1)</sup>                     | 100-FPTA30                                    |              |
|   |   |   | 2...180 s   |   |   | 100-FPTA180                                   |              |
|   | Off-Delay   | Pneumatic Timing Modules<br>• Pneumatic timing element contacts switch after the delay time. The contacts on the main control relay continue to operate without delay   | 0.3...30 s  |    | 100-C all, 700-CF all   | 100-FPTB30                                    |              |
|   |   |   | 2...180 s   |   |   | 100-FPTB180                                   |              |
|    | On-delay  | Electronic Timing Modules – On-delay<br>• Delay of the contactor or control relay solenoid. The contactor or control relay is energized at the end of the delay time.   | 0.1...3 s   |    | 100-C or 700-CF with 110...240V, 50/60Hz coils  | 100-ETA3                                      |              |
|   |   |   | 1...30 s  |   |   | 100-ETA30                                     |              |
|   |   |   | 10...180 s  |   |   | 100-ETA180                                    |              |
|   | On-delay  |   | Electronic Timing Modules – On-delay<br>• Delay of the contactor or control relay solenoid. The contactor or control relay is energized at the end of the delay time.   | 0.1...3 s   |    | 100-C or 700-CF with 24VDC coils              | 100-ETAZJ3   |
|   |   |   |   | 1...30 s  |   |   | 100-ETAZJ30  |
|   |   |   |   | 10...180 s  |   |   | 100-ETAZJ180 |
|   | Off-delay   | Electronic Timing Modules – Off-delay<br>• Delay of the contactor or control relay solenoid. After interruption of the control signal, the contactor or control relay is de-energized at the end of the delay time.   |   | 0.3...3 s   |    | 100-C09...C37 or 700-CF with 24V 50/60Hz      | 100-ETBKJ3   |
|   |   |   |   | 1...30 s  |   |   | 100-ETBKJ30  |
|   |   |   |   | 10...180 s  |   |   | 100-ETBKJ180 |
|   | Off-delay   |   | Electronic Timing Modules – Off-delay<br>• Delay of the contactor or control relay solenoid. After interruption of the control signal, the contactor or control relay is de-energized at the end of the delay time. | 0.3...3 s   |   | 100-C or 700-CF with 110...240V 50/60Hz coils | 100-ETB3     |
|   |   |   |   | 1...30 s  |   |   | 100-ETB30    |
|   |   |   |   | 10...180 s  |   |   | 100-ETB180   |
|  | Transition Time Y   | Electronic Timing Modules<br>• Delay of the contactor solenoid. Contactor K 3(Y) is de-energized (off) and K 2 (Δ) is energized (on) after the end of the set Y end time. (Switching delay at 50 ms.)<br>• Continuous adjustment range<br>• High repeat   |   | 1...30 s  |  | 100-C with 110...240V 50/60Hz coils           | 100-ETY30    |
|  | Mechanical only, without auxiliary contacts                     | Mechanical Interlocks<br>• For interlocking of two contactors.<br>• Common interlock for most Bul. 100-C contactor sizes<br>• Interlocking of different sizes possible<br>• Mechanical and electrical interlocking possible in one module by means of integrated auxiliary contacts<br>• 9 mm dovetail connector included |   |   |  | 100-C (except 100-C40, -C90)                  | 100-MCA00    |
|   | Mechanical/ electrical interlock with 2 N.C. auxiliary contacts |   |   |  | 100-C (except 100-C40, -C90)  | 100-MCA02                                     |              |
|  | Maximum command duration 0.03...10 s                            | Mechanical Latch<br>• Following contactor latching, the contactor coil is immediately de-energized (off) by the N.C. auxiliary contact (65-66).<br>• Electrical or manual release<br>• 1 N.O. + 1 N.C. auxiliary contacts<br>• Suitable for all Bul. 100-C contactor sizes, 9...97 A                                      |   |  | 100-C with AC or 24V DC electronic coils (except 100-C90)                             | 100-FL11⊗                                     |              |


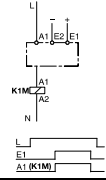

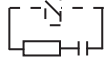
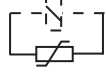
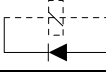
(1) Cannot be used with side-mounted auxiliary contacts on 700-CF DC relays.

**Coil Voltage Code:** The Cat. No. as listed is incomplete. Select a coil voltage code from the table below to complete the Cat. No. Example: 120V, 60 Hz: Cat. No. 100-FL11⊗ becomes Cat. No.100-FL11D

| AC Voltages [V] <sup>(1)</sup> | 24 | 48 | 100 | 110 | 120 | 230...240 | 240 | 277 | 380...400 | 400...415 | 440 | 480 |
|--------------------------------|----|----|-----|-----|-----|-----------|-----|-----|-----------|-----------|-----|-----|
| 50 Hz                          | K  | Y  | KP  | D   | —   | VA        | KA  | —   | N         | G         | B   | —   |
| 60 Hz                          | J  | —  | —   | —   | D   | —         | KA  | T   | —         | —         | N   | B   |


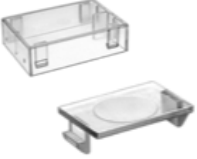


(1) For special voltages, consult your local Rockwell Automation sales office or Allen-Bradley distributor.

**Additional Control Modules**

|   | Description  |                                     | Voltage Range                                | Connection Diagrams   | For Use With  | Cat. No.  |                           |
|---|--|-------------------------------------|--|---|---|---|---------------------------|
|  | DC Interface (Electronic) <ul style="list-style-type: none"> <li>Interface between the DC control signal (PLC) and the AC operating mechanism of the contactor.</li> <li>Requires no additional surge suppression on the relay coils.</li> </ul>   |                                     | Input: 12V DC<br>Output: 110...240V AC       |  | 100-C with AC coils<br>110...240V AC  | 100-JE12  |                           |
|   |  |                                     | Input: 18...30V DC<br>Output: 110...240V AC  |   |   | 100-JE  |                           |
|   |  |                                     | Input: 48V DC<br>Output: 110...240V AC       |   |   | 100-JE48  |                           |
|  | Surge Suppressors <ul style="list-style-type: none"> <li>For limitation of coil switching transients.</li> <li>Plug-in, coil mounted.</li> <li>Suitable for 100-C contactor sizes, 9...97 A.</li> <li>RC, varistor, and diode versions.</li> </ul> | RC Module<br>AC operating mechanism | 24...48V AC, 50/60 Hz                        |  | 100-C with Coils  | 100-FSC48 <sup>(1)</sup>                            |                           |
|   |  |                                     | 110...280V AC, 50/60 Hz                      |   |   | 100-FSC280 <sup>(1)</sup>                           |                           |
|   |  |                                     | 380...480V AC, 50/60 Hz                      |   |   | 100-FSC480 <sup>(1)</sup>                           |                           |
|   |  |                                     | Varistor Module<br>AC/DC operating mechanism | 12...55V AC, 12...77V DC  |  | 100-C with AC coils or 100-C09...-C43 with DC coils | 100-FSV55 <sup>(1)</sup>  |
|   |  |                                     |  | 56...136V AC/78...180V DC   |   |   | 100-FSV136 <sup>(1)</sup> |
|   |  |                                     |  | 137...277V AC/ 181...350V DC  |   |   | 100-FSV277 <sup>(1)</sup> |
|   |  |                                     |  | 278...575V AC   |   |   | 100-FSV575 <sup>(1)</sup> |
|   |  |                                     | Diode Module<br>DC operating mechanism       | 1...30 s<br>10...180 s  |  | 100-C09...-C43 with DC coils                        | 100-FSD250 <sup>(1)</sup> |

(1) For screwless terminals, insert "CR" after the "100-" in the catalog number. Example: Cat No. 100-FSC48 becomes Cat. No.-CRFSC48.

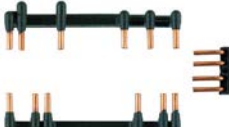
**Assembly Components (For 100-C09...C97 contactors)**

|   | Description   | For Use With                  | Pkg. Qty. | Cat. No. |
|---|---|-------------------------------|-----------|----------|
|  | Dovetail Connectors <ul style="list-style-type: none"> <li>For use in contactor and starter assemblies</li> <li>Single Connector – 0 mm spacing</li> </ul>  | 100-C                         | 10        | 100-S0   |
|   | Dovetail Connectors <ul style="list-style-type: none"> <li>For use in contactor and starter assemblies</li> <li>Single Connector – 9 mm spacing</li> </ul>  |                               | 10        | 100-S9   |
|  | Protective Covers <ul style="list-style-type: none"> <li>Provides protection against unintended manual operation</li> <li>For contactors and front-mounted auxiliary contacts, pneumatic timers, and latches</li> </ul> | 100-C all                     | 1         | 100-SCCA |
|   |   | 100-FA, -FB, -FC, -FP, -FL    | 10        | 100-SCFA |
|  | Reversing Power Wiring Kits <ul style="list-style-type: none"> <li>For reversing connection with a solid-state or thermal overload relay</li> </ul>   | 100-C09...C23                 | 1         | 105-PW23 |
|   |   | 100-C30...C37                 | 1         | 105-PW37 |
|   |   | 100-C43...C55                 | 1         | 105-PW55 |
|   |   | 100-C60...C97                 | 1         | 105-PW85 |
|  | DIN (#3) symmetrical hat rail <ul style="list-style-type: none"> <li>35 x 7.5 x 1 m</li> </ul>  | 140M-D<br>140M-F<br>100-C all | 10        | 199-DR1  |





## Wye-Delta/Star-Delta Starter Kits

Wye-Delta power wiring kits are designed to aid in the field assembly of open-transition Wye-delta starters that use Bulletin 100-C contactors. These kits include line, load, and start-point (shorting) connections. Assembling a Wye-delta starter requires the following additional components:

- Contactors
- Overload Relay
- Cat. No. 100-MCA02 Mechanical/Electrical Interlock
- Cat. No. 100-ETY30 Electronic Y-ΔTimer
- Cat. No. 100-S9 Base Coupler for 1M to 2M contactor (optional)






|   | 3-Phase Rating |          |      |      |            |      |      |      |                        |     |     | Pkg Qty. | Cat. No. |
|---|----------------|----------|------|------|------------|------|------|------|------------------------|-----|-----|----------|----------|
|   | kW (50 Hz)     |          |      |      | Hp (60 Hz) |      |      |      | Use with Cat. No. 100- |     |     |          |          |
|   | 230V           | 380/415V | 500V | 690V | 200V       | 230V | 460V | 575V | Delta                  |     | Wye |          |          |
|   |                |          |      |      |            |      |      |      | 1M                     | 2M  | 1S  |          |          |
|  | 5.5            | 7.5      | 7.5  | 7.5  | 5          | 5    | 10   | 10   | C09                    | C09 | C09 | 1        | 170-PW23 |
|   | 7.5            | 11       | 11   | 10   | 5          | 7.5  | 15   | 15   | C12                    | C12 | C09 | 1        | 170-PW23 |
|   | 10             | 15       | 15   | 13   | 7.5        | 10   | 20   | 20   | C16                    | C16 | C12 | 1        | 170-PW23 |
|   | 13             | 22       | 22   | 18.5 | 7.5        | 10   | 25   | 25   | C23                    | C23 | C12 | 1        | 170-PW23 |
|   | 17             | 25       | 25   | 25   | 10         | 15   | 30   | 30   | C30                    | C30 | C16 | 1        | 170-PW37 |
|   | 20             | 37       | 32   | 32   | 15         | 20   | 40   | 40   | C37                    | C37 | C23 | 1        | 170-PW37 |
|   | 22             | 40       | 40   | 40   | 20         | 25   | 50   | 50   | C43                    | C43 | C30 | 1        | 170-PW55 |
|   | 30             | 45       | 45   | 45   | 25         | 30   | 60   | 60   | C55                    | C55 | C37 | 1        | 170-PW55 |
|   | 32             | 55       | 55   | 55   | 30         | 40   | 75   | 75   | C60                    | C60 | C37 | 1        | 170-PW72 |
|   | 40             | 63       | 63   | 63   | 40         | 50   | 100  | 100  | C72                    | C72 | C43 | 1        | 170-PW72 |
|   | 50             | 80       | 80   | 80   | 50         | 60   | 125  | 125  | C85                    | C85 | C60 | 1        | 170-PW85 |
| 50  | 90             | 90       | 90   | 50   | 60         | 125  | 125  | C97  | C97                    | C60 | 1   | 170-PW85 |          |

### Marking Systems (For 100-C09...C97 contactors)

|   | Description  | Pkg. Qty. <sup>(1)</sup> | Cat. No.       |
|---|--|--------------------------|----------------|
|  | Adhesive labels <ul style="list-style-type: none"> <li>• Each label 6 x 17 mm (0.236 x 0.67 in)</li> <li>• White, halogen-free polyester, with acrylate adhesive</li> <li>• Ambient temperature range -40...+120 °C (-40...+248 °F)</li> <li>• Qty: 3000/roll</li> </ul> | 1                        | 1492-MDM6X17-W |
|  | Label Sheet <ul style="list-style-type: none"> <li>• 105 self-adhesive paper labels each, 6 x 17 mm</li> </ul>   | 10                       | 100-FMS        |
|  | Marking Tag Sheet <ul style="list-style-type: none"> <li>• 106 perforated paper labels each, 6 x 17 mm, to be used with a transparent cover</li> </ul>   | 10                       | 100-FMP        |
|   | Transparent Cover <ul style="list-style-type: none"> <li>• To be used with marking tag sheets</li> </ul>   | 100                      | 100-FMC        |
|  | Marking Tag Adapters <ul style="list-style-type: none"> <li>• To be used with 1492W marking tag system</li> </ul>  | 100                      | 100-FMA2       |


(1) Must be ordered in multiples of package quantities

**Terminal Kits (For 100-C09...C97 contactors)**

|  | Description   | Max. Current Ratings and Wire Sizes          |  | Pkg. Qty <sup>(1)</sup> | Cat. No.  |
|--|---|--|--|-------------------------|-----------|
|   | Stab Connector Kit<br>• Dual stab (0.250 in.) for 100-C coil terminals<br>• For 100-C09...C97 contactors  |  |  | 20                      | 199-SC2   |
|   | Stab Connector Kit<br>• Dual stab (0.250 in.) for 100-C power terminals<br>• For 100-C09...C23 contactors |  |  | 100                     | 199-SC10  |
|   | 3-Pole Terminal Lug Kit<br>• For Cat. No. 100-C09...C23 (Line side)                                       | IEC @ 40 °C<br>IEC @ 40 °C<br>UL/CSA (Encl.) | 45 A (4...16 mm <sup>2</sup> , fine stranded w/ ferrule) <sup>(2)</sup><br>45 A (4...25 mm <sup>2</sup> , coarse stranded/solid)<br>40 A (#10...4 AWG, stranded/solid) | 1                       | 100-CTN23 |
|  | 3-Pole Terminal Lug Kit<br>• For Cat. No. 100-C09...C23 (Load side)                                       | IEC @ 40 °C<br>IEC @ 40 °C<br>UL/CSA (Encl.) | 45 A (4...16 mm <sup>2</sup> , fine stranded w/ ferrule)<br>45 A (4...25 mm <sup>2</sup> , coarse stranded/solid)<br>40 A (#10...4 AWG, stranded/solid)                | 1                       | 100-CTL23 |
|  | 3-Pole Terminal Lug Kit<br>• For Cat. No. 100-C30...C37 (Line and load side)                              | IEC @ 40 °C<br>IEC @ 40 °C<br>UL/CSA (Encl.) | 60 A (4...16 mm <sup>2</sup> , fine stranded w/ ferrule)<br>60 A (4...25 mm <sup>2</sup> , coarse stranded/solid)<br>55 A (#10...4 AWG, stranded/solid)                | 1                       | 100-CT37  |
|   | 1-Pole Terminal Lug Kit<br>• For Cat. No. 100-C43   | IEC @ 40 °C<br>IEC @ 40 °C<br>UL/CSA (Encl.) | 90 A (6...35 mm <sup>2</sup> , fine stranded w/ ferrule)<br>90 A (6...50 mm <sup>2</sup> , coarse stranded/solid)<br>75 A (#8...2 AWG, stranded/solid)                 | 3                       | 100-CT43  |
|  | 3-Pole Paralleling Kit<br>• For Cat. No. 100-C09...C23  | IEC @ 40 °C<br>IEC @ 40 °C<br>UL/CSA (Encl.) | 100 A (35...70 mm <sup>2</sup> , fine stranded w/ ferrule)<br>100 A (35...95 mm <sup>2</sup> , coarse stranded/solid)<br>100 A (#0...2/0 AWG, stranded/solid)          | 2                       | 100-CP23  |
|  | 3-Pole Paralleling Kit<br>• For Cat. No. 100-C30...C37  | IEC @ 40 °C<br>IEC @ 40 °C<br>UL/CSA (Encl.) | 150 A (35...70 mm <sup>2</sup> , fine stranded w/ ferrule)<br>150 A (35...95 mm <sup>2</sup> , coarse stranded/solid)<br>150 A (#0...2/0 AWG, stranded/solid)          | 2                       | 100-CP37  |

(1) Must be ordered in multiples of the package quantity.  
 (2) 16 mm<sup>2</sup> max. according to IEC 60947; actual max. 25 mm<sup>2</sup>

**SEMI-F47 Voltage Sag Immunity Module**

|   | Description  | Input Voltage | For Use With <sup>(1)</sup> | Options                      | Cat. No.     |
|---|--|---------------|-----------------------------|------------------------------|--------------|
|  | SEMI-F47 Module<br>• Meets SEMI-F47 voltage sag immunity requirements<br>• Direct mounting to coil terminals of 100-C contactors and 700-CF control relays<br>• Requires DC coil contactor<br>• Optional 1...30 s ON-delay timer version | 24...240V AC  | 100-C60...C97               | without timer                | 100-CSF47    |
|   |  | 110...240V AC | 100-C60...C97               | with 1...30 s ON-delay timer | 100-CSF47A30 |

(1) Contactor must have DC coil at the same voltage as AC input. Example: for 24V AC control, select Cat. No. 100-C09ZJ10 (24V DC coil).

# Renewal Parts

## Replacement Coils for AC Contactors



| AC Standard Control Voltages [V] |           |           | AC Coil Code | 100-C09...100-C16 | 100-C23...100-C37, 100L-C20 | 100-C40...100-C55 | 100-C60...100-C85 | 100-C90...100-C97 |
|----------------------------------|-----------|-----------|--------------|-------------------|-----------------------------|-------------------|-------------------|-------------------|
| 50 Hz                            | 60 Hz     | 50/60 Hz  |              | Cat. No.          | Cat. No.                    | Cat. No.          | Cat. No.          | Cat. No.          |
| —                                | 12        | —         | Q            | TA006             | TC006                       | TD006             | TE006             | TF006             |
| 12                               | —         | —         | R            | TA404             | TC404                       | TD404             | TE404             | TF404             |
| —                                | 24        | —         | J            | TA013             | TC013                       | TD013             | TE013             | TF013             |
| 24                               | —         | —         | K            | TA407             | TC407                       | TD407             | TE407             | TF407             |
| —                                | —         | 24        | KJ           | TA855             | TC855                       | TD855             | TE855             | TF855             |
| 32                               | 36        | —         | V            | TA481             | TC481                       | TD481             | TE481             | TF481             |
| 36                               | 42        | —         | W            | TA410             | TC410                       | TD410             | TE410             | TF410             |
| 42                               | 48        | —         | X            | TA482             | TC482                       | TD482             | TE482             | TF482             |
| 48                               | —         | —         | Y            | TA414             | TC414                       | TD414             | TE414             | TF414             |
| —                                | —         | 48        | KY           | TA860             | TC860                       | TD860             | TE860             | TF860             |
| 100                              | 100...110 | 100       | KP           | TA861             | TC861                       | TD861             | TE861             | TF861             |
| 110                              | 120       | —         | D            | TA473             | TC473                       | TD473             | TE473             | TF473             |
| —                                | —         | 110       | KD           | TA856             | TC856                       | TD856             | TE856             | TF856             |
| 120                              | —         | —         | P            | TA425             | TC425                       | TD425             | TE425             | TF425             |
| 127                              | —         | —         | S            | TA428             | TC428                       | TD428             | TE428             | TF428             |
| 200                              | 200...220 | 200       | KG           | TA862             | TC862                       | TD862             | TE862             | TF862             |
| —                                | 208       | —         | H            | TA049             | TC049                       | TD049             | TE049             | TF049             |
| 200...220                        | 208...240 | —         | L            | TA296             | TC296                       | TD296             | TE296             | TF296             |
| —                                | —         | 200...230 | KL           | TA864             | TC864                       | TD864             | TE864             | —                 |
| 220                              | 240       | —         | A            | TA474             | TC474                       | TD474             | TE474             | TF474             |
| 220...230                        | 260       | —         | F            | TA441             | TC441                       | TD441             | TE441             | TF441             |
| —                                | —         | 230       | KF           | TA851             | TC851                       | TD851             | TE851             | TF851             |
| 230...240                        | —         | —         | VA           | TA440             | TC440                       | TD440             | TE440             | TF440             |
| 240                              | 277       | —         | T            | TA480             | TC480                       | TD480             | TE480             | TF480             |
| —                                | —         | 240       | KA           | TA858             | TC858                       | TD858             | TE858             | TF858             |
| —                                | 347       | —         | I            | TA065             | TC065                       | TD065             | TE065             | TF065             |
| —                                | 380       | —         | E            | TA067             | TC067                       | TD067             | TE067             | TF067             |
| 380...400                        | 440       | —         | N            | TA071             | TC071                       | TD071             | TE071             | TF071             |
| —                                | —         | 400       | KN           | TA863             | TC863                       | TD863             | TE863             | TF863             |
| 400...415                        | —         | —         | G            | TA457             | TC457                       | TD457             | TE457             | TF457             |
| 440                              | 480       | —         | B            | TA475             | TC475                       | TD475             | TE475             | TF475             |
| —                                | —         | 440       | KB           | TA859             | TC859                       | TD859             | TE859             | TF859             |
| 500                              | —         | —         | M            | TA479             | TC479                       | TD479             | TE479             | TF479             |
| 550                              | 600       | —         | C            | TA476             | TC476                       | TD476             | TE476             | TF476             |



### Replacement Coils for DC Contactors



| DC Control Voltage [V]               | DC Coil Code | 100-C09...100-C16, 100Q-C16 | 100-C23...100-C37, 100Q-C37 | 100-C40...100-C55 (Series A) | 100-C40...100-C55 (Series B) | 100-C60...100-C85 | 100-C90...100-C97 |
|--------------------------------------|--------------|-----------------------------|-----------------------------|------------------------------|------------------------------|-------------------|-------------------|
|                                      |              | Cat. No.                    | Cat. No.                    | Cat. No.                     | Cat. No.                     | Cat. No.          | Cat. No.          |
| 9V Diode <sup>(1)</sup>              | DR           | —                           | —                           | —                            | —                            | TE766M            | TF766M            |
| 12V Electronic <sup>(2)</sup>        | EQ           | TC708E                      | TC708E                      | TD708E                       | TD708E2                      | —                 | —                 |
| 12V Diode                            | DQ           | —                           | —                           | —                            | —                            | TE708M            | TF708M            |
| 24V Electronic <sup>(2)</sup>        | EJ           | TC714E                      | TC714E                      | TD714E                       | TD714E2                      | —                 | —                 |
| 24V Electronic <sup>(3)</sup>        | QJ           | TC714Q                      | TC714Q                      | TD714Q                       | TD714Q2                      | —                 | —                 |
| 24V Diode <sup>(2)</sup>             | DJ           | —                           | —                           | —                            | —                            | TE714M            | TF714M            |
| 36...48V Electronic <sup>(2)</sup>   | EW           | TC719E                      | TC719E                      | TD719E                       | TD719E2                      | —                 | —                 |
| 36V Diode                            | DW           | —                           | —                           | —                            | —                            | TE719M            | TF719M            |
| 48...72V Electronic                  | EY           | TC724E                      | TC724E                      | TD724E                       | TD724E2                      | —                 | —                 |
| 48V Diode                            | DY           | —                           | —                           | —                            | —                            | TE724M            | TF724M            |
| 60V Diode                            | DZ           | —                           | —                           | —                            | —                            | TE774M            | TF774M            |
| 64V Diode                            | DB           | —                           | —                           | —                            | —                            | TE727M            | TF727M            |
| 72V Diode                            | DG           | —                           | —                           | —                            | —                            | TE728M            | TF728M            |
| 80V Diode                            | DE           | —                           | —                           | —                            | —                            | TE729M            | TF729M            |
| 110...125V Electronic <sup>(4)</sup> | ED           | TC733E                      | TC733E                      | TD733E                       | TD733E2                      | —                 | —                 |
| 110V Diode                           | DD           | —                           | —                           | —                            | —                            | TE733M            | TF733M            |
| 115V Diode                           | DP           | —                           | —                           | —                            | —                            | TE734M            | TF734M            |
| 125V Diode                           | DS           | —                           | —                           | —                            | —                            | TE737M            | TF737M            |
| 220...250V Electronic                | EA           | TC747E                      | TC747E                      | TD747E                       | TD747E2                      | —                 | —                 |
| 220V Diode                           | DA           | —                           | —                           | —                            | —                            | TE747M            | TF747M            |
| 230V Diode                           | DF           | —                           | —                           | —                            | —                            | TE749F            | TF749F            |
| 250V Diode                           | DT           | —                           | —                           | —                            | —                            | TE751F            | TF751F            |

- (1) Voltage operating range: 0.65...1.3 U<sub>s</sub>
- (2) Voltage operating range: 0.7...1.25 U<sub>s</sub>
- (3) Faster drop-out time (16...21 ms)
- (4) Voltage operating range: 0.7...1.25 U<sub>s</sub> at 110V DC

# Specifications

Table 10 - Main Circuits

|  |                 | 100/104-C, 100S/104S-C |     |     |      |                       |      |        |        |      |      |      |      |      |        |        |      |     |
|--|-----------------|------------------------|-----|-----|------|-----------------------|------|--------|--------|------|------|------|------|------|--------|--------|------|-----|
|  |                 | 09                     | 12  | 16  | 23   | 30                    | 37   | 40*200 | 40*400 | 43   | 55   | 60   | 72   | 85   | 90*200 | 90*400 | 97   |     |
| Coil Type:   | Conventional    | X                      | X   | X   | X    | X                     | X    | X      | X      | X    | X    | X    | X    | X    | X      | X      | X    |     |
|  | Electronic – EI | X                      | X   | X   | X    | X                     | X    | X      | X      | X    | X    | –    | –    | –    | –      | –      | –    |     |
| <b>AC-1 Active Power Load (50 Hz); Ambient temperature 40 °C (104 °F)</b>                  |                 |                        |     |     |      |                       |      |        |        |      |      |      |      |      |        |        |      |     |
| Rated Operational Current, $I_e$   | ≤500V           | [A]                    | 32  | 32  | 32   | 32(40) <sup>(1)</sup> | 65   | 65     | 75     | 75   | 85   | 85   | 100  | 100  | 100    | 130    | 130  | 130 |
|  | 690V            | [A]                    | 32  | 32  | 32   | 32(40) <sup>(1)</sup> | 65   | 65     | 75     | 75   | 85   | 85   | 100  | 100  | 100    | 130    | 130  | 130 |
| Rated Operational Power, $P_e$   | 230V            | [kW]                   | 13  | 13  | 13   | 13                    | 26   | 26     | 30     | 30   | 34   | 34   | 40   | 40   | 40     | 52     | 52   | 52  |
|  | 240V            | [kW]                   | 13  | 13  | 13   | 13                    | 27   | 27     | 31     | 31   | 35   | 35   | 42   | 42   | 42     | 54     | 54   | 54  |
|  | 400V            | [kW]                   | 22  | 22  | 22   | 22                    | 45   | 45     | 52     | 52   | 59   | 59   | 69   | 69   | 69     | 90     | 90   | 90  |
|  | 415V            | [kW]                   | 23  | 23  | 23   | 23                    | 47   | 47     | 54     | 54   | 61   | 61   | 72   | 72   | 72     | 93     | 93   | 93  |
|  | 500V            | [kW]                   | 28  | 28  | 28   | 28                    | 56   | 56     | 65     | 65   | 74   | 74   | 87   | 87   | 87     | 113    | 113  | 113 |
|  | 690V            | [kW]                   | 38  | 38  | 38   | 38                    | 78   | 78     | 90     | 90   | 102  | 102  | 120  | 120  | 120    | 155    | 155  | 155 |
| <b>AC-1 Active Power Load (50 Hz); Ambient temperature 60 °C (140 °F)</b>                  |                 |                        |     |     |      |                       |      |        |        |      |      |      |      |      |        |        |      |     |
| Rated Operational Current, $I_e$   | ≤500V           | [A]                    | 32  | 32  | 32   | 32                    | 65   | 65     | 60     | 60   | 75   | 75   | 100  | 100  | 100    | 110    | 110  | 110 |
|  | 690V            | [A]                    | 32  | 32  | 32   | 32                    | 65   | 65     | 60     | 60   | 75   | 75   | 100  | 100  | 100    | 110    | 110  | 110 |
| Rated Operational Power, $P_e$   | 230V            | [kW]                   | 13  | 13  | 13   | 13                    | 26   | 26     | 24     | 24   | 25   | 25   | 40   | 40   | 40     | 44     | 44   | 44  |
|  | 240V            | [kW]                   | 13  | 13  | 13   | 13                    | 27   | 27     | 25     | 25   | 26   | 26   | 42   | 42   | 42     | 46     | 46   | 46  |
|  | 400V            | [kW]                   | 22  | 22  | 22   | 22                    | 45   | 45     | 42     | 42   | 44   | 44   | 69   | 69   | 69     | 76     | 76   | 76  |
|  | 415V            | [kW]                   | 23  | 23  | 23   | 23                    | 47   | 47     | 43     | 43   | 45   | 45   | 72   | 72   | 72     | 79     | 79   | 79  |
|  | 500V            | [kW]                   | 28  | 28  | 28   | 28                    | 56   | 56     | 52     | 52   | 55   | 55   | 87   | 87   | 87     | 95     | 95   | 95  |
|  | 690V            | [kW]                   | 38  | 38  | 38   | 38                    | 78   | 78     | 72     | 72   | 75   | 75   | 120  | 120  | 120    | 131    | 131  | 131 |
| <b>Switching of 3-phase Motors; (50 Hz) Ambient temperature 60 °C (140 °F), AC-2, AC-3</b> |                 |                        |     |     |      |                       |      |        |        |      |      |      |      |      |        |        |      |     |
| Rated Operational Current, $I_e$   | 230V            | [A]                    | 12  | 15  | 20   | 26.5                  | 35   | 38     | 38     | 38   | 44   | 56   | 62   | 72   | 85     | 85     | 85   | 96  |
|  | 240V            | [A]                    | 12  | 15  | 20   | 26.5                  | 35   | 38     | 38     | 38   | 44   | 56   | 62   | 72   | 85     | 85     | 85   | 95  |
|  | 400V            | [A]                    | 9   | 12  | 16   | 23                    | 30   | 37     | 37     | 37   | 43   | 55   | 60   | 72   | 85     | 85     | 85   | 97  |
|  | 415V            | [A]                    | 9   | 12  | 16   | 23                    | 30   | 37     | 37     | 37   | 43   | 55   | 60   | 72   | 85     | 85     | 85   | 97  |
|  | 500V            | [A]                    | 7   | 10  | 14   | 20                    | 25   | 30     | 29     | 30   | 38   | 44   | 55   | 67   | 80     | 80     | 80   | 78  |
|  | 690V            | [A]                    | 5   | 7   | 9    | 12                    | 18   | 21     | 9      | 21   | 25   | 25   | 34   | 42   | 49     | 22     | 49   | 57  |
| Rated Operational Power, $P_e$   | 230V            | [kW]                   | 3   | 4   | 5.5  | 7.5                   | 10   | 11     | 11     | 11   | 13   | 15   | 18.5 | 22   | 25     | 25     | 25   | 30  |
|  | 240V            | [kW]                   | 3   | 4   | 5.5  | 7.5                   | 10   | 11     | 11     | 11   | 13   | 15   | 18.5 | 22   | 25     | 25     | 25   | 30  |
|  | 400V            | [kW]                   | 4   | 5.5 | 7.5  | 11                    | 15   | 18.5   | 18.5   | 18.5 | 22   | 30   | 32   | 40   | 45     | 45     | 45   | 55  |
|  | 415V            | [kW]                   | 4   | 5.5 | 7.5  | 11                    | 15   | 20     | 20     | 20   | 22   | 30   | 32   | 40   | 45     | 45     | 45   | 55  |
|  | 500V            | [kW]                   | 4   | 5.5 | 7.5  | 13                    | 15   | 20     | 18.5   | 20   | 25   | 30   | 37   | 45   | 55     | 55     | 55   | 55  |
|  | 690V            | [kW]                   | 4   | 5.5 | 7.5  | 10                    | 15   | 18.5   | 7.5    | 18.5 | 22   | 22   | 32   | 40   | 45     | 18.5   | 45   | 55  |
| <b>Load Carrying Capacity per UL/CSA</b>   |                 |                        |     |     |      |                       |      |        |        |      |      |      |      |      |        |        |      |     |
| General Purpose Current (enclosed)   |                 | [A]                    | 25  | 25  | 30   | 30                    | 55   | 60     | 60     | 60   | 75   | 75   | 90   | 90   | 100    | 125    | 130  | 120 |
| Rated current (enclosed), 1-phase  | 115V            | [A]                    | 9.8 | 9.8 | 16   | 24                    | 24   | 34     | 34     | 34   | 34   | 56   | 56   | 56   | 80     | 80     | 80   | 100 |
|  | 230V            | [A]                    | 10  | 12  | 17   | 17                    | 28   | 28     | 28     | 28   | 40   | 50   | 50   | 68   | 68     | 68     | 68   | 88  |
| Rated power (enclosed), 1-phase  | 115V            | [Hp]                   | 0.5 | 0.5 | 1    | 2                     | 2    | 3      | 3      | 3    | 3    | 5    | 5    | 5    | 7.5    | 7.5    | 7.5  | 10  |
|  | 230V            | [Hp]                   | 1.5 | 2   | 3    | 3                     | 5    | 5      | 5      | 5    | 7.5  | 10   | 10   | 15   | 15     | 15     | 15   | 20  |
| Rated current (enclosed), 3-phase  | 200V            | [A]                    | 7.8 | 11  | 17.5 | 17.5                  | 25.3 | 32.2   | 32.2   | 32.2 | 32.2 | 48.3 | 48.3 | 62.1 | 78.2   | 78.2   | 78.2 | 92  |
|  | 230V            | [A]                    | 6.8 | 9.6 | 15.2 | 22                    | 28   | 28     | 28     | 28   | 42   | 54   | 54   | 68   | 80     | 80     | 80   | 80  |
|  | 460V            | [A]                    | 7.6 | 11  | 14   | 21                    | 27   | 34     | 34     | 34   | 40   | 52   | 52   | 65   | 77     | 65     | 77   | 96  |
|  | 575V            | [A]                    | 9   | 11  | 17   | 17                    | 27   | 32     | 17     | 32   | 32   | 41   | 52   | 62   | 62     | 22     | 52   | 77  |
| Rated power (enclosed), 3-phase  | 200V            | [Hp]                   | 2   | 3   | 5    | 5                     | 7.5  | 10     | 10     | 10   | 10   | 15   | 15   | 20   | 25     | 25     | 25   | 30  |
|  | 230V            | [Hp]                   | 2   | 3   | 5    | 7.5                   | 10   | 10     | 10     | 10   | 15   | 20   | 20   | 25   | 30     | 30     | 30   | 30  |
|  | 460V            | [Hp]                   | 5   | 7.5 | 10   | 15                    | 20   | 25     | 25     | 25   | 30   | 40   | 40   | 50   | 60     | 50     | 60   | 75  |
|  | 575V            | [Hp]                   | 7.5 | 10  | 15   | 15                    | 25   | 30     | 15     | 30   | 30   | 40   | 50   | 60   | 60     | 20     | 50   | 75  |

(1) Values in ( ) with increased cross-section and cable lug.

Table 11 - Main Circuits

|   |                     |      | 100/104-C, 100S/104S-C |       |       |       |       |       |      |      |      |      |      |     |
|---|---------------------|------|------------------------|-------|-------|-------|-------|-------|------|------|------|------|------|-----|
|   |                     |      | 09                     | 12    | 16    | 23    | 30    | 37    | 43   | 55   | 60   | 72   | 85   | 97  |
| Coil Type:  | Conventional        |      | X                      | X     | X     | X     | X     | X     | X    | X    | X    | X    | X    | X   |
|   | Electronic – EI     |      | X                      | X     | X     | X     | X     | X     | X    | X    | X    | –    | –    | –   |
| <b>Switching of 3-phase Motors, (50 Hz); Ambient temperature 60 °C (140 °F), AC-4</b> |                     |      |                        |       |       |       |       |       |      |      |      |      |      |     |
| Rated Operational Current, $I_e$  | 230V                | [A]  | 12                     | 15    | 20    | 26.5  | 35    | 38    | 44   | 56   | 62   | 72   | 85   | 96  |
|   | 240V                | [A]  | 12                     | 15    | 20    | 26.5  | 35    | 38    | 44   | 56   | 62   | 72   | 85   | 95  |
|   | 400V                | [A]  | 9                      | 12    | 16    | 23    | 30    | 37    | 43   | 55   | 60   | 72   | 85   | 97  |
|   | 415V                | [A]  | 9                      | 12    | 16    | 23    | 30    | 37    | 43   | 55   | 60   | 72   | 85   | 97  |
|   | 500V                | [A]  | 7                      | 10    | 14    | 20    | 25    | 30    | 38   | 44   | 55   | 67   | 80   | 78  |
|   | 690V                | [A]  | 5                      | 7     | 9     | 12    | 18    | 21    | 25   | 25   | 34   | 42   | 49   | 57  |
| Rated Operational Power, $P_e$  | 230V                | [kW] | 3                      | 4     | 5.5   | 7.5   | 10    | 11    | 13   | 15   | 18.5 | 22   | 25   | 30  |
|   | 240V                | [kW] | 3                      | 4     | 5.5   | 7.5   | 10    | 11    | 13   | 15   | 18.5 | 22   | 25   | 30  |
|   | 400V                | [kW] | 4                      | 5.5   | 7.5   | 11    | 15    | 18.5  | 22   | 30   | 32   | 40   | 45   | 55  |
|   | 415V                | [kW] | 4                      | 5.5   | 7.5   | 11    | 15    | 20    | 22   | 30   | 32   | 40   | 45   | 55  |
|   | 500V                | [kW] | 4                      | 5.5   | 7.5   | 13    | 15    | 20    | 25   | 30   | 37   | 45   | 55   | 55  |
|   | 690V                | [kW] | 4                      | 5.5   | 7.5   | 10    | 15    | 18.5  | 22   | 22   | 32   | 40   | 45   | 55  |
| <b>AC-4 at approximately 200,000 operations</b>                                       |                     |      |                        |       |       |       |       |       |      |      |      |      |      |     |
| Rated Operational Current, $I_e$  | 230V                | [A]  | 4.3                    | 6.6   | 9     | 9     | 12    | 14    | 16.5 | 22   | 25.5 | 31   | 38   | 44  |
|   | 240V                | [A]  | 4.3                    | 6.6   | 9     | 9     | 12    | 14    | 16.5 | 22   | 25.5 | 31   | 38   | 44  |
|   | 400/415V            | [A]  | 4.3                    | 6.6   | 9     | 9     | 12    | 14    | 16.5 | 22   | 25.5 | 31   | 38   | 44  |
|   | 500V                | [A]  | 4.3                    | 6.6   | 9     | 9     | 12    | 14    | 16.5 | 22   | 25.5 | 31   | 38   | 44  |
|   | 690V                | [A]  | 4.3                    | 6.6   | 9     | 9     | 12    | 14    | 16.5 | 22   | 25.5 | 31   | 38   | 44  |
| Rated Operational Power, $P_e$  | 230V <sup>(1)</sup> | [kW] | 0.75                   | 1.5   | 2.2   | 2.2   | 3     | 3.7   | 4    | 5.5  | 6.3  | 7.5  | 11   | 11  |
|   | 240V <sup>(1)</sup> | [kW] | 0.75                   | 1.5   | 2.2   | 2.2   | 3     | 4     | 4    | 5.5  | 7.5  | 7.5  | 11   | 11  |
|   | 400V <sup>(1)</sup> | [kW] | 1.8                    | 3     | 4     | 4     | 5.5   | 6.3   | 7.5  | 11   | 13   | 15   | 20   | 22  |
|   | 415V <sup>(1)</sup> | [kW] | 1.8                    | 3     | 4     | 4     | 5.5   | 6.3   | 7.5  | 11   | 13   | 17   | 20   | 22  |
|   | 500V <sup>(1)</sup> | [kW] | 2.2                    | 3.7   | 5.5   | 5.5   | 7.5   | 7.5   | 10   | 11   | 15   | 20   | 25   | 30  |
|   | 690V <sup>(1)</sup> | [kW] | 3                      | 5.5   | 7.5   | 7.5   | 10    | 11    | 15   | 18.5 | 22   | 25   | 32   | 37  |
| Max. switching frequency  | Ops/hour            | 250  | 250                    | 220   | 200   | 200   | 200   | 200   | 200  | 200  | 120  | 120  | 120  | 120 |
| Wye-Delta (60 Hz)<br>Rated Operational Power  | 200V                | [Hp] | 5                      | 5     | 7-1/2 | 7-1/2 | 10    | 15    | 20   | 25   | 30   | 40   | 50   | 50  |
|   | 230V                | [Hp] | 5                      | 7-1/2 | 10    | 10    | 15    | 20    | 25   | 30   | 40   | 50   | 60   | 60  |
|   | 460V                | [Hp] | 10                     | 15    | 20    | 25    | 30    | 40    | 50   | 60   | 75   | 100  | 125  | 125 |
|   | 575V                | [Hp] | 10                     | 15    | 20    | 25    | 30    | 40    | 50   | 60   | 75   | 100  | 125  | 125 |
| UL/CSA Elevator Duty<br>Rated Operational Current                                     | 200V                | [A]  | 7.8                    | 11.0  | 11.0  | 17.5  | 25.3  | 25.3  | 32.2 | TBD  | 32.2 | 48.3 | 62.1 | TBD |
|   | 230V                | [A]  | 6.8                    | 9.6   | 15.2  | 15.2  | 22.0  | 28.0  | 28.0 | TBD  | 42.0 | 54.0 | 68.0 | TBD |
|   | 460V                | [A]  | 7.6                    | 11.0  | 14.0  | 21.0  | 27.0  | 27.0  | 34.0 | TBD  | 40.0 | 52.0 | 65.0 | TBD |
|   | 575V                | [A]  | 6.1                    | 9.0   | 11.0  | 17.0  | 22.0  | 27.0  | 32.0 | TBD  | 41.0 | 52.0 | 62.0 | TBD |
| UL/CSA Elevator Duty<br>Rated Operational Power                                       | 200V                | [Hp] | 2                      | 3     | 3     | 5     | 7-1/2 | 7-1/2 | 10   | TBD  | 10   | 15   | 20   | TBD |
|   | 230V                | [Hp] | 2                      | 3     | 5     | 5     | 7-1/2 | 10    | 10   | TBD  | 15   | 20   | 25   | TBD |
|   | 460V                | [Hp] | 5                      | 7-1/2 | 10    | 15    | 20    | 20    | 25   | TBD  | 30   | 40   | 50   | TBD |
|   | 575V                | [Hp] | 5                      | 7-1/2 | 10    | 15    | 20    | 25    | 30   | TBD  | 40   | 50   | 60   | TBD |

(1) Power ratings at 50 Hz: Preferred values according to IEC 60072-1

Table 12 - Main Circuits

|   |                     | 100/104-C, 100S/104S-C |      |      |      |      |      |      |      |      |      |      |      |      |
|---|---------------------|------------------------|------|------|------|------|------|------|------|------|------|------|------|------|
|   |                     | 09                     | 12   | 16   | 23   | 30   | 37   | 43   | 55   | 60   | 72   | 85   | 97   |      |
| Coil Type:  | Conventional        | X                      | X    | X    | X    | X    | X    | X    | X    | X    | X    | X    | X    |      |
|   | Electronic – EI     | X                      | X    | X    | X    | X    | X    | X    | X    | –    | –    | –    | –    |      |
| <b>Star-Delta Starting (50 Hz)</b>                    |                     |                        |      |      |      |      |      |      |      |      |      |      |      |      |
| Rated Operational Current, $I_e$                      | ≤ 230V              | [A]                    | 21   | 26   | 35   | 46   | 61   | 66   | 76   | 96   | 107  | 125  | 147  | 166  |
|   | ≤ 240V              | [A]                    | 21   | 26   | 35   | 46   | 61   | 66   | 76   | 96   | 107  | 125  | 47   | 165  |
|   | 400V                | [A]                    | 16   | 21   | 28   | 40   | 52   | 64   | 74   | 95.3 | 104  | 125  | 147  | 168  |
|   | 415V                | [A]                    | 16   | 21   | 28   | 40   | 52   | 64   | 74   | 95.3 | 104  | 125  | 47   | 168  |
|   | 500V                | [A]                    | 12   | 17   | 24   | 35   | 43   | 52   | 66   | 76.2 | 95   | 116  | 139  | 135  |
|   | 690V                | [A]                    | 8.6  | 12   | 16   | 21   | 31   | 36   | 43   | 55.4 | 59   | 73   | 85   | 99   |
| Rated Operational Power, $P_e$                        | 230V <sup>(1)</sup> | [kW]                   | 5.5  | 7.5  | 10   | 13   | 17   | 20   | 22   | 30   | 32   | 37   | 45   | 50   |
|   | 240V <sup>(1)</sup> | [kW]                   | 5.5  | 7.5  | 10   | 13   | 18.5 | 20   | 22   | 30   | 32   | 40   | 50   | 50   |
|   | 400V <sup>(1)</sup> | [kW]                   | 7.5  | 10   | 13   | 20   | 25   | 32   | 40   | 45   | 55   | 63   | 80   | 90   |
|   | 415V <sup>(1)</sup> | [kW]                   | 7.5  | 11   | 15   | 22   | 25   | 32   | 40   | 45   | 55   | 63   | 80   | 90   |
|   | 500V <sup>(1)</sup> | [kW]                   | 7.5  | 11   | 15   | 22   | 25   | 32   | 45   | 45   | 63   | 80   | 90   | 90   |
|   | 690V <sup>(1)</sup> | [kW]                   | 7.5  | 10   | 13   | 18.5 | 25   | 32   | 40   | 45   | 55   | 63   | 80   | 90   |
| <b>Switching of Power Transformers, AC-6a (50 Hz)</b> |                     |                        |      |      |      |      |      |      |      |      |      |      |      |      |
| Inrush Current = n                                    |                     |                        |      |      |      |      |      |      |      |      |      |      |      |      |
| Rated transformer current                             |                     |                        |      |      |      |      |      |      |      |      |      |      |      |      |
| n = 30  | ≤ 230V              | [A]                    | 10.9 | 10.9 | 10.9 | 10.9 | 20   | 20   | 23   | 23   | 40.8 | 40.8 | 40.8 | 48.5 |
|   | ≤ 240V              | [A]                    | 10.9 | 10.9 | 10.9 | 10.9 | 20   | 20   | 23   | 23   | 40.8 | 40.8 | 40.8 | 48.5 |
|   | ≤ 400V              | [A]                    | 10.9 | 10.9 | 10.9 | 10.9 | 20   | 20   | 23   | 23   | 40.8 | 40.8 | 40.8 | 48.5 |
|   | ≤ 415V              | [A]                    | 10.9 | 10.9 | 10.9 | 10.9 | 20   | 20   | 23   | 23   | 40.8 | 40.8 | 40.8 | 48.5 |
|   | ≤ 500V              | [A]                    | 10.9 | 10.9 | 10.9 | 10.9 | 20   | 20   | 23   | 23   | 40.8 | 40.8 | 40.8 | 48.5 |
|   | ≤ 690V              | [A]                    | 10.9 | 10.9 | 10.9 | 10.9 | 20   | 20   | 23   | 23   | 40.8 | 40.8 | 40.8 | 48.5 |
| Apparent Power  | 230V                | [kVA]                  | 4.3  | 4.3  | 4.3  | 4.3  | 8    | 8    | 9.2  | 9.2  | 16   | 16   | 16   | 19.3 |
|   | 240V                | [kVA]                  | 4.5  | 4.5  | 4.5  | 4.5  | 8.3  | 8.3  | 10   | 10   | 17   | 17   | 17   | 20.2 |
|   | 400V                | [kVA]                  | 7.5  | 7.5  | 7.5  | 7.5  | 14   | 14   | 16   | 16   | 28   | 28   | 28   | 33.6 |
|   | 415V                | [kVA]                  | 7.8  | 7.8  | 7.8  | 7.8  | 14   | 14   | 17   | 17   | 29   | 29   | 29   | 34.9 |
|   | 500V                | [kVA]                  | 9.4  | 9.4  | 9.4  | 9.4  | 17   | 17   | 20   | 20   | 35   | 35   | 35   | 42   |
|   | 690V                | [kVA]                  | 13   | 13   | 13   | 13   | 24   | 24   | 27   | 27   | 49   | 49   | 49   | 58   |
| n=20  | ≤ 690V              | [A]                    | 16.3 | 16.3 | 16.3 | 16.3 | 30   | 30   | 34.5 | 34.5 | 61.3 | 61.3 | 61.3 | 72.8 |
| n=15  | ≤ 690V              | [A]                    | 22   | 22   | 22   | 22   | 40   | 40   | 46   | 46   | 82   | 82   | 82   | 97   |
| 60 Hz Peak Inrush/peak rated transformer current      |                     |                        |      |      |      |      |      |      |      |      |      |      |      |      |
| n=30  |                     | [A]                    | 10.9 | 10.9 | 10.9 | 10.9 | 20   | 20   | 23   | 23   | 40.8 | 40.8 | 40.8 | 48.5 |
| Apparent Power  | 200V                | [kVA]                  | 3.8  | 3.8  | 3.8  | 3.8  | 6.9  | 6.9  | 8.0  | 8    | 14.1 | 14.4 | 14.4 | 16.8 |
|   | 208V                | [kVA]                  | 3.9  | 3.9  | 3.9  | 3.9  | 7.2  | 7.2  | 8.3  | 8.3  | 14.7 | 14.7 | 14.7 | 17.5 |
|   | 240V                | [kVA]                  | 4.5  | 4.5  | 4.5  | 4.5  | 8.3  | 8.3  | 9.6  | 9.6  | 17.0 | 17.0 | 17.0 | 20.2 |
|   | 480V                | [kVA]                  | 9.1  | 9.1  | 9.1  | 9.1  | 16.6 | 16.6 | 19.1 | 19.1 | 33.9 | 33.9 | 33.9 | 40.3 |
|   | 600V                | [kVA]                  | 11.3 | 11.3 | 11.3 | 11.3 | 20.8 | 20.8 | 23.9 | 23.9 | 42.4 | 42.4 | 42.4 | 50.4 |
|   | 660V                | [kVA]                  | 12.5 | 12.5 | 12.5 | 12.5 | 22.9 | 22.9 | 26.3 | 26.3 | 46.6 | 46.6 | 46.6 | 55.4 |
| 60 Hz Peak Inrush/peak rated transformer current      |                     |                        |      |      |      |      |      |      |      |      |      |      |      |      |
| n=20  |                     | [A]                    | 16.3 | 16.3 | 16.3 | 16.3 | 30   | 30   | 34.5 | 34.5 | 61.3 | 61.3 | 61.3 | 72.8 |
| Apparent Power  | 200V                | [kVA]                  | 5.6  | 5.6  | 5.6  | 5.6  | 10.4 | 10.4 | 12.0 | 12   | 21.2 | 21.2 | 21.2 | 25.2 |
|   | 208V                | [kVA]                  | 5.9  | 5.9  | 5.9  | 5.9  | 10.8 | 10.8 | 12.4 | 12.4 | 22.1 | 22.1 | 22.1 | 26.2 |
|   | 240V                | [kVA]                  | 6.8  | 6.8  | 6.8  | 6.8  | 12.5 | 12.5 | 14.3 | 14.3 | 25.5 | 25.5 | 25.5 | 30.3 |
|   | 480V                | [kVA]                  | 13.6 | 13.6 | 13.6 | 13.6 | 24.9 | 24.9 | 28.7 | 28.7 | 51.0 | 51.0 | 51.0 | 60.5 |
|   | 600V                | [kVA]                  | 16.9 | 16.9 | 16.9 | 16.9 | 31.2 | 31.2 | 35.9 | 35.9 | 63.7 | 63.7 | 63.7 | 75.7 |
|   | 660V                | [kVA]                  | 18.6 | 18.6 | 18.6 | 18.6 | 34.3 | 34.3 | 39.4 | 39.4 | 70.1 | 70.1 | 70.1 | 83.2 |

(1) Power ratings at 50 Hz: Preferred values according to IEC 60072-1

Table 13 - Main Circuits

|   |                 | 100/104-C, 100S/104S-C |      |      |      |      |      |      |      |      |      |      |       |
|---|-----------------|------------------------|------|------|------|------|------|------|------|------|------|------|-------|
|   |                 | 09                     | 12   | 16   | 23   | 30   | 37   | 43   | 55   | 60   | 72   | 85   | 97    |
| Coil Type:  | Conventional    | X                      | X    | X    | X    | X    | X    | X    | X    | X    | X    | X    | X     |
|   | Electronic – EI | X                      | X    | X    | X    | X    | X    | X    | X    | X    | –    | –    | –     |
| <b>60 Hz Peak Inrush/peak rated transformer current</b> |                 |                        |      |      |      |      |      |      |      |      |      |      |       |
| n=15  | [A]             | 22                     | 22   | 22   | 22   | 40   | 40   | 46   | 46   | 82   | 82   | 82   | 97    |
| Apparent Power  | 200V [kVA]      | 7.5                    | 7.5  | 7.5  | 7.5  | 13.9 | 13.9 | 15.9 | 15.9 | 28.4 | 28.4 | 28.4 | 33.6  |
|   | 208V [kVA]      | 7.8                    | 7.8  | 7.8  | 7.8  | 14.4 | 14.4 | 16.6 | 16.6 | 29.5 | 29.5 | 29.5 | 34.9  |
|   | 240V [kVA]      | 9.0                    | 9.0  | 9.0  | 9.0  | 16.6 | 16.6 | 19.1 | 19.1 | 34.1 | 34.1 | 34.1 | 40.3  |
|   | 480V [kVA]      | 18.1                   | 18.1 | 18.1 | 18.1 | 33.3 | 33.3 | 38.2 | 38.2 | 68.2 | 68.2 | 68.2 | 80.6  |
|   | 600V [kVA]      | 22.6                   | 22.6 | 22.6 | 22.6 | 41.6 | 41.6 | 47.8 | 47.8 | 85.2 | 85.2 | 85.2 | 100.8 |
|   | 660V [kVA]      | 24.9                   | 24.9 | 24.9 | 24.9 | 45.7 | 45.7 | 52.6 | 52.6 | 93.7 | 93.7 | 93.7 | 110.9 |

Table 14 - Main Circuits

|   |                 | 100/104-C, 100S/104S-C |    |     |      |      |      |        |        |    |    |    |    |    |        |        |    |
|---|-----------------|------------------------|----|-----|------|------|------|--------|--------|----|----|----|----|----|--------|--------|----|
|   |                 | 09                     | 12 | 16  | 23   | 30   | 37   | 40*200 | 40*400 | 43 | 55 | 60 | 72 | 85 | 90*200 | 90*400 | 97 |
| Coil Type:  | Conventional    | X                      | X  | X   | X    | X    | X    | X      | X      | X  | X  | X  | X  | X  | X      | X      | X  |
|   | Electronic – EI | X                      | X  | X   | X    | X    | X    | X      | X      | X  | X  | –  | –  | –  | –      | –      | –  |
| <b>Switching of 3-phase Capacitors, AC-6b (50 Hz)<sup>(1)</sup></b> |                 |                        |    |     |      |      |      |        |        |    |    |    |    |    |        |        |    |
| Single capacitor<br>40 °C (104 °F)                                  | 230V [kVAR]     | 8                      | 8  | 8.5 | 9    | 14   | 14   | –      | –      | 24 | 24 | 28 | 28 | 28 | –      | –      | 28 |
|   | 240V [kVAR]     | 8                      | 8  | 8.5 | 9    | 14   | 14   | –      | –      | 25 | 25 | 29 | 29 | 29 | –      | –      | 29 |
|   | 400V [kVAR]     | 8                      | 8  | 10  | 12.5 | 20   | 24   | –      | –      | 35 | 35 | 48 | 48 | 48 | –      | –      | 48 |
|   | 415V [kVAR]     | 8                      | 8  | 10  | 12.5 | 20   | 25   | –      | –      | 35 | 35 | 50 | 50 | 50 | –      | –      | 50 |
|   | 500V [kVAR]     | 8                      | 8  | 10  | 12.5 | 20   | 25   | –      | –      | 35 | 35 | 50 | 55 | 60 | –      | –      | 60 |
|   | 690V [kVAR]     | 8                      | 8  | 10  | 12.5 | 20   | 25   | –      | –      | 35 | 35 | 50 | 55 | 60 | –      | –      | 60 |
| Single capacitor<br>60 °C (140 °F)                                  | 230V [kVAR]     | 8                      | 8  | 8.5 | 9    | 12.5 | 12.5 | –      | –      | 18 | 18 | 28 | 28 | 28 | –      | –      | 28 |
|   | 240V [kVAR]     | 8                      | 8  | 8.5 | 9    | 12.5 | 12.5 | –      | –      | 18 | 18 | 29 | 29 | 29 | –      | –      | 29 |
|   | 400V [kVAR]     | 8                      | 8  | 10  | 12.5 | 20   | 21.5 | –      | –      | 30 | 30 | 42 | 48 | 48 | –      | –      | 48 |
|   | 415V [kVAR]     | 8                      | 8  | 10  | 12.5 | 20   | 22   | –      | –      | 30 | 30 | 42 | 50 | 50 | –      | –      | 50 |
|   | 500V [kVAR]     | 8                      | 8  | 10  | 12.5 | 20   | 25   | –      | –      | 30 | 30 | 42 | 50 | 55 | –      | –      | 55 |
|   | 690V [kVAR]     | 8                      | 8  | 10  | 12.5 | 20   | 25   | –      | –      | 30 | 30 | 42 | 50 | 55 | –      | –      | 55 |
| Group capacitors<br>40 °C (104 °F)                                  | 230V [kVAR]     | 5                      | 5  | 8   | 9    | 12.5 | 14   | –      | –      | 20 | 20 | 28 | 28 | 28 | –      | –      | 28 |
|   | 240V [kVAR]     | 5                      | 5  | 8   | 9    | 12.5 | 14   | –      | –      | 20 | 20 | 29 | 29 | 29 | –      | –      | 29 |
|   | 400V [kVAR]     | 5                      | 5  | 8   | 10   | 15   | 20   | –      | –      | 25 | 25 | 40 | 48 | 48 | –      | –      | 48 |
|   | 415V [kVAR]     | 5                      | 5  | 8   | 10   | 15   | 20   | –      | –      | 25 | 25 | 40 | 50 | 50 | –      | –      | 50 |
|   | 500V [kVAR]     | 5                      | 5  | 8   | 10   | 15   | 20   | –      | –      | 25 | 25 | 40 | 50 | 50 | –      | –      | 50 |
|   | 690V [kVAR]     | 5                      | 5  | 8   | 10   | 15   | 20   | –      | –      | 25 | 25 | 40 | 50 | 50 | –      | –      | 50 |
| Group capacitors<br>60 °C (140 °F)                                  | 230V [kVAR]     | 5                      | 5  | 8   | 9    | 12.5 | 12.5 | –      | –      | 18 | 18 | 28 | 28 | 28 | –      | –      | 28 |
|   | 240V [kVAR]     | 5                      | 5  | 8   | 9    | 12.5 | 12.5 | –      | –      | 18 | 18 | 29 | 29 | 29 | –      | –      | 29 |
|   | 400V [kVAR]     | 5                      | 5  | 8   | 10   | 15   | 20   | –      | –      | 25 | 25 | 40 | 48 | 48 | –      | –      | 48 |
|   | 415V [kVAR]     | 5                      | 5  | 8   | 10   | 15   | 20   | –      | –      | 25 | 25 | 40 | 50 | 50 | –      | –      | 50 |
|   | 500V [kVAR]     | 5                      | 5  | 8   | 10   | 15   | 20   | –      | –      | 25 | 25 | 40 | 50 | 50 | –      | –      | 50 |
|   | 690V [kVAR]     | 5                      | 5  | 8   | 10   | 15   | 20   | –      | –      | 25 | 25 | 40 | 50 | 50 | –      | –      | 50 |
| 60 Hz Single Capacitor<br>– 40 °C (104 °F)                          | 200V [kVAR]     | 5                      | 5  | 8   | 9    | 12.5 | 14   | –      | –      | 20 | 20 | 28 | 28 | 28 | –      | –      | 28 |
|   | 230V [kVAR]     | 5                      | 5  | 8   | 9    | 12.5 | 14   | –      | –      | 20 | 20 | 29 | 29 | 29 | –      | –      | 29 |
|   | 460V [kVAR]     | 5                      | 5  | 8   | 10   | 15   | 20   | –      | –      | 25 | 25 | 40 | 50 | 50 | –      | –      | 50 |
|   | 600V [kVAR]     | 5                      | 5  | 8   | 10   | 15   | 20   | –      | –      | 25 | 25 | 40 | 50 | 50 | –      | –      | 50 |
| 60 Hz Group<br>Capacitors –<br>40 °C (104 °F)                       | 200V [kVAR]     | 5                      | 5  | 8   | 9    | 12.5 | 12.5 | –      | –      | 18 | 18 | 28 | 28 | 28 | –      | –      | 28 |
|   | 230V [kVAR]     | 5                      | 5  | 8   | 9    | 12.5 | 12.5 | –      | –      | 18 | 18 | 29 | 29 | 29 | –      | –      | 29 |
|   | 460V [kVAR]     | 5                      | 5  | 8   | 10   | 15   | 20   | –      | –      | 25 | 25 | 40 | 50 | 50 | –      | –      | 50 |
|   | 600V [kVAR]     | 5                      | 5  | 8   | 10   | 15   | 20   | –      | –      | 25 | 25 | 40 | 50 | 50 | –      | –      | 50 |

(1) Inductance of leads between capacitors in parallel: min. 6 µH (100-C09...C30 contactors: min 30 µH)


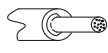
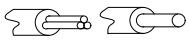

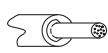
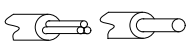
Table 15 - Main Circuits

|  |                        | 100/104-C, 100S/104S-C |      |      |      |      |      |        |        |     |      |      |      |      |        |        |     |      |
|--|------------------------|------------------------|------|------|------|------|------|--------|--------|-----|------|------|------|------|--------|--------|-----|------|
|  |                        | 09                     | 12   | 16   | 23   | 30   | 37   | 40*200 | 40*400 | 43  | 55   | 60   | 72   | 85   | 90*200 | 90*400 | 97  |      |
| <b>Coil Type:</b>  | <b>Conventional</b>    | X                      | X    | X    | X    | X    | X    | X      | X      | X   | X    | X    | X    | X    | X      | X      | X   |      |
|  | <b>Electronic – EI</b> | X                      | X    | X    | X    | X    | X    | X      | X      | X   | X    | X    | –    | –    | –      | –      | –   |      |
| <b>Switching of Lamps</b>  |                        |                        |      |      |      |      |      |        |        |     |      |      |      |      |        |        |     |      |
| Gas discharge lamps AC-5a, 40 °C (104 °F)  |                        |                        |      |      |      |      |      |        |        |     |      |      |      |      |        |        |     |      |
| open   | [A]                    | 22.5                   | 25   | 28   | 29   | 40.5 | 45   | 65     | 65     | 77  | 77   | 81   | 85   | 90   | 115    | 115    | 115 |      |
| enclosed   | [A]                    | 22.5                   | 25   | 28   | 29   | 37   | 41   | 54     | 54     | 57  | 57   | 77   | 81   | 90   | 95     | 95     | 100 |      |
| Individually compensated:  |                        |                        |      |      |      |      |      |        |        |     |      |      |      |      |        |        |     |      |
| Max. capacitance at expected   |                        |                        |      |      |      |      |      |        |        |     |      |      |      |      |        |        |     |      |
| Short-circuit current of   | 10 kA                  | [μF]                   | 1000 | 1000 | 1000 | 1000 | 2700 | 2700   | –      | –   | 3200 | 3200 | 4000 | 4000 | 4700   | –      | –   | 4700 |
|  | 20 kA                  | [μF]                   | 500  | 500  | 500  | 500  | 1350 | 1350   | –      | –   | 1600 | 1600 | 2000 | 2000 | 2350   | –      | –   | 2350 |
|  | 50 kA                  | [μF]                   | 200  | 200  | 200  | 200  | 540  | 540    | –      | –   | 640  | 640  | 800  | 800  | 940    | –      | –   | 940  |
| Filament AC-5b   | 230/240V               | [A]                    | 12   | 16   | 18   | 22   | 30   | 37     | 18     | 25  | 43   | 51   | 60   | 70   | 76     | 60     | 75  | 90   |
| <b>Switching of Low Inductive Loads in Home Appliances and Similar Applications per IEC 61095 (50 Hz)</b>    |                        |                        |      |      |      |      |      |        |        |     |      |      |      |      |        |        |     |      |
| AC-7a  | 230V                   | [A]                    | 32   | 32   | 32   | 32   | 45   | 45     | –      | –   | 63   | 63   | –    | –    | –      | –      | –   | –    |
|  | 400V                   | [A]                    | 32   | 32   | 32   | 32   | 45   | 45     | –      | –   | 63   | 63   | –    | –    | –      | –      | –   | –    |
|  | 440V                   | [A]                    | 32   | 32   | 32   | 32   | 45   | 45     | –      | –   | 63   | 63   | –    | –    | –      | –      | –   | –    |
| <b>Switching of Motor Load for Home Appliances (50 Hz)</b>   |                        |                        |      |      |      |      |      |        |        |     |      |      |      |      |        |        |     |      |
| AC-7b  | 230V                   | [A]                    | 10.5 | 14   | 19   | 23   | 30   | –      | –      | –   | –    | –    | –    | –    | –      | –      | –   | –    |
|  | 400V                   | [A]                    | 9    | 12   | 16   | 20   | 30   | –      | –      | –   | –    | –    | –    | –    | –      | –      | –   | –    |
|  | 440V                   | [A]                    | 7.5  | 10   | 13.5 | 18   | 27   | –      | –      | –   | –    | –    | –    | –    | –      | –      | –   | –    |
| <b>Switching of Hermetically Sealed Cooling Compressor Motors - manual reset of overload release (50 Hz)</b> |                        |                        |      |      |      |      |      |        |        |     |      |      |      |      |        |        |     |      |
| AC-8a  | 400V                   | [A]                    | 12   | 16   | 22   | 32   | 38   | 45     | –      | –   | 63   | 63   | 72   | 85   | 100    | –      | –   | 115  |
|  | 500V                   | [A]                    | 12   | 16   | 22   | 32   | 38   | 45     | –      | –   | 63   | 63   | 72   | 85   | 100    | –      | –   | 115  |
|  | 690V                   | [A]                    | 8    | 10   | 14   | 20   | 28   | 35     | –      | –   | 42   | 42   | 56   | 67   | 80     | –      | –   | 90   |
| - automatic reset of overload release  |                        |                        |      |      |      |      |      |        |        |     |      |      |      |      |        |        |     |      |
| AC-8b  | 400V                   | [A]                    | 5.5  | 7    | 9.3  | 12   | 13   | 14     | –      | –   | 16   | 16   | 24   | 30   | 35     | –      | –   | 35   |
|  | 500V                   | [A]                    | 5.5  | 7    | 9.3  | 12   | 13   | 14     | –      | –   | 16   | 16   | 24   | 30   | 35     | –      | –   | 35   |
|  | 690V                   | [A]                    | 5.5  | 7    | 9.3  | 12   | 13   | 14     | –      | –   | 16   | 16   | 24   | 30   | 35     | –      | –   | 35   |
| <b>Switching of DC Loads</b>   |                        |                        |      |      |      |      |      |        |        |     |      |      |      |      |        |        |     |      |
| Non-inductive or slightly inductive loads or resistance furnaces DC-1, 60 °C (140 °F)                        |                        |                        |      |      |      |      |      |        |        |     |      |      |      |      |        |        |     |      |
| 1 pole   | 24V                    | [A]                    | 25   | 25   | 32   | 32   | 45   | 45     | 45     | 45  | 50   | 50   | 70   | 80   | 80     | 80     | 80  | 80   |
|  | 48/60V                 | [A]                    | 20   | 20   | 20   | 20   | 25   | 25     | 25     | 25  | 30   | 30   | 40   | 40   | 40     | 40     | 40  | 40   |
|  | 110V                   | [A]                    | 6    | 6    | 6    | 6    | 8    | 8      | 10     | 10  | 9    | 9    | 11   | 11   | 11     | 11     | 11  | 11   |
|  | 220V                   | [A]                    | 1.5  | 1.5  | 1.5  | 1.5  | 1.5  | 1.5    | 1.5    | 1.5 | 1.5  | 1.5  | 2    | 2    | 2      | 1.8    | 1.8 | 2    |
|  | 440V                   | [A]                    | 0.4  | 0.4  | 0.4  | 0.4  | 0.4  | 0.4    | 0.4    | 0.4 | 0.5  | 0.5  | 0.5  | 0.5  | 0.5    | 0.5    | 0.5 | 0.5  |
| 2 poles in series  | 24V                    | [A]                    | 25   | 25   | 32   | 32   | 45   | 45     | 45     | 45  | 50   | 50   | 70   | 80   | 80     | 80     | 80  | 80   |
|  | 48/60V                 | [A]                    | 25   | 25   | 32   | 32   | 45   | 45     | 45     | 45  | 50   | 50   | 70   | 80   | 80     | 80     | 80  | 80   |
|  | 110V                   | [A]                    | 25   | 25   | 32   | 32   | 45   | 45     | 45     | 45  | 50   | 50   | 70   | 80   | 80     | 80     | 80  | 80   |
|  | 220V                   | [A]                    | 8    | 8    | 8    | 10   | 10   | 10     | 10     | 10  | 10   | 10   | 15   | 15   | 15     | 15     | 15  | 15   |
|  | 440V                   | [A]                    | 1    | 1    | 1    | 1    | 1    | 1      | 1      | 1   | 1    | 1    | 1.5  | 1.5  | 1.5    | 1.5    | 1.5 | 1.5  |
| 3 poles in series  | 24V                    | [A]                    | 25   | 25   | 32   | 32   | 45   | 45     | –      | 45  | 63   | 63   | 90   | 90   | 100    | –      | 100 | 100  |
|  | 48/60V                 | [A]                    | 25   | 25   | 32   | 32   | 45   | 45     | –      | 45  | 63   | 63   | 90   | 90   | 100    | –      | 100 | 100  |
|  | 110V                   | [A]                    | 25   | 25   | 32   | 32   | 45   | 45     | –      | 45  | 63   | 63   | 90   | 90   | 100    | –      | 100 | 100  |
|  | 220V                   | [A]                    | 25   | 25   | 32   | 32   | 45   | 45     | –      | 45  | 50   | 50   | 70   | 80   | 80     | –      | 80  | 80   |
|  | 440V                   | [A]                    | 3    | 3    | 3    | 3    | 3.5  | 3.5    | –      | 3.5 | 4    | 4    | 5    | 5    | 5      | –      | 5   | 5    |

Table 16 - Main Circuits

|  |                     | 100/104-C, 100S/104S-C |             |             |             |             |             |             |             |             |             |             |             |             |             |        |      |             |
|--|---------------------|------------------------|-------------|-------------|-------------|-------------|-------------|-------------|-------------|-------------|-------------|-------------|-------------|-------------|-------------|--------|------|-------------|
|  |                     | 09                     | 12          | 16          | 23          | 30          | 37          | 40*200      | 40*400      | 43          | 55          | 60          | 72          | 85          | 90*200      | 90*400 | 97   |             |
| Coil Type:   | Conventional        | X                      | X           | X           | X           | X           | X           | X           | X           | X           | X           | X           | X           | X           | X           | X      | X    |             |
|  | Electronic – EI     | X                      | X           | X           | X           | X           | X           | X           | X           | X           | X           | X           | –           | –           | –           | –      | –    |             |
| <b>Switching of DC Loads, Continued</b>  |                     |                        |             |             |             |             |             |             |             |             |             |             |             |             |             |        |      |             |
| Shunt-wound Motors, Starting, reverse current braking, reversing, stepping DC-3, 60 °C (140 °F)  |                     |                        |             |             |             |             |             |             |             |             |             |             |             |             |             |        |      |             |
| 3 poles in series  | 24V                 | [A]                    | 25          | 25          | 32          | 32          | 45          | 45          | –           | –           | 63          | 63          | 90          | 90          | 100         | –      | –    | 100         |
|  | 48/60V              | [A]                    | 25          | 25          | 32          | 32          | 45          | 45          | –           | –           | 50          | 50          | 70          | 70          | 80          | –      | –    | 80          |
|  | 110V                | [A]                    | 20          | 20          | 25          | 25          | 30          | 30          | –           | –           | 35          | 35          | 70          | 70          | 80          | –      | –    | 80          |
|  | 220V                | [A]                    | 6           | 6           | 6           | 10          | 15          | 15          | –           | –           | 20          | 20          | 25          | 25          | 30          | –      | –    | 30          |
|  | 440V                | [A]                    | 0.6         | 0.6         | 0.6         | 0.6         | 0.6         | 0.6         | –           | –           | 0.6         | 0.6         | 0.6         | 0.6         | 0.6         | –      | –    | 0.6         |
| Series-wound Motors, Starting, reverse current braking, reversing, stepping DC-5, 60 °C (140 °F) |                     |                        |             |             |             |             |             |             |             |             |             |             |             |             |             |        |      |             |
| 3 poles in series  | 24V                 | [A]                    | 25          | 25          | 32          | 32          | 45          | 45          | –           | –           | 63          | 63          | 90          | 90          | 100         | –      | –    | 100         |
|  | 48/60V              | [A]                    | 25          | 25          | 32          | 32          | 45          | 45          | –           | –           | 50          | 50          | 70          | 70          | 80          | –      | –    | 80          |
|  | 110V                | [A]                    | 20          | 20          | 25          | 25          | 30          | 30          | –           | –           | 35          | 35          | 70          | 70          | 80          | –      | –    | 80          |
|  | 220V                | [A]                    | 6           | 6           | 6           | 10          | 15          | 15          | –           | –           | 20          | 20          | 25          | 25          | 30          | –      | –    | 30          |
|  | 440V                | [A]                    | 0.6         | 0.6         | 0.6         | 0.6         | 0.6         | 0.6         | –           | –           | 0.6         | 0.6         | 0.6         | 0.6         | 0.6         | –      | –    | 0.6         |
| <b>Short Time Withstand <math>I_{CW}</math>, 60 °C (140 °F)</b>                                  |                     |                        |             |             |             |             |             |             |             |             |             |             |             |             |             |        |      |             |
| 3- and 4-pole  | 10 s                | [A]                    | 170         | 170         | 170         | 215         | 300         | 304         | 304         | 304         | 375         | 375         | 700         | 700         | 700         | 700    | 700  | 840         |
| <b>Resistance and Power Dissipation</b>  |                     |                        |             |             |             |             |             |             |             |             |             |             |             |             |             |        |      |             |
| Main current circuit resistance  | [mΩ]                | 2.7                    | 2.7         | 2.7         | 2           | 2           | 2           | 2           | 1.5         | 1.5         | 1           | 0.9         | 0.9         | 0.9         | 0.8         | 0.7    | 0.6  |             |
| Power dissipation by all circuits at $I_e$ AC-3/400V   | [W]                 | 0.66                   | 1.2         | 2.1         | 3.2         | 5.4         | 8.2         | 11.3        | 8.4         | 8.3         | 9.1         | 9.7         | 14          | 19.5        | 11.6        | 20.2   | 17   |             |
| Total power dissipation At $I_e$ AC-3/400V   | AC control          | [W]                    | 3.4         | 3.9         | 4.8         | 6.3         | 8.5         | 11.3        | 8.8         | 9.5         | 11.6        | 12.4        | 14.2        | 18.5        | 24          | 20.6   | 29.2 | 26          |
|  | DC control (conv.)  | [W]                    | –           | –           | –           | –           | –           | –           | –           | –           | –           | –           | 13.7        | 18          | 23.5        | 16.6   | 25.2 | 22          |
|  | DC control (elect.) | [W]                    | 2.4         | 2.9         | 3.8         | 4.9         | 7.1         | 9.9         | 8           | 8.7         | 10.8        | 11.6        | –           | –           | –           | –      | –    | –           |
| <b>Lifespan</b>  |                     |                        |             |             |             |             |             |             |             |             |             |             |             |             |             |        |      |             |
| Mechanical AC control  | [Million ops.]      | 13                     | 13          | 13          | 13          | 13          | 13          | 10          | 10          | 12          | 12          | 6           | 6           | 6           | 6           | 6      | 6    |             |
| Mechanical DC control  | [Million ops.]      | 13                     | 13          | 13          | 13          | 13          | 13          | 10          | 10          | 13          | 13          | 6           | 6           | 6           | 6           | 6      | 6    |             |
| Electrical AC-3 (400 V)  | [Million ops.]      | 1.3                    | 1.3         | 1.3         | 1.3         | 1.3         | 1.3         | –           | –           | 1           | 0.8         | 1           | 1           | 1           | –           | –      | 1    |             |
| <b>Weight</b>  |                     |                        |             |             |             |             |             |             |             |             |             |             |             |             |             |        |      |             |
| AC   | Non-Rev.            | [kg (lbs)]             | 0.39 (0.86) | 0.39 (0.86) | 0.39 (0.86) | 0.39 (0.86) | 0.48 (1.06) | 0.49 (1.08) | 0.63 (1.39) | 0.63 (1.39) | 0.51 (1.12) | 0.51 (1.12) | 1.45 (3.20) | 1.45 (3.20) | 1.45 (3.20) | –      | –    | 1.45 (3.20) |
|  | Rev.                | [kg (lbs)]             | 0.85 (1.89) | 0.85 (1.89) | 0.85 (1.89) | 0.85 (1.89) | 1.08 (2.39) | 1.08 (2.39) | –           | –           | 1.15 (2.54) | 1.15 (2.54) | 3.14 (6.92) | 3.14 (6.92) | 3.14 (6.92) | –      | –    | 3.14 (6.92) |
| DC   | Non-Rev.            | [kg (lbs)]             | 0.6 (1.32)  | –           | –           | –           | –           | –           | –           | –           | –           | –           | 1.47 (3.24) | 1.47 (3.24) | 1.47 (3.24) | –      | –    | 1.47 (3.24) |
|  | Rev.                | [kg (lbs)]             | 1.27 (2.81) | –           | –           | –           | –           | –           | –           | –           | –           | –           | 3.22 (7.1)  | 3.22 (7.1)  | 3.22 (7.1)  | –      | –    | 3.22 (7.1)  |
| DC (Electronic-E0, EJ)   | Non-Rev.            | [kg (lbs)]             | 0.40 (0.88) | 0.40 (0.88) | 0.40 (0.88) | 0.40 (0.88) | 0.40 (0.88) | 0.49 (1.08) | 0.49 (1.08) | 0.57 (1.25) | 0.57 (1.25) | 0.57 (1.25) | –           | –           | –           | –      | –    | –           |
|  | Rev.                | [kg (lbs)]             | 0.87 (1.91) | 0.87 (1.91) | 0.87 (1.91) | 0.87 (1.91) | 0.87 (1.91) | 1.08 (2.39) | 1.08 (2.39) | –           | 1.27 (2.79) | 1.27 (2.79) | –           | –           | –           | –      | –    | –           |
| DC (Electronic- EW, EY, ED, EA)  | Non-Rev.            | [kg (lbs)]             | 0.43 (0.95) | 0.43 (0.95) | 0.43 (0.95) | 0.43 (0.95) | 0.43 (0.95) | 0.52 (1.14) | 0.52 (1.14) | 0.60 (1.32) | 0.60 (1.32) | 0.60 (1.32) | –           | –           | –           | –      | –    | –           |
|  | Rev.                | [kg (lbs)]             | 0.93 (2.05) | 0.93 (2.05) | 0.93 (2.05) | 0.93 (2.05) | 0.93 (2.05) | 1.14 (2.51) | 1.14 (2.51) | –           | 1.33 (2.93) | 1.33 (2.93) | –           | –           | –           | –      | –    | –           |

Table 17 - Conductors

|   |                        |                    | 100/104-C, 100S/104S-C   |    |    |           |    |    |           |        |    |          |    |    |          |    |  |
|---|------------------------|--------------------|--|----|----|-----------|----|----|-----------|--------|----|----------|----|----|----------|----|--|
|   |                        |                    | 09   | 12 | 16 | 23        | 30 | 37 | 40        | 43     | 55 | 60       | 72 | 85 | 90       | 97 |  |
| <b>Coil Type:</b>   | <b>Conventional</b>    |                    | X  | X  | X  | X         | X  | X  | X         | X      | X  | X        | X  | X  | X        |    |  |
|   | <b>Electronic – EI</b> |                    | X  | X  | X  | X         | X  | X  | X         | X      | X  | –        | –  | –  | –        |    |  |
| Conductor Cross Sections - Main Contacts Terminal type                            |                        |                    | <br>(1)   |    |    |           |    |    |           |        |    |          |    |    |          |    |  |
|  | 1 conductor            | [mm <sup>2</sup> ] |  |    |    | 1...4     |    |    | 2.5...10  |        |    | 2.5...16 |    |    | 2.5...35 |    |  |
|   | 2 conductors           | [mm <sup>2</sup> ] | 1...4  |    |    | 2.5...10  |    |    | 2.5...10  |        |    | 2.5...25 |    |    |          |    |  |
|  | 1 conductor            | [mm <sup>2</sup> ] | 1.5...6  |    |    | 2.5...16  |    |    | 2.5...25  |        |    | 2.5...50 |    |    |          |    |  |
|   | 2 conductors           | [mm <sup>2</sup> ] | 1.5...6  |    |    | 2.5...16  |    |    | 2.5...16  |        |    | 2.5...35 |    |    |          |    |  |
| Recommended torque  |                        | [N•m]              | 1.5...2.0  |    |    | 2.5...3.5 |    |    | 2.5...3.5 |        |    | 4.5...6  |    |    |          |    |  |
| Cross section per UL/CSA  |                        | [AWG]              | 16...10  |    |    | 14...4    |    |    | 14...6    | 14...4 |    | 14...1   |    |    |          |    |  |
| Recommended torque  |                        | [lb•in]            | 13.3...17.7  |    |    | 22...31   |    |    | 22...31   |        |    | 40...53  |    |    |          |    |  |
| Conductor Cross Sections - Coil Terminal type                                     |                        |                    | <br>(1) |    |    |           |    |    |           |        |    |          |    |    |          |    |  |
|  | 1 conductor            | [mm <sup>2</sup> ] |  |    |    |           |    |    | 1...2.5   |        |    |          |    |    |          |    |  |
|   | 2 conductors           | [mm <sup>2</sup> ] |  |    |    |           |    |    | 1...2.5   |        |    |          |    |    |          |    |  |
|  | 1 conductor            | [mm <sup>2</sup> ] |  |    |    |           |    |    | 1...4     |        |    |          |    |    |          |    |  |
|   | 2 conductors           | [mm <sup>2</sup> ] |  |    |    |           |    |    | 1...4     |        |    |          |    |    |          |    |  |
| Recommended torque  |                        | [N•m]              |  |    |    |           |    |    | 1...1.5   |        |    |          |    |    |          |    |  |
| Cross section per UL/CSA  |                        | [AWG]              |  |    |    |           |    |    | 16...12   |        |    |          |    |    |          |    |  |
| Recommended torque  |                        | [lb•in]            |  |    |    |           |    |    | 9...13    |        |    |          |    |    |          |    |  |

(1) Pozidriv No. 2 / Blade No. 3 screw  
 (2) Pozidriv No. 2 / Blade No. 4 screw  
 (3) Hexagonal socket screw



Table 18 - Short-Circuit Coordination Data<sup>(1)</sup>

|  |  | 100/104-C, 100S/104S-C        |                                |                   |                   |                    |                    |                   |        |                    |                   |                    |                    |                    |        |        |                    |     |
|--|--|-------------------------------|--------------------------------|-------------------|-------------------|--------------------|--------------------|-------------------|--------|--------------------|-------------------|--------------------|--------------------|--------------------|--------|--------|--------------------|-----|
|  |  | 09                            | 12                             | 16                | 23                | 30                 | 37                 | 40*200            | 40*400 | 43                 | 55                | 60                 | 72                 | 85                 | 90*200 | 90*400 | 97                 |     |
| Coil Type:   | Conventional                                     | X                             | X                              | X                 | X                 | X                  | X                  | X                 | X      | X                  | X                 | X                  | X                  | X                  | X      | X      | X                  |     |
|  | Electronic - EI                                  | X                             | X                              | X                 | X                 | X                  | X                  | X                 | X      | X                  | X                 | -                  | -                  | -                  | -      | -      | -                  |     |
| <b>Short Circuit Coordination (Max. Fuse or Circuit Breaker Rating) Per IEC 60947-4-1 (contactor and fuses only)</b> |  |                               |                                |                   |                   |                    |                    |                   |        |                    |                   |                    |                    |                    |        |        |                    |     |
| DIN Fuses- gG, gL  | Type"1"(690V)                                    | [A]                           | 50 kA Available Fault Current  |                   |                   |                    |                    |                   |        |                    |                   |                    |                    |                    |        |        |                    |     |
|  | Type"2"(400V)                                    | [A]                           | 50                             | 50                | 50                | 80                 | 125                | 125               | 160    | 160                | 160               | 160                | 250                | 250                | 250    | 250    | 250                | 250 |
|  | Type"2"(690V)                                    | [A]                           | 25                             | 35                | 35                | 40                 | 80                 | 80                | 63     | 80                 | 100               | 100                | 160                | 160                | 160    | 160    | 100                | 200 |
| BS88Fuses  | Type"1"(415V)                                    | [A]                           | 65kA Available Fault Current   |                   |                   |                    |                    |                   |        |                    |                   |                    |                    |                    |        |        |                    |     |
|  | Type"2"(415V)                                    | [A]                           | 25                             | 32                | 40                | 50                 | 63                 | 80                | -      | -                  | 80                | TBD                | 100                | 160                | 160    | -      | -                  | TBD |
|  | Type"2"(415V)                                    | [A]                           | 20                             | 25                | 32                | 50                 | 63                 | 80                | -      | -                  | 80                | TBD                | 100                | 125                | 160    | -      | -                  | TBD |
| <b>Per UL 508 and CSA 22.2 No. 14 (contactor and fuses or circuit breaker only)</b>                                  |  |                               |                                |                   |                   |                    |                    |                   |        |                    |                   |                    |                    |                    |        |        |                    |     |
| UL Class K5 and RK5 Fuses  | UL Listed Combination (600V)                     | [A]                           | 5 kA Available Fault Current   |                   |                   |                    |                    |                   |        |                    |                   |                    |                    |                    |        |        |                    |     |
|  |  | [A]                           | 35                             | 40                | 70                | 90                 | 110                | 125               | 125    | 125                | 150               | 200                | 200                | -                  | -      | -      | -                  | -   |
| UL Class CC and CSA HRCl-MISC Fuses  | UL verified combination to IEC60947-4-1 "Type2"  | [A]                           | 10 kA Available Fault Current  |                   |                   |                    |                    |                   |        |                    |                   |                    |                    |                    |        |        |                    |     |
|  |  | [A]                           | -                              | -                 | -                 | -                  | -                  | -                 | -      | -                  | -                 | -                  | -                  | 250                | 300    | 300    | 300                | 350 |
| UL Class J and CSA HRCl-J Fuses  | UL verified combination to IEC60947-4-1 "Type 2" | [A]                           | 100 kA Available Fault Current |                   |                   |                    |                    |                   |        |                    |                   |                    |                    |                    |        |        |                    |     |
|  |  | [A]                           | 20 <sup>(2)</sup>              | 20                | 30                | 40                 | -                  | -                 | -      | -                  | -                 | -                  | -                  | -                  | -      | -      | -                  | -   |
| UL Inverse-time Circuit Breaker  | UL Listed Combination (480V)                     | [A]                           | 5 kA Available Fault Current   |                   |                   |                    |                    |                   |        |                    |                   |                    |                    |                    |        |        |                    |     |
|  |  | [A]                           | 30                             | 30                | 50                | 50                 | 125                | 125               | -      | -                  | 125               | 150                | 250                | -                  | -      | -      | -                  | -   |
|  | UL Listed Combination (600V)                     | [A]                           | 10 kA Available Fault Current  |                   |                   |                    |                    |                   |        |                    |                   |                    |                    |                    |        |        |                    |     |
|  |  | [A]                           | -                              | -                 | -                 | -                  | -                  | -                 | -      | -                  | -                 | -                  | -                  | 250                | 250    | -      | -                  | 250 |
|  | UL Listed Combination (600V/347V)                | [A]                           | 18 kA Available Fault Current  |                   |                   |                    |                    |                   |        |                    |                   |                    |                    |                    |        |        |                    |     |
|  |  | [A]                           | -                              | -                 | -                 | -                  | -                  | -                 | -      | -                  | -                 | -                  | -                  | -                  | -      | -      | -                  | -   |
|  | UL Listed Combination (600V)                     | [A]                           | 25 kA Available Fault Current  |                   |                   |                    |                    |                   |        |                    |                   |                    |                    |                    |        |        |                    |     |
|  |  | [A]                           | 30 <sup>(3)</sup>              | 30 <sup>(3)</sup> | 30 <sup>(3)</sup> | 30 <sup>(3)</sup>  | 50 <sup>(4)</sup>  | 50 <sup>(4)</sup> | -      | -                  | 50 <sup>(4)</sup> | -                  | 110                | 110                | 110    | -      | -                  | -   |
|  | UL Listed Combination (480V)                     | [A]                           | 50 kA Available Fault Current  |                   |                   |                    |                    |                   |        |                    |                   |                    |                    |                    |        |        |                    |     |
| [A]  |  | -                             | -                              | -                 | -                 | 50 <sup>(4)</sup>  | 50 <sup>(4)</sup>  | -                 | -      | 50 <sup>(4)</sup>  | -                 | -                  | -                  | -                  | -      | -      | -                  |     |
| UL Listed Combination (480V/277V)  | [A]  | 65 kA Available Fault Current |                                |                   |                   |                    |                    |                   |        |                    |                   |                    |                    |                    |        |        |                    |     |
|  | [A]  | 30 <sup>(3)</sup>             | 30 <sup>(3)</sup>              | 30 <sup>(3)</sup> | 30 <sup>(3)</sup> | -                  | -                  | -                 | -      | -                  | -                 | -                  | -                  | -                  | -      | -      | -                  |     |
| UL Listed Combination (480V)   | [A]  | 50 kA Available Fault Current |                                |                   |                   |                    |                    |                   |        |                    |                   |                    |                    |                    |        |        |                    |     |
|  | [A]  | -                             | -                              | -                 | -                 | 100 <sup>(5)</sup> | 100 <sup>(5)</sup> | -                 | -      | 100 <sup>(5)</sup> | 125               | 200 <sup>(5)</sup> | 225 <sup>(5)</sup> | 225 <sup>(5)</sup> | -      | -      | 225 <sup>(5)</sup> |     |

(1) See the Rockwell Automation Global SCCR Tool at [rok.auto/sccr](http://rok.auto/sccr) for complete short-circuit current ratings.  
 (2) 15 A max. fuse for Type 2 coordination.  
 (3) Ratings apply when used with Bulletin 140U-D circuit breakers only.  
 (4) Minimum enclosure size 12-3/8 x 7-5/8 s 7-1/4 inches  
 (5) Minimum enclosure size 20 x 12 x 8 inches with two latches.

Table 19 - Coil Data

|                                   |                        |                     | 100/104-C, 100S/104S-C |          |         |         |          |            |         |        |                |         |            |                |         |         |        |    |
|-----------------------------------|------------------------|---------------------|------------------------|----------|---------|---------|----------|------------|---------|--------|----------------|---------|------------|----------------|---------|---------|--------|----|
|                                   |                        |                     | 09                     | 12       | 16      | 23      | 30       | 37         | 40*200  | 40*400 | 43             | 55      | 60         | 72             | 85      | 90*200  | 90*400 | 97 |
| <b>Coil Type:</b>                 | <b>Conventional</b>    |                     | X                      | X        | X       | X       | X        | X          | X       | X      | X              | X       | X          | X              | X       | X       | X      | X  |
|                                   | <b>Electronic - EI</b> |                     | X                      | X        | X       | X       | X        | X          | X       | X      | X              | -       | -          | -              | -       | -       | -      | -  |
| <b>Operating Limits</b>           |                        |                     |                        |          |         |         |          |            |         |        |                |         |            |                |         |         |        |    |
| 50 Hz, 60 Hz,<br>50/60 Hz         | pick-up                | [x U <sub>s</sub> ] | 0.85...1.1             |          |         |         |          | 0.85...1.1 |         |        |                |         | 0.85...1.1 |                |         |         |        |    |
|                                   | dropout                | [x U <sub>s</sub> ] | 0.3...0.6              |          |         |         |          | 0.3...0.6  |         |        |                |         | 0.3...0.6  |                |         |         |        |    |
| DC (conventional)                 | pick-up                | [x U <sub>s</sub> ] | -                      |          |         |         |          | -          |         |        |                |         | 0.8...1.1  |                |         |         |        |    |
|                                   | dropout                | [x U <sub>s</sub> ] | -                      |          |         |         |          | -          |         |        |                |         | 0.1...0.6  |                |         |         |        |    |
| DC (electronic—EQ,<br>EJ, EW)     | pick-up                | [x U <sub>s</sub> ] | 0.7...1.25             |          |         |         |          | -          |         |        |                |         | -          |                |         |         |        |    |
|                                   | dropout                | [x U <sub>s</sub> ] | 0.3...0.4              |          |         |         |          | -          |         |        |                |         | -          |                |         |         |        |    |
| DC (electronic—EY)                | pick-up                | [x U <sub>s</sub> ] | 0.8...1.25             |          |         |         |          | -          |         |        |                |         | -          |                |         |         |        |    |
|                                   | dropout                | [x U <sub>s</sub> ] | 0.3...0.4              |          |         |         |          | -          |         |        |                |         | -          |                |         |         |        |    |
| DC (electronic—ED)                | pick-up                | [x U <sub>s</sub> ] | 0.7...1.12             |          |         |         |          | -          |         |        |                |         | -          |                |         |         |        |    |
|                                   | dropout                | [x U <sub>s</sub> ] | 0.3...0.4              |          |         |         |          | -          |         |        |                |         | -          |                |         |         |        |    |
| DC (electronic—EA)                | pick-up                | [x U <sub>s</sub> ] | 0.8...1.1              |          |         |         |          | -          |         |        |                |         | -          |                |         |         |        |    |
|                                   | dropout                | [x U <sub>s</sub> ] | 0.3...0.4              |          |         |         |          | -          |         |        |                |         | -          |                |         |         |        |    |
| <b>Coil Consumption</b>           |                        |                     |                        |          |         |         |          |            |         |        |                |         |            |                |         |         |        |    |
| 50 Hz, 60 Hz,<br>50/60 Hz         | pick-up                | [VA]                | 75                     | 105      |         |         | 135      |            |         | 235    |                |         | 400        |                |         |         |        |    |
|                                   | hold-in                | [VA/W]              | 9.5/2.7                | 12.3/3.1 |         |         | 13.3/3.3 |            |         | 19.6/5 |                |         | 24/9       |                |         |         |        |    |
| DC (conventional)                 | pick-up                | [W]                 | -                      | -        |         |         | -        |            |         | 200    |                |         | 325        |                |         |         |        |    |
|                                   | hold-in                | [W]                 | -                      | -        |         |         | -        |            |         | 4      |                |         | 5          |                |         |         |        |    |
| DC (electronic—EQ,<br>EJ)         | pick-up<br>(avg/peak)  | [W]                 | 10/17                  |          |         |         |          | 16/25      |         |        |                |         | -          |                |         |         |        |    |
|                                   | hold-in                | [W]                 | 1.7                    |          |         |         |          | 2.5        |         |        |                |         | -          |                |         |         |        |    |
| DC (electronic—EY,<br>EW)         | pick-up<br>(avg/peak)  | [W]                 | 10/17                  |          |         |         |          | 16/25      |         |        |                |         | -          |                |         |         |        |    |
|                                   | hold-in                | [W]                 | 1.9                    |          |         |         |          | 2.7        |         |        |                |         | -          |                |         |         |        |    |
| DC (electronic—ED)                | pick-up<br>(avg/peak)  | [W]                 | 12/19                  |          |         |         |          | 16/26      |         |        |                |         | -          |                |         |         |        |    |
|                                   | hold-in                | [W]                 | 2.1                    |          |         |         |          | 2.8        |         |        |                |         | -          |                |         |         |        |    |
| DC (electronic—EA)                | pick-up<br>(avg/peak)  | [W]                 | 14/22                  |          |         |         |          | 18/29      |         |        |                |         | -          |                |         |         |        |    |
|                                   | hold-in                | [W]                 | 3.0                    |          |         |         |          | 4.0        |         |        |                |         | -          |                |         |         |        |    |
| <b>Operating Times</b>            |                        |                     |                        |          |         |         |          |            |         |        |                |         |            |                |         |         |        |    |
| AC                                | closing delay          | [ms]                | 15...30                | 15...30  | 15...30 | 15...30 |          |            |         |        | 20...40        |         |            | 20...40        |         |         |        |    |
|                                   | opening delay          | [ms]                | 10...60                | 10...60  | 10...60 | 10...60 |          |            |         |        | 10...60        |         |            | 20...40        |         |         |        |    |
| With RC module                    | closing delay          | [ms]                | 10...60                | 10...60  | 10...60 | 10...60 |          |            | 10...60 |        |                | 20...40 |            |                |         |         |        |    |
| DC (conventional)                 | opening delay          | [ms]                | -                      | -        | -       | -       |          |            | 50...80 |        |                | 20...40 |            | 15...25        | 20...25 | 20...25 |        |    |
|                                   | closing delay          | [ms]                | -                      | -        | -       | -       |          |            | 7...15  |        |                | 20...40 |            | 15...25        | 20...25 | 20...25 |        |    |
| With integrated diode             | opening delay          | [ms]                | -                      | -        | -       | -       |          |            | 17...23 |        | ≤ 220V 20...35 |         |            | ≤ 220V 20...35 |         |         |        |    |
| With external diode               | opening delay          | [ms]                | -                      | -        | -       | -       |          | 80...125   |         | -      |                |         | -          |                |         |         |        |    |
| DC (electronic—EQ,<br>EJ)         | closing delay          | [ms]                | 20...50                |          |         |         |          | -          |         |        |                |         | -          |                |         |         |        |    |
|                                   | opening delay          | [ms]                | 20...50                |          |         |         |          | -          |         |        |                |         | -          |                |         |         |        |    |
|                                   | Max. Ripple            |                     | ±15%                   |          |         |         |          | -          |         |        |                |         | -          |                |         |         |        |    |
|                                   | min. OFF time          | [ms]                | 50                     |          |         |         |          | -          |         |        |                |         | -          |                |         |         |        |    |
| DC (electronic—EW,<br>EY, ED, EA) | closing delay          | [ms]                | 20...50                |          |         |         |          | -          |         |        |                |         | -          |                |         |         |        |    |
|                                   | opening delay          | [ms]                | 23...33                |          |         |         |          | -          |         |        |                |         | -          |                |         |         |        |    |
|                                   | Max. Ripple            |                     | ±15%                   |          |         |         |          | -          |         |        |                |         | -          |                |         |         |        |    |
|                                   | min. OFF time          | [ms]                | 50                     |          |         |         |          | -          |         |        |                |         | -          |                |         |         |        |    |

**Table 20 - Auxiliary Contacts, Auxiliary Contact Blocks, and Pneumatic Timers**

|  |                   |     | Internal                                | Front mounted                           | Front mounted (Bifurcated) | Side-mounted |
|--|-------------------|-----|---|---|----------------------------|--------------|
| <b>Switching of AC Loads</b>   |                   |     |   |   |                            |              |
| AC-12 $I_{th}$   | at 40 °C (104 °F) | [A] | 20                                      | 10                                      | 10                         | 10           |
|  | at 60 °C (140 °F) | [A] | 20                                      | 6                                       | 6                          | 6            |
| AC-15 at rated voltage of  | 24V               | [A] | 10                                      | 6                                       | 3                          | 6            |
|  | 42/48V            | [A] | 10                                      | 6                                       | 3                          | 6            |
|  | 120V              | [A] | 10                                      | 6                                       | 3                          | 6            |
|  | 230V              | [A] | 10                                      | 5.5                                     | 3                          | 5.5          |
|  | 240V              | [A] | 10                                      | 5                                       | 3                          | 5            |
|  | 400V              | [A] | 6                                       | 3                                       | 2                          | 3            |
|  | 415V              | [A] | 6                                       | 3                                       | 2                          | 3            |
|  | 500V              | [A] | 2.5                                     | 1.6                                     | 1.2                        | 1.6          |
| 690V   | [A]               | 1   | 1                                       | 0.7                                     | 1                          |              |
| <b>Switching of DC Loads</b>   |                   |     |   |   |                            |              |
| DC-12 L/R < 1 ms resistive loads at                                    | 24V DC            | [A] | 12                                      | 12                                      | 6                          | 6            |
|  | 48V DC            | [A] | 9                                       | 9                                       | 3.2                        | 3.2          |
|  | 110V DC           | [A] | 3.5                                     | 3.5                                     | 1                          | 1            |
|  | 220V DC           | [A] | 0.55                                    | 0.55                                    | 0.5                        | 0.5          |
|  | 440V DC           | [A] | 0.2                                     | 0.2                                     | 0.2                        | 0.2          |
| DC-14L/R <15 ms inductive loads with economy resistor in series at     | 24V DC            | [A] | 9                                       | 9                                       | 2                          | 2            |
|  | 48V DC            | [A] | 5                                       | 5                                       | 1.6                        | 1.6          |
|  | 110V DC           | [A] | 2                                       | 2                                       | 0.3                        | 0.3          |
|  | 220V DC           | [A] | 0.4                                     | 0.4                                     | 0.12                       | 0.12         |
|  | 440V DC           | [A] | 0.16                                    | 0.16                                    | 0.05                       | 0.05         |
| DC-13 switching electromagnets at                                      | 24V DC            | [A] | 5                                       | 5                                       | 2.5                        | 5            |
|  | 48V DC            | [A] | 3                                       | 3                                       | 1.5                        | 2.5          |
|  | 110V DC           | [A] | 1.2                                     | 1.2                                     | 0.6                        | 0.68         |
|  | 220V DC           | [A] | 0.6                                     | 0.6                                     | 0.3                        | 0.32         |
|  | 440V DC           | [A] | 0.3                                     | 0.15                                    | 0.15                       | 0.15         |
| <b>Fuse gG</b>   |                   |     |   |   |                            |              |
| Short-circuit protection with no welding of contacts per IEC 60947-5-1 |                   | [A] | 20                                      | 10                                      | 10                         | 10           |
|  |                   | [A] | 20                                      | 10                                      | 10                         | 10           |
| Protective Separation per IEC 60947-1, Annex N                         |                   |     | between load and auxiliary circuit 320V | between load and auxiliary circuit 440V |                            |              |
| Min. switching capacity according to IEC 60947-5-4                     |                   |     | 17V/10mA                                | 17V/5mA                                 | 5V/3mA                     | 17V/10mA     |
| <b>Load Carrying Capacity per UL/CSA</b>                               |                   |     |   |   |                            |              |
| Rated voltage  | AC                | [V] | max.600                                 |   |                            |              |
| Continuous rating  | 40 °C (104 °F)    | [A] | 10                                      | 10                                      | 10                         | 10           |
| Switching capacity   | AC                | [A] | A600                                    |   |                            |              |
| Rated voltage  | DC                | [V] | max.600                                 |   |                            |              |
| Switching capacity   | DC                | [A] | P600                                    | Ø600                                    | Ø600                       |              |

**Table 21 - General Specifications**

| Attribute   |             | Value   |
|---|-------------|---|
| <b>Rated Isolation Voltage U<sub>i</sub></b>      |             |   |
| IEC   | [V]         | 690   |
| UL, CSA   | [V]         | 600   |
| Rated Impulse Voltage Withstand U <sub>imp</sub>  | [kV]        | 6   |
| <b>Rated Voltage U<sub>e</sub></b>                |             |   |
| AC 50/60 Hz                                       | [V]         | 115, 200, 230, 240, 400, 415, 460, 500, 575, 690  |
| DC  | [V]         | 24, 48, 110, 220, 440   |
| Insulation Class of the Coil                      |             | Class F per IEC 60085, UL Class 105   |
| Rated coil frequency                              |             | AC 50/60Hz, DC  |
| Ambient Temperature                               |             |   |
| Storage   | [ °C ( °F)] | -55...+80 (-67...176)   |
| Operation at rated voltage                        | [ °C ( °F)] | -40...+60 (-40...140)   |
| at 70 °C (158 °F)                                 |             | 15% current reduction against 60 °C (140 °F) values   |
| Climatic Withstand                                |             | IEC 60068-2-1/-2/-30  |
| Max. Altitude of Installation Site                | [m]         | 2000 NN, per IEC60947-1   |
| Protection Class                                  |             | 100-C09...C23: IP2X from all directions<br>100-C30...C55: IP2X from front with front (upper) terminal wired<br>100-C60...C97: IP2X from front with front (upper) terminal wired (min. wire size 16 mm <sup>2</sup> or #6 AWG) |
| Single contactor cover                            |             | —   |
| Contactor with frame terminal block               |             | —   |
| Auxiliary contact                                 |             | IP2X  |
| Protection against Accidental Contact             |             | Finger- and back-of-hand proof per VDE0106, part100   |
| Resistance to Shock                               |             | IEC60068-2-27   |
| Resistance to Vibration                           |             | IEC60068-2-6  |
| Mechanically Linked Contacts IEC60947-5-1,Annex L |             | 100-/100S-C09...C55+100-FA/-FB/-FC, (except L11, L22),100-/100S-C09...C55+ 100-FAB/-FBB/-FCB  |
| Mirror Contacts IEC60947-4-1, Annex F             |             | 100-/100S-C09...C97+100-FA/-FB/-FC, (except L11, L22),100-/100S-C09...C97+ 100-SA/SB, 100-/100S-C09...C97+100-FAB/-FBB/-FCB   |

**Table 22 - Standards Compliance and Certifications**

| Standards Compliance   | Certifications                                   |
|--|--|
| <b>100-C IEC Contactors</b>  |  |
| EN/IEC 60947-4-1, 60947-5-1  | CE Marked  |
| IEC 60947 Type "2" Coordination  | CCC  |
| CSA 22.2. No. 14   | cULus Listed (File No. E3125; Guide NLDX, NLDX7) |
| UL 508   |  |
| Meets the material restrictions for European Directive 2002/95/IEC-EU-RoHS |  |

| Standards Compliance   | Certifications                                   |
|--|--|
| <b>100S-C IEC Safety Contactors</b>  |  |
| EN50205  | CE Marked  |
| CSA C22.2 No. 14   | SUVA Third-Party Certified                       |
| UL 508   | cULus Listed (File No. E3125; Guide NLDX, NLDX7) |
| EN/IEC 60947-4   |  |
| IEC 60947-4-1 Annex F – Mirror Contacts                                    |  |
| IEC 60947-5-1 Annex L – Mechanically Linked Contacts                       |  |
| Meets the material restrictions for European Directive 2002/95/IEC-EU-RoHS |  |

# Life-Load Curves

Bulletin 100-C/104-C IEC contactors are designed for superior performance in a wide variety of applications. When selecting IEC products, the user must give consideration to the specific load, utilization category, and required electrical life of the application. The life-load curves shown here are based on Rockwell Automation tests according to the requirements defined in IEC 60947-4-1. Since contact life in application is dependent on environmental conditions and duty cycle, actual application contact life may vary from that indicated by the curves shown here.

To find the estimated electrical life of the contactor, follow these guidelines:

1. Identify the appropriate utilization category from [Table 23](#).
2. Choose the graph for the utilization category selected.
3. Locate the intersection of the life-load curve for the appropriate contactor with the application's operational current ( $I_e$ ) found on the horizontal axis.
4. Read the estimated contact life along the vertical axis.

## Contact Life for Mixed Utilization Categories AC-3 and AC-4:

In many applications, the utilization category cannot be defined as either purely AC-3 or AC-4. In those applications, the electrical life of the contactor can be estimated from the following equation:

$$L_{\text{mixed}} = L_{\text{ac3}} / [1 + P_{\text{ac4}} * (L_{\text{ac3}} / L_{\text{ac4}} - 1)], \text{ where:}$$

$L_{\text{mixed}}$  = Approximate contact life in operations for a mixed AC-3/AC-4 utilization category application

$L_{\text{ac3}}$  = Approximate contact life in operations for a pure AC-3 utilization category (from the AC-3 life-load curves)

$L_{\text{ac4}}$  = Approximate contact life in operations for a pure AC-4 utilization category (from the AC-4 life-load curves)

$P_{\text{ac4}}$  = Percentage of AC-4 operations

**Table 23 - Utilization Category Determination**

| Test Conditions |   | Making               |         |             | Breaking  |           |             |      |
|-----------------|---|----------------------|---------|-------------|-----------|-----------|-------------|------|
|                 |   | $I/I_e$              | $U/U_e$ | $\cos \phi$ | $I_c/I_e$ | $U_r/U_e$ | $\cos \phi$ |      |
| AC-1            | Resistance Furnaces:<br>Non inductive or slightly inductive loads                   | 1                    | 1       | 0.95        | 1         | 1         | 0.95        |      |
| AC-2            | Slip-ring motors:<br>Starting and reversing   | 2.5                  | 1       | 0.65        | 2.5       | 1         | 0.65        |      |
| AC-3            | Squirrel-cage motors:<br>Starting and stopping of running motors                    | $I_e < 17 \text{ A}$ | 6       | 1           | 0.65      | 1         | 0.17        | 0.65 |
|                 |   | $I_e > 17 \text{ A}$ | 6       | 1           | 0.35      | 1         | 0.17        | 0.35 |
| AC-4            | Squirrel-cage motors:<br>Starting, plugging <sup>(1)</sup> , inching <sup>(2)</sup> | $I_e < 17 \text{ A}$ | 6       | 1           | 0.65      | 6         | 1           | 0.65 |
|                 |   | $I_e > 17 \text{ A}$ | 6       | 1           | 0.35      | 6         | 1           | 0.35 |
| AC-15           | Solenoids:<br>Contactors, valves and lifting magnets                                | 10                   | 1       | 0.7         | 1         | 1         | 0.4         |      |

(1) Plugging is understood as stopping or reversing the motor rapidly by reversing motor primary connections while the motor is running.

(2) Inching (jogging) is understood as energizing a motor once or repeatedly for short periods to obtain small movements of the driven mechanism.

- $I_e$  Rated operational current
- $I_c$  Breaking Current
- $U_e$  Rated voltage
- $I$  Making Current
- $U$  Off-load voltage
- $U_r$  Recovery voltage

Figure 11 - AC-1, 40 °C (104 °F) Non- or slightly inductive loads, resistance furnaces;  $U_e = 230...690V$

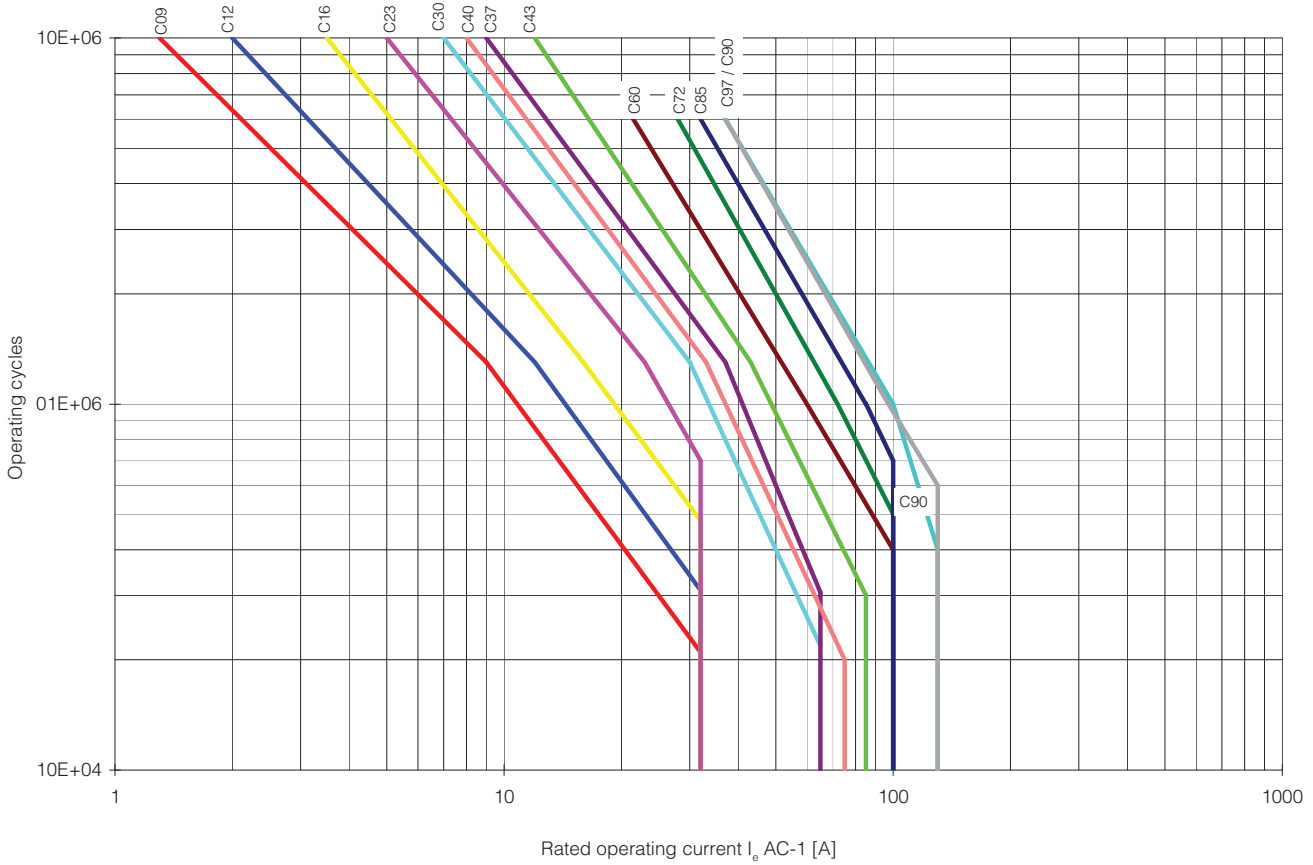


Figure 12 - AC-2, Switching of slip-ring motors;  $U_e = 230...400...460V$

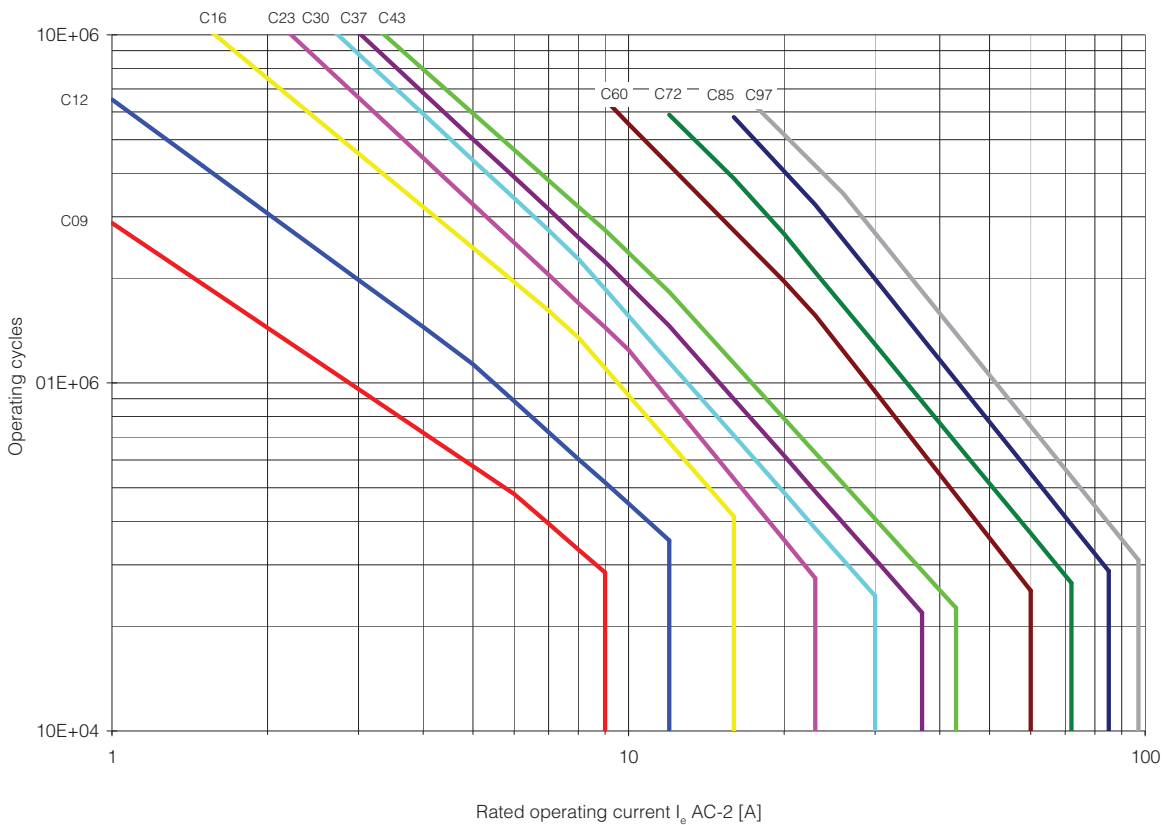


Figure 13 - AC-3, Switching of squirrel-cage motors while starting;  $U_e = 230...400...460V$

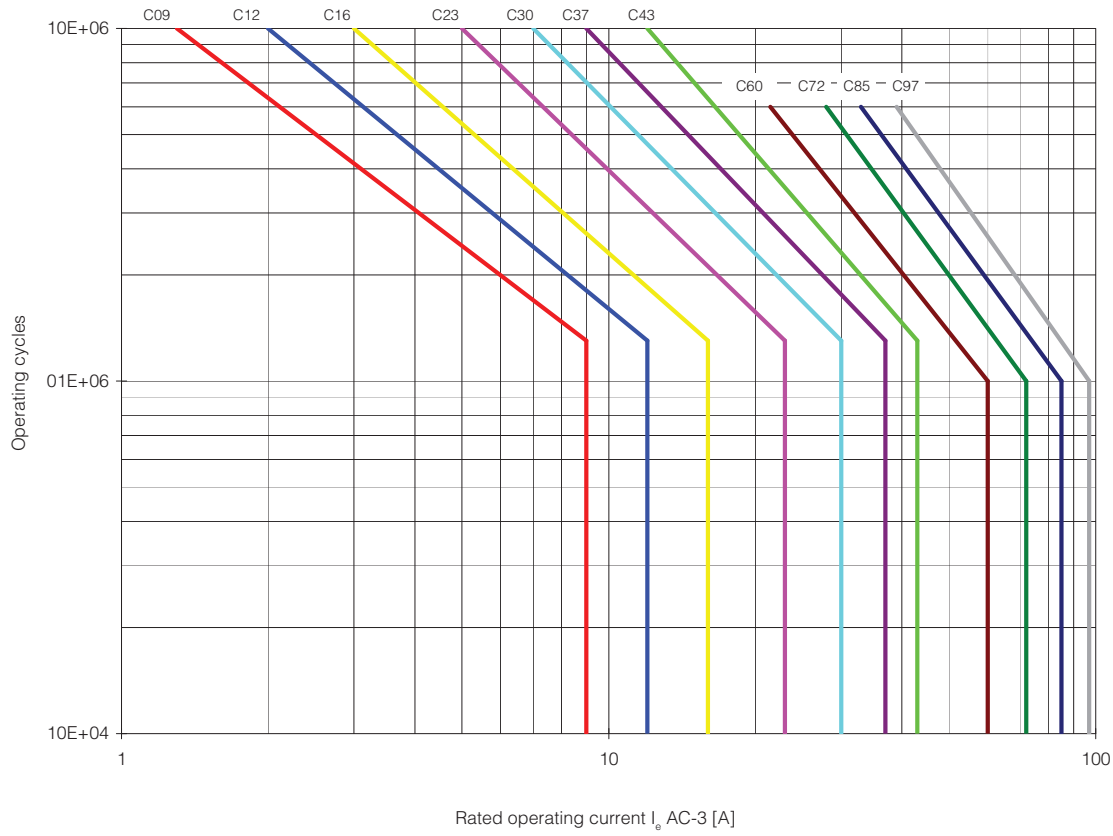


Figure 14 - AC-3, Switching of squirrel-cage motors while starting;  $U_e = 500...575V$

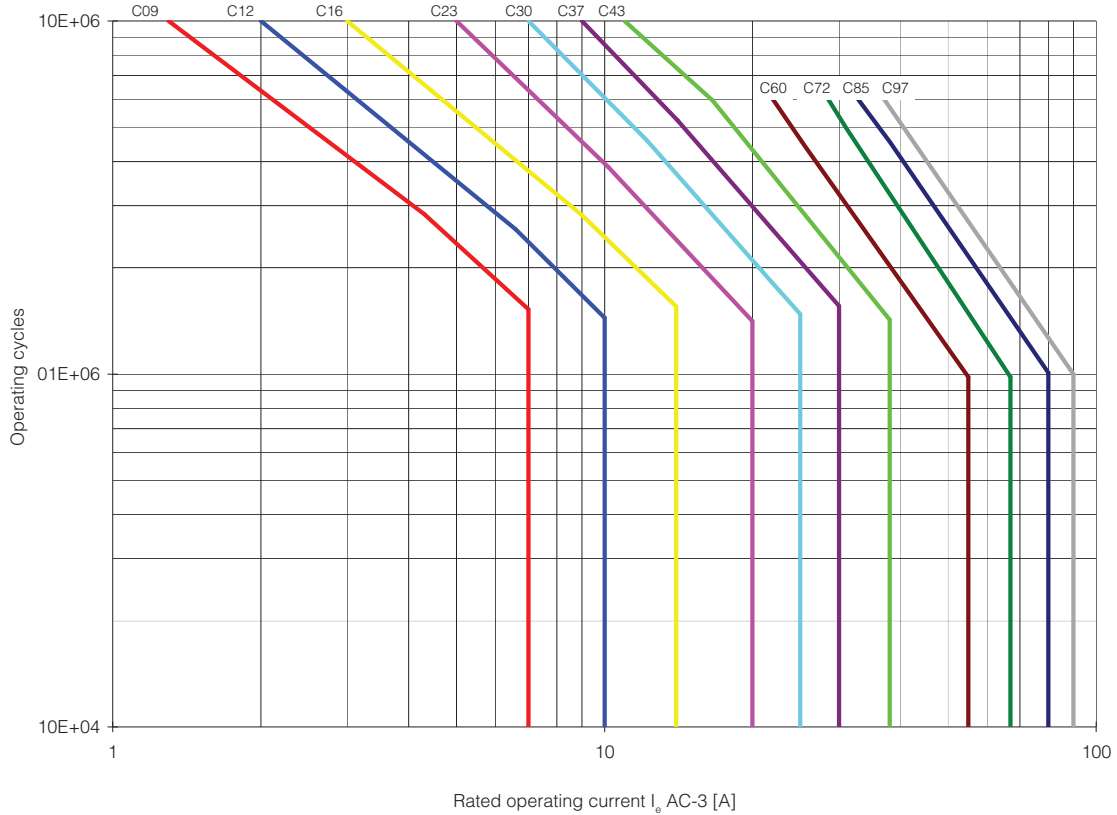


Figure 15 - AC-3, Switching of squirrel-cage motors while starting;  $U_e = 690V$

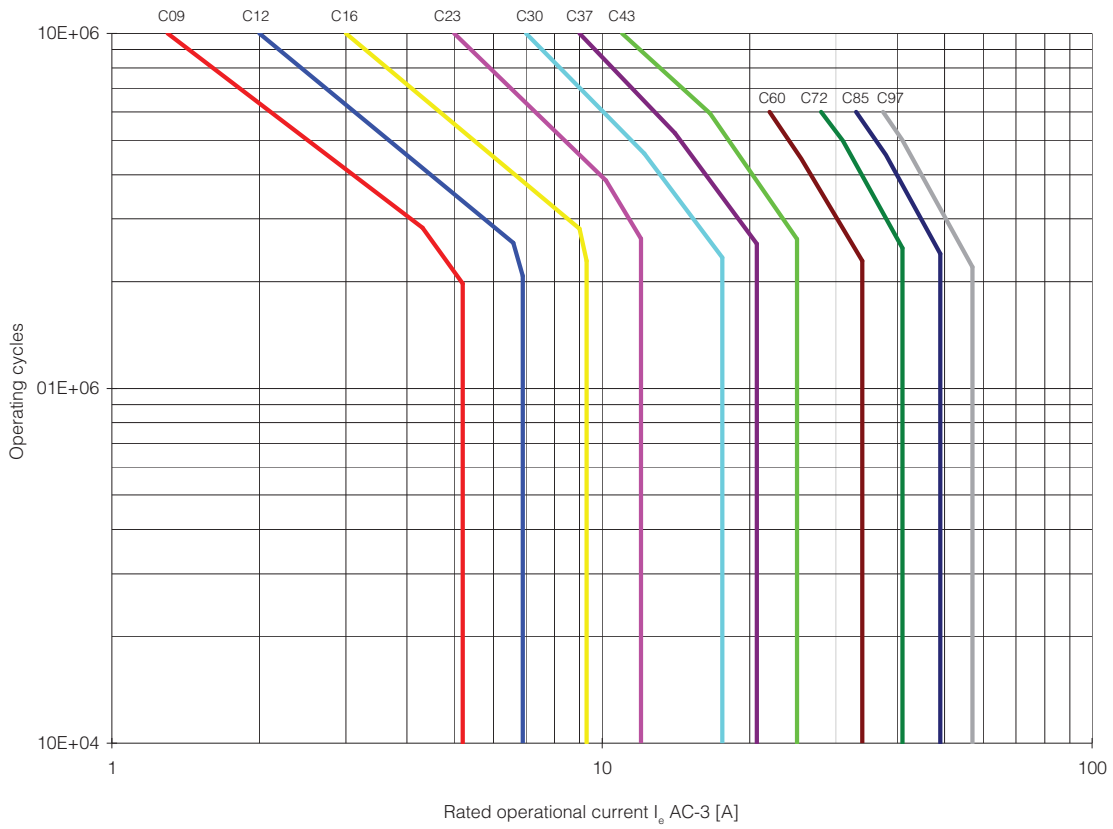


Figure 16 - AC-4, Switching of squirrel-cage motors;  $U_e = 230...690V$

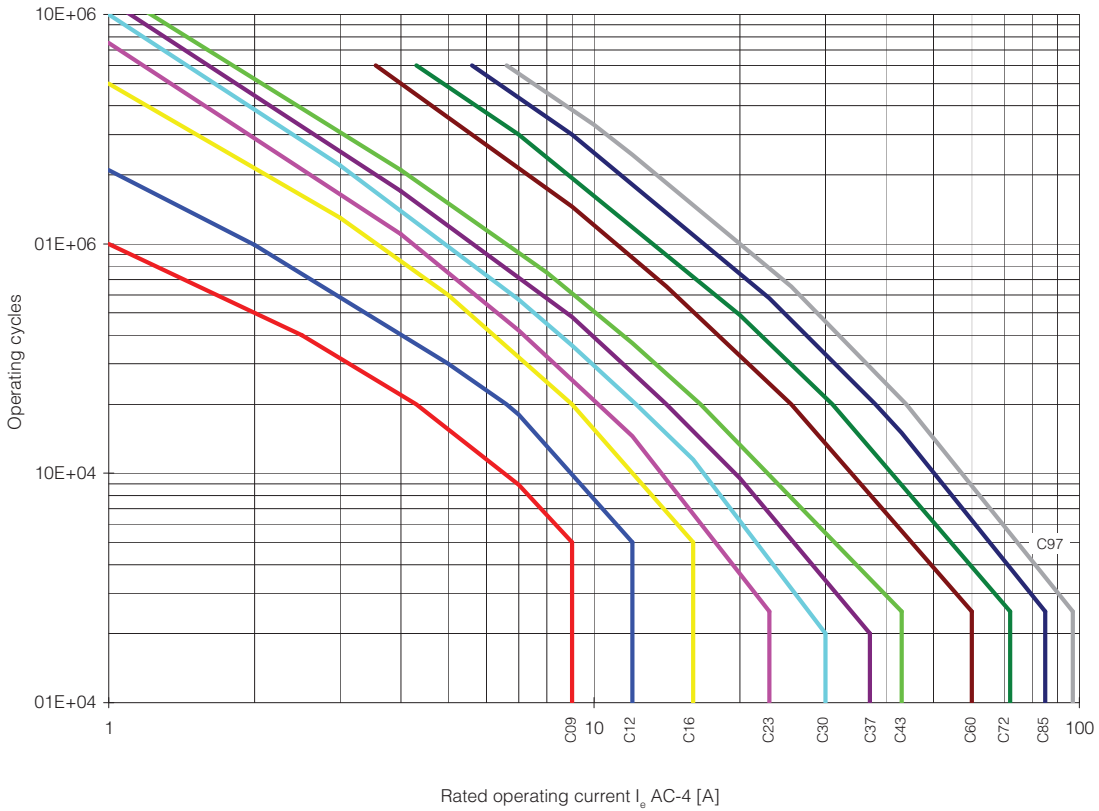




Figure 17 - AC-3 & AC-4, 10% AC-4 Mixed operation of squirrel-cage motors;  $U_e = 230...400...460V$

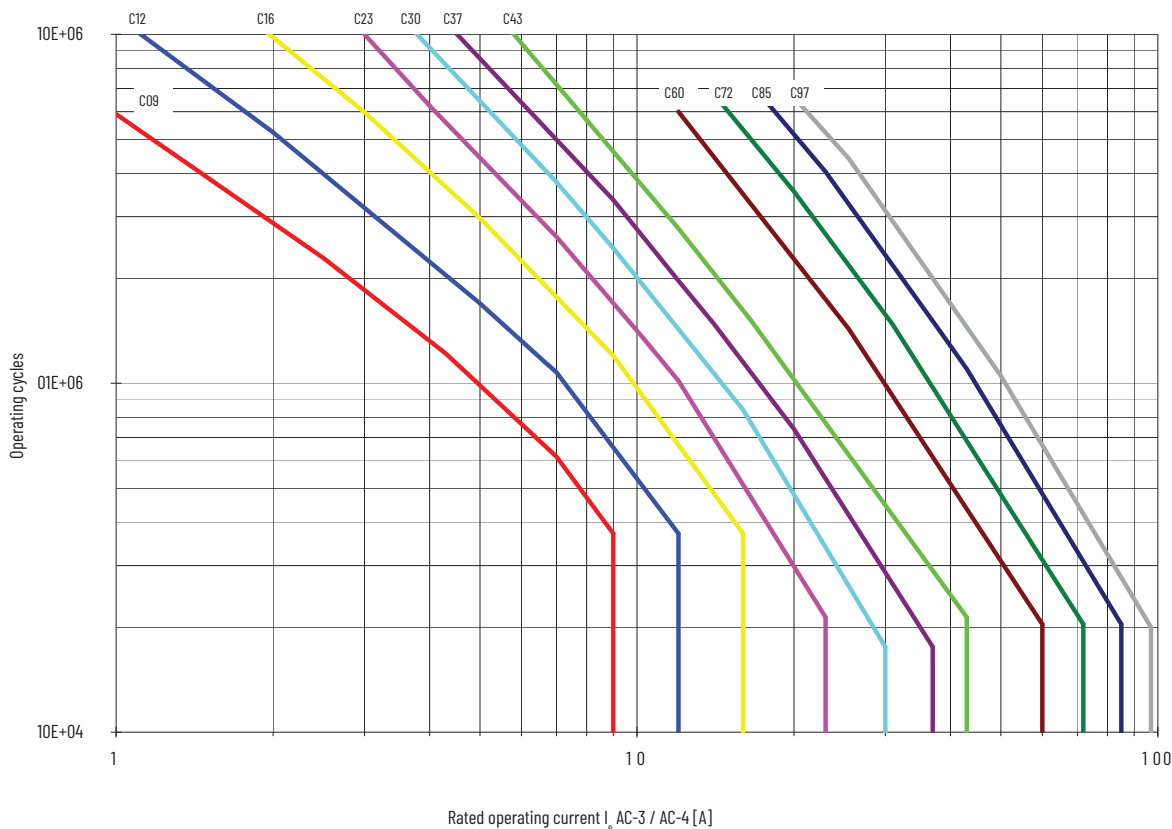
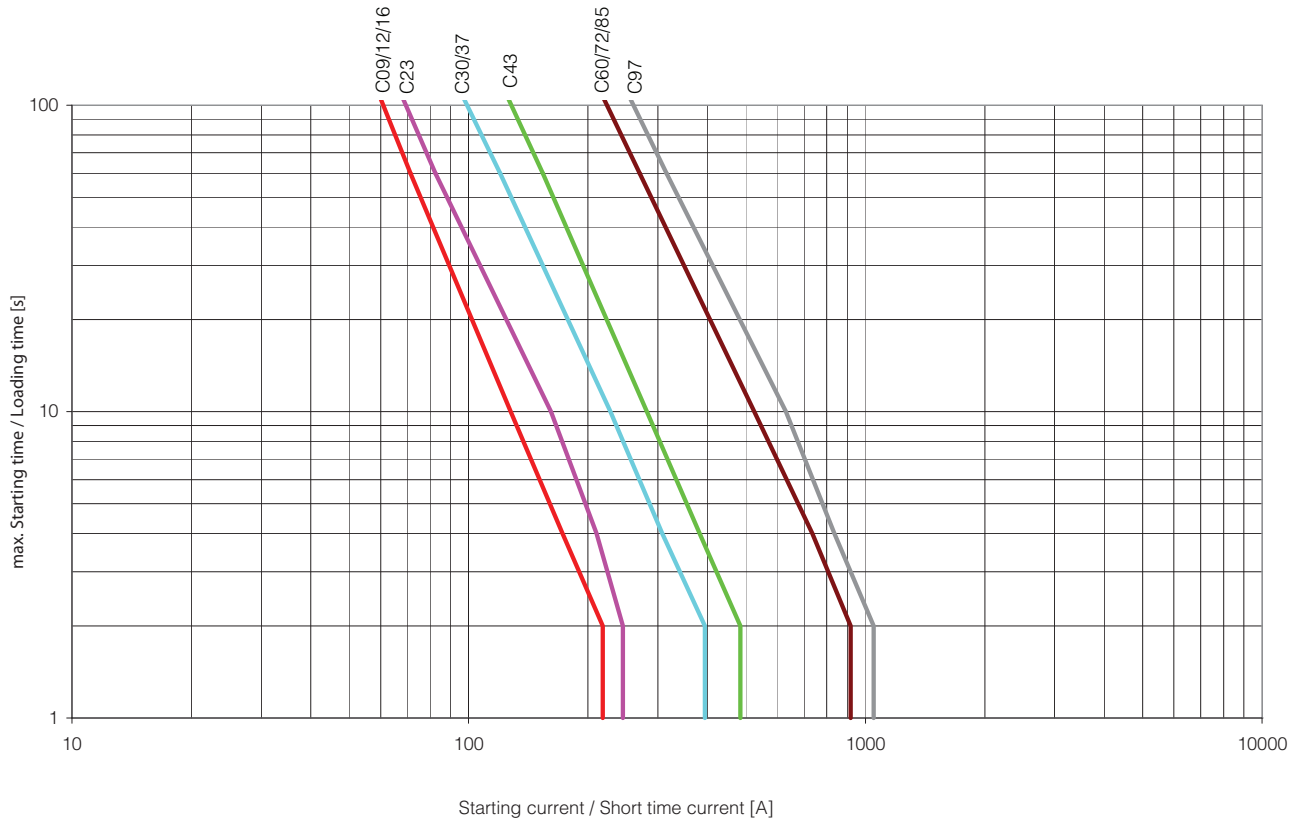


Figure 18 - Heavy Duty Starting and Regular Short-time Operation



# Maximum Operating Rates

Figure 19 - AC-1, 40 °C (104 °F) Non- or slightly inductive loads, resistance furnaces;  $U_e = 230...690V$

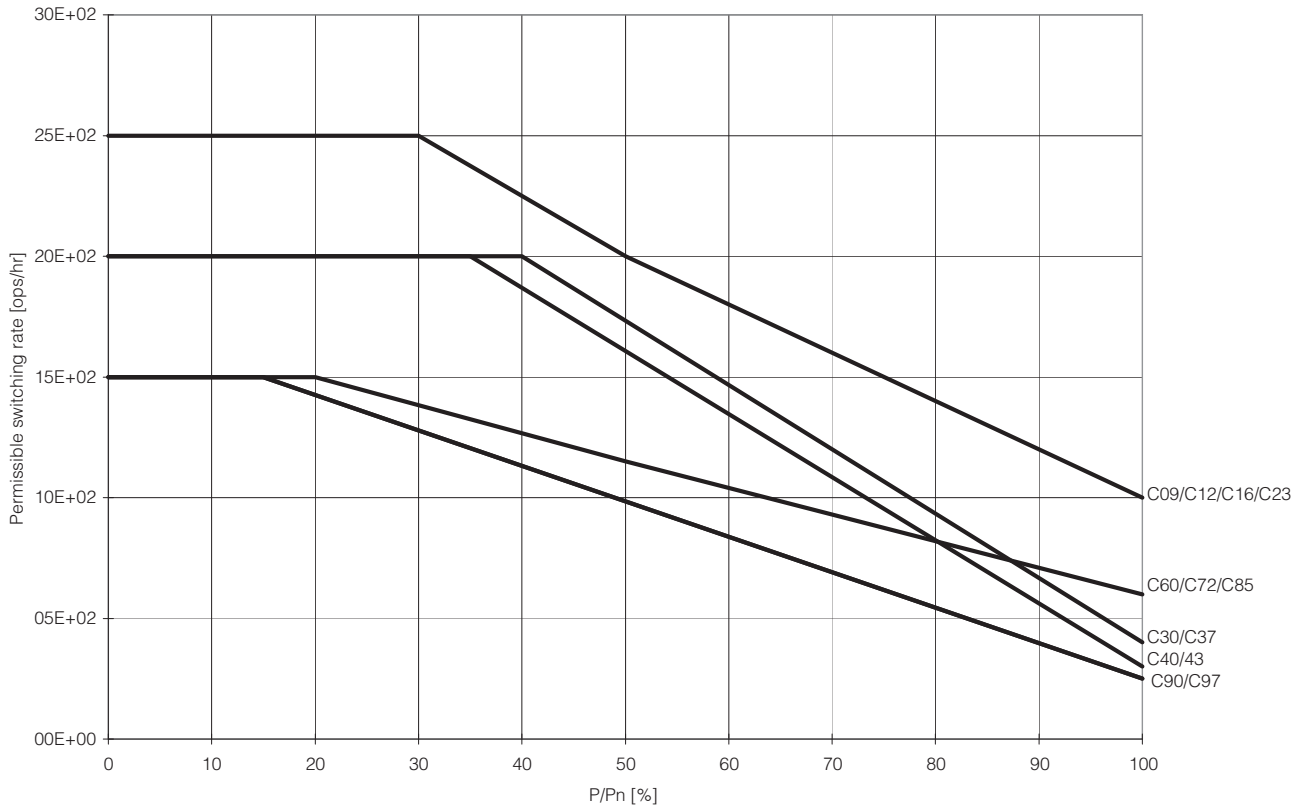
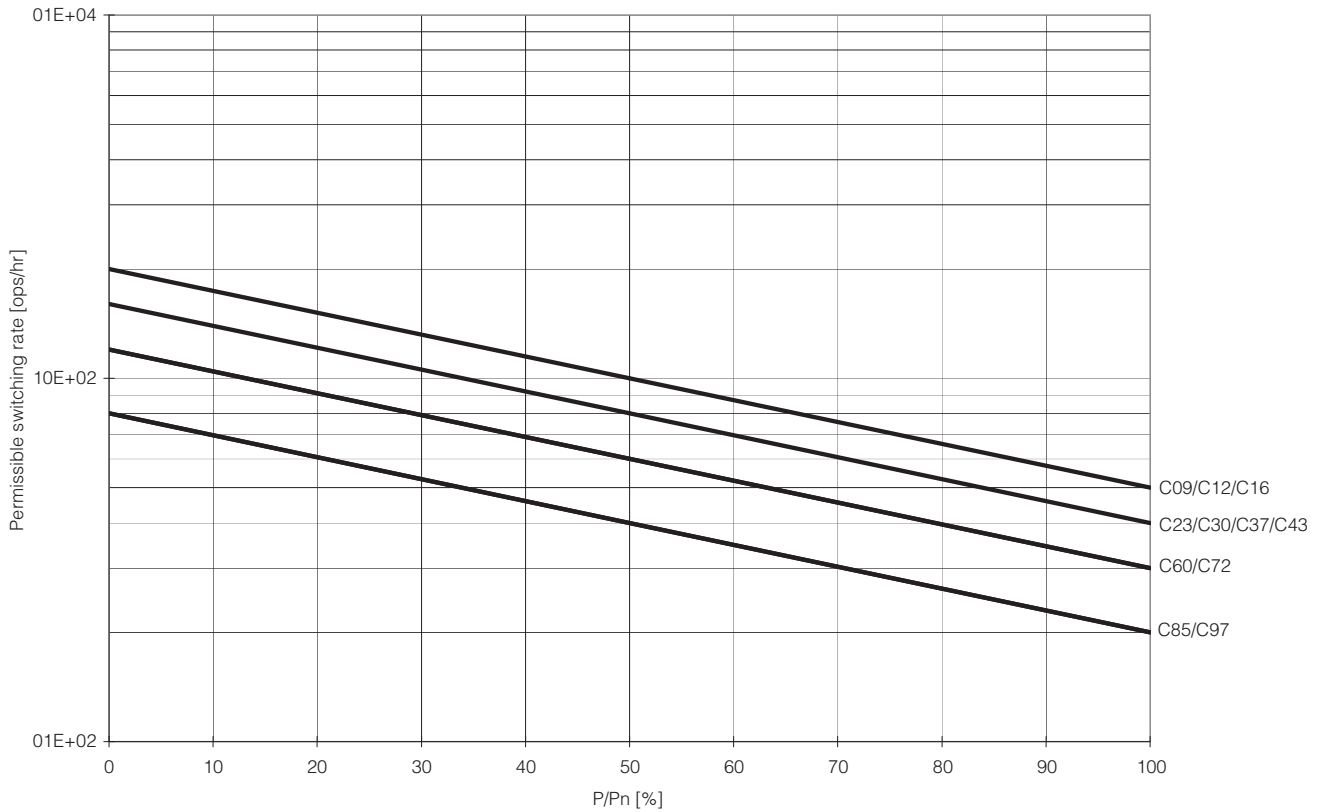
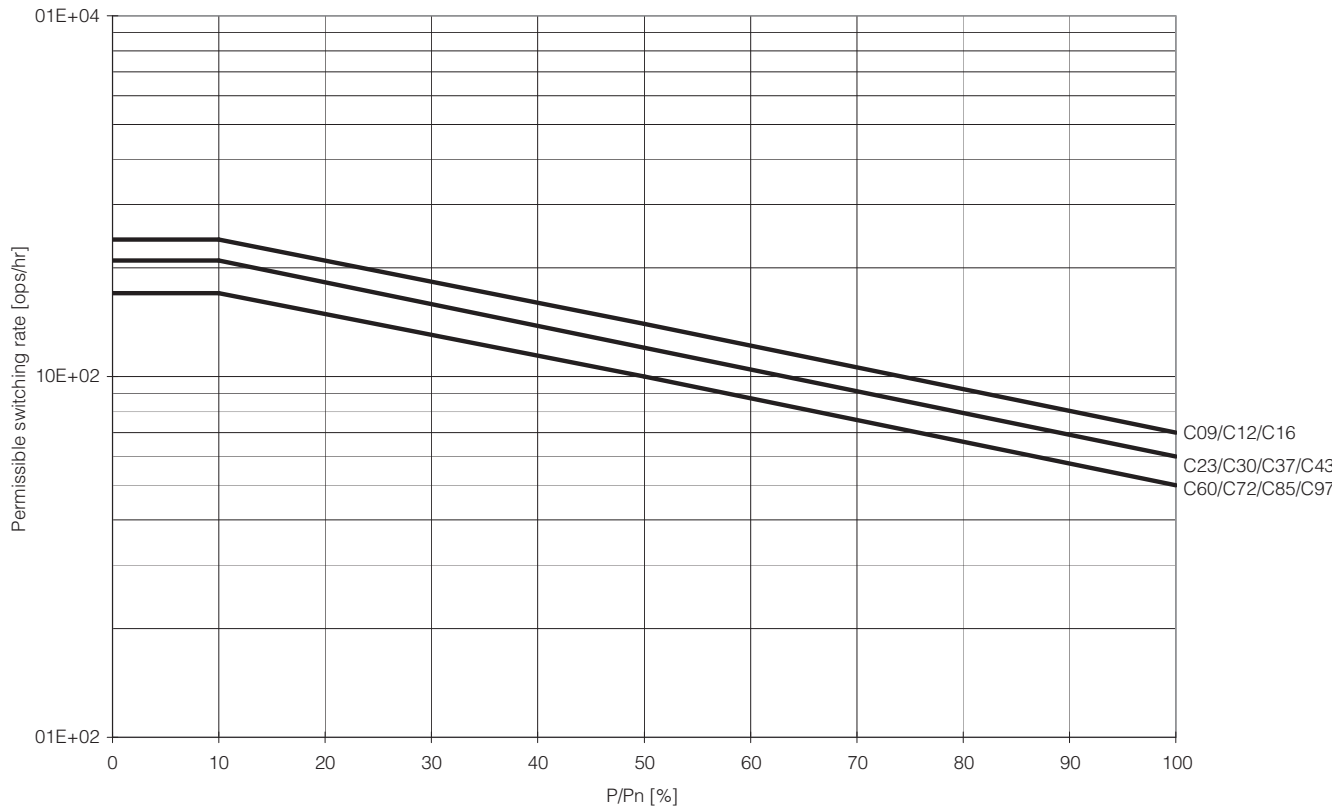


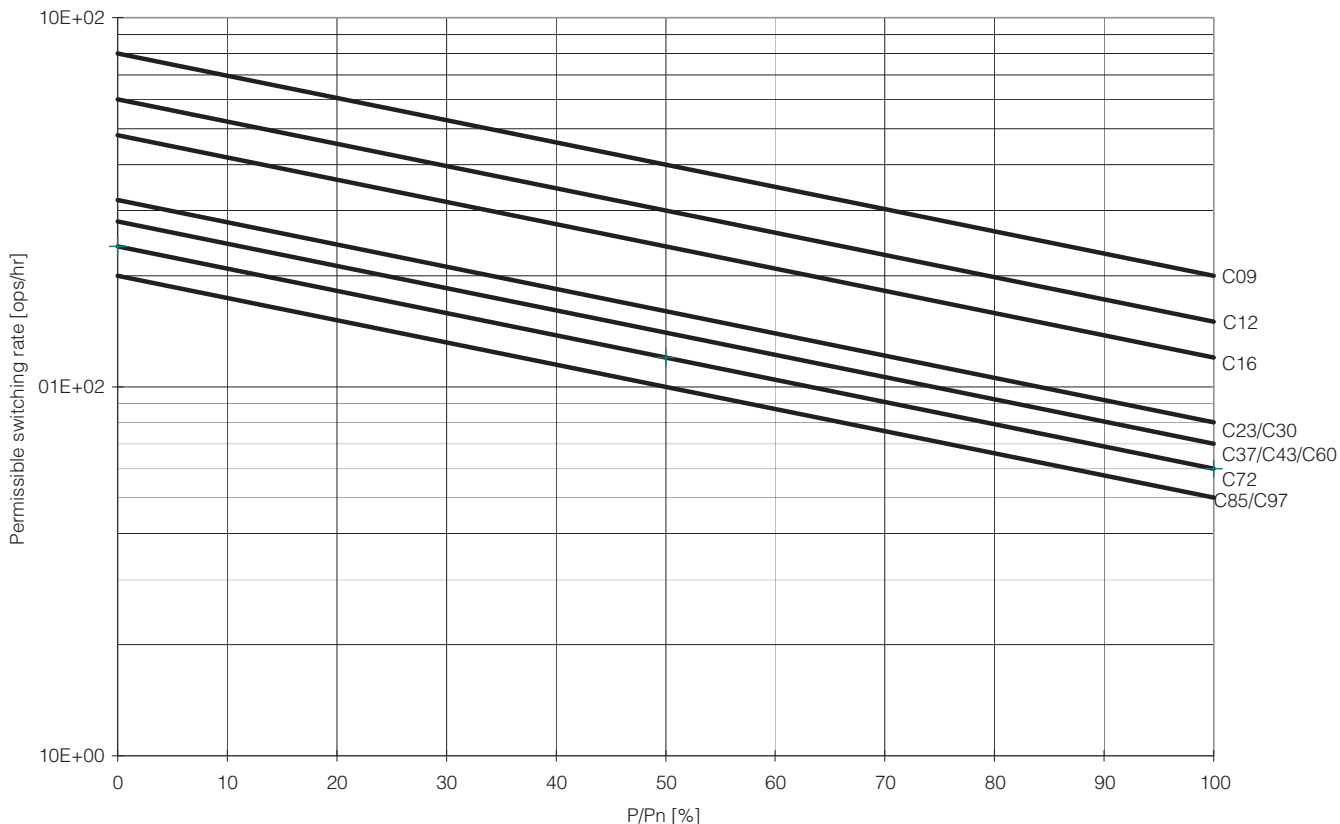
Figure 20 - AC-2, Stepping of slip-ring motors;  $U_e = 230...460V$



**Figure 21 - AC-3, Switching of squirrel-cage motors while starting;  $U_e = 230...460V$ ;  
Relative operating time 40%, Starting time  $t_A = 0.25 s$**



**Figure 22 - AC-4, Inching of squirrel-cage motors;  $U_e = 230...460V$ , Starting time  $t_A = 0.25 s$**



# Approximate Dimensions

Dimensions are shown in millimeters (inches). Dimensions are not intended for manufacturing purposes.

Figure 23 - Bulletin 100-C/100S-C Contactors and Accessories

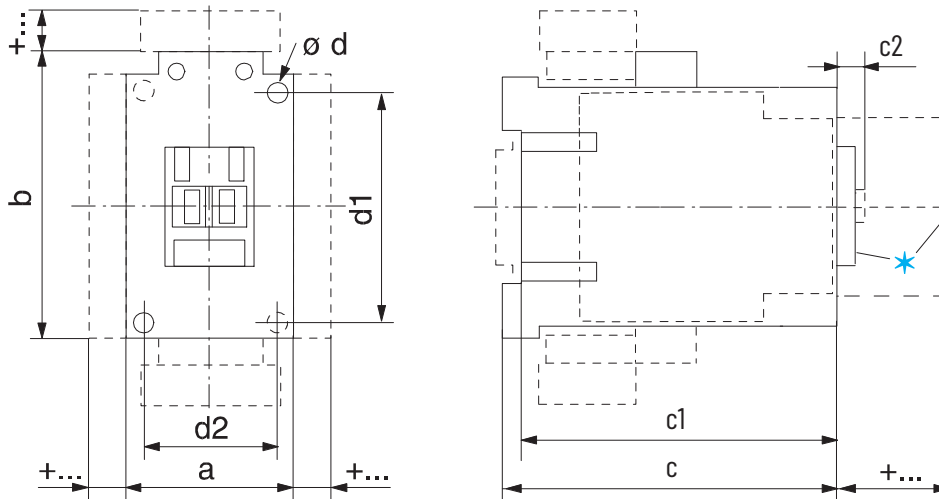


Figure 24 - Mounting Position – 100-C Contactors; 100S-C AC Contactors and DC Contactors with Electronic Coils

Figure 25 - Mounting Position – 100S-C DC Contactors with Conventional Coils

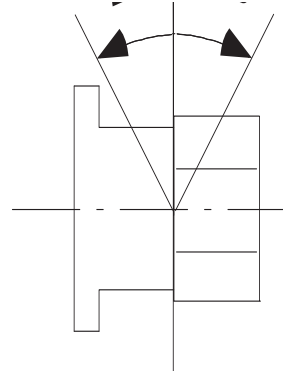
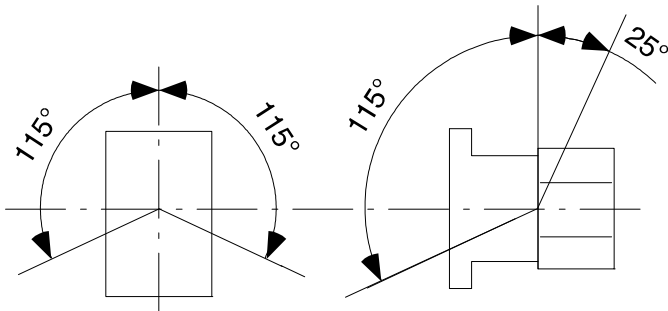


Table 24 - AC Contactors and DC Contactors with 12V or 24V Electronic Coils

| Cat. No.            | a            | b             | c               | c1              | c2          | Ød                 | d1            | d2           |
|---------------------|--------------|---------------|-----------------|-----------------|-------------|--------------------|---------------|--------------|
| 100-C09...100-C23   | 45 (1-25/32) | 81 (3-3/16)   | 80.5 (3-11/64)  | 75.5 (2-31/32)  | 6 (15/64)   | 2 - 4.5 (2 - 3/16) | 60 (2-23/64)  | 35 (1-3/8)   |
| 100-C30, 100-C37    | 45 (1-25/32) | 81 (3-3/16)   | 97.5 (4)        | 92.5 (3-41/64)  | 6.5 (1/4)   | 2 - 4.5 (2 - 3/16) | 60 (2-23/64)  | 35 (1-3/8)   |
| 100-C40             | 59 (2-21/64) | 81 (3-3/16)   | 100.5 (3-61/64) | 95.5 (3-49/64)  | 6.5 (1/4)   | 2 - 4.5 (2 - 3/16) | 60 (2-23/64)  | 45 (1-25/32) |
| 100-C43, 100-C55    | 54 (2-1/8)   | 81 (3-3/16)   | 100.5 (3-61/64) | 95.5 (3-49/64)  | 6.5 (1/4)   | 2 - 4.5 (2 - 3/16) | 60 (2-23/64)  | 45 (1-25/32) |
| 100-C60...100-C97   | 72 (2-53/64) | 122 (4-51/64) | 117 (4-39/64)   | 111.5 (4-25/64) | 8.5 (21/64) | 4 - 5.4 (4 - 7/32) | 100 (3-15/16) | 55 (2-11/64) |
| 100-C90             | 95 (3-47/64) | 122 (4-51/64) | 117 (4-39/64)   | 111.5 (4-25/64) | 8.5 (21/64) | 4 - 5.4 (4 - 7/32) | 100 (3-15/16) | 55 (2-11/64) |
| 100S-C09...100S-C23 | 45 (1-25/32) | 81 (3-3/16)   | 119.5 (4-3/4)   | 114.5 (4-43/64) | 6 (15/64)   | 2 - 4.5 (2 - 3/16) | 60 (2-23/64)  | 35 (1-3/8)   |
| 100S-C30, 100S-C37  | 45 (1-25/32) | 81 (3-3/16)   | 136.5 (5-37/64) | 131.6 (5-11/32) | 6.5 (1/4)   | 2 - 4.5 (2 - 3/16) | 60 (2-23/64)  | 35 (1-3/8)   |
| 100S-C43, 100S-C55  | 54 (2-1/8)   | 81 (3-3/16)   | 139.5 (5-11/16) | 134.6 (5-29/64) | 6.5 (1/4)   | 2 - 4.5 (2 - 3/16) | 60 (2-23/64)  | 45 (1-25/32) |
| 100S-C60...100S-C97 | 72 (2-53/64) | 122 (4-51/64) | 156 (6-11/32)   | 150.5 (6-1/8)   | 8.5 (21/64) | 4 - 5.4 (4 - 7/32) | 100 (3-15/16) | 55 (2-11/64) |

Table 25 - DC Contactors with Conventional Coils

| Cat. No.              | a            | b             | c             | c1              | c2          | Ød                 | d1            | d2           |
|-----------------------|--------------|---------------|---------------|-----------------|-------------|--------------------|---------------|--------------|
| 100-C60D...100-C97D   | 72 (2-53/64) | 122 (4-51/64) | 117 (4-39/64) | 111.5 (4-25/64) | 8.5 (21/64) | 4 - 5.4 (4 - 7/32) | 100 (3-15/16) | 55 (2-11/64) |
| 100-C90D              | 95 (3-47/64) | 81 (3-3/16)   | 117 (4-39/64) | 111.5 (4-25/64) | 8.5 (21/64) | 4 - 5.4 (4 - 7/32) | 100 (3-15/16) | 55 (2-11/64) |
| 100S-C60D...100S-C97D | 72 (2-53/64) | 122 (4-51/64) | 156 (6-11/32) | 150.5 (6-1/8)   | 8.5 (21/64) | 4 - 5.4 (4 - 7/32) | 100 (3-15/16) | 55 (2-11/64) |

**Table 26 - DC Contactors with 36...48V, 48...72V, 110...125V, or 200...250V DC Electronic Coils**

| Cat. No.              | a            | b           | c               | c1              | c2        | Ød                | d1           | d2           |
|-----------------------|--------------|-------------|-----------------|-----------------|-----------|-------------------|--------------|--------------|
| 100-C09E...100-C23E   | 45 (1-25/32) | 105 (4-1/8) | 80.5 (3-11/64)  | 75.5 (2-31/32)  | 6 (15/64) | 2 - 4.5 (2 -3/16) | 60 (2-23/64) | 35 (1-3/8)   |
| 100-C30E...100-C37E   | 45 (1-25/32) | 105 (4-1/8) | 97.5 (4)        | 92.5 (3-41/64)  | 6.5 (1/4) | 2 - 4.5 (2 -3/16) | 60 (2-23/64) | 35 (1-3/8)   |
| 100-C40E              | 59 (2-21/64) | 105 (4-1/8) | 100.5 (3-61/64) | 95.5 (3-49/64)  | 6.5 (1/4) | 2 - 4.5 (2 -3/16) | 60 (2-23/64) | 45 (1-25/32) |
| 100-C43E...100-C55E   | 54 (2-1/8)   | 105 (4-1/8) | 100.5 (3-61/64) | 95.5 (3-49/64)  | 6.5 (1/4) | 2 - 4.5 (2 -3/16) | 60 (2-23/64) | 45 (1-25/32) |
| 100S-C09E...100S-C23E | 45 (1-25/32) | 105 (4-1/8) | 119.5 (4-3/4)   | 114.5 (4-43/64) | 6 (15/64) | 2 - 4.5 (2 -3/16) | 60 (2-23/64) | 35 (1-3/8)   |
| 100S-C30E...100S-C37E | 45 (1-25/32) | 105 (4-1/8) | 136.5 (5-37/64) | 131.6 (5-11/32) | 6.5 (1/4) | 2 - 4.5 (2 -3/16) | 60 (2-23/64) | 35 (1-3/8)   |
| 100S-C43E...100S-C55E | 54 (2-1/8)   | 105 (4-1/8) | 139.5 (5-11/16) | 134.6 (5-29/64) | 6.5 (1/4) | 2 - 4.5 (2 -3/16) | 60 (2-23/64) | 45 (1-25/32) |

**Table 27 - 100-C/104-C Accessories**

| Contactors with                            |   | mm        | (inches)         |
|--|---|-----------|------------------|
| Auxiliary contact block for front mounting | 2- or 4-pole                              | c/c1 + 39 | (c/c1 + 1-37/64) |
| Auxiliary contact block for side mounting  | 1- or 2-pole                              | a + 9     | (a + 23/64)      |
| Pneumatic Timing Module                    |   | c/c1 + 58 | (c/c1 + 2-23/64) |
| Electronic Timing Module                   | on coil terminal side                     | b + 24    | (b + 15/16)      |
| Mechanical Interlock                       | on side of contactor                      | a + 9     | (a + 23/64)      |
| Mechanical Latch                           |   | c/c1 + 63 | (c/c1 + 2-31/64) |
| Interface Module                           | on coil terminal side                     | b + 9     | (b + 23/64)      |
| Surge Suppressor                           | on coil terminal side                     | b + 3     | (b + 1/8)        |
| Labeling with...                           | label sheet                               | + 0       | (+ 0)            |
|  | marking tag sheet with clear cover        | + 0       | (+ 0)            |
|  | marking tag adapter for System Bul. 1492W | + 5.5     | (+ 7/32)         |
| Terminal Lug Kit                           | 100-C09...C23                             | b + 53    | (b + 2-3/32)     |
|  | 100-C30...C37                             | b + 44    | (b + 1-47/64)    |
|  | 100-C43...C55                             | b + 52    | (b + 2-3/64)     |
|  | 100-C60...C97                             | b + 99    | (b + 3-7/8)      |
| Paralleling Links                          | 100-C09...C23                             | b + 78    | (b + 3-1/16)     |
|  |   | c + 9/5   | (c + 3/8)        |
|  | 100-C30...C37                             | b + 85    | (b + 3-11/32)    |
| Auxiliary contact block for side mounting  | 1- or 2-pole                              | a + 9     | (a + 23/64)      |
| Electronic Timing Module                   | on coil terminal side                     | b + 24    | (b + 15/16)      |
| Mechanical Interlock                       | on side of contactor                      | a + 9     | (a + 23/64)      |
| Interface Module                           | on coil terminal side                     | b + 9     | (b + 23/64)      |
| Surge Suppressor                           | on coil terminal side                     | b + 3     | (b + 1/8)        |
| Labeling with                              | label sheet                               | + 0       | (+ 0)            |
|  | marking tag sheet with clear cover        | + 0       | (+ 0)            |
|  | marking tag adapter for System Bul. 1492W | + 5.5     | (+ 7/32)         |

## Product Selection—100-E/104-E Contactors

- 4...560 kW @ 400V
- 5...900 Hp @ 460V
- AC-1 ratings up to 2650 A
- Compact dimensions
- Electronic coils
  - AC/DC
  - Wide voltage range
  - Built-in surge suppression
  - Low power pick-up and hold-in
  - Optional PLC interface for 116...370 A contactors, standard on 400...2650 A contactors
- Direct-on-line or reversing
- 3 Main contacts
- Complete range of accessories
- Environmentally friendly



The Bulletin 100-E/104-E contactor family, along with a wide range of accessories, provides the most compact and flexible contactor system available.





### 3-Pole AC- and DC-operated Direct-on-line Contactors

| Rated Operational Current $I_e$ [A] |             | Ratings for switching AC motors - AC-2, AC-3 |          |      |      |      |      |       |            |      |      |      | Auxiliary Contacts |      | Cat No.                    |
|-------------------------------------|-------------|--|----------|------|------|------|------|-------|------------|------|------|------|--------------------|------|----------------------------|
| 60 °C                               | 40 °C       | kW (50 Hz)                                   |          |      |      |      |      |       | Hp (60 Hz) |      |      |      |                    |      |                            |
| AC-3 (400V)                         | AC-1 (690V) | 220-240V                                     | 380-400V | 415V | 440V | 500V | 690V | 1000V | 200V       | 230V | 460V | 575V | N.O.               | N.C. |                            |
| 9                                   | 25          | 2.2  | 4        | 4    | 4    | 5.5  | 5.5  | —     | 2          | 2    | 5    | 7.5  | 1                  | 0    | 100-E09⊗10                 |
|                                     |             |  |          |      |      |      |      |       |            |      |      |      | 0                  | 1    | 100-E09⊗01                 |
| 12                                  | 28          | 3  | 5.5      | 5.5  | 5.5  | 7.5  | 7.5  | —     | 3          | 3    | 7.5  | 10   | 1                  | 0    | 100-E12⊗10                 |
|                                     |             |  |          |      |      |      |      |       |            |      |      |      | 0                  | 1    | 100-E12⊗01                 |
| 16                                  | 30          | 4  | 7.5      | 9    | 9    | 9    | 9    | —     | 5          | 5    | 10   | 15   | 1                  | 0    | 100-E16⊗10                 |
|                                     |             |  |          |      |      |      |      |       |            |      |      |      | 0                  | 1    | 100-E16⊗01                 |
| 26                                  | 45          | 6.5  | 11       | 11   | 15   | 15   | 15   | —     | 7.5        | 7.5  | 15   | 20   | 0                  | 0    | 100-E26⊗00                 |
| 32                                  | 50          | 9  | 15       | 15   | 18.5 | 18.5 | 18.5 | —     | 10         | 10   | 20   | 25   | 0                  | 0    | 100-E30⊗00                 |
| 38                                  | 50          | 11   | 18.5     | 18.5 | 22   | 22   | 22   | —     | 10         | 10   | 25   | 30   | 0                  | 0    | 100-E38⊗00                 |
| 40                                  | 70          | 11   | 18.5     | 22   | 22   | 22   | 22   | —     | 10         | 15   | 30   | 40   | 0                  | 0    | 100-E40⊗00                 |
| 52                                  | 100         | 15   | 22       | 30   | 30   | 30   | 30   | —     | 15         | 20   | 40   | 50   | 0                  | 0    | 100-E52⊗00                 |
| 65                                  | 105         | 18.5   | 30       | 37   | 37   | 37   | 37   | —     | 20         | 25   | 50   | 60   | 0                  | 0    | 100-E65⊗00                 |
| 80                                  | 125         | 22   | 37       | 45   | 45   | 45   | 45   | 35    | 25         | 30   | 60   | 75   | 0                  | 0    | 100-E80⊗00                 |
| 96                                  | 130         | 25   | 45       | 55   | 55   | 55   | 55   | 40    | 30         | 30   | 60   | 75   | 0                  | 0    | 100-E96⊗00                 |
| 116                                 | 160         | 37   | 55       | 55   | 75   | 75   | 63   | 55    | 30         | 40   | 75   | 100  | 1                  | 1    | 100-E116⊗11 <sup>(1)</sup> |
| 146                                 | 225         | 45   | 75       | 75   | 90   | 90   | 90   | 75    | 40         | 50   | 100  | 125  | 1                  | 1    | 100-E146⊗11 <sup>(1)</sup> |
| 190                                 | 275         | 55   | 90       | 90   | 110  | 110  | 132  | 110   | 50         | 60   | 125  | 150  | 1                  | 1    | 100-E190⊗11                |
| 205                                 | 350         | 55   | 110      | 110  | 132  | 132  | 160  | 132   | 60         | 75   | 150  | 200  | 1                  | 1    | 100-E205⊗11                |
| 265                                 | 400         | 75   | 132      | 132  | 160  | 160  | 200  | 160   | 75         | 100  | 200  | 250  | 1                  | 1    | 100-E265⊗11                |
| 305                                 | 500         | 90   | 160      | 160  | 160  | 200  | 250  | 185   | 100        | 125  | 250  | 300  | 1                  | 1    | 100-E305⊗11                |
| 370                                 | 600         | 110  | 200      | 200  | 200  | 250  | 315  | 200   | 125        | 150  | 300  | 350  | 1                  | 1    | 100-E370⊗11                |
| 400                                 | 600         | 110  | 200      | 220  | 220  | 250  | 315  | 220   | 125        | 150  | 350  | 400  | 1                  | 1    | 100-E400⊗11                |
| 460                                 | 700         | 132  | 250      | 250  | 250  | 315  | 355  | 280   | 150        | 200  | 400  | 500  | 1                  | 1    | 100-E460⊗11                |
| 580                                 | 800         | 160  | 315      | 355  | 355  | 400  | 500  | 355   | 200        | 250  | 500  | 600  | 1                  | 1    | 100-E580⊗11                |
| 750                                 | 1050        | 220  | 400      | 425  | 450  | 530  | 600  | 400   | 250        | 300  | 600  | 700  | 1                  | 1    | 100-E750⊗11                |
| 860                                 | 1350        | 250  | 475      | 500  | 560  | 630  | 800  | 555   | —          | 400  | 800  | 1000 | 1                  | 1    | 100-E860⊗11                |
| 1060                                | 1650        | 315  | 560      | 630  | 710  | 710  | 1000 | 600   | —          | 450  | 900  | 1150 | 1                  | 1    | 100-E1060⊗11               |
| —                                   | 1260        | —  | —        | —    | —    | —    | —    | —     | —          | —    | —    | —    | 1                  | 1    | 100-E1260⊗11               |
| —                                   | 2050        | —  | —        | —    | —    | —    | —    | —     | —          | —    | —    | —    | 1                  | 1    | 100-E2050⊗11               |
| —                                   | 2650        | —  | —        | —    | —    | —    | —    | —     | —          | —    | —    | —    | 1                  | 1    | 100-E2650⊗11               |

(1) To order with built-in terminal lugs, add the letter "L" to the end of the catalog number (example: 100-E116⊗11L).



⊗ Coil voltage code and terminal position—see [page 60](#)

## 4-Pole AC- and DC-operated Direct-on-line Contactors

| Rated Current at 40 °C [A] |                           | Main Poles  |   | Auxiliary Contacts  |   | Cat No.     |
|----------------------------|---------------------------|---|---|---|---|-------------|
| $I_e$                      | UL General Use (enclosed) |  |  |  |  |             |
| AC-1 (690V)                | 600V                      | N.O.  | N.C.  | N.O.  | N.C.  |             |
| 25                         | 25                        | 4   | 0   | 0   | 0   | 100-E09⊗400 |
|                            |                           | 2   | 2   | 0   | 0   | 100-E09⊗200 |
| 30                         | 30                        | 4   | 0   | 0   | 0   | 100-E16⊗400 |
|                            |                           | 2   | 2   | 0   | 0   | 100-E16⊗200 |
| 45                         | 45                        | 4   | 0   | 0   | 0   | 100-E26⊗400 |
|                            |                           | 2   | 2   | 0   | 0   | 100-E26⊗200 |
| 55                         | 55                        | 4   | 0   | 0   | 0   | 100-E38⊗400 |
|                            |                           | 2   | 2   | 0   | 0   | 100-E38⊗200 |
| 70                         | 60                        | 4   | 0   | 0   | 0   | 100-E40⊗400 |
|                            |                           | 2   | 2   | 0   | 0   | 100-E40⊗200 |
| 100                        | 80                        | 4   | 0   | 0   | 0   | 100-E52⊗400 |
| 125                        | 105                       | 4   | 0   | 0   | 0   | 100-E80⊗400 |
|                            |                           | 2   | 2   | 0   | 0   | 100-E80⊗200 |

⊗ Coil voltage code and terminal position—see [page 60](#)

## 3-Pole AC- and DC-operated Reversing Contactors

| Rated Operational Current $I_e$ [A] |             | Ratings for switching AC motors - AC-2, AC-3 |          |      |      |      |      |       |            |      |      |      | Auxiliary Contacts  |   | Cat No.                    |
|-------------------------------------|-------------|--|----------|------|------|------|------|-------|------------|------|------|------|---|---|----------------------------|
| 60 °C                               | 40 °C       | kW (50 Hz)                                   |          |      |      |      |      |       | Hp (60 Hz) |      |      |      |  |  |                            |
| AC-3 (400V)                         | AC-1 (690V) | 220-240V                                     | 380-400V | 415V | 440V | 500V | 690V | 1000V | 200V       | 230V | 460V | 575V | N.O.  | N.C.  |                            |
| 9                                   | 25          | 2.2  | 4        | 4    | 4    | 5.5  | 5.5  | —     | 2          | 2    | 5    | 7.5  | 0   | 1   | 104-E09⊗02                 |
|                                     |             |  |          |      |      |      |      |       |            |      |      |      | 1   | 1 <sup>(1)</sup>  | 104-E09⊗22 <sup>(2)</sup>  |
| 12                                  | 28          | 3  | 5.5      | 5.5  | 5.5  | 7.5  | 7.5  | —     | 3          | 3    | 7.5  | 10   | 0   | 1   | 104-E12⊗02                 |
|                                     |             |  |          |      |      |      |      |       |            |      |      |      | 1   | 1 <sup>(1)</sup>  | 104-E12⊗22 <sup>(2)</sup>  |
| 16                                  | 30          | 4  | 7.5      | 9    | 9    | 9    | 9    | —     | 5          | 5    | 10   | 15   | 0   | 1   | 104-E16⊗02                 |
|                                     |             |  |          |      |      |      |      |       |            |      |      |      | 1   | 1 <sup>(1)</sup>  | 104-E16⊗22 <sup>(2)</sup>  |
| 26                                  | 45          | 6.5  | 11       | 11   | 15   | 15   | 15   | —     | 7.5        | 7.5  | 15   | 20   | 0   | 1 <sup>(1)</sup>  | 104-E26⊗02 <sup>(2)</sup>  |
|                                     |             |  |          |      |      |      |      |       |            |      |      |      | 1   | 1   | 104-E26⊗22                 |
| 32                                  | 50          | 9  | 15       | 15   | 18.5 | 18.5 | 18.5 | —     | 10         | 10   | 20   | 25   | 0   | 1 <sup>(1)</sup>  | 104-E30⊗02 <sup>(2)</sup>  |
|                                     |             |  |          |      |      |      |      |       |            |      |      |      | 1   | 1   | 104-E30⊗22                 |
| 38                                  | 50          | 11   | 18.5     | 18.5 | 18.5 | 22   | 22   | —     | 10         | 10   | 25   | 30   | 0   | 1 <sup>(1)</sup>  | 104-E38⊗02 <sup>(2)</sup>  |
|                                     |             |  |          |      |      |      |      |       |            |      |      |      | 1   | 1   | 104-E38⊗22                 |
| 40                                  | 70          | 11   | 18.5     | 22   | 22   | 22   | 22   | —     | 10         | 15   | 30   | 40   | 1   | 1   | 104-E40⊗22                 |
| 52                                  | 100         | 15   | 22       | 30   | 30   | 30   | 30   | —     | 15         | 20   | 40   | 50   | 1   | 1   | 104-E52⊗22                 |
| 65                                  | 105         | 18.5   | 30       | 37   | 37   | 37   | 37   | —     | 20         | 25   | 50   | 60   | 1   | 1   | 104-E65⊗22                 |
| 80                                  | 125         | 22   | 37       | 45   | 45   | 45   | 45   | 35    | 25         | 30   | 60   | 75   | 1   | 1   | 104-E80⊗22                 |
| 96                                  | 130         | 25   | 45       | 55   | 55   | 55   | 55   | 40    | 30         | 30   | 60   | 75   | 1   | 1   | 104-E96⊗22                 |
| 116                                 | 160         | 55   | 55       | 55   | 75   | 75   | 63   | 55    | 30         | 40   | 75   | 100  | 1   | 1   | 104-E116⊗22 <sup>(3)</sup> |
| 146                                 | 225         | 75   | 75       | 75   | 90   | 90   | 90   | 75    | 40         | 50   | 100  | 125  | 1   | 1   | 104-E146⊗22 <sup>(3)</sup> |
| 190                                 | 275         | 90   | 90       | 90   | 110  | 110  | 132  | 110   | 50         | 60   | 125  | 150  | 1   | 1   | 104-E190⊗22                |
| 205                                 | 350         | 110  | 110      | 110  | 132  | 132  | 160  | 132   | 60         | 75   | 150  | 200  | 1   | 1   | 104-E205⊗22                |
| 265                                 | 400         | 132  | 132      | 132  | 160  | 160  | 200  | 160   | 75         | 100  | 200  | 250  | 1   | 1   | 104-E265⊗22                |
| 305                                 | 500         | 160  | 160      | 160  | 160  | 200  | 250  | 185   | 100        | 125  | 250  | 300  | 1   | 1   | 104-E305⊗22                |
| 370                                 | 600         | 200  | 200      | 200  | 200  | 250  | 315  | 200   | 125        | 150  | 300  | 350  | 1   | 1   | 104-E370⊗22                |
| 400                                 | 600         | 200  | 200      | 220  | 220  | 250  | 315  | 220   | 125        | 150  | 350  | 400  | 1   | 1   | 104-E400⊗22                |
| 460                                 | 700         | 250  | 250      | 250  | 250  | 315  | 355  | 280   | 150        | 200  | 400  | 500  | 1   | 1   | 104-E460⊗22                |
| 580                                 | 800         | 315  | 315      | 355  | 355  | 400  | 500  | 355   | 200        | 250  | 500  | 600  | 1   | 1   | 104-E580⊗22                |
| 750                                 | 1050        | 400  | 400      | 425  | 450  | 530  | 600  | 400   | 250        | 300  | 600  | 700  | 1   | 1   | 104-E750⊗22                |

(1) The N.C. auxiliary contact is supplied as part of the mechanical/electrical interlock.

(2) Not available with EQ or OJ coil codes.

(3) To order with built-in terminal lugs, add the letter "L" to the end of the catalog number (Example: 104-E116⊗22L).

⊗ Coil voltage code and terminal position—see [page 60](#)

## Coil Voltage Codes

### For 3-Pole Contactors

The Cat. No. as listed is incomplete. Select a coil voltage code from the table below to complete the Cat. No. Example: 100-E116KJ11

| Electronic Coils                           | v <sup>(1)</sup>                       | 12-20V DC | 24V DC | 24-60V AC,<br>20-60V DC | 48-130V AC/DC | 100-250V AC/DC | 250-500V AC/DC |
|--|--|-----------|--------|-------------------------|---------------|----------------|----------------|
| 100-E09...100-E370                         | Standard AC/DC                         | —         | —      | KJ                      | KY            | KD             | KN             |
| 100-E09...100-E38                          | Low Consumption AC/DC                  | EQ        | —      | EJ                      | —             | —              | —              |
| 100-E09...100-E38                          | Low Consumption/<br>Faster Drop-out DC | —         | QJ     | —                       | —             | —              | —              |
| 100-E116...100-E370 <sup>(2)</sup>         | Standard AC/DC<br>with PLC Input       | —         | —      | —                       | —             | ED             | EN             |
| 100-E400...100-E750, 100-E1260             |  | —         | —      | EJ <sup>(3)</sup>       | EY            | ED             | EN             |
| 100-E860...100-1060, 100-E2050...100-E2650 |  | —         | —      | —                       | —             | ED             | —              |

(1) AC voltages are at 50/60 Hz.

(2) When ordering coil with PLC input, the PLC input must be used.

(3) 24V...60V DC only.

### For 3-Pole Reversing Contactors

The Cat. No. as listed is incomplete. Select a coil voltage code from the table below to complete the Cat. No. Example: 104-E116KJ11

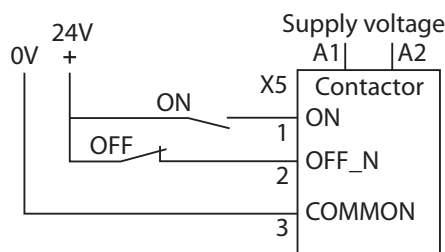
| Electronic Coils                           | v <sup>(1)</sup>                       | 12-20V DC | 24V DC | 24-60V AC,<br>20-60V DC | 48-130V AC/DC | 100-250V AC/DC | 250-500V AC/DC |
|--|--|-----------|--------|-------------------------|---------------|----------------|----------------|
| 104-E09...104-E370                         | Standard AC/DC                         | —         | —      | KJ                      | KY            | KD             | KN             |
| 104-E09...104-E38                          | Low Consumption AC/DC                  | EQ        | —      | EJ                      | —             | —              | —              |
| 104-E09...104-E38                          | Low Consumption/<br>Faster Drop-out DC | —         | QJ     | —                       | —             | —              | —              |
| 104-E116...104-E370 <sup>(2)</sup>         | Standard AC/DC<br>with PLC Input       | —         | —      | —                       | —             | ED             | EN             |
| 100-E400...104-E750, 104-E1260             |  | —         | —      | EJ <sup>(3)</sup>       | EY            | ED             | EN             |
| 104-E860...104-1060, 104-E2050...104-E2650 |  | —         | —      | —                       | —             | ED             | —              |

(1) AC voltages are at 50/60 Hz.

(2) When ordering coil with PLC input, the PLC input must be used.

(3) 24V...60V DC only.

### PLC Interface



### For 4-Pole Contactors

The Cat. No. as listed is incomplete. Select a coil voltage code from the table below to complete the Cat. No. Example: 100-E09KD400.

| Electronic Coils  | v <sup>(1)</sup>                   | 12-20V DC | 24V DC | 24-60V AC,<br>20-60V DC | 48-130V AC/DC | 100-250V AC/DC | 250-500V AC/DC |
|-------------------|------------------------------------|-----------|--------|-------------------------|---------------|----------------|----------------|
| 100-E09...100-E80 | Standard AC/DC                     | —         | —      | KJ                      | KY            | KD             | KN             |
| 100-E09...100-E38 | Low Consumption AC/DC              | EQ        | —      | EJ                      | —             | —              | —              |
| 100-E09...100-E38 | Low Consumption/Faster Drop-out DC | —         | QJ     | —                       | —             | —              | —              |

(1) AC voltages are at 50/60 Hz.



# Product Selection—100S-E Safety Contactors

- Electronic Coils with built-in surge suppression
- 3 Main Contacts
- Direct-on-line
- Low-power auxiliary contacts for feedback circuit
- Mirror contact performance






100S-E09 Contactor






100S-E80 Contactor

## 3-Pole AC- and DC-operated Safety Contactors

| Rated Operational Current $I_e$ [A] |             | Ratings for switching AC motors - AC-2, AC-3 |          |      |      |      |      |       |            |      |      |      | Auxiliary contacts per contactor  |   |   | Direct-on-line Contactor |
|-------------------------------------|-------------|--|----------|------|------|------|------|-------|------------|------|------|------|---|---|---|--------------------------|
| 60 °C                               | 40 °C       | kW (50 Hz)                                   |          |      |      |      |      |       | Hp (60 Hz) |      |      |      |  |  |  |                          |
| AC-3 (400V)                         | AC-1 (690V) | 220-240V                                     | 380-400V | 415V | 440V | 500V | 690V | 1000V | 200V       | 230V | 460V | 575V | N.O.  | N.C.  | N.C. <sup>(1)</sup>   | Cat No.                  |
| 9                                   | 25          | 2.2  | 4        | 4    | 4    | 5.5  | 5.5  | —     | 2          | 2    | 5    | 7.5  | 2   | 0   | 3   |                          |
|                                     |             |  |          |      |      |      |      |       |            |      |      |      | 1   | 0   | 4   | 100S-E09⊗14C             |
|                                     |             |  |          |      |      |      |      |       |            |      |      |      | 3   | 0   | 2   | 100S-E09⊗32C             |
| 12                                  | 28          | 3  | 5.5      | 5.5  | 5.5  | 7.5  | 7.5  | —     | 3          | 3    | 7.5  | 10   | 2   | 0   | 3   | 100S-E12⊗23C             |
|                                     |             |  |          |      |      |      |      |       |            |      |      |      | 1   | 0   | 4   | 100S-E12⊗14C             |
|                                     |             |  |          |      |      |      |      |       |            |      |      |      | 3   | 0   | 2   | 100S-E12⊗32C             |
| 16                                  | 30          | 4  | 7.5      | 9    | 9    | 9    | 9    | —     | 5          | 5    | 10   | 15   | 2   | 0   | 3   | 100S-E16⊗23C             |
|                                     |             |  |          |      |      |      |      |       |            |      |      |      | 1   | 0   | 4   | 100S-E16⊗14C             |
|                                     |             |  |          |      |      |      |      |       |            |      |      |      | 3   | 0   | 2   | 100S-E16⊗32C             |
| 26                                  | 45          | 6.5  | 11       | 11   | 15   | 15   | 15   | —     | 7.5        | 7.5  | 15   | 20   | 0   | 0   | 4   | 100S-E26⊗04C             |
|                                     |             |  |          |      |      |      |      |       |            |      |      |      | 1   | 0   | 3   | 100S-E26⊗13C             |
|                                     |             |  |          |      |      |      |      |       |            |      |      |      | 2   | 0   | 2   | 100S-E26⊗22C             |
|                                     |             |  |          |      |      |      |      |       |            |      |      |      | 3   | 0   | 1   | 100S-E26⊗31C             |
| 32                                  | 50          | 9  | 15       | 15   | 18.5 | 18.5 | 18.5 | —     | 10         | 10   | 20   | 25   | 0   | 0   | 4   | 100S-E30⊗04C             |
|                                     |             |  |          |      |      |      |      |       |            |      |      |      | 1   | 0   | 3   | 100S-E30⊗13C             |
|                                     |             |  |          |      |      |      |      |       |            |      |      |      | 2   | 0   | 2   | 100S-E30⊗22C             |
|                                     |             |  |          |      |      |      |      |       |            |      |      |      | 3   | 0   | 1   | 100S-E30⊗31C             |
| 38                                  | 50          | 11   | 18.5     | 18.5 | 22   | 22   | 22   | —     | 10         | 10   | 25   | 30   | 0   | 0   | 4   | 100S-E38⊗04C             |
|                                     |             |  |          |      |      |      |      |       |            |      |      |      | 1   | 0   | 3   | 100S-E38⊗13C             |
|                                     |             |  |          |      |      |      |      |       |            |      |      |      | 2   | 0   | 2   | 100S-E38⊗22C             |
|                                     |             |  |          |      |      |      |      |       |            |      |      |      | 3   | 0   | 1   | 100S-E38⊗31C             |
| 40                                  | 70          | 11   | 18.5     | 22   | 22   | 22   | 22   | —     | 10         | 15   | 30   | 40   | 0   | 0   | 4   | 100S-E40⊗04C             |
|                                     |             |  |          |      |      |      |      |       |            |      |      |      | 1   | 0   | 3   | 100S-E40⊗13C             |
|                                     |             |  |          |      |      |      |      |       |            |      |      |      | 2   | 0   | 2   | 100S-E40⊗22C             |
|                                     |             |  |          |      |      |      |      |       |            |      |      |      | 3   | 0   | 1   | 100S-E40⊗31C             |
| 52                                  | 100         | 15   | 22       | 30   | 30   | 30   | 30   | —     | 15         | 20   | 40   | 50   | 0   | 0   | 4   | 100S-E52⊗04C             |
|                                     |             |  |          |      |      |      |      |       |            |      |      |      | 1   | 0   | 3   | 100S-E52⊗13C             |
|                                     |             |  |          |      |      |      |      |       |            |      |      |      | 2   | 0   | 2   | 100S-E52⊗22C             |
|                                     |             |  |          |      |      |      |      |       |            |      |      |      | 3   | 0   | 1   | 100S-E52⊗31C             |

(1) The N.C. contact meets IEC 60947-4-1 Annex F requirements for mirror contact performance.





3-Pole AC- and DC-operated Safety Contactors (Continued)

| Rated Operational Current $I_e$ [A] |             | Ratings for switching AC motors - AC-2, AC-3 |          |      |      |      |      |       |            |      |      |      | Auxiliary contacts per contactor  |   |   | Direct-on-line Contactor     |
|-------------------------------------|-------------|--|----------|------|------|------|------|-------|------------|------|------|------|---|---|---|------------------------------|
| 60 °C                               | 40 °C       | kW (50 Hz)                                   |          |      |      |      |      |       | Hp (60 Hz) |      |      |      |  |  |  |                              |
| AC-3 (400V)                         | AC-1 (690V) | 220-240V                                     | 380-400V | 415V | 440V | 500V | 690V | 1000V | 200V       | 230V | 460V | 575V | N.O.  | N.C.  | N.C. <sup>(1)</sup>   | Cat No.                      |
| 65                                  | 105         | 18.5   | 30       | 37   | 37   | 37   | 37   | —     | 20         | 25   | 50   | 60   | 0   | 0   | 4   | 100S-E65⊗04C                 |
|                                     |             |  |          |      |      |      |      |       |            |      |      |      | 1   | 0   | 3   | 100S-E65⊗13C                 |
|                                     |             |  |          |      |      |      |      |       |            |      |      |      | 2   | 0   | 2   | 100S-E65⊗22C                 |
|                                     |             |  |          |      |      |      |      |       |            |      |      |      | 3   | 0   | 1   | 100S-E65⊗31C                 |
| 80                                  | 125         | 22   | 37       | 45   | 45   | 45   | 45   | 35    | 25         | 30   | 60   | 75   | 0   | 0   | 4   | 100S-E80⊗04C                 |
|                                     |             |  |          |      |      |      |      |       |            |      |      |      | 1   | 0   | 3   | 100S-E80⊗13C                 |
|                                     |             |  |          |      |      |      |      |       |            |      |      |      | 2   | 0   | 2   | 100S-E80⊗22C                 |
|                                     |             |  |          |      |      |      |      |       |            |      |      |      | 3   | 0   | 1   | 100S-E80⊗31C                 |
| 96                                  | 130         | 25   | 45       | 55   | 55   | 55   | 55   | 40    | 30         | 30   | 60   | 75   | 0   | 0   | 4   | 100S-E96⊗04C                 |
|                                     |             |  |          |      |      |      |      |       |            |      |      |      | 1   | 0   | 3   | 100S-E96⊗13C                 |
|                                     |             |  |          |      |      |      |      |       |            |      |      |      | 2   | 0   | 2   | 100S-E96⊗22C                 |
|                                     |             |  |          |      |      |      |      |       |            |      |      |      | 3   | 0   | 1   | 100S-E96⊗31C                 |
| 116                                 | 160         | 37   | 55       | 55   | 75   | 75   | 55   | 55    | 30         | 40   | 75   | 100  | 1   | 1   | 1   | 100S-E116⊗12C <sup>(2)</sup> |
| 146                                 | 225         | 45   | 75       | 75   | 90   | 90   | 90   | 75    | 40         | 50   | 100  | 125  | 1   | 1   | 1   | 100S-E146⊗12C <sup>(2)</sup> |
| 190                                 | 275         | 55   | 90       | 90   | 110  | 90   | 132  | 110   | 50         | 60   | 125  | 150  | 1   | 1   | 1   | 100S-E190⊗12C                |
| 205                                 | 350         | 55   | 110      | 110  | 132  | 110  | 160  | 132   | 60         | 75   | 150  | 200  | 1   | 1   | 1   | 100S-E205⊗12C                |
| 265                                 | 400         | 75   | 132      | 132  | 160  | 160  | 200  | 132   | 75         | 100  | 200  | 250  | 1   | 1   | 1   | 100S-E265⊗12C                |
| 305                                 | 500         | 90   | 160      | 160  | 160  | 200  | 250  | 132   | 100        | 125  | 250  | 300  | 1   | 1   | 1   | 100S-E305⊗12C                |
| 370                                 | 600         | 110  | 200      | 200  | 200  | 220  | 315  | 132   | 125        | 150  | 300  | 350  | 1   | 1   | 1   | 100S-E370⊗12C                |
| 400                                 | 600         | 110  | 200      | 220  | 220  | 250  | 315  | 220   | 125        | 150  | 350  | 400  | 1   | 1   | 1   | 100S-E400⊗12C                |
| 460                                 | 700         | 132  | 250      | 250  | 250  | 315  | 355  | 280   | 150        | 200  | 400  | 500  | 1   | 1   | 1   | 100S-E460⊗12C                |
| 580                                 | 800         | 160  | 315      | 355  | 355  | 400  | 500  | 355   | 200        | 250  | 500  | 600  | 1   | 1   | 1   | 100S-E580⊗12C                |
| 750                                 | 1050        | 220  | 400      | 425  | 450  | 530  | 600  | 400   | 250        | 300  | 600  | 700  | 1   | 1   | 1   | 100S-E750⊗12C                |

(1) The N.C. contact meets IEC 60947-4-1 Annex F requirements for mirror contact performance.



(2) To order with built-in terminal lugs, add the letter "L" to the end of the catalog number (example: 100S-E116⊗12CL).

## 4-Pole AC- and DC-operated Safety Contactors

| Rated Operational Current $I_e$ [A] |                           | Main Poles per contactor  |   | Auxiliary contacts per contactor  |   | Direct-on-line Contactor |
|-------------------------------------|---------------------------|---|---|---|---|--------------------------|
| 40 °C                               |                           |   |   |   |   |                          |
| AC-1                                | UL General Use (Enclosed) |  |  |  |  |                          |
| 690V                                | 600V                      | N.O.  | N.C.  | N.O.  | N.C. <sup>(1)</sup>   | Cat No.                  |
| 25                                  | 25                        | 4   | 0   | 0   | 4   | 100S-E09⊗404C            |
|                                     |                           |   |   | 1   | 3   | 100S-E09⊗413C            |
|                                     |                           |   |   | 2   | 2   | 100S-E09⊗422C            |
|                                     |                           |   |   | 3   | 1   | 100S-E09⊗431C            |
| 30                                  | 30                        | 4   | 0   | 0   | 4   | 100S-E16⊗404C            |
|                                     |                           |   |   | 1   | 3   | 100S-E16⊗413C            |
|                                     |                           |   |   | 2   | 2   | 100S-E16⊗422C            |
|                                     |                           |   |   | 3   | 1   | 100S-E16⊗431C            |
| 45                                  | 45                        | 4   | 0   | 0   | 4   | 100S-E26⊗404C            |
|                                     |                           |   |   | 1   | 3   | 100S-E26⊗413C            |
|                                     |                           |   |   | 2   | 2   | 100S-E26⊗422C            |
| 70                                  | 60                        | 4   | 0   | 2   | 2   | 100S-E40⊗422C            |
| 100                                 | 80                        | 4   | 0   | 2   | 2   | 100S-E52⊗422C            |
| 125                                 | 105                       | 4   | 0   | 2   | 2   | 100S-E80⊗422C            |

(1) The N.C. contact meets IEC 60947-4-1 Annex F requirements for mirror contact performance.

## 3-Pole AC- and DC-operated Reversing Safety Contactors

| Rated Operational Current $I_e$ [A] |             | Ratings for switching AC motors - AC-2, AC-3 |          |      |      |      |      |       |            |      |      |      | Auxiliary contacts per contactor  |   | Direct-on-line Contactor |
|-------------------------------------|-------------|--|----------|------|------|------|------|-------|------------|------|------|------|---|---|--------------------------|
| 60 °C                               | 40 °C       | kW (50 Hz)                                   |          |      |      |      |      |       | Hp (60 Hz) |      |      |      |  |  |                          |
| AC-3 (400V)                         | AC-1 (690V) | 220-240V                                     | 380-400V | 415V | 440V | 500V | 690V | 1000V | 200V       | 230V | 460V | 575V | N.O.  | N.C. <sup>(1)</sup>   |                          |
| 9                                   | 25          | 2.2  | 4        | 4    | 4    | 5.5  | 5.5  | —     | 2          | 2    | 5    | 7.5  | 1   | 4   | 104S-E09⊗28C             |
| 12                                  | 28          | 3  | 5.5      | 5.5  | 5.5  | 7.5  | 7.5  | —     | 3          | 3    | 7.5  | 10   | 1   | 4   | 104S-E12⊗28C             |
| 16                                  | 30          | 4  | 7.5      | 9    | 9    | 9    | 9    | —     | 5          | 5    | 10   | 15   | 1   | 4   | 104S-E16⊗28C             |
| 26                                  | 45          | 6.5  | 11       | 11   | 15   | 15   | 15   | —     | 7.5        | 7.5  | 15   | 20   | 3   | 3   | 104S-E26⊗66C             |
| 32                                  | 50          | 9  | 15       | 15   | 18.5 | 18.5 | 18.5 | —     | 10         | 10   | 20   | 25   | 3   | 3   | 104S-E30⊗66C             |
| 38                                  | 50          | 11   | 18.5     | 18.5 | 18.5 | 22   | 22   | —     | 10         | 10   | 25   | 30   | 3   | 3   | 104S-E38⊗66C             |
| 40                                  | 70          | 11   | 18.5     | 22   | 22   | 22   | 22   | —     | 10         | 15   | 30   | 40   | 3   | 3   | 104S-E40⊗66C             |
|                                     |             |  |          |      |      |      |      |       |            |      |      |      | 1   | 5   | 104S-E40⊗210C            |
| 52                                  | 100         | 15   | 22       | 30   | 30   | 30   | 30   | —     | 15         | 20   | 40   | 50   | 3   | 3   | 104S-E52⊗66C             |
|                                     |             |  |          |      |      |      |      |       |            |      |      |      | 1   | 5   | 104S-E52⊗210C            |
| 65                                  | 105         | 18.5   | 30       | 37   | 37   | 37   | 37   | —     | 20         | 25   | 50   | 60   | 3   | 3   | 104S-E65⊗66C             |
|                                     |             |  |          |      |      |      |      |       |            |      |      |      | 1   | 5   | 104S-E65⊗210C            |
| 80                                  | 125         | 22   | 37       | 45   | 45   | 45   | 45   | 35    | 25         | 30   | 60   | 75   | 3   | 3   | 104S-E80⊗66C             |
|                                     |             |  |          |      |      |      |      |       |            |      |      |      | 1   | 5   | 104S-E80⊗210C            |
| 96                                  | 130         | 25   | 45       | 55   | 55   | 55   | 55   | 40    | 30         | 30   | 60   | 75   | 3   | 3   | 104S-E96⊗66C             |
|                                     |             |  |          |      |      |      |      |       |            |      |      |      | 1   | 5   | 104S-E96⊗210C            |

(1) The N.C. contact meets IEC 60947-4-1 Annex F requirements for mirror contact performance.

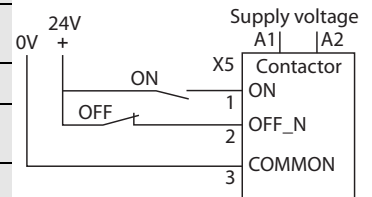
## Coil Voltage Codes

### For 3-Pole Safety Contactors

The Cat. No. as listed is incomplete. Select a coil voltage code from the table below to complete the Cat. No. Example: 100S-E09EJ14C

| Electronic Coils                                   | v <sup>(1)</sup>                            | 12-20V DC | 24V DC | 24-60V AC, 20-60V DC | 48-130V AC/DC | 100-250V AC/DC | 250-500V AC/DC |
|--|---|-----------|--------|----------------------|---------------|----------------|----------------|
| 100S-E09...100S-E370                               | Standard AC/DC                              | —         | —      | KJ                   | KY            | KD             | KN             |
| 100S-E09...100S-E38                                | Low Consumption AC/DC                       | EQ        | —      | EJ                   | —             | —              | —              |
| 100S-E09...100S-E38                                | Low Consumption/<br>Faster Drop-out DC      | —         | QJ     | —                    | —             | —              | —              |
| 100S-E116...100S-E370 <sup>(2)</sup>               | Standard AC/DC with<br>24V DC PLC Interface | —         | —      | —                    | —             | ED             | EN             |
| 100S-E400...100S-E750,<br>100S-E1260               |   | —         | —      | EJ <sup>(3)</sup>    | EY            | ED             | EN             |
| 100S-E860...100S-E1060,<br>100S-E2050...100S-E2650 |   | —         | —      | —                    | —             | ED             | —              |

#### PLC Interface



(1) AC voltages are at 50/60 Hz.

(2) When ordering coil with PLC input, the PLC input must be used.

(3) 24V...60V DC only.

### For 3-Pole Reversing Safety Contactors

The Cat. No. as listed is incomplete. Select a coil voltage code from the table below to complete the Cat. No. Example: 104S-E09KD28C

| Electronic Coils    | v <sup>(1)</sup>      | 12-20V DC | 24V DC | 24-60V AC, 20-60V DC | 48-130V AC/DC | 100-250V AC/DC | 250-500V AC/DC |
|---------------------|-----------------------|-----------|--------|----------------------|---------------|----------------|----------------|
| 104S-E09...104S-E96 | Standard AC/DC        | —         | —      | KJ                   | KY            | KD             | KN             |
| 104S-E09...104S-E38 | Low Consumption AC/DC | EQ        | —      | EJ                   | —             | —              | —              |

(1) AC voltages are at 50/60 Hz.

### For 4-Pole Safety Contactors

The Cat. No. as listed is incomplete. Select a coil voltage code from the table below to complete the Cat. No. Example: 100S-E09KD422C

| Electronic Coils    | v <sup>(1)</sup>                       | 12-20V DC | 24V DC | 24-60V AC, 20-60V DC | 48-130V AC/DC | 100-250V AC/DC | 250-500V AC/DC |
|---------------------|--|-----------|--------|----------------------|---------------|----------------|----------------|
| 100S-E09...100S-E96 | Standard AC/DC                         | —         | —      | KJ                   | KY            | KD             | KN             |
| 100S-E09...100S-E38 | Low Consumption AC/DC                  | EQ        | —      | EJ                   | —             | —              | —              |
| 100S-E09...100S-E38 | Low Consumption/<br>Faster Drop-out DC | —         | QJ     | —                    | —             | —              | —              |

(1) AC voltages are at 50/60 Hz.

## Assignment of Contacts

Table valid for: AC / DC = 0.85...1.1 x U<sub>s</sub>, T<sub>amb</sub> = -40 °C...+70 °C (-40 °F...158 °F), normal position (horizontal rail mounting)

### Device Combinations in Accordance with IEC 60947-1 / -4-1

| Auxiliary Contact Blocks |         | 100-E Contactors (AC/DC Control)        |   |   |  |  |  |
|--------------------------|---------|---|---|---|--|--|--|
| Circuit Diagram          | Control |   |   |   | 100-E26 $\Rightarrow$ 00 <sup>(1)</sup><br>100-E30 $\Rightarrow$ 00 <sup>(1)</sup> | 100-E09 $\Rightarrow$ 400 <sup>(1)</sup> | 100-E09 $\Rightarrow$ 200 <sup>(2)</sup> |
|                          |         |   |   |   | 100-E38 $\Rightarrow$ 00 <sup>(1)</sup>  | 100-E16 $\Rightarrow$ 400 <sup>(1)</sup> | 100-E16 $\Rightarrow$ 200 <sup>(2)</sup> |
|                          |         | 100-E09 $\Rightarrow$ 10 <sup>(1)</sup> | 100-E09 $\Rightarrow$ 01 <sup>(2)</sup> | 100-E40 $\Rightarrow$ 00 <sup>(3)</sup> | 100-E26 $\Rightarrow$ 400 <sup>(2)</sup>   | 100-E26 $\Rightarrow$ 200 <sup>(2)</sup> |  |
|                          |         | 100-E12 $\Rightarrow$ 10 <sup>(1)</sup> | 100-E12 $\Rightarrow$ 01 <sup>(2)</sup> | 100-E52 $\Rightarrow$ 00 <sup>(3)</sup> | 100-E38 $\Rightarrow$ 400 <sup>(2)</sup>   | 100-E38 $\Rightarrow$ 200 <sup>(2)</sup> |  |
|                          |         | 100-E16 $\Rightarrow$ 10 <sup>(1)</sup> | 100-E16 $\Rightarrow$ 01 <sup>(2)</sup> | 100-E65 $\Rightarrow$ 00 <sup>(3)</sup> | 100-E40 $\Rightarrow$ 400 <sup>(3)</sup>   | 100-E40 $\Rightarrow$ 200 <sup>(4)</sup> |  |
|                          |         |   |   | 100-E80 $\Rightarrow$ 00 <sup>(3)</sup> | 100-E52 $\Rightarrow$ 400 <sup>(3)</sup>   | 100-E80 $\Rightarrow$ 200 <sup>(4)</sup> |  |
|                          |         |   |   | 100-E96 $\Rightarrow$ 00 <sup>(3)</sup> | 100-E80 $\Rightarrow$ 400 <sup>(3)</sup>   |  |  |
|                          |         |   |   |   |  |  |  |

### Side Mounting

|           |  |       |                             |                             |              |              |              |
|-----------|--|-------|-----------------------------|-----------------------------|--------------|--------------|--------------|
| 100-ESB11 |  | AC/DC | 10 + 11 = 21 <sup>(5)</sup> | 01 + 11 = 12 <sup>(5)</sup> | 00 + 11 = 11 | 00 + 11 = 11 | 00 + 11 = 11 |
|-----------|--|-------|-----------------------------|-----------------------------|--------------|--------------|--------------|

### Front Mounting

|            |  |       |                |                |                |                |                |
|------------|--|-------|----------------|----------------|----------------|----------------|----------------|
| 100-EFA01  |  | AC/DC | 10 + 01 = 11   | 01 + 01 = 02   | 00 + 01 = 01   | 00 + 01 = 01   | 00 + 01 = 01   |
| 100-EFA10  |  | AC/DC | 10 + 10 = 20   | 01 + 10 = 11   | 00 + 10 = 10   | 00 + 10 = 10   | 00 + 10 = 10   |
| 100-EFAL01 |  | AC/DC | 10 + L01 = L11 | 01 + L01 = L02 | 00 + L01 = L01 | 00 + L01 = L01 | 00 + L01 = L01 |
| 100-EFAL10 |  | AC/DC | 10 + L10 = L20 | 01 + L10 = L11 | 00 + L10 = L10 | 00 + L10 = L10 | 00 + L10 = L10 |
| 100-EFA04  |  | AC/DC | 10 + 04 = 14   | ---            | 00 + 04 = 04   | 00 + 04 = 04   | ---            |
| 100-EFA13  |  | AC/DC | 10 + 13 = 23   | 01 + 13 = 14   | 00 + 13 = 13   | 00 + 13 = 13   | 00 + 13 = 13   |
| 100-EFA22  |  | AC/DC | 10 + 22 = 32   | 01 + 22 = 23   | 00 + 22 = 22   | 00 + 22 = 22   | 00 + 22 = 22   |

Device Combinations in Accordance with IEC 60947-1 / -4-1

| Auxiliary Contact Blocks |  | 100-E Contactors (AC/DC Control) |              |              |                             |                             |                             |
|--------------------------|--|----------------------------------|--------------|--------------|-----------------------------|-----------------------------|-----------------------------|
| 100-EFA31                |  | AC/DC                            | 10 + 31 = 41 | 01 + 31 = 32 | 00 + 31 = 31                | 00 + 31 = 31                | 00 + 31 = 31                |
| 100-EFA40                |  | AC/DC                            | 10 + 40 = 50 | 01 + 40 = 14 | 00 + 40 = 40                | 00 + 40 = 40                | 00 + 40 = 40                |
| 100-EFB04                |  | AC/DC                            | ---          | ---          | 00 + 04 = 04                | 00 + 04 = 04                | ---                         |
| 100-EFB22                |  | AC/DC                            | ---          | ---          | 00 + 22 = 22                | 00 + 22 = 22                | 00 + 22 = 22                |
| 100-EFB31                |  | AC/DC                            | ---          | ---          | 00 + 31 = 31                | 00 + 31 = 31                | 00 + 31 = 31                |
| 100-EFB40                |  | AC/DC                            | ---          | ---          | 00 + 40 = 40                | 00 + 40 = 40                | 00 + 40 = 40                |
| 100-EFC04                |  | AC/DC                            | 10 + 04 = 14 | ---          | ---                         | ---                         | ---                         |
| 100-EFC13                |  | AC/DC                            | 10 + 13 = 23 | ---          | ---                         | ---                         | ---                         |
| 100-EFC22                |  | AC/DC                            | 10 + 22 = 32 | ---          | ---                         | ---                         | ---                         |
| 100-EFC31                |  | AC/DC                            | 10 + 31 = 41 | ---          | ---                         | ---                         | ---                         |
| 100-EFB11T               |  | AC/DC                            | ---          | ---          | 00 + 11 = 11 <sup>(6)</sup> | 00 + 11 = 11 <sup>(6)</sup> | 00 + 11 = 11 <sup>(6)</sup> |
| 100-EFC11T               |  | AC/DC                            | 10 + 11 = 32 | ---          | ---                         | ---                         | ---                         |

- (1) Maximum 6 auxiliary contacts possible with up to 4 N.C., front or side mounted
- (2) Maximum 6 auxiliary contacts possible with up to 3 N.C., front or side mounted
- (3) Maximum 8 auxiliary contacts possible with up to 6 N.C., front or side mounted
- (4) Maximum 8 auxiliary contacts possible with up to 2 N.C., front or side mounted
- (5) Double numbering: because of double numbering, only left-side mounting is recommended
- (6) Not for use on 100-E80...E96 contactors

Device Combinations in Accordance with IEC 60947-1 / -4-1

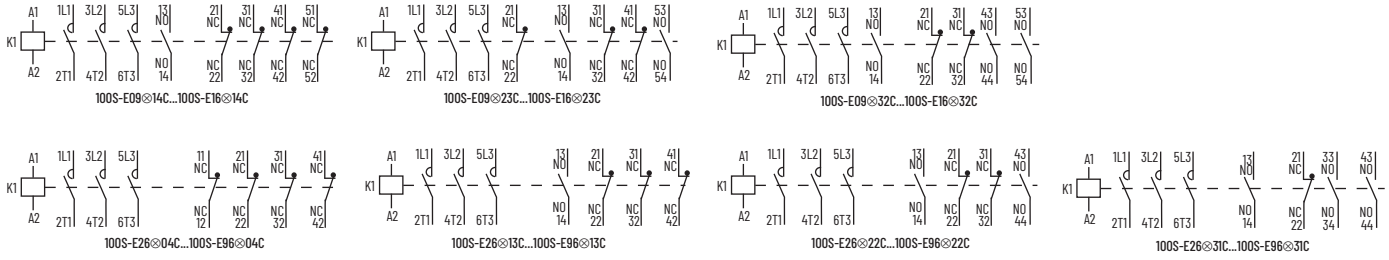
| Auxiliary Contact Blocks |         | 100-E Contactors (AC/DC Control) |               |               |              |
|--------------------------|---------|----------------------------------|---------------|---------------|--------------|
| Circuit Diagram          | Control | 100-E116⊕J11                     | 100-E400⊕J11  | 100-E860⊕J11  |              |
|                          |         | 100-E146⊕11                      |               |               | 100-E460⊕J11 |
|                          |         | 100-E190⊕J11                     | 100-E580⊕J11  | 100-E2050⊕J11 |              |
|                          |         | 100-E205⊕J11                     | 100-E750⊕J11  | 100-E2650⊕J11 |              |
|                          |         | 100-E265⊕J11                     | 100-E1260⊕J11 |               |              |
|                          |         | 100-E305⊕J11                     |               |               |              |
|                          |         | 100-E370⊕J11                     |               |               |              |
|                          |         |                                  |               |               |              |

Side Mounting<sup>(1)</sup>

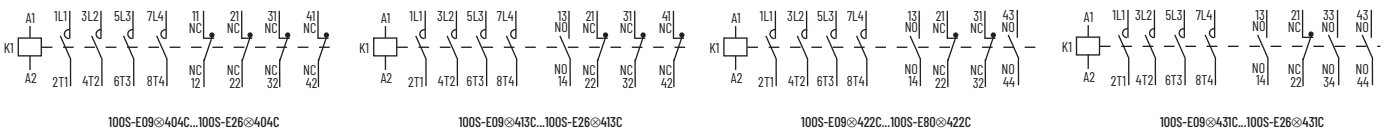
|                            |  |       |              |              |              |
|----------------------------|--|-------|--------------|--------------|--------------|
| 100-ES1-11                 |  | AC/DC | 11 + 11 = 22 | ---          | ---          |
| 100-ES2-11                 |  | AC/DC | 11 + 11 = 22 | ---          | ---          |
| 100-ES3-11                 |  | AC/DC | ---          | 11 + 11 = 22 | 11 + 11 = 22 |
| 100-ES4-11                 |  | AC/DC | ---          | 11 + 11 = 22 | 11 + 11 = 22 |
| 100-ES1-B01 <sup>(2)</sup> |  | AC/DC | 11 + 01 = 12 | ---          | ---          |
| 100-ES1-B10 <sup>(2)</sup> |  | AC/DC | 11 + 10 = 21 | ---          | ---          |
| 100-ES3-B01 <sup>(2)</sup> |  | AC/DC | ---          | 11 + 01 = 12 | 11 + 01 = 12 |
| 100-ES3-B10 <sup>(2)</sup> |  | AC/DC | ---          | 11 + 10 = 21 | 11 + 10 = 21 |

(1) Maximum 8 auxiliary contacts possible with up to 4 N.C.  
 (2) Maximum 6 auxiliary contacts possible when using the 100-ES\*-B01 or 100-ES\*B10.

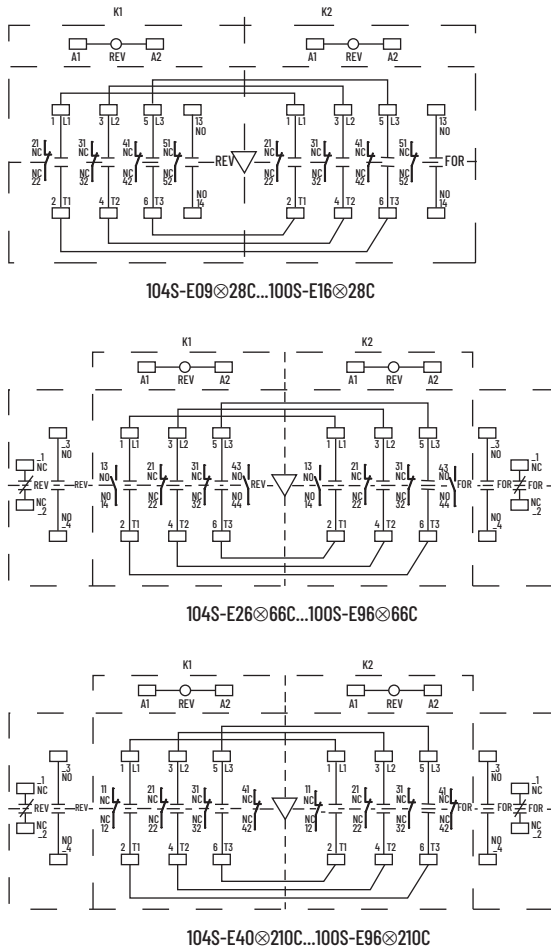
**Safety Contactors with three main contacts front-mount auxiliary contacts**



**Safety Contactors with four main contacts front-mount auxiliary contacts**




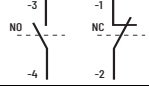
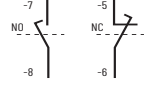

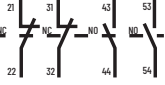
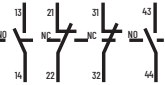

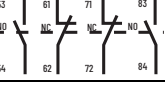
**Safety Reversing Contactors with three main contacts front-mount auxiliary contacts**




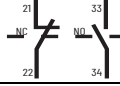
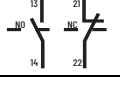

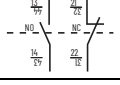
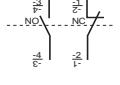

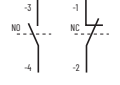

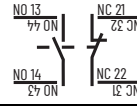
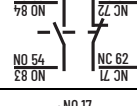



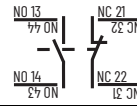
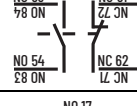




# Accessories

## Auxiliary Contact Blocks with Standard Auxiliary Contacts






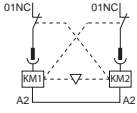
|  | Description   | Connection Diagrams |      | For Use With  | Cat. No.  |           |
|--|---|---------------------|------|---|---|-----------|
|  |   | N.O.                | N.C. |   |   |           |
|  <p>Auxiliary Contact Blocks for Front Mounting</p> <ul style="list-style-type: none"> <li>• 1-pole</li> <li>• Quick and easy mounting without tools</li> <li>• Screw connection terminals</li> <li>• Switching down to 12V, 3mA</li> <li>• Mirror contact performance to the main contactor poles</li> <li>• L= Late break N.C./early make N.O.</li> </ul> |   | 1                   | 0    |  <p>100-E09...100-E96</p>   | 100-EFA10   |           |
|  |   | 0                   | 1    |   | 100-EFA01   |           |
|  |   | 1L                  | 0    |  <p>100-E09...100-E96</p>   | 100-EFAL10  |           |
|  |   | 0                   | 1L   |   | 100-EFAL01  |           |
|  <p>Auxiliary Contact Blocks for Front Mounting</p> <ul style="list-style-type: none"> <li>• 4-pole</li> <li>• Quick and easy mounting without tools</li> <li>• Screw connection terminals</li> <li>• Switching down to 12V 3mA</li> <li>• Mirror contact performance to the main contactor poles</li> </ul>   |   | 2                   | 2    |  <p>100-E09⊗10...100-E16⊗10</p>   | 100-EFC22   |           |
|  |   | 3                   | 1    |   | 100-EFC31   |           |
|  |   | 1                   | 3    |   | 100-EFC13   |           |
|  |   | 0                   | 4    |   | 100-EFC04   |           |
|  |   | 2                   | 2    |  <p>100-E26⊗00...100-E96⊗00<br/>100-E09⊗400...100-E80⊗400<br/>100-E09⊗200...100-E80⊗200</p> | 100-EFB22   |           |
|  |   | 3                   | 1    |   | 100-EFB31   |           |
|  |   | 4                   | 0    |   | 100-EFB40   |           |
|  |   | 0                   | 4    |   | 100-EFB04   |           |
|  |  <p>Auxiliary Contact Blocks for Front Mounting</p> <ul style="list-style-type: none"> <li>• 4-pole</li> <li>• Quick and easy mounting without tools</li> <li>• Screw connection terminals</li> <li>• Switching down to 12V 3mA</li> <li>• Mirror contact performance to the main contactor poles</li> </ul> |                     | 2    | 2   |  <p>100-E09...100-E96</p> | 100-EFA22 |
|  |   |                     | 3    | 1   |   | 100-EFA31 |
|  |   | 4                   | 0    | 100-EFA40   |   |           |
|  |   | 1                   | 3    | 100-EFA13   |   |           |
|  |   | 0                   | 4    | 100-EFA04   |   |           |

Auxiliary Contact Blocks with Standard Auxiliary Contacts (Continued)

|   | Description   | Connection Diagrams |      | For Use With  | Cat. No.  |             |
|---|---|---------------------|------|---|---|-------------|
|   |   | N.O.                | N.C. |   |   |             |
|    | Auxiliary Contact Blocks for Front Mounting with A1/A2 Coil Terminal Blocks <ul style="list-style-type: none"> <li>• 2-pole</li> <li>• Quick and easy mounting without tools</li> <li>• Screw connection terminals</li> <li>• Switching down to 12V, 3mA</li> <li>• Mirror contact performance to the main contactor poles</li> </ul>   | 1                   | 1    |     | 100-E09⊗10...100-E16⊗10   | 100-EFC11T  |
|   |   | 1                   | 1    |     | 100-E26⊗00...100-E65⊗00<br>100-E09⊗400...100-E52⊗400<br>100-E09⊗200...100-E40⊗200 | 100-EFB11T  |
|    | Auxiliary Contact Blocks for Side Mounting <ul style="list-style-type: none"> <li>• 2-pole</li> <li>• Two-way numbering for right or left mounting on the contactor</li> <li>• With or without sequence terminal designations</li> <li>• Quick and easy mounting without tools</li> <li>• Screw connecting terminals</li> <li>• Switching down to 12V, 3mA</li> <li>• Mirror contact performance to the main contactor poles</li> </ul>   | 1                   | 1    |     | 100-E26...100-E96   | 100-ESB11   |
|   |   | 1                   | 1    |     | 100-E09...100-E96   | 100-ESA11   |
|   | Auxiliary Contact Blocks for Front Mounting for Low-power Applications <ul style="list-style-type: none"> <li>• 1-pole</li> <li>• Available in two IP degrees of ingress protection                             <ul style="list-style-type: none"> <li>- B, B2 with built-in microswitch, IP40 degree of protection (IP20 terminals)</li> <li>- B3, B4 with built-in microswitch, IP67 degree of protection (IP20 terminals)</li> </ul> </li> <li>• Available in two voltage and current ratings                             <ul style="list-style-type: none"> <li>- B, B3: 125V, 0.1 A max., 3V, 1 mA min.</li> <li>- B2, B4: 250V, 2 A max., 17V, 1 mA min.</li> </ul> </li> </ul> | 1                   | 0    |     | 100-E09...100-E96   | 100-ESA10B  |
|   |   | 0                   | 1    |   |   | 100-ESA01B  |
|   |   | 1                   | 0    |   |   | 100-ESA10B2 |
|   |   | 0                   | 1    |   |   | 100-ESA01B2 |
|   |   | 1                   | 0    |   |   | 100-ESA10B3 |
|   |   | 0                   | 1    |   |   | 100-ESA01B3 |
|   |   | 1                   | 0    |   |   | 100-ESA10B4 |
|   |   | 0                   | 1    |   |   | 100-ESA01B4 |
|  | Auxiliary Contact Blocks for Side Mounting with Sequence Terminal Designations <ul style="list-style-type: none"> <li>• 2-pole</li> <li>• Two-way numbering for right or left mounting on the contactor</li> <li>• Quick and easy mounting without tools</li> <li>• Mirror contact performance to the main contactor poles</li> <li>• Low power switching down to 24V 50 mA</li> </ul>  | 1                   | 1    |   | 100-E116...E370,<br>left or right inside mounting                                 | 100-ES1-11  |
|   |   | 1                   | 1    |   | 100-E116...E370,<br>left or right outside mounting                                | 100-ES2-11  |
|   | Low-power Auxiliary Contact Blocks for Side Mounting with Sequence Terminal Designations <sup>(1)</sup> <ul style="list-style-type: none"> <li>• 1-pole</li> <li>• Two-way numbering for right or left side contactor mounting</li> <li>• Quick and easy mounting without tools</li> <li>• Mirror contact performance to the main contactor poles</li> <li>• Electronic compatible, 3V 1 mA</li> </ul>  | 1                   | 0    |  | 100-E116...E370,<br>left or right inside or outside mounting                      | 100-ES1-B10 |
|   |   | 0                   | 1    |  | 100-E116...E370,<br>left or right inside or outside mounting                      | 100-ES1-B01 |
|  | Auxiliary Contact Blocks for Side Mounting with Sequence Terminal Designations <ul style="list-style-type: none"> <li>• 2-pole</li> <li>• Two-way numbering for right or left side contactor mounting</li> <li>• Quick and easy mounting without tools</li> <li>• Mirror contact performance to the main contactor poles</li> <li>• Low power switching down to 24V 50 mA</li> </ul>  | 1                   | 1    |   | 100-E400...E2650,<br>left or right inside mounting                                | 100-ES3-11  |
|   |   | 1                   | 1    |   | 100-E400...E2650,<br>left or right outside mounting                               | 100-ES4-11  |
|   | Low-power Auxiliary Contact Blocks for Side Mounting with Sequence Terminal Designations <sup>(1)</sup> <ul style="list-style-type: none"> <li>• 1-pole</li> <li>• Two-way numbering for right or left side contactor mounting</li> <li>• Quick and easy mounting without tools</li> <li>• Mirror contact performance to the main contactor poles</li> <li>• Electronic compatible, 3V 1 mA</li> </ul>  | 1                   | 0    |  | 100-E400...E2650,<br>left or right inside or outside mounting                     | 100-ES3-B10 |
|   |   | 0                   | 1    |  | 100-E400...E2650,<br>left or right inside or outside mounting                     | 100-ES3-B01 |




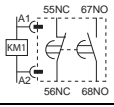
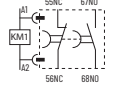
(1) No auxiliary contacts blocks can be mounted on the outside of the 100-ES1-B\* or 100-ES3-B\* devices.

**Mechanical Interlocks**


|   | Description   |   | Connection Diagrams  | For Use With  | Cat. No.                   |
|---|---|---|--|---|----------------------------|
|  | Mechanical Interlock<br>• For interlocking of two contactors<br>• Two fixing clips included   | Mechanical only, without auxiliary contacts |   | 100-E09...100-E38 (3 pole),<br>100-E09⊗400...100-E38⊗400      | 100-EMCA00A <sup>(1)</sup> |
|   |   |   |  | 100-E40...100-E96 (3 pole),<br>100-E40⊗400...100-E80⊗400      | 100-EMCA00B <sup>(1)</sup> |
|  | Mechanical Interlock<br>• For interlocking of two contactors.<br>• Interlocking of different sizes possible   | Mechanical only, without auxiliary contacts |   | 100-E116...100-E146   | 100-EM1-00                 |
|   |   |   |  | 100-E190...100-E205   |                            |
|   |   |   |  | 100-E265...100-E370   |                            |
|   |   |   |  | 100-E116...100-E146<br>to 100-E190...100-E205                 | 100-EM4-00                 |
|   |   |   |  | 100-E190...100-E205<br>to 100-E265...100-E370                 | 100-EM5-00                 |
|   |   |   |  | 100-E400...100-E750, 100-E1260 <sup>(2)</sup>                 | 100-EM2-00                 |
|   |   |   |  | 100-E860...100-E1060,<br>100-E2050...100-E2650 <sup>(3)</sup> | 100-EM3-00                 |
| Rod for vertical mounting<br>100-E400...E750 reversing contactors                 | 100-EVR750  |   |  |   |                            |
|  | Mechanical and Electrical Interlock<br>• For interlocking of two contactors<br>• Two fixing clips, a mechanical interlock and an electrical interlock block with A2-A2 connection included<br>• Front-face connection of the electrical interlock block connects the 2 built-in N.C. interlocking contacts with the two coils<br>• The electrical diagram is used with the A2-A2 connection | Mechanical/electrical interlock             |  | 100-E09...100-E38 (3 pole),<br>100-E09⊗400...100-E38⊗400      | 100-EMCA02 <sup>(4)</sup>  |

- (1) Must be ordered in multiples of 10 pieces.
- (2) Mounting plate ordered separately.
- (3) Mounting plate included.
- (4) Not for use with contactors that have EQ or QJ coils.


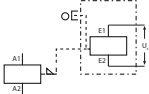
**Electronic Timers**

|   | Description   | <br> |      | Connection Diagrams | For Use With  | Cat. No.                              |         |
|---|---|---|------|---------------------|---|---------------------------------------|---------|
|   |   | N.O.  | N.C. |                     |   |                                       |         |
|  | Electronic Timing Module—ON-Delay<br>• Delay of the contactor coil<br>• The contactor is energized at the end of the delay time   | ON-Delay<br>0.1...1 s<br>1...10 s<br>10...100 s   | 1    | 1                   |  | 100-E09...100-E96,<br>24...240V AC/DC | 100-ETA |
|   | Electronic Timing Module—OFF-Delay<br>• Delay of the contactor coil<br>• After interruption of the control signal, the contactor is de-energized at the end of the delay time | OFF-Delay<br>0.1...1 s<br>1...10 s<br>10...100 s  | 1    | 1                   |  | 100-E09...100-E96,<br>24...240V AC/DC | 100-ETB |


**DC Interface Module**

|   | Description  | For Use With      | Pkg. Qty. | Cat. No. |
|---|--|-------------------|-----------|----------|
|  | DC Interface<br>• Receives 24V DC signals from PLCs or other low output power sources and switches AC control power to operate the coils of the contactor<br>• Coil voltage: 24...250V AC 50/60 Hz<br>• Rated control circuit voltage U <sub>c</sub> : 24VDC | 100-E09...100-E96 | 1         | 100-EJE  |
|   |  |                   | 10        | 100-EJEM |


**Mechanical Latch**

|   | Description   | Rated Voltage [V] |           | Connection Diagram   | For Use With      | Cat. No.    |
|---|---|-------------------|-----------|--|-------------------|-------------|
|   |   | V AC, 50/60 Hz    | V DC      |  |                   |             |
|  | Mechanical Latch <ul style="list-style-type: none"> <li>Ensures contactor or contactor relay is switched on even if there is a voltage failure</li> <li>Opening controlled either electrically by AC or DC impulse or manually by button</li> <li>Front mounting</li> </ul> | 24...60           | 24...60   |  | 100-E09...100-E65 | 100-EFL11KJ |
|   |   | 48...130          | 48...130  |  |                   | 100-EFL11KY |
|   |   | 100...250         | 100...250 |  |                   | 100-EFL11KD |
|   |   | 250...500         | 250...500 |  |                   | 100-EFL11KN |
|   |   | 24...60           | 24...60   |  | 100-E80, 100-E96  | 100-EFL12KJ |
|   |   | 48...130          | 48...130  |  |                   | 100-EFL12KY |
|   |   | 100...250         | 100...250 |  |                   | 100-EFL12KD |
|   |   | 250...500         | 250...500 |  |                   | 100-EFL12KN |


**Additional Coil Terminal Block**

|   | Description   | For Use With      | Pkg. Qty. | Cat. No. |
|---|---|-------------------|-----------|----------|
|  | Additional Coil Terminal Block <ul style="list-style-type: none"> <li>Allows bottom access to the coil terminals in addition to top access</li> </ul> | 100-E09...100-E96 | 10        | 100-ECT  |


**Protective Covers**

|  | Description  | For Use With         | Pkg. Qty. | Cat. No.  |
|--|--|----------------------|-----------|-----------|
|  | Protective Cover <ul style="list-style-type: none"> <li>Provides protection against unintended manual operation</li> <li>Sealable and Transparent</li> </ul> | 100-E09...100-E96    | 10        | 100-ESCCA |
|  |  | 100-EF (4-pole only) | 10        | 100-ESCFA |


**Functional Markers**

|   | Description   | For Use With      | Pkg. Qty. | Cat. No. |
|---|---|-------------------|-----------|----------|
|  | Functional Markers <ul style="list-style-type: none"> <li>256 markers (16 per card) printable on HTP500 thermal transfer printer and AMS 500 marking table</li> <li>7 x 20 mm (0.276 x 0.787 in)</li> </ul> | 100-E09...100-E96 | 16        | 100-EFMS |


**Terminal Block**

|   | Description   | For Use With      | Pkg. Qty. | Cat. No.  |
|---|---|-------------------|-----------|-----------|
|  | Additional Terminal Blocks <ul style="list-style-type: none"> <li>Designed to increase wire size capacity of 3-pole contactors</li> <li>3-pole terminal blocks with IP20 terminals</li> </ul> | 100-E26...100-E38 | 2         | 100-ECT38 |



**Terminal Shrouds**

|   | Description  | No. of Poles | For Use With      | Cat. No.  |
|---|--|--------------|-------------------|-----------|
|  | Terminal Shrouds <ul style="list-style-type: none"> <li>IP20 terminal protection against accidental direct contact after wiring (EN 50274)</li> <li>3-pole and 4-pole</li> </ul> | 3-pole       | 100-E40...100-E65 | 100-ESC65 |
|   |  | 3-pole       | 100-E80, 100-E96  | 100-ESC96 |
|   |  | 4-pole       | 100-E40, 100-E52  | 100-ESC52 |
|   |  | 4-pole       | 100-E80           | 100-ESC80 |


## Paralleling Terminals

|   | Description  | For Use With              | Cat. No.  |
|---|--|---------------------------|-----------|
|  | Paralleling Terminals <ul style="list-style-type: none"> <li>To connect poles in parallel and thus increase the AC-1 load passing through the flow path made up of the parallel-connected poles</li> </ul> | 100-E09, 100-E12, 100-E16 | 100-ECP16 |
|   |  | 100-E26, 100-E30, 100-E38 | 100-ECP38 |

## Terminal Lugs






|   | Description   | Wire Sizes             | For Use With        | Cat. No.    |
|---|---|------------------------|---------------------|-------------|
|  | Terminal Lug Kit <ul style="list-style-type: none"> <li>Standard on 100-E116*L...100-E146*L contactors</li> <li>Set of two</li> </ul>                     | 2 x 6 AWG...3/0 AWG    | 100-E116...100-E146 | 100-ECL146  |
|  | Terminal Lugs <ul style="list-style-type: none"> <li>Set of three</li> <li>10-32 threaded hole for customer-supplied control circuit tap screw</li> </ul> | 6 AWG...300 MCM        | 100-E190...100-E205 | 100-ETL205  |
|   |   | 4 AWG...400 MCM        | 100-E265...100-E370 | 100-ETL370  |
|   |   | (2x) 4 AWG...500 MCM   | 100-E265...100-E370 | 100-ETL370B |
|   |   | (2x) 2/0 AWG...500 MCM | 100-E400...100-E460 | 100-ETL580  |
|   |   | (3x) 2/0 AWG...500 MCM | 100-E580...E750     | 100-ETL750  |
|   |   | (4x) 4/0 AWG...500 MCM | 100-E860            | 100-ETL860  |
|   |   | (4x) 1/0 AWG...750 MCM | 100-E1060           | 100-ETL1060 |
| (6x) 1/0 AWG...750 MCM  | 100-E1060   | 100-ETL1060B           |                     |             |

## Terminal Shrouds and Shields

|  | Description   | Wires with Compression Lugs | Contactor with Terminal Lugs | For Use With                   | Cat. No.                   |            |
|--|---|-----------------------------|------------------------------|--------------------------------|----------------------------|------------|
|                     | Terminal Shrouds <ul style="list-style-type: none"> <li>Not applicable when using 105-PW* or 170-PW* power wiring kits</li> <li>Pkg. Qty:2</li> </ul> | X                           | —                            | 100-E116...100-E146            | 100-ETS146L                |            |
|  |   | —                           | X                            | 100-E190...100-E205            | 100-ETS205L                |            |
|  |   | X                           | —                            | 100-E190...100-E205            | 100-ETS205C                |            |
|  |   | —                           | X                            | 100-E265...100-E370            | 100-ETS370L <sup>(1)</sup> |            |
|  |   | X                           | —                            | 100-E265...100-E370            | 100-ETS370C                |            |
|  |   | —                           | X                            | 100-E400...100-E460            | 100-ETS460L                |            |
|  |   | X                           | —                            | 100-E400...100-E460            | 100-ETS460C                |            |
|  |   | —                           | X                            | 100-E580...100-E750            | 100-ETS750L                |            |
| IP20 terminal shield between contactor and 193-E overload relay on an assembled direct-on-line starter |   | X                           | —                            | 100-E580...100-E750, 100-E1260 | 100-ETS750C                |            |
|  |   |                             |                              |                                |                            |            |
|  | IP20 terminal shield between contactor and 193-E overload relay on an assembled reversing starter   |                             |                              |                                | 100-E116...100-E146        | 100-ETC146 |
|  |   |                             |                              |                                | 100-E190...100-E205        | 100-ETC205 |
|  |   |                             |                              | 100-E116...100-E146            | 100-ETCR146                |            |
|  |   |                             |                              | 100-E190...100-E205            | 100-ETCR205                |            |


(1) Not applicable when using the 100-ETL370B lug kit.

**Power Wiring Kits**


|   | Description  | For Use With                   | Cat. No.                  |                 |
|---|--|--------------------------------|---------------------------|-----------------|
|    | Reversing Power Wiring Kits <ul style="list-style-type: none"> <li>Used to connect the main poles of two 3-pole contactors mounted side by side</li> <li>1 line-side paralleling and 1 load-side reversing connection</li> <li>Insulated, solid copper bars</li> </ul>   | 100-E09...100-E16              | 105-PW16                  |                 |
|   |  | 100-E26...100-E38              | 105-PW38                  |                 |
|   |  | 100-E40...100-E65              | 105-PW65                  |                 |
|   |  | 100-E80, 100-E96               | 105-PW96                  |                 |
|    | Reversing Power Wiring Kits  | 100-E116...100-E146            | 105-PW146                 |                 |
|   |  | 100-E190...100-E205            | 105-PW205 <sup>(1)</sup>  |                 |
|   |  | 100-E265...100-E370            | 105-PW370 <sup>(1)</sup>  |                 |
|   |  | 100-E400...100-E460            | 105-PW460 <sup>(2)</sup>  |                 |
|   |  | 100-E580...100-E750            | 105-PW750 <sup>(2)</sup>  |                 |
|    | Wye-Delta Power Wiring Kits <ul style="list-style-type: none"> <li>Used to connect the main poles of the Line, Delta and Star contactors of a star-delta starter.</li> <li>Connection sets are made up of:                             <ul style="list-style-type: none"> <li>Line contactor / delta contactor, line-side phase-to-phase connection</li> <li>Delta contactor / star contactor, load-side connection in parallel</li> <li>Star contactor: star point line-side</li> <li>Insulated, solid copper bars</li> </ul> </li> </ul> | <b>Delta Contactor (1M/2M)</b> | <b>Wye Contactor (1S)</b> | <b>Cat. No.</b> |
|   |  | 100-E09...100-E16              | 100-E09...100-E16         | 170-PW16        |
|   |  | 100-E26...100-E38              | 100-E26...100-E38         | 170-PW38        |
|   |  | 100-E40...100-E65              | 100-E40...100-E65         | 170-PW65        |
|   |  | 100-E80, 100-E96               | 100-E40, 100-E65          | 170-PW96        |
|   | Wye-Delta Power Wiring Kits  | <b>Delta Contactor (1M/2M)</b> | <b>Wye Contactor (1S)</b> | <b>Cat. No.</b> |
|   |  | 100-E116...100-E146            | 100-E116...100-E146       | 170-PW146       |
|   |  | 100-E190...100-E205            | 100-E116...100-E146       | 170-PW190       |
|   |  | 100-E190...100-E205            | 100-E190...100-E205       | 170-PW205       |
|   |  | 100-E265...100-E370            | 100-E190...100-E205       | 170-PW265       |
|   |  | 100-E265...100-E370            | 100-E265...100-E370       | 170-PW370       |
|   |  | 100-E400...100-E460            | 100-E400...100-E460       | 170-PW460       |
|   |  | 100-E580...100-E750            | 100-E400...100-E460       | 170-PW580       |
| 100-E580...100-E750   | 100-E580...100-E750  | 170-PW750                      |                           |                 |
|  | Shorting Bars  | 100-E116...100-E146            | 170-PWY146                |                 |
|   |  | 100-E190...100-E205            | 170-PWY205                |                 |
|   |  | 100-E265...100-E370            | 170-PWY370                |                 |
|   |  | 100-E400...100-E460            | 170-PWY460                |                 |
|   |  | 100-E580...100-E750            | 170-PWY750                |                 |

(1) Kits includes one set of terminal extensions. If 100-ETL\* terminal lugs are to be used on line and load side of reversing contactor, and second set of 100-ETX terminal extensions is required.  
 (2) If 100-ETL\* terminal lugs are to be used on line and load side of reversing contactor, two sets of 100-ETX terminal extensions are also required.



**Mounting Plates**

|   | Description                 | For Use With        | Cat. No.    |
|---|-----------------------------|---------------------|-------------|
|  | For direct-on-line starters | 100-E116...100-E146 | 100-EMS146  |
|   |                             | 100-E190...100-E205 | 100-EMS205  |
|   | For reversing contactors    | 100-E116...100-E146 | 100-EMR146  |
|   |                             | 100-E190...100-E205 | 100-EMR205  |
|   |                             | 100-E265...100-E370 | 100-EMR370  |
|   |                             | 100-E400...100-E460 | 100-EMR460  |
|   |                             | 100-E580...100-E750 | 100-EMR750  |
|   | For reversing starters      | 100-E116...100-E146 | 100-EMRS146 |
|   |                             | 100-E190...100-E205 | 100-EMRS205 |

## Connectors

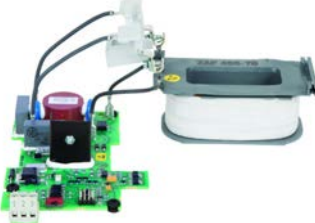
|   | Description | For Use With Circuit Breaker | For Use With Contactor | Cat. No. |
|---|-------------|------------------------------|------------------------|----------|
|  <p>For connection to 140G or 140MG</p> <ul style="list-style-type: none"> <li>• Connection between contactors/starters and molded case circuit breakers.</li> <li>• These connection sets are solid copper bars.</li> </ul> |             | 140G-H, 140MG-H              | 100-E116...100-E146    | 100-PCE1 |
|   |             | 140G-I, 140MG-I              | 100-E116...100-E146    | 100-PCE2 |
|   |             | 140G-J, 140MG-J              | 100-E116...100-E146    | 100-PCE3 |
|   |             | 140G-J, 140MG-J              | 100-E190...100-E205    | 100-PCE4 |
|   |             | 140G-K, 140MG-K              | 100-E265...100-E370    | 100-PCE5 |
|   |             | 140G-M, 140MG-M              | 100-E400...100-E750    | 100-PCE6 |
|   |             | 140G-K, 140MG-K              | 100-E400...100-E750    | 100-PCE7 |

## Terminal Accessories

|   | Description | For Use With Contactor | Cat. No.    |
|---|-------------|------------------------|-------------|
|  <p>Terminal Enlargements</p> <ul style="list-style-type: none"> <li>• Enlargement pieces designed to increase the width of the contactor terminal pads in order to allow larger connections to be mounted.</li> </ul> |             | 100-E116...100-E146    | 100-ETE146  |
|   |             | 100-E190...100-E205    | 100-ETE205  |
|   |             | 100-E265...100-E370    | 100-ETE370  |
|   |             | 100-E400...100-E460    | 100-ETE460  |
|   |             | 100-E580...100-E750    | 100-ETE750  |
|   |             | 100-E1260              | 100-ETE1260 |
|  <p>Terminal Extensions</p> <ul style="list-style-type: none"> <li>• Extension pieces designed to extend the main terminals of contactors for combined mounting of contactors and connection sets</li> </ul>           |             | 100-E116...100-E146    | 100-ETX146  |
|   |             | 100-E190...100-E205    | 100-ETX205  |
|   |             | 100-E265...100-E370    | 100-ETX370  |
|   |             | 100-E400...100-E460    | 100-ETX460  |
|   |             | 100-E580...100-E750    | 100-ETX750  |

# Renewal Parts

## Coil Modules


|  | Description                       | For Use With                 | Voltage                           | Cat. No. |
|--|-----------------------------------|------------------------------|-----------------------------------|----------|
|  | Coil Modules                      | 100-E116                     | 24...60V AC/DC                    | TG913    |
|  |                                   |                              | 48...130V AC/DC                   | TG914    |
|  |                                   |                              | 100...250V AC/DC                  | TG915    |
|  |                                   |                              | 250...500V AC/DC                  | TG916    |
|  |                                   |                              | 100...250V AC/DC w/ PLC Interface | TGE913   |
|  |                                   |                              | 250...500V AC/DC w/ PLC Interface | TGE914   |
|  |                                   | 100-E146                     | 24...60V AC/DC                    | TG901    |
|  |                                   |                              | 48...130V AC/DC                   | TG902    |
|  |                                   |                              | 100...250V AC/DC                  | TG903    |
|  |                                   |                              | 250...500V AC/DC                  | TG904    |
|  |                                   |                              | 100...250V AC/DC w/ PLC Interface | TGE903   |
|  |                                   |                              | 250...500V AC/DC w/ PLC Interface | TGE904   |
|  |                                   | 100-E190, 100-E205           | 24...60V AC/DC                    | TG905    |
|  |                                   |                              | 48...130V AC/DC                   | TG906    |
|  |                                   |                              | 100...250V AC/DC                  | TG907    |
|  |                                   |                              | 250...500V AC/DC                  | TG908    |
|  |                                   | 100-E190                     | 100...250V AC/DC w/ PLC Interface | TGE915   |
|  |                                   |                              | 250...500V AC/DC w/ PLC Interface | TGE916   |
|  |                                   | 100-E205                     | 100...250V AC/DC w/ PLC Interface | TGE907   |
|  |                                   |                              | 250...500V AC/DC w/ PLC Interface | TGE908   |
|  |                                   | 100-E265, 100-E305, 100-E370 | 24...60V AC/DC                    | TG909    |
|  |                                   |                              | 48...130V AC/DC                   | TG910    |
|  |                                   |                              | 100...250V AC/DC                  | TG911    |
|  |                                   |                              | 250...500V AC/DC                  | TG912    |
|  |                                   | 100-E265                     | 100...250V AC/DC w/ PLC Interface | TGE917   |
|  |                                   |                              | 250...500V AC/DC w/ PLC Interface | TGE918   |
|  |                                   | 100-E305                     | 100...250V AC/DC w/ PLC Interface | TGE919   |
|  |                                   |                              | 250...500V AC/DC w/ PLC Interface | TGE920   |
|  |                                   | 100-E370                     | 100...250V AC/DC w/ PLC Interface | TGE911   |
|  |                                   |                              | 250...500V AC/DC w/ PLC Interface | TGE912   |
|  |                                   | 100-E400, 100-E460           | 24...60V DC w/ PLC Interface      | THE901   |
|  |                                   |                              | 48...130V AC/DC w/ PLC Interface  | THE902   |
| 100...250V AC/DC w/ PLC Interface  | THE903                            |                              |                                   |          |
| 250...500V AC/DC w/ PLC Interface  | THE904                            |                              |                                   |          |
| 100-E580, 100-E750, 100-E1260  | 24...60V DC w/ PLC Interface      | TJE901                       |                                   |          |
|  | 48...130V AC/DC w/ PLC Interface  | TJE902                       |                                   |          |
|  | 100...250V AC/DC w/ PLC Interface | TJE903                       |                                   |          |
|  | 250...500V AC/DC w/ PLC Interface | TJE904                       |                                   |          |
| 100-E860, 100-E1060, 100-E2050   | 100...250V AC/DC w/ PLC Interface | TKE903 <sup>(1)</sup>        |                                   |          |
|  |                                   | TKE904 <sup>(2)</sup>        |                                   |          |
| 100-E2650  | 100...250V AC/DC w/ PLC Interface | TLE903 <sup>(1)</sup>        |                                   |          |
|  |                                   | TLE904 <sup>(2)</sup>        |                                   |          |

(1) One set of two coils.

(2) Printed circuit board.




**Contact Kits**

|   | Description  | For Use With                  | Cat. No.           |
|---|--------------|-------------------------------|--------------------|
|  | Contact Kits | 100-E116                      | 100-EA116          |
|   |              | 100-E146                      | 100-EA146          |
|   |              | 100-E190                      | 100-EA190          |
|   |              | 100-E205                      | 100-EA205          |
|   |              | 100-E2650                     | 100-EA265          |
|   |              | 100-E305                      | 100-EA305          |
|   |              | 100-E370                      | 100-EA370          |
|   |              | 100-E400                      | 100-EA400          |
|   |              | 100-E460                      | 100-EA460          |
|   |              | 100-E580                      | 100-EA580          |
|   |              | 100-E750                      | 100-EA750          |
|   |              | 100-E1260                     | 100-EA1260         |
|   |              | 100-E860                      | 100-EA860          |
|   |              | 100-E1060                     | 100-EA1060         |
|   |              | 100-E2050                     | 100-EA2050         |
|   |              | 100-E2650 <sup>(1)</sup>      | 100-EA2650         |
|   |              | Arc Chutes                    | 100-E400, 100-E460 |
|   |              | 100-E580, 100-E750, 100-E1260 | 100-EC750          |
|   |              | 100-E860, 1060, 100-E2050     | 100-EC1060         |
|   |              | 100-E2650                     | 100-EC2650         |

(1) Movable contacts only.

**Terminal and Mounting Hardware Kits**

|   | Description                         | For Use With                   | Cat. No.                  |
|---|-------------------------------------|--------------------------------|---------------------------|
|  | Terminal and Mounting Hardware Kits | 100-E116*L, 100-E146*L         | 100-EHS146 <sup>(1)</sup> |
|   |                                     | 100-E116, 100-E146             | 100-EHF146                |
|   |                                     | 100-E190, 100-E205             | 100-EHF205                |
|   |                                     | 100-E265, 100-E305, 100-E370   | 100-EHF370                |
|   |                                     | 100-E400, 100-E460             | 100-EHF460                |
|   |                                     | 100-E580, 100-E750, 100-E1260  | 100-EHF750                |
|   |                                     | 100-E860, 100-E1060, 100-E2050 | 100-EHF2050               |
|   |                                     | 100-E2650                      | 100-EHF2650               |

(1) Mounting hardware only.

# Specifications

**Table 28 - General Specifications**

|  |   |                 | 100-E, 100S-E, 104-E, 104S-E09...65   | 100-E, 100S-E, 104S-E80...96, 104-E80...2650 |
|--|---|-----------------|---|--|
| Rated Isolation Voltage $U_i$  | IEC                                       | [V]             | 690   | 1000   |
|  | UL, CSA                                   | [V]             | 600   | 600  |
| Rated Impulse Voltage Withstand $U_{imp}$  |   | [kV]            | 6   | 8  |
| Rated Voltage $U_e$  | AC 50/60 Hz                               | [V]             | 115, 200, 230, 240, 400, 415, 460 500, 575, 690, 1000   |  |
|  | DC  | [V]             | 24, 48, 110, 220, 440   |  |
| Electromagnetic compatibility  |   |                 | IEC 60947-1 - Environment A and B <sup>(1)</sup>  |  |
| Insulation Class of the Coil   |   |                 | Class F per IEC 60947-4-1   |  |
| Rated coil frequency   |   |                 | AC 50/60 Hz, DC   |  |
| Ambient Temperature  | Storage                                   | [°C (°F)]       | -60...+80 (-76...+176)  | -40...+70 (-40...+158)                       |
|  | Operation at rated voltage                | [°C (°F)]       | -40...+70 (-40...+158)  | -40...+70 (-40...+158)                       |
| Max. Altitude of Installation Site   |   | [m]             | 3000  |  |
| Climatic Withstand   |   |                 | Category B according to IEC 60947-1, Annex Q  |  |
| Resistance to Shock  |   |                 | IEC 60068-2-27  |  |
| Resistance to Vibration  |   |                 | IEC 60068-2-6   |  |
| Protection Class   | Contactor main contacts                   |                 | IP2X <sup>(2)</sup>   | IPO0 <sup>(2)</sup>                          |
|  | Contactor coil terminals                  |                 | IP2X (in connected state)   |  |
|  | Auxiliary contacts                        |                 | IP2X (in connected state)   |  |
| <b>Functional Safety Data (100S-E09...-E750):</b> Usable for ISO 13849-1 and IEC 62061. Data is based on the B10 value given and: - Mission time/Proof test interval of 20 years. The B10 data for 100S-E116...100S-E750 is applicable for all coil codes, including the internal PLC Interface. | 100S-E09...100S-E370                      |                 | B10: 1.0E+06 operations at 50% max. AC-3 load; failure ratio: 75% failure to open, 25% failure to close |  |
|  | 100S-E09...100S-E38                       |                 | B10: 10.0E+06 operations, mechanical only; failure ratio: 50% failure to open, 50% failure to close     |  |
|  | 100S-E40...100S-E96                       |                 | B10: 4.0E+06 operations, mechanical only; failure ratio: 50% failure to open, 50% failure to close      |  |
|  | 100S-E116...100S-E205                     |                 | B10: 5.0E+06 operations, mechanical only; failure ratio: 50% failure to open, 50% failure to close      |  |
|  | 100S-E265...100S-E370                     |                 | B10: 2.5E+06 operations, mechanical only; failure ratio: 50% failure to open, 50% failure to close      |  |
|  | 100S-E400...100S-E750                     |                 | B10: 5.0E+05 operations at 50% max. AC-3 load; failure ratio: 75% failure to open, 25% failure to close |  |
|  | 100S-E400...100S-E460                     |                 | B10: 3.0E+06 operations, mechanical only; failure ratio: 50% failure to open, 50% failure to close      |  |
|  | 100S-E580...100S-E750                     |                 | B10: 7.0E+05 operations, mechanical only; failure ratio: 50% failure to open, 50% failure to close      |  |
|  | 100S-E09...100S-E38 Electronic Components |                 | Mean time to failure (MTTF): 233 years  |  |
|  | 100S-E40...100S-E96 Electronic Components |                 | MTTF: 266 years   |  |
| 100S-E116...100S-E750 PLC Interface  |   | MTTF: 428 years |   |  |

(1) 100-E09...E38 only.

(2) 100-E40...E96 meet IP2X when used with 100-ESC... terminal shrouds.

**Table 29 - Standards Compliance and Certifications**

| Standards Compliance   | Certifications  |
|--|---|
| • IEC/EN 60947-1, Low-voltage switchgear and controlgear   | • cULus, File No. E41850 / E196120 (contactors, reversing contactors) |
| • IEC/EN 60947-4-1, Low-voltage switchgear and controlgear, Contactors and motor-starters  | • UL  |
| • IEC/EN 60947-5-1, Low-voltage switchgear and controlgear, Control circuit devices and switching elements   | • CSA   |
| • UL 60947-4-1, Industrial Control Equipment (USA)   | • CCC   |
| • CSA C22.2 No. 60947-4-1 Industrial Control Equipment (Canada).   | • EAC   |
| • Mechanically Linked Contacts: IEC 60947-5-1, Annex L (100/100S-E09...100/100S-E96 with all 100-E* front- and side-mounted N.C. auxiliary contacts) | • RCM   |
| • Mirror Contacts: IEC 60947-4-1, Annex F (100/100S-E116...100/100S-E750 with all 100-ES* side-mounted N.C. auxiliary contacts)                      | • KC  |
|  | • CE  |
|  | • SUVA  |
|  | • SEMI-F47 (Conditions of use on request)                             |

## 9...96 A Contactor Specifications

Table 30 - Main Circuits

| 100/104-E, 100S/104S-E  |                    |      | 9  | 12 | 16 | 26 | 30 | 38 | 40 | 52  | 65  | 80  | 96  |
|---|--------------------|------|----|----|----|----|----|----|----|-----|-----|-----|-----|
| <b>AC-1 Active Power Load (50/60Hz); Ambient temperature 40 °C (104 °F)</b> |                    |      |    |    |    |    |    |    |    |     |     |     |     |
| Rated Operational Current, $I_e$  | 690V               | [A]  | 25 | 28 | 30 | 45 | 50 | 50 | 70 | 100 | 105 | 125 | 130 |
|   | 1000V              | [A]  | —  | —  | —  | —  | —  | —  | —  | —   | —   | 35  | 40  |
| Rated Operational Power, $P_e$  | 230                | [kW] | 10 | 11 | 12 | 18 | 20 | 20 | 28 | 40  | 42  | 50  | 52  |
|   | 240                | [kW] | 10 | 12 | 12 | 19 | 21 | 21 | 29 | 42  | 44  | 52  | 54  |
|   | 400                | [kW] | 17 | 19 | 21 | 31 | 35 | 35 | 48 | 69  | 73  | 87  | 90  |
|   | 415                | [kW] | 18 | 20 | 22 | 32 | 36 | 36 | 50 | 72  | 75  | 90  | 93  |
|   | 500                | [kW] | 22 | 24 | 26 | 39 | 43 | 43 | 61 | 87  | 91  | 108 | 113 |
|   | 690                | [kW] | 30 | 33 | 36 | 54 | 60 | 60 | 84 | 120 | 125 | 149 | 155 |
|   | 1000               | [kW] | —  | —  | —  | —  | —  | —  | —  | —   | —   | 61  | 69  |
| <b>Ambient temperature 60 °C (140 °F)</b>                                   |                    |      |    |    |    |    |    |    |    |     |     |     |     |
| Rated Operational Current, $I_e$  | 690V               | [A]  | 25 | 28 | 30 | 40 | 42 | 42 | 60 | 80  | 90  | 100 | 105 |
|   | 1000V              | [A]  | —  | —  | —  | —  | —  | —  | —  | —   | —   | 35  | 40  |
| Rated Operational Power, $P_e$  | 230                | [kW] | 10 | 11 | 12 | 16 | 17 | 17 | 24 | 32  | 36  | 40  | 42  |
|   | 240                | [kW] | 10 | 12 | 12 | 17 | 17 | 17 | 25 | 33  | 37  | 42  | 44  |
|   | 400                | [kW] | 17 | 19 | 21 | 28 | 29 | 29 | 42 | 55  | 62  | 69  | 73  |
|   | 415                | [kW] | 18 | 20 | 22 | 29 | 30 | 30 | 43 | 58  | 65  | 72  | 75  |
|   | 500                | [kW] | 22 | 24 | 26 | 35 | 36 | 36 | 52 | 69  | 78  | 87  | 91  |
|   | 690                | [kW] | 30 | 33 | 36 | 48 | 50 | 50 | 72 | 96  | 108 | 120 | 125 |
|   | 1000               | [kW] | —  | —  | —  | —  | —  | —  | —  | —   | —   | 61  | 69  |
| <b>Ambient temperature 70 °C (158 °F)</b>                                   |                    |      |    |    |    |    |    |    |    |     |     |     |     |
| Rated Operational Current, $I_e$  | 690V               | [A]  | 22 | 24 | 26 | 32 | 37 | 37 | 50 | 70  | 80  | 85  | 90  |
|   | 1000V              | [A]  | —  | —  | —  | —  | —  | —  | —  | —   | —   | 35  | 40  |
| Rated Operational Power, $P_e$  | 230                | [kW] | 9  | 10 | 10 | 13 | 15 | 15 | 20 | 28  | 32  | 34  | 36  |
|   | 240                | [kW] | 9  | 10 | 11 | 13 | 15 | 15 | 21 | 29  | 33  | 35  | 37  |
|   | 400                | [kW] | 15 | 17 | 18 | 22 | 26 | 26 | 35 | 48  | 55  | 59  | 62  |
|   | 415                | [kW] | 16 | 17 | 19 | 23 | 27 | 27 | 36 | 50  | 58  | 61  | 65  |
|   | 500                | [kW] | 19 | 21 | 23 | 28 | 32 | 32 | 43 | 61  | 69  | 74  | 78  |
|   | 690                | [kW] | 26 | 29 | 31 | 38 | 44 | 44 | 60 | 84  | 96  | 102 | 108 |
|   | 1000               | [kW] | —  | —  | —  | —  | —  | —  | —  | —   | —   | 61  | 69  |
| With Conductor sizes  | [mm <sup>2</sup> ] | 4    | 6  | 6  | 10 | 10 | 10 | 25 | 35 | 35  | 50  | 50  |     |

Table 31 - Main Circuits

| 100/104-E, 100S/104S-E   |          | 9    | 12   | 16   | 26   | 30   | 38   | 40   | 52   | 65   | 80   | 96   |     |
|--|----------|------|------|------|------|------|------|------|------|------|------|------|-----|
| <b>Switching of 3-phase Motors; (50Hz) Ambient temperature 60 °C (140 °F) AC-2, AC-3</b> |          |      |      |      |      |      |      |      |      |      |      |      |     |
| Rated Operational Current, $I_e$   | 220-240V | [A]  | 9    | 12   | 18   | 26   | 33   | 40   | 40   | 53   | 65   | 80   | 96  |
|  | 380-400V | [A]  | 9    | 12   | 18   | 26   | 32   | 38   | 40   | 53   | 65   | 80   | 96  |
|  | 415V     | [A]  | 9    | 12   | 18   | 26   | 32   | 38   | 40   | 53   | 65   | 80   | 96  |
|  | 440V     | [A]  | 9    | 12   | 18   | 26   | 32   | 38   | 40   | 53   | 65   | 80   | 96  |
|  | 500V     | [A]  | 9.5  | 12.5 | 15   | 23   | 28   | 33   | 40   | 45   | 55   | 65   | 80  |
|  | 690V     | [A]  | 7    | 9    | 10.5 | 17   | 21   | 24   | 25   | 35   | 39   | 49   | 57  |
|  | 1000V    | [A]  | —    | —    | —    | —    | —    | —    | —    | —    | —    | 25   | 30  |
| Rated Operational Power, $P_e$   | 220-240V | [kW] | 2.2  | 3    | 4    | 6.5  | 9    | 11   | 11   | 15   | 18.5 | 22   | 25  |
|  | 380-400V | [kW] | 4.0  | 5.5  | 7.5  | 11   | 15   | 18.5 | 18.5 | 22   | 30   | 37   | 45  |
|  | 415V     | [kW] | 4.0  | 5.5  | 9    | 11   | 15   | 18.5 | 22   | 30   | 37   | 45   | 55  |
|  | 440V     | [kW] | 4.0  | 5.5  | 9    | 15   | 18.5 | 22.0 | 22   | 30   | 37   | 45   | 55  |
|  | 500V     | [kW] | 5.5  | 7.5  | 9    | 15   | 18.5 | 22.0 | 22   | 30   | 37   | 45   | 55  |
|  | 690V     | [kW] | 5.5  | 7.5  | 9    | 15   | 18.5 | 22.0 | 22   | 30   | 37   | 45   | 55  |
|  | 1000V    | [kW] | —    | —    | —    | —    | —    | —    | —    | —    | —    | 35   | 40  |
| <b>Load Carrying Capacity per UL/CSA</b>   |          |      |      |      |      |      |      |      |      |      |      |      |     |
| General Purpose Current (enclosed)   | 600V     | [A]  | 25   | 28   | 30   | 45   | 50   | 50   | 60   | 80   | 90   | 105  | 115 |
| Rated Operational Current and Power (enclosed), 1-Phase                                  | 120V     | [A]  | 13.8 | 16.0 | 20   | 24   | 24.0 | 24.0 | 34   | 34   | 56   | 80   | 80  |
|  | 240V     | [A]  | 10.0 | 12.0 | 17   | 17   | 28.0 | 28.0 | 40   | 50   | 68   | 68   | 88  |
|  | 120V     | [Hp] | 0.75 | 1    | 1.5  | 2    | 2    | 2    | 3    | 3    | 5    | 7.5  | 7.5 |
|  | 240V     | [Hp] | 1.5  | 2    | 3    | 3    | 5    | 5    | 7.5  | 10   | 15   | 15   | 20  |
| Rated Operational Current and Power (enclosed), 3-Phase                                  | 200-208  | [A]  | 7.8  | 11   | 17.5 | 25.3 | 32.2 | 32.2 | 32.2 | 48.3 | 62.1 | 78.2 | 92  |
|  | 220-240  | [A]  | 6.8  | 9.6  | 15.2 | 22.0 | 28   | 28   | 42   | 54   | 68   | 80   | 80  |
|  | 440-480  | [A]  | 7.6  | 11   | 14   | 21.0 | 27   | 34   | 40   | 52   | 65   | 77   | 77  |
|  | 550-600  | [A]  | 9    | 11   | 17   | 22.0 | 27   | 32   | 41   | 52   | 62   | 77   | 77  |
|  | 200-208  | [Hp] | 2    | 3    | 5    | 7.5  | 10   | 10   | 10   | 15   | 20   | 25   | 30  |
|  | 220-240  | [Hp] | 2    | 3    | 5    | 7.5  | 10   | 10   | 15   | 20   | 25   | 30   | 30  |
|  | 440-480  | [Hp] | 5    | 7.5  | 10   | 15.0 | 20   | 25   | 30   | 40   | 50   | 60   | 60  |
|  | 550-600  | [Hp] | 7.5  | 10   | 15   | 20.0 | 25   | 30   | 40   | 50   | 60   | 75   | 75  |
| Rated Operational Current and Power (enclosed), with 3 poles in series                   | 125V DC  | [A]  | 9.5  | 13.2 | 17   | 25.0 | 25   | 25   | 40   | 58   | 76   | 76   | 110 |
|  | 250V DC  | [A]  | 8.5  | 8.5  | 12.2 | 12.2 | 20   | 29   | 38   | 55   | 72   | 89   | 106 |
|  | 125V DC  | [Hp] | 1    | 1.5  | 2    | 3    | 3    | 3    | 5    | 7.5  | 10   | 10   | 15  |
|  | 250V DC  | [Hp] | 2    | 3    | 3    | 5    | 7.5  | 7.5  | 10   | 15   | 20   | 25   | 30  |

Table 32 - Main Circuits

| 100/104-E, 100S/104S-E                    |        |      | 9   | 12   | 16   | 26 | 30 | 38   | 40   | 52 | 65  | 80  | 96  |
|---|--------|------|-----|------|------|----|----|------|------|----|-----|-----|-----|
| <b>Wye-Delta (60 Hz)</b>                  |        |      |     |      |      |    |    |      |      |    |     |     |     |
| Rated Operational Power, P <sub>e</sub>   | 200V   | [Hp] | 3   | 5    | 7.5  | 10 | 15 | 15   | 15   | 25 | 30  | 40  | 50  |
|   | 230V   | [Hp] | 3   | 5    | 7.5  | 10 | 15 | 15   | 25   | 30 | 40  | 50  | 50  |
|   | 460V   | [Hp] | 7.5 | 10   | 15   | 25 | 30 | 40   | 50   | 60 | 75  | 100 | 100 |
|   | 575V   | [Hp] | 10  | 15   | 25   | 30 | 40 | 50   | 60   | 75 | 100 | 125 | 125 |
| <b>Star-Delta Starting (50 Hz)</b>        |        |      |     |      |      |    |    |      |      |    |     |     |     |
| Rated Operational Current, I <sub>e</sub> | ≥230V  | [A]  | 9   | 12   | 18   | 26 | 33 | 40   | 40   | 53 | 65  | 80  | 96  |
|   | ≥ 240V | [A]  | 9   | 12   | 18   | 26 | 32 | 38   | 40   | 53 | 65  | 80  | 96  |
|   | 400V   | [A]  | 9   | 12   | 18   | 26 | 32 | 38   | 40   | 53 | 65  | 80  | 96  |
|   | 415V   | [A]  | 9   | 12   | 18   | 26 | 32 | 38   | 40   | 53 | 65  | 80  | 96  |
|   | 500V   | [A]  | 9.5 | 12.5 | 15   | 23 | 28 | 33   | 40   | 45 | 55  | 65  | 80  |
|   | 690V   | [A]  | 7   | 9    | 10.5 | 17 | 21 | 24   | 25   | 35 | 39  | 49  | 57  |
|   | 1000V  | [A]  | –   | –    | –    | –  | –  | –    | –    | –  | –   | 25  | 30  |
| Rated Operational Power, P <sub>e</sub>   | 230V   | [kW] | 4   | 5.5  | 7.5  | 11 | 15 | 18.5 | 18.5 | 22 | 30  | 37  | 45  |
|   | 240V   | [kW] | 4   | 5.5  | 7.5  | 11 | 15 | 18.5 | 18.5 | 22 | 30  | 37  | 45  |
|   | 400V   | [kW] | 7.5 | 7.5  | 15   | 22 | 30 | 30   | 37   | 45 | 55  | 75  | 90  |
|   | 415V   | [kW] | 7.5 | 7.5  | 15   | 22 | 30 | 37   | 37   | 45 | 55  | 75  | 90  |
|   | 500V   | [kW] | 7.5 | 11   | 15   | 22 | 30 | 37   | 45   | 45 | 55  | 75  | 90  |
|   | 690V   | [kW] | 7.5 | 11   | 15   | 22 | 30 | 37   | 37   | 55 | 55  | 75  | 90  |
|   | 1000V  | [kW] | –   | –    | –    | –  | –  | –    | –    | –  | –   | –   | –   |

Table 33 - Main Circuits

| 100/104-E, 100S/104S-E  |             |      | 9    | 12   | 16  | 26   | 30   | 38   | 40   | 52   | 65   | 80   | 96   |
|---|-------------|------|------|------|-----|------|------|------|------|------|------|------|------|
| <b>UL/CSA Elevator Duty</b>   |             |      |      |      |     |      |      |      |      |      |      |      |      |
| Rated Operational Current and Power, 500,000 electrical operations, 1-Phase | 115V AC     | [A]  | 5.8  | 7.20 | –   | 20   | 24   | 24   | 34   | 34   | 34   | 56   | 56   |
|   | 230V AC     | [A]  | 2.20 | 3.20 | –   | 9.6  | 10   | 15.2 | 15.2 | 22   | 28   | 28   | 28   |
|   | 115V AC     | [Hp] | 0.25 | 0.33 | –   | 1.5  | 2    | 2    | 3    | 3    | 3    | 5    | 5    |
|   | 230V AC     | [Hp] | 0.50 | 0.75 | –   | 3    | 3    | 5    | 5    | 7.5  | 10   | 10   | 10   |
| Rated Operational Current and Power, 500,000 electrical operations 3-Phase  | 200V AC     | [A]  | 4.60 | 7.50 | –   | 16.7 | 24.2 | 24.2 | 30.8 | 30.8 | 46.2 | 46.2 | 46.2 |
|   | 230V AC     | [A]  | 4.20 | 6.80 | –   | 15.2 | 22   | 22   | 28   | 28   | 42   | 42   | 42   |
|   | 460V AC     | [A]  | 4.80 | 7.60 | –   | 21.0 | 27   | 27   | 34   | 40   | 52   | 52   | 52   |
|   | 575V AC     | [A]  | 3.90 | 6.10 | –   | 17   | 22   | 22   | 32   | 41   | 41   | 52   | 52   |
|   | 200V AC     | [Hp] | 1    | 2    | –   | 5    | 7.5  | 7.5  | 10   | 10   | 15   | 15   | 15   |
|   | 230V AC     | [Hp] | 1    | 2    | –   | 5    | 8    | 10   | 10   | 15   | 20   | 20   | 20   |
|   | 460V AC     | [Hp] | 3    | 5    | –   | 15   | 20   | 20   | 25   | 30   | 40   | 40   | 40   |
|   | 575V AC     | [Hp] | 3    | 5    | –   | 15   | 20   | 20   | 30   | 40   | 40   | 50   | 50   |
| <b>UL/CSA HVAC Applications</b><br>Definite purpose rating (3-phase)        |             |      |      |      |     |      |      |      |      |      |      |      |      |
| FLA   | 600V        | [A]  | 20   | 25   | 30  | 45   | 50   | 50   | 60   | 80   | 90   | 105  | 115  |
| LRA   | 200-208V AC | [A]  | 120  | 150  | 180 | 270  | 300  | 300  | 360  | 480  | 540  | 630  | 690  |
|   | 220-240V AC | [A]  | 120  | 150  | 180 | 270  | 300  | 300  | 360  | 480  | 540  | 630  | 690  |
|   | 440-480V AC | [A]  | 120  | 150  | 180 | 270  | 300  | 300  | 360  | 480  | 540  | 630  | 690  |
|   | 550-600V AC | [A]  | 80   | 100  | 120 | 180  | 200  | 200  | 240  | 320  | 360  | 420  | 460  |

**Table 34 - Main Circuits**

| 100/104-E, 100S/104S-E                                  |   |          | 9    | 12   | 16   | 26   | 30   | 38   | 40   | 52   | 65   | 80   | 96   |
|---|---|----------|------|------|------|------|------|------|------|------|------|------|------|
| <b>Switching of Power Transformers, AC-6a (50 Hz)</b>   |   |          |      |      |      |      |      |      |      |      |      |      |      |
| Inrush Current _____ = n<br>Rated transformer current   |   |          |      |      |      |      |      |      |      |      |      |      |      |
| n=30  | 230V  | [A]      | 11.7 | 13.3 | 16.7 | 26.7 | 33.3 | 40.0 | 41.7 | 51.7 | 58.3 | 63.3 | 70.0 |
|   | 240V  | [A]      | 11.7 | 13.3 | 16.7 | 26.7 | 33.3 | 40.0 | 41.7 | 51.7 | 58.3 | 63.3 | 70.0 |
|   | 400V  | [A]      | 11.7 | 13.3 | 16.7 | 26.7 | 33.3 | 40.0 | 41.7 | 51.7 | 58.3 | 63.3 | 70.0 |
|   | 415V  | [A]      | 11.7 | 13.3 | 16.7 | 26.7 | 33.3 | 40.0 | 41.7 | 51.7 | 58.3 | 63.3 | 70.0 |
|   | 500V  | [A]      | 11.7 | 13.3 | 16.7 | 26.7 | 33.3 | 40.0 | 41.7 | 51.7 | 58.3 | 63.3 | 70.0 |
|   | 690V  | [A]      | 11.7 | 13.3 | 16.7 | 26.7 | 33.3 | 40.0 | 41.7 | 51.7 | 58.3 | 63.3 | 70.0 |
| Apparent Power  | 230V  | [kVA]    | 5    | 5    | 7    | 11   | 13   | 16   | 17   | 21   | 23   | 25   | 28   |
|   | 240V  | [kVA]    | 5    | 6    | 7    | 11   | 14   | 17   | 17   | 21   | 24   | 26   | 29   |
|   | 400V  | [kVA]    | 8    | 9    | 12   | 18   | 23   | 28   | 29   | 36   | 40   | 44   | 48   |
|   | 415V  | [kVA]    | 8    | 10   | 12   | 19   | 24   | 29   | 30   | 37   | 42   | 45   | 50   |
|   | 500V  | [kVA]    | 10   | 12   | 14   | 23   | 29   | 35   | 36   | 45   | 50   | 55   | 61   |
|   | 690V  | [kVA]    | 14   | 16   | 20   | 32   | 40   | 48   | 50   | 62   | 70   | 76   | 84   |
| n=20  | 690V  | [A]      | 17.5 | 20   | 25   | 40   | 50   | 60   | 62.5 | 77.5 | 87.5 | 95   | 105  |
| n=15  | 690V  | [A]      | 23.3 | 26.7 | 33.3 | 53.3 | 66.7 | 80.0 | 83.3 | 103  | 117  | 127  | 140  |
| <b>60 Hz Peak Inrush/peak rated transformer current</b> |   |          |      |      |      |      |      |      |      |      |      |      |      |
| n=30  | 600V  | [A]      | 11.7 | 13.3 | 16.7 | 26.7 | 33.3 | 40.0 | 41.7 | 51.7 | 58.3 | 63.3 | 70.0 |
| Apparent Power  | 200V  | [kVA]    | 4    | 5    | 6    | 9    | 12   | 14   | 14   | 18   | 20   | 22   | 24   |
|   | 208V  | [kVA]    | 4    | 5    | 6    | 10   | 12   | 14   | 15   | 19   | 21   | 23   | 25   |
|   | 240V  | [kVA]    | 5    | 6    | 7    | 11   | 14   | 17   | 17   | 21   | 24   | 26   | 29   |
|   | 480V  | [kVA]    | 10   | 11   | 14   | 22   | 28   | 33   | 35   | 43   | 48   | 53   | 58   |
|   | 600V  | [kVA]    | 12   | 14   | 17   | 28   | 35   | 42   | 43   | 54   | 61   | 66   | 73   |
|   | n=20  | 600V     | [A]  | 17.5 | 20.0 | 25.0 | 40.0 | 50.0 | 60.0 | 62.5 | 77.5 | 87.5 | 95.0 |
| Apparent Power  | 200V  | [kVA]    | 6    | 7    | 9    | 14   | 17   | 21   | 22   | 27   | 30   | 33   | 36   |
|   | 208V  | [kVA]    | 6    | 7    | 9    | 14   | 18   | 22   | 22   | 28   | 31   | 34   | 38   |
|   | 240V  | [kVA]    | 7    | 8    | 10   | 17   | 21   | 25   | 26   | 32   | 36   | 39   | 44   |
|   | 480V  | [kVA]    | 15   | 17   | 21   | 33   | 42   | 50   | 52   | 64   | 73   | 79   | 87   |
|   | 600V  | [kVA]    | 18   | 21   | 26   | 42   | 52   | 62   | 65   | 80   | 91   | 99   | 109  |
|   | n=15  | 600V     | [A]  | 23.3 | 26.7 | 33.3 | 53.3 | 66.7 | 80.0 | 83.3 | 103  | 117  | 127  |
| Apparent Power  | 200V  | [kVA]    | 8    | 9    | 12   | 18   | 23   | 28   | 29   | 36   | 40   | 44   | 48   |
|   | 208V  | [kVA]    | 8    | 10   | 12   | 19   | 24   | 29   | 30   | 37   | 42   | 46   | 50   |
|   | 240V  | [kVA]    | 10   | 11   | 14   | 22   | 28   | 33   | 35   | 43   | 48   | 53   | 58   |
|   | 480V  | [kVA]    | 19   | 22   | 28   | 44   | 55   | 66   | 69   | 86   | 97   | 105  | 116  |
|   | 600V  | [kVA]    | 24   | 28   | 35   | 55   | 69   | 83   | 87   | 107  | 121  | 131  | 145  |
|   | <b>Switching of Lighting Loads (UL/CSA)</b> |          |      |      |      |      |      |      |      |      |      |      |      |
| Tungsten lamps  | 1-phase per pole                            | 347V [A] | 20   | 25   | 30   | 45   | 50   | 50   | 65   | 80   | 90   | 105  | 115  |
|   | 3-phase (break all lines)                   | 600V [A] | 20   | 25   | 30   | 45   | 50   | 50   | 65   | 80   | 90   | 105  | 115  |
| Electrical discharge lamps (ballast)                    | 1-phase per pole                            | 347V [A] | 20   | 25   | 30   | 45   | 50   | 50   | 65   | 80   | 90   | 105  | 115  |
|   | 3-phase (break all lines)                   | 600V [A] | 20   | 25   | 30   | 45   | 50   | 50   | 65   | 80   | 90   | 105  | 115  |

Table 35 - Main Circuits

| 100/104-E, 100S/104S-E  |        | 9            | 12  | 16  | 26     |        | 30     | 38     |        | 40     | 52     | 65     | 80     | 96     |      |
|---|--------|--------------|-----|-----|--------|--------|--------|--------|--------|--------|--------|--------|--------|--------|------|
|   |        | 3- or 4-Pole |     |     | 3-Pole | 4-Pole | 3-Pole | 3-Pole | 4-Pole | 3-Pole | 3-Pole | 3-Pole | 3-Pole | 3-Pole |      |
| <b>Switching of DC Loads—Non-inductive or slightly inductive loads or resistance furnaces DC-1 at 60 °C</b> |        |              |     |     |        |        |        |        |        |        |        |        |        |        |      |
| 1 pole  | ≤ 72V  | [A]          | 25  | 27  | 30     | 45     | 45     | 50     | 50     | 55     | 70     | 100    | 105    | 125    | 130  |
|   | 110V   | [A]          | 10  | 15  | 20     | —      | —      | —      | —      | —      | —      | —      | —      | —      | —    |
|   | 220V   | [A]          | —   | —   | —      | —      | —      | —      | —      | —      | —      | —      | —      | —      | —    |
| 2 poles in series   | ≤ 72V  | [A]          | 25  | 27  | 30     | 45     | 45     | 50     | 50     | 55     | 70     | 100    | 105    | 125    | 130  |
|   | 110V   | [A]          | 25  | 27  | 30     | 45     | 45     | 50     | 50     | 55     | 70     | 100    | 105    | 125    | 130  |
|   | 220V   | [A]          | 10  | 15  | 20     | —      | —      | —      | —      | —      | —      | —      | —      | —      | —    |
| 3 poles in series   | ≤ 72V  | [A]          | 25  | 27  | 30     | 45     | 45     | 50     | 50     | 55     | 70     | 100    | 105    | 125    | 130  |
|   | 110V   | [A]          | 25  | 27  | 30     | 45     | 45     | 50     | 50     | 55     | 70     | 100    | 105    | 125    | 130  |
|   | 220V   | [A]          | 25  | 27  | 30     | 45     | 45     | 50     | 50     | 55     | 70     | 100    | 105    | 125    | 130  |
| 4 poles in series   | ≤ 72V  | [A]          | 25  | —   | 30     | —      | 45     | —      | —      | 55     | —      | —      | —      | —      |      |
|   | 110V   | [A]          | 25  | —   | 30     | —      | 45     | —      | —      | 55     | —      | —      | —      | —      |      |
|   | 220V   | [A]          | 25  | —   | 30     | —      | 45     | —      | —      | 55     | —      | —      | —      | —      |      |
|   | 440V   | [A]          | 10  | —   | 20     | —      | —      | —      | —      | —      | —      | —      | —      | —      |      |
| <b>Shunt-wound Motors—Starting, reverse current breaking, reversing, stepping: DC-3 at 60 °C</b>            |        |              |     |     |        |        |        |        |        |        |        |        |        |        |      |
| 1 pole  | ≤ 72V  | [A]          | 25  | 27  | 30     | 45     | —      | 50     | 50     | —      | 70     | 100    | 105    | 125    | 130  |
|   | 110V   | [A]          | 6   | 7   | 8      | —      | —      | —      | —      | —      | —      | —      | —      | —      | —    |
|   | 220V   | [A]          | —   | —   | —      | —      | —      | —      | —      | —      | —      | —      | —      | —      | —    |
| 2 poles in series   | ≤ 72V  | [A]          | 25  | 27  | 30     | 45     | —      | 50     | 50     | —      | 70     | 100    | 105    | 125    | 130  |
|   | 110V   | [A]          | 25  | 27  | 30     | 45     | —      | 50     | 50     | —      | 70     | 100    | 105    | 125    | 130  |
|   | 220V   | [A]          | 6   | 7   | 8      | —      | —      | —      | —      | —      | —      | —      | —      | —      | —    |
| 3 poles in series   | ≤ 72V  | [A]          | 25  | 27  | 30     | 45     | —      | 50     | 50     | —      | 70     | 100    | 105    | 125    | 130  |
|   | 110V   | [A]          | 25  | 27  | 30     | 45     | —      | 50     | 50     | —      | 70     | 100    | 105    | 125    | 130  |
|   | 220V   | [A]          | 25  | 27  | 30     | 45     | —      | 50     | 50     | —      | 70     | 100    | 105    | 125    | 130  |
| 4 poles in series   | ≤ 72V  | [A]          | 25  | —   | 30     | —      | —      | —      | —      | —      | —      | —      | —      | —      |      |
|   | 110V   | [A]          | 25  | —   | 30     | —      | —      | —      | —      | —      | —      | —      | —      | —      |      |
|   | 220V   | [A]          | 25  | —   | 30     | —      | —      | —      | —      | —      | —      | —      | —      | —      |      |
|   | 440V   | [A]          | 6   | —   | 8      | —      | —      | —      | —      | —      | —      | —      | —      | —      |      |
| <b>Series-wound Motors—Starting, reverse current breaking, reversing, stepping: DC-5 at 60 °C</b>           |        |              |     |     |        |        |        |        |        |        |        |        |        |        |      |
| 1 pole  | ≤ 72V  | [A]          | 9   | 12  | 16     | 20     | —      | 25     | 25     | —      | 70     | 100    | 105    | 125    | 130  |
|   | 110V   | [A]          | 4   | 4   | 4      | —      | —      | —      | —      | —      | —      | —      | —      | —      | —    |
|   | 220V   | [A]          | —   | —   | —      | —      | —      | —      | —      | —      | —      | —      | —      | —      | —    |
| 2 poles in series   | ≤ 72V  | [A]          | 25  | 27  | 30     | 45     | —      | 50     | 50     | —      | 70     | 100    | 105    | 125    | 130  |
|   | 110V   | [A]          | 10  | 15  | 20     | 45     | —      | 50     | 50     | —      | 70     | 100    | 105    | 125    | 130  |
|   | 220V   | [A]          | 4   | 4   | 4      | —      | —      | —      | —      | —      | —      | —      | —      | —      | —    |
| 3 poles in series   | ≤ 72V  | [A]          | 25  | 27  | 30     | 45     | —      | 50     | 50     | —      | 70     | 100    | 105    | 125    | 130  |
|   | 110V   | [A]          | 25  | 27  | 30     | 45     | —      | 50     | 50     | —      | 70     | 100    | 105    | 125    | 130  |
|   | 220V   | [A]          | 9   | 12  | 16     | 20     | —      | 25     | 25     | —      | 70     | 100    | 105    | 125    | 130  |
| 4 poles in series   | ≤ 72V  | [A]          | 25  | —   | 30     | —      | —      | —      | —      | —      | —      | —      | —      | —      |      |
|   | 110V   | [A]          | 25  | —   | 30     | —      | —      | —      | —      | —      | —      | —      | —      | —      |      |
|   | 220V   | [A]          | 10  | —   | 20     | —      | —      | —      | —      | —      | —      | —      | —      | —      |      |
|   | 440V   | [A]          | 4   | —   | 4      | —      | —      | —      | —      | —      | —      | —      | —      | —      |      |
| <b>Short Time Withstand I<sub>CW</sub> 40 °C (104 °F)</b>   |        |              |     |     |        |        |        |        |        |        |        |        |        |        |      |
| 3- and 4-Pole   | 1 s    | [A]          | 300 | 300 | 300    | 700    | 700    | 700    | 700    | 700    | 1000   | 1000   | 1000   | 1200   | 1200 |
|   | 10 s   | [A]          | 150 | 150 | 150    | 350    | 350    | 350    | 350    | 350    | 600    | 600    | 600    | 780    | 780  |
|   | 30 s   | [A]          | 80  | 80  | 80     | 225    | 225    | 225    | 225    | 225    | 350    | 350    | 350    | 450    | 450  |
|   | 1 min  | [A]          | 60  | 60  | 60     | 150    | 150    | 150    | 150    | 150    | 250    | 250    | 250    | 300    | 300  |
|   | 15 min | [A]          | 35  | 35  | 35     | 50     | 50     | 50     | 50     | 50     | 110    | 110    | 110    | 140    | 140  |

**Table 36 - Main Circuits**

| 100/104-E, 100S/104S-E   |            | 9              | 12            | 16          | 26          | 30          | 38          | 40           | 52          | 65          | 80          | 96          |             |
|--|------------|----------------|---------------|-------------|-------------|-------------|-------------|--------------|-------------|-------------|-------------|-------------|-------------|
|  |            | 3-Pole         |               |             | 3-Pole      | 3-Pole      | 3-Pole      | 3-Pole       | 3-Pole      | 3-Pole      | 3-Pole      | 3-Pole      |             |
| <b>Resistance and Power Dissipation</b>                                |            |                |               |             |             |             |             |              |             |             |             |             |             |
| Main current circuit resistance  |            | [mΩ]           | 1.23          | 1.39        | 1.08        | 0.89        | 0.88        | 0.9          | 0.63        | 0.61        | 0.64        | 0.47        | 0.49        |
| Power dissipation per pole at $I_e$ AC-1, 400V                         |            | [W]            | 0.8           | 1           | 1.2         | 1.8         | 2.4         | 2.4          | 3           | 6.3         | 7           | 7.6         | 8.2         |
| Power dissipation per pole at $I_e$ AC-3, 400V                         |            | [W]            | 0.1           | 0.2         | 0.35        | 0.6         | 0.9         | 1.3          | 1           | 1.7         | 2.7         | 3           | 4.5         |
| Total Power dissipation at: $I_e$ AC-3, 400V; AC/DC control (120-250V) |            | [W]            | 2.3           | 2.6         | 3.1         | 3.8         | 4.7         | 5.9          | 5           | 7.1         | 10.1        | 11          | 15.5        |
| Maximum Switching Frequency  | AC-1       | ops/hr         | 600 cycles/h  |             |             |             |             |              |             |             |             |             |             |
|  | AC-3       | ops/hr         | 1200 cycles/h |             |             |             |             |              |             |             |             |             |             |
|  | AC-2, AC-4 | ops/hr         | 300 cycles/h  |             |             |             |             | 150 cycles/h |             |             |             |             |             |
| Lifespan, mechanical   |            | [Million ops.] | 10            | 10          | 10          | 10          | 10          | 10           | 4           | 4           | 4           | 4           | 4           |
| <b>Weight</b>  |            |                |               |             |             |             |             |              |             |             |             |             |             |
| AC/DC Coil Codes   | KJ, KY     | [kg (lbs.)]    | 0.27 (0.59)   | 0.27 (0.59) | 0.27 (0.59) | 0.31 (0.68) | 0.31 (0.68) | 0.31 (0.68)  | 0.97 (2.13) | 0.97 (2.13) | 0.97 (2.13) | 1.22 (2.68) | 1.22 (2.68) |
|  | KD         | [kg (lbs.)]    | 0.27 (0.59)   | 0.27 (0.59) | 0.27 (0.59) | 0.31 (0.68) | 0.31 (0.68) | 0.31 (0.68)  | 0.95 (2.09) | 0.95 (2.09) | 0.95 (2.09) | 1.17 (2.57) | 1.17 (2.57) |
|  | KN         | [kg (lbs.)]    | 0.31 (0.68)   | 0.31 (0.68) | 0.31 (0.68) | 0.35 (0.77) | 0.35 (0.77) | 0.35 (0.77)  | 0.95 (2.09) | 0.95 (2.09) | 0.95 (2.09) | 1.17 (2.57) | 1.17 (2.57) |
| DC Coil Codes  | E0, EJ     | [kg (lbs.)]    | 0.31 (0.68)   | 0.31 (0.68) | 0.31 (0.68) | 0.35 (0.77) | 0.35 (0.77) | 0.35 (0.77)  | –           | –           | –           | –           | –           |
|  | 0J         | [kg (lbs.)]    | 0.43 (0.95)   | 0.43 (0.95) | 0.43 (0.95) | 0.48 (1.06) | 0.48 (1.06) | 0.48 (1.06)  | –           | –           | –           | –           | –           |

**Table 37 - Short-circuit Current Ratings**

| 100/104-E, 100S/104S-E   |                           | 9   | 12                             | 16 | 26 | 30 | 38  | 40  | 52  | 65  | 80  | 96  |
|--|---------------------------|-----|--------------------------------|----|----|----|-----|-----|-----|-----|-----|-----|
| <b>Short Circuit Coordination (Max. Fuse or Circuit Breaker Rating) Per IEC 60947-4-1</b>  |                           |     |                                |    |    |    |     |     |     |     |     |     |
| DIN FUSES- gG  | Type "2" (400V)           | [A] | 100 kA Available Fault Current |    |    |    |     |     |     |     |     |     |
|  |                           |     | 32                             | 32 | 35 | 62 | 80  | 80  | 100 | 125 | 125 | 160 |
| MCCB (140G-H)  | Type "2" (690V)           | [A] | 60 kA Available Fault Current  |    |    |    |     |     |     |     |     |     |
|  |                           |     | 6                              | 10 | 16 | 32 | 32  | 40  | 40  | 63  | 80  | 80  |
| MCCB (140G-H)  | Type "2" (400V)           | [A] | 70 kA Available Fault Current  |    |    |    |     |     |     |     |     |     |
|  |                           |     |                                |    |    |    | 15  | 20  | 50  | 80  | 80  | 80  |
| <b>Short Circuit Current Rating (Max. Fuse or Circuit Breaker Rating) Per UL 60947 and CSA 22.2 No. 14 (contactor and fuses or circuit breaker only)</b> |                           |     |                                |    |    |    |     |     |     |     |     |     |
| UL Class RK5 Fuses   | Type 1 Combination (600V) | [A] | 5 kA Available Fault Current   |    |    |    |     |     |     |     |     |     |
|  |                           |     | 30                             | 30 | 60 | 60 | 100 | 100 | 150 | 150 | –   | –   |
| UL Class RK5 Fuses   | Type 1 Combination (600V) | [A] | 10 kA Available Fault Current  |    |    |    |     |     |     |     |     |     |
|  |                           |     | –                              | –  | –  | –  | –   | –   | –   | –   | 150 | 200 |
| UL Class J and CSA HRCI-J Fuses  | Type 1 Combination (600V) | [A] | 100 kA Available Fault Current |    |    |    |     |     |     |     |     |     |
|  |                           |     | 30                             | 30 | 60 | 60 | 100 | 100 | 150 | 150 | 150 | 200 |



**Table 37 - Short-circuit Current Ratings (Continued)**

| 100/104-E, 100S/104S-E             |                           |                               | 9                              | 12 | 16  | 26  | 30  | 38  | 40  | 52  | 65  | 80  | 96  |
|------------------------------------|---------------------------|-------------------------------|--------------------------------|----|-----|-----|-----|-----|-----|-----|-----|-----|-----|
| UL Inverse-Time<br>Circuit Breaker | Type 1 Combination (480V) | [A]                           | 5 kA Available Fault Current   |    |     |     |     |     |     |     |     |     |     |
|                                    |                           |                               | 60                             | 60 | 60  | 100 | 125 | 125 | 250 | 250 | —   | —   | —   |
|                                    | Type 1 Combination (480V) | [A]                           | 10 kA Available Fault Current  |    |     |     |     |     |     |     |     |     |     |
|                                    |                           |                               | 60                             | 60 | 60  | —   | —   | —   | —   | —   | 250 | 250 | 250 |
|                                    | Type 1 Combination (480V) | [A]                           | 65 kA Available Fault Current  |    |     |     |     |     |     |     |     |     |     |
|                                    |                           |                               | —                              | —  | —   | 100 | —   | —   | 250 | 250 | 250 | 250 | 250 |
|                                    | Type 1 Combination (480V) | [A]                           | 100 kA Available Fault Current |    |     |     |     |     |     |     |     |     |     |
|                                    |                           |                               | —                              | —  | —   | —   | 125 | 125 | —   | —   | —   | 100 | 100 |
|                                    | Type 1 Combination (600V) | [A]                           | 5 kA Available Fault Current   |    |     |     |     |     |     |     |     |     |     |
|                                    |                           |                               | 60                             | 60 | —   | —   | 125 | 125 | 250 | 250 | —   | —   | —   |
| Type 1 Combination (600V)          | [A]                       | 10 kA Available Fault Current |                                |    |     |     |     |     |     |     |     |     |     |
|                                    |                           | —                             | —                              | 60 | —   | —   | —   | 250 | 250 | 250 | 250 | 250 |     |
| Type 1 Combination (600V)          | [A]                       | 25 kA Available Fault Current |                                |    |     |     |     |     |     |     |     |     |     |
|                                    |                           | —                             | —                              | —  | 100 | —   | —   | —   | —   | —   | —   | —   |     |
| Type 1 Combination (600V)          | [A]                       | 35 kA Available Fault Current |                                |    |     |     |     |     |     |     |     |     |     |
|                                    |                           | —                             | —                              | —  | —   | 125 | 125 | —   | —   | 250 | —   | —   |     |
| Type 1 Combination (600V)          | [A]                       | 50 kA Available Fault Current |                                |    |     |     |     |     |     |     |     |     |     |
|                                    |                           | —                             | —                              | —  | —   | —   | —   | —   | —   | —   | —   | 250 | 250 |

**Table 38 - Coil Data**

| 100/104-E, 100S/104S-E            |               |          | 9          | 12 | 16 | 26 | 30 | 38       | 40 | 52 | 65    | 80 | 96 |   |
|-----------------------------------|---------------|----------|------------|----|----|----|----|----------|----|----|-------|----|----|---|
| <b>Operating Limits</b>           |               |          |            |    |    |    |    |          |    |    |       |    |    |   |
| 50/60Hz                           | pick-up       | [x Us]   | 0.85...1.1 |    |    |    |    |          |    |    |       |    |    |   |
|                                   | dropout       | [x Us]   | ≤ 0.60     |    |    |    |    |          |    |    |       |    |    |   |
| DC Control                        | pick-up       | [x Us]   | 0.80...1.1 |    |    |    |    |          |    |    |       |    |    |   |
|                                   | dropout       | [x Us]   | ≤ 0.60     |    |    |    |    |          |    |    |       |    |    |   |
| <b>Standard Coil</b>              |               |          |            |    |    |    |    |          |    |    |       |    |    |   |
| 24-60V AC, 20-60V DC (KJ)         | pick-up       | [VA]/[W] | 50/50      |    |    |    |    | 25/25    |    |    | 40/40 |    |    |   |
|                                   | hold-in       | [VA]/[W] | 2.2/2      |    |    |    |    | 4/2      |    |    | 4/2   |    |    |   |
| 48...130V AC/DC (KY)              | pick-up       | [VA]/[W] | 50/50      |    |    |    |    | 25/25    |    |    | 40/40 |    |    |   |
|                                   | hold-in       | [VA]/[W] | 2.2/2      |    |    |    |    | 4/2      |    |    | 4/2   |    |    |   |
| 100...250V AC/DC (KD)             | pick-up       | [VA]/[W] | 50/50      |    |    |    |    | 25/25    |    |    | 40/40 |    |    |   |
|                                   | hold-in       | [VA]/[W] | 2.2/2      |    |    |    |    | 4/2      |    |    | 4/2   |    |    |   |
| 250...500V AC/DC (KN)             | pick-up       | [VA]/[W] | 50/50      |    |    |    |    | 25/25    |    |    | 40/40 |    |    |   |
|                                   | hold-in       | [VA]/[W] | 2.2/2      |    |    |    |    | 4/2      |    |    | 4/2   |    |    |   |
| Operating Times                   | closing delay | [ms]     | 40...95    |    |    |    |    | 42...100 |    |    |       |    |    |   |
|                                   | opening delay | [ms]     | 11...95    |    |    |    |    | 17...100 |    |    |       |    |    |   |
| <b>Energy-efficient Coil</b>      |               |          |            |    |    |    |    |          |    |    |       |    |    |   |
| 12-20V DC (EQ)                    | pick-up       | [W]      | 12...16    |    |    |    |    | —        | —  | —  | —     | —  | —  | — |
|                                   | hold-in       | [W]      | 1.7        |    |    |    |    | —        | —  | —  | —     | —  | —  | — |
| 24-60V AC, 20-60V DC (EJ)         | pick-up       | [VA]/[W] | 16/12...16 |    |    |    |    | —        | —  | —  | —     | —  | —  | — |
|                                   | hold-in       | [VA]/[W] | 1.7/1.7    |    |    |    |    | —        | —  | —  | —     | —  | —  | — |
| Operating Times                   | closing delay | [ms]     | 40...95    |    |    |    |    | —        | —  | —  | —     | —  | —  | — |
|                                   | opening delay | [ms]     | 11...95    |    |    |    |    | —        | —  | —  | —     | —  | —  | — |
| <b>High Energy Efficient Coil</b> |               |          |            |    |    |    |    |          |    |    |       |    |    |   |
| 24V DC (QJ)                       | pick-up       | [W]      | 6          |    |    |    |    | —        | —  | —  | —     | —  | —  | — |
|                                   | hold-in       | [W]      | 1.7        |    |    |    |    | —        | —  | —  | —     | —  | —  | — |
| Operating Times                   | closing delay | [ms]     | 27...53    |    |    |    |    | —        | —  | —  | —     | —  | —  | — |
|                                   | opening delay | [ms]     | 17...29    |    |    |    |    | —        | —  | —  | —     | —  | —  | — |

# 116...2650 A Contactors

Table 39 - Main Circuits

| 100/104-E, 100S-E  |                    | 116  | 146 | 190 | 205                | 265 | 305                | 370                  | 400   | 460   | 580   | 750                | 860                 | 1060                | 1260                | 2050                | 2650                |      |
|--|--------------------|------|-----|-----|--------------------|-----|--------------------|----------------------|-------|-------|-------|--------------------|---------------------|---------------------|---------------------|---------------------|---------------------|------|
| <b>AC-1 Active Power Load (50/60 Hz); Ambient temperature 40 °C (104 °F)</b> |                    |      |     |     |                    |     |                    |                      |       |       |       |                    |                     |                     |                     |                     |                     |      |
| Rated Operational Current, $I_e$   | 690V               | [A]  | 160 | 225 | 275                | 350 | 400                | 500                  | 600   | 600   | 700   | 800                | 1050                | 1350                | 1650                | 1260                | 2050                | 2650 |
|  | 1000V              | [A]  | 160 | 225 | 250                | 275 | 350                | 375                  | 400   | 600   | 700   | 800                | 1050                | 1350                | 1650                | 1260                | 2050                | 2650 |
| Rated Operational Power, $P_e$   | 230V               | [kW] | 64  | 90  | 110                | 139 | 159                | 199                  | 239   | 239   | 279   | 319                | 418                 | 538                 | 657                 | 502                 | 817                 | 1056 |
|  | 240V               | [kW] | 67  | 94  | 114                | 145 | 166                | 208                  | 249   | 249   | 291   | 333                | 436                 | 561                 | 686                 | 524                 | 852                 | 1102 |
|  | 400V               | [kW] | 111 | 156 | 191                | 242 | 277                | 346                  | 416   | 416   | 485   | 554                | 727                 | 935                 | 1143                | 873                 | 1420                | 1836 |
|  | 415V               | [kW] | 115 | 162 | 198                | 252 | 288                | 359                  | 431   | 431   | 503   | 575                | 755                 | 970                 | 1186                | 906                 | 1474                | 1905 |
|  | 500V               | [kW] | 139 | 195 | 238                | 303 | 346                | 433                  | 520   | 520   | 606   | 693                | 909                 | 1169                | 1429                | 1091                | 1775                | 2295 |
|  | 690V               | [kW] | 191 | 269 | 329                | 418 | 478                | 598                  | 717   | 717   | 837   | 956                | 1255                | 1613                | 1972                | 1506                | 2450                | 3167 |
|  | 1000V              | [kW] | 277 | 390 | 433                | 476 | 606                | 650                  | 693   | 1039  | 1212  | 1386               | 1819                | 2338                | 2858                | 2182                | 3551                | 4590 |
| <b>Ambient temperature 60 °C (140 °F)</b>                                    |                    |      |     |     |                    |     |                    |                      |       |       |       |                    |                     |                     |                     |                     |                     |      |
| Rated Operational Current, $I_e$   | 690V               | [A]  | 145 | 200 | 250                | 300 | 350                | 400                  | 500   | 500   | 600   | 700                | 875                 | 1150                | 1450                | 1040                | 1750                | 2350 |
|  | 1000V              | [A]  | 145 | 200 | 225                | 250 | 300                | 325                  | 350   | 500   | 600   | 700                | 875                 | 1150                | 1450                | 1040                | 1750                | 2350 |
| Rated Operational Power, $P_e$   | 230V               | [kW] | 58  | 80  | 100                | 120 | 139                | 159                  | 199   | 199   | 239   | 279                | 349                 | 458                 | 578                 | 414                 | 697                 | 936  |
|  | 240V               | [kW] | 60  | 83  | 104                | 125 | 145                | 166                  | 208   | 208   | 249   | 291                | 364                 | 478                 | 603                 | 432                 | 727                 | 977  |
|  | 400V               | [kW] | 100 | 139 | 173                | 208 | 242                | 277                  | 346   | 346   | 416   | 485                | 606                 | 797                 | 1005                | 721                 | 1212                | 1628 |
|  | 415V               | [kW] | 104 | 144 | 180                | 216 | 252                | 288                  | 359   | 359   | 431   | 503                | 629                 | 827                 | 1042                | 748                 | 1258                | 1689 |
|  | 500V               | [kW] | 126 | 173 | 217                | 260 | 303                | 346                  | 433   | 433   | 520   | 606                | 758                 | 996                 | 1256                | 901                 | 1516                | 2035 |
|  | 690V               | [kW] | 173 | 239 | 299                | 359 | 418                | 478                  | 598   | 598   | 717   | 837                | 1046                | 1374                | 1733                | 1243                | 2091                | 2809 |
|  | 1000V              | [kW] | 251 | 346 | 390                | 433 | 520                | 563                  | 606   | 866   | 1039  | 1212               | 1516                | 1992                | 2511                | 1801                | 3031                | 4070 |
| <b>Ambient temperature 70 °C (158 °F)</b>                                    |                    |      |     |     |                    |     |                    |                      |       |       |       |                    |                     |                     |                     |                     |                     |      |
| Rated Operational Current, $I_e$   | 690V               | [A]  | 130 | 175 | 200                | 240 | 290                | 325                  | 400   | 400   | 480   | 580                | 720                 | 1000                | 1270                | 875                 | 1500                | 2120 |
|  | 1000V              | [A]  | 130 | 175 | 185                | 200 | 240                | 260                  | 290   | 400   | 480   | 580                | 720                 | 1000                | 1270                | 875                 | 1500                | 2120 |
| Rated Operational Power, $P_e$   | 230V               | [kW] | 52  | 70  | 80                 | 96  | 116                | 129                  | 159   | 159   | 191   | 231                | 287                 | 398                 | 506                 | 349                 | 598                 | 845  |
|  | 240V               | [kW] | 54  | 73  | 83                 | 100 | 121                | 135                  | 166   | 166   | 200   | 241                | 299                 | 416                 | 528                 | 364                 | 624                 | 881  |
|  | 400V               | [kW] | 90  | 121 | 139                | 166 | 201                | 225                  | 277   | 277   | 333   | 402                | 499                 | 693                 | 880                 | 606                 | 1039                | 1469 |
|  | 415V               | [kW] | 93  | 126 | 144                | 173 | 208                | 234                  | 288   | 288   | 345   | 417                | 518                 | 719                 | 913                 | 629                 | 1078                | 1524 |
|  | 500V               | [kW] | 113 | 152 | 173                | 208 | 251                | 281                  | 346   | 346   | 416   | 502                | 624                 | 866                 | 1100                | 758                 | 1299                | 1836 |
|  | 690V               | [kW] | 155 | 209 | 239                | 287 | 347                | 388                  | 478   | 478   | 574   | 693                | 860                 | 1195                | 1518                | 1046                | 1793                | 2534 |
|  | 1000V              | [kW] | 225 | 303 | 320                | 346 | 416                | 450                  | 502   | 693   | 831   | 1005               | 1247                | 1732                | 2200                | 1516                | 2598                | 3672 |
| With conductor sizes   | [mm <sup>2</sup> ] | 70   | 95  | 150 | 240 <sup>(1)</sup> | 240 | 300 <sup>(2)</sup> | 2x185 <sup>(2)</sup> | 2x185 | 2x240 | 2x240 | 800 <sup>(3)</sup> | 1000 <sup>(4)</sup> | 1500 <sup>(4)</sup> | 1000 <sup>(3)</sup> | 2000 <sup>(4)</sup> | 3000 <sup>(4)</sup> |      |

(1) For currents above 275 A, use terminal extensions.  
 (2) For currents above 450 A, use terminal extensions.  
 (3) Maximum connection bar width 50 mm.  
 (4) Maximum connection bar width 100 mm.

Table 40 - Main Circuits

| 100/104-E, 100S-E                                       |          |      | 116 | 146 | 190 | 205 | 265 | 305 | 370 | 400 | 460 | 580 | 750 | 860  | 1060 | 1260 | 2050 | 2650 |
|---|----------|------|-----|-----|-----|-----|-----|-----|-----|-----|-----|-----|-----|------|------|------|------|------|
| <b>Switching of 3-phase Motors: (50 Hz)</b>             |          |      |     |     |     |     |     |     |     |     |     |     |     |      |      |      |      |      |
| <b>Ambient temperature 60 °C (140 °F) AC-2, AC-3</b>    |          |      |     |     |     |     |     |     |     |     |     |     |     |      |      |      |      |      |
| Rated Operational Current, $I_e$                        | 220-240V | [A]  | 116 | 146 | 190 | 205 | 265 | 305 | 370 | 400 | 460 | 580 | 750 | 860  | 1060 | —    | —    | —    |
|   | 380-400V | [A]  | 116 | 146 | 190 | 205 | 265 | 305 | 370 | 400 | 460 | 580 | 750 | 860  | 1060 | —    | —    | —    |
|   | 415V     | [A]  | 116 | 146 | 190 | 205 | 265 | 305 | 370 | 400 | 460 | 580 | 750 | 860  | 1060 | —    | —    | —    |
|   | 440V     | [A]  | 116 | 146 | 190 | 205 | 265 | 305 | 370 | 400 | 460 | 580 | 750 | 860  | 1060 | —    | —    | —    |
|   | 500V     | [A]  | 110 | 130 | 156 | 185 | 250 | 290 | 350 | 400 | 460 | 580 | 750 | 860  | 970  | —    | —    | —    |
|   | 690V     | [A]  | 66  | 93  | 135 | 165 | 250 | 290 | 315 | 350 | 400 | 500 | 650 | 800  | 970  | —    | —    | —    |
|   | 1000V    | [A]  | 46  | 60  | 85  | 100 | 113 | 131 | 141 | 155 | 200 | 250 | 300 | 375  | 400  | —    | —    | —    |
| Rated Operational Power, $P_e$                          | 220-240V | [kW] | 37  | 45  | 55  | 55  | 75  | 90  | 110 | 110 | 132 | 160 | 220 | 250  | 315  | —    | —    | —    |
|   | 380-400V | [kW] | 55  | 75  | 90  | 110 | 132 | 160 | 200 | 200 | 250 | 315 | 400 | 475  | 560  | —    | —    | —    |
|   | 415V     | [kW] | 55  | 75  | 90  | 110 | 132 | 160 | 200 | 220 | 250 | 355 | 425 | 500  | 630  | —    | —    | —    |
|   | 440V     | [kW] | 75  | 90  | 110 | 132 | 160 | 160 | 200 | 220 | 250 | 355 | 450 | 560  | 710  | —    | —    | —    |
|   | 500V     | [kW] | 75  | 90  | 110 | 132 | 160 | 200 | 250 | 250 | 315 | 400 | 530 | 630  | 710  | —    | —    | —    |
|   | 690V     | [kW] | 63  | 90  | 132 | 160 | 200 | 250 | 315 | 315 | 355 | 500 | 600 | 800  | 1000 | —    | —    | —    |
|   | 1000V    | [kW] | 55  | 75  | 110 | 132 | 160 | 185 | 200 | 220 | 280 | 355 | 400 | 555  | 600  | —    | —    | —    |
| <b>Load Carrying Capacity per UL/CSA</b>                |          |      |     |     |     |     |     |     |     |     |     |     |     |      |      |      |      |      |
| General-purpose Current (enclosed)                      |          | [A]  | 160 | 200 | 250 | 300 | 350 | 400 | 520 | 550 | 650 | 750 | 900 | 1350 | 1650 | 1210 | 2100 | 2700 |
| Rated Operational Current and Power (enclosed), 3-Phase | 200V     | [A]  | 92  | 120 | 150 | 177 | 221 | 285 | 359 | 359 | 414 | 552 | 692 | 954  | 1030 | —    | —    | —    |
|   | 230V     | [A]  | 104 | 130 | 154 | 192 | 248 | 312 | 360 | 360 | 480 | 604 | 722 | 954  | 1030 | —    | —    | —    |
|   | 460V     | [A]  | 96  | 124 | 156 | 180 | 240 | 302 | 361 | 414 | 477 | 590 | 722 | 954  | 1030 | —    | —    | —    |
|   | 575V     | [A]  | 99  | 125 | 144 | 192 | 242 | 289 | 336 | 382 | 472 | 578 | 672 | 944  | 1050 | —    | —    | —    |
|   | 200V     | [Hp] | 30  | 40  | 50  | 60  | 75  | 100 | 125 | 125 | 150 | 200 | 250 | —    | —    | —    | —    | —    |
|   | 230V     | [Hp] | 40  | 50  | 60  | 75  | 100 | 125 | 150 | 150 | 200 | 250 | 300 | 400  | 450  | —    | —    | —    |
|   | 460V     | [Hp] | 75  | 100 | 125 | 150 | 200 | 250 | 300 | 350 | 400 | 500 | 600 | 800  | 900  | —    | —    | —    |
|   | 575V     | [Hp] | 100 | 125 | 150 | 200 | 250 | 300 | 350 | 400 | 500 | 600 | 700 | 1000 | 1150 | —    | —    | —    |
| Rated Current (enclosed), with 3 poles in series        | 260V DC  | [A]  | 160 | 200 | —   | —   | —   | —   | —   | —   | —   | —   | —   | —    | —    | —    | —    | —    |
|   | 300V DC  | [A]  | —   | —   | 230 | 250 | —   | —   | —   | —   | —   | —   | —   | —    | —    | —    | —    | —    |
|   | 340V DC  | [A]  | —   | —   | —   | —   | 350 | 400 | 520 | —   | —   | —   | —   | —    | —    | —    | —    | —    |
|   | 600V DC  | [A]  | —   | —   | —   | —   | —   | —   | —   | 550 | 650 | 750 | 900 | 1050 | 1350 | 1210 | 1900 | —    |

Table 41 - Main Circuits

| 100/104-E, 100S-E  |                                |      | 116  | 146 | 190 | 205 | 265 | 305 | 370 | 400 | 460 | 580  | 750 | 860 | 1060 | 1260 | 2050 | 2650 |   |
|--|--------------------------------|------|------|-----|-----|-----|-----|-----|-----|-----|-----|------|-----|-----|------|------|------|------|---|
| <b>Switching of 3-phase Motors, (50Hz); Ambient temperature 60°C, AC-4</b> |                                |      |      |     |     |     |     |     |     |     |     |      |     |     |      |      |      |      |   |
| Rated Operational Current, $I_e$   | 230V                           | [A]  | 84   | 103 | 128 | 156 | 195 | 230 | 280 | 307 | 377 | -    | -   | -   | -    | -    | -    | -    |   |
|  | 240V                           | [A]  | 84   | 103 | 128 | 156 | 195 | 230 | 280 | 307 | 377 | -    | -   | -   | -    | -    | -    | -    |   |
|  | 400V                           | [A]  | 84   | 103 | 128 | 156 | 195 | 230 | 280 | 307 | 377 | -    | -   | -   | -    | -    | -    | -    |   |
|  | 415V                           | [A]  | 84   | 103 | 128 | 156 | 195 | 230 | 280 | 307 | 377 | -    | -   | -   | -    | -    | -    | -    |   |
|  | 500V                           | [A]  | 84   | 103 | 128 | 156 | 195 | 230 | 280 | 307 | 377 | -    | -   | -   | -    | -    | -    | -    |   |
|  | 690V                           | [A]  | 66   | 80  | 93  | 104 | 153 | 162 | 188 | 334 | 350 | -    | -   | -   | -    | -    | -    | -    | - |
|  | 1000V                          | [A]  | 40   | 48  | 72  | 85  | 90  | 95  | 100 | 141 | 155 | -    | -   | -   | -    | -    | -    | -    | - |
| Rated Operational Power, $P_e$   | 230V                           | [kW] | 25   | 32  | 40  | 50  | 55  | 75  | 90  | 90  | 110 | -    | -   | -   | -    | -    | -    | -    |   |
|  | 240V                           | [kW] | 25   | 32  | 40  | 50  | 63  | 75  | 90  | 100 | 125 | -    | -   | -   | -    | -    | -    | -    |   |
|  | 400V                           | [kW] | 45   | 55  | 63  | 80  | 110 | 132 | 160 | 160 | 200 | -    | -   | -   | -    | -    | -    | -    |   |
|  | 415V                           | [kW] | 45   | 55  | 63  | 90  | 110 | 132 | 160 | 160 | 220 | -    | -   | -   | -    | -    | -    | -    |   |
|  | 500V                           | [kW] | 55   | 63  | 90  | 110 | 132 | 160 | 200 | 220 | 250 | -    | -   | -   | -    | -    | -    | -    |   |
|  | 690V                           | [kW] | 63   | 75  | 90  | 100 | 150 | 160 | 185 | 315 | 335 | -    | -   | -   | -    | -    | -    | -    |   |
|  | 1000V                          | [kW] | 55   | 63  | 100 | 110 | 125 | 132 | 132 | 200 | 220 | -    | -   | -   | -    | -    | -    | -    |   |
| <b>AC-4 at approximately 200,000 operations</b>                            |                                |      |      |     |     |     |     |     |     |     |     |      |     |     |      |      |      |      |   |
| Rated Operational Current, $I_e$   | 230V                           | [A]  | 38   | 38  | 49  | 55  | 73  | 89  | 100 | 118 | 135 | -    | -   | -   | -    | -    | -    | -    |   |
|  | 240V                           | [A]  | 38   | 38  | 49  | 55  | 73  | 89  | 100 | 118 | 135 | -    | -   | -   | -    | -    | -    | -    |   |
|  | 400/415V                       | [A]  | 38   | 38  | 49  | 55  | 73  | 89  | 100 | 118 | 135 | -    | -   | -   | -    | -    | -    | -    |   |
|  | 500V                           | [A]  | 33   | 33  | 37  | 44  | 53  | 59  | 68  | 78  | 89  | -    | -   | -   | -    | -    | -    | -    |   |
|  | 690V                           | [A]  | 33   | 33  | 37  | 44  | 53  | 59  | 68  | 78  | 89  | -    | -   | -   | -    | -    | -    | -    |   |
|  | 1000V                          | [A]  | -    | -   | -   | -   | -   | -   | -   | -   | -   | -    | -   | -   | -    | -    | -    | -    |   |
|  | Rated Operational Power, $P_e$ | 230V | [kW] | 11  | 11  | 13  | 15  | 22  | 25  | 30  | 37  | 40   | -   | -   | -    | -    | -    | -    | - |
| 240V   |                                | [kW] | 11   | 11  | 15  | 15  | 22  | 25  | 32  | 37  | 45  | -    | -   | -   | -    | -    | -    | -    |   |
| 400V   |                                | [kW] | 20   | 20  | 25  | 30  | 40  | 50  | 55  | 63  | 75  | -    | -   | -   | -    | -    | -    | -    |   |
| 415V   |                                | [kW] | 20   | 20  | 25  | 30  | 40  | 50  | 55  | 63  | 75  | -    | -   | -   | -    | -    | -    | -    |   |
| 500V   |                                | [kW] | 22   | 22  | 25  | 30  | 37  | 40  | 45  | 55  | 63  | -    | -   | -   | -    | -    | -    | -    |   |
| 690V   |                                | [kW] | 30   | 30  | 32  | 40  | 50  | 55  | 63  | 75  | 80  | -    | -   | -   | -    | -    | -    | -    |   |
| 1000V  |                                | [kW] | -    | -   | -   | -   | -   | -   | -   | -   | -   | -    | -   | -   | -    | -    | -    | -    |   |
| Max. switching frequency   | Ops/h                          | 150  | 150  | 150 | 150 | 150 | 150 | 150 | 60  | 60  | -   | -    | -   | -   | -    | -    | -    |      |   |
| <b>Wye-Delta (60 Hz)</b>   |                                |      |      |     |     |     |     |     |     |     |     |      |     |     |      |      |      |      |   |
| Rated Operational Power, $P_e$   | 200V                           | [Hp] | 50   | 60  | 75  | 100 | 125 | 150 | 200 | 200 | 250 | -    | -   | -   | -    | -    | -    | -    |   |
|  | 230V                           | [Hp] | 60   | 75  | 100 | 125 | 150 | 200 | 250 | 250 | 350 | 450  | 500 | -   | -    | -    | -    | -    |   |
|  | 460V                           | [Hp] | 125  | 150 | 200 | 250 | 350 | 450 | 500 | 500 | 600 | 800  | -   | -   | -    | -    | -    | -    |   |
|  | 575V                           | [Hp] | 150  | 200 | 250 | 300 | 450 | 500 | 600 | 600 | 700 | 1000 | -   | -   | -    | -    | -    | -    |   |

Table 42 - Main Circuits

| 100/104-E, 100S-E                  |                      |      | 116 | 146 | 190  | 205  | 265  | 305  | 370  | 400 | 460 | 580  | 750  | 860  | 1060 | 1260 | 2050 | 2650 |   |
|------------------------------------|----------------------|------|-----|-----|------|------|------|------|------|-----|-----|------|------|------|------|------|------|------|---|
| <b>UL/CSA Elevator Duty</b>        |                      |      |     |     |      |      |      |      |      |     |     |      |      |      |      |      |      |      |   |
| Rated Operational Current, $I_e$   | 200V                 | [A]  | 54  | 54  | 77   | 99   | 125  | 149  | 156  | —   | —   | —    | —    | —    | —    | —    | —    | —    | — |
|                                    | 230V                 | [A]  | 54  | 54  | 77   | 99   | 125  | 149  | 156  | —   | —   | —    | —    | —    | —    | —    | —    | —    | — |
|                                    | 460V                 | [A]  | 54  | 54  | 77   | 99   | 125  | 149  | 156  | —   | —   | —    | —    | —    | —    | —    | —    | —    | — |
|                                    | 575V                 | [A]  | 54  | 54  | 77   | 99   | 125  | 149  | 156  | —   | —   | —    | —    | —    | —    | —    | —    | —    | — |
| Rated Operational Power, $P_e$     | 200V                 | [Hp] | 15  | 15  | 20   | 30   | 40   | 40   | 50   | —   | —   | —    | —    | —    | —    | —    | —    | —    | — |
|                                    | 230V                 | [Hp] | 20  | 20  | 25   | 30   | 40   | 50   | 60   | —   | —   | —    | —    | —    | —    | —    | —    | —    | — |
|                                    | 460V                 | [Hp] | 40  | 40  | 60   | 75   | 100  | 100  | 125  | —   | —   | —    | —    | —    | —    | —    | —    | —    | — |
|                                    | 575V                 | [Hp] | 50  | 50  | 75   | 100  | 125  | 150  | 150  | —   | —   | —    | —    | —    | —    | —    | —    | —    | — |
| <b>UL/CSA HVAC Applications</b>    |                      |      |     |     |      |      |      |      |      |     |     |      |      |      |      |      |      |      |   |
| Definite purpose rating (3-phase)  |                      |      |     |     |      |      |      |      |      |     |     |      |      |      |      |      |      |      |   |
| FLA                                | 600V                 | [A]  | 116 | 160 | 200  | 250  | 300  | 350  | 520  | —   | —   | —    | —    | —    | —    | —    | —    | —    | — |
| LRA                                | 230V                 | [A]  | 700 | 960 | 1200 | 1500 | 1800 | 2100 | 3120 | —   | —   | —    | —    | —    | —    | —    | —    | —    | — |
|                                    | 460V                 | [A]  | 580 | 800 | 1000 | 1250 | 1500 | 1750 | 2600 | —   | —   | —    | —    | —    | —    | —    | —    | —    | — |
|                                    | 575V                 | [A]  | 470 | 640 | 800  | 1000 | 1200 | 1400 | 2080 | —   | —   | —    | —    | —    | —    | —    | —    | —    | — |
| AC resistance heating              | 600V                 | [A]  | 160 | 200 | 250  | 300  | 400  | 450  | 520  | —   | —   | —    | —    | —    | —    | —    | —    | —    | — |
| <b>Star-Delta Starting (50 Hz)</b> |                      |      |     |     |      |      |      |      |      |     |     |      |      |      |      |      |      |      |   |
| Rated Operational Current, $I_e$   | ≤ 230V               | [A]  | 200 | 252 | 329  | 355  | 458  | 528  | 640  | 692 | 796 | 1004 | 1299 | 1489 | 1835 | —    | —    | —    | — |
|                                    | ≤ 240V               | [A]  | 200 | 252 | 329  | 355  | 458  | 528  | 640  | 692 | 796 | 1004 | 1299 | 1489 | 1835 | —    | —    | —    | — |
|                                    | 400V                 | [A]  | 200 | 252 | 329  | 355  | 458  | 528  | 640  | 692 | 796 | 1004 | 1299 | 1489 | 1835 | —    | —    | —    | — |
|                                    | 415V                 | [A]  | 200 | 252 | 329  | 355  | 458  | 528  | 640  | 692 | 796 | 1004 | 1299 | 1489 | 1835 | —    | —    | —    | — |
|                                    | 500V                 | [A]  | 190 | 225 | 233  | 285  | 433  | 502  | 545  | 692 | 796 | 1004 | 1299 | 1385 | 1680 | —    | —    | —    | — |
|                                    | 690V                 | [A]  | 112 | 161 | 233  | 285  | 433  | 502  | 545  | 606 | 692 | 866  | 1125 | 1385 | 1680 | —    | —    | —    | — |
|                                    | 1000V                | [A]  | —   | 103 | 147  | 173  | 173  | 173  | 173  | 268 | 346 | 433  | 519  | —    | —    | —    | —    | —    | — |
| Rated Operational Power, $P_e$     | 230V <sup>(1)</sup>  | [kW] | 55  | 75  | 90   | 110  | 132  | 160  | 200  | 200 | 250 | 315  | 400  | 500  | 560  | —    | —    | —    | — |
|                                    | 240V <sup>(1)</sup>  | [kW] | 55  | 75  | 110  | 110  | 132  | 160  | 200  | 200 | 250 | 315  | 400  | 500  | 630  | —    | —    | —    | — |
|                                    | 400V <sup>(1)</sup>  | [kW] | 110 | 132 | 160  | 200  | 250  | 250  | 355  | 400 | 400 | 560  | 710  | 800  | 1000 | —    | —    | —    | — |
|                                    | 415V <sup>(1)</sup>  | [kW] | 110 | 132 | 160  | 200  | 250  | 315  | 355  | 400 | 400 | 560  | 800  | 900  | 1100 | —    | —    | —    | — |
|                                    | 500V <sup>(1)</sup>  | [kW] | 132 | 160 | 160  | 200  | 315  | 355  | 355  | 500 | 500 | 710  | 800  | 1000 | 1300 | —    | —    | —    | — |
|                                    | 690V <sup>(1)</sup>  | [kW] | 90  | 132 | 200  | 250  | 400  | 500  | 500  | 560 | 710 | 800  | 1100 | 1400 | 1700 | —    | —    | —    | — |
|                                    | 1000V <sup>(1)</sup> | [kW] | —   | 132 | 200  | 250  | 250  | 250  | 250  | 355 | 500 | 630  | 710  | —    | —    | —    | —    | —    | — |

(1) Power ratings at 50 Hz: Preferred values according to IEC 60947-4-1.

Table 43 - Main Circuits

| 100/104-E, 100S-E                                       |         | 116   | 146 | 190 | 205 | 265 | 305 | 370 | 400 | 460 | 580 | 750 | 860 | 1060 | 1260 | 2050 | 2650 |   |
|---|---------|-------|-----|-----|-----|-----|-----|-----|-----|-----|-----|-----|-----|------|------|------|------|---|
| <b>Switching of Power Transformers, AC-6a (50 Hz)</b>   |         |       |     |     |     |     |     |     |     |     |     |     |     |      |      |      |      |   |
| Inrush Current _____ = n                                |         |       |     |     |     |     |     |     |     |     |     |     |     |      |      |      |      |   |
| Rated transformer current                               |         |       |     |     |     |     |     |     |     |     |     |     |     |      |      |      |      |   |
| n = 30  | ≥ 230V  | [A]   | 70  | 79  | 111 | 115 | 143 | 165 | 200 | 252 | 263 | 286 | 430 | 524  | 362  | —    | —    | — |
|   | ≥ 240V  | [A]   | 70  | 79  | 111 | 115 | 143 | 165 | 200 | 252 | 263 | 286 | 430 | 524  | 362  | —    | —    | — |
|   | ≥ 400V  | [A]   | 70  | 79  | 111 | 115 | 143 | 165 | 200 | 252 | 263 | 286 | 430 | 524  | 362  | —    | —    | — |
|   | ≥ 415V  | [A]   | 70  | 79  | 111 | 115 | 143 | 165 | 200 | 252 | 263 | 286 | 430 | 524  | 362  | —    | —    | — |
|   | ≥ 500V  | [A]   | 70  | 79  | 111 | 115 | 143 | 165 | 200 | 252 | 263 | 286 | —   | —    | 362  | —    | —    | — |
|   | ≥ 690V  | [A]   | 70  | 79  | 111 | 115 | 143 | 165 | 200 | 252 | 263 | 286 | —   | —    | 362  | —    | —    | — |
|   | ≥ 1000V | [A]   | —   | —   | —   | —   | —   | —   | —   | —   | —   | —   | —   | —    | —    | —    | —    | — |
| Apparent Power  | 230V    | [kVA] | 28  | 31  | 44  | 46  | 57  | 66  | 80  | 100 | 105 | 114 | 171 | 209  | 144  | —    | —    | — |
|   | 240V    | [kVA] | 29  | 33  | 46  | 48  | 59  | 69  | 83  | 105 | 109 | 119 | 179 | 218  | 150  | —    | —    | — |
|   | 400V    | [kVA] | 48  | 55  | 77  | 80  | 99  | 114 | 139 | 175 | 182 | 198 | 298 | 363  | 251  | —    | —    | — |
|   | 415V    | [kVA] | 50  | 56  | 79  | 82  | 102 | 117 | 142 | 179 | 187 | 203 | 305 | 372  | 257  | —    | —    | — |
|   | 500V    | [kVA] | 61  | 68  | 96  | 100 | 124 | 143 | 173 | 218 | 228 | 248 | —   | —    | 314  | —    | —    | — |
|   | 690V    | [kVA] | 84  | 94  | 133 | 137 | 171 | 197 | 239 | 301 | 314 | 342 | —   | —    | 433  | —    | —    | — |
| n = 20  | ≥ 690V  | [A]   | 105 | 119 | 167 | 173 | 215 | 248 | 300 | 378 | 395 | 429 | —   | —    | 543  | —    | —    | — |
| n = 15  | ≥ 690V  | [A]   | 140 | 158 | 222 | 230 | 286 | 330 | 400 | 504 | 526 | 572 | —   | —    | 724  | —    | —    | — |
| <b>60 Hz Peak Inrush/peak rated transformer current</b> |         |       |     |     |     |     |     |     |     |     |     |     |     |      |      |      |      |   |
| n = 30  | ≥ 660V  | [A]   | 70  | 79  | 111 | 115 | 143 | 165 | 200 | 252 | 263 | 286 | 430 | 524  | 362  | —    | —    | — |
| Apparent Power  | 200V    | [kVA] | 24  | 27  | 38  | 40  | 50  | 57  | 69  | 87  | 91  | 99  | 149 | 182  | 125  | —    | —    | — |
|   | 208V    | [kVA] | 25  | 28  | 40  | 41  | 52  | 59  | 72  | 91  | 95  | 103 | 155 | 189  | 130  | —    | —    | — |
|   | 240V    | [kVA] | 29  | 33  | 46  | 48  | 59  | 69  | 83  | 105 | 109 | 119 | 179 | 218  | 150  | —    | —    | — |
|   | 480V    | [kVA] | 58  | 66  | 92  | 96  | 119 | 137 | 166 | 210 | 219 | 238 | 357 | 436  | 301  | —    | —    | — |
|   | 600V    | [kVA] | 73  | 82  | 115 | 120 | 149 | 171 | 208 | 262 | 273 | 297 | 447 | 545  | 376  | —    | —    | — |
|   | 660V    | [kVA] | 80  | 90  | 127 | 131 | 163 | 189 | 229 | 288 | 301 | 327 | 492 | 599  | 414  | —    | —    | — |
| n = 20  | ≥ 660V  | [A]   | 105 | 119 | 167 | 173 | 215 | 248 | 300 | 378 | 395 | 429 | 645 | 786  | 543  | —    | —    | — |
| Apparent Power  | 200V    | [kVA] | 36  | 41  | 58  | 60  | 74  | 86  | 104 | 131 | 137 | 149 | 223 | 272  | 188  | —    | —    | — |
|   | 208V    | [kVA] | 38  | 43  | 60  | 62  | 77  | 89  | 108 | 136 | 142 | 155 | 232 | 283  | 196  | —    | —    | — |
|   | 240V    | [kVA] | 44  | 49  | 69  | 72  | 89  | 103 | 125 | 157 | 164 | 178 | 268 | 327  | 226  | —    | —    | — |
|   | 480V    | [kVA] | 87  | 99  | 139 | 144 | 179 | 206 | 249 | 314 | 328 | 357 | 536 | 653  | 451  | —    | —    | — |
|   | 600V    | [kVA] | 109 | 124 | 174 | 180 | 223 | 258 | 312 | 393 | 410 | 446 | 670 | 817  | 564  | —    | —    | — |
|   | 660V    | [kVA] | 120 | 136 | 191 | 198 | 246 | 284 | 343 | 432 | 452 | 490 | 737 | 899  | 621  | —    | —    | — |
| n = 15  | ≥ 660V  | [A]   | 140 | 158 | 222 | 230 | 286 | 330 | 400 | 504 | 526 | 572 | 860 | 1048 | 724  | —    | —    | — |
| Apparent Power  | 200V    | [kVA] | 48  | 55  | 77  | 80  | 99  | 114 | 139 | 175 | 182 | 198 | 298 | 363  | 251  | —    | —    | — |
|   | 208V    | [kVA] | 50  | 57  | 80  | 83  | 103 | 119 | 144 | 182 | 190 | 206 | 310 | 378  | 261  | —    | —    | — |
|   | 240V    | [kVA] | 58  | 66  | 92  | 96  | 119 | 137 | 166 | 210 | 219 | 238 | 357 | 436  | 301  | —    | —    | — |
|   | 480V    | [kVA] | 116 | 131 | 185 | 191 | 238 | 274 | 333 | 419 | 437 | 476 | 715 | 871  | 602  | —    | —    | — |
|   | 600V    | [kVA] | 145 | 164 | 231 | 239 | 297 | 343 | 416 | 524 | 547 | 594 | 894 | 1089 | 752  | —    | —    | — |
|   | 660V    | [kVA] | 160 | 181 | 254 | 263 | 327 | 377 | 457 | 576 | 601 | 654 | 983 | 1198 | 828  | —    | —    | — |

Table 44 - Main Circuits

| 100/104-E, 100S-E                                     |              |        | 116 | 146 | 190 | 205 | 265 | 305 | 370 | 400 | 460 | 580 | 750 | 860 | 1060 | 1260 | 2050 | 2650 |  |
|---|--------------|--------|-----|-----|-----|-----|-----|-----|-----|-----|-----|-----|-----|-----|------|------|------|------|--|
| <b>Switching of 3-phase Capacitors, AC-6b (50 Hz)</b> |              |        |     |     |     |     |     |     |     |     |     |     |     |     |      |      |      |      |  |
| Single capacitor 40 °C                                | 230V         | [kVAR] | 40  | 50  | 60  | 75  | 85  | 100 | 110 | 120 | 140 | 170 | 220 | 250 | 300  | –    | –    | –    |  |
|   | 240V         | [kVAR] | 40  | 50  | 60  | 75  | 85  | 100 | 110 | 120 | 140 | 170 | 220 | 250 | 300  | –    | –    | –    |  |
|   | 400V         | [kVAR] | 75  | 90  | 110 | 130 | 145 | 165 | 200 | 210 | 240 | 285 | 400 | 450 | 500  | –    | –    | –    |  |
|   | 415V         | [kVAR] | 75  | 90  | 110 | 130 | 145 | 165 | 200 | 210 | 240 | 285 | 400 | 450 | 500  | –    | –    | –    |  |
|   | 500V         | [kVAR] | 83  | 110 | 140 | 160 | 180 | 210 | 240 | 260 | 325 | 350 | 490 | 550 | 600  | –    | –    | –    |  |
|   | 690V         | [kVAR] | 80  | 110 | 135 | 170 | 200 | 240 | 280 | 300 | 325 | 440 | 600 | 650 | 800  | –    | –    | –    |  |
|   | 1000V        | [kVAR] | –   | 100 | 140 | 150 | 155 | 160 | 170 | 250 | 300 | 350 | 450 | –   | –    | –    | –    | –    |  |
| Single capacitor 55 °C                                | 230V         | [kVAR] | 40  | 50  | 60  | 75  | 85  | 100 | 110 | 120 | 140 | 170 | 220 | 250 | 300  | –    | –    | –    |  |
|   | 240V         | [kVAR] | 40  | 50  | 60  | 75  | 85  | 100 | 110 | 120 | 140 | 170 | 220 | 250 | 300  | –    | –    | –    |  |
|   | 400V         | [kVAR] | 75  | 90  | 110 | 130 | 145 | 165 | 200 | 210 | 240 | 285 | 400 | 450 | 500  | –    | –    | –    |  |
|   | 415V         | [kVAR] | 75  | 90  | 110 | 130 | 145 | 165 | 200 | 210 | 240 | 285 | 400 | 450 | 500  | –    | –    | –    |  |
|   | 500V         | [kVAR] | 83  | 110 | 140 | 160 | 180 | 210 | 240 | 260 | 325 | 350 | 490 | 550 | 600  | –    | –    | –    |  |
|   | 690V         | [kVAR] | 80  | 110 | 135 | 170 | 200 | 240 | 280 | 300 | 325 | 440 | 600 | 650 | 800  | –    | –    | –    |  |
|   | 1000V        | [kVAR] | –   | 100 | 140 | 150 | 155 | 160 | 170 | 250 | 300 | 350 | 450 | –   | –    | –    | –    | –    |  |
| Single capacitor 70 °C                                | 230V         | [kVAR] | 35  | 42  | 45  | 57  | 70  | 85  | 100 | 105 | 120 | 160 | 190 | 230 | 280  | –    | –    | –    |  |
|   | 240V         | [kVAR] | 35  | 42  | 45  | 57  | 70  | 85  | 100 | 105 | 120 | 160 | 190 | 230 | 280  | –    | –    | –    |  |
|   | 400V         | [kVAR] | 65  | 74  | 83  | 105 | 135 | 155 | 180 | 195 | 225 | 275 | 370 | 430 | 480  | –    | –    | –    |  |
|   | 415V         | [kVAR] | 65  | 74  | 83  | 105 | 135 | 155 | 180 | 195 | 225 | 275 | 370 | 430 | 480  | –    | –    | –    |  |
|   | 500V         | [kVAR] | 78  | 96  | 102 | 130 | 165 | 196 | 220 | 241 | 300 | 340 | 435 | 530 | 570  | –    | –    | –    |  |
|   | 690V         | [kVAR] | 75  | 110 | 135 | 160 | 200 | 240 | 260 | 300 | 325 | 440 | 600 | 630 | 750  | –    | –    | –    |  |
|   | 1000V        | [kVAR] | –   | 95  | 120 | 130 | 140 | 150 | 160 | 220 | 270 | 300 | 400 | –   | –    | –    | –    | –    |  |
| <b>60 Hz Single Capacitor (cULus)</b>                 |              |        |     |     |     |     |     |     |     |     |     |     |     |     |      |      |      |      |  |
| Single capacitor 40 °C                                | 208V         | [kVAR] | 33  | 41  | 50  | 67  | 83  | 100 | 125 | 119 | 142 | 178 | 214 | –   | 346  | –    | –    | –    |  |
|   | 240V         | [kVAR] | 38  | 48  | 57  | 77  | 95  | 115 | 144 | 137 | 164 | 205 | 247 | –   | 398  | –    | –    | –    |  |
|   | 480V         | [kVAR] | 75  | 100 | 125 | 150 | 200 | 250 | 300 | 274 | 329 | 411 | 494 | –   | 832  | –    | –    | –    |  |
|   | 600V         | [kVAR] | 100 | 125 | 150 | 200 | 250 | 300 | 350 | 343 | 410 | 514 | 618 | –   | 1040 | –    | –    | –    |  |
| <b>Switching of Lamps</b>                             |              |        |     |     |     |     |     |     |     |     |     |     |     |     |      |      |      |      |  |
| Gas discharge lamps AC-5a                             | open         | [A]    | 116 | 146 | 190 | 205 | 265 | 305 | 370 | 400 | 460 | 580 | 750 | 877 | 1072 | 812  | 1332 | 1722 |  |
| UL Ballast Ratings                                    |              | [A]    | 160 | 200 | 250 | 300 | 400 | 450 | 520 | –   | –   | –   | –   | –   | –    | –    | –    | –    |  |
| Filament AC-5b  | 230/<br>240V | [A]    | 116 | 146 | 190 | 205 | 265 | 305 | 370 | 400 | 460 | 580 | 750 | 877 | 1072 | 812  | 1332 | 1722 |  |

Table 45 - Main Circuits

| 100/104-E, 100S-E   |            |                | 116   | 146   | 190   | 205   | 265   | 305   | 370   | 400   | 460   | 580   | 750   | 860   | 1060  | 1260  | 2050  | 2650  |       |  |    |  |
|---|------------|----------------|-------|-------|-------|-------|-------|-------|-------|-------|-------|-------|-------|-------|-------|-------|-------|-------|-------|--|----|--|
| <b>Switching of DC Loads—Non-inductive or slightly inductive loads or resistance furnaces DC-1 at 60 °C</b>   |            |                |       |       |       |       |       |       |       |       |       |       |       |       |       |       |       |       |       |  |    |  |
| 1 pole  | ≤ 72V      | [A]            | 160   | 200   | 250   | 350   | 400   | 500   | 520   | 600   | 700   | 800   | 1050  | 1350  | 1650  | 1250  | 2050  | —     | —     |  |    |  |
|   | 90V        | [A]            | 160   | 200   | 250   | 350   | 400   | 500   | 520   | —     | —     | —     | —     | —     | —     | —     | —     | —     | —     |  |    |  |
|   | 100V       | [A]            | —     | —     | 250   | 350   | 400   | 500   | 520   | —     | —     | —     | —     | —     | —     | —     | —     | —     | —     |  |    |  |
|   | 110V       | [A]            | —     | —     | —     | —     | 400   | 500   | 520   | 600   | 700   | 800   | 1050  | 1350  | 1650  | 1250  | 2050  | —     | —     |  |    |  |
| 2 poles in series   | ≤ 72V      | [A]            | 160   | 200   | 250   | 350   | 400   | 500   | 520   | 600   | 700   | 800   | 1050  | 1350  | 1650  | 1250  | 2050  | —     | —     |  |    |  |
|   | 110V       | [A]            | 160   | 200   | 250   | 350   | 400   | 500   | 520   | 600   | 700   | 800   | 1050  | 1350  | 1650  | 1250  | 2050  | —     | —     |  |    |  |
|   | 175V       | [A]            | 160   | 200   | 250   | 350   | 400   | 500   | 520   | 600   | 700   | 800   | 1050  | —     | —     | —     | —     | —     | —     |  |    |  |
|   | 200V       | [A]            | —     | —     | 250   | 350   | 400   | 500   | 520   | 600   | 700   | 800   | 1050  | —     | —     | —     | —     | —     | —     |  |    |  |
| 3 poles in series   | ≤ 72V      | [A]            | 160   | 200   | 250   | 350   | 400   | 500   | 520   | 600   | 700   | 800   | 1050  | 1350  | 1650  | 1250  | 2050  | —     | —     |  |    |  |
|   | 110V       | [A]            | 160   | 200   | 250   | 350   | 400   | 500   | 520   | 600   | 700   | 800   | 1050  | 1350  | 1650  | 1250  | 2050  | —     | —     |  |    |  |
|   | 175V       | [A]            | 160   | 200   | 250   | 350   | 400   | 500   | 520   | 600   | 700   | 800   | 1050  | 1350  | 1650  | 1250  | 2050  | —     | —     |  |    |  |
|   | 220V       | [A]            | 160   | 200   | 250   | 350   | 400   | 500   | 520   | 600   | 700   | 800   | 1050  | 1350  | 1650  | 1250  | 2050  | —     | —     |  |    |  |
|   | 260V       | [A]            | 160   | 200   | 250   | 350   | 400   | 500   | 520   | 600   | 700   | 800   | 1050  | 1350  | 1650  | 1250  | 2050  | —     | —     |  |    |  |
|   | 300V       | [A]            | —     | —     | 250   | 350   | 400   | 500   | 520   | 600   | 700   | 800   | 1050  | 1350  | 1650  | 1250  | 2050  | —     | —     |  |    |  |
|   | 340V       | [A]            | —     | —     | —     | —     | 400   | 500   | 520   | 600   | 700   | 800   | 1050  | 1350  | 1650  | 1250  | 2050  | —     | —     |  |    |  |
|   | 600V       | [A]            | —     | —     | —     | —     | —     | —     | —     | 600   | 700   | 800   | 1050  | 1350  | 1650  | 1250  | 2050  | —     | —     |  |    |  |
| 850V  | [A]        | —              | —     | —     | —     | —     | —     | —     | —     | —     | 800   | 1050  | 1350  | 1650  | 1250  | 2050  | —     | —     |       |  |    |  |
| <b>Shunt-wound Motors—Starting, reverse current breaking, reversing, stepping DC-3, 60 °C (L/R ≤ 2 ms)</b>    |            |                |       |       |       |       |       |       |       |       |       |       |       |       |       |       |       |       |       |  |    |  |
| 3 poles in series   | 24V        | [A]            | 145   | 160   | 250   | 275   | 350   | 400   | 450   | 600   | 700   | 800   | 1050  | —     | —     | —     | —     | —     | —     |  |    |  |
|   | 48/60V     | [A]            | 145   | 160   | 250   | 275   | 350   | 400   | 450   | 600   | 700   | 800   | 1050  | —     | —     | —     | —     | —     | —     |  |    |  |
|   | 110V       | [A]            | 145   | 160   | 250   | 275   | 350   | 400   | 450   | 600   | 700   | 800   | 1050  | —     | —     | —     | —     | —     | —     |  |    |  |
|   | 220V       | [A]            | 145   | 160   | 250   | 275   | 350   | 400   | 450   | 600   | 700   | 800   | 1050  | —     | —     | —     | —     | —     | —     |  |    |  |
|   | 600V       | [A]            | —     | —     | —     | —     | —     | —     | —     | 600   | 700   | 800   | 1050  | —     | —     | —     | —     | —     | —     |  |    |  |
| <b>Series-wound Motors—Starting, reverse current breaking, reversing, stepping DC-5, 60 °C (L/R ≤ 7.5 ms)</b> |            |                |       |       |       |       |       |       |       |       |       |       |       |       |       |       |       |       |       |  |    |  |
| 3 poles in series   | 24V        | [A]            | 145   | 160   | 250   | 275   | 350   | 400   | 450   | 600   | 700   | 800   | 1050  | —     | —     | —     | —     | —     | —     |  |    |  |
|   | 48/60V     | [A]            | 145   | 160   | 250   | 275   | 350   | 400   | 450   | 600   | 700   | 800   | 1050  | —     | —     | —     | —     | —     | —     |  |    |  |
|   | 110V       | [A]            | 145   | 160   | 250   | 275   | 350   | 400   | 450   | 600   | 700   | 800   | 1050  | —     | —     | —     | —     | —     | —     |  |    |  |
|   | 220V       | [A]            | 145   | 160   | 250   | 275   | 350   | 400   | 450   | 600   | 700   | 800   | 1050  | —     | —     | —     | —     | —     | —     |  |    |  |
|   | 600V       | [A]            | —     | —     | —     | —     | —     | —     | —     | 600   | 700   | 800   | 1050  | —     | —     | —     | —     | —     | —     |  |    |  |
| <b>Short Time Withstand I<sub>CW</sub></b>  |            |                |       |       |       |       |       |       |       |       |       |       |       |       |       |       |       |       |       |  |    |  |
| 40 °C   | 1 s        | [A]            | 1300  | 1460  | 1900  | 2050  | 2650  | 3050  | 3700  | 4600  | 4600  | 7000  | 7000  | 10000 | 12000 | 8000  | 12000 | 12000 | 12000 |  |    |  |
|   | 10 s       | [A]            | 928   | 1168  | 1520  | 1640  | 2120  | 2440  | 2960  | 4400  | 4400  | 6400  | 6400  | 8000  | 10000 | 7200  | 10000 | 10000 | 10000 |  |    |  |
|   | 30 s       | [A]            | 536   | 674   | 878   | 947   | 1224  | 1409  | 1709  | 3100  | 3100  | 4500  | 4500  | 6000  | 7500  | 5200  | 7500  | 7500  | 7500  |  |    |  |
|   | 1 min      | [A]            | 379   | 477   | 621   | 670   | 865   | 996   | 1208  | 2500  | 2500  | 3500  | 3500  | 4500  | 5500  | 4000  | 5500  | 5500  | 5500  |  |    |  |
|   | 15 min     | [A]            | 160   | 225   | 275   | 350   | 400   | 500   | 600   | 840   | 840   | 1300  | 1300  | 1600  | 2200  | 1500  | 2200  | 2800  | 2800  |  |    |  |
| <b>Resistance and Power Dissipation</b>   |            |                |       |       |       |       |       |       |       |       |       |       |       |       |       |       |       |       |       |  |    |  |
| Main current circuit resistance   |            | [mΩ]           | 0.469 | 0.454 | 0.198 | 0.204 | 0.200 | 0.200 | 0.200 | 0.083 | 0.086 | 0.050 | 0.045 | 0.044 | 0.029 | 0.050 | 0.030 | 0.028 | —     |  |    |  |
| Power dissipation per pole at I <sub>e</sub> AC-1, 400V   |            | [W]            | 12    | 23    | 15    | 25    | 32    | 50    | 72    | 30    | 42    | 32    | 50    | 80    | 80    | 80    | 125   | 200   | —     |  |    |  |
| Power dissipation per pole at I <sub>e</sub> AC-3/400V  |            | [W]            | 6     | 10    | 7     | 8     | 14    | 19    | 27    | 16    | 21    | 17    | 28    | 50    | 50    | —     | —     | —     | —     |  |    |  |
| Total power dissipation at:   |            |                |       |       |       |       |       |       |       |       |       |       |       |       |       |       |       |       |       |  |    |  |
| I <sub>e</sub> AC-3, 400V; AC/DC control (120-250V)   |            | [W]            | 21    | 33    | 23.5  | 26.5  | 46.5  | 61.5  | 85.5  | 53    | 68    | 56    | 89    | 171   | 171   | —     | —     | —     | —     |  |    |  |
| Maximum Switching Frequency   | AC-1       | ops/hr         | 300   |       |       |       |       |       | 300   |       |       |       |       |       | 60    |       | 300   |       | 60    |  | 15 |  |
|   | AC-3       | ops/hr         | 300   |       |       |       |       |       | 300   |       |       |       |       |       | 60    |       | —     |       | —     |  | —  |  |
|   | AC-2, AC-4 | ops/hr         | 150   |       |       |       |       |       | 60    |       |       |       |       |       | 60    |       | —     |       | —     |  | —  |  |
| Lifespan, mechanical  |            | [Million ops.] | 5     | 5     | 5     | 5     | 5     | 5     | 5     | 3     | 3     | 3     | 3     | 0.5   | 0.5   | 0.5   | 0.5   | 0.5   | 0.3   |  |    |  |



**Table 45 - Main Circuits (Continued)**

| 100/104-E, 100S-E                          |              | 116            | 146            | 190        | 205        | 265            | 305            | 370            | 400          | 460          | 580        | 750        | 860          | 1060       | 1260         | 2050       | 2650       |
|--|--------------|----------------|----------------|------------|------------|----------------|----------------|----------------|--------------|--------------|------------|------------|--------------|------------|--------------|------------|------------|
| <b>Weight</b>                              |              |                |                |            |            |                |                |                |              |              |            |            |              |            |              |            |            |
| AC/DC (Electronic)<br>with bar connections | kg<br>(lbs.) | 1.50<br>(3.3)  | 1.50<br>(3.3)  | 3<br>(6.6) | 3<br>(6.6) | 4.64<br>(10.2) | 4.64<br>(10.2) | 4.64<br>(10.2) | 12<br>(26.4) | 12<br>(26.4) | 15<br>(33) | 15<br>(33) | 34<br>(74.8) | 35<br>(77) | 16<br>(35.2) | 35<br>(77) | 45<br>(99) |
| with built-in cable clamps                 | kg<br>(lbs.) | 1.75<br>(3.85) | 1.75<br>(3.85) | -          | -          | -              | -              | -              | -            | -            | -          | -          | -            | -          | -            | -          | -          |

**Table 46 - Short-circuit Current Ratings**

| 100/104-E, 100S-E  |                           | 116                           | 146                            | 190 | 205 | 265 | 305 | 370 | 400 | 460  | 580  | 750  | 860  | 1060 | 1260 | 2050 | 2650 |   |
|--|---------------------------|-------------------------------|--------------------------------|-----|-----|-----|-----|-----|-----|------|------|------|------|------|------|------|------|---|
| <b>Short Circuit Coordination (Max. Fuse or Circuit Breaker Rating) Per IEC 60947-4-1</b>  |                           |                               |                                |     |     |     |     |     |     |      |      |      |      |      |      |      |      |   |
| DIN Fuses -<br>gG  | Type "2" (400V)           | [A]                           | 100 kA Available Fault Current |     |     |     |     |     |     |      |      |      |      |      |      |      |      |   |
|  |                           |                               | 250                            | 250 | 315 | 315 | 400 | 500 | 630 | 630  | 630  | 800  | 800  | 1000 | 1250 | -    | -    | - |
| MCCB   | Type "2" (690V)           | [A]                           | 80 kA Available Fault Current  |     |     |     |     |     |     |      |      |      |      |      |      |      |      |   |
|  |                           |                               | 160                            | 200 | 315 | 315 | 400 | 425 | 500 | 500  | 630  | 800  | 800  | 1000 | 1600 | -    | -    | - |
| MCCB   | Type "2" (400V)           | [A]                           | 70 kA Available Fault Current  |     |     |     |     |     |     |      |      |      |      |      |      |      |      |   |
|  |                           |                               | 160                            | 160 | 320 | 320 | 400 | 630 | 630 | 630  | 630  | 800  | 1000 | 1600 | 1600 | -    | -    | - |
| <b>Short Circuit Current Rating (Max. Fuse or Circuit Breaker Rating) Per UL 60947 and CSA 22.2 No. 14 (contactor and fuses or circuit breaker only)</b> |                           |                               |                                |     |     |     |     |     |     |      |      |      |      |      |      |      |      |   |
| UL Class<br>RK5 Fuses  | Type 1 Combination (600V) | [A]                           | 10 kA Available Fault Current  |     |     |     |     |     |     |      |      |      |      |      |      |      |      |   |
|  |                           |                               | 250                            | 250 | 400 | 400 | -   | -   | -   | -    | -    | -    | -    | -    | -    | -    | -    | - |
| UL Class L<br>Fuses  | Type 1 Combination (600V) | [A]                           | 18 kA Available Fault Current  |     |     |     |     |     |     |      |      |      |      |      |      |      |      |   |
|  |                           |                               | -                              | -   | -   | -   | 800 | 800 | 800 | 1000 | -    | -    | -    | -    | -    | -    | -    | - |
|  | Type 1 Combination (600V) | [A]                           | 30 kA Available Fault Current  |     |     |     |     |     |     |      |      |      |      |      |      |      |      |   |
|  |                           |                               | -                              | -   | -   | -   | -   | -   | -   | 1000 | -    | -    | -    | -    | -    | -    | -    | - |
| UL Class J<br>and CSA<br>HRCl-J<br>Fuses   | Type 1 Combination (600V) | [A]                           | 85 kA Available Fault Current  |     |     |     |     |     |     |      |      |      |      |      |      |      |      |   |
|  |                           |                               | -                              | -   | -   | -   | -   | -   | -   | -    | -    | -    | 1600 | 2000 | -    | -    | -    |   |
| UL Class J<br>and CSA<br>HRCl-J<br>Fuses   | Type 1 Combination (600V) | [A]                           | 100 kA Available Fault Current |     |     |     |     |     |     |      |      |      |      |      |      |      |      |   |
|  |                           |                               | 250                            | 250 | 400 | 400 | 600 | 600 | 600 | 600  | 600  | -    | -    | -    | -    | -    | -    | - |
| UL Class L<br>Fuses  | Type 2 Combination (600V) | [A]                           | 100 kA Available Fault Current |     |     |     |     |     |     |      |      |      |      |      |      |      |      |   |
|  |                           |                               | 200                            | 200 | 400 | 400 | 600 | 600 | 600 | 600  | 600  | -    | -    | -    | -    | -    | -    | - |
| UL Class L<br>Fuses  | Type 1 Combination (600V) | [A]                           | 42 kA Available Fault Current  |     |     |     |     |     |     |      |      |      |      |      |      |      |      |   |
|  |                           |                               | -                              | -   | -   | -   | -   | -   | 800 | 800  | 1200 | 1200 | -    | -    | 1600 | -    | -    |   |
| UL Class L<br>Fuses  | Type 2 Combination (600V) | [A]                           | 65 kA Available Fault Current  |     |     |     |     |     |     |      |      |      |      |      |      |      |      |   |
|  |                           |                               | -                              | -   | -   | -   | -   | -   | -   | -    | 1200 | 1200 | -    | -    | -    | -    | -    |   |
| UL Inverse-<br>Time<br>Circuit<br>Breaker  | Type 1 Combination (480V) | [A]                           | 84 kA Available Fault Current  |     |     |     |     |     |     |      |      |      |      |      |      |      |      |   |
|  |                           |                               | -                              | -   | -   | -   | -   | -   | 800 | 800  | -    | -    | -    | -    | -    | -    | -    |   |
|  | Type 2 Combination (480V) | [A]                           | 89 kA Available Fault Current  |     |     |     |     |     |     |      |      |      |      |      |      |      |      |   |
|  |                           |                               | 250                            | 250 | 400 | 400 | 800 | 800 | 800 | 800  | 800  | 800  | 800  | -    | -    | -    | -    | - |
|  | Type 1 Combination (480V) | [A]                           | 100 kA Available Fault Current |     |     |     |     |     |     |      |      |      |      |      |      |      |      |   |
|  |                           |                               | -                              | -   | -   | -   | -   | -   | -   | -    | 800  | 800  | -    | -    | -    | -    | -    |   |
|  | Type 1 Combination (480V) | [A]                           | 25 kA Available Fault Current  |     |     |     |     |     |     |      |      |      |      |      |      |      |      |   |
|  |                           |                               | 250                            | 250 | -   | -   | -   | -   | -   | -    | -    | -    | -    | -    | -    | -    | -    | - |
|  | Type 2 Combination (600V) | [A]                           | 35 kA Available Fault Current  |     |     |     |     |     |     |      |      |      |      |      |      |      |      |   |
|  |                           |                               | -                              | -   | 400 | 400 | 800 | 800 | 800 | 800  | 800  | 800  | 800  | -    | -    | -    | -    | - |
|  | Type 1 Combination (600V) | [A]                           | 42 kA Available Fault Current  |     |     |     |     |     |     |      |      |      |      |      |      |      |      |   |
|  |                           |                               | -                              | -   | -   | -   | 800 | 800 | 800 | 800  | 800  | 800  | 800  | -    | -    | -    | -    | - |
|  | Type 1 Combination (600V) | [A]                           | 50 kA Available Fault Current  |     |     |     |     |     |     |      |      |      |      |      |      |      |      |   |
|  |                           |                               | 250                            | 250 | -   | -   | -   | -   | -   | -    | -    | -    | -    | -    | -    | -    | -    | - |
| Type 1 Combination (600V)  | [A]                       | 65 kA Available Fault Current |                                |     |     |     |     |     |     |      |      |      |      |      |      |      |      |   |
|  |                           | -                             | -                              | 400 | 400 | 400 | 400 | 400 | -   | -    | -    | -    | -    | -    | -    | -    | -    |   |

Table 47 - Coil Data

| 100/104-E, 100S-E       |               |             | 116            | 146     | 190     | 205      | 265      | 305     | 370      | 400     | 460 | 580 | 750 | 860 | 1060 | 1260 | 2050 | 2650 |   |
|-------------------------|---------------|-------------|----------------|---------|---------|----------|----------|---------|----------|---------|-----|-----|-----|-----|------|------|------|------|---|
| <b>Operating Limits</b> |               |             |                |         |         |          |          |         |          |         |     |     |     |     |      |      |      |      |   |
| 50/60 Hz                | pick-up       | [ $x U_s$ ] | 0.85...1.1     |         |         |          |          |         |          |         |     |     |     |     |      |      |      |      |   |
|                         | dropout       | [ $x U_s$ ] | 0.55           |         |         |          |          |         |          |         |     |     |     |     |      |      |      |      |   |
| DC control              | pick-up       | [ $x U_s$ ] | 0.80...1.1     |         |         |          |          |         |          |         |     |     |     |     |      |      |      |      |   |
|                         | dropout       | [ $x U_s$ ] | 0.55           |         |         |          |          |         |          |         |     |     |     |     |      |      |      |      |   |
| 24...60V AC             | pick-up       | [VA]        | 225            | 165     | 475     | —        | —        | —       | —        | —       | —   | —   | —   | —   | —    | —    | —    | —    | — |
|                         | hold-in       | [VA]        | 5.5            | 6       | 8.5     | —        | —        | —       | —        | —       | —   | —   | —   | —   | —    | —    | —    | —    | — |
| 48...130V AC            | pick-up       | [VA]        | 170            | 175     | 340     | 1215     | 1100     | —       | 1100     | —       | —   | —   | —   | —   | —    | —    | —    | —    | — |
|                         | hold-in       | [VA]        | 4              | 4       | 17      | 12       | 12       | —       | 12       | —       | —   | —   | —   | —   | —    | —    | —    | —    | — |
| 100...250V AC           | pick-up       | [VA]        | 130            | 220     | 385     | 955      | 880      | 2450    | 880      | 2450    | —   | —   | —   | —   | —    | —    | —    | —    | — |
|                         | hold-in       | [VA]        | 6              | 7       | 17.5    | 12       | 12       | 48      | 12       | 48      | —   | —   | —   | —   | —    | —    | —    | —    | — |
| 250...500V AC           | pick-up       | [VA]        | 205            | 185     | 420     | 950      | 985      | —       | 985      | —       | —   | —   | —   | —   | —    | —    | —    | —    | — |
|                         | hold-in       | [VA]        | 16             | 16      | 21      | 12       | 12       | —       | 12       | —       | —   | —   | —   | —   | —    | —    | —    | —    | — |
| 24...60V DC             | pick-up       | [W]         | 210            | 205     | 400     | 900      | 785      | —       | 785      | —       | —   | —   | —   | —   | —    | —    | —    | —    | — |
|                         | hold-in       | [W]         | 2.5            | 2.5     | 3.5     | 5        | 5.5      | —       | 5.5      | —       | —   | —   | —   | —   | —    | —    | —    | —    | — |
| 48...130V DC            | pick-up       | [W]         | 130            | 130     | 360     | 1150     | 1020     | —       | 1020     | —       | —   | —   | —   | —   | —    | —    | —    | —    | — |
|                         | hold-in       | [W]         | 2.5            | 2.5     | 2.5     | 5        | 5        | —       | 5        | —       | —   | —   | —   | —   | —    | —    | —    | —    | — |
| 100...250V DC           | pick-up       | [W]         | 135            | 190     | 410     | 895      | 880      | 2290    | 880      | 2290    | —   | —   | —   | —   | —    | —    | —    | —    | — |
|                         | hold-in       | [W]         | 3              | 2.5     | 4.5     | 5        | 5        | 20.5    | 5        | 20.5    | —   | —   | —   | —   | —    | —    | —    | —    | — |
| 250...500V DC           | pick-up       | [W]         | 205            | 190     | 600     | 885      | 910      | —       | 910      | —       | —   | —   | —   | —   | —    | —    | —    | —    | — |
|                         | hold-in       | [W]         | 4              | 4       | 4.7     | 7.5      | 7.5      | —       | 7.5      | —       | —   | —   | —   | —   | —    | —    | —    | —    | — |
| PLC Interface           |               |             | 10 mA @ 24V DC |         |         |          |          |         |          |         |     |     |     |     |      |      |      |      |   |
| <b>Operating Times</b>  |               |             |                |         |         |          |          |         |          |         |     |     |     |     |      |      |      |      |   |
| AC or DC                | closing delay | [ms]        | 20...55        | 25...60 | 30...60 | 50...120 | 50...120 | 50...80 | 50...120 | 50...80 | —   | —   | —   | —   | —    | —    | —    | —    | — |
|                         | opening delay | [ms]        | 40...70        | 45...80 | 45...80 | 33...70  | 33...70  | 35...55 | 33...70  | 35...55 | —   | —   | —   | —   | —    | —    | —    | —    | — |
| With PLC Interface      | closing delay | [ms]        | 20...31        | 25...45 | 25...45 | 40...60  | 40...90  | 40...65 | 40...90  | 40...65 | —   | —   | —   | —   | —    | —    | —    | —    | — |
|                         | opening delay | [ms]        | 24...34        | 25...45 | 25...45 | 10...30  | 10...30  | 10...30 | 10...30  | 10...30 | —   | —   | —   | —   | —    | —    | —    | —    | — |

# Conductors

**Table 48 - Cross Sections, Screw Type Terminals**

| 100/104-E, 100S/104S-E   |              |                    | 9          | 12         | 16         | 26         | 30         | 38         | 40         | 52         | 65         | 80         | 96         |
|--|--------------|--------------------|------------|------------|------------|------------|------------|------------|------------|------------|------------|------------|------------|
| Conductor Cross Sections—Main Contacts Terminal Type               |              |                    | (1)        |            |            |            |            |            | (2)        |            |            | (3)        |            |
|  | 1 conductor  | [mm <sup>2</sup> ] | 0.75...6   | 0.75...6   | 0.75...6   | 1.5...10   | 1.5...10   | 1.5...10   | 4...35     | 4...35     | 4...35     | 6...50     | 6...50     |
|  | 2 conductors | [mm <sup>2</sup> ] | 0.75...6   | 0.75...6   | 0.75...6   | 1.5...10   | 1.5...10   | 1.5...10   | 4...35     | 4...35     | 4...35     | 6...50     | 6...50     |
|  | 1 conductor  | [mm <sup>2</sup> ] | 1...6      | 1...6      | 1...6      | 2.5...10   | 2.5...10   | 2.5...10   | 6...35     | 6...35     | 6...35     | 6...70     | 6...70     |
|  | 2 conductors | [mm <sup>2</sup> ] | 1...6      | 1...6      | 1...6      | 2.5...10   | 2.5...10   | 2.5...10   | 6...35     | 6...35     | 6...35     | 6...50     | 6...50     |
| Recommended torque   |              | [N·m]              | 1.5        | 1.5        | 1.5        | 2.5        | 2.5        | 2.5        | 4          | 4          | 4          | 6          | 6          |
| Cross Section per UL/CSA   |              | [AWG]              | 16...10    | 16...10    | 16...10    | 14...8     | 14...8     | 14...8     | 10...2     | 10...2     | 10...2     | 6...1      | 6...1      |
| Recommended torque   |              | [lb·in]            | 13         | 13         | 13         | 22         | 22         | 22         | 35         | 35         | 35         | 53         | 53         |
| Conductor Cross Sections- Coil and Auxiliary Contact Terminal Type |              |                    | (1)        |            |            |            |            |            |            |            |            |            |            |
|  | 1 conductor  | [mm <sup>2</sup> ] | 0.75...2.5 | 0.75...2.5 | 0.75...2.5 | 0.75...2.5 | 0.75...2.5 | 0.75...2.5 | 0.75...2.5 | 0.75...2.5 | 0.75...2.5 | 0.75...2.5 | 0.75...2.5 |
|  | 2 conductors | [mm <sup>2</sup> ] | 0.75...2.5 | 0.75...2.5 | 0.75...2.5 | 0.75...2.5 | 0.75...2.5 | 0.75...2.5 | 0.75...2.5 | 0.75...2.5 | 0.75...2.5 | 0.75...2.5 | 0.75...2.5 |
|  | 1 conductor  | [mm <sup>2</sup> ] | 1...2.5    | 1...2.5    | 1...2.5    | 1...2.5    | 1...2.5    | 1...2.5    | 1...2.5    | 1...2.5    | 1...2.5    | 1...2.5    | 1...2.5    |
|  | 2 conductors | [mm <sup>2</sup> ] | 1...2.5    | 1...2.5    | 1...2.5    | 1...2.5    | 1...2.5    | 1...2.5    | 1...2.5    | 1...2.5    | 1...2.5    | 1...2.5    | 1...2.5    |
| Recommended torque   |              | [N·m]              | 1.2        | 1.2        | 1.2        | 1.2        | 1.2        | 1.2        | 1.2        | 1.2        | 1.2        | 1.2        | 1.2        |
| Cross Section per UL/CSA   |              | [AWG]              | 18...14    | 18...14    | 18...14    | 18...14    | 18...14    | 18...14    | 18...14    | 18...14    | 18...14    | 18...14    | 18...14    |
| Recommended torque   |              | [lb·in]            | 11         | 11         | 11         | 11         | 11         | 11         | 11         | 11         | 11         | 11         | 11         |

- (1) Pozidriv No. 2 / Blade No. 3 screw.
- (2) Pozidriv No. 2 / Blade No. 4 screw.
- (3) Hexagonal socket screw.

**Table 49 - Cross Sections, Screw Type Terminals**

| 100/104-E, 100S-E   |                |                    | 116        | 146        | 190         | 205        | 265        | 305        | 370         | 400         | 460         | 580 | 750 | 860          | 1060 | 1260 | 2050 | 2650 |
|---|----------------|--------------------|------------|------------|-------------|------------|------------|------------|-------------|-------------|-------------|-----|-----|--------------|------|------|------|------|
| <b>Main Terminals</b>   |                |                    |            |            |             |            |            |            |             |             |             |     |     |              |      |      |      |      |
| <b>Conductor Cross Sections – Main Contacts (Terminal type)</b> |                |                    |            |            |             |            |            |            |             |             |             |     |     |              |      |      |      |      |
|   | (1) conductor  | [mm <sup>2</sup> ] | 10...95    | 10...150   | 16...185    | —          | —          | —          | —           | —           | —           | —   | —   | —            | —    | —    | —    | —    |
|   | Clamp Type     |                    | 100-ECL146 | 100-ETL205 | 100-ETL370  | —          | —          | —          | —           | —           | —           | —   | —   | —            | —    | —    | —    | —    |
| Recommended torque  |                | [N·m]              | 8          | 34         | 42          | —          | —          | —          | —           | —           | —           | —   | —   | —            | —    | —    | —    | —    |
|   | (2) conductors | [mm <sup>2</sup> ] | 10...95    | —          | 16...500    | 70...240   | 70...240   | 120...240  | 70...300    | —           | —           | —   | —   | —            | —    | —    | —    | —    |
|   | Clamp Type     |                    | 100-ECL146 | —          | 100-ETL370B | 100-ETL580 | 100-ETL750 | 100-ETL860 | 100-ETL1060 | —           | —           | —   | —   | —            | —    | —    | —    | —    |
| Recommended torque  |                | [N·m]              | 8          | —          | 42          | 31         | 43         | 43         | 57          | —           | —           | —   | —   | —            | —    | —    | —    | —    |
|   | (3) conductors | [mm <sup>2</sup> ] | —          | —          | —           | —          | —          | 70...500   | 120...500   | 70...750    | 70...240    | —   | —   | —            | —    | —    | —    | —    |
|   | Clamp Type     |                    | —          | —          | —           | —          | —          | 100-ETL750 | 100-ETL860  | 100-ETL1060 | 100-ETL750  | —   | —   | —            | —    | —    | —    | —    |
| Recommended torque  |                | [N·m]              | —          | —          | —           | —          | —          | 43         | 43          | 57          | 43          | —   | —   | —            | —    | —    | —    | —    |
|   | (4) conductors | [mm <sup>2</sup> ] | —          | —          | —           | —          | —          | —          | —           | 120...500   | 70...750    | —   | —   | —            | —    | —    | —    | —    |
|   | Clamp Type     |                    | —          | —          | —           | —          | —          | —          | —           | 100-ETL860  | 100-ETL1060 | —   | —   | —            | —    | —    | —    | —    |
| Recommended torque  |                | [N·m]              | —          | —          | —           | —          | —          | —          | —           | 43          | 57          | —   | —   | —            | —    | —    | —    | —    |
|   | (6) conductors | [mm <sup>2</sup> ] | —          | —          | —           | —          | —          | —          | —           | —           | —           | —   | —   | 70...750     | —    | —    | —    | —    |
|   | Clamp Type     |                    | —          | —          | —           | —          | —          | —          | —           | —           | —           | —   | —   | 100-ETL1060B | —    | —    | —    | —    |
| Recommended torque  |                | [N·m]              | —          | —          | —           | —          | —          | —          | —           | —           | —           | —   | —   | 57           | —    | —    | —    | —    |



**Table 49 - Cross Sections, Screw Type Terminals (Continued)**

| 100/104-E, 100S-E  |                                   | 116        | 146                    | 190                    | 205                      | 265                      | 305                      | 370                      | 400                      | 460   | 580   | 750   | 860   | 1060  | 1260  | 2050  | 2650  |  |
|--|-----------------------------------|------------|------------------------|------------------------|--------------------------|--------------------------|--------------------------|--------------------------|--------------------------|-------|-------|-------|-------|-------|-------|-------|-------|--|
|  | L max. [mm]                       | 22         | 24                     | 32                     | 47                       | 50                       | 100                      | 50                       | 100                      | 50    | 100   | 50    | 100   | 50    | 100   | 50    | 100   |  |
|  | Ø min. [mm]                       | 6          | 8                      | 10                     | 10                       | 12                       | 12                       | 12                       | 12                       | 12    | 12    | 12    | 12    | 12    | 12    | 12    | 12    |  |
| Recommended torque [N•m]   |                                   | 9          | 18                     | 28                     | 35                       | 45                       | 45                       | 45                       | 45                       | 45    | 45    | 45    | 45    | 45    | 45    | 45    | 45    |  |
| <b>Cross section per UL/CSA</b>  |                                   |            |                        |                        |                          |                          |                          |                          |                          |       |       |       |       |       |       |       |       |  |
|  | (1) conductor [AWG]               | 6...3/0    | 6...300 <sup>(1)</sup> | 4...400 <sup>(1)</sup> | —                        | —                        | —                        | —                        | —                        | —     | —     | —     | —     | —     | —     | —     | —     |  |
|  | Clamp Type                        | 100-ECL146 | 100-ETL205             | 100-ETL370             | —                        | —                        | —                        | —                        | —                        | —     | —     | —     | —     | —     | —     | —     | —     |  |
| Recommended torque [lb•in]   |                                   | 80         | 300                    | 375                    | —                        | —                        | —                        | —                        | —                        | —     | —     | —     | —     | —     | —     | —     | —     |  |
|  | (2) conductors [AWG]              | 6...3/0    | —                      | 4...500 <sup>(1)</sup> | 2/0...500 <sup>(1)</sup> | 2/0...500 <sup>(1)</sup> | 4/0...500 <sup>(1)</sup> | 1/0...750 <sup>(1)</sup> | 2/0...500 <sup>(1)</sup> | —     | —     | —     | —     | —     | —     | —     | —     |  |
|  | Clamp Type                        | 100-ECL146 | —                      | 100-ETL370B            | 100-ETL580               | 100-ETL750               | 100-ETL860               | 100-ETL1060              | 100-ETL750               | —     | —     | —     | —     | —     | —     | —     | —     |  |
| Recommended torque [lb•in]   |                                   | 80         | —                      | 375                    | 275                      | 375                      | 375                      | 500                      | 375                      | —     | —     | —     | —     | —     | —     | —     | —     |  |
|  | (3) conductors [AWG]              | —          | —                      | —                      | —                        | 2/0...500 <sup>(1)</sup> | 4/0...500 <sup>(1)</sup> | 1/0...750 <sup>(1)</sup> | 2/0...500 <sup>(1)</sup> | —     | —     | —     | —     | —     | —     | —     | —     |  |
|  | Clamp Type                        | —          | —                      | —                      | —                        | 100-ETL750               | 100-ETL860               | 100-ETL1060              | 100-ETL750               | —     | —     | —     | —     | —     | —     | —     | —     |  |
| Recommended torque [lb•in]   |                                   | —          | —                      | —                      | —                        | 375                      | 375                      | 500                      | 375                      | —     | —     | —     | —     | —     | —     | —     | —     |  |
|  | (4) conductors [AWG]              | —          | —                      | —                      | —                        | —                        | 4/0...500 <sup>(1)</sup> | 1/0...750 <sup>(1)</sup> | —                        | —     | —     | —     | —     | —     | —     | —     | —     |  |
|  | Clamp Type                        | —          | —                      | —                      | —                        | —                        | 100-ETL860               | 100-ETL1060              | —                        | —     | —     | —     | —     | —     | —     | —     | —     |  |
| Recommended torque [lb•in]   |                                   | —          | —                      | —                      | —                        | —                        | 375                      | 500                      | —                        | —     | —     | —     | —     | —     | —     | —     | —     |  |
|  | (6) conductors [AWG]              | —          | —                      | —                      | —                        | —                        | —                        | 1/0...750 <sup>(1)</sup> | —                        | —     | —     | —     | —     | —     | —     | —     | —     |  |
|  | Clamp Type                        | —          | —                      | —                      | —                        | —                        | —                        | 100-ETL1060B             | —                        | —     | —     | —     | —     | —     | —     | —     | —     |  |
| Recommended torque [lb•in]   |                                   | —          | —                      | —                      | —                        | —                        | —                        | 500                      | —                        | —     | —     | —     | —     | —     | —     | —     | —     |  |
|  | L max. [in]                       | 0.866      | 0.945                  | 1.26                   | 1.85                     | 1.97                     | 3.94                     | 1.97                     | 3.94                     | 1.97  | 3.94  | 1.97  | 3.94  | 1.97  | 3.94  | 1.97  | 3.94  |  |
|  | Ø min. [in]                       | 0.236      | 0.315                  | 0.394                  | 0.394                    | 0.472                    | 0.472                    | 0.472                    | 0.472                    | 0.472 | 0.472 | 0.472 | 0.472 | 0.472 | 0.472 | 0.472 | 0.472 |  |
| Recommended torque [lb•in]   |                                   | 80         | 160                    | 248                    | 310                      | 398                      | 398                      | 398                      | 398                      | 398   | 398   | 398   | 398   | 398   | 398   | 398   | 398   |  |
| <b>Conductor Cross Sections – Coil and Auxiliary Contact Terminals (Terminal Type)</b> |                                   |            |                        |                        |                          |                          |                          |                          |                          |       |       |       |       |       |       |       |       |  |
|  | (1) conductor [mm <sup>2</sup> ]  | 0.75...2.5 |                        |                        |                          |                          |                          |                          |                          |       |       |       |       |       |       |       |       |  |
|  | (2) conductors [mm <sup>2</sup> ] | 0.75...2.5 |                        |                        |                          |                          |                          |                          |                          |       |       |       |       |       |       |       |       |  |
|  | (1) conductor [mm <sup>2</sup> ]  | 1...4      |                        |                        |                          |                          |                          |                          |                          |       |       |       |       |       |       |       |       |  |
|  | (2) conductors [mm <sup>2</sup> ] | 1...4      |                        |                        |                          |                          |                          |                          |                          |       |       |       |       |       |       |       |       |  |
| Recommended torque [N•m]   |                                   | 1...12     |                        |                        |                          |                          |                          |                          |                          |       |       |       |       |       |       |       |       |  |
| Cross section per UL/CSA [AWG]   |                                   | 18...14    |                        |                        |                          |                          |                          |                          |                          |       |       |       |       |       |       |       |       |  |
| Recommended torque [lb•in]   |                                   | 8.9...10.6 |                        |                        |                          |                          |                          |                          |                          |       |       |       |       |       |       |       |       |  |

(1) MCM.

# Auxiliary Contacts

Table 50 - Auxiliary Contacts

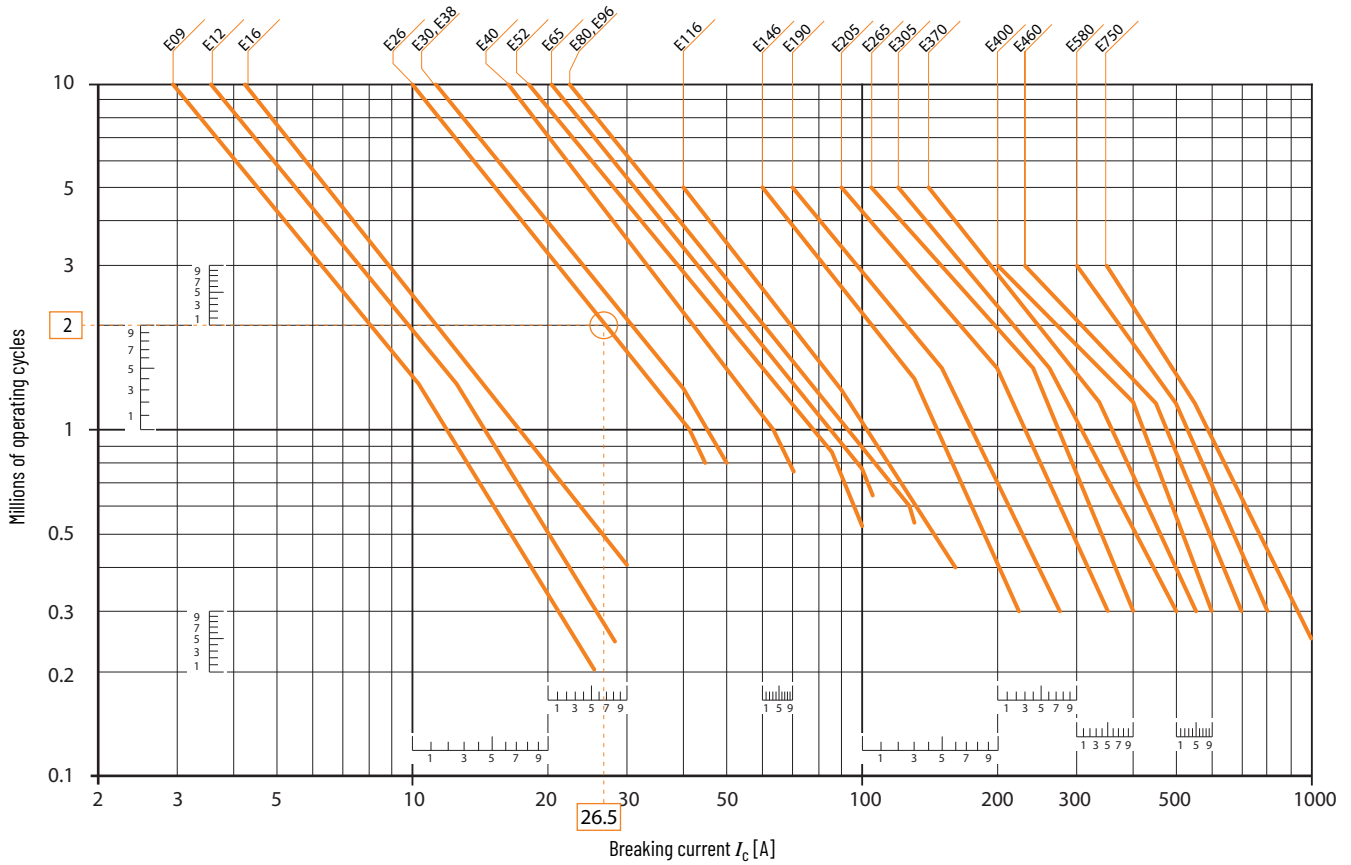
|  |   |     | Auxiliary contact for<br>100/100S/104-E09...E96 |                      |                           |                            | Auxiliary contact for<br>100/100S/104-E16...E2650 |            |                         |
|--|---|-----|---|----------------------|---------------------------|----------------------------|---|------------|-------------------------|
|  |   |     | Internal<br>100-E09...E16                       | 100-EF/ESA*/<br>ESB* | Low-power<br>100-ESA*B/B3 | Low-power<br>100-ESA*B2/B4 | 100-ES1/2*  | 100-ES3/4* | Low-power<br>100-ES*-B* |
| <b>Switching of AC Loads</b>   |   |     |   |                      |                           |                            |   |            |                         |
| Rated Insulation voltage $U_i$   |   |     | 690V  | 690V                 | 250V                      | 250V                       | 690V  | 690V       | 250V                    |
| Rated operational voltage $U_e$  |   |     | 690V  | 690V                 | 125V                      | 250V                       | 690V  | 690V       | 125V                    |
| Rated impulse withstand voltage $U_{imp}$                              |   |     | 6kV   | 6kV                  | —                         | —                          | 6kV   | 6kV        | 1.5kV                   |
| AC-12 $I_{th}$   | at 40 °C  | [A] | 16  | 16                   | 0.1                       | 2                          | 16  | 16         | 0.1                     |
|  | at 60 °C  | [A] | —   | —                    | —                         | —                          | —   | —          | —                       |
| AC-14 at rated voltage of  | 24V   | [A] | —   | —                    | 0.1                       | —                          | —   | —          | 0.1                     |
|  | 42/48V  | [A] | —   | —                    | 0.1                       | —                          | —   | —          | 0.1                     |
|  | 120V  | [A] | —   | —                    | 0.1                       | —                          | —   | —          | 0.1                     |
| AC-15 at rated voltage of  | 24V   | [A] | 6   | 6                    | —                         | 2                          | 6   | 6          | —                       |
|  | 42/48V  | [A] | 6   | 6                    | —                         | 2                          | 6   | 6          | —                       |
|  | 120V  | [A] | 6   | 6                    | —                         | 2                          | 6   | 6          | —                       |
|  | 230V  | [A] | 4   | 4                    | —                         | 2                          | 4   | 4          | —                       |
|  | 240V  | [A] | 4   | 4                    | —                         | 2                          | 4   | 4          | —                       |
|  | 400V  | [A] | 3   | 3                    | —                         | —                          | 3   | 3          | —                       |
|  | 415V  | [A] | 3   | 3                    | —                         | —                          | 3   | 3          | —                       |
| 500V   | [A]   | 2   | 2   | —                    | —                         | 2                          | 2   | —          |                         |
| 690V   | [A]   | 2   | 2   | —                    | —                         | 2                          | 2   | —          |                         |
| <b>Switching of DC Loads</b>   |   |     |   |                      |                           |                            |   |            |                         |
| DC-12 L/R < 1 ms resistive loads at                                    | 24V DC  | [A] | —   | —                    | 0.1                       | 2                          | —   | —          | 0.1                     |
|  | 48V DC  | [A] | —   | —                    | 0.1                       | 1                          | —   | —          | 0.1                     |
|  | 110V DC   | [A] | —   | —                    | 0.1                       | 0.2                        | —   | —          | 0.1                     |
|  | 220V DC   | [A] | —   | —                    | —                         | 0.1                        | —   | —          | —                       |
|  | 440V DC   | [A] | —   | —                    | —                         | —                          | —   | —          | —                       |
| DC-14 L/R < 15 ms inductive loads with economy resistor in series at   | 24V DC  | [A] | —   | —                    | —                         | —                          | —   | —          | —                       |
|  | 48V DC  | [A] | —   | —                    | —                         | —                          | —   | —          | —                       |
|  | 110V DC   | [A] | —   | —                    | —                         | —                          | —   | —          | —                       |
|  | 220V DC   | [A] | —   | —                    | —                         | —                          | —   | —          | —                       |
|  | 440V DC   | [A] | —   | —                    | —                         | —                          | —   | —          | —                       |
| DC-13 switching electromagnets at                                      | 24V DC  | [A] | 6   | 6                    | —                         | —                          | 3   | 6          | —                       |
|  | 48V DC  | [A] | 2.8   | 2.8                  | —                         | —                          | 1.5   | 2.8        | —                       |
|  | 110V DC   | [A] | 0.55  | 0.55                 | —                         | —                          | 0.55  | 0.55       | —                       |
|  | 220V DC   | [A] | 0.27  | 0.27                 | —                         | —                          | 0.3   | 0.3        | —                       |
|  | 440V DC   | [A] | 0.13  | 0.13                 | —                         | —                          | —   | —          | —                       |
| <b>Fuse gG</b>   |   |     |   |                      |                           |                            |   |            |                         |
| Short-circuit protection with no welding of contacts per IEC 60947-5-2 |  | [A] | 10  | 10                   | 0.1                       | 10                         | 10  | 10         | 0.1                     |
|  |  | [A] | 10  | 10                   | 0.1                       | 10                         | 10  | 10         | 0.1                     |
| Protective Separation per IEC 60947-1, Annex N                         |   |     |   |                      |                           |                            |   |            |                         |
| Min. switching capacity at 12V IEC 60947-5-4                           | [mA]  | 3   | 3   | —                    | —                         | 50                         | 50  | —          |                         |
| Min. switching capacity at 3V IEC 60947-5-4                            | [mA]  | —   | —   | —                    | 1                         | —                          | —   | 1          |                         |
| <b>Load Carrying Capacity per UL/CSA</b>                               |   |     |   |                      |                           |                            |   |            |                         |
| Rated voltage  | AC  | [V] | 600   | 600                  | 125                       | 250                        | 600   | 600        | 125                     |
| Continuous rating  | 40 °C   | [A] | 10  | 10                   | 0.1                       | 2                          | 10  | 10         | 0.1                     |
| Switching capacity   | AC  |     | A600  | A 600                | —                         | —                          | A 600   | A 600      | —                       |
| Rated voltage  | DC  | [V] | 600   | 600                  | 110                       | 220                        | 250   | 250        | 125                     |
| Continuous rating  | 40 °C   | [A] | 2.5   | 2.5                  | 0.1                       | 0.1                        | 2.5   | 2.5        | 0.1                     |
| Switching capacity   | DC  |     | Q600  | Q 600                | —                         | —                          | P 600   | Q 300      | —                       |

# Life-Load Curves

## 3-pole Contactors – Electrical Durability

Figure 26 - Electrical durability for AC-1 utilization category -  $U_e \leq 690V$

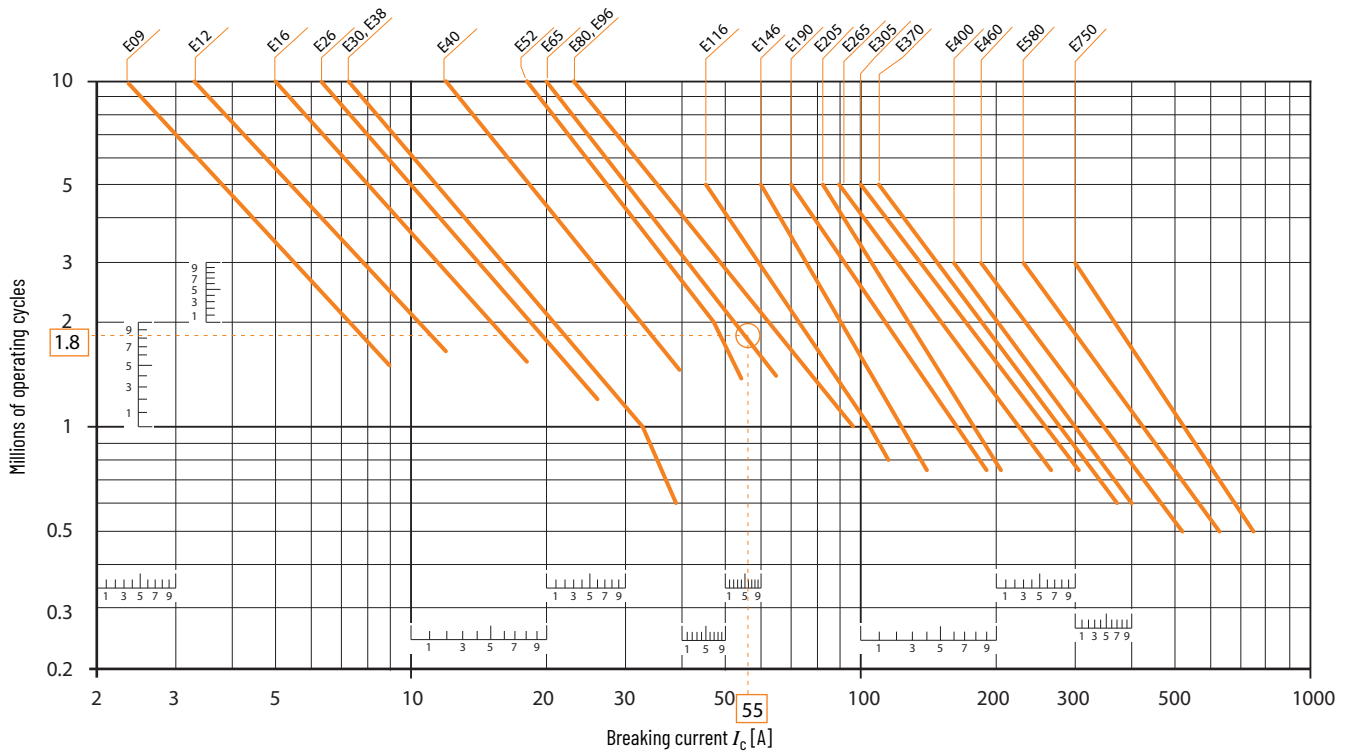
Switching non-inductive or slightly inductive loads. The breaking current  $I_C$  for AC-1 is equal to the rated operational current of the load.



**Cat. Nos. 100-E860, -E1060:** The electrical durability at the rated current is 50,000 operating cycles.

**Figure 27 - Electrical durability for AC-3 utilization category -  $U_e \leq 440V$**

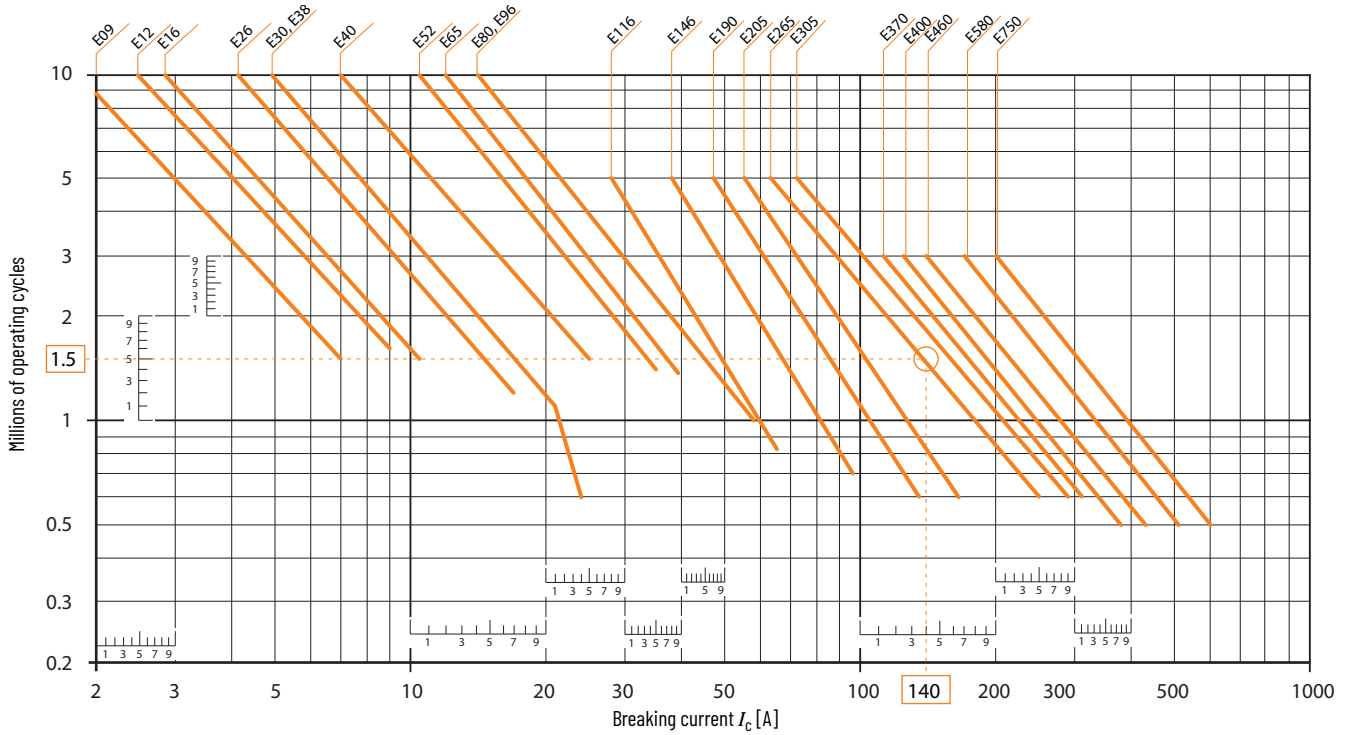
Switching cage motors: starting and switching off running motors. The breaking current  $I_c$  for AC-3 is equal to the rated operational current  $I_e$  ( $I_e$  = motor full load current).



**Cat. Nos. 100-E860, -E1060:** The electrical durability at the rated current is 50,000 operating cycles.

**Figure 28 - Electrical durability for AC-3 utilization category -  $440V < U_e \leq 690V$**

Switching cage motors: starting and switching off running motors. The breaking current  $I_c$  for AC-3 is equal to the rated operational current  $I_e$  ( $I_e$  = motor full load current).

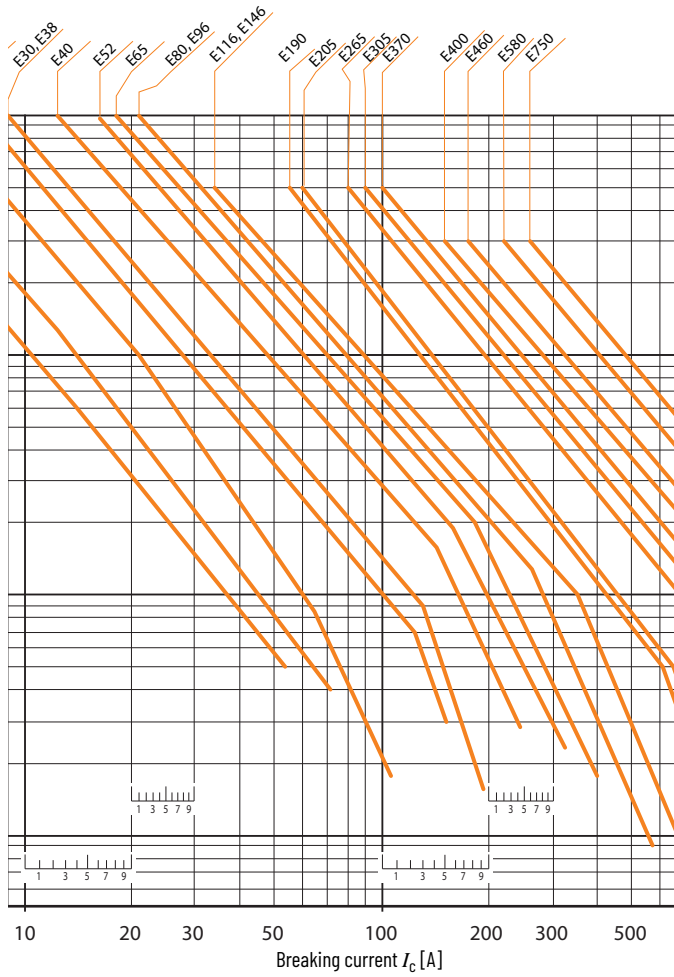


**Cat. Nos. 100-E860, -E1060:** The electrical durability at the rated current is 50,000 operating cycles.



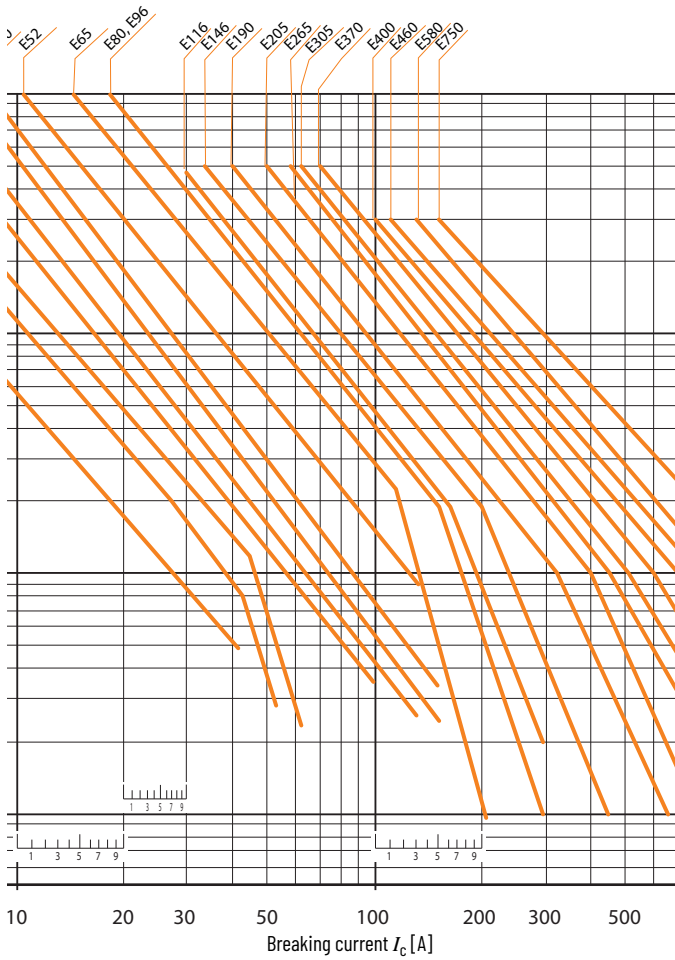
**Figure 29 - Electrical durability for AC-2 or AC-4 utilization category -  $U_e \leq 440V$**

Switching cage motors: starting, reverse operation and step-by-step operation. The breaking current  $I_c$  is equal to  $2.5 \times I_e$  for AC-2 and  $6 \times I_e$  for AC-4, keeping in mind that  $I_e$  is the motor rated operational current ( $I_e$  = motor full-load current).



**Figure 30 - Electrical durability for AC-2 or AC-4 utilization category -  $440V < U_e \leq 690V$**

Switching cage motors: starting, reverse operation and step-by-step operation. The breaking current  $I_c$  is equal to  $2.5 \times I_e$  for AC-2 and  $6 \times I_e$  for AC-4, keeping in mind that  $I_e$  is the motor rated operational current ( $I_e$  = motor full load current).

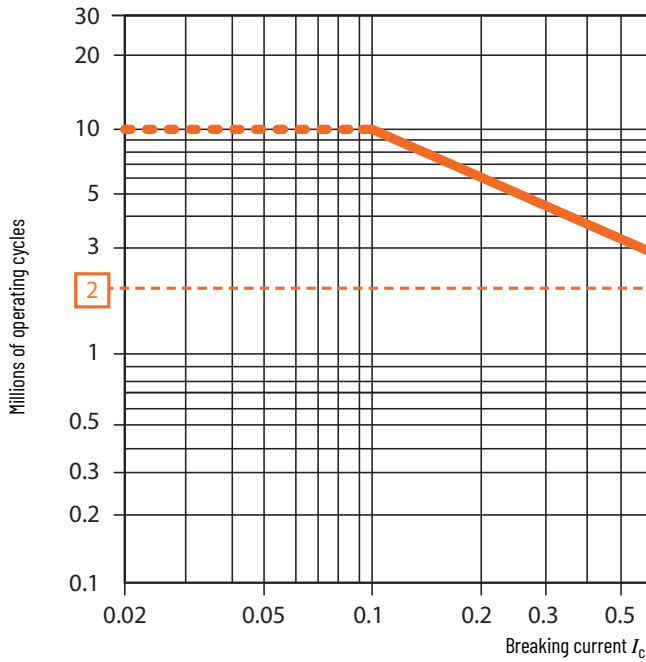


## Auxiliary Contacts for 100-E09...E96 Contactors—Electrical Durability

**Figure 31 - Electrical durability for AC-15 utilization category -  $U_e \leq 690V$ , 40...60 Hz**

Switching of resistive or inductive loads according to IEC/EN/UL 60947-5-1

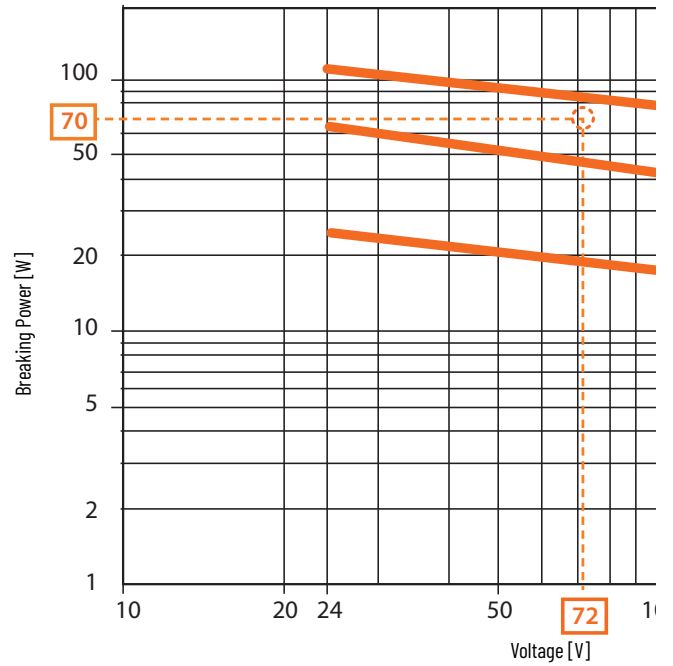
- Making current:  $10 \times I_e$  with  $\cos \phi - 0.7$
- Breaking current:  $I_e$  with  $\cos \phi - 0.4$



**Figure 32 - Electrical durability for DC-13 utilization category -  $U_e \leq 250V$**

Switching of inductive loads according to IEC/EN/UL 60947-5-1

- Making and breaking current:  $I_e$  at  $U_e$

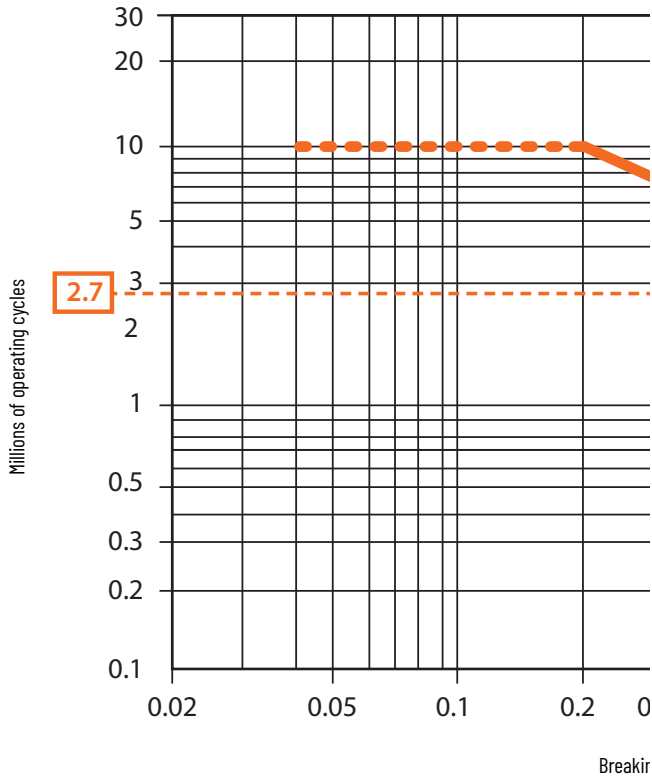


## Auxiliary Contacts for 100-E116...E2650 Contactors—Electrical Durability

Figure 33 - Electrical durability for AC-15 utilization category -  $U_e \leq 690V, 40...60\text{ Hz}$

Switching of resistive or inductive loads according to IEC/EN/UL 60947-5-1

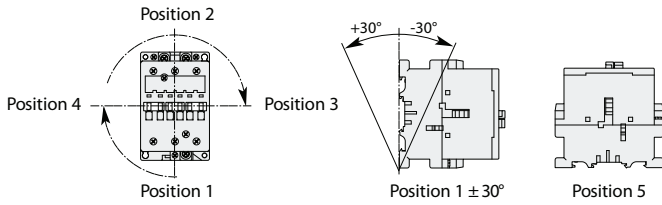
- Making current:  $10 \times I_e$  with  $\cos \phi - 0.7$
- Breaking current:  $I_e$  with  $\cos \phi - 0.4$



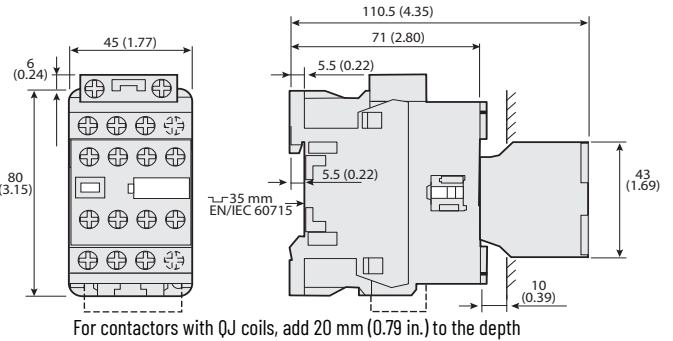
# Approximate Dimensions

Dimensions are shown in millimeters (inches). Dimensions are not intended for manufacturing purposes.

**Figure 34 - Mounting Position for 100-E09...100-E96 Devices— AC/DC and AC/DC with PLC input**

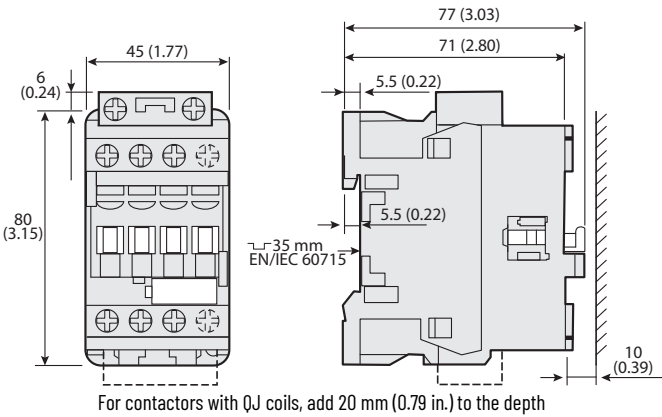


**Figure 37 - 100-E09...100-E16 Contactors with Standard Coils and Front-mounted Auxiliary Contact**

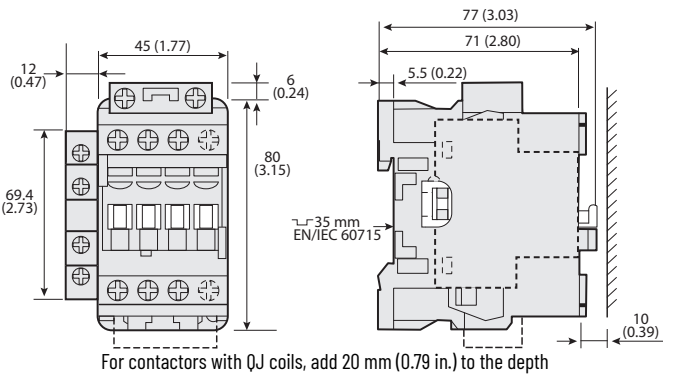


## 9...16 A Contactors

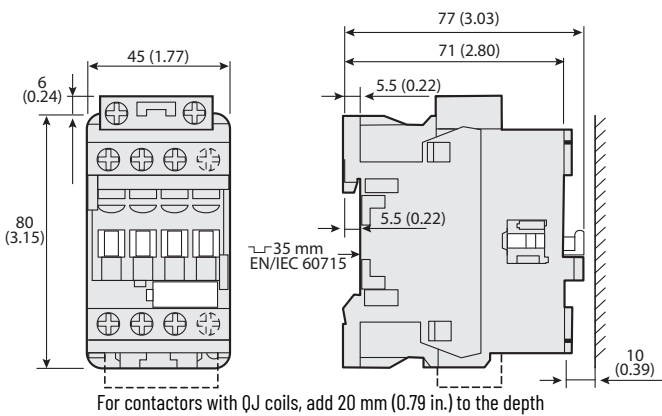
**Figure 35 - 100-E09...100-E16 Contactors with Standard Coils**



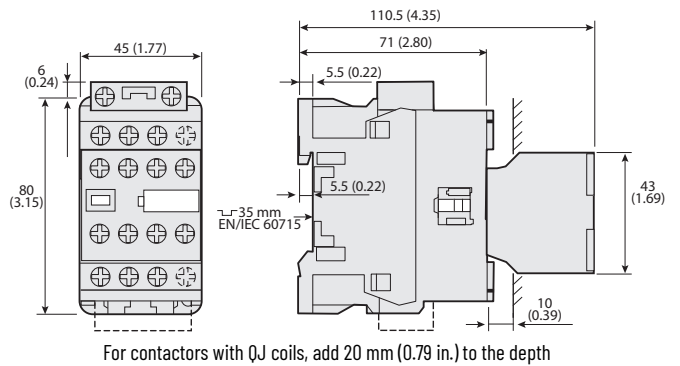
**Figure 38 - 100-E09...100-E16 Contactors with Standard Coils and Side-mounted Auxiliary Contact**



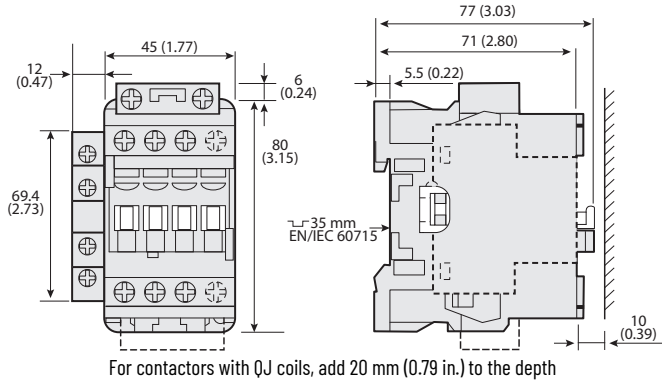
**Figure 36 - 100-E09...100-E16 Contactors with Low-consumption Coils**



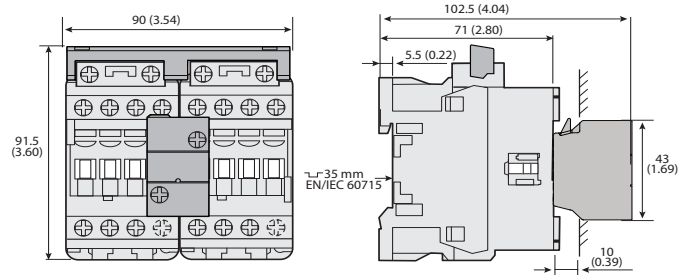
**Figure 39 - 100-E09...100-E16 Contactors with Low-consumption Coils and Front-mounted Auxiliary Contact**



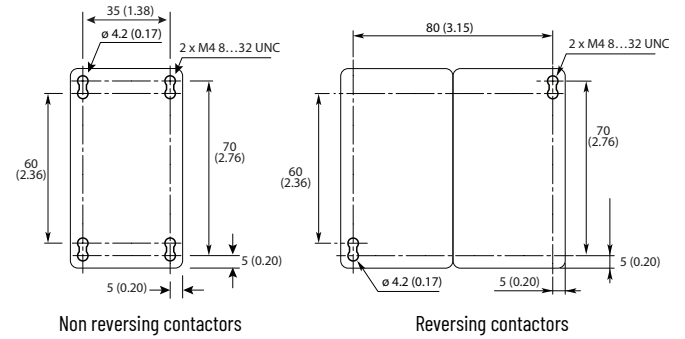
**Figure 40 - 100-E09...100-E16 Contactors with Low-consumption Coils and Side-mounted Auxiliary Contact**



**Figure 41 - 104-E09...104-E16 Reversing Contactors with Cat. No. 100-EMCA02 Mechanical and Electrical Interlock**

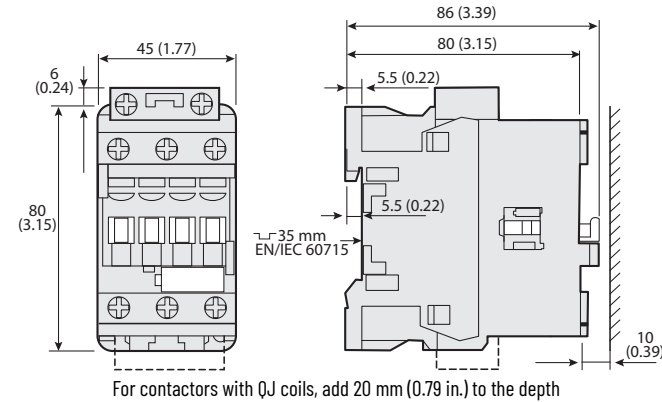


**Figure 42 - Drilling Template for 9...16 A Contactors**

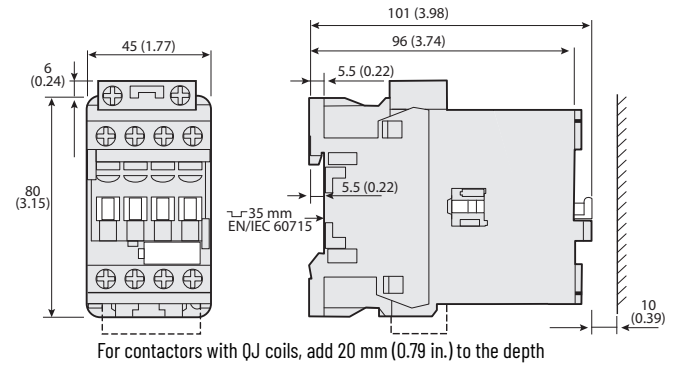


## 26...38 A Contactors

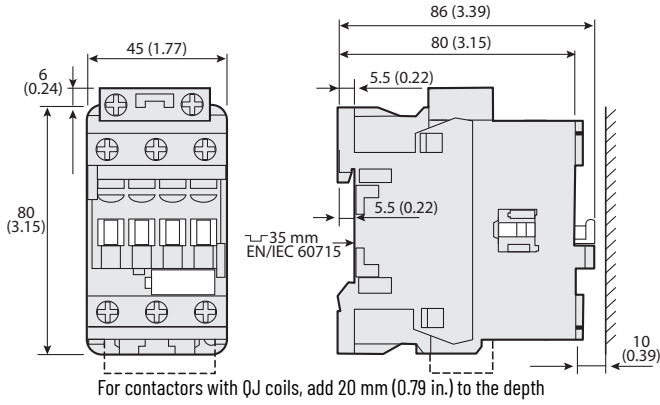
**Figure 43 - 100-E26...100-E38 3-Pole Contactors with Standard Coils**



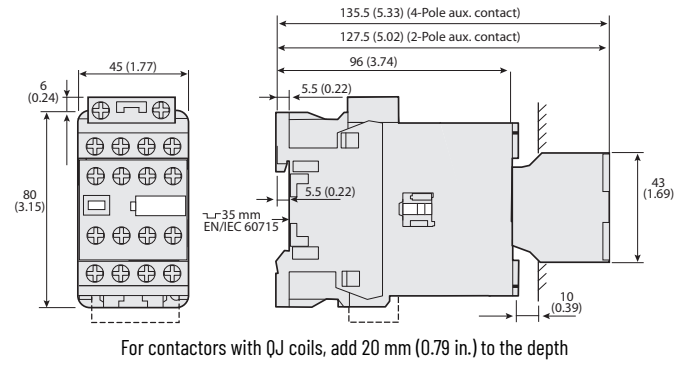
**Figure 44 - 100-E26...100-E38 4-Pole Contactors with Standard Coils**



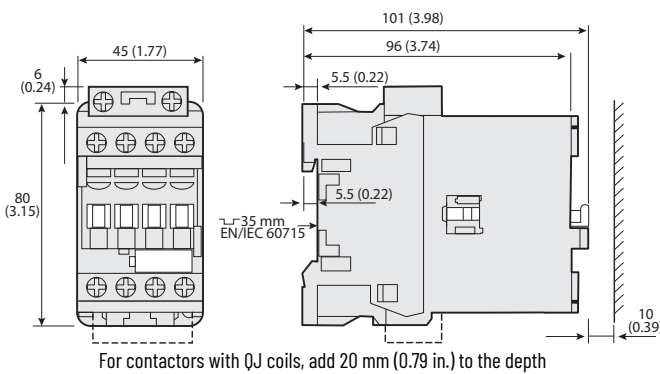
**Figure 45 - 100-E26...100-E38 3-Pole Contactors with Low-consumption Coils**



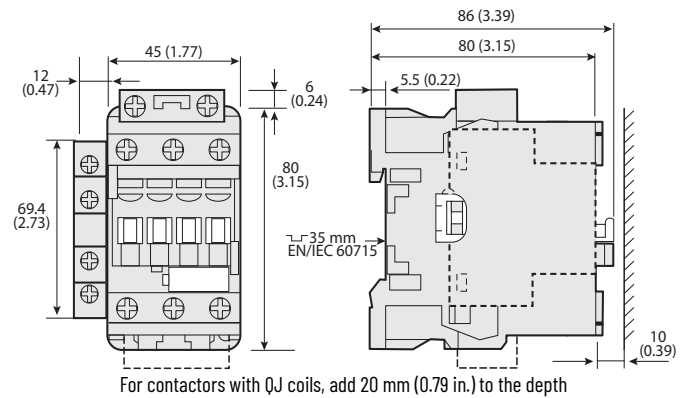
**Figure 48 - 100-E26...100-E38 4-Pole Contactors with Standard Coils and Front-mounted Auxiliary Contact**



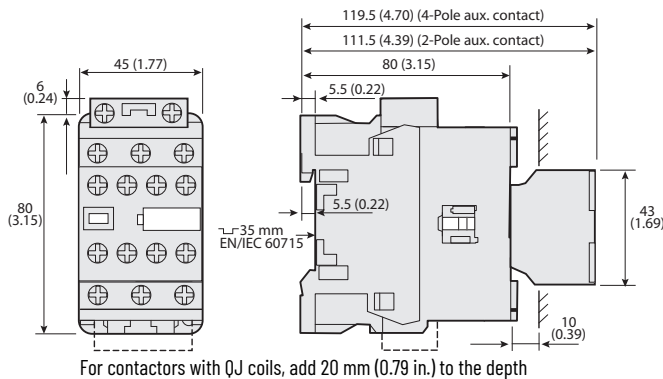
**Figure 46 - 100-E26...100-E38 4-Pole Contactors with Low-consumption Coils**



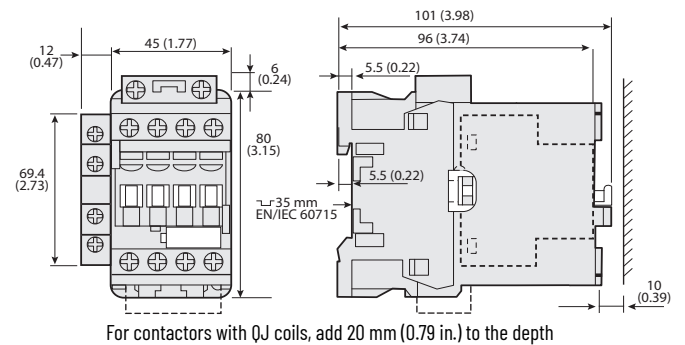
**Figure 49 - 100-E26...100-E38 3-Pole Contactors with Standard Coils and Side-mounted Auxiliary Contact**



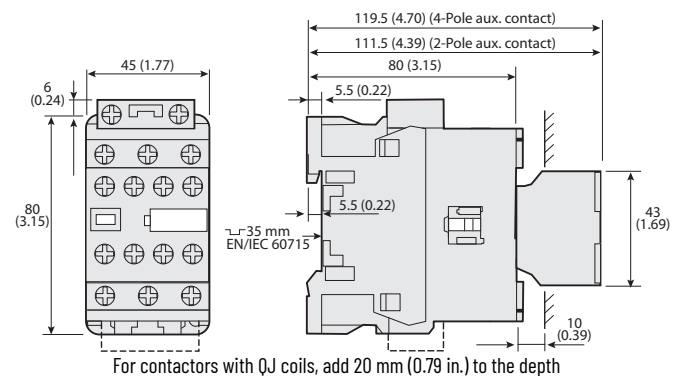
**Figure 47 - 100-E26...100-E38 3-Pole Contactors with Standard Coils and Front-mounted Auxiliary Contact**



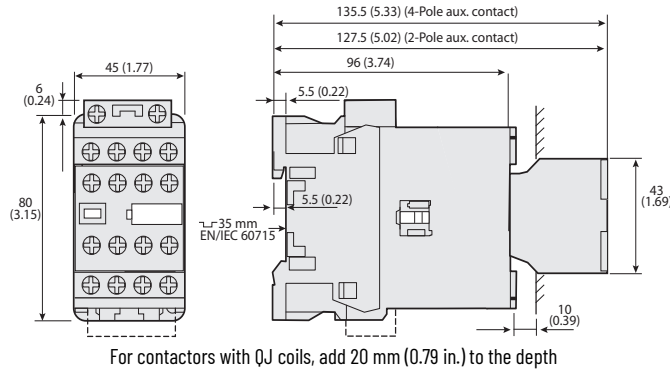
**Figure 50 - 100-E26...100-E38 4-Pole Contactors with Standard Coils and Side-mounted Auxiliary Contact**



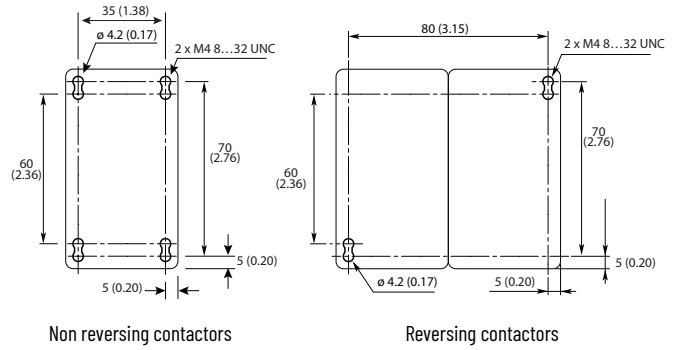
**Figure 51 - 100-E26...100-E38 3-Pole Contactors with Low-consumption Coils and Front-mounted Auxiliary Contact**



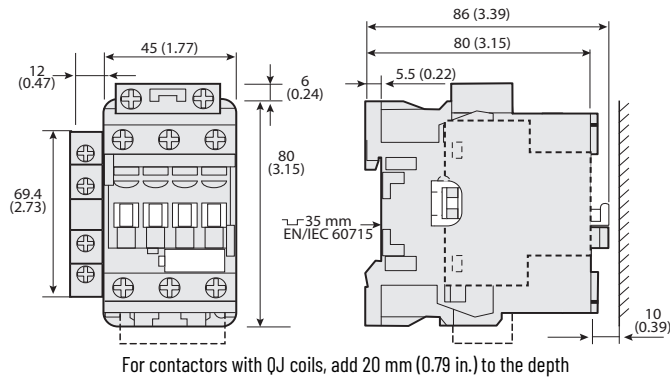
**Figure 52 - 100-E26...100-E38 4-Pole Contactors with Low-consumption Coils and Front-mounted Auxiliary Contact**



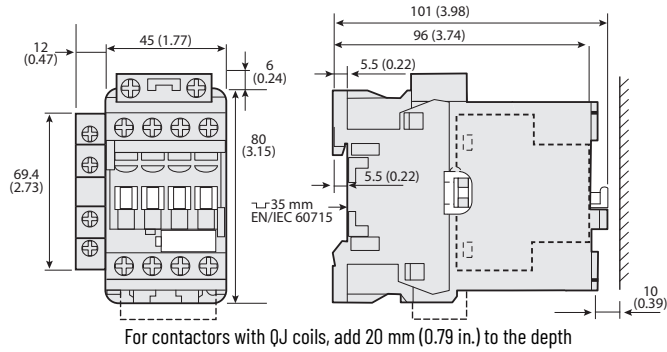
**Figure 56 - Drilling Template for 26...38 A Contactors**



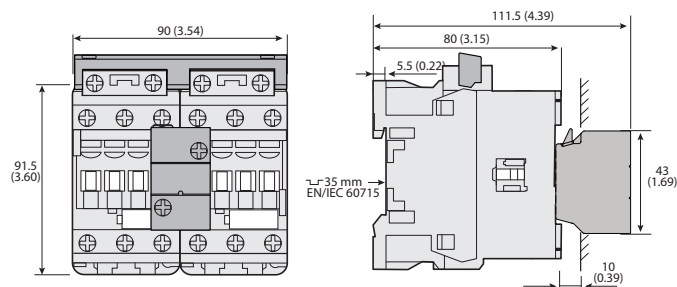
**Figure 53 - 100-E26...100-E38 3-Pole Contactors with Low-consumption Coils and Side-mounted Auxiliary Contact**



**Figure 54 - 100-E26...100-E38 4-Pole Contactors with Low-consumption Coils and Side-mounted Auxiliary Contact**



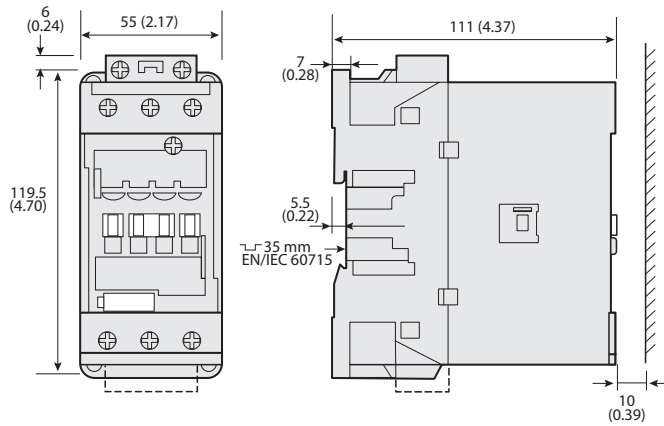
**Figure 55 - 104-E26...104-E38 Reversing Contactors with Cat. No. 100-EMCA02 Mechanical and Electrical Interlock**



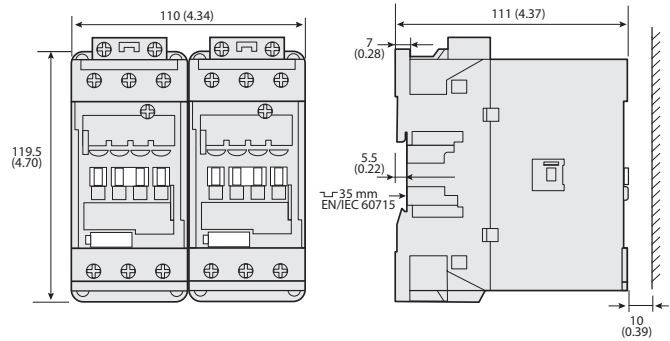


# 40...65 A Contactors

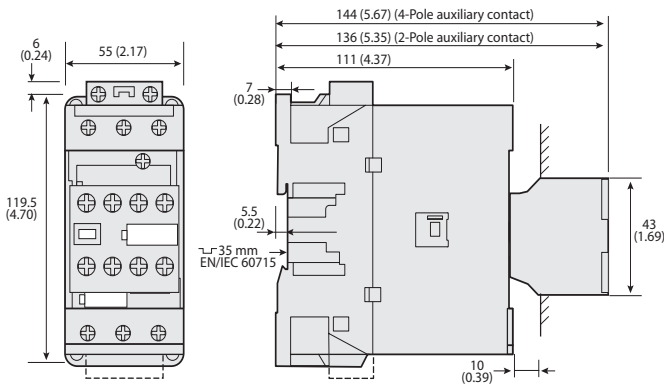
**Figure 57 - 100-E40...100-E65 3-Pole Contactors**



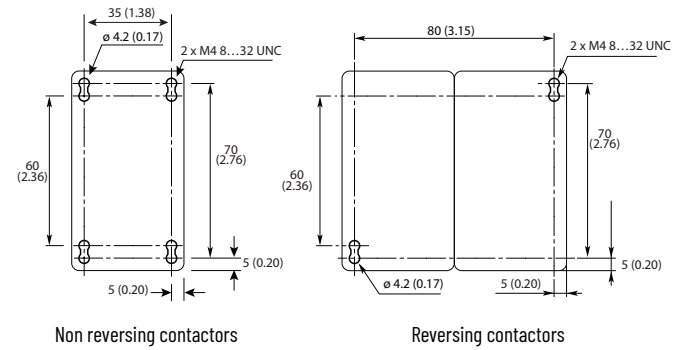
**Figure 60 - 104-E40...104-E65 Reversing 3-Pole Contactors**



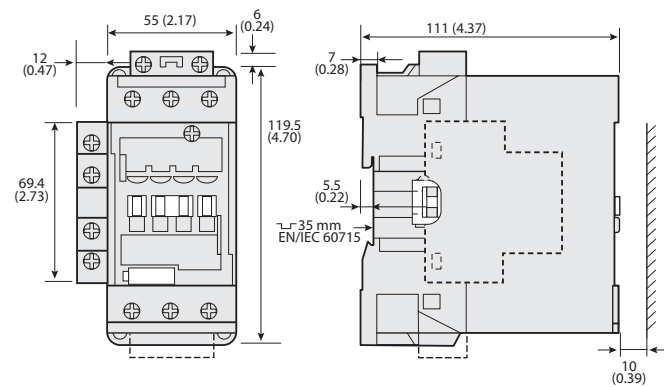
**Figure 58 - 100-E40...100-E65 3-Pole Contactors with Front-mounted Auxiliary Contact**



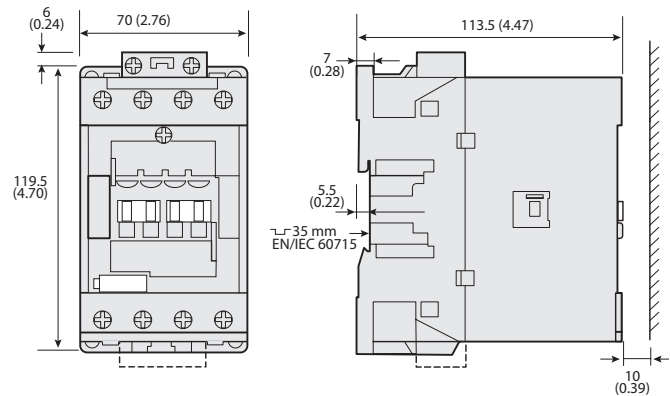
**Figure 61 - Drilling Template for 40...65 A 3-Pole Contactors**



**Figure 59 - 100-E40...100-E65 3-Pole Contactors with Side-mounted Auxiliary Contact**



**Figure 62 - 100-E40...100-E52 4-Pole Contactors**



**Figure 63 - 100-E40...100-E52 4-Pole Contactors with Front-mounted Auxiliary Contact**

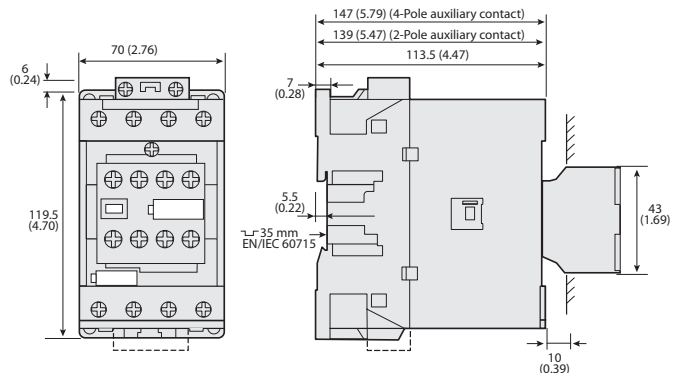


Figure 64 - 100-E40...100-E52 4-Pole Contactors with Side-mounted Auxiliary Contact

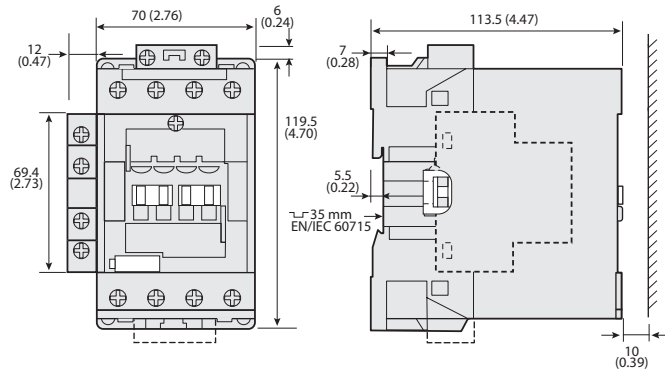
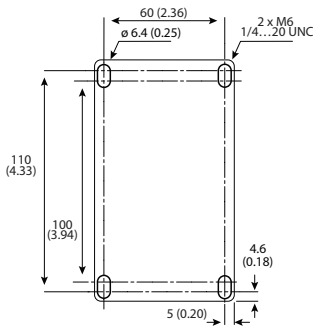


Figure 65 - Drilling Template for 40...52 A 4-Pole Contactors



## 80...96 A Contactors

Figure 66 - 100-E80...100-E96 3-Pole Contactors

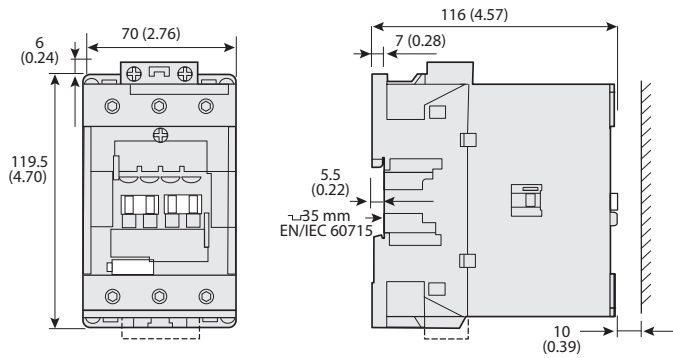
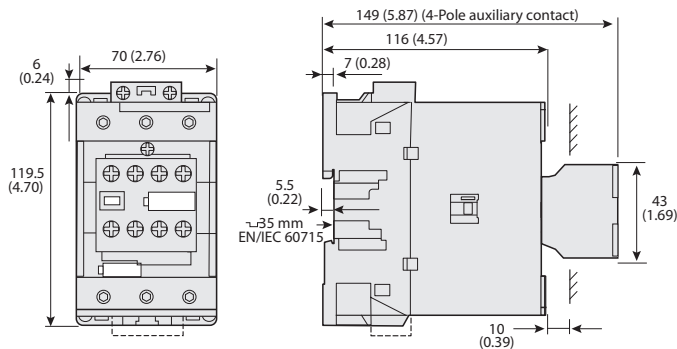
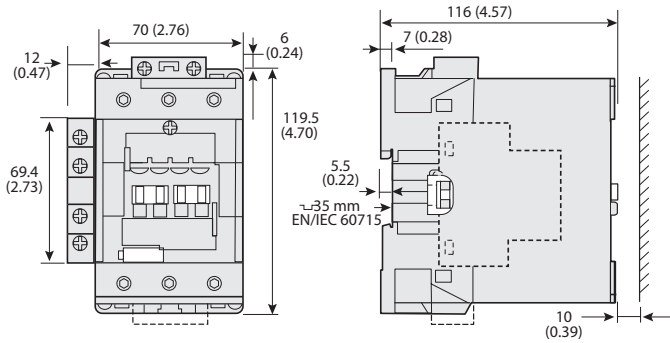


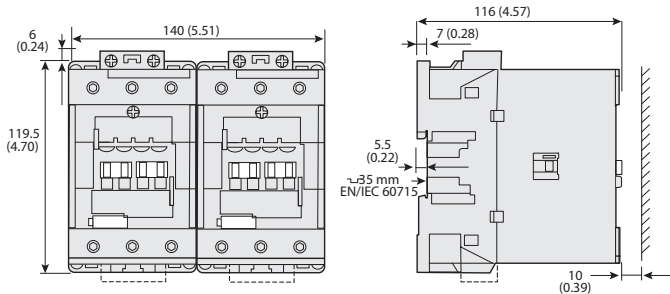
Figure 67 - 100-E80...100-E96 3-Pole Contactors with Front-mounted Auxiliary Contact



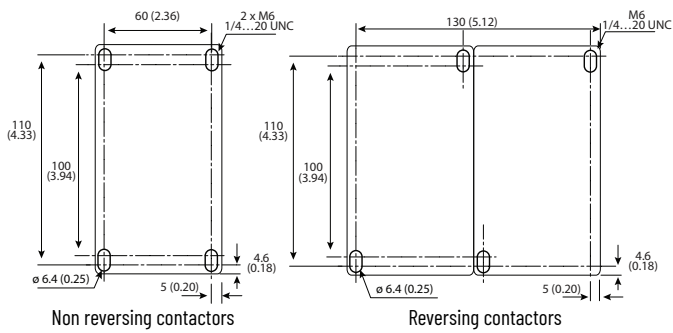
**Figure 68 - 100-E80...100-E96 3-Pole Contactors with Side-mounted Auxiliary Contact**



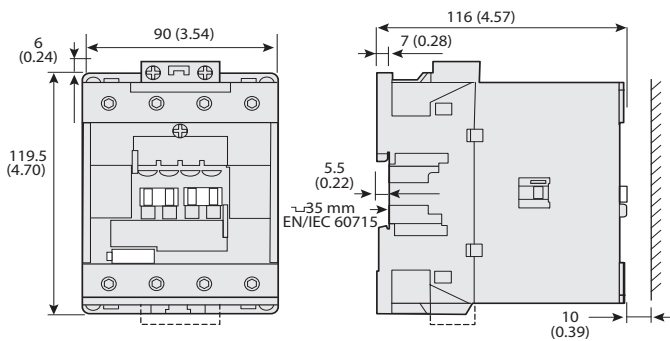
**Figure 69 - 104-E80...104-E96 Reversing 3-Pole Contactors**



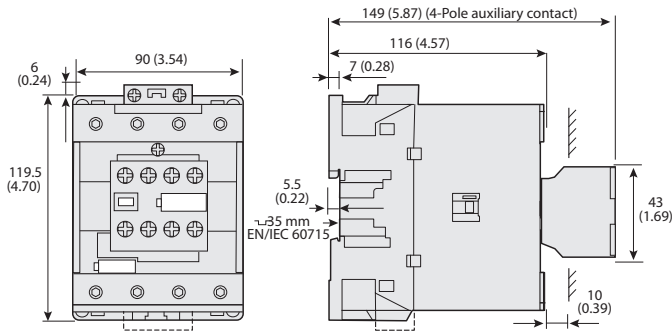
**Figure 70 - Drilling Template for 80...96 A 3-Pole Contactors**



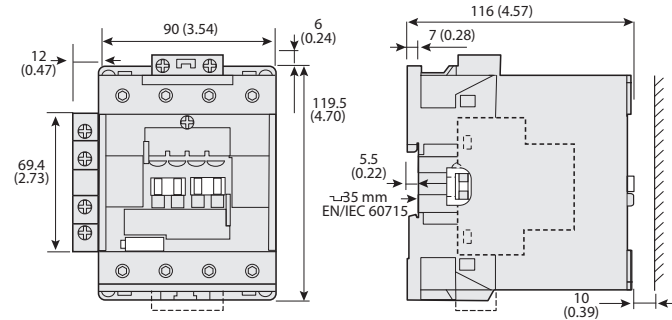
**Figure 71 - 100-E80 4-Pole Contactors**



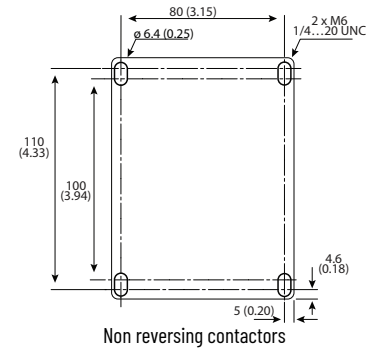
**Figure 72 - 100-E80 4-Pole Contactors with Front-mounted Auxiliary Contact**



**Figure 73 - 100-E80 4-Pole Contactors with Side-mounted Auxiliary Contact**

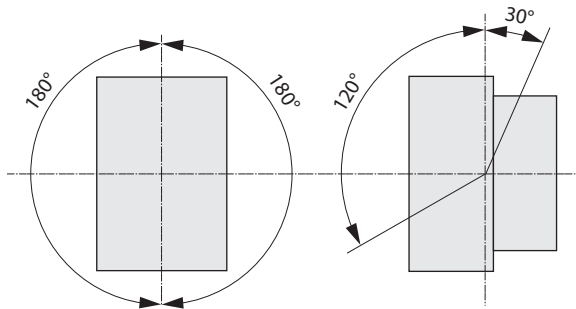


**Figure 74 - Drilling Template for 80 A 4-Pole Contactors**

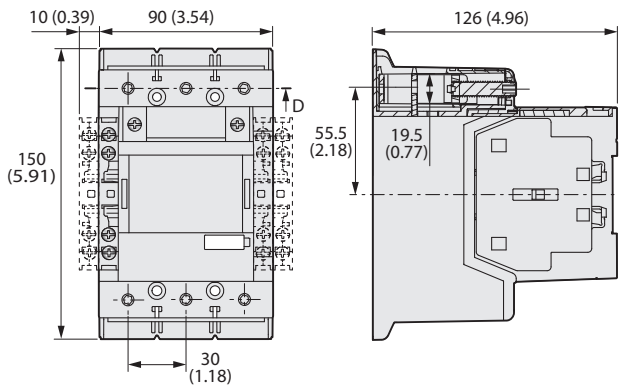


## 116...2650 A Contactors

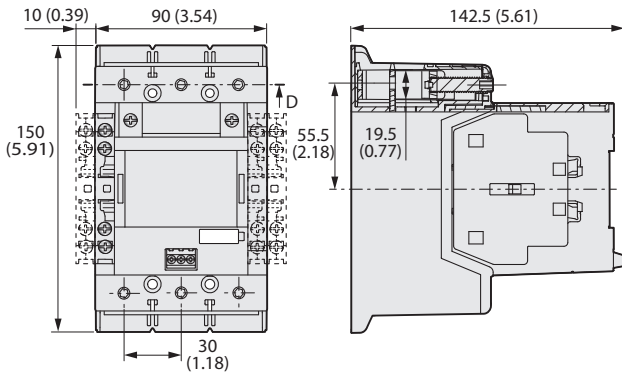
**Figure 75 - Mounting Position for 100-E116...100-E2650 Devices— AC/DC and AC/DC with PLC input**



**Figure 76 - 100-E116K..., 100-E146K... Contactors**



**Figure 77 - 100-E116E..., 100-E146E... Contactors with PLC Input**



**Figure 78 - 104-E116E..., 104-E146E... Reversing Contactors with Cat. No. 100-EM... Mechanical Interlock**

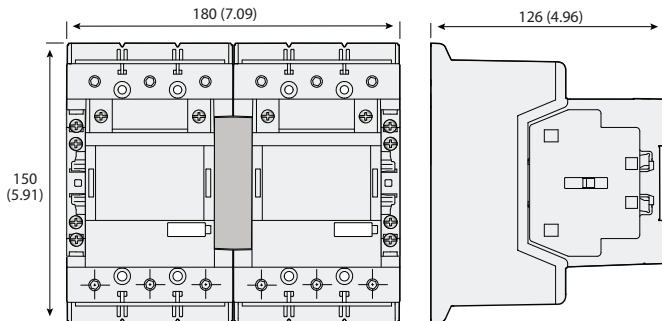


Figure 79 - Drilling Template for 116...146 A 3-Pole Contactors

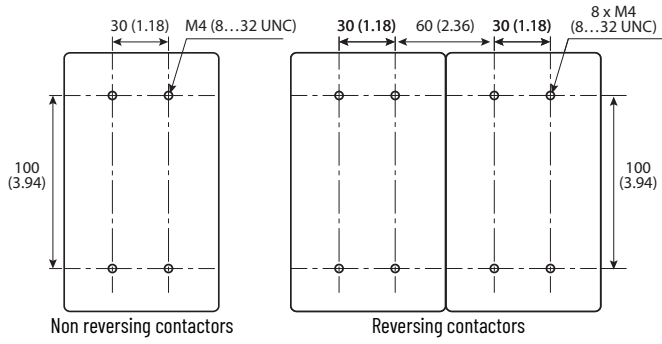


Figure 80 - 100-E190, 100-E205 Contactors

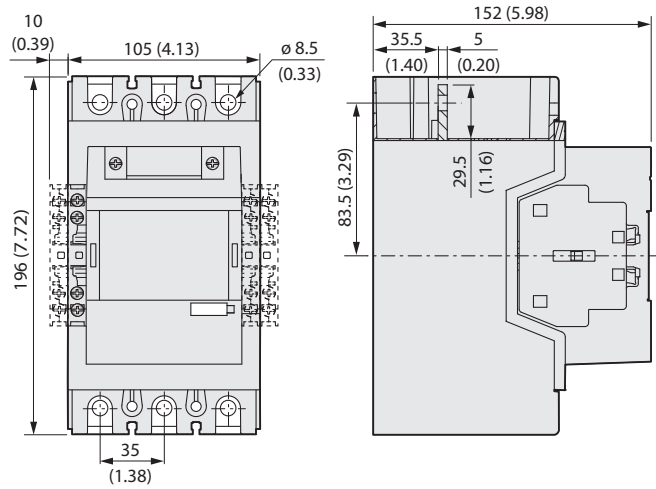
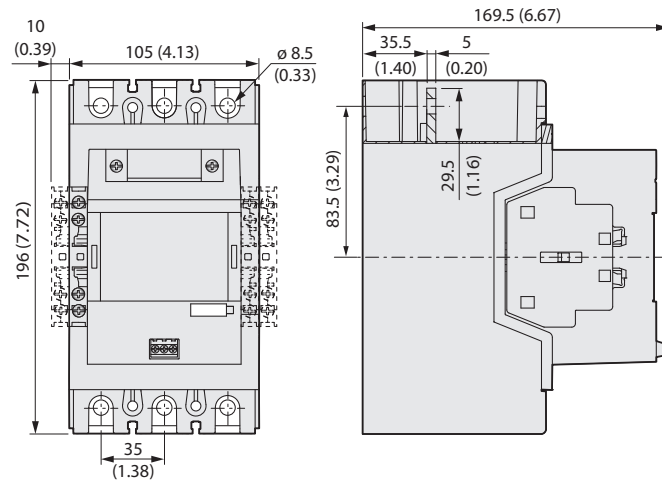
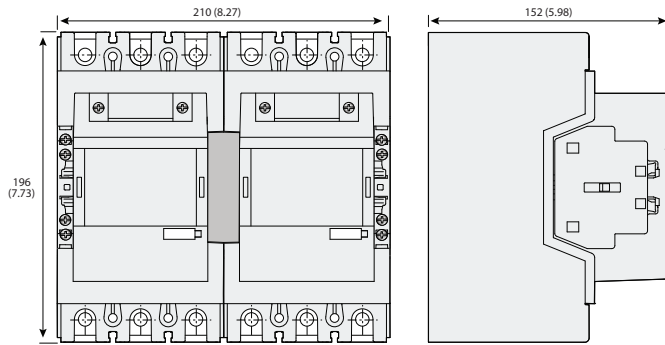


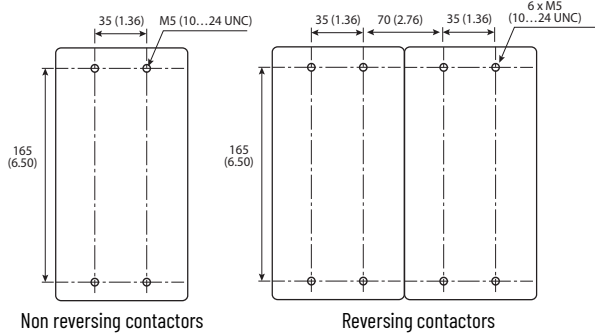
Figure 81 - 100-E190E, 100-E205E Contactors with PLC Input



**Figure 82 - 104-E190, 104-E205 Reversing Contactors with Cat. No. 100-EM... Mechanical Interlock**



**Figure 83 - Drilling Template for 190...205 A 3-Pole Contactors**



**Figure 84 - 100-E265...100-E370 Contactors**

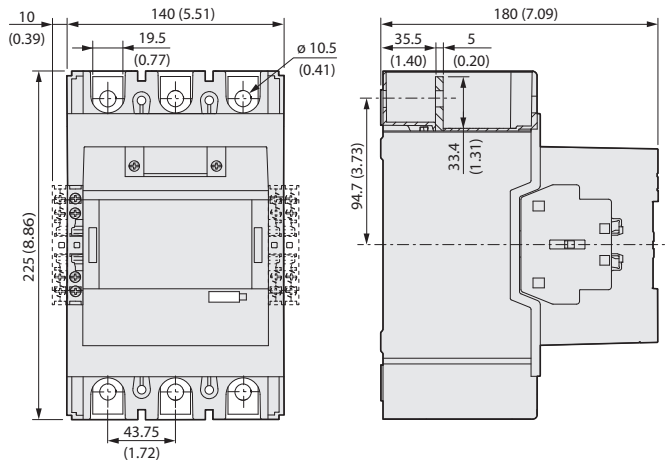
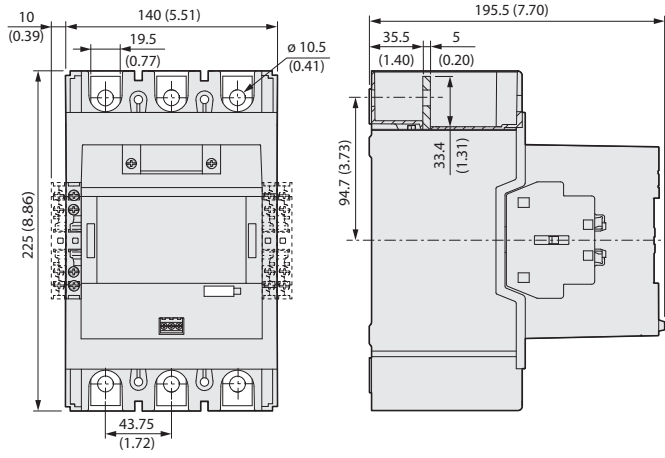
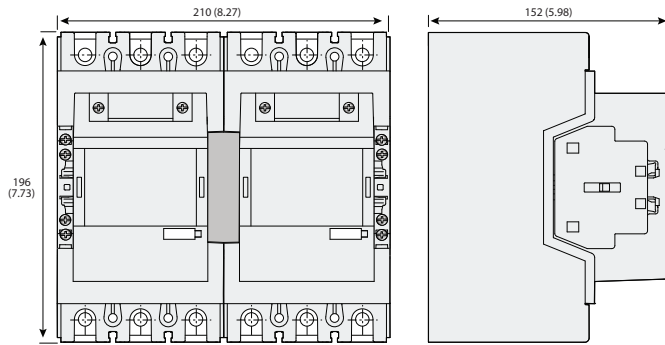


Figure 85 - 100-E265E...100-E370E Contactors with PLC Input





**Figure 86 - 104-E265...104-E370 Reversing Contactors with Cat. No. 100-EM... Mechanical Interlock**



**Figure 87 - Drilling Template for 265...370 A 3-Pole Contactors**

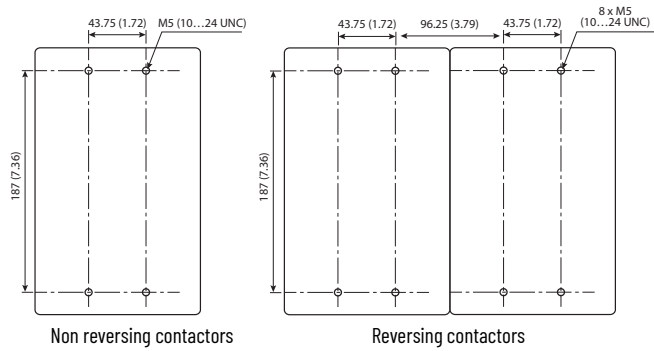


Figure 88 - 100-E400, 100-E460 Contactors with PLC Input

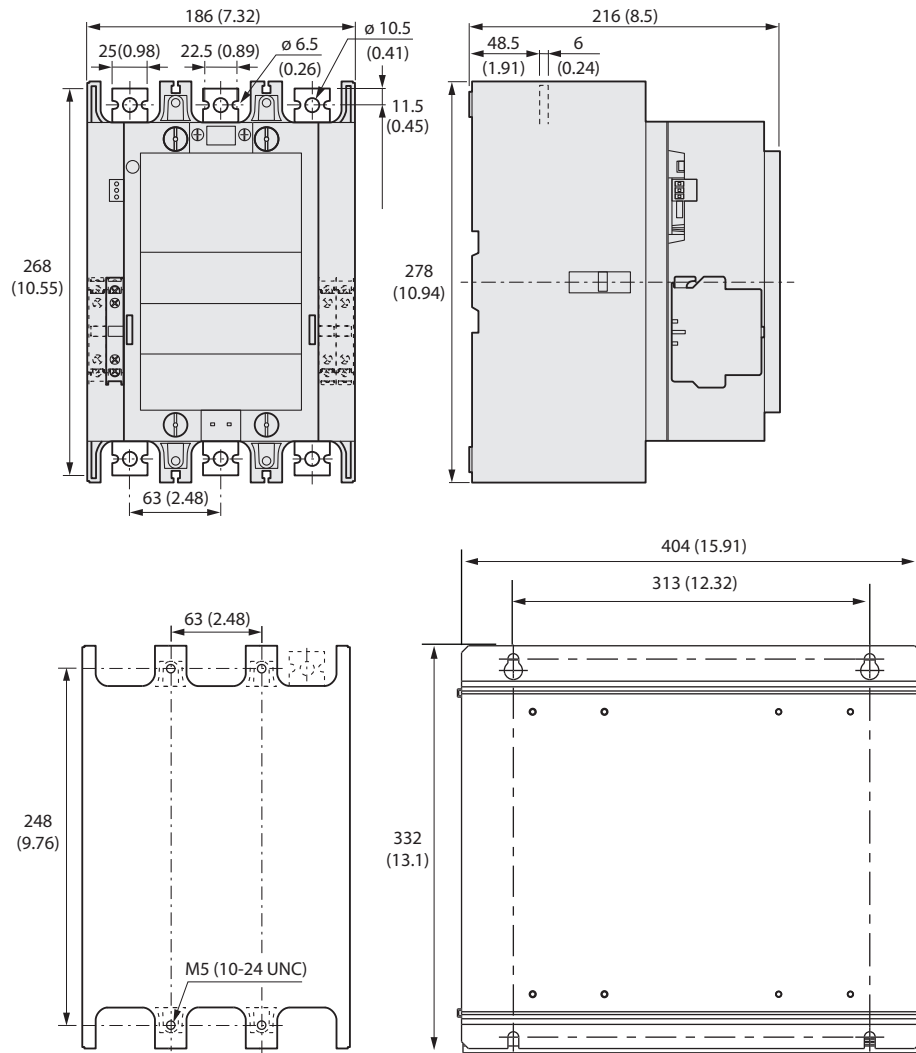


Figure 89 - 100-E580...100-E750 Contactors with PLC Input

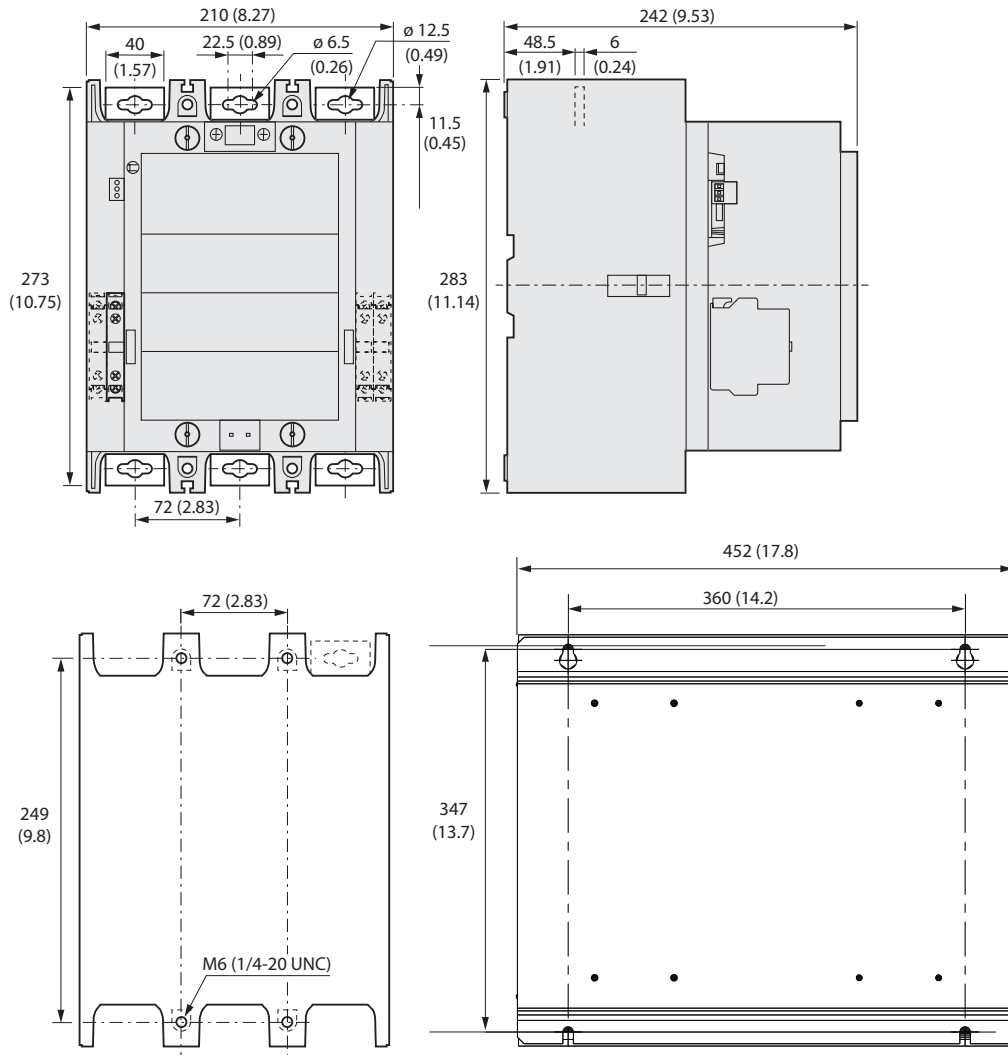


Figure 90 - 100-E1260 Contactors with PLC Input

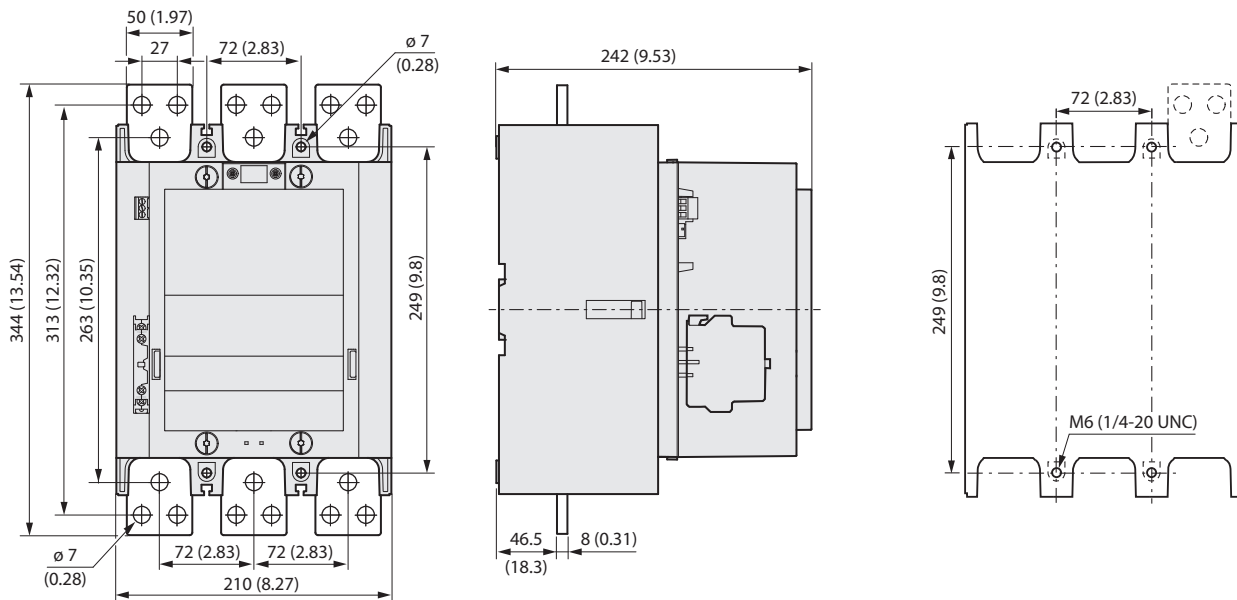
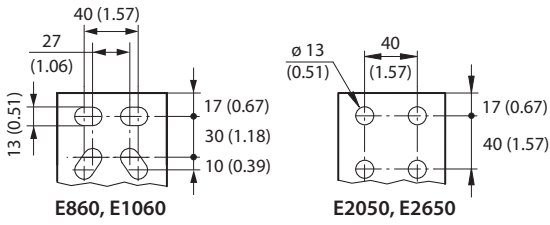
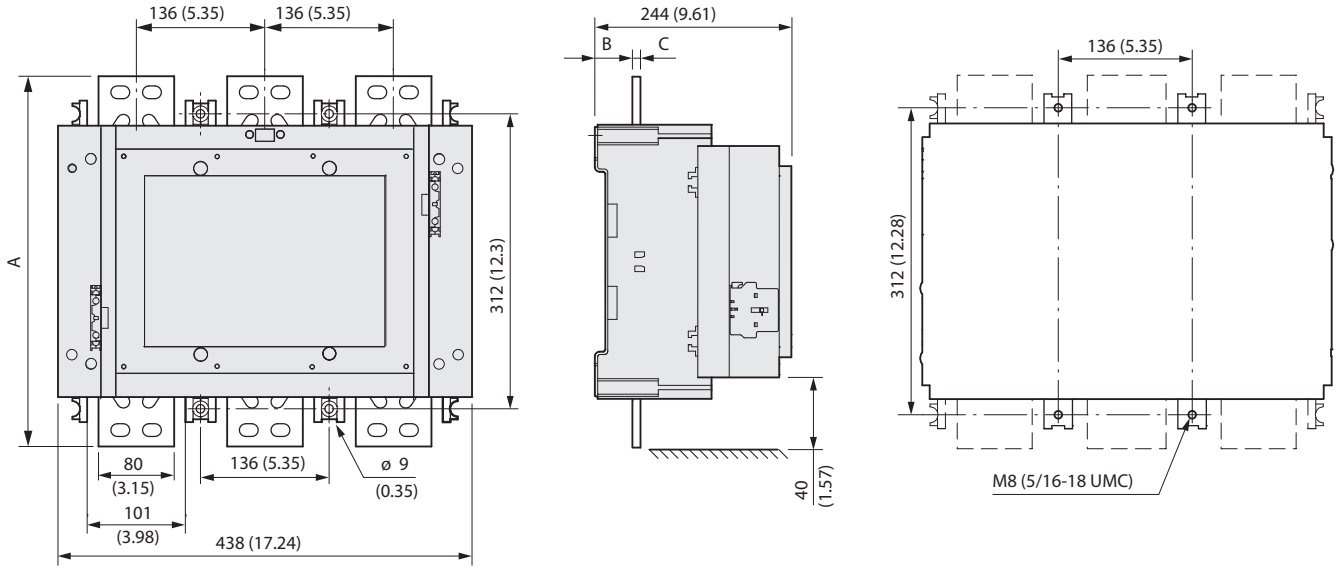


Figure 91 - 100-E860, 100-E1060, 100-E2050, 100-E2650 Contactors with PLC Input



|          | E860, E1060, E2050 | E2650       |
|----------|--------------------|-------------|
| <b>A</b> | 392 (15.43)        | 422 (16.61) |
| <b>B</b> | 47 (1.85)          | 53 (2.09)   |
| <b>C</b> | 10 (0.39)          | 25 (0.98)   |



## Additional Resources

These documents contain additional information concerning related products from Rockwell Automation.

| Resource   | Description   |
|--|---|
| UL Standards Listing for Industrial Control Products, publication <a href="#">CMPNTS-SR002</a>                                     | Assists original equipment manufacturers (OEMs) with construction of panels, to help ensure that they conform to the requirements of Underwriters Laboratories.   |
| American Standards, Configurations, and Ratings: Introduction to Motor Circuit Design, publication <a href="#">IC-AT001</a>        | Provides an overview of American motor circuit design based on methods that are outlined in the NEC.  |
| Industrial Components Preventive Maintenance, Enclosures, and Contact Ratings Specifications, publication <a href="#">IC-TD002</a> | Provides a quick reference tool for Allen-Bradley industrial automation controls and assemblies.  |
| Safety Guidelines for the Application, Installation, and Maintenance of Solid-state Control, publication <a href="#">SGI-1.1</a>   | Designed to harmonize with NEMA Standards Publication No. ICS 1.1-1987 and provides general guidelines for the application, installation, and maintenance of solid-state control in the form of individual devices or packaged assemblies incorporating solid-state components. |
| Industrial Automation Wiring and Grounding Guidelines, publication <a href="#">1770-4.1</a>  | Provides general guidelines for installing a Rockwell Automation industrial system.   |
| ProposalWorks™ configuration software, <a href="http://rok.auto/systemtools">rok.auto/systemtools</a>                              | Helps configure complete, valid catalog numbers and build complete quotes based on detailed product information.  |
| Rockwell Automation Global SCCR tool, <a href="http://rok.auto/sccr">rok.auto/sccr</a>   | Provides coordinated high-fault branch circuit solutions for motor starters, soft starters, and component drives.   |
| Product Certifications website, <a href="http://rok.auto/certifications">rok.auto/certifications</a>                               | Provides declarations of conformity, certificates, and other certification details.   |

You can view or download publications at [rok.auto/literature](http://rok.auto/literature).

# Rockwell Automation Support

Use these resources to access support information.

|   |   |  |
|---|---|--|
| <b>Technical Support Center</b>                         | Find help with how-to videos, FAQs, chat, user forums, Knowledgebase, and product notification updates. | <a href="http://rok.auto/support">rok.auto/support</a>           |
| <b>Local Technical Support Phone Numbers</b>            | Locate the telephone number for your country.   | <a href="http://rok.auto/phonesupport">rok.auto/phonesupport</a> |
| <b>Technical Documentation Center</b>                   | Quickly access and download technical specifications, installation instructions, and user manuals.      | <a href="http://rok.auto/techdocs">rok.auto/techdocs</a>         |
| <b>Literature Library</b>                               | Find installation instructions, manuals, brochures, and technical data publications.                    | <a href="http://rok.auto/literature">rok.auto/literature</a>     |
| <b>Product Compatibility and Download Center (PCDC)</b> | Download firmware, associated files (such as AOP, EDS, and DTM), and access product release notes.      | <a href="http://rok.auto/pcdc">rok.auto/pcdc</a>                 |





## Documentation Feedback

Your comments help us serve your documentation needs better. If you have any suggestions on how to improve our content, complete the form at [rok.auto/docfeedback](http://rok.auto/docfeedback).

Allen-Bradley, expanding human possibility, ProposalWorks, and Rockwell Automation are trademarks of Rockwell Automation, Inc. Trademarks not belonging to Rockwell Automation are property of their respective companies.

Rockwell Automation maintains current product environmental compliance information on its website at [rok.auto/pec](http://rok.auto/pec).

Rockwell Otomasyon Ticaret A.Ş. Kar Plaza İş Merkezi E Blok Kat:6 34752, İçerenköy, İstanbul, Tel: +90 (216) 5698400 EEE Yönetmeliğine Uygundur

Connect with us.    

**rockwellautomation.com** ————— expanding **human possibility**<sup>®</sup>

AMERICAS: Rockwell Automation, 1201 South Second Street, Milwaukee, WI 53204-2496 USA, Tel: (1) 414.382.2000, Fax: (1) 414.382.4444

EUROPE/MIDDLE EAST/AFRICA: Rockwell Automation NV, Pegasus Park, De Kleetlaan 12a, 1831 Diegem, Belgium, Tel: (32) 2 663 0600, Fax: (32) 2 663 0640

ASIA PACIFIC: Rockwell Automation, Level 14, Core F, Cyberport 3, 100 Cyberport Road, Hong Kong, Tel: (852) 2887 4788, Fax: (852) 2508 1846

UNITED KINGDOM: Rockwell Automation Ltd. Pitfield, Kiln Farm Milton Keynes, MK11 3DR, United Kingdom, Tel: (44)(1908) 838-800, Fax: (44)(1908) 261-917

Publication 100-TD013L-EN-P - June 2023

Supersedes Publication 100-TD013K-EN-P - June 2022

Copyright © 2023 Rockwell Automation, Inc. All rights reserved. Printed in the U.S.A.