

LISTEN.
THINK.
SOLVE.SM



MCS MINIATURE CONTACTORS SELECTION GUIDE

THE MINIATURE MODULAR CONTROL SYSTEM
SMALL IN DIMENSIONS - BIG IN PERFORMANCE



DOL- Starter

- ✓ Overload Protection

PROTECTION FOR AC AND DC MOTORS

- The Bulletin 193-K thermal overload relay is designed to work with Bulletin 100-K mini contactors.
- Sensitivity under phase loss conditions through differential mechanism.
- Temperature compensated for precise motor protection from -20°C to + 60°C.



DOL- Starter

- ✓ Overload Protection
- ✓ Short Circuit Protection

SHORT CIRCUIT PROTECTION RELIABILITY

- The Bulletin 140-M motor protection circuit breaker is the ideal device for economic and compact starter solutions providing short circuit and motor overload protection.
- The excellent breaking capacity provides effective, fast shut-off in case of short-circuits, limiting equipment damage.
- Sensitivity under phase loss conditions through differential mechanism.
- Temperature compensated for precise motor protection from -20°C to + 60°C.
- Only one DIN Rail required for the complete starter.



Reversing Starter

- ✓ For Reversing Motors
- ✓ Overload Protection
- ✓ Short Circuit Protection

REVERSING AND STAR-DELTA STARTERS

- With the Bulletin 100-K mini contactor and the Bulletin 140-M circuit breaker, it's easier than ever to assemble reversing and star-delta starters.
- Connection kit for easy and time-saving wiring.

THE NEW MINIATURE CONTACTOR FROM ROCKWELL AUTOMATION:

- Switching and protection of DOL or reversing motors up to 5.5 kW at 400V and 690V.
- Switching of illumination or heating loads up to 20 A.
- Reliability for switching of signals down to 15V/2 mA.



ON-MACHINE CONTROLS



INDUSTRIAL PRODUCTION

COST- AND SPACE-SAVING MOTOR CONTROL HAS A NEW NAME

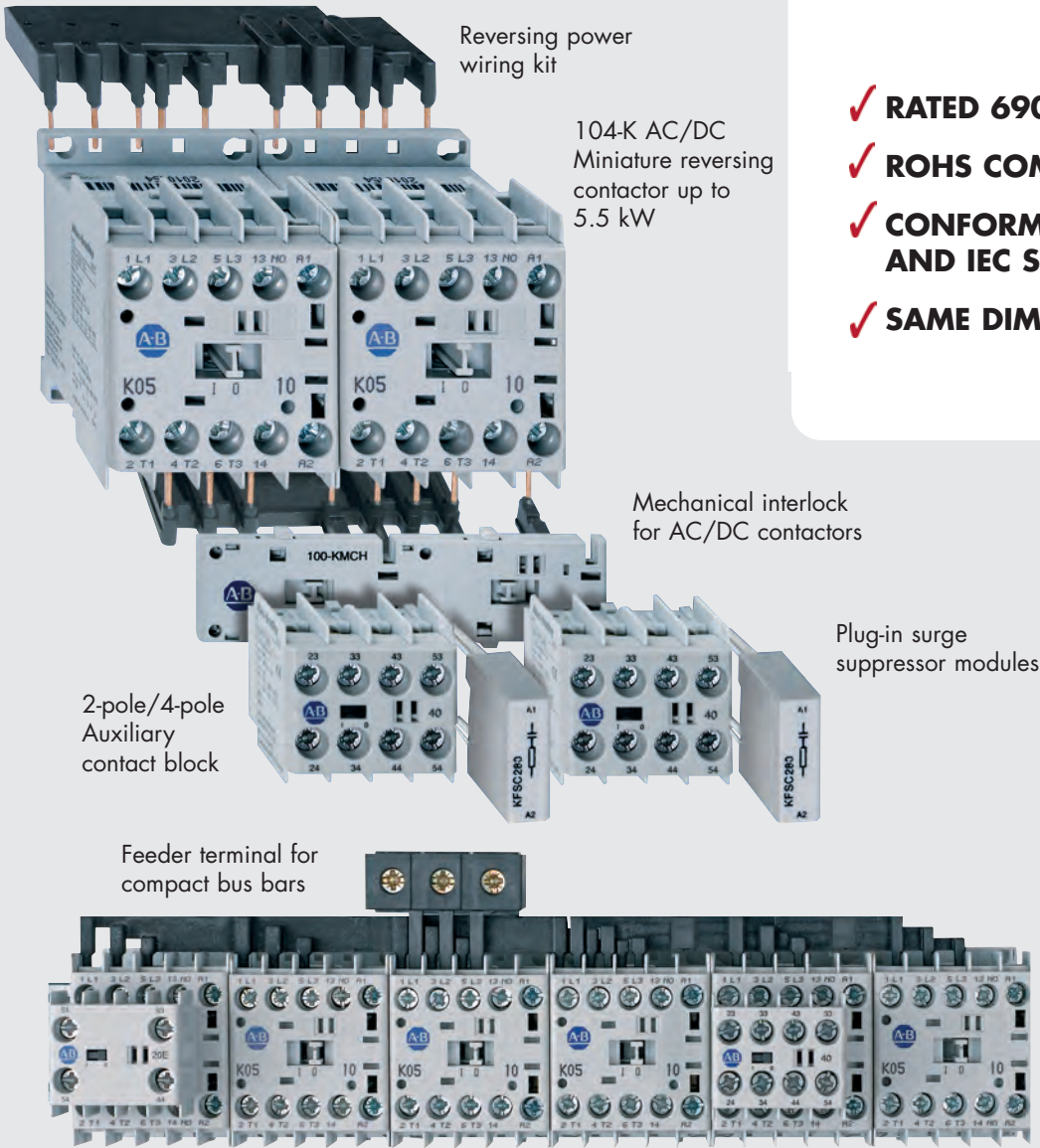

Reversing power wiring kit

104-K AC/DC Miniature reversing contactor up to 5.5 kW

- ✓ **RATED 690V**
- ✓ **ROHS COMPLIANT**
- ✓ **CONFORMING TO US, CANADIAN, AND IEC STANDARDS**
- ✓ **SAME DIMENSIONS FOR AC AND DC**

Mechanical interlock for AC/DC contactors

Plug-in surge suppressor modules

2-pole/4-pole Auxiliary contact block

Feeder terminal for compact bus bars

Three-phase compact bus bars for feeding up to four contactors. Additional contactors can be added by interconnecting the bus bars.

STATE-OF-THE-ART CONTROL FOR YOUR APPLICATIONS



LAUNDRY EQUIPMENT



LIGHTNING AND HVAC



PUMPS AND IRRIGATION

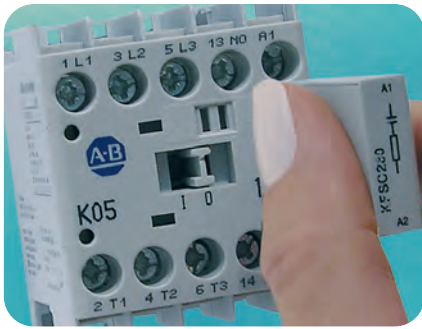

PLUGGABLE SURGE SUPPRESSOR MODULES

- Suppressor modules are simply plugged on the front of the contactors, next to the auxiliary contact blocks.
- No wiring required: fast and easy installation.



COMPACT AUXILIARY CONTACT BLOCKS

- The front pluggable auxiliary contact blocks are 36 mm wide, leaving space for a 9 mm wide surge suppressor module next to it.
- Large variety of contact configurations.

TIME-SAVING FEATURES

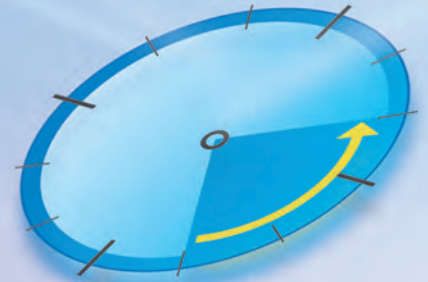

HIGH FLEXIBILITY CONFIGURATION FOR REVERSING CONTACTORS

- The front pluggable mechanical interlock for AC and DC contactors allows top mounting of auxiliary contact blocks and surge suppressor modules.
- High flexibility for easy tailoring to application needs.
- All front-mounted modules are pluggable.
- Sturdy, molded, reversing wiring kits make the assembly fast and easy.

MIRROR AND MECHANICALLY LINKED DESIGN

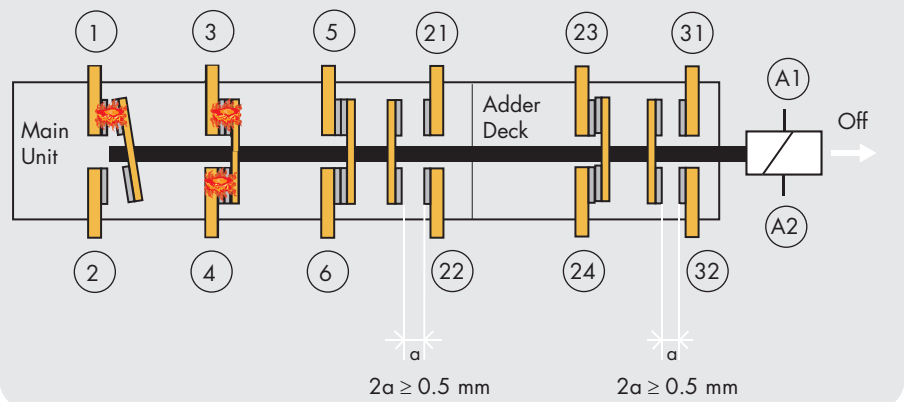

ALL-AROUND SAFETY

- 100-K: Mechanically linked performance between main contacts and internal auxiliary contacts. This feature provides status feedback in the event of a contact weld.
- 100-K/100-KF: Mirror contact between main and auxiliary contacts as per IEC 60947-4-1 prevent any status condition if a N.O. power pole welds.

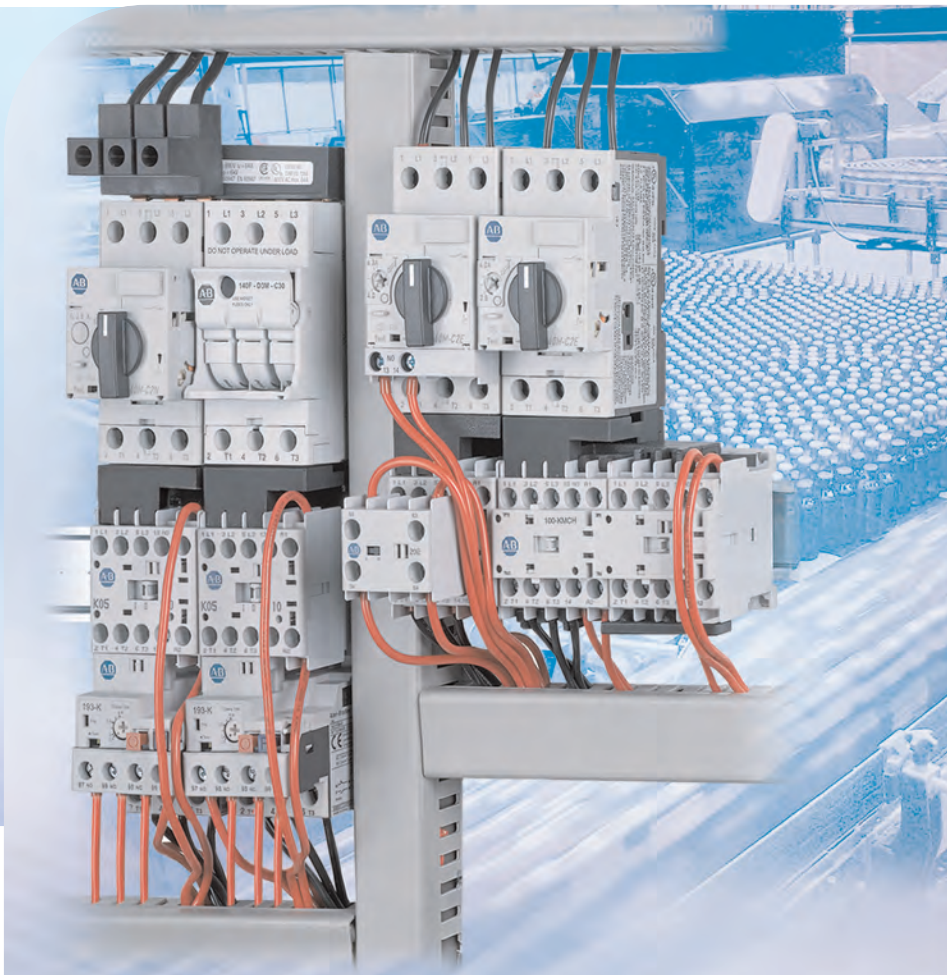

CHOICE OF MODULAR STARTERS

- Compact Two-Component Starters using Bulletin 140-M motor circuit protector and Bulletin 100-K mini contactors.
- Three-Component Starters with fuse holders, Bulletin 100-K mini contactors, and Bulletin 193-K bimetal overload relays.
- Three-component starters using Bulletin 140M motor circuit protector, Bulletin 100-K mini-contactor and Bulletin 193-K overload relay.

PARALLEL 3-PHASE FEEDING OF CONTACTORS

- Versions for feeding three or four contactors; extension is possible.

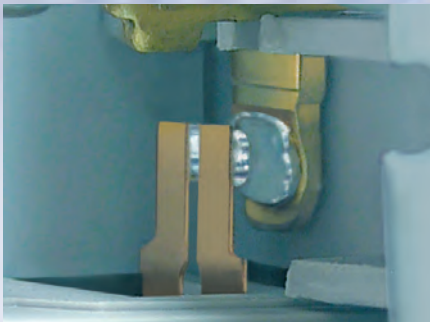

CONTACT RELIABILITY

- Bifurcated, AgNi (silver/nickel)-plated contacts for high contact reliability for 15V/2 mA electronic signals.
- H-shaped self cleaning auxiliary contacts provide a 4-way current path enabling contact reliability for low energy switching.

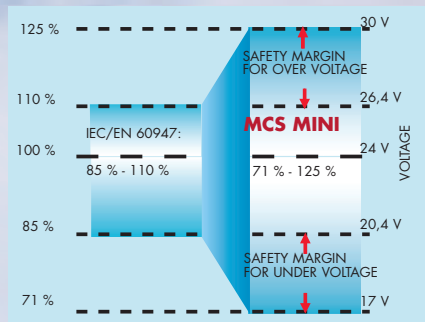

HIGH PERFORMANCE AC AND DC COILS

- Wide-range DC coils can provide reliability in case of over- and under-voltage, a common issue with battery-fed control power supply systems.
- The low coil consumption allows the contactors to be directly controlled via a PLC.
- Optional, integral factory-installed surge suppressor modules for AC and DC for limiting coil switching transients.

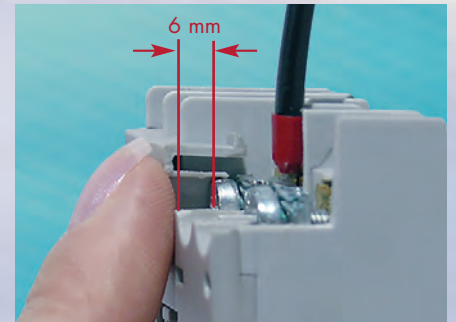

OPERATOR SAFETY

- 6 mm distance from housing surface to live parts enables compliance with dielectric voltage test requirements per IEC 60947-1 edition 4.
- Increased operator protection against contact with contactor terminals.



IEC Miniature Contactors

- Bulletin 100/104-K Miniature Contactors

Page 8



IEC Miniature Control Relays

- Bulletin 700-K Miniature Control Relays

Page 12



IEC Miniature Thermal Overload Relays

- Bulletin 193-K Miniature Thermal Overload Relays

Page 15



IEC Circuit Breakers

- Bulletin 140M Circuit Breakers
- Bulletin 140M Fuse Holders

Page 16

Page 17



IEC Miniature Starter Selection

- Selection

Page 21

IEC Miniature Contactors

Overview/Product Selection



Bulletin 100-K / 104-K IEC Contactors

- Compact size
- Same dimensions for AC and DC
- Full-voltage non-reversing and reversing contactors
- 5, 9, and 12 A Contactors rated at 690V
- IP2X Finger Protection
- Optional integrated surge suppressor
- Compatible with Bulletin 193-K bimetallic overload relay
- Mirror contacts per IEC 60947-4-1 and mechanically linked contacts per IEC 60947-5-1 on main unit

Table of Contents

Product Selection this page
 Accessories..... 10
 Specifications..... 22
 Approximate Dimensions..... 31

Standards Compliance

IEC/EN 60947-1,-4-1,-5-1,-5-4
 UL 508
 CSA 22.2. No. 14
 NF F 62-000

Approvals

CE marked
 cULus listed (File No. E41850,
 Guide No. NLDX and NLDX7)

Allen-Bradley Bulletin 100-K miniature contactors are designed for commercial and light industrial applications where panel space is at a premium. These miniature devices, while 45 mm wide, are shallower and have less panel depth requirements than standard IEC contactors.

The miniature contactors have been designed with flexibility in mind. They are available with AC or DC operating coils, several contact ratings, and optional 2- or 4-pole adder decks in a variety of auxiliary contact configurations.

Your order must include: cat. no. (with coil voltage code) of the mini contactor specified and, if required, cat. no. of any accessories

Miniature Contactors



Non-Reversing Mini-Contactors — 3 N.O. Power Poles with Auxiliary Contact

Rated Operational Current I_e [A]	Ratings for switching AC motors - AC-2, AC-3, AC-4										Auxiliary Contacts		Pkg. Qty.*	Cat. No.
	3Ø kW (50 Hz)				Hp (60 Hz)						N.O.	N.C.		
	40 °C	230V	400/415V	500V	690V	1Ø		3Ø						
115V						230V	200V	230V	460V	575V				
AC-1	230V	400/415V	500V	690V	115V	230V	200V	230V	460V	575V	N.O.	N.C.		
20	1.5	2.2	2.2	2.2	1/2	1	1-1/2	1-1/2	3	3	1	0	1	100-K05⊗10
											0	1	1	100-K05⊗01
20	3	4	4	4	1/2	1-1/2	2	2	5	5	1	0	1	100-K09⊗10
											0	1	1	100-K09⊗01
20	3	5.5	5.5	5.5	3/4	2	3	3	7-1/2	7-1/2	1	0	1	100-K12⊗10
											0	1	1	100-K12⊗01

* May be ordered in package quantities of 20. Add letter M to the end of the cat. no. Example: **100-K09ZJ10M**.



⊗ The Cat. No. as listed is incomplete. Select a Coil Voltage Code from the table on page 9 to complete the Cat. No.
 Example: 24V DC: Cat. No. **100-K05⊗10** becomes Cat. No. **100-K05ZJ10**.

Non-Reversing Mini-Contactors — 4 Power Poles

Rated Operational Current I_e [A]	Ratings for switching AC motors - AC-2, AC-3										Contact Configuration, Main Pole		Pkg. Qty.*	Cat. No.
	3Ø kW (50 Hz)				Hp (60 Hz)									
					1Ø		3Ø							
40 °C	230V	400/415V	500V	690V	115V	230V	200V	230V	460V	575V	N.O.	N.C.		
AC-1	230V	400/415V	500V	690V	115V	230V	200V	230V	460V	575V	N.O.	N.C.		
20	1.5	2.2	2.2	2.2	1/2	1	1-1/2	1-1/2	3	3	4	0	1	100-K05Ø400
											3	1	1	100-K05Ø300
											2	2	1	100-K05Ø200
20	3	4	4	4	1/2	1-1/2	2	2	5	5	4	0	1	100-K09Ø400
											3	1	1	100-K09Ø300
											2	2	1	100-K09Ø200
20	3	5.5	5.5	5.5	3/4	2	3	3	7-1/2	7-1/2	4	0	1	100-K12Ø400
											3	1	1	100-K12Ø300
											2	2	1	100-K12Ø200

- * May be ordered in package quantities of 20. Add letter M to the end of the cat. no. Example: **100-K09ZJ400M**.
- ⊗ The Cat. No. as listed is incomplete. Select a Coil Voltage Code from the table below to complete the Cat. No.
 Example: 24V DC: Cat. No. **100-K05Ø400** becomes Cat. No. **100-K05ZJ400**.

Reversing Mini-Contactors — 3 N.O. Power Poles with Auxiliary Contact

Rated Operational Current I_e [A]	Ratings for switching AC motors - AC-2, AC-3, AC-4										Auxiliary Contacts per Contactor*		Cat. No.
	3Ø kW (50 Hz)				Hp (60 Hz)								
					1Ø		3Ø						
40 °C	230V	400/415V	500V	690V	115V	230V	200V	230V	460V	575V	N.O.	N.C.	
AC-1	230V	400/415V	500V	690V	115V	230V	200V	230V	460V	575V	N.O.	N.C.	
20	1.5	2.2	2.2	2.2	—	—	1-1/2	1-1/2	3	3	0	1	104-K05Ø02
20	3	4	4	4	—	—	2	2	5	5	0	1	104-K09Ø02
20	3	5.5	5.5	5.5	—	—	3	3	7-1/2	7-1/2	0	1	104-K12Ø02

- * Used for electrical interlocking
- ⊗ The Cat. No. as listed is incomplete. Select a standard Coil Voltage Code from the table below to complete the Cat. No.
 Example: 230V, 50/60 Hz: Cat. No. **104-K05Ø02** becomes Cat. No. **104-K05KF02**.

Bulletin 104-K reversing contactors are factory assembled and include contactors, mechanical interlock (Cat. No. 100-KMCH) and wiring kit (Cat. No. 100-KPR) for power and control circuit (electrical interlock).

⊗ Coil Voltage Code

The Cat. No. as listed is incomplete. Select a coil voltage code from the table below to complete the Cat. No. Example: 120V, 60 Hz:
Cat. No. 100-K09Ø10 becomes **Cat. No.100-K09D10**.

AC Voltages [V]	24	110	120	230	240	400	480	600
50 Hz	—	D	—	—	—	—	—	—
60 Hz	—	—	D	—	—	—	B	VC
50/60 Hz	KJ	—	—	KF	KA	KN	—	—























DC Voltages [V]	12	24	110	125	220	250
Standard	ZQ	ZJ	ZD	ZS	ZA	ZT
with Integrated Diode	—	DJ	—	—	—	—

For other voltages, see table on page 31



IEC Miniature Contactors

Accessories

Auxiliary Contact Blocks

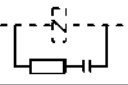
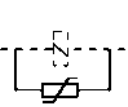
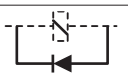

	Description	Connection Diagrams			For Use With	Pkg. Qty. *	Cat. No.	
			N.O.	N.C.				
	Front-mounted auxiliary contacts Auxiliary Contact Blocks 2- and 4-pole versions Choice of contact configurations Snap on, no tools required Electronic-compatible bifurcated contacts for signals down to 15V/2 mA Mirror Contact performance per IEC 60947-4-1		0	2	100-K05...K12⊗10	1	100-KFC02	
			1	1	100-K05...K12⊗10	1	100-KFC11	
			2	0	100-K05...K12⊗10	1	100-KFC20	
			0	4	100-K05...K12⊗10	1	100-KFC04	
			1	3	100-K05...K12⊗10	1	100-KFC13	
			3	1	100-K05...K12⊗10	1	100-KFC31	
			2	2	100-K05...K12⊗10	1	100-KFC22	
			4	0	100-K05...K12⊗10	1	100-KFC40	
				0	2	100/104-K, 700-K	1	100-KFA02E
				1	1	100/104-K, 700-K	1	100-KFA11E
			2	0	100/104-K, 700-K	1	100-KFA20E	
			0	4	100/104-K, 700-K	1	100-KFA04E	
			1	3	100/104-K, 700-K	1	100-KFA13E	
			2	2	100/104-K, 700-K	1	100-KFA22Z	
			3	1	100/104-K, 700-K	1	100-KFA31Z	
			4	0	100/104-K, 700-K	1	100-KFA40E	
		4	0	100/104-K, 700-K	1	100-KFA40E		

Control Modules

	Description	Connection Diagrams	For Use With	Pkg. Qty.	Cat. No.
	Mechanical Interlock For interlocking of two adjacent contactors No added width to contactor assembly Front mount Plug-In type Optional auxiliary contact blocks and suppressor modules mount onto the interlock		100-K, 700-K (AC & DC Control)	1	100-KMCH
	Surge Suppressor Plug-in Type Limits surge voltage on coil drop-off		100/104-K, 700-K	1 *	100-KFSC50
				1 *	100-KFSC280
				1 *	100-KFSC480
			100/104-K, 700-K	1 *	100-KFSV55
				1 *	100-KFSV136
				1 *	100-KFSV277
	100/104-K, 700-K	1 *	100-KFSD250		

* May be ordered in package quantities of 10. Add letter M to the end of the cat. no. Example: 100-KFSC50M.

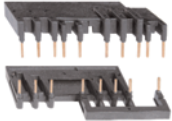



Connecting Components

	Description		For Use With	Pkg. Qty.	Cat. No.
	ECO Connecting Module For DOL and reversing starters Provides electrical and mechanical link	Connects: 140M-C circuit breakers with 100-K contactors	140M-C to 100-K	1 *	140M-C-PEK12
	Power Wiring Kit	For Reversing and Star/Delta combinations. Star-point bridge not included.	100-K	1	100-KPR
	Feeder Terminal for Compact Bus Bars	Supply of compact bus bars	100-K	1	100-KWT
	Three-Phase Compact Bus Bars	For 100-K, 5...12 A contactors 45 mm spacing (3 connections)*	100-K	1	100-KW453
		For 100-K, 5...12 A contactors 45 mm spacing (4 connections)*	100-K	1	100-KW454

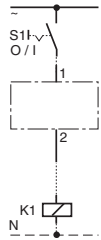

* May be ordered in package quantities of 10. Add letter M to the end of the cat. no. Example: **140M-C-PEK12M**.

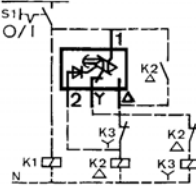
* Combinations possible. Example: For 6 contactor connections use one cat. no. 100-KW453 and one cat. no. 100-KW454.

Timers

	Description		Connection Diagrams	For Use With	Pkg. Qty.	Cat. No.	
	Solid-State Timing Element 110...250V AC or DC	On-Delay, 0.1...3 s		100/104-K, 700-K	10	100-KT3S	
		On-Delay, 1...30 s				100-KT30S	
	Star-Delta Timer	After the set time has elapsed, the K3 contactor (Y) is de-energized and then after a time of 90 ± 30 ms the K2 Contactor (Delta) is energized.		100/104-K, 700-K	10	110...120V 50/60 Hz	100-KTSDA1
		220...250V 50/60 Hz				100-KTSDA2	
		48V AC 50/60 Hz				100-KTSDA3	
	35 mm DIN Rail Mounting Adapter For easy mounting of timer modules on standard DIN Rail			100-KT	10	100-KTM	

Marking Systems

	Description	Pkg. Qty.	Cat. No.
	Label Sheet 10 sheets with 105 self-adhesive paper labels each, 6 x 17 mm	10	100-FMS
	Snap-In Hinged Marker Card	5	1492-MH6X12



Bulletin 700-K Miniature Control Relays

- IEC compact industrial relay
- IP2X Finger Protection
- Bifurcated contacts for low-level signals
- Optional integrated coil protection diode

Table of Contents

Product Selection this page
 Accessories..... 13
 Specifications..... 27
 Approximate
 Dimensions 31

Standards Compliance

IEC/EN 60947-1,-5-1,-5-4
 UL 508
 CSA 22.2. No. 14
 NF F 62-000

Approvals

CE marked
 cULus listed (File No. E33916,
 Guide No. NKCR and NKCR7)

4-Pole AC or DC Coil Voltage

AC-12		AC-15 (B600)							Connection Diagrams	Contacts		Pkg. Qty. *	Cat. No.
I_e [A]		I_e [A]								N.O.	N.C.		
40 °C	60 °C	24/48V	120V	240V	400V	500V	600V	690V					
10	6	3	3	2	1.2	1	0.6	0.6		4	0	1	700-K40E-⊗
										3	1	1	700-K31Z-⊗
										2	2	1	700-K22Z-⊗
										1+1L*	1+1L*	1	700-KL22Z-⊗

* May be ordered in package quantities of 20. Add letter M to the end of the cat. no. Example: **700-K40E-ZJM**.

* 1L = Late break N.C./early make N.O.

⊗ The Cat. No. as listed is incomplete. Select a Coil Voltage Code from the table below to complete the Cat. No.
 Example: 24V DC: Cat. No. **700-K40E-⊗** becomes Cat. No. **700-K40E-ZJ**.

⊗ Coil Voltage Code









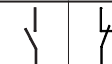

The Cat. No. as listed is incomplete. Select a coil voltage code from the table below to complete the Cat. No. Example: 120V, 60 Hz:
Cat. No. 700-K40E-⊗ becomes **Cat. No. 700-K40E-D**.

AC Voltages [V]	24	110	120	230	240	400	480	600
50 Hz	—	D	—	—	—	—	—	—
60 Hz	—	—	D	—	—	—	B	VC
50/60 Hz	KJ	—	—	KF	KA	KN	—	—

DC Voltages [V]	12	24	110	125	220	250
Standard	ZQ	ZJ	ZD	ZS	ZA	ZT
with Integrated Diode	—	DJ	—	—	—	—





For other voltages, see table on page 31

Auxiliary Contact Blocks

	Description	Connection Diagrams			For Use With	Pkg. Qty. *	Cat. No.
			N.O.	N.C.			
			0	2	100/104-K, 700-K	1	100-KFA02E
			1	1	100/104-K, 700-K	1	100-KFA11E
			2	0	100/104-K, 700-K	1	100-KFA20E
	Front-mounted auxiliary contacts Auxiliary Contact Blocks 2- and 4-pole versions Choice of contact configurations Snap on, no tools required Electronic-compatible bifurcated contacts for signals down to 15V/2 mA		0	4	100/104-K, 700-K	1	100-KFA04E
			1	3	100/104-K, 700-K	1	100-KFA13E
			2	2	100/104-K, 700-K	1	100-KFA22Z
			3	1	100/104-K, 700-K	1	100-KFA31Z
			4	0	100/104-K, 700-K	1	100-KFA40E

* May be ordered in package quantities of 10. Add letter M to the end of the cat. no. Example: **100-KFA02EM**.

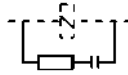
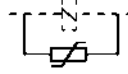

Control Modules

	Description	Connection Diagrams	For Use With	Pkg. Qty.	Cat. No.
	Mechanical Interlock For interlocking of two adjacent contactors No added width to contactor assembly Front mount Plug-In type Optional auxiliary contact blocks and suppressor modules mount onto the interlock		100-K, 700-K (AC & DC Control)	1	100-KMCH
	Surge Suppressor Plug-in Type Limits surge voltage on coil drop-off		100/104-K, 700-K	1 *	100-KFSC50
				1 *	100-KFSC280
				1 *	100-KFSC480
			100/104-K, 700-K	1 *	100-KFSV55
				1 *	100-KFSV136
				1 *	100-KFSV277
	100/104-K, 700-K	1 *	100-KFSD250		

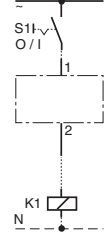

* May be ordered in package quantities of 10. Add letter M to the end of the cat. no. Example: **100-KFSC50M**.

Bulletin 700-K
IEC Miniature Control Relays
 Accessories

Timers

	Description		Connection Diagrams	For Use With	Pkg. Qty.	Cat. No.
	Solid-State Timing Element 110...250V AC or DC	On-Delay, 0.1...3 s		100/104-K, 700-K	10	100-KT3S
		On-Delay, 1...30 s				100-KT30S
	35 mm DIN Rail Mounting Adapter For easy mounting of timer modules on standard DIN Rail			100-KT	10	100-KTM

Marking Systems

	Description	Pkg. Qty.	Cat. No.
	Label Sheet 10 sheets with 105 self-adhesive paper labels each, 6 x 17 mm	10	100-FMS
	Snap-In Hinged Marker Card	5	1492-MH6X12

IEC Miniature Thermal Overload Relays

Overview/Product Selection



Bulletin 193-K — Miniature Bimetallic Overload Relays

- Standard motor protection for AC and DC motors
- Overload protection Trip Class 10A
- Auxiliary switch (1 N.O. and 1 N.C.)
- Phase loss sensitivity
- Manual/Auto reset button
- Test release
- Stop button
- Trip indicator

Bulletin 193-K bimetallic overload relays are designed for use with Bulletin 100-K contactors and Bulletin 104-K Reversing Contactors. These class 10A ambient temperature-compensated thermal overload relays include a differential mechanism for sensitivity to phase-loss conditions.

Table of Contents

Product Selection this page
 Accessories..... this page
 Specifications..... 29
 Approximate
 Dimensions 31

Conformity to Standards

IEC/EN 60947-1,-4-1,-5-1
 UL 508
 CSA 22.2. No. 14

Approvals

CE marked
 cULus listed (File No. E33916,
 Guide No. NKCR)

Miniature Bimetallic Overload Relays

Mounts to Contactor	Setting Range [A] *⊛	Max. Current Rating Backup gG Fuse [A] IEC Coordination Type		Cat. No.
		Type 1	Type 2	
100-K05...100-K12	0.10...0.16	35	—	193-KA16
	0.16...0.25	35	—	193-KA25
	0.25...0.40	35	2	193-KA40
	0.35...0.50	35	2	193-KA50
	0.45...0.63	35	2	193-KA63
	0.55...0.80	35	4	193-KA80
	0.75...1.0	35	4	193-KB10
	0.9...1.3	35	6	193-KB13
	1.1...1.6	35	6	193-KB16
	1.4...2.0	35	10	193-KB20
	1.8...2.5	35	20	193-KB25
	2.3...3.2	35	20	193-KB32
	2.9...4.0	35	20	193-KB40
	3.5...4.8	35	20	193-KB48
4.5...6.3	35	20	193-KB63	
100-K09...100-K12	5.5...7.5	35	20	193-KB75
	7.2...10.0	35	20	193-KC10
100-K12	9.0...12.5	35	20	193-KC12

* To select the setting range for use in Y-Δ Starters, multiply the rated operating current of the motor by a factor of 0.58.

⊛ For motors with Service Factor of 1.15 or greater, use motor nameplate full load current. For motors with service factor of 1.0, use 90% of the motor nameplate full load current.



Bulletin 140M Motor Protection Circuit Breakers

- Current Range 0.1...25 A
- UL Listed for motor loads
 - Short-circuit protection
 - Overload protection
- Visible trip indication
 - Additional short-circuit trip identification
- High current limiting
- High switching capacity

Bulletin 140M Motor Protection Circuit Breakers provide short-circuit and overload protection for individual motor loads. Field-installed accessories make installation and wiring easy.

Table of Contents

Product Selection.... this page
 Accessories 18

Conformity to Standards

IEC/EN 60947-1,-2,-4-1,-5-1
 UL 508
 CSA 22.2. No. 14
 NF F 62-000

Approvals

CE marked
 cULus listed (File No. E54612, Guide No. NLRV and NLRV7)

Product Selection — Motor Protection Circuit Breakers

- Short-circuit protection — standard magnetic trip (fixed at $13 \times I_n$)
- Motor overload protection — Trip Class 10



Rated Operational Current (I_n) [A]	Motor Current Adjustment Range [A]	Magnetic Trip Current [A]	Ultimate Interrupting Current [kA] (I_{cu})		Max. kW, 3-Phase				3-phase Hp Ratings [Hp]*				Cat. No.
			400V	480V	230V	400/415V	500V	690V	200V	230V	460V	575V	
C-Frame													
0.16 A	0.10...0.16	2.1	100	65	—	0.02	—	—	—	—	—	—	140M-C2E-A16
0.25 A	0.16...0.25	3.3	100	65	—	0.06	—	—	—	—	—	—	140M-C2E-A25
0.40 A	0.25...0.40	5.2	100	65	—	0.09	—	—	—	—	—	—	140M-C2E-A40
0.63 A	0.40...0.63	8.2	100	65	0.06...0.09	0.12...0.18	0.18	0.25	—	—	—	—	140M-C2E-A63
1.0 A	0.63...1.0	13	100	65	0.12	0.25	0.25...0.37	0.37...0.55	—	—	—	0.5	140M-C2E-B10
1.6 A	1.0...1.6	21	100	65	0.18...0.25	0.37...0.55	0.55...0.75	0.75...1.1	—	—	0.5...0.75	0.75	140M-C2E-B16
2.5 A	1.6...2.5	33	100	65	0.37	0.75	1.1	1.8	0.5	0.5	0.75...1	1...1.5	140M-C2E-B25
4.0 A	2.5...4.0	52	100	65	0.55...0.75	1.1...1.5	1.5...2.2	2.2...3.0	0.75	0.75	1.5...2	2...3	140M-C2E-B40
6.3 A	4.0...6.3	82	100	65	1.1...1.5	2.2	2.5...3.0	4.0	1	1...1.5	3	5	140M-C2E-B63
10 A	6.3...10	130	100	65	2.2	3.0...4.0	4.0...6.3	5.5...7.5	1.5...2	2...3	5	7.5	140M-C2E-C10
16 A	10...16	208	50	30	3.0...4.0	5.5...7.5	7.5...10	11...13	3	—	7.5...10	10	140M-C2E-C16
20 A	14.5...20	260	15	30	4.0...5.5	7.5...10	11	15...17	5	5	—	15	140M-C2E-C20
25 A	18...25	325	15	25	—	11	15	18.5...22	—	7.5	15	20	140M-C2E-C25

* Horsepower/kW ratings shown in the table above are for reference. **The final selection of the MPCB depends on the actual motor full load current and service factor.**

Motor Circuit Protectors

- Short-circuit protection — standard magnetic trip (fixed at $13 \times I_e$)
- No motor overload protection, only magnetic trip
- For Trip Class 10 motor applications*
- Separate overload relay required for motor protection



Rated Operational Current [A] (I_e)	Magnetic Trip Current [A]	Ultimate Interrupting Current [kA], (I_{cm})		3-phase kW Ratings				3-phase Hp Ratings [Hp]*				Cat. No.
		400V	480V	230V	400/415V	500V	690V	200V	230V	460V	575V	
C-Frame												
0.16 A	2.1	100	65	—	0.02	—	—	—	—	—	—	140M-C2N-A16
0.25 A	3.3	100	65	—	0.06	—	—	—	—	—	—	140M-C2N-A25
0.40 A	5.2	100	65	—	0.09	—	—	—	—	—	—	140M-C2N-A40
0.63 A	8.2	100	65	0.06...0.09	0.12...0.18	0.18	0.25	—	—	—	—	140M-C2N-A63
1.0 A	13	100	65	0.12	0.25	0.25...0.37	0.37...0.55	—	—	—	0.5	140M-C2N-B10
1.6 A	21	100	65	0.18...0.25	0.37...0.55	0.55...0.75	0.75...1.1	—	—	0.5...0.75	0.75	140M-C2N-B16
2.5 A	33	100	65	0.37	0.75	1.1	1.8	0.5	0.5	0.75-1	1...1.5	140M-C2N-B25
D-Frame												
2.5 A	33	100	65	0.37	0.75	1.1	1.8	0.5	0.5	0.75...1	1...1.5	140M-D8N-B25
4.0 A	52	100	65	0.55...0.75	1.1...1.5	1.5...2.2	2.2...3.0	0.75	0.75	1.5...2	2...3	140M-D8N-B40
6.3 A	82	100	65	1.1...1.5	2.2	2.5...3.0	4.0	1	1...1.5	3	5	140M-D8N-B63
10 A	130	100	65	2.2	3.0...4.0	4.0...6.3	5.5...7.5	1.5...2	2...3	5	7.5	140M-D8N-C10
16 A	208	100	65	3.0...4.0	5.5...7.5	7.5...10	11...13	3	—	7.5...10	10	140M-D8N-C16
25 A	325	50	65	—	11	15	18.5...22	5	5...7.5	15	15...20	140M-D8N-C25

* Horsepower/kW ratings shown in the table above are for reference. **The final selection of the manual starter depends on the actual motor full load current and service factor.**

* For Heavy Duty (exceeding Trip Class 10) starting applications, please consult your local sales office.





Bulletin 140F Fuse Holders

- Available for UL Class CC or midget fuses and IEC 10 x 38 mm fuses, with or without blown fuse indication
- Lockable in the open position
- Compatible with Bulletin 140M wiring and accessories
- Compact busbar and connectors to Bulletin 100-C and 100-K contactors
- 1 N.O./ 1N.C. auxiliary contact, early break N.C.
- Provides capability for dropping out contactor before breaking current on fuse
- Late make N.O. contact provides positive indication that power circuit is open
- Separate overload relay required for motor protection

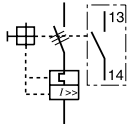
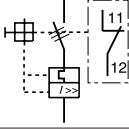

Description	Approvals				Cat. No.
	IEC	CE Mark	UL	CSA	
Fuse Holder, CC - 30 A	Yes	Yes	Yes	Yes	140F-D3C-C30
Fuse Holder with Blown Fuse Indication, CC - 30 A	Yes	Yes	Yes	Yes	140F-D3C-C30L
Fuse Holder, Midget - 30 A	Yes	Yes	Yes	Yes	140F-D3M-C30
Fuse Holder with Blown Fuse Indication, Midget - 30 A	Yes	Yes	Yes	Yes	140F-D3M-C30L
Fuse Holder, gG - 32 A	Yes	Yes	No	No	140F-D3F-C30
Fuse Holder with Blown Fuse Indication, gG - 32 A	Yes	Yes	No	No	140F-D3F-C30L
Auxiliary Contact for Fuse Holder (1 N.O. Late Make + 1 N.C. Early Break)	Yes	Yes	Yes	Yes	140F-C-AFA11

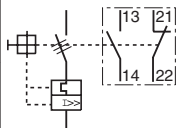
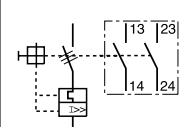
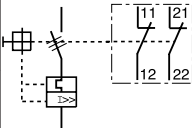

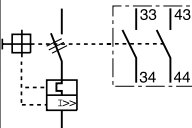
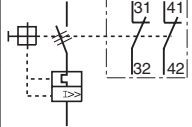
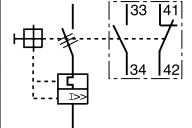
Accessories

		Description			Term. No.	Description	Connection Diagram *	For Use With	Cat. No.
		Operator Position *							
		OFF	ON	Tripped					
		O	X	O	13-14	N.O. Aux		140M-C, D, F	140M-C-AFA10
		X	O	X	11-12	N.C. Aux		140M-C, D, F	140M-C-AFA01
	Front-Mounted Auxiliary Contact 1-pole or 2-pole No additional space required - Only (1) per MPCB	O	X	O	13-14	N.O. Aux		140M-C, D, F	140M-C-AFA11
		X	O	X	21-22	N.C. Aux			140M-C-AFA02
		O	X	O	13-14	N.O. Aux		140M-C, D, F	140M-C-AFA20
		O	X	O	23-24	N.O. Aux			140M-C-AFA02
		X	O	X	11-12	N.C. Aux		140M-C, D, F	140M-C-AFA02
		X	O	X	21-22	N.C. Aux			140M-C-AFA02
	Right Side-Mounted Auxiliary Contact 2-pole Adds 9 mm to the width of the device - (2) per MPCB	O	X	O	33-34	N.O. Aux		140M-C, D, F	140M-C-ASA20
		O	X	O	43-44	N.O. Aux			140M-C-ASA02
		X	O	X	31-32	N.C. Aux		140M-C, D, F	140M-C-ASA02
		X	O	X	41-42	N.C. Aux			140M-C-ASA11
		O	X	O	33-34	N.O. Aux		140M-C, D, F	140M-C-ASA11
		X	O	X	41-42	N.C. Aux			140M-C-ASA11

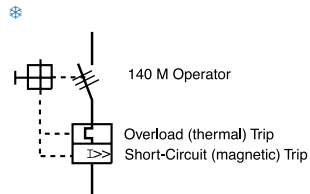
* X = Contact Closed; O = Contact Open

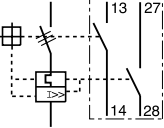
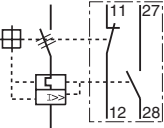

Accessories

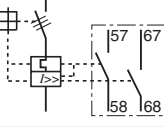
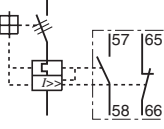
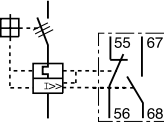
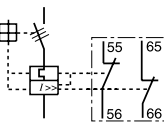
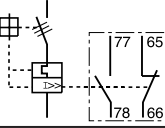



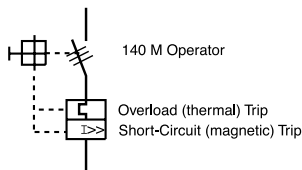

		Description					Connection Diagram *	For Use With	Cat. No.
		Operator Position *			Term. No.	Description			
		OFF	ON	Tripped					
	Front-Mounted Trip Contact 2-pole Indicates tripping of device No additional space required	O	X	O	13-14	N.O. Aux		140M-C, D, F	140M-C-AFAR10A10
		O	O	X	27-28	N.O. Trip (Short-Circuit & Overload)			
		X	O	X	11-12	N.C. Aux		140M-C, D, F	140M-C-AFAR10A01
		O	O	X	27-28	N.O. Trip (Short-Circuit & Overload)			
	Right-Side Mounted Trip Contact 2-pole Indicates tripping of Motor Protection Circuit Breaker Adds 9 mm to the width of the circuit breaker - Only (1) per MPCB - A Right-Side mounted Auxiliary Contact may be tandem mounted on top of this Trip Contact	O	O	X	57-58	N.O. Trip (Short-Circuit & Overload)		140M-C, D, F	140M-C-ASAR10M10
		O	O	X	67-68	N.O. Trip			
		O	O	X	57-58	N.O. Trip (Short-Circuit & Overload)		140M-C, D, F	140M-C-ASAR10M01
		X	X	O	65-66	N.C. Trip			
		X	X	O	55-56	N.C. Trip (Short-Circuit & Overload)		140M-C, D, F	140M-C-ASAR01M10
		O	O	X	67-68	N.O. Trip			
		X	X	O	55-56	N.C. Trip (Short-Circuit & Overload)		140M-C, D, F	140M-C-ASAR01M01
		X	X	O	65-66	N.C. Trip			
		O	O	X	77-78	N.O. Trip (Short-Circuit)		140M-C, D, F	140M-C-ASAM11
		X	X	O	65-66	N.C. Trip (Short-Circuit)			

* X = Contact Closed; O = Contact Open

*



Bulletin 140M
IEC Circuit Breakers
 Accessories



	Description	For Use With	Cat. No.	
	ECO Connecting Module For DOL and reversing starters Provides electrical and mechanical link	140M-C to 100-K	140M-C-PEK12	
	Spacing Adapter Required for Self-Protected combination motor controller (Type E) applications of 140M-C, -D, and -F MPCBs	140M-C, -D	140M-C-TE1	
	Compact Busbar Feeder Block Supply of compact busbars Increases terminal capacity	140M-C, -D	140M-C-WBE	
	Compact Busbar Feeder Terminal For supply of commoning links Top feed — overlaps commoning link Meets UL Type E spacing requirements	140M-C, -D	140M-C-WTE	
	Three-Phase Compact Busbar for 25 A Motor Protection Circuit Breakers — 63 A Max. Continuous Current 45 mm spacing For use with front-mounted auxiliary contact	2 connections	140M-C, -D	140M-C-W452
		3 connections		140M-C-W453
		4 connections		140M-C-W454
		5 connections		140M-C-W455
	Three-Phase Compact Busbar for 25 A Motor Protection Circuit Breakers — 63 A Max. Continuous Current 54 mm spacing For use with side-mounted auxiliary contact	2 connections	140M-C, -D	140M-C-W542
		3 connections		140M-C-W543
		4 connections		140M-C-W544
		5 connections		140M-C-W545
	Three-Phase Compact Busbar for 25 A Motor Protection Circuit Breakers — 63 A Max. Continuous Current 63 mm spacing For use with side-mounted undervoltage trip and shunt trip	2 connections	140M-C, -D	140M-C-W632
		3 connections		140M-C-W633
		4 connections		140M-C-W634
		5 connections		140M-C-W635
	Jumper for 140M-D to 140M-C Accommodates difference in depth from 140M-D to 140M-C 54 mm spacing Can be used with all other commoning links	2 connections	140M-D to 140M-C	140M-C-WD542

For complete list of available 140M accessories, please consult the Allen-Bradley **Industrial Controls** main catalog.

	<p>Modular Eco Starter Component Selection</p> <ul style="list-style-type: none"> • Power Range 0.1...12 A • Modular Eco Starter using Bulletin 140M Motor Protection Circuit Breaker and Bulletin 100-K Mini Contactors • Mounting Options: Snap Fixing on (1) 35 mm DIN Rail 	<p>Table of Contents</p> <p>Product Selection this page</p>
---	--	---

Use the chart to select components based on motor application data.

Mini Starters

Motor Current Adjustment Range [A]	Type 1 Coordination								DOL- and Reversing-Starters *		
	Max. Hp (60 Hz)				Max. kW (50 Hz)				Contactor	Eco Starter Module	Circuit Breaker
	200V	230V	460V	575V	230V	400V	500V	690V			
	C-Frame and 100-K Mini Contactors										
0.1...0.16	—	—	—	—	—	0.02	—	—	100-K05⊗..	140M-C-PEK12	140M-C2E-A16
0.16...0.25	—	—	—	—	0.02	0.06	0.06	—	100-K05⊗..	140M-C-PEK12	140M-C2E-A25
0.25...0.4	—	—	—	—	0.06	0.09	0.12	—	100-K05⊗..	140M-C-PEK12	140M-C2E-A40
0.4...0.63	—	—	—	—	0.09	0.18	0.18	—	100-K05⊗..	140M-C-PEK12	140M-C2E-A63
0.63...1.0	—	—	—	1/2	0.12	0.25	0.37	0.25	100-K05⊗..	140M-C-PEK12	140M-C2E-B10
1.0...1.6	—	—	0.5...0.75	3/4	0.25	0.55	0.75	0.37...0.55	100-K05⊗..	140M-C-PEK12	140M-C2E-B16
1.6...2.5	1/2	1/2	0.75...1	1...1.5	0.55	0.75	1.1	0.75...1.1	100-K05⊗..	140M-C-PEK12	140M-C2E-B25
2.5...4.0	3/4	3/4	1.5...2	2...3	0.75	1.5	1.8	1.8	100-K05⊗..	140M-C-PEK12	140M-C2E-B40
4.0...6.3	1	1...1.5	3	5	1.5	2.2	2.2	4	100-K09⊗..	140M-C-PEK12	140M-C2E-B63
6.3...10	1.6...2	2	5	7.5	2.2	4	4	—	100-K12⊗..	140M-C-PEK12	140M-C2E-C10
10...16	3	—	7 1/2	—	4	5.5	—	—	100-K12⊗..	140M-C-PEK12	140M-C2E-C16

* Reversing Starters using 2 contactors 100-K..⊗01 and power wiring kit 100-KPR and if needed mechanical interlock 100-KMCH in addition. Horsepower and Kilowatt ratings shown in the table are for reference. Final selection of the starter depends upon the actual motor full-load current and service factor.

⊗ **Coil Voltage Code**

The Cat. No. as listed is incomplete. Select a coil voltage code from the table below to complete the Cat. No. Example: 120V, 60 Hz: **Cat. No. 100-K09⊗10** becomes **Cat. No.100-K09D10**.

AC Voltages [V]	24	110	120	230	240	400	480	600
50 Hz	—	D	—	—	—	—	—	—
60 Hz	—	—	D	—	—	—	B	VC
50/60 Hz	KJ	—	—	KF	KA	KN	—	—

DC Voltages [V]	12	24	110	125	220	250
Standard	ZQ	ZJ	ZD	ZS	ZA	ZT
with Integrated Diode	—	DJ	—	—	—	—

For other voltages, see table on page 31

Bulletin 100-K
IEC Miniature Contactors
 Specifications

IEC Specifications

		100/104-K		
		05	09	12
AC-1 Active Power Load (50 Hz); Ambient temperature 40°C				
I_e	≤ 690V [A]	20	20	20
	230V [kW]	8	8	8
	240V [kW]	8.3	8.3	8.3
	400V [kW]	14	14	14
	415V [kW]	14	14	14
	500V [kW]	17	17	17
	690V [kW]	24	24	24
Ambient temperature 60°C				
I_e	≤ 690V [A]	16	16	16
	230V [kW]	6.4	6.4	6.4
	240V [kW]	6.7	6.7	6.7
	400V [kW]	11	11	11
	415V [kW]	12	12	12
	500V [kW]	14	14	14
	690V [kW]	19	19	19
Switching of 3-phase Motors; (50 Hz) Ambient temperature 60°C, AC-2, AC-3, AC-4				
	230V [A]	6.3	11.3	11.3
	240V [A]	6.3	11.3	11.3
	400V [A]	4.9	8.5	11.5
	415V [A]	4.9	8.5	11.5
	500V [A]	3.9	6.8	9.2
	690V [A]	2.8	4.9	6.7
	230V [kW]	1.5	3	3
	240V [kW]	1.5	3	3
	400V [kW]	2.2	4	5.5
	415V [kW]	2.2	4	5.5
	500V [kW]	2.2	4	5.5
	690V [kW]	2.2	4	5.5
AC-4 at approximately 200,000 operations				
	230V [A]	2.3	3.9	3.9
	240V [A]	2.3	3.9	3.9
	400V [A]	2	3.6	3.6
	415V [A]	2	3.6	3.6
	500V [A]	1.9	3.2	3.2
	690V [A]	—	—	—
	230V [kW]	0.37	0.75	0.75
	240V [kW]	0.37	0.75	0.75
	400V [kW]	0.75	1.5	1.5
	415V [kW]	0.75	1.5	1.5
	500V [kW]	0.75	1.5	1.5
	690V [kW]	—	—	—
Max. switching frequency	Ops/h	250	250	250

		100/104-K		
		05	09	12
Star-Delta Starting (50 Hz)				
	≤ 230V [A]	11.3	20	20
	≤ 240V [A]	11.3	20	20
	400V [A]	8.5	15.5	15.5
	415V [A]	8.5	15.5	15.5
	500V [A]	6.8	12.4	12.4
	690V [A]	4.9	8.9	8.9
	230V [kW]	3	5.5	5.5
	240V [kW]	3	5.5	5.5
	400V [kW]	4	7.5	7.5
	415V [kW]	4	7.5	7.5
	500V [kW]	4	7.5	7.5
	690V [kW]	4	7.5	7.5
Load Carrying Capacity per UL/CSA				
General Purpose Current (enclosed)				
	[A]	12	15	18
Rated power (enclosed)				
1-phase (100-K)	115V [A]	9.8	9.8	13.8
	230V [A]	8	10	12
	115V [Hp]	0.5	0.5	0.75
	230V [Hp]	1	1.5	2
3-phase	200V [A]	6.9	7.8	11
	230V [A]	6	6.8	9.6
	460V [A]	4.8	7.6	11
	575V [A]	3.9	6.1	9
	200V [Hp]	1.5	2	3
	230V [Hp]	1.5	2	3
	460V [Hp]	3	5	7.5
	575V [Hp]	3	5	7.5
Wye-Delta (60 Hz)				
	200V [Hp]	2.5	3.3	5
	230V [Hp]	2.5	3.3	5
	460V [Hp]	5	8.5	12
	575V [Hp]	5	8.5	12

IEC Specifications



			100/104-K		
			05	09	12
Switching of Power Transformers, AC-6a (50 Hz)					
Inrush Current	= n				
Rated transformer current					
n = 30	≤ 230V [A]	2.9	5.4	5.4	
	≤ 240V [A]	2.9	5.4	5.4	
	≤ 400V/415V [A]	2.4	4.1	5.4	
	≤ 500V [A]	1.8	3.2	3.2	
	≤ 690V [A]	—	—	—	
	230V [kVA]	1.2	2	2	
	240V [kVA]	1.2	2	2	
	400V [kVA]	1.7	2.8	3.4	
	415V [kVA]	1.7	2.8	3.4	
	500V [kVA]	1.7	2.8	3.4	
	690V [kVA]	2	4	5	
n = 20	≤ 690V [A]	—	—	—	
n = 15	≤ 690V [A]	—	—	—	
Switching of Lamps					
Gas discharge lamps AC-5a 220...240V AC (40 °C)	open [A]	18	18	18	
	closed [A]	14.5	14.5	14.5	
Individually compensated:					
Max. capacitance at expected					
Short-circuit current of	10 kA [μF]	750	750	750	
	20 kA [μF]	400	400	400	
	50 kA [μF]	—	—	—	
Filament AC-5b	230/240V [A]	5	9	9	
Switching of Low Inductive Loads in Home Appliances and Similar Applications per IEC 61095 (50 Hz)					
AC-7a	230V [A]	20	20	20	
	400V [A]	20	20	20	
Switching of Motor Load for Home Appliances (50 Hz)					
AC-7b	230V [A]	6	11	11	
	400V [A]	6	11	11	
Switching of hermetically encapsulated cooling compressor motors with manual reset of the overload release					
AC-8a	400V [A]	11	18	18	
	500V [A]	10	15	15	

Specifications

			100/104-K		
			05	09	12
Switching of DC Loads					
Non-inductive/slightly inductive loads or resistance furnaces DC-1 at 60 °C					
1 pole (100-K)	24V [A]	6	9	9	
	48/60V [A]	4/1	6/1.5	6/1.5	
	110V [A]	0.6	1	1	
	220V [A]	0.2	0.3	0.3	
2 poles in series	24V [A]	0.08	0.1	0.1	
	48/60V [A]	6	9	9	
	110V [A]	4	6	6	
	220V [A]	0.8	1.2	1.2	
3 poles in series	24V [A]	0.2	0.3	0.3	
	48/60V [A]	6	9	9	
	110V [A]	6	9	9	
	220V [A]	3	4	4	
	440V [A]	0.4	0.6	0.6	
Shunt-wound Motors					
Starting, reverse current braking, reversing, stepping DC-3, 60 °C					
3 poles in series	24V [A]	5	9	9	
	48/60V [A]	4	6	6	
	110V [A]	2	3	3	
	220V [A]	0.8	1.2	1.2	
	440V [A]	0.15	0.2	0.2	
Series-wound Motors					
Starting, reverse current braking, reversing, stepping DC-5, 60 °C					
3 poles in series	24V [A]	5	9	9	
	48/60V [A]	2	3	3	
	110V [A]	0.6	1	1	
	220V [A]	0.1	0.1	0.1	
	440V [A]	—	—	—	
Short Time Withstand I_{CW}, 60 °C					
	10 s [A]	60	96	96	
Resistance and Power Dissipation					
Main current circuit resistance, 1 pole	[mΩ]	2.2	2.2	2.2	
Power dissipation, 3 main poles I_e AC-3/400V		0.3	0.9	0.9	
Total power dissipation					
At I_e AC-3/400V	AC control, warm [W]	2.1	2.7	2.7	
	DC control, warm [W]	2.9	3.5	3.5	
Lifespan					
Mechanical	[Mio. op.]	15	15	15	
Electrical AC-3 (400 V)	[Mio. op.]	0.7	0.7	0.7	
Reversing combination mechanical, electrical	[Mio. op.]	0.7	0.7	0.7	
Weight					
AC	DOL kg (lbs.)	0.16 (0.35)	0.16 (0.35)	0.16 (0.35)	
	Reversing kg (lbs.)	—	—	—	
DC	DOL kg (lbs.)	0.2 (0.44)	0.2 (0.44)	0.2 (0.44)	
	Reversing kg (lbs.)	—	—	—	

Bulletin 100-K
IEC Miniature Contactors
 Specifications

Cross Sections, Srew Type Terminals

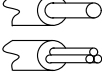
Conductor Cross Sections - Main Contacts and Auxiliary Contacts				100/104-K		
				05	09	12
Terminal type				* 		
	Fine stranded with ferrule	(1) Conductor (2) Conductors	[mm ²] [mm ²]	0.75...2.5 0.75...2.5		
	Solid or coarse stranded	(1) Conductor (2) Conductors	[mm ²] [mm ²]	1...4 0.75...2.5 + 1...4		
Recommended torque				[Nm]	1.2	
Cross section per UL/CSA				[AWG]	18...12 *	
Recommended torque				[lb-in]	10.6	

* Pozidriv No. 2 / Blade No. 3 screw
 * Use same cross sections



Coil Data

				100/104-K		
				05	09	12
Operating Limits						
AC control 50 Hz, 60 Hz, 50/60 Hz	pick-up	[x U _s]	0.85...1.1			
	dropout	[x U _s]	0.2...0.75			
DC control	pick-up	[x U _s]	0.8...1.1 9, 12, 24, 110V DC: 0.7...1.25			
	dropout	[x U _s]	0.1...0.75			
Coil Consumption						
AC control 50 Hz, 60 Hz, 50/60 Hz	pick-up	[VA/W]	35/32			
	hold-in	[VA/W]	5/1.8			
DC control	pick-up	[W]	cold 3.0, warm 2.6			
	hold-in	[W]	cold 3.0, warm 2.6			
Operating Times						
AC	closing delay	[ms]	15...40			
	opening delay	[ms]	15...33			
With RC module	opening delay	[ms]	15...28			
DC	closing delay	[ms]	18...40			
	opening delay	[ms]	6...12			
With integrated diode	opening delay	[ms]	8...12			
With external diode	opening delay	[ms]	35...50			
Minimal change over-time for reversing		[ms]	>50			

Short Circuit Coordination

		100/104-K		
		05	09	12
Short Circuit Coordination (Max. Fuse or Circuit Breaker Rating)				
Per IEC 60947-4-1 (contactor and fuses only)				
DIN Fuses - gG		50 kA Available Fault Current		
Type "1" (690V)	[A]	35	35	35
Type "2" (690V)	[A]	16	20	20

Auxiliary Contacts and Auxiliary Contact Blocks

		Auxiliary contacts	
		Internal (100-K)	Blocks (100-KF)
Switching of AC Loads			
AC-12 I _{th}	at 40°C [A]	10	10
	at 60°C [A]	6	6
AC-15 at rated voltage of			
	24V [A]	6	3
	120V [A]	6	3
	240V [A]	3	2
	400V [A]	1.8	1.2
	480V [A]	1.5	1
	500V [A]	1.4	1
	600V [A]	1.2	0.6
	690V [A]	1	0.6
Switching of DC Loads			
DC-12 L/R < 1 ms resistive loads at			
	24V DC [A]	6	—
	48V DC [A]	4	—
	110V DC [A]	0.6	—
	125V DC [A]	0.6	—
	220V DC [A]	0.2	—
	250V DC [A]	0.2	—
	400V DC [A]	0.08	—
	440V DC [A]	0.08	—
DC-14 L/R < 15 ms inductive loads with economy resistor in series at			
	24V DC [A]	4	—
	48V DC [A]	2.5	—
	110V DC [A]	0.4	—
	125V DC [A]	0.4	—
	220V DC [A]	0.12	—
	250V DC [A]	0.12	—
	400V DC [A]	0.05	—
	440V DC [A]	0.05	—
DC-13 switching electromagnets at			
	24V DC [A]	2.8	2.3
	48V DC [A]	1.2	1
	110V DC [A]	0.55	0.55
	125V DC [A]	0.55	0.55
	220V DC [A]	0.27	0.27
	250V DC [A]	0.27	0.27
	400V DC [A]	0.15	0.15
	440V DC [A]	0.15	0.15
	600V DC [A]	0.1	0.1
Fuse gG			
Short-circuit protection with no Welding of contacts per IEC 60947-5-1			
	 [A]	10	10
	 [A]	10	10
Protective Separation per IEC 60947-1, Annex N			
	Min. switching capacity 15V IEC 60947-5-4 [mA]	—	2
Load Carrying Capacity per UL/CSA			
Rated voltage	AC [V]	max. 600	max. 600
Continuous rating	40 °C [A]	10	10
Switching capacity	AC [A]	A 600	B 600
Rated voltage	DC [V]	max. 600	max. 600
Switching capacity	DC [A]	Q 600	Q 600

General Data

Rated Isolation Voltage U_i		
IEC [V]		690
UL, CSA [V]		600
Rated Impulse Voltage Withstand U_{imp} [kV]		6
Rated Operating Voltage U_e		
AC 50/60 Hz [V]		230, 240, 400, 415, 500, 690
DC [V]		24, 48, 110, 220, 440
Insulation Class of the Coil	Class F according to IEC 60085, Class 105 insulation system according to UL 508	
Rated coil frequency	AC 50/60 Hz, DC	
Ambient Temperature		
Storage [°C]	-55...+80	
Operation at rated voltage [°C]	-25...+60	
at 70°C	15% current reduction against 60°C values	
Climatic Withstand	IEC 68-2/EN 60068	
Max. Altitude of Installation Site [m]	2000 NN	
Protection Class		
Single contactor cover	—	
Contactors with frame terminal block	—	
Auxiliary contact	IP2X	
Resistance to Shock	IEC 68-2/EN 60068	
Resistance to Vibration	IEC 68-2/EN 60068	
Mechanically Linked Contacts IEC 60947-5-1, Annex L	100-K (on main unit)	
Mirror Contacts IEC 60947-4 Annex F	100-K and 100-KF	
Standards	IEC/EN 60947-1, -4-1, -5-1, -5-4, UL 508, CSA 22.2. No. 14	
Approvals	CE, cULus	

Life-Load Curves

Electrical life; $U_e = 400...460V$ AC

AC-3

Switching of squirrel-cage motors while starting

AC-1

Non- or slightly inductive loads, resistance furnaces

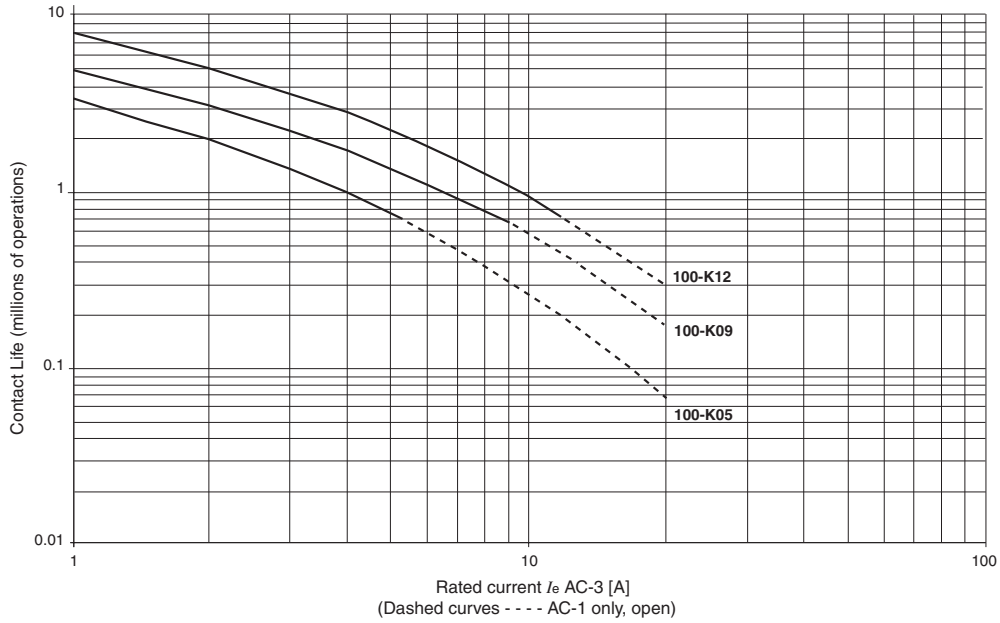

Electrical life; $U_e = 400...460V$ AC

AC-4

Stepping of squirrel-cage motors

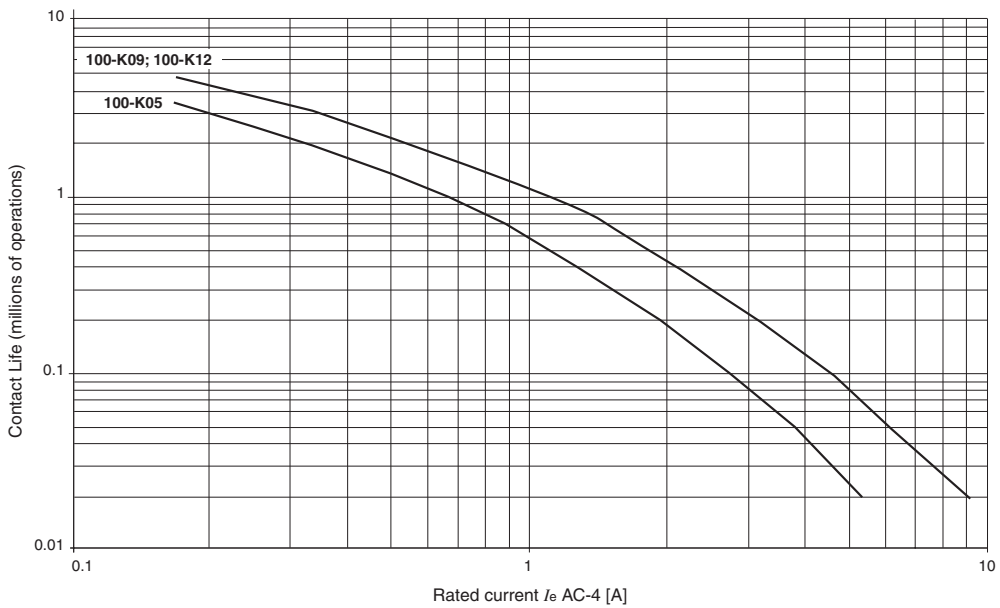

IEC Specifications

			700-K
AC-12 Rated Thermal Current			
Ambient temperature 40°C			
I_{th}	24...240V	[A]	10
	230...500V	[A]	10
	230...690V	[A]	10
Ambient temperature 60°C			
I_{th}	24...240V	[A]	6
	230...500V	[A]	6
	230...690V	[A]	6
AC-15/B600			
Switching of Solenoids and contactors			
	24V	[A]	3
	48V	[A]	3
	120V	[A]	3
	230V	[A]	2
	240V	[A]	2
	400V	[A]	1.2
	480V	[A]	1
	500V	[A]	1
	600V	[A]	0.6
	690V	[A]	0.6
Short-circuit Protection			
"gG" Fuse acc. to IEC 60947-5-1, no welding of contacts			
	Fuse gG	[A]	10
Min. Switching Capacity 15V			
For bifurcated contacts (control relays and auxiliary contact blocks)			
		[mA]	2
Resistance and Power Dissipation			
Main current circuit resistance, 1 pole		[mΩ]	6.5
Power dissipation I_{th} , 4 poles		[W]	2.6
Total power dissipation			
I_{th}	AC control, warm	[W]	4.4
	DC control, warm	[W]	5.2
Lifespan			
Mechanical		[Mio. op.]	15
Electrical AC-15 (240V / 2 A)		[Mio. op.]	0.7
Weight			
	AC control	kg (lbs.)	0.16 (0.35)
	DC control	kg (lbs.)	0.2 (0.44)
Load Carrying Capacity per UL/CSA			
Rated voltage	AC	[V]	max. 600
Continuous rating	40 °C	[A]	10
Switching capacity	AC	[A]	B 600
Rated voltage	DC	[V]	max. 600
Switching capacity	DC	[A]	Q 600



			700-K
Continuous Current			
(General Purpose)	300V AC	[A]	5
	600V AC	[A]	10
DC-13/Q600			
1 pole	24V	[A]	2.3
	48V	[A]	1
	110V	[A]	0.55
	125V	[A]	0.55
	220V	[A]	0.27
	250V	[A]	0.27
	400V	[A]	0.15
	440V	[A]	0.15
	600V	[A]	0.1

Bulletin 700-K

IEC Miniature Control Relays

Specifications

Cross Sections, Srew Type Terminals

Conductor Cross Sections - Main Contacts and Auxiliary Contacts				700-K
Terminal type				* 
	Fine stranded with ferrule	(1) Conductor (2) Conductors	[mm ²] [mm ²]	0.75...2.5 0.75...2.5
	Solid or coarse stranded	(1) Conductor (2) Conductors	[mm ²] [mm ²]	1...4 0.75...2.5 + 1...4
Recommended torque			[Nm]	1.2
Cross section per UL/CSA			[AWG]	18...12 *
Recommended torque			[lb-in]	10.6

* Pozidriv No. 2 / Blade No. 3 screw

* Use same cross sections

Coil Data



			700-K
Operating Limits			
AC control 50 Hz, 60 Hz, 50/60 Hz	pick-up	[x U _s]	0.85...1.1
	dropout	[x U _s]	0.2...0.75
DC control	pick-up	[x U _s]	0.8...1.1 9, 12, 24, 110V DC: 0.7...1.25
	dropout	[x U _s]	0.1...0.75
Coil Consumption			
AC control 50 Hz, 60 Hz, 50/60 Hz	pick-up	[VA/W]	35/32
	hold-in	[VA/W]	5/1.8
DC control	pick-up	[W]	cold 3.0, warm 2.6
	hold-in	[W]	cold 3.0, warm 2.6
Operating Times			
AC	closing delay	[ms]	15...40
	opening delay	[ms]	15...33
With RC module	opening delay	[ms]	15...28
DC	closing delay	[ms]	18...40
	opening delay	[ms]	6...12
With integrated diode	opening delay	[ms]	8...12
With external diode	opening delay	[ms]	35...50

General Data

		700-K
Rated Isolation Voltage U_i		
IEC	[V]	690
UL, CSA	[V]	600
1 minute acc. to IEC 60947-5-1	[V]	—
Rated Impulse Voltage Withstand U_{imp}	[kV]	6
Rated Operating Voltage U_e		
AC 50/60 Hz	[V]	24, 48, 120, 230, 400, 500, 600, 690
DC	[V]	24, 48, 110, 220, 440
Rated Coil Frequency		
AC 50/60 Hz, DC		
Ambient Temperature		
Storage	[°C]	-55...+80
Operation at rated voltage	[°C]	-25...+60
at 70°C		15% current reduction against 60°C values
Climatic Withstand		
—		
Max. Altitude of Installation Site	[m]	2000 NN
Protection Class		
IP2X		
Auxiliary contact		
—		
Standards		
IEC/EN 60947-1, -5-1, -5-4, UL 508, CSA 22.2. No. 14		
Approvals		
CE, cULus		

Specifications

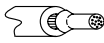

Main Circuits

		193-K
Rated Isolation Voltage U_i		690V
Rated Impulse Strength U_{imp}		6 kV
Rated Operating Voltage U_e	IEC/UL	690V AC / 600V AC
Wiring cross section Terminal type		
Terminal screws		M3.5
	Fine stranded with ferrule [mm ²]	2 x (1.5...4)
	Solid or coarse stranded [mm ²] [AWG]	2 x (1.5...4) 2 x (16...10)
Recommended torque	[Nm] [lb-in]	1.2 10.6
Pozidriv screwdriver	Size	2
Slotted screwdriver	[mm]	1 x 6

Environmental Ratings

		193-K
Ambient Temperature	Storage Operating	-55...+80 °C (-67...+176 °F) -20...+60 °C (-4...+140 °F)
Humidity	Operating Damp Heat	5...95 % Non-condensing per IEC 68-2-3 and IEC 68-2-30
Vibration (per IEC 68-2-6)		3G
Shock (per IEC 68-2-27)		30G
Max. Altitude		2000 m
Pollution Environment		Pollution Degree 3
Degree of Protection		IP2X
Protection		
Type of Relay		Ambient Compensated, Time Delay, Phase Loss Sensitive
Nature of Relay		Bimetallic Overload Relay
Trip Rating		120 % FLA
Trip Class		IEC: 10A, UL 10
Reset Mode		Automatic or Manual
Power dissipation	up to 0.4 A	7 W
	0.5...12.5 A	6 W

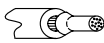
Control Circuits

		193-K
Rated Isolation Voltage U_i		690V AC
Rated Impulse Strength U_{imp}		4 kV AC
Rated Operating Voltage U_e	IEC/UL	690V AC / 600V AC
Rating Designation		A600 / Q300
Rated Operating Current I_e		N.O./N.C.
AC-15	24V [A]	4
	240V [A]	2
	400V [A]	1.6
	690V [A]	0.15
DC-13	24V [A]	2
	110V [A]	0.4
	220V [A]	0.25
	440V [A]	0.08
Thermal Current I_{the}	[A]	5
Short-circuit withstand, fuse gG	[A]	6
Contact Reliability		15V, 2 mA
Wiring cross section Terminal type		
Terminal screw		M 3.5
	Fine stranded with ferrule [mm ²]	2 x (1...4)
	Solid or coarse stranded [mm ²] [AWG]	2 x (1...4) 2 x (18...12)
Recommended torque	[Nm] [lb-in]	1.2 10.6
Pozidriv screwdriver	Size	2
Slotted screwdriver	[mm]	1 x 6

General Data

		193-K
Standards		IEC/EN 60947-1, -4-1, -5-1, UL 508, CSA 22.2. No. 14
Certifications		CE, cULus
Approximate Weights (unpacked)		0.115 kg (0.25 lb)

Bulletin 193-K
IEC Miniature Thermal Overload Relays
 Specifications

Thermal Overload Relays

Circuit Diagrams

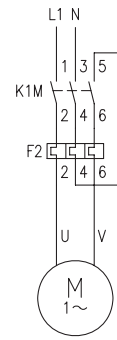
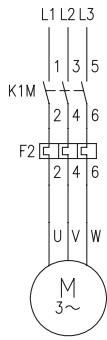

Trip Characteristics

These trip characteristics refer to IEC 60947 and are average values from cold start at an ambient temperature of 20 °C. Trip time is pictured as a function of operating current. With the device at normal operating temperature, the trip time decreases to approximately 25% of the shown value.

Trip Class 10A

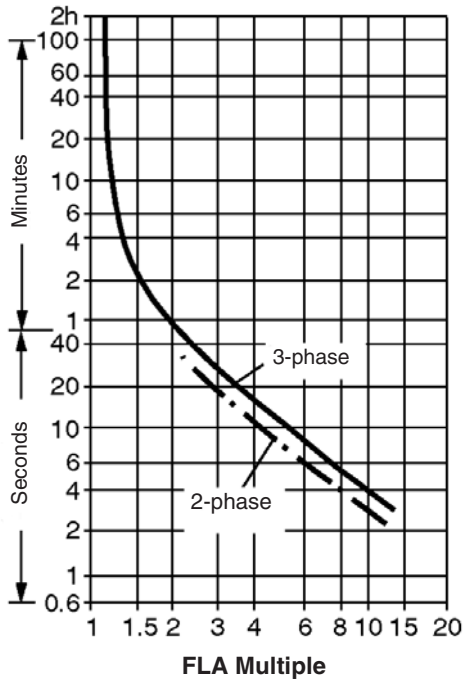

⊗ **Coil Voltage Codes**

AC Coil Voltages			
[V]	50 Hz	60 Hz	50/60 Hz
12	—	—	KQ
24	—	—	KJ (WJ)*
32	—	—	VU
36	—	—	KV
42	—	—	KW
48	—	—	KY
60	—	—	KR
70	—	—	VG
110	D (WD)*	—	—
120	—	D (WD)*	—
127	—	—	VS
135	—	—	VE
200	KG	—	—
200-220	—	—	KG
230	—	—	KF (WF)*
240	—	—	KA
250	—	—	VT
380-400	N	—	—
400	—	—	KN
415	—	—	KU
440	B	—	—
480	—	B	—
500	M	—	—
525	VC	—	—
575	—	M	—
600	—	VC	—

DC Coil Voltages	
[V]	DC
9	ZR
12	ZQ
24	ZJ (DJ)*
30	ZC
36	ZW
48	ZY
60	ZZ
72	ZG
80	ZE
110	ZD
120	ZU
125	ZS
220	ZA
240	ZL
250	ZT

* (DJ): with integrated Diode

Voltage codes in bold are preferred products. For availability of other voltage codes, please consult your local Allen-Bradley distributor or representative.

* (Wx): with built-in Varistor

Bulletin 100-K, 700-K, 193-K Approximate Dimensions

Dimensions are shown in millimeters (inches). Dimensions are not intended for manufacturing purposes.

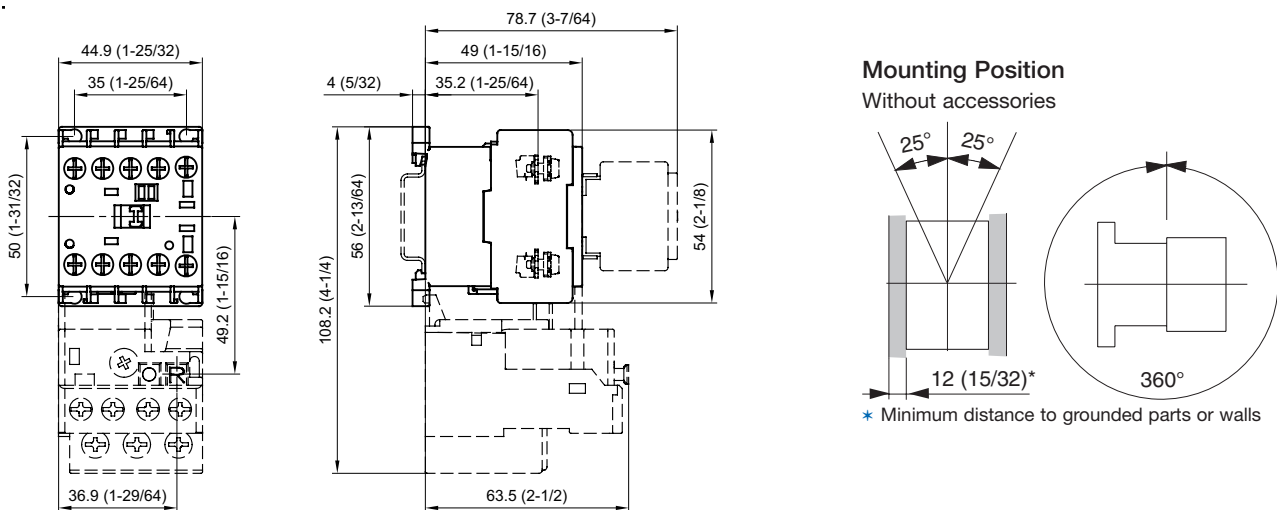

Mounting Position

Without accessories

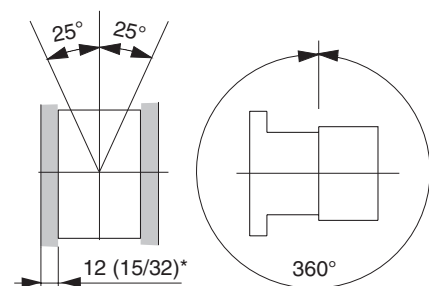

* Minimum distance to grounded parts or walls

General Terms and Conditions of Sale

TERMS AND CONDITIONS

«General Terms and Conditions of Sale» can be found in publication «6500(EN) - January 2004». This publication is available as a PDF file (Adobe Acrobat) at <http://www.rockwellautomation.com/termsofsale>

www.rockwellautomation.com

Power, Control and Information Solutions Headquarters

Americas: Rockwell Automation, 1201 South Second Street, Milwaukee, WI 53204-2496 USA, Tel: (1) 414.382.2000, Fax: (1) 414.382.4444

Europe/Middle East/Africa: Rockwell Automation, Vorstlaan/Boulevard du Souverain 36, 1170 Brussels, Belgium, Tel: (32) 2 663 0600, Fax: (32) 2 663 0640

Asia Pacific: Rockwell Automation, Level 14, Core F, Cyberport 3, 100 Cyberport Road, Hong Kong, Tel: (852) 2887 4788, Fax: (852) 2508 1846