



PLX82-EIP-PNC

Communication Gateway

EtherNet/IP™ Server to PROFINET
Controller

May 29, 2017

Your Feedback Please

We always want you to feel that you made the right decision to use our products. If you have suggestions, comments, compliments or complaints about our products, documentation, or support, please write or call us.

How to Contact Us

ProSoft Technology, Inc.
9201 Camino Media, Suite 200
Bakersfield, CA 93311
+1 (661) 716-5100
+1 (661) 716-5101 (Fax)
www.prosoft-technology.com
support@prosoft-technology.com

PLX82-EIP-PNC User Manual
Rev 1.0.0

May 29, 2017

ProSoft Technology® is a registered copyright of ProSoft Technology, Inc. All other brand or product names are or may be trademarks of, and are used to identify products and services of, their respective owners.

In an effort to conserve paper, ProSoft Technology no longer includes printed manuals with our product shipments. User Manuals, Datasheets, Sample Ladder Files, and Configuration Files are provided at our website:
www.prosoft-technology.com

Content Disclaimer

This documentation is not intended as a substitute for and is not to be used for determining suitability or reliability of these products for specific user applications. It is the duty of any such user or integrator to perform the appropriate and complete risk analysis, evaluation and testing of the products with respect to the relevant specific application or use thereof. Neither ProSoft Technology nor any of its affiliates or subsidiaries shall be responsible or liable for misuse of the information contained herein. Information in this document including illustrations, specifications and dimensions may contain technical inaccuracies or typographical errors. ProSoft Technology makes no warranty or representation as to its accuracy and assumes no liability for and reserves the right to correct such inaccuracies or errors at any time without notice. If you have any suggestions for improvements or amendments or have found errors in this publication, please notify us.

No part of this document may be reproduced in any form or by any means, electronic or mechanical, including photocopying, without express written permission of ProSoft Technology. All pertinent state, regional, and local safety regulations must be observed when installing and using this product. For reasons of safety and to help ensure compliance with documented system data, only the manufacturer should perform repairs to components. When devices are used for applications with technical safety requirements, the relevant instructions must be followed. Failure to use ProSoft Technology software or approved software with our hardware products may result in injury, harm, or improper operating results. Failure to observe this information can result in injury or equipment damage.

Copyright © 2017 ProSoft Technology, Inc. All Rights Reserved.

Printed documentation is available for purchase. Contact ProSoft Technology for pricing and availability.

North America: +1 (661) 716-5100
Asia Pacific: +603.7724.2080
Europe, Middle East, Africa: +33 (0) 5.3436.87.20
Latin America: +1.281.298.9109

Important Safety Information

Power, Input, and Output (I/O) wiring must be in accordance with Class I, Division 2 wiring methods, Article 501-4 (b) of the National Electrical Code, NFPA 70 for installation in the U.S., or as specified in Section 18-1J2 of the Canadian Electrical Code for installations in Canada, and in accordance with the authority having jurisdiction. The following warnings must be heeded:

North America Warnings

- A** Warning - Explosion Hazard - Substitution of components may impair suitability for Class I, Division 2.
- B** Warning - Explosion Hazard - When in Hazardous Locations, turn off power before replacing or rewiring modules.
- C** Warning - Explosion Hazard - Do not disconnect equipment unless power has been switched off or the area is known to be nonhazardous.

Agency Approvals and Certifications

Agency

ATEX

CSA-CB Safety

CE

GOST-R

UL/cUL



Contents

Your Feedback Please.....	2
How to Contact Us	2
Content Disclaimer.....	2
Important Safety Information.....	3
1 Start Here	9
1.1 PLX82-EIP-PNC Overview.....	9
1.2 System Requirements.....	11
1.3 Shipping Contents	11
1.4 Setting Jumpers	12
1.5 Mounting the PLX82-EIP-PNC on a DIN-rail.....	12
1.6 Connecting Power	13
2 ProSoft Configuration Builder Software	15
2.1 Creating a New Project	16
2.2 Setting a Project Name	18
2.3 Setting a Temporary IP Address	19
2.4 Ethernet Configuration	22
2.5 Saving the Project	23
2.6 Downloading the Configuration File to the PLX82-EIP-PNC	24
2.7 Uploading a Configuration from the PLX82-EIP-PNC.....	25
2.8 Exporting a Project	26
2.9 Writing the Project to Compact Flash.....	27
3 Configuring the EtherNet/IP Driver	29
3.1 RSLogix 5000.....	30
3.2 Adding an Ethernet Bridge	31
3.3 Adding the PLX82-EIP-PNC.....	33
3.4 Importing the Ladder Rung.....	36
3.5 Downloading the RSLogix 5000 Project to the Processor	38
3.6 EIP Class 3 Server Connection.....	39
3.7 EIP Class 1 Connection	40
3.8 EIP Class 3 Client/UClient [x] Connection	41
3.8.1 EIP Class 3 Client/UClient [x].....	41
3.8.2 EIP Class 3 Client/UClient [x] Commands	42
3.9 Configuring the EIP Processor Path	49
4 Configuring the PROFINET Controller	51
4.1 Importing GSD Files	54
4.2 Adding a Slave Device to the Project.....	56
4.3 Configuring a Slave Device	57
4.4 Verifying Slave Device Information	59
4.4.1 Controller Network Settings.....	60
4.4.2 Device Table	61

4.4.3	IP Address Table	63
4.4.4	Process Data	64
4.4.5	Address Table.....	65
4.4.6	FSU-/Port-Settings.....	68
4.4.7	Stations Timing	69
4.4.8	Controller Settings	70
4.4.9	Ethernet Devices	72
4.4.10	Viewing Configured Device Information	78
5	PROFINET Start Input and Output Byte Offsets	81
6	Acyclic Data	83
7	CommonNet Data Map	87
8	Webpage	89
9	Diagnostics and Troubleshooting	91
9.1	LEDs	92
9.2	PCB Diagnostics	94
9.2.1	PCB Diagnostics Menu Options	96
9.2.2	PROFINET General Status Codes	102
9.2.3	PROFINET Device Errors	103
9.2.4	Acyclic Read/Write Communication Status	103
9.2.5	Acyclic Read/Write PNIO Remote Procedure Call Status	104
9.3	Network Diagnostics	106
9.3.1	Establishing a Diagnostic Connection	110
9.3.2	General Diagnosis	113
9.3.3	Master Diagnosis	114
9.3.4	Station Diagnosis	115
9.3.5	Firmware Diagnosis	116
9.3.6	Extended Diagnosis	117
9.3.7	Tools	126
9.3.8	Viewing Alarm Information.....	134
9.3.9	EIP Status Data in Upper Memory.....	135
9.3.10	EIP Error Codes.....	137
10	Reference	143
10.1	EtherNet/IP Explicit Messaging Server Command Support	143
10.2	Accessing the PLX82-EIP-PNC Internal Memory.....	144
10.2.1	MSG Instruction Type - CIP.....	144
10.2.2	MSG Instruction Type - PCCC.....	145
10.3	Specifications.....	145
10.3.1	Hardware Specifications	145
10.3.2	EtherNet/IP (EIP) Specifications	146
10.3.3	PROFINET (PNC) Specifications	146

11	Support, Service & Warranty	147
11.1	Contacting Technical Support	147
11.2	Warranty Information	148
Index		149

1 Start Here

In This Chapter

❖ PLX82-EIP-PNC Overview	9
❖ System Requirements.....	11
❖ Shipping Contents	11
❖ Setting Jumpers.....	12
❖ Mounting the PLX82-EIP-PNC on a DIN-rail.....	12
❖ Connecting Power	13

1.1 **PLX82-EIP-PNC Overview**

The EtherNet/IP™ to PROFINET Controller gateway provides EtherNet/IP-based controllers the ability to control up to 36 PROFINET RT devices such as field I/O, drives, HMIs, controllers, etc.

The PLX82-EIP-PNC gateways are stand-alone DIN-rail mounted units that provide two Ethernet ports for communications, remote configuration, and diagnostics. The onboard SD card slot (SD card optional) is used for storing configuration files that can be used for recovery, transferring the configuration to another gateway, or general configuration backup.

The gateway supports 248 bytes of input data and 248 bytes of output data per Class 1 connection. The module supports 8 EIP connections and 100 Class 3 EIP commands.

The module is configured using *ProSoft Configuration Builder (PCB)* and *ProSoft fdt Configuration Manager*.

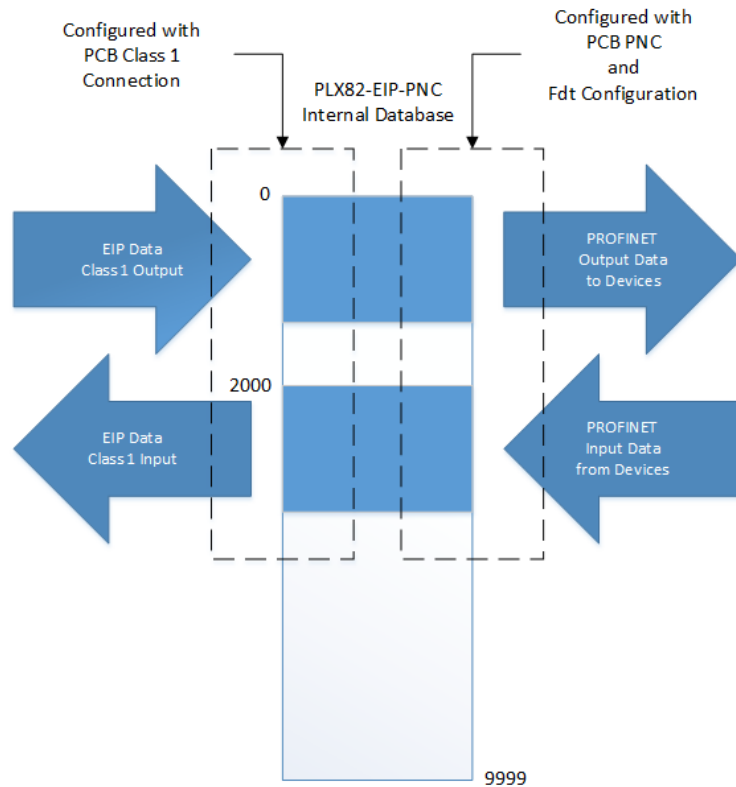
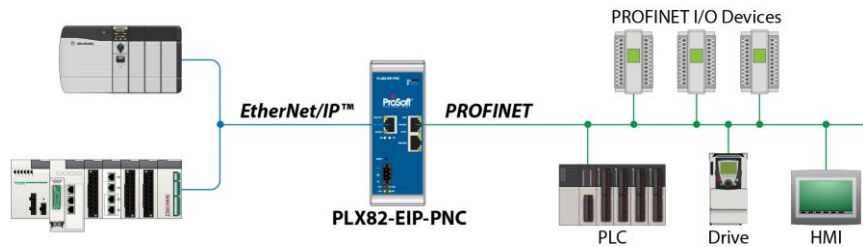

- ODVA Approved
- PROFINET v2 certification with PROFINET Class A compliance
- EtherNet/IP and PROFINET certifications ensure that the device is compatible with their respective network
- Field-tested with multiple PROFINET devices from multiple vendors
- Remotely view and diagnose EtherNet/IP and PROFINET networks
- Embedded EDS AOP provided to allow for seamless integration to Studio 5000 and RSLogix 5000
- No ladder programming is required using EtherNet/IP I/O connections

1.2 System Requirements

The PLX82-EIP-PNC module requires the following minimum hardware and software components:

- Rockwell Automation ControlLogix or CompactLogix processor (firmware version 10 or higher).
- Rockwell Automation RSLogix 5000 programming software version 16 or higher
- Rockwell Automation RSLinx® communication software version 2.51 or higher.

The ProSoft Configuration Builder configuration software for the PLX82-EIP-PNC gateway requires the following minimum hardware and software components:

- Pentium® II 450 MHz minimum. Pentium III 733 MHz (or better) recommended
- 128 Mbytes of RAM minimum, 256 Mbytes of RAM recommended
- 100 Mbytes of free hard disk space (or more based on application requirements)
- 256-color VGA graphics adapter, 800 x 600 minimum resolution (True Color 1024 x 768 recommended)

Supported operating systems:

- Microsoft Windows 7 (32 bit) (64bit not tested)
- Microsoft Windows Vista (not tested)
- Microsoft Windows XP Professional with Service Pack 1 or 2
- Microsoft Windows 2000 Professional with Service Pack 1, 2, or 3 (not tested)

Microsoft Windows Server 2003 (not tested)

ProSoft fdt Configuration Manager requires that Microsoft .NET be installed on the PC or laptop used to configure the gateway.

1.3 Shipping Contents

The following components are included with the PLX82-EIP-PNC.

Qty.	Part Name	Part Number	Part Description
1	EtherNet/IP™ Server to PROFINET Controller	PLX82-EIP-PNC	ProSoft communication gateway
1	Screwdriver	HRD250	Small, flat-bladed screwdriver
1	Power Connector	J180	3-wire DC power connector

If any of these components are missing, please contact ProSoft Technology Technical Support for replacement parts.

1.4 Setting Jumpers

The jumper settings are located on the back of the PLX82-EIP-PNC. For security reasons, the *Mode 1* and *Mode 2* jumpers are not readily accessible. Under normal conditions, these two jumpers will not be required.

Setup Jumper

Mode 3 is jumpered by default. It is only required for firmware updates.

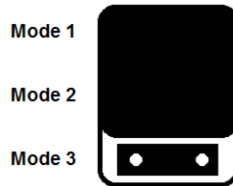

1.5 Mounting the PLX82-EIP-PNC on a DIN-rail

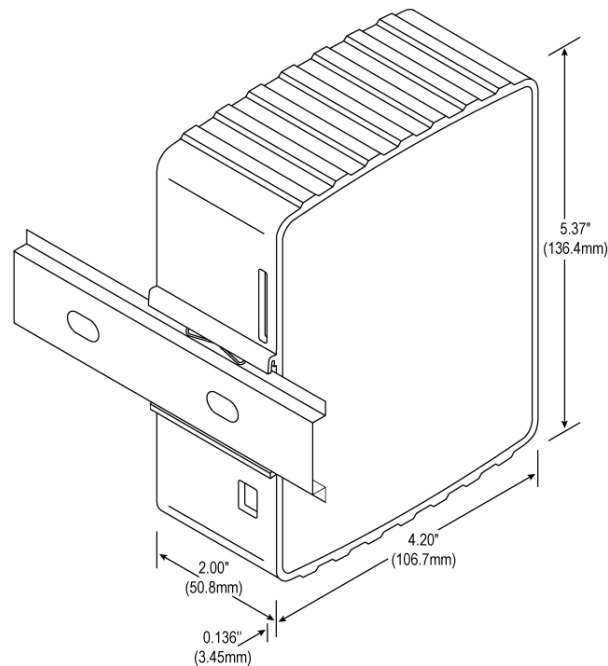

- 1 Position the PLX82-EIP-PNC on the DIN-rail B at a slight angle.
- 2 Hook the lip on the rear of the adapter onto the top of the DIN-rail, and rotate the adapter onto the rail.
- 3 Press the adapter down onto the DIN-rail until flush. The locking tab snaps into position and locks the module to the DIN-rail.
- 4 If the adapter does not lock in place, use a screwdriver or similar device to move the locking tab down while pressing the adapter flush onto the DIN-rail and release the locking tab to lock the adapter in place. If necessary, push up on the locking tab to lock.

1.6 Connecting Power



Use the J180 Power Connector to connect to the proper signals.

WARNING: Be sure not to reverse polarity when applying power to the PLX82-EIP-PNC. This causes permanent damage to the internal power distribution circuits.

2 ProSoft Configuration Builder Software

In This Chapter

❖ Creating a New Project.....	16
❖ Setting a Project Name.....	17
❖ Setting a Temporary IP Address	18
❖ Ethernet Configuration	22
❖ Saving the Project	23
❖ Downloading the Configuration File to the PLX82-EIP-PNC	24
❖ Uploading a Configuration from the PLX82-EIP-PNC	25
❖ Exporting a Project.....	26
❖ Writing the Project to Compact Flash	27

ProSoft Configuration Builder (PCB) and ProSoft fdt Configuration Manager is used to configure the PLX82-EIP-PNC. You can find both software files at www.prosoft-technology.com.

Important Note: Microsoft .NET must be installed on your PC or laptop used to perform configuration tasks. This is required for ProSoft fdt Configuration Manager to install and run.

Note: To use the ProSoft Configuration Builder under the Windows 7 OS, you must be sure to install it using the *Run as Administrator* option. To find this option, right-click the Setup.exe program icon, and then click **RUN AS ADMINISTRATOR** on the context menu. You must install using this option even if you are already logged in as an Administrator on your network or personal computer (PC). Using the Run as Administrator option allows the installation program to create folders and files on your PC with proper permissions and security. If you do not use the Run as Administrator option, the ProSoft Configuration Builder may appear to install correctly, but you will receive multiple file access errors whenever the ProSoft Configuration Builder is running, especially when changing configuration screens. If this happens, you must completely uninstall the ProSoft Configuration Builder and then re-install using the Run as Administrator option to eliminate the errors.

2.1 Creating a New Project

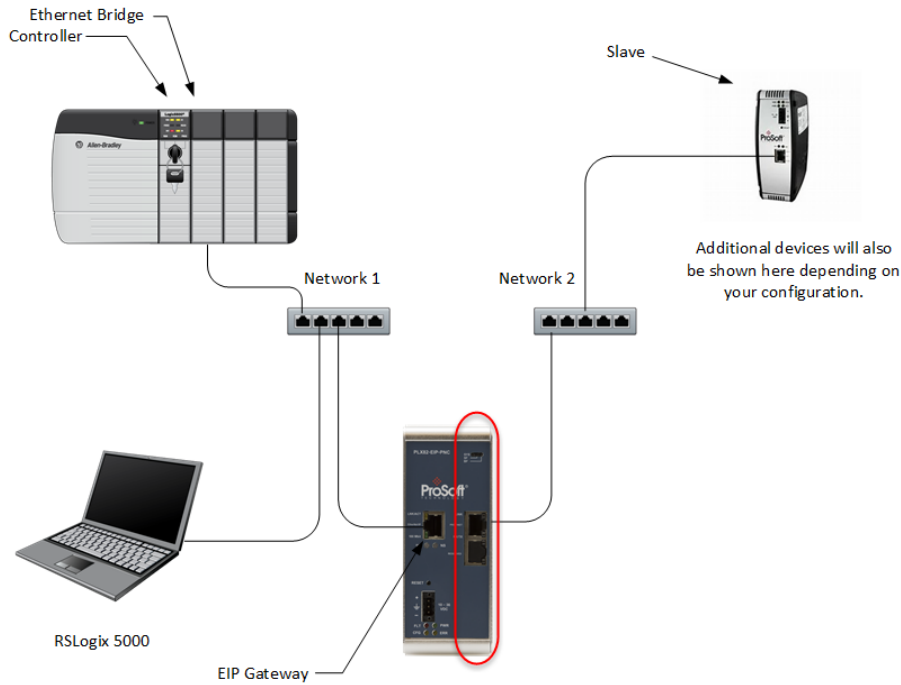

- 1 From your PC, click **START > PROSOFT TECHNOLOGY > PROSOFT CONFIGURATION BUILDER**.
- 2 Click **FILE > NEW**. The application prompts for a *Module Type*.

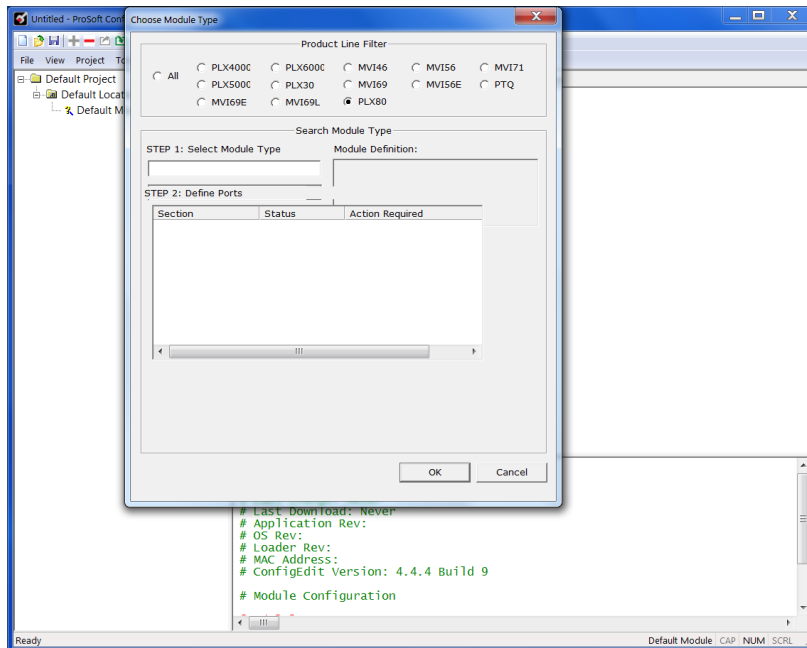

3 Select the PLX80 radio button and then select PLX82-EIP-PNC.

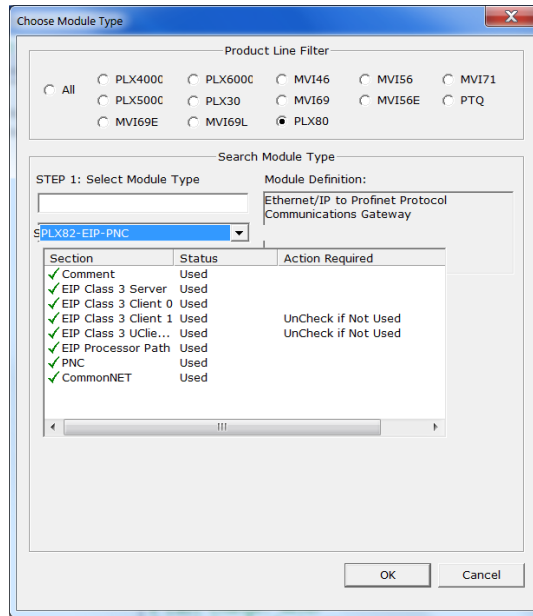

4 Click OK. The PLX82-EIP-PNC is now added to ProSoft Configuration builder.

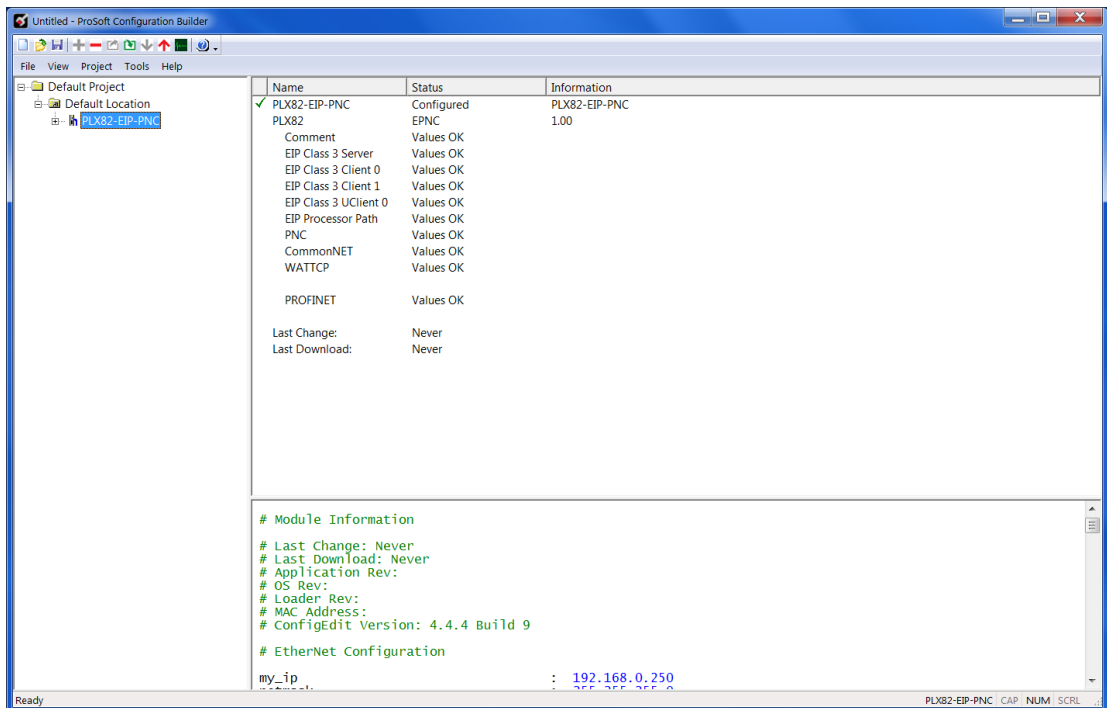

2.2 Setting a Project Name

The project name is initially set to "*Default Location*".

- 1 Right click on the **DEFAULT LOCATION** icon and select **RENAME**.

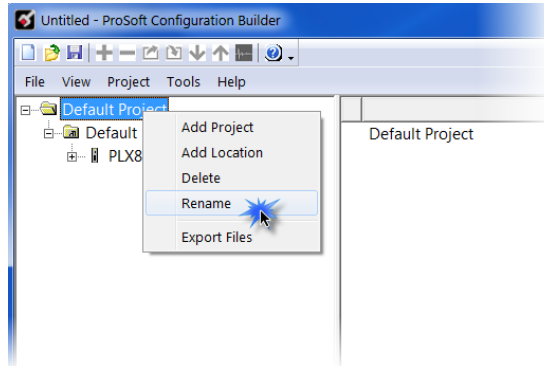

- 2 Type in a name for your project and press **ENTER**.

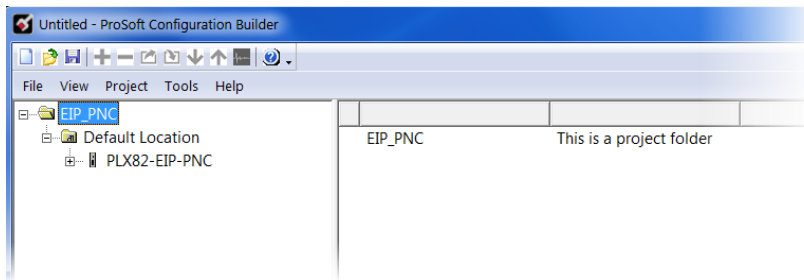

2.3 Setting a Temporary IP Address

Important: ProSoft Discovery Service (PDS) is a built-in utility within PCB. It locates the PLX82-EIP-PNC through UDP broadcast messages. These messages may be blocked by routers or layer 3 switches. In that case, PDS is unable to locate the PLX82-EIP-PNC.

To use PDS, arrange the Ethernet connection so that there is no router or layer 3 switch between the computer and the PLX82-EIP-PNC, or reconfigure the router or layer 3 switch to allow the routing of the UDP broadcast messages.

- 1 Right-click the **PLX82-EIP-PNC** icon and select **DIAGNOSTICS**.

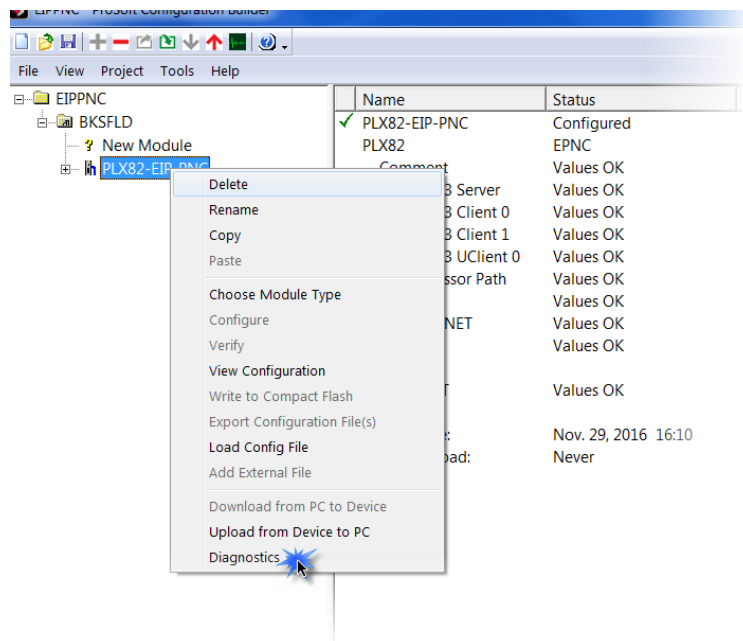

- 2 When the *Diagnostics* dialog opens, click on the **SETUP CONNECTION** icon.



- 3 When the *Connection Setup* dialog opens, click the **BROWSE DEVICES** button to locate your device.

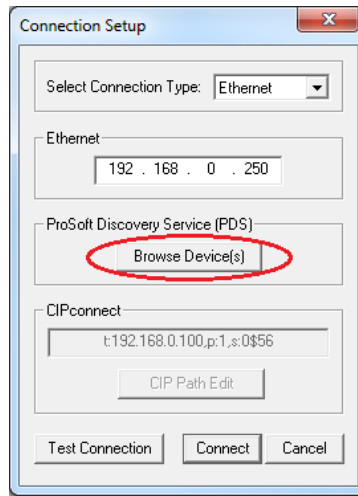

- 4 This launches *Prosoft Discovery Service*, which displays the ProSoft modules that have been detected on the network

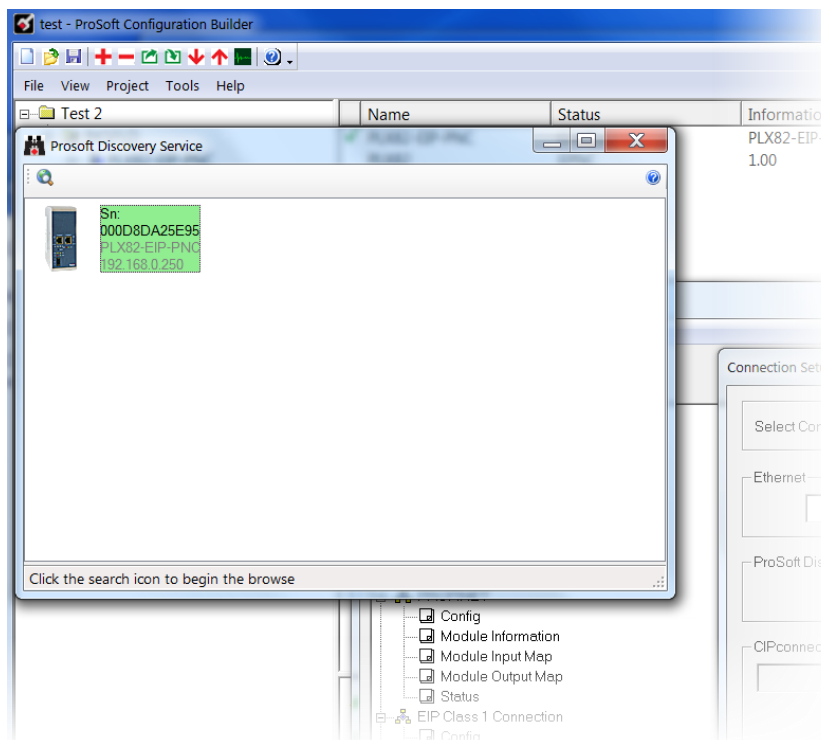

- 5 Right-click the module, and then click **ASSIGN TEMPORARY IP**.

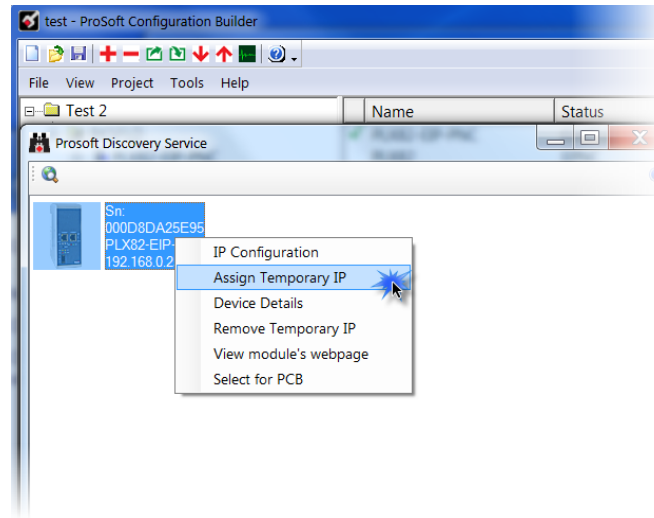

- 6 The module's default IP address is **192.168.0.250**.

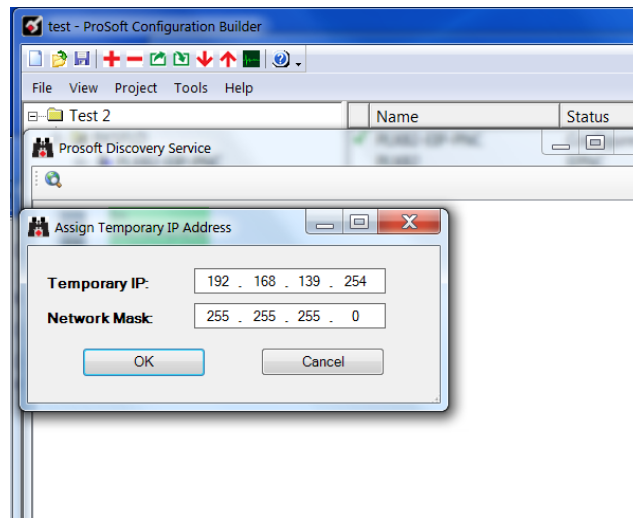

- 7 Enter an unused IP within your subnet, and then click **OK**.

2.4 Ethernet Configuration

This is used to provide address information for the gateway; in this case, the EIP driver. This is unique address information for the PLX82-EIP-PNC's EIP driver and diagnostic interface. The default is initially set to 192.168.0.250.

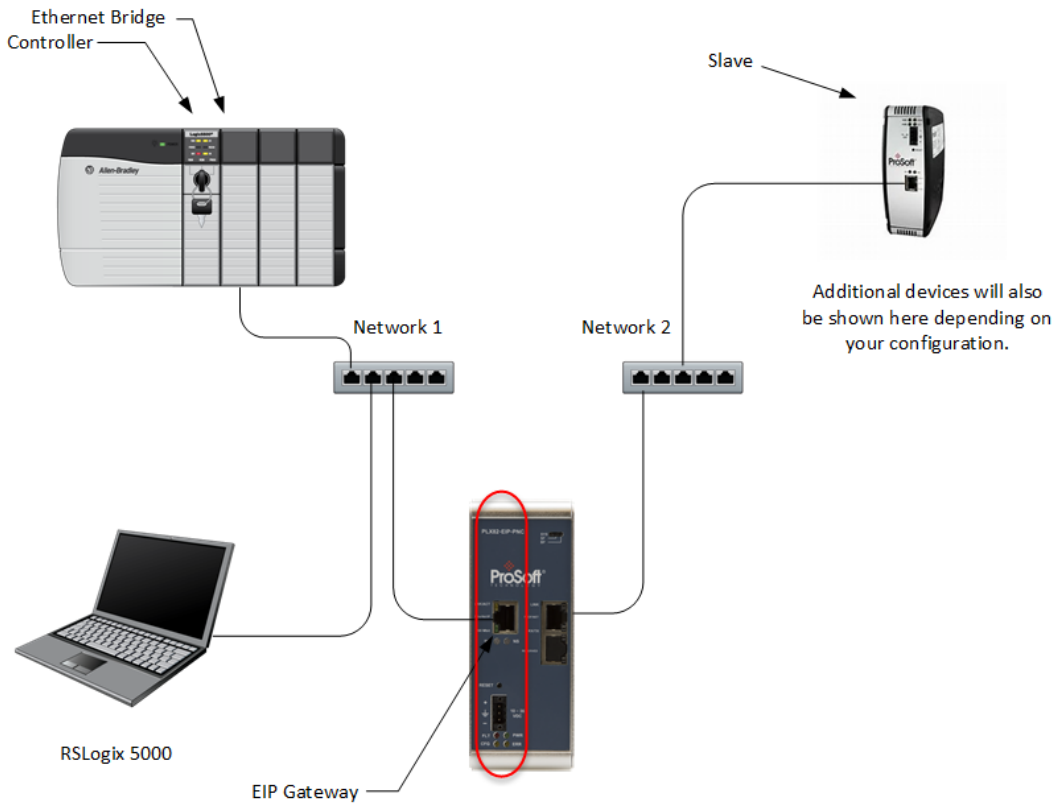

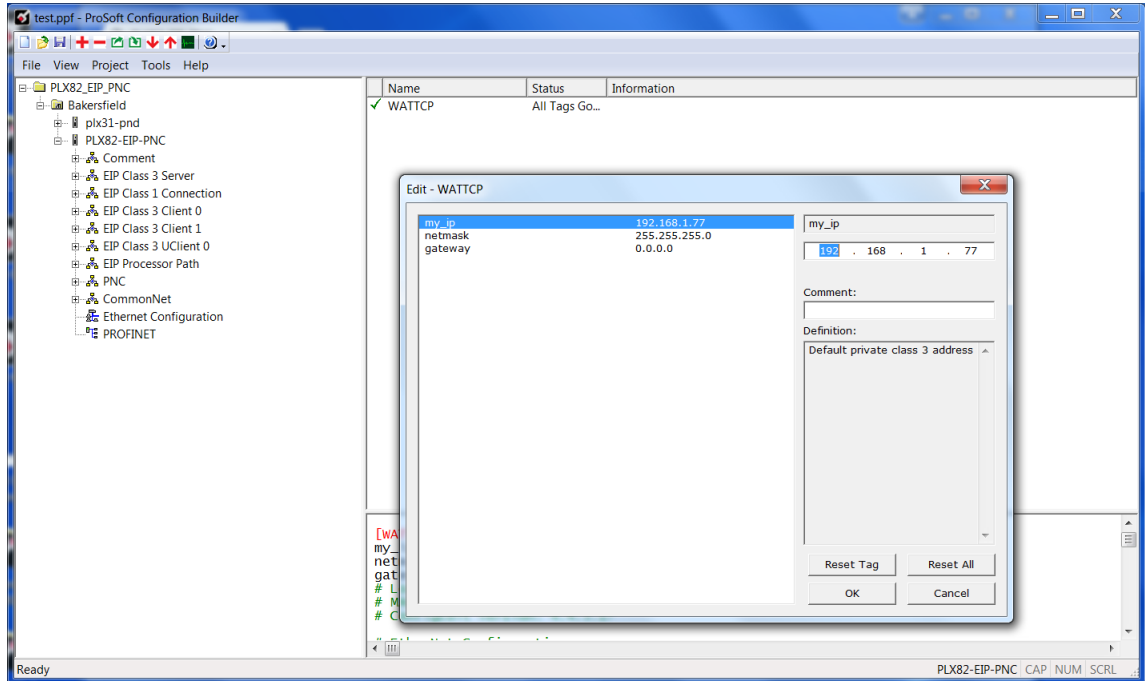

- 1 Select **my_ip** and enter the IP address of the EIP device in the gateway.
- 2 Select **netmask** and enter the network mask.
- 3 If using a gateway/router, select **gateway** and enter the IP address of the network gateway (router). If you are not using a gateway/router, enter 0.0.0.0 in this field.
- 4 Click **OK** when done.

Parameter	Description
my_ip	This is the default address assigned to the EIP side of the gateway. Change this to the address that suites your network configuration.
netmask	This is the default network mask. Update this to the appropriate network mask.
gateway	This is the IP address for gateway that you want to use.

2.5 Saving the Project

The PCB project must be saved when you move from PCB to ProSoft fdt Configuration Manager if you have not previously saved the project while in PCB.

- 1 Navigate to **FILE > SAVE AS**.
- 2 Select the appropriate directory and filename name of your ProSoft Project File (PPF).
- 3 Click **SAVE**.

2.6 Downloading the Configuration File to the PLX82-EIP-PNC

After you have created the project in the ProSoft Configuration Builder and ProSoft fdt Configuration Manager software, you are ready to download it to the PLX82-EIP-PNC.

- 1 From PCB, right-click on the **PLX82-EIP-PNC** icon and select **DOWNLOAD FROM PC TO DEVICE**.

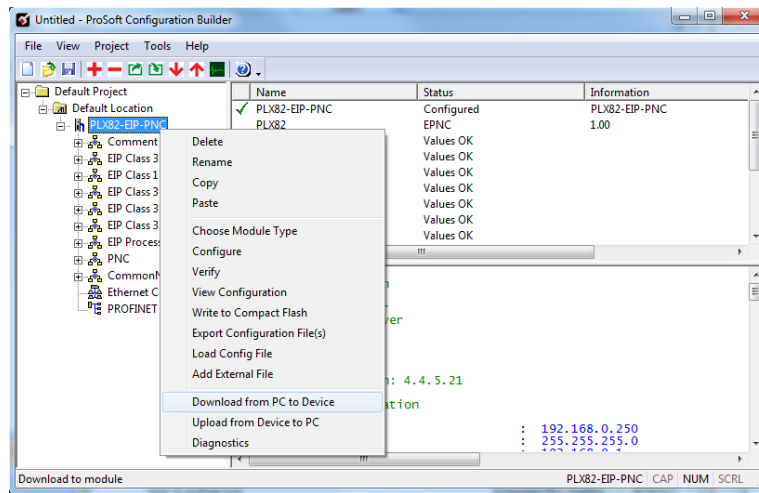

- 2 The *Download files from PC to module* dialog box opens:

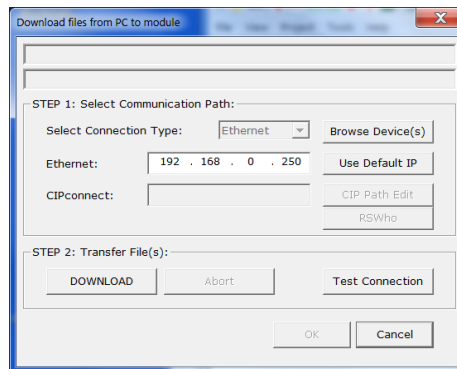

- 3 Click **TEST CONNECTION**.

If the PLX82-EIP-PNC's IP address matches the address in the Configuration Manager, and the software displays the following message: "*Successfully connected.*"

If the PLX82-EIP-PNC's IP address does not match what was entered in ProSoft Configuration Builder, then the software displays an error message: "*Error: Connecting to Module. Please check your IP Address.*"

- 4 Click **DOWNLOAD** to download the project to the PLX82-EIP-PNC.

2.7 Uploading a Configuration from the PLX82-EIP-PNC

Use this feature to retrieve the configuration from the PLX82-EIP-PNC. Not only does it retrieve the configuration, but it also retrieves all related files used in creating that configuration. There are several reasons that you might use this feature:

- You want to modify the configuration, but do not have access to the original configuration files.
- You want to copy a configuration from one PLX82-EIP-PNC to another PLX82-EIP-PNC.
- You want to back up the configuration for safety.

Warning: This function replaces the current configuration in the ProSoft Configuration Builder with the one from the PLX82-EIP-PNC. Make sure you save the current configuration before uploading the configuration from the PLX82-EIP-PNC.

- 1 **Optional:** Create a new project in the ProSoft Configuration Builder by choosing **FILE > NEW**.
- 2 Right-click the PLX82-EIP-PNC icon and choose **UPLOAD FROM DEVICE TO PC**.

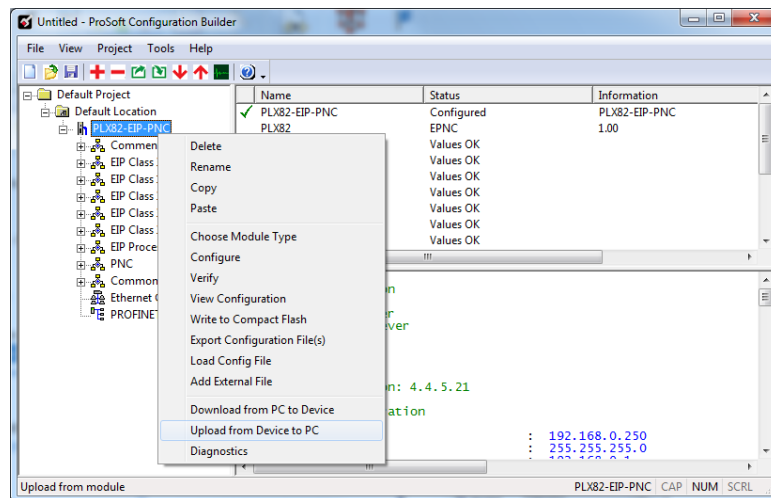

- 3 The *Upload files from Module to PC* dialog box opens:

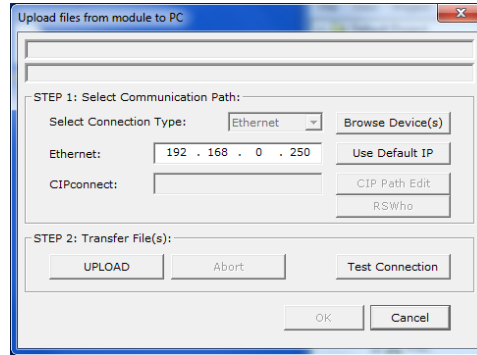

- 4 Select the *Connection Type*. If you don't know the IP address of the module that contains the configuration that you want, you can browse devices using the **BROWSE DEVICE(S)** button. This launches the ProSoft Discovery Service application.
- 5 Enter the IP address of the PLX82-EIP-PNC. All PLX82-EIP-PNC's are shipped with a default IP address **192.168.0.250**. Click the **USE DEFAULT IP** button to use the default address.
- 6 Use the **TEST CONNECTION** button to ensure that the connection is good.
- 7 Click the **UPLOAD** button to start the upload.
- 8 When the upload is complete, the configuration is displayed in PCB. You can edit or save it on the PC.

2.8 Exporting a Project

You can export a PCB file that was created on your PC. This allows someone on a different PC to import your configuration file and have all the files that are part of your project. If you need assistance from ProSoft Technology Technical Support, they will need your exported files.

- 1 In the ProSoft Configuration Builder choose **PROJECT > MODULE > EXPORT CONFIGURATION FILES**.
- 2 In the *Save As* dialog box, navigate to the correct directory and save the configuration file.

2.9 Writing the Project to Compact Flash

This procedure describes how to save a project from a PC to a Compact Flash drive.

- 1 From PCB, navigate to **PROJECT > MODULE > WRITE TO COMPACT FLASH**.

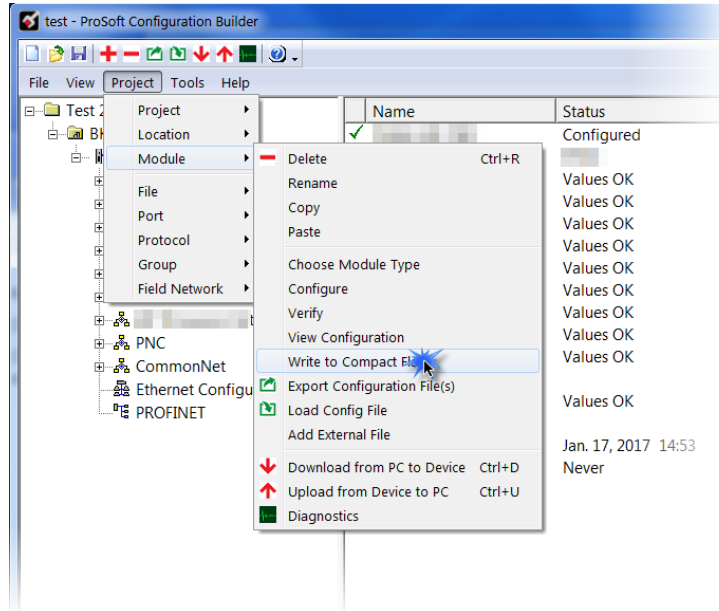

- 2 Choose the appropriate drive, then click **NEXT**.

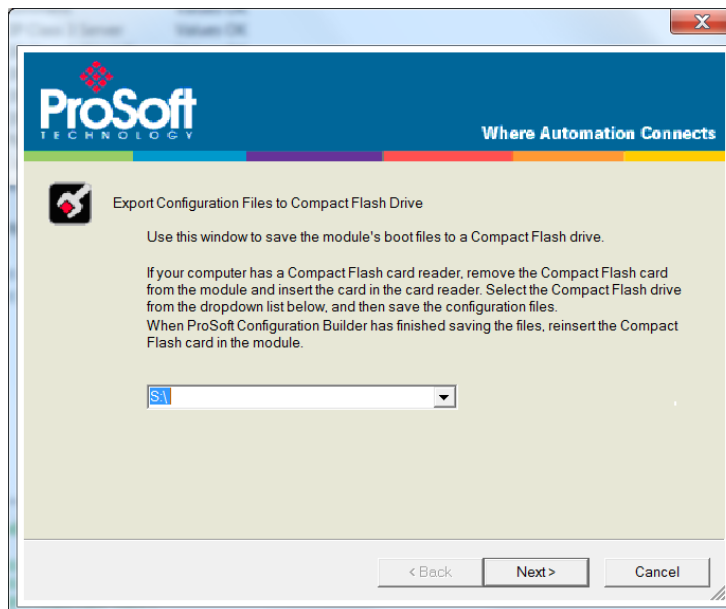

- 3 Follow the on-screen instructions and click **FINISH** when complete.

3 Configuring the EtherNet/IP Driver

In This Chapter

- ❖ RSLogix 5000..... 30
- ❖ Adding an Ethernet Bridge 31
- ❖ Adding the PLX82-EIP-PNC..... 33
- ❖ Importing the Ladder Rung..... 36
- ❖ Downloading the RSLogix 5000 Project to the Processor 38
- ❖ EIP Class 3 Server Connection 39
- ❖ EIP Class 1 Connection..... 40
- ❖ EIP Class 3 Client/UClient [x] Connection 41
- ❖ Configuring the EIP Processor Path..... 49

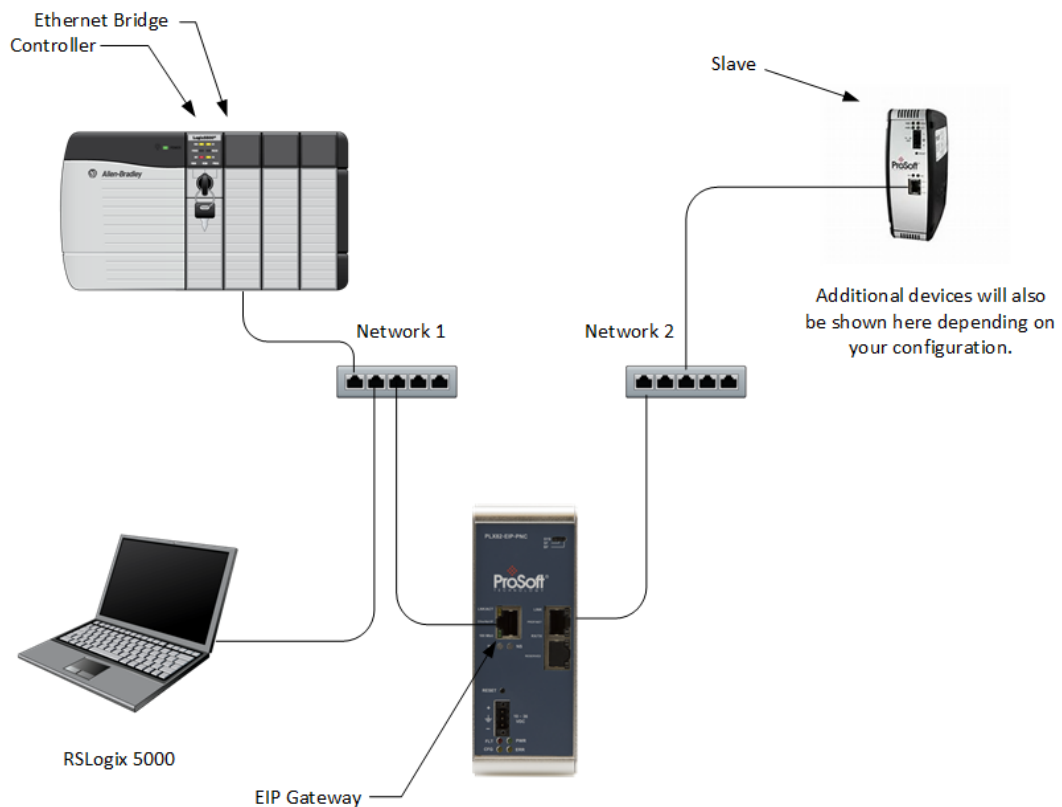

3.1 RSLogix 5000

If you want to add the PLX82-EIP-PNC gateway to an existing project, skip to *Adding an Ethernet Bridge* (page 31).

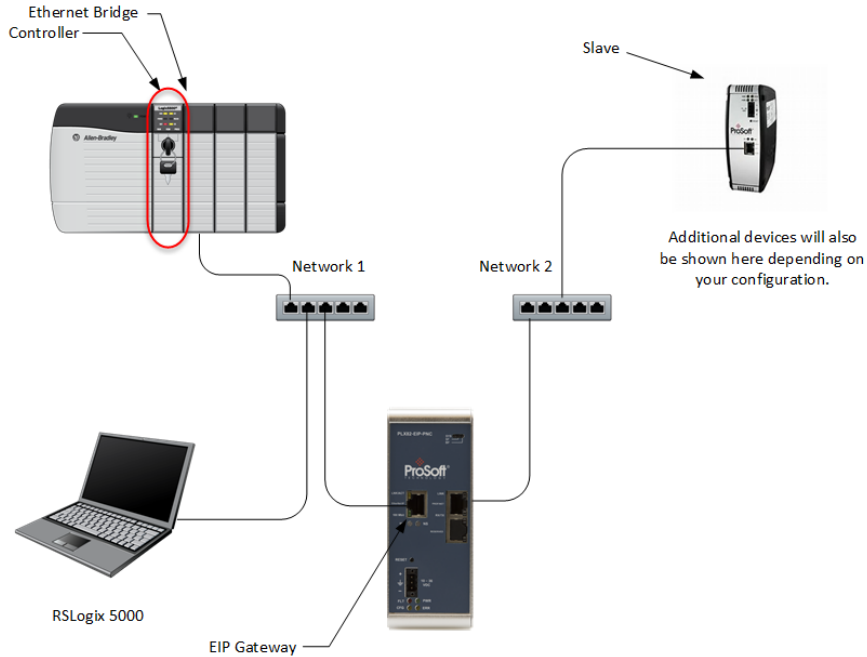

To create a new project...

- 1 In RSLogix 5000, choose **FILE > NEW**.
- 2 Select your PLC (a ControlLogix, or CompactLogix PLC).
- 3 Select **REVISION 16** or newer.
- 4 Enter a name for your controller, such as **MY_CONTROLLER**.
- 5 Select your chassis type and click **OK**.

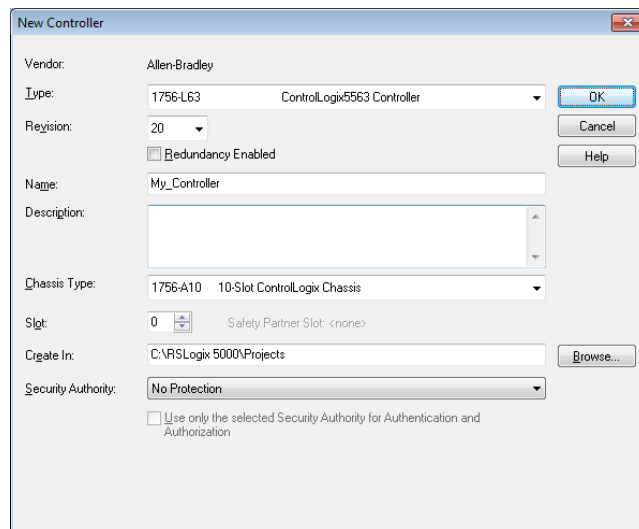

3.2 Adding an Ethernet Bridge

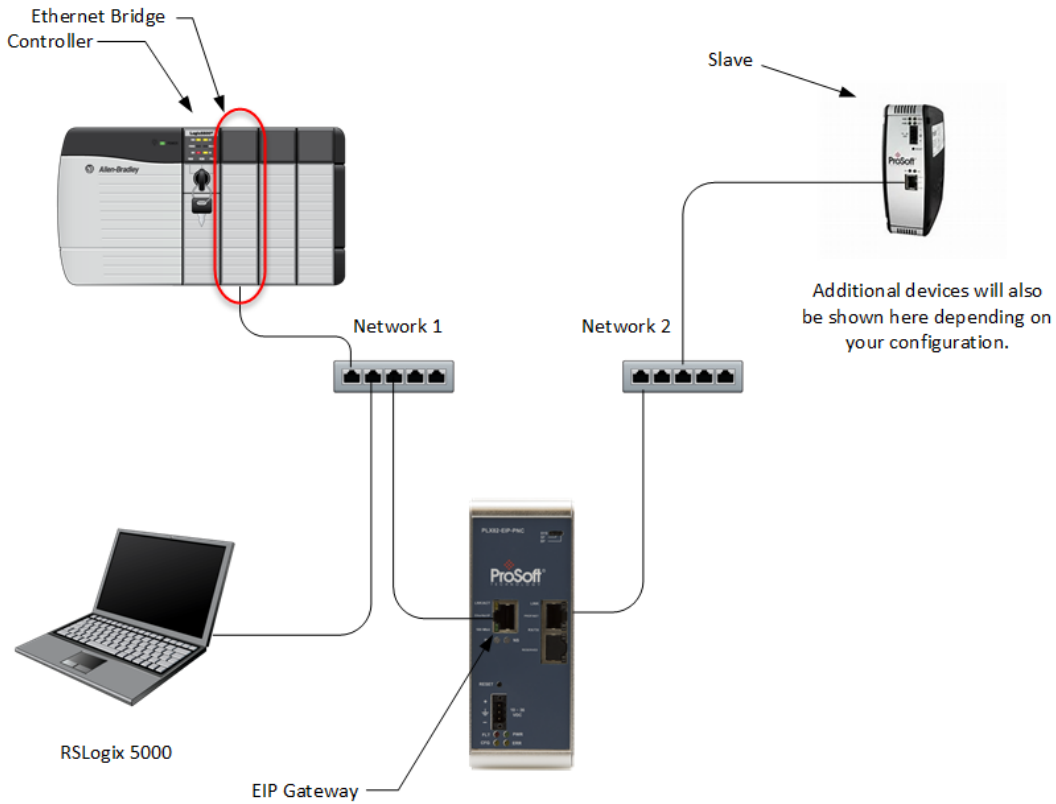

- 1 Expand the **I/O CONFIGURATION** folder in the Project tree. Right-click the appropriate communications bus and choose **NEW MODULE**.

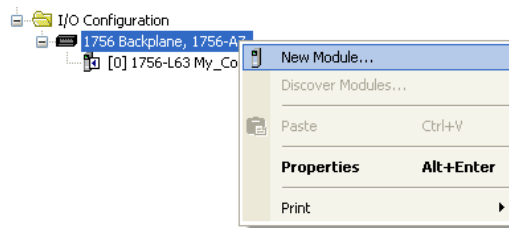

- 2 This opens the *Select Module Type* dialog box.

- 3 For this example, click the **1756-ENBT ETHERNET BRIDGE** and then click **CREATE**.

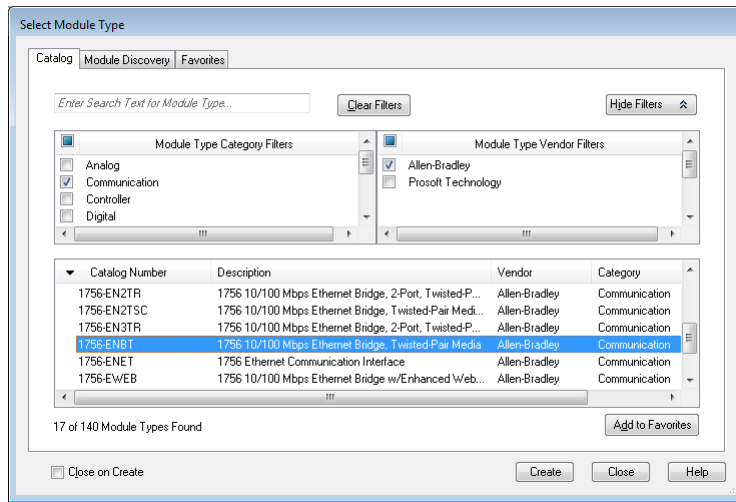

- 4 Enter the name, revision, and IP address for the 1756-ENBT and then click **OK**.

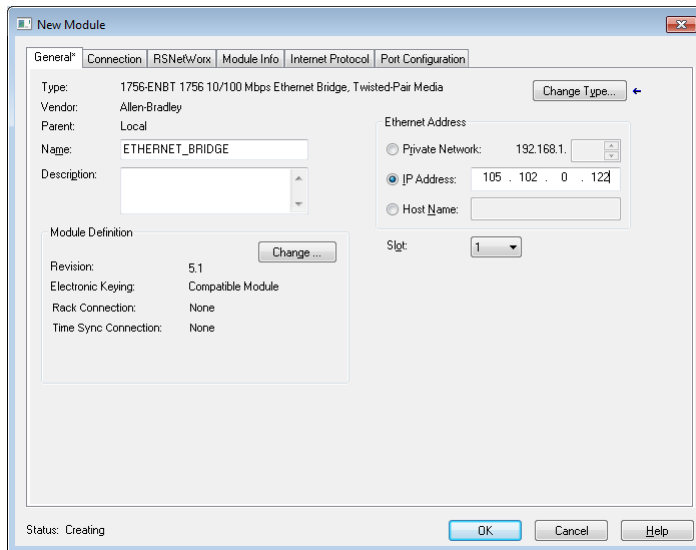

3.3 Adding the PLX82-EIP-PNC

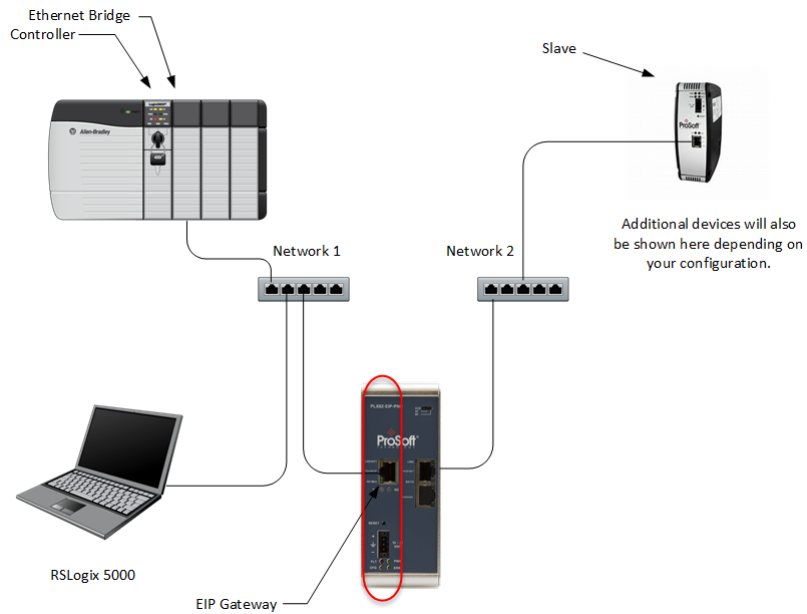

- 1 In RSLogix 5000, under the *1756-ENBT* icon, right-click **ETHERNET** and then choose **NEW MODULE**.

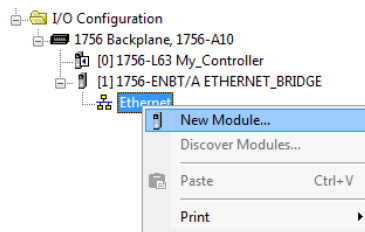

- 2 Select the **GENERIC ETHERNET/IP CIP BRIDGE** and then click **CREATE**.

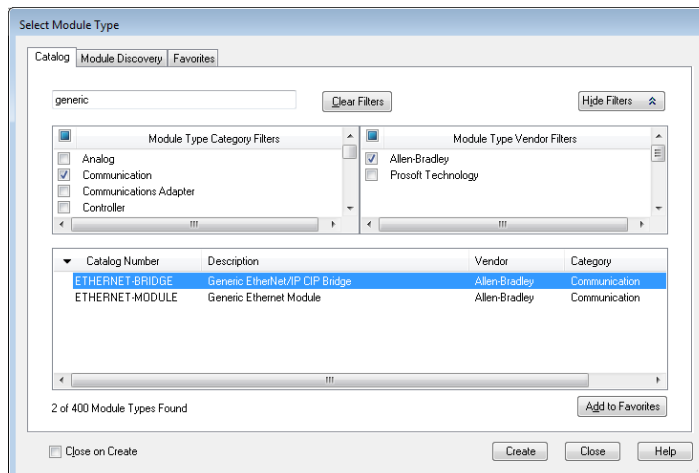

- 3 Enter the name and IP address for the gateway and then click **OK**.

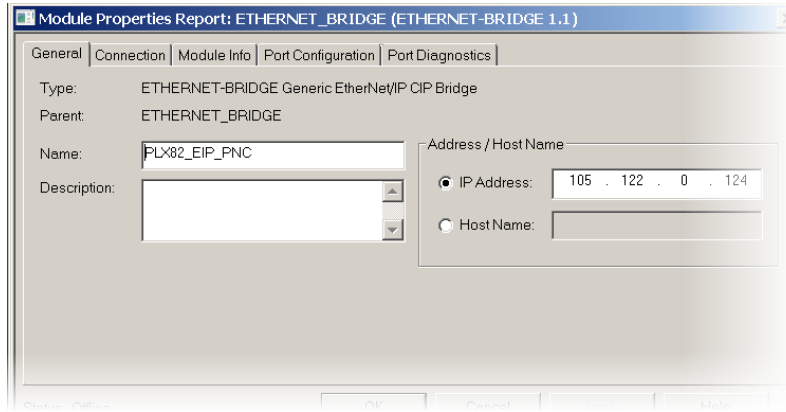

- 4 Under the gateway (PLX82_EIP_PNC in this example), right-click **CIP Bus** and then choose **NEW MODULE**.

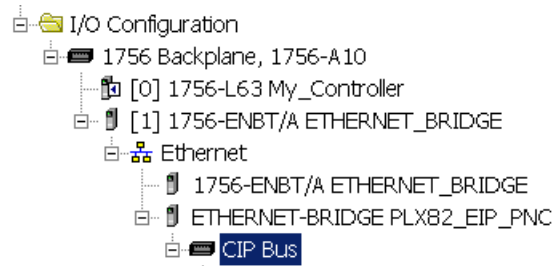

- 5 Click the **GENERIC CIP MODULE** and then click **CREATE**.

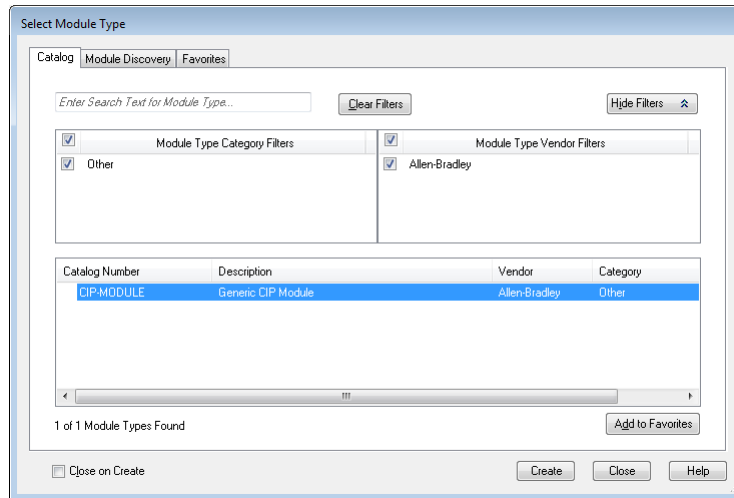

- 6 Add a Class 1 connection (enter the name and configuration parameters). Enter the Name, select **DATA-INT** for *Comm Format*, and enter the *Connection Parameters* as shown below. Click **OK**.

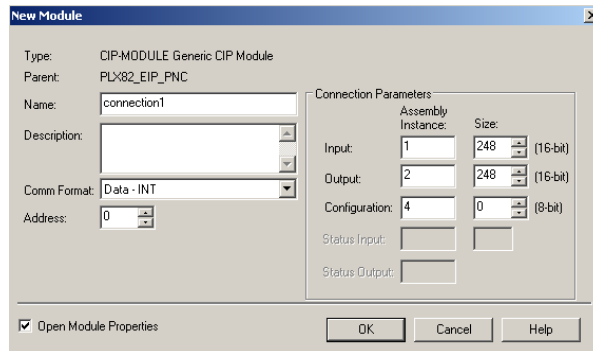

- 7 Right-click the new connection and then choose **PROPERTIES**.

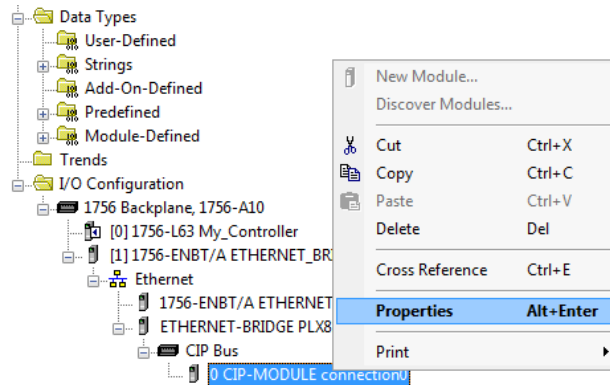

- 8 On the *Connection* tab, enter the *Requested Packet Interval (RPI)* time and then click **OK**.

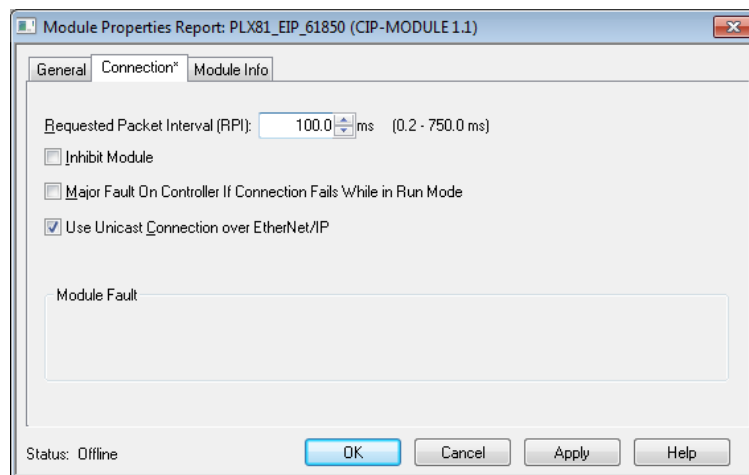

3.4 Importing the Ladder Rung

- 1 Download the .L5X file from the PLX82-EIP-PNC product page at www.prosoft-technology.com.
- 2 Open the *Main Routine*.
- 3 Right-click on an existing rung and select **IMPORT RUNGS**.

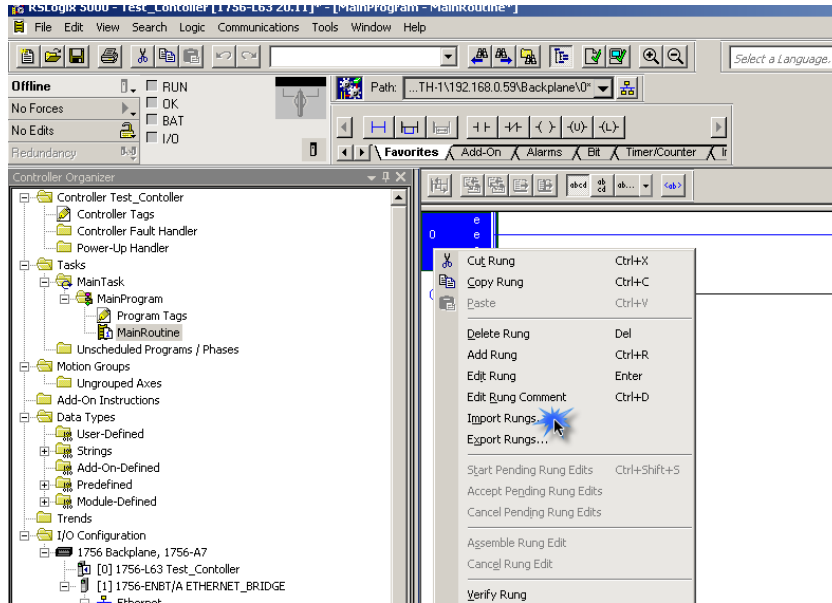

- 4 At the *Input Rungs* dialog, locate the directory that contains the Add On rung.

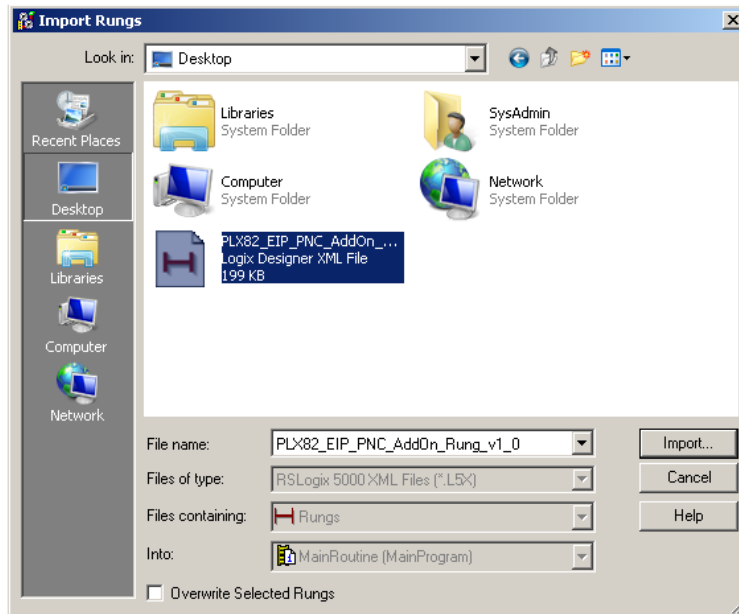

- 5 Click **IMPORT**.

- 6 In the *Import Configuration* dialog box, make sure the *Operation* is set to **CREATE**, and then click **OK**.

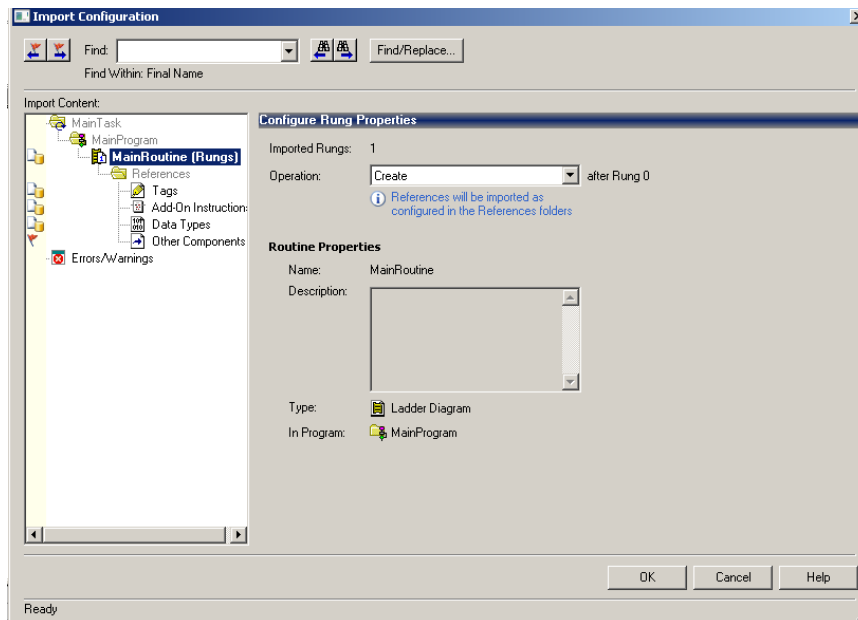

- 7 When the import completes, the Add-On Instruction appears under *Add-On Instructions* in the window.

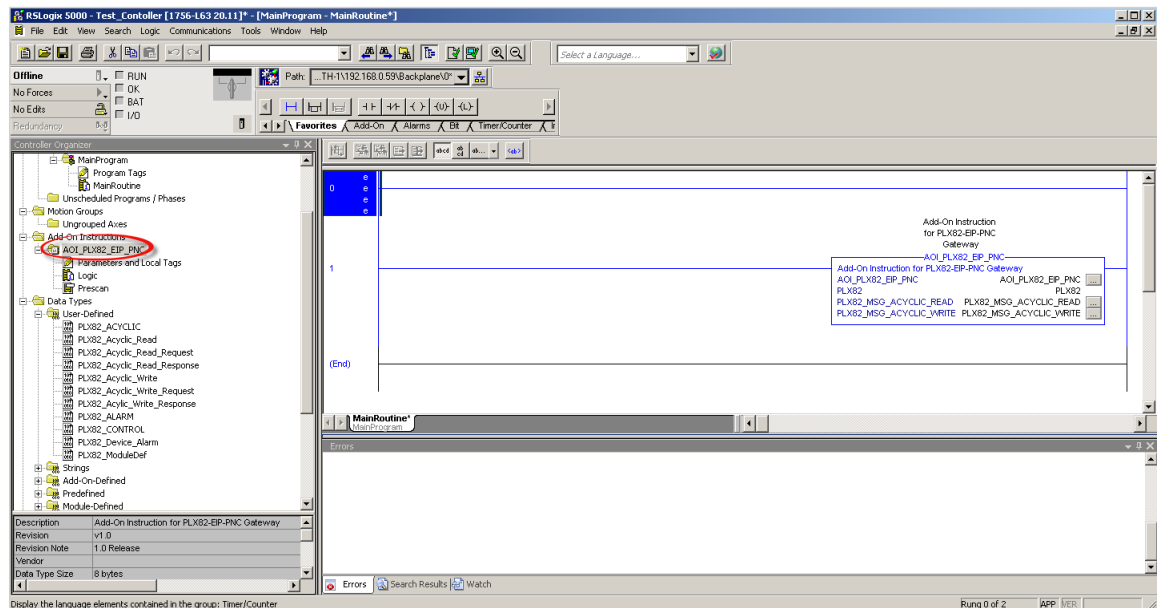

3.5 Downloading the RSLogix 5000 Project to the Processor

- 1 Save, and then download the project to the processor.
- 2 A yellow triangle in RSLogix 5000 means an error on connection. Check that the **OUTPUT** size and **INPUT** size for the Class 1 connection in the gateway configuration matches and the **COMM FORMAT** is **INT**. Try increasing the **REQUESTED PACKET INTERVAL** time of module if the error persists.
- 3 Check the PLX82-EIP-PNC's IP address. This is located in the bottom left of the *Diagnostics* page.
- 4 If errors persist, download the configuration again to make sure that the module configuration matches the configured RSLogix 5000 program.
- 5 For additional troubleshooting, use the ProSoft Configuration Builder. Click on **PROJECT > MODULE > DIAGNOSTICS**.

Class 1 displays the connection RPI time of processor and the IP address of the module. The open connection count starts at 1 and increments if the connection to the processor is interrupted or there is a connection timeout. State, open connection, and connection timeout are controlled by the code.

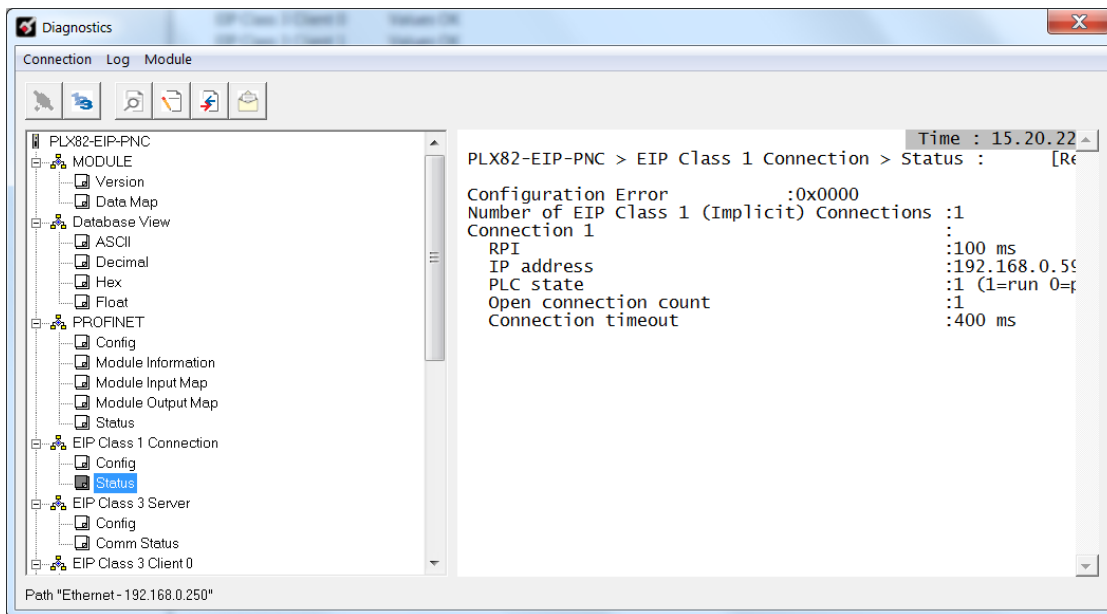

You can change the RPI and Ethernet IP in the ladder configuration in RSLogix 5000 (right-click **CONNECTION1** and choose **PROPERTIES**).

3.6 EIP Class 3 Server Connection

Use the EIP Class 3 Server connection in ProSoft Configuration Builder when the gateway is acting as a server (slave) device responding to message instructions initiated from a client (Controller) device such as an HMI, DCS, PLC, or PAC.

- 1 Within ProSoft Configuration Builder, click the **[+]** next to the gateway, then click the **[+]** next to EIP Class 3 Server.
- 2 Double-click the second **EIP CLASS 3 SERVER** to display the *Edit - EIP Class 3 Server* dialog box.

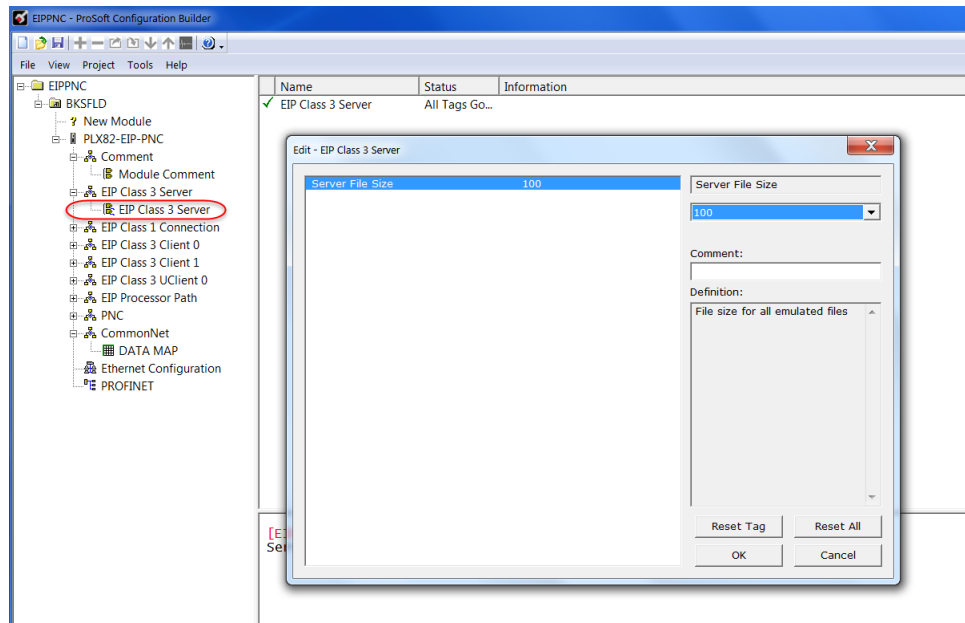

- 3 Select the *Server File Size* (100 or 1000).
 - For a value of 100, the registers are from N10:0 to N10:99.
 - For a value of 1000, the valid registers are from N10:0 to N10:999.

3.7 EIP Class 1 Connection

The EIP Class 1 connection is used with the gateway and acts as an EtherNet/IP adapter transferring data to and from a PLC using a direct I/O connection. Direct I/O connections can be used to transfer large amounts of data quickly.

The EIP driver can handle up to eight I/O connections, each with 248 words of input data and 248 words of output data. Rockwell Automation customers running RSLogix 5000 v2.0 or higher can take advantage of premier integration with an Add-on profile.

After you create the PLX82-EIP-PNC in RSLogix 5000, you must configure gateway connections.

- 1 In ProSoft Configuration Builder, click the **[+]** next to the gateway, and then click the **[+]** next to *EIP Class 1 Connection [x]*.

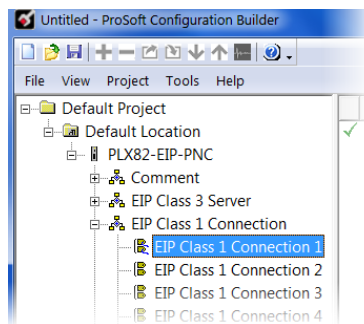

- 2 Double-click the **EIP CLASS 1 CONNECTION [x]** to display the *Edit - EIP Class 1 Connection [x]* dialog box.

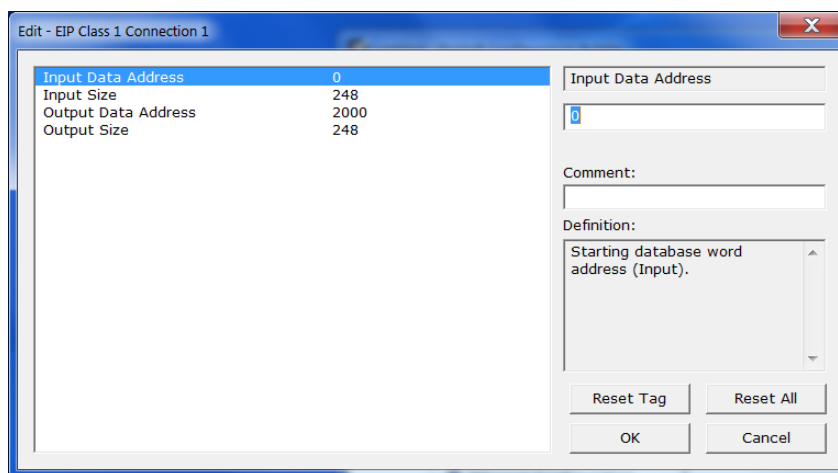

- 3 In the dialog box, enter a value for each parameter.

Parameter	Value	Description
Input Data Address	0 to 3999	This parameter specifies the starting address within the gateway's virtual database for data transferred from the PLC to the module.
Input size	0 to 248	This parameter specifies the number of integers being transferred to the PLC's input image (248 integers max).
Output data address	0 to 3999	This parameter specifies the starting address within the gateway's virtual database for data transferred from the gateway to the PLC.
Output size	0 to 248	This parameter specifies the number of integers being transferred to the PLC's output image (248 integers max).

Create entries for up to 8 connections by following the same steps.

3.8 EIP Class 3 Client/UClient [x] Connection

EIP Class 3 Client [x] connections are used when the gateway is acting as a client/controller initiating message instructions to the server/slave devices. The EIP driver supports three connected clients. Typical applications include SCADA systems, PLC and SLC communication.

The EIP driver supports one unconnected client connection. Unconnected messaging is a type of EtherNet/IP explicit messaging that uses TCP/IP implementation. Certain devices, such as the AB Power Monitor 3000 series B, support unconnected messaging. Check your device documentation for further information about its EtherNet/IP implementation.

3.8.1 EIP Class 3 Client/UClient [x]

- 1 In ProSoft Configuration Builder, click the [+] next to the gateway, then click the [+] next to *EIP Class 3 Client [x]* or *EIP Class 3 UClient [x]*.
- 2 Double-click the second *EIP Class 3 Client [x]* to display the *Edit - EIP Class 3 Client [x]* dialog box.
- 3 Click a parameter to change it's value.

The following table specifies the configuration for the EIP client (Controller) device on the network port:

Parameter	Value	Description
Minimum Command Delay	0 to 65535 milliseconds	Specifies the number of milliseconds to wait between the initial issuances of a command. This parameter can be used to delay all commands sent to servers to avoid "flooding" commands on the network. This parameter does not affect retries of a command as they will be issued when a failure is recognized.
Response Timeout	0 to 65535 milliseconds	Specifies the amount of time in milliseconds that a client will wait before re-transmitting a command if no response is received from the addressed server. The value depends on the type of communication network used, and the expected response time of the slowest device connected to the network.
Retry Count	0 to 10	Specifies the number of times a command will be retried if it fails.

3.8.2 EIP Class 3 Client/UClient [x] Commands

- There is a separate command list for each of the different message types supported by the protocol. Each list is processed from top to bottom, one after the other, until all specified commands are completed, and then the polling process begins all over again.
- This section defines the EtherNet/IP commands to be issued from the gateway to server devices on the network. These commands can be used for data collection and/or control of devices on the TCP/IP network.
- In order to interface the virtual database with Rockwell Automation Programmable Automation controllers (PACs), Programmable Logic Controllers (PLCs), or other EtherNet/IP server devices, you must construct a command list using the command list parameters for each message type.

To add Class 3 Client/UClient [x] commands...

- 1 In ProSoft Configuration Builder, click the **[+]** next to the gateway, then click the **[+]** next to *EIP Class 3 Client [x]* or *EIP Class 3 UClient [x]*.
- 2 Double-click the desired command type to display the *Edit - EIP Class 3 Client [x] Commands* or *Edit - EIP Class 3 UClient Commands* dialog box.
- 3 Click **ADD ROW** to add a new command.
- 4 Click **EDIT ROW** or double-click the row to display the *Edit* dialog box where you configure the command.

Class 3 Client/UClient [x] Commands SLC500 2 Address Fields

Parameter	Value	Description
Enable	Enable Disable Conditional Write	Specifies if the command should be executed and under what conditions. Enable - The command is execute each scan of the command list. Disable - The command is disabled and will not be executed. Conditional Write - The command executes only if the internal data associated with the command changes.
Internal Address	0 to 3999	Specifies the database address in the module's internal database to be associated with the command. If the command is a read function, the data received in the response message is placed at the specified location. If the command is a write function, data used in the command is sourced from a specified data area.
Poll Interval	0 to 65535	Specifies the minimum interval to execute continuous commands. The parameter is entered in 1/10 of a second. If a value of 100 is entered for a command the command executes no more frequently that every 10 seconds.
Reg Count	1-125	Specifies the number of data points to be read from or written to the target audience.
Swap Code	None Word Swap Word and Byte Swap Byte Swap	Specifies if the data from the server is to be ordered differently than it was received. This parameter is typically used when dealing with floating-point or other multi-register values. None - No change is made (abcd) Word Swap - The words are swapped (cdab) Word and Byte Swap - The words and bytes are swapped (dcba) Byte Swap - The bytes are swapped (badc).
IP Address	xxx.xxx.xxx.xxx	Specifies the IP address of the target device to be addressed by this command.
Slot	-1	Use a value of -1 when interfacing to an SLC 5/05. These devices do not have a slot parameter. When addressing a processor in a ControlLogix or CompactLogix rack, the slot number corresponds to the slot in the rack containing the controller being addressed.
Func Code	501 509	Specifies the function code to be used in the command. 501 - Protected Typed Read 509 - Protected Typed Write
File Type	Binary Counter Timer Control Integer Float ASCII String Status	Specifies the file type to be associated with the command.
File Number	-1	Specifies the PLC-5 file number to be associated with the command. If a value of -1 is entered for the parameter, the field will not be used in the command, and the default file will be used.
Element Number		Specifies the element in the file where the command will start.
Comment		This field can be used to give a 32-character comment to the command.

Class 3 Client/UClient [x] Commands SLC500 3 Address Fields

Parameter	Value	Description
Enable	Enable Disable Conditional Write	Specifies if the command should be executed and under what conditions. Enable - The command is execute each scan of the command list. Disable - The command is disabled and will not be executed. Conditional Write - The command executes only if the internal data associated with the command changes.
Internal Address	0 to 3999	Specifies the database address in the module's internal database to be associated with the command. If the command is a read function, the data received in the response message is placed at the specified location. If the command is a write function, data used in the command is sourced from a specified data area.
Poll Interval	0 to 65535	Specifies the minimum interval to execute continuous commands. The parameter is entered in 1/10 of a second. If a value of 100 is entered for a command the command executes no more frequently that every 10 seconds.
Reg Count	1 to 125	Specifies the number of data points to be read from or written to the target device.
Swap Code	None Word Swap Word and Byte Swap Byte Swap	Specifies if the data from the server is to be ordered differently than it was received. This parameter is typically used when dealing with floating-point or other multi-register values. None - No change is made (abcd) Word Swap - The words are swapped (cdab) Word and Byte Swap - The words and bytes are swapped (dcba) Byte Swap - The bytes are swapped (badc).
IP Address	xxx.xxx.xxx.xxx	Specifies the IP address of the target device to be addressed by this command.
Slot	-1	Use a value of -1 when interfacing to an SLC 5/05. These devices do not have a slot parameter. When addressing a processor in a ControlLogix or CompactLogix rack, the slot number corresponds to the slot in the rack containing the controller being addressed.
Func Code	502 510 511	Specifies the function code to be used in the command. 502 - Protected Typed Read 510 - Protected Typed Write 511 - Protect Typed Write w/Mask
File Type	Binary Counter Timer Control Integer Float ASCII String Status	Specifies the file type to be associated with the command.
File Number	-1	Specifies the PLC-5 file number to be associated with the command. If a value of -1 is entered for the parameter, the field will not be used in the command, and the default file will be used.
Element Number		Specifies the element in the file where the command will start.
Sub-Element		Specifies the sub-element to be used with the command. Refer to the AB documentation for a list of valid sub-element codes.
Comment		This field can be used to give a 32-character comment to the command.

Class 3 Client/UClient [x] Commands PLC5 Binary

Parameter	Value	Description
Enable	Enable Disable Conditional Write	Specifies if the command should be executed and under what conditions. Enable - The command is executed each scan of the command list. Disable - The command is disabled and will not be executed. Conditional Write - The command executes only if the internal data associated with the command changes.
Internal Address	0 to 3999	Specifies the database address in the module's internal database to be associated with the command. If the command is a read function, the data received in the response message is placed at the specified location. If the command is a write function, data used in the command is sourced from a specified data area.
Poll Interval	0 to 65535	Specifies the minimum interval to execute continuous commands. The parameter is entered in 1/10 of a second. If a value of 100 is entered for a command the command executes no more frequently than every 10 seconds.
Reg Count	1 to 125	Specifies the number of data points to be read from or written to the target device.
Swap Code	None Word Swap Word and Byte Swap Byte Swap	Specifies if the data from the server is to be ordered differently than it was received. This parameter is typically used when dealing with floating-point or other multi-register values. None - No change is made (abcd) Word Swap - The words are swapped (cdab) Word and Byte Swap - The words and bytes are swapped (dcba) Byte Swap - The bytes are swapped (badc).
IP Address	xxx.xxx.xxx.xxx	Specifies the IP address of the target device to be addressed by this command.
Slot	-1	Use a value of -1 when interfacing to an SLC 5/05. These devices do not have a slot parameter. When addressing a processor in a ControlLogix or CompactLogix rack, the slot number corresponds to the slot in the rack containing the controller being addressed.
Func Code	100 101 102	Specifies the function code to be used in the command. 100 - Word Range Write 101 - Word Range Read 102 - Read-Modify-Write
File Type	Binary Counter Timer Control Integer Float ASCII String Status	Specifies the file type to be associated with the command.
File Number	-1	Specifies the PLC-5 file number to be associated with the command. If a value of -1 is entered for the parameter, the field will not be used in the command, and the default file will be used.
Element Number		Specifies the element in the file where the command will start.
Sub-Element		Specifies the sub-element to be used with the command. Refer to the AB documentation for a list of valid sub-element codes.
Comment		This field can be used to give a 32-character comment to the command.

Class 3 Client/UClient [x] Commands PLC5 ASCII

Parameter	Value	Description
Enable	Enable Disable Conditional Write	Specifies if the command should be executed and under what conditions. ENABLE - The Command is executed each scan of the command list DISABLE - The command is disabled and will not be executed CONDITIONAL WRITE - The Command executes only if the internal data associated with the command changes
Internal Address	0 to 3999	Specifies the database address in the modules internal database to be associated with the command. If the command is a read function, the data received in the response message is placed at the specified location. If the command is a write function data used in the command is sourced from specified location.
Poll Interval	0 to 65535	Specifies the minimum interval to execute continuous commands. The parameter is entered in 1/10 of a second. If a value of 100 is entered for a command the command executes no more frequently than every 10 seconds.
Reg Count	1 to 125	Specifies the number of data points to be read from or written to the target device.
Swap Code	None Word swap Word and Byte swap Byte swap	Specifies if the data from the server is to be ordered differently than it was received. This parameter is typically used when dealing with floating-point or other multi-register values. NONE - No change is made (abcd) WORD SWAP - The words are swapped (cdab) WORD AND BYTE SWAP - The words and bytes are swapped (dcba) BYTE SWAP - The bytes are swapped (badc)
IP Address	xxx.xxx.xxx.xxx	Specifies IP address of the target device to be addressed by this command
Slot	-1	Specifies the slot number for the device. Use a value of -1 when interfacing to a PLC5 These devices do not have a slot parameter. When addressing a processor in a ControlLogix or CompactLogix, the slot number corresponds to the slot in the rack containing the controller being addressed.
Func Code	150 151 152	Specifies the function code to be used in the command. 150 - Word Range Write 151 - Word Range Read 152 - Read-Modify-Write
File String		Specifies the PLC-5 Address as a string. For example N10:300
Comment		Optional 32 character comment for the command.

Class 3 Client/UClient [x] Commands Controller Tag Access

Parameter	Value	Description
Enable	Enable Disable Conditional Write	Specifies if the command should be executed and under what conditions. ENABLE - The Command is executed each scan of the command list DISABLE - The command is disabled and will not be executed CONDITIONAL WRITE - The Command executes only if the internal data associated with the command changes
Internal Address	0 to 3999	Specifies the database address in the modules internal database to be associated with the command. If the command is a read function, the data received in the response message is placed at the specified location. If the command is a write function data used in the command is sourced from the specified location.
Poll Interval	0 to 65535	Specifies the minimum interval to execute continuous commands. The parameter is entered in 1/10 of a second. If a value of 100 is entered for a command the command executes no more frequently than every 10 seconds.
Reg Count	1 to 125	Specifies the number of data points to be read from or written to the target device.
Swap Code	None Word swap Word and Byte swap Byte swap	Specifies if the data from the server is to be ordered differently than it was received. This parameter is typically used when dealing with floating-point or other multi-register values. NONE - No change is made (abcd) WORD SWAP - The words are swapped (cdab) WORD AND BYTE SWAP - The words and bytes are swapped (dcba) BYTE SWAP - The bytes are swapped (badc)
IP Address	xxx.xxx.xxx.xxx	Specifies the IP address of the target device to be addressed by this command
Slot	-1	Specifies the slot number for the device. Use a value of -1 when interfacing to a PLC5 These devices do not have a slot parameter. When addressing a processor in a ControlLogix or CompactLogix, the slot number corresponds to the slot in the rack containing the controller being addressed.
Func Code	332 333	Specifies the function code to be used in the command. 332 - CIP Data Table Read 333 - CIP Data Table Write
Data Type	Bool SINT INT DINT REAL DWORD	Specifies the data type of the target controller tag name.
Tag Name		Specifies the controller tag in the target PLC.
Offset	0 to 3999	Specifies the offset database where the value corresponds to the Tag Name parameter.
Comment		Optional 32 character comment for the command.

Class 3 Client/UClient [x] Commands Basic

Parameter	Value	Description
Enable	Enable Disable Conditional Write	Specifies if the command should be executed and under what conditions. ENABLE - The command is executed each scan of the command list DISABLE - The command is disabled and will not be executed CONDITIONAL WRITE - The command executes only if the internal data associated with the command changes
Internal Address	0 to 3999	Specifies the database address in the module's internal database to be associated with the command. If the command is a read function, the data received in the response message is placed at the specified location. If the command is a write function data used in the command is taken from the specified location.
Poll Interval	0-65535	Specifies the minimum interval to execute continuous commands. The parameter is entered in 1/10 of a second. If a value of 100 is entered for a command the command executes no more frequently than every 10 seconds.
Reg Count	1 to 125	Specifies the number of data points to be read from or written to the target device.
Swap Code	None Word swap Word and Byte swap Byte swap	Specifies if the data from the server is to be ordered differently than it was received. This parameter is typically used when dealing with floating-point or other multi-register values. NONE - No change is made (abcd) WORD SWAP - The words are swapped (cdab) WORD AND BYTE SWAP - The words and bytes are swapped (dcba) BYTE SWAP - The bytes are swapped (badc)
IP Address	xxx.xxx.xxx.xxx	Specifies the IP address of the target device to be addressed by this command
Slot	-1	The slot should always be -1.
Func Code	1 2 3 4 5	Specifies the function code to be used in the command. 1 - Protected Write 2 - Unprotected Read 3 - Protected Bit Write 4 - Unprotected Bit Write 5 - Unprotected Write
Word Address		Specifies the word address where to start the operation.
Comment		Optional 32 character comment for the command.

3.9 Configuring the EIP Processor Path

The EIP Processor Path parameter allows you to set or change the IP address of a device being addressed by a command. For example, a PLC. Settings here specify the information required to identify where alarms are to be sent.

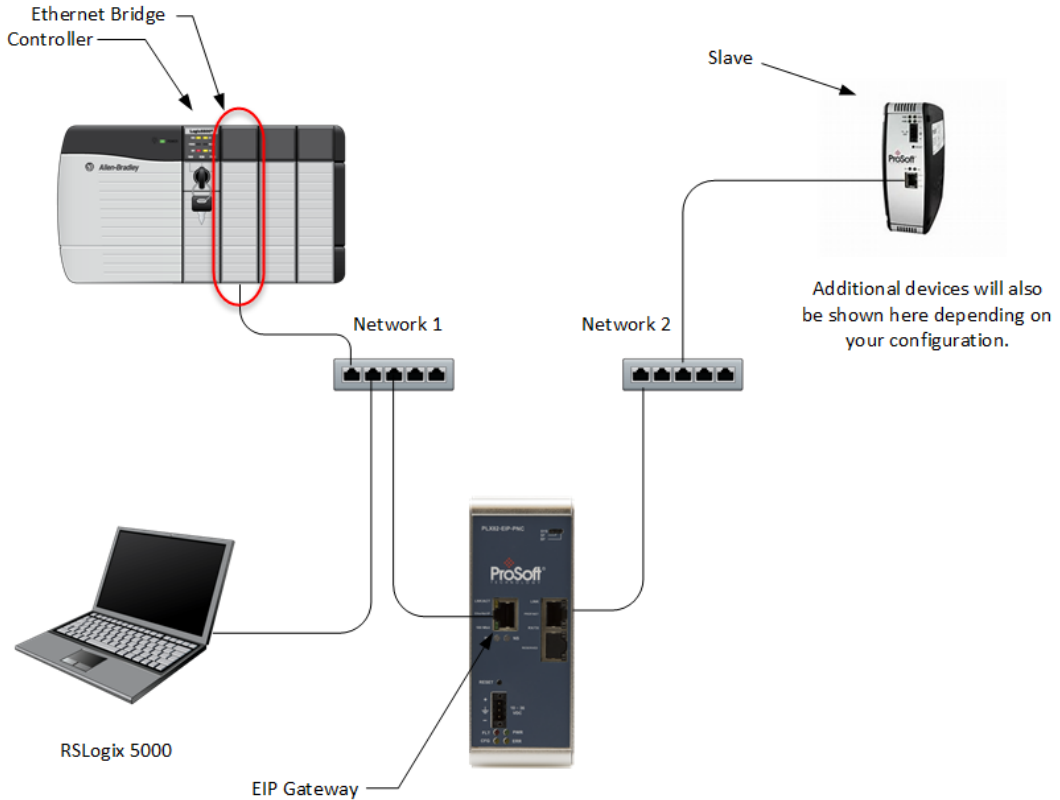

- 1 To edit the EIP Processor path, expand the *EIP Processor Path* selection and click on **PLX82-EIP-PNC > EIP PROCESSOR PATH > EIP PROCESSOR PATH**.

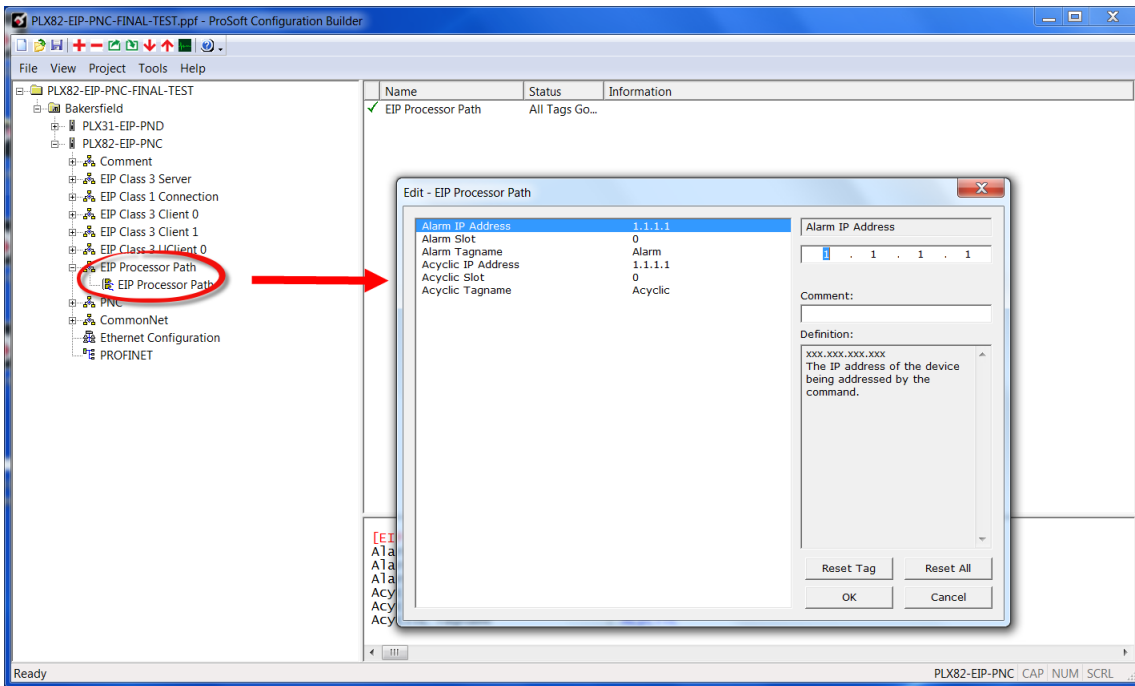

Parameter	Description
Alarm IP Address	This is the IP address of the device being addressed by the command.
Alarm Slot	Use a value of -1 when interfacing to a SLC 5/05 or a PLC5. These devices do not have a slot parameter. When addressing a processor, the slot number corresponds to the slot in the rack containing the controller being addressed. In the platform, the controller can be placed in any slot and the rack may contain multiple processors. This parameter uniquely selects a controller in the rack.
Alarm TagName	A name assigned to the alarm.
Acyclic IP Address	The IP address of the device being addressed by the command.
Acyclic Slot	Use a value of -1 when interfacing to a SLC 5/05 or a PLC5. These devices do not have a slot parameter. When addressing a processor, the slot number corresponds to the slot in the rack containing the controller being addressed. In the platform, the controller can be placed in any slot and the rack may contain multiple processors. This parameter uniquely selects a controller in the rack.
Acyclic Tagname	A name assigned to the acyclic alarm.

- 2 Click **OK**.

4 Configuring the PROFINET Controller

Note: ProSoft fdt Configuration Software incorrectly allows for up to 36 PROFINET devices to be configured with an "Update rate" as low as 1ms. Since that configuration can produce over 70,000 frames per second, the PROFINET controller and devices will experience errors. ProSoft Technology is in the process of adding limitations to the configuration software, and until then, we have produced a guideline document to aid in the proper configuration of the PROFINET controller. This guideline is available from the ProSoft website, accessible from the PLX82-EIP-PNC product page. The file is named "ProSoft-PROFINET-Net-Load-Calculator+v4.xlsx.

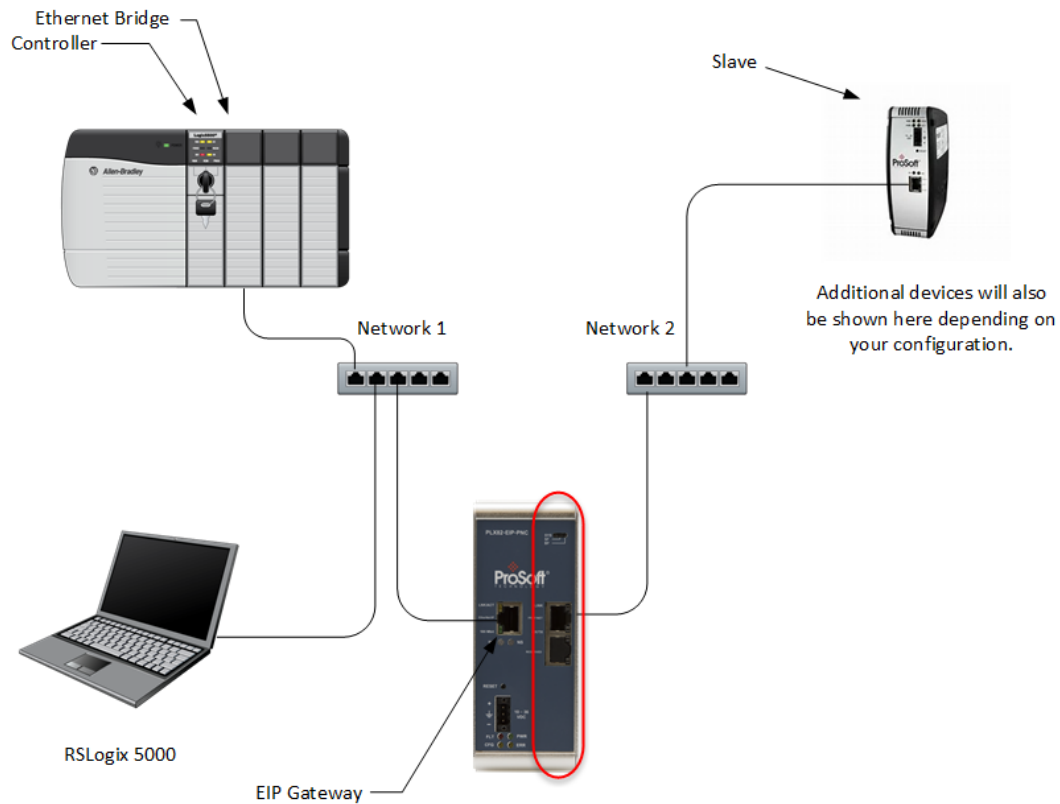

- 1 From the PCB window, double-click on the **PROFINET** icon.

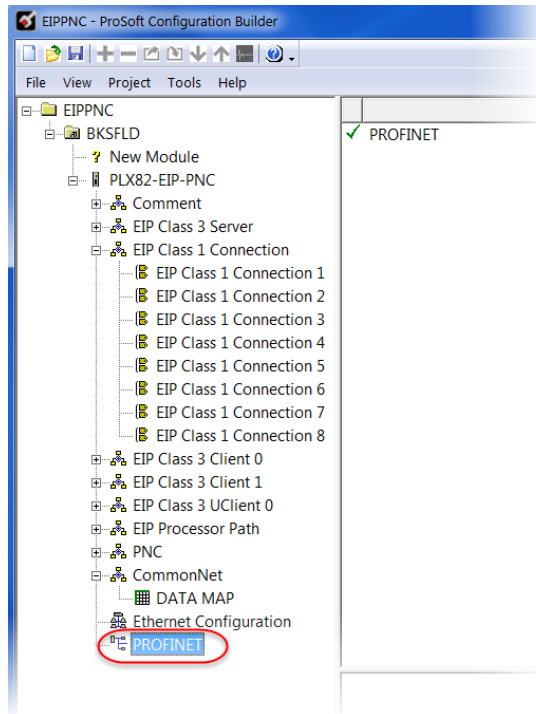

- 2 This opens the *ProSoft fdt Configuration Manager* network view.

Note: If you have not already saved the project file, you are prompted to do so before you can proceed.

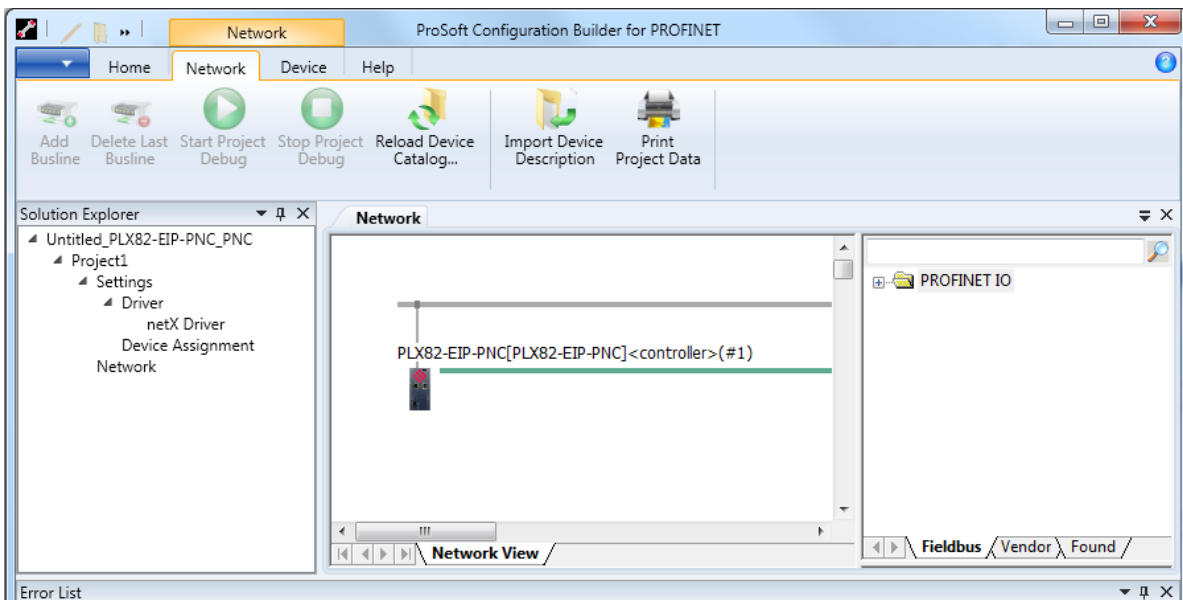

3 Double-click on the **PLX82-EIP-PNC** icon.

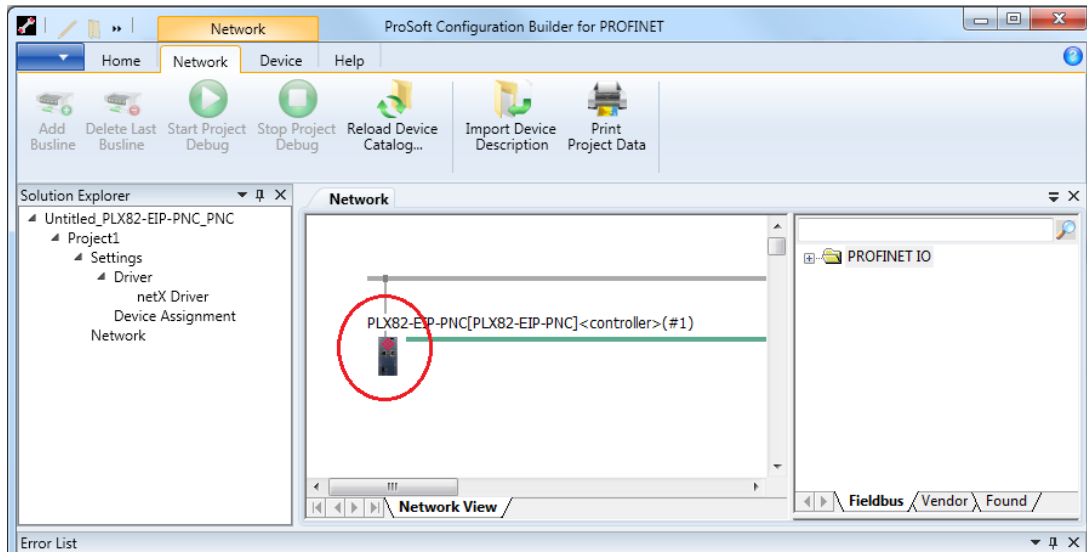

4 This opens the *Controller Network Settings* window.

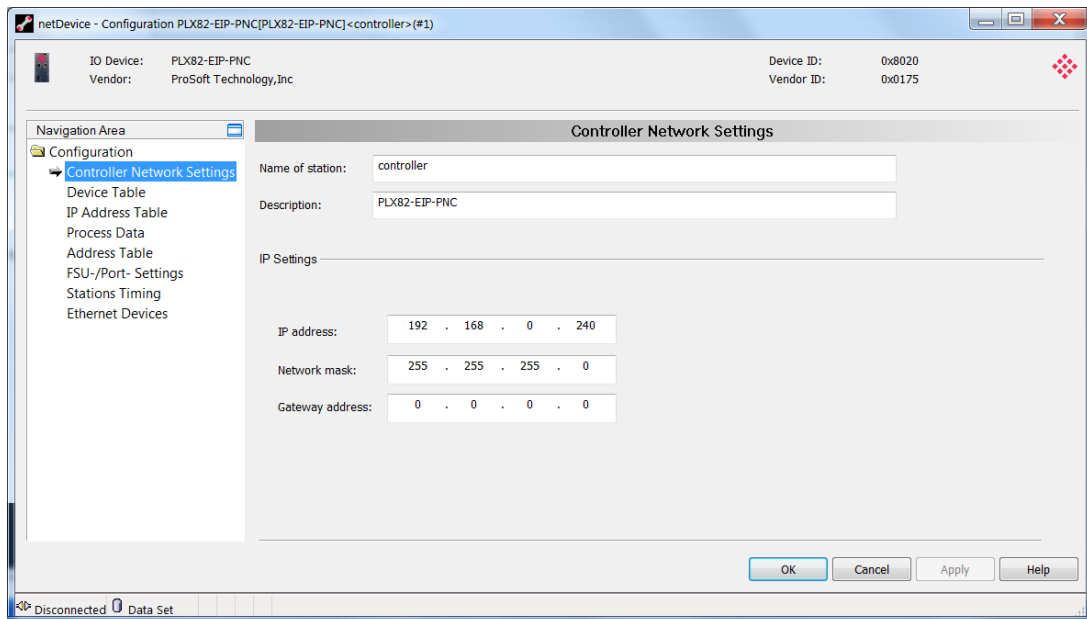

- 5 Click on **CONTROLLER NETWORK SETTINGS** located in the *Navigation Area* pane of the *netDevice Configuration* window.
- 6 Set the name of the station for the controller, provide a description, and IP address.
- 7 When complete, click **OK**.

4.1 Importing GSD Files

PROFINET Device information files (typically GSD or GSDML) must be imported for all devices you intend to connect to through the PLX82-EIP-PNC. GSD and GSDML files are available from the PROFINET device manufacturer.

Important:

- For devices with GSDML XML Schema version 1.0, every module has one submodule assigned. No additional submodules can be added, and the assigned submodule cannot be removed.
- For devices with GSDML XML Schema version 2.0, you can configure the submodules, and these submodules can be added or removed from the corresponding module.
- The GSDML file differentiates between **fixed in slot**, **used in slot**, and **allowed in slot** modules. *Fixed in slot* and *Used in slot* modules are automatically configured. **Allowed in slot** modules can be configured.

- 1 Click on the **NETWORK** tab and then click on the **IMPORT DEVICE DESCRIPTION** icon.

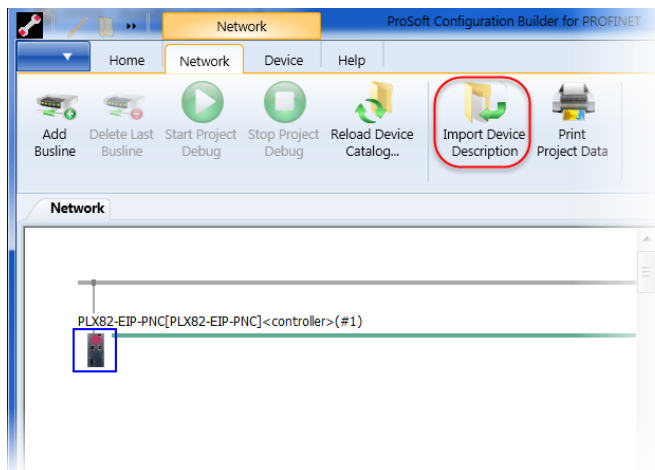

- 2 Navigate to the location of your GSD or GSDML files and select the appropriate files for your devices.

- 3 Click **OPEN** and then click **YES**. The GSD file is displayed in the right pane.

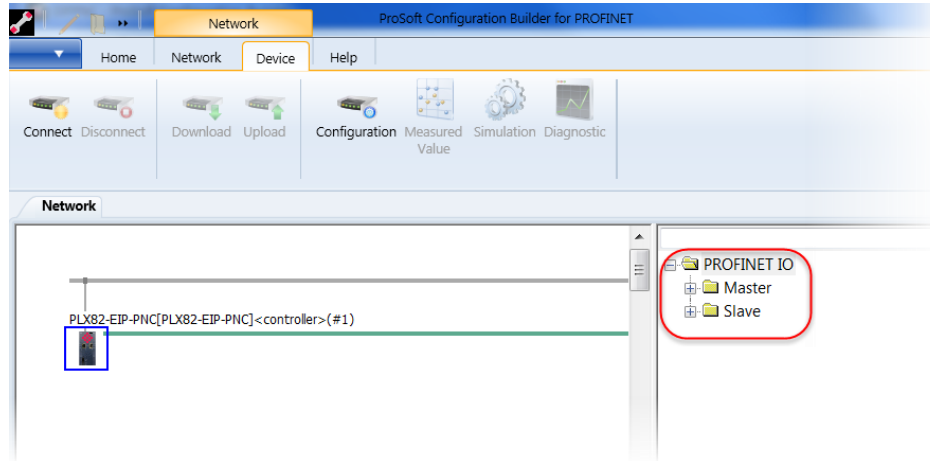

- 4 Open the device folder to display the device icon(s).

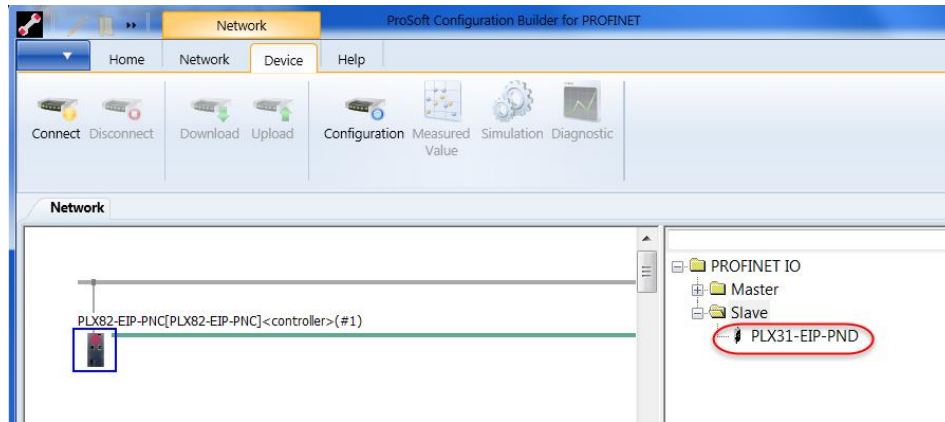

4.2 Adding a Slave Device to the Project

- 1 Locate the slave from the *Slave Catalog*.

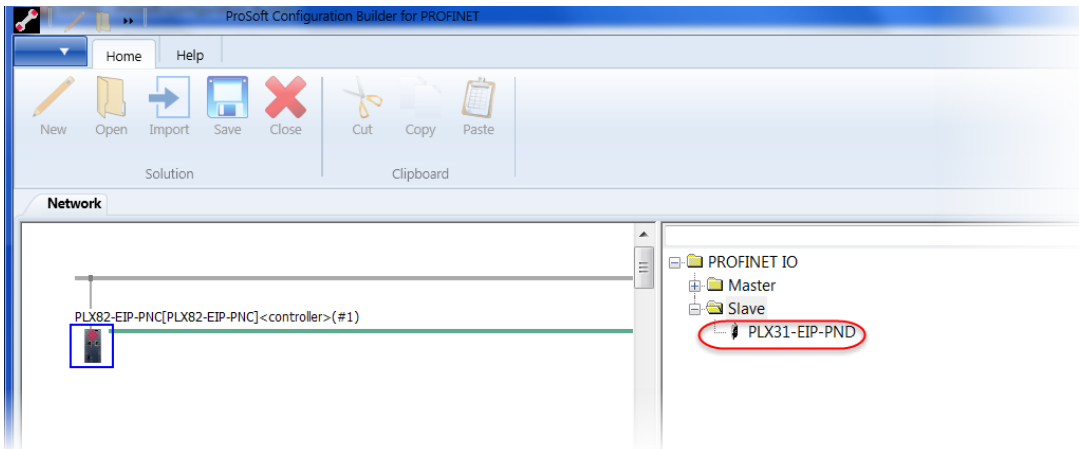

- 2 Drag and drop the slave onto the PROFINET bus line.

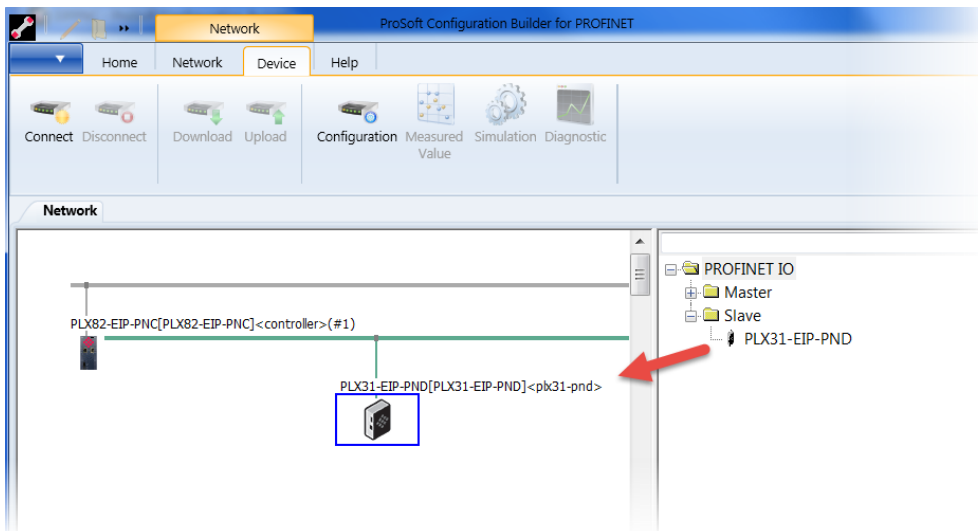

- 3 If you are installing multiple slave devices, perform the same steps to add them to the network.

4.3 Configuring a Slave Device

This procedure configures all PROFINET slave devices for the PNC. As slaves are configured, configuration information is automatically placed in the PLX82-EIP-PNC. This information is visible by double-clicking on the **PLX82-EIP-PNC** icon.

Note: The diagram only shows one slave device. All slaves on the network must be defined and configured according to the following steps:

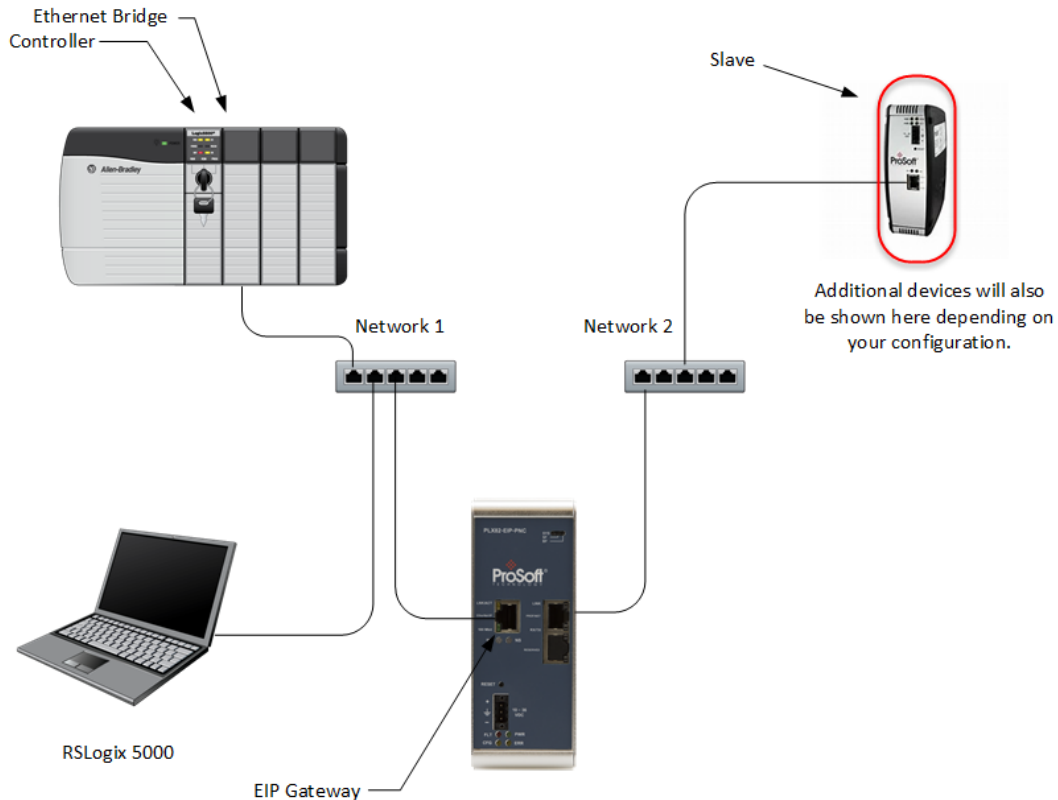

- 1 Double-click on the slave device.
- 2 Click the **ADD MODULE** button.
- 3 Select an *Input* or *Output* space allocation.
- 4 Repeat the steps 2 and 3 above for additional Inputs or Outputs.

5 When complete, click **APPLY** and then click **OK**.

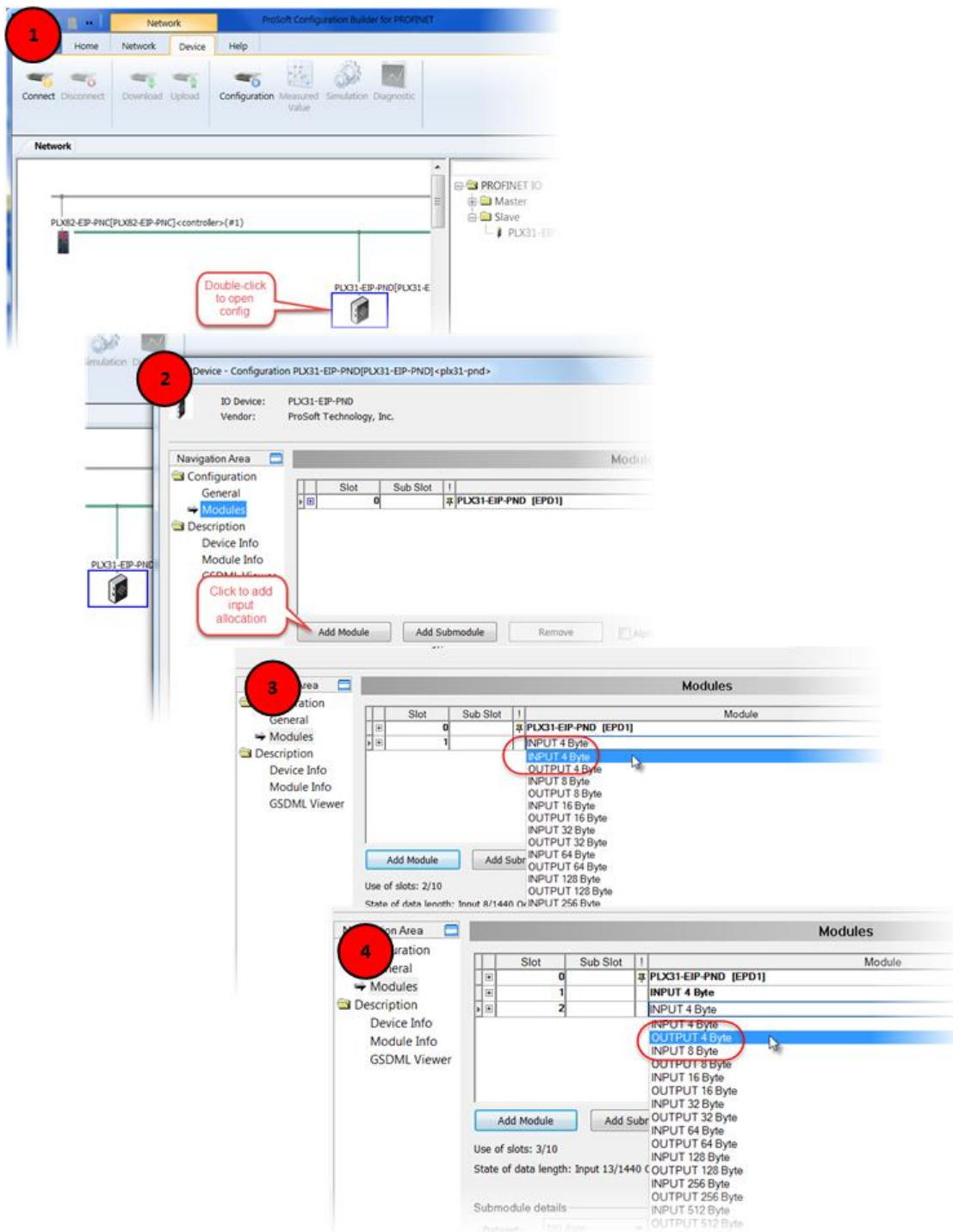

Parameter	Description
Slot	Displays the slot number assigned to the module. Clicking on the slot field displays a drop-down list of free slot numbers. Changing the slot number changes the sequence of the modules.
Sub Slot	Displays the sub slot assigned to a sub module. Clicking on the sub slot field displays a drop-down list of free sub slot numbers.
!	Slot icon tag. This indicates the usage of the submodule An icon in this field indicates that the Slot number, subslot number and module name are not changeable. No icon in this field indicates that the slot number, subslot number and module name are changeable.
Module	Module name as defined in the GSDML file.
Add Module button	Adds a module to the device configuration below the current line.
Add Submodule button	Add a submodule to the selected module of the device configuration below the current line.
Remove button	Removes the selected submodule from the configuration below the current line.
-	The arrow icon shows the current line in the table. This line is the reference for Add Module, Add Submodule, and Remove.

Note: Not all devices support sub-modules.

4.4 Verifying Slave Device Information

Slave devices are automatically configured. As configured, the new information is immediately visible in the module. To view device information, double-click on the **PLX82-EIP-PNC** module icon and then select the appropriate link.

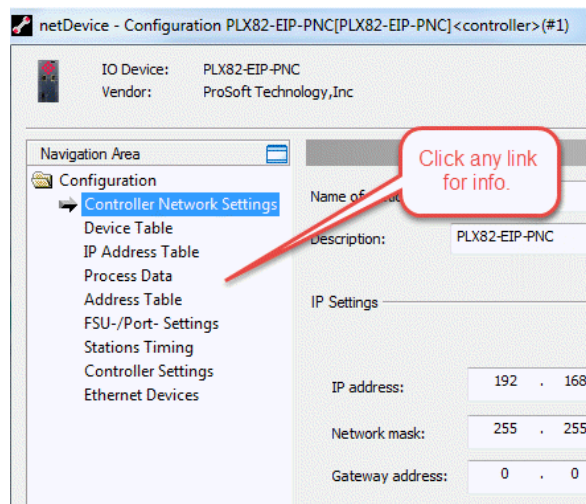

4.4.1 Controller Network Settings

Controller Network Settings display the following information:

- Name of Station
- Description of the station
- IP Address, Network Mask, and Gateway Address

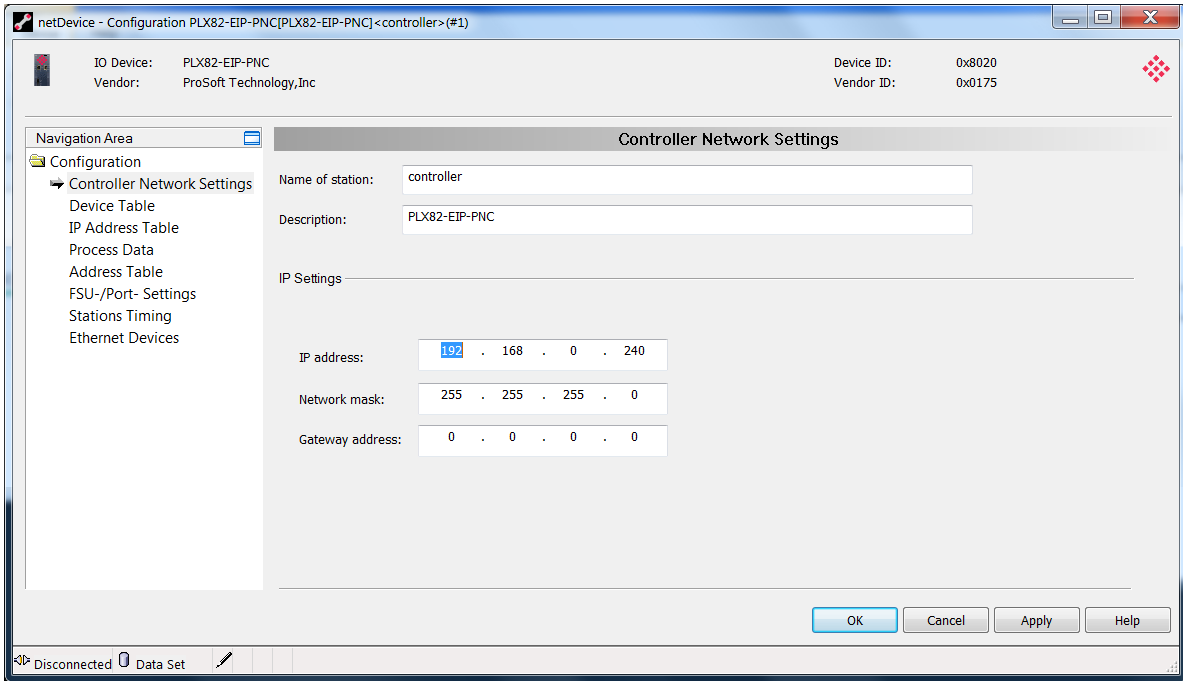

Parameter	Description
Name of Station	Network name of the PROFINET controller. This must be a DNS compatible name. 1 - 240 characters.
Description	Symbolic name of the PROFINET controller DTM.
IP Settings	
IP Address	IP address of the PROFINET controller.
Network Mask	Network mask of the PROFINET controller.
Gateway Address	Gateway address of the PROFINET controller.

4.4.2 Device Table

The *Device Table* lists all devices connected and configured in the PROFINET Controller.

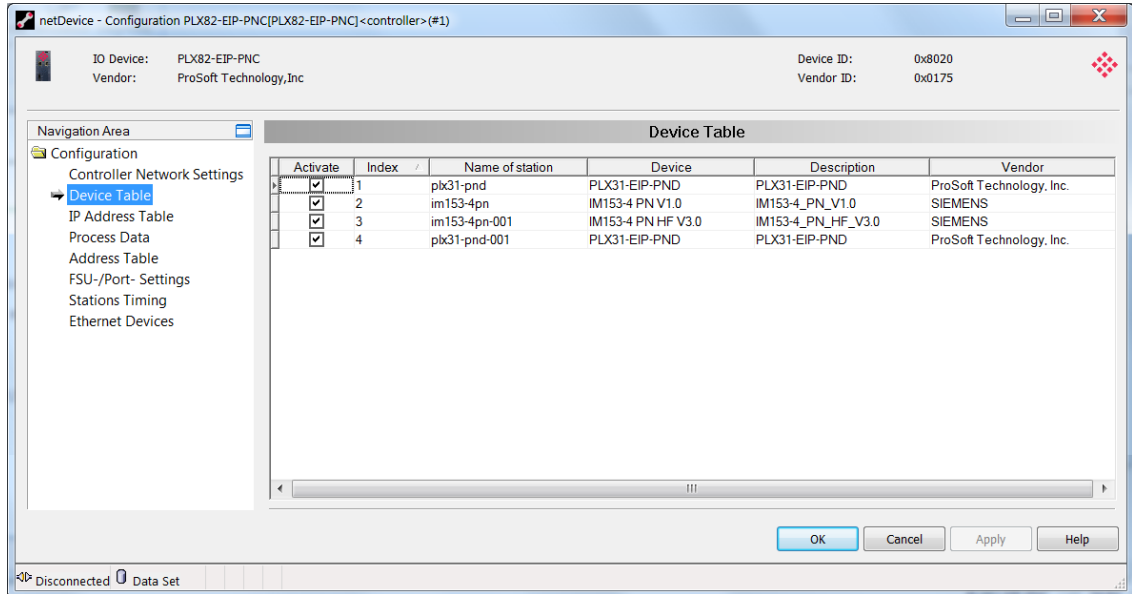

Parameter	Description
Activate	Use this checkbox to activate or deactivate a station
Index	This is editable. This allows you to set a user-defined sequence for the configured devices. However, when using acyclic messaging, the sequence always starts at 0. Therefore, the Device ID of the first slave in this list would actually be Index 0, followed by 1, 2, 3, etc.
Name of Station	Name of the device.
Device	Actual device name of the slave as specified in the GSD or GSDML file.
Description	Description of the device.
Vendor	Name of the vendor of the device.

You can activate and deactivate configured devices from this table. Simply click the checkbox to to clear the checkmark or click to place a checkmark which enables the device.

To change the Index number...

- 1 Click on the **INDEX** number to be changed.

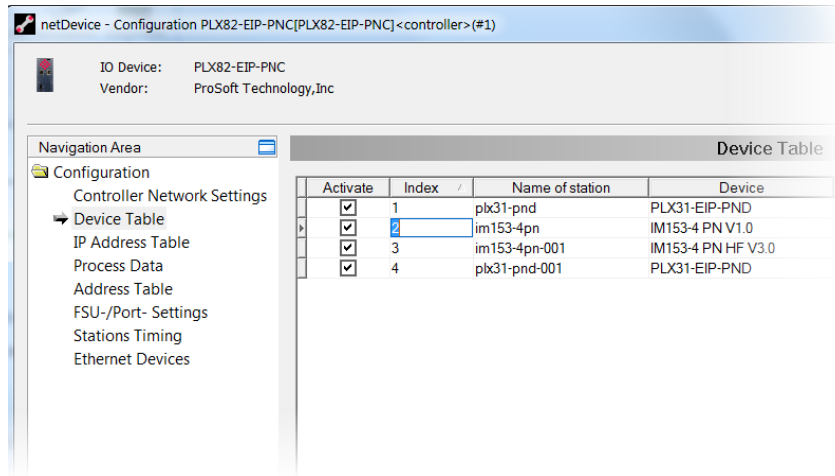

- 2 Edit the Index number.
- 3 Click **OK** when done.

To change the name of the station...

- 1 Click on the *Name of Station* to be changed.
- 2 Edit the *Name of Station*.
- 3 When complete, click **OK**.

4.4.3 IP Address Table

The *IP Address Table* shows the IP address of each connected slave device. The IP address is assigned automatically based on incrementing the last octet based on the IP address of the PLX82-EIP-PNC. For example, if the controller IP address is 192.168.0.240, the first device added will have an IP address of 192.168.0.241.

Use this pane to view or change IP addresses. Changes to the *Network Mask* or *Gateway* address are not possible with the **INHERIT** checkbox checked. 'Checked' indicates that the *Network Mask* and *Gateway* address are taken from the controller.

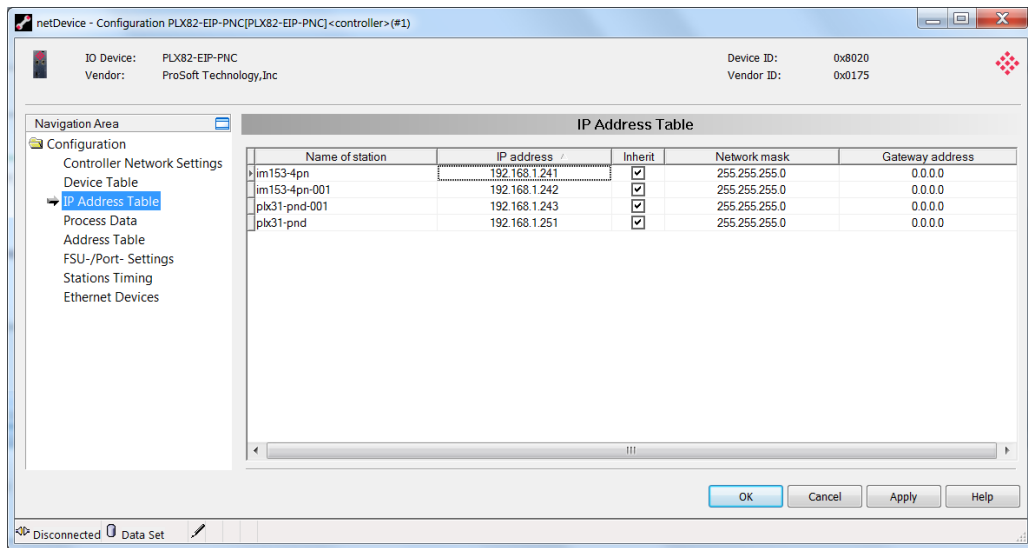

Parameter	Description
Name of station	This is the name of the slave device.
IP Address	This is the IP address of the slave device. The PNC transmits the IP address of the slaves during startup.
Inherit	Indicates whether the Network Mask and the Gateway Address are taken from the controller.
Network Mask	This is the network mask of the slave device. The PNC transmits the network mask of the slave during startup to the slave, thereby configuring the device.
Gateway address	This is the gateway address of the slave device. The PNC transmits the gateway address to the slave over the network, thereby configuring the device.

To change the IP address...

- 1 Click on the IP address in the *IP address* column and enter the new address. The *Network Mask* and *Gateway* address columns are only editable with the **INHERIT** checkbox unchecked.
- 2 Click **APPLY**, then **OK**.

4.4.4 Process Data

The *Process Data* table serves as an external process data interface (for data transfer to a PLC unit). It lists the devices connected to the controller, and well as configured modules or input or output signals of the devices. This makes the fieldbus structure visible.

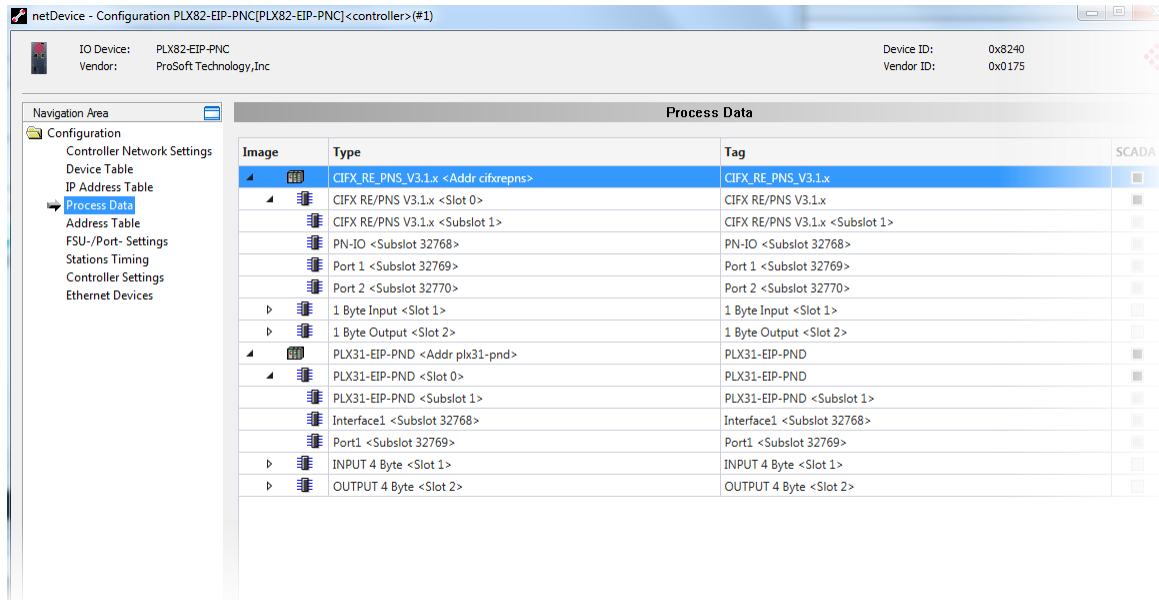

Parameter	Description
Type	Device label provided by the hardware. Provides a description of the modules or input or output signals configured to the device.
Tag	Device name provided by the hardware (not changeable) or the symbolic name for the modules configured to the device or input/output signals (changeable).
SCADA	Indicates which module or single data is provided for the OPC server.

4.4.5 Address Table

The *Address Table* displays a list of all addresses used in the process data image. The displayed addresses refer to the PROFINET Controller (PNC). This page allows you to view current input and output data sizes per slave device.

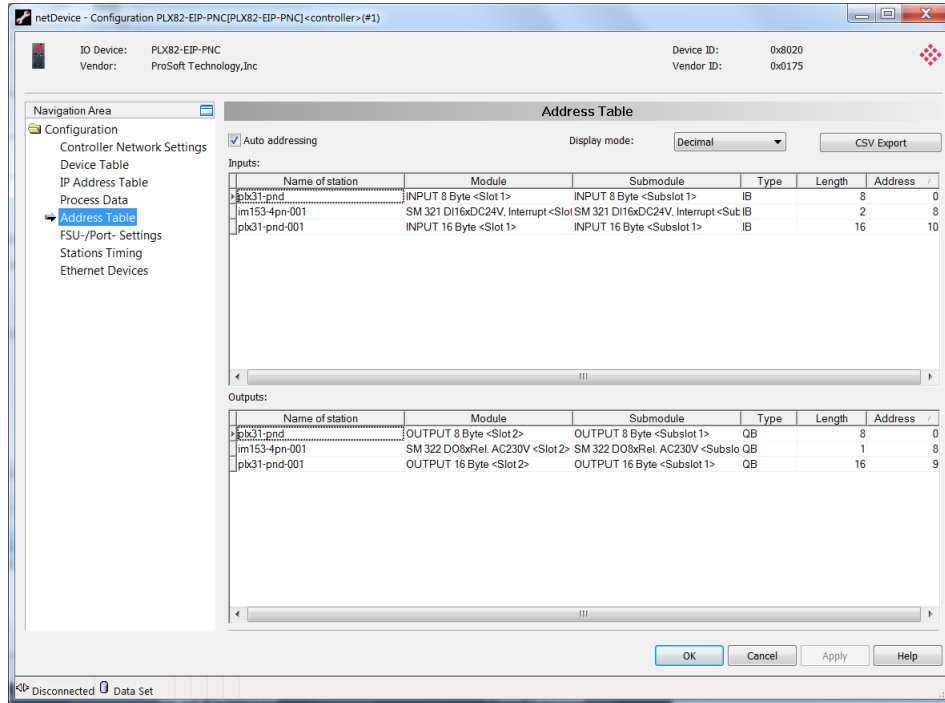

Parameter	Description
Auto addressing	Selected by default. If you want to set addresses manually, this checkbox must be unchecked (see Manual address updates).
Display mode	Allows you to display the address data in decimal or hexadecimal format.

CSV Export

This option allows you to export input and output addresses as a .CSV file (comma separated values).

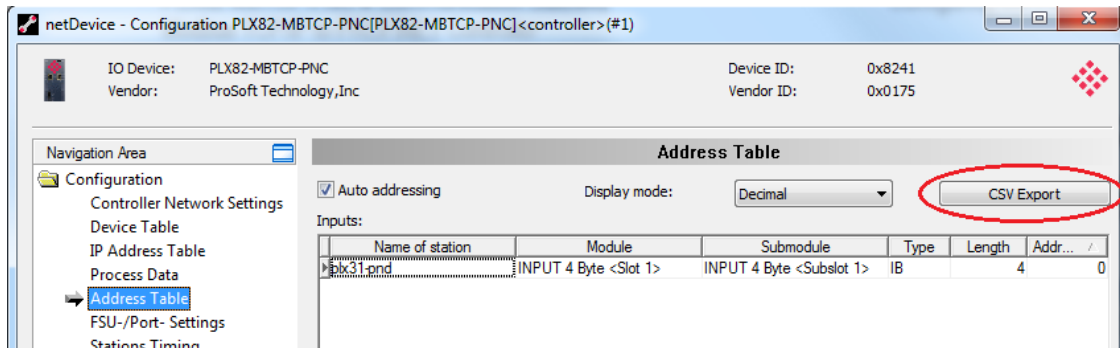

- 1 Click the **CSV EXPORT** button. The *File Save* dialog opens.
- 2 Navigate to a folder location, enter a filename, and then click **SAVE**.

The data file can be opened using a spreadsheet application or input into another application.

Manual Address Update

If manual addressing is allowed, input and output addresses of the PLX82-EIP-PNC may be assigned manually.

- 1 Uncheck the **AUTO ADDRESSING** checkbox.
- 2 Click on the address of a module.
- 3 Edit the field and type in a new address.
- 4 Click **OK**.

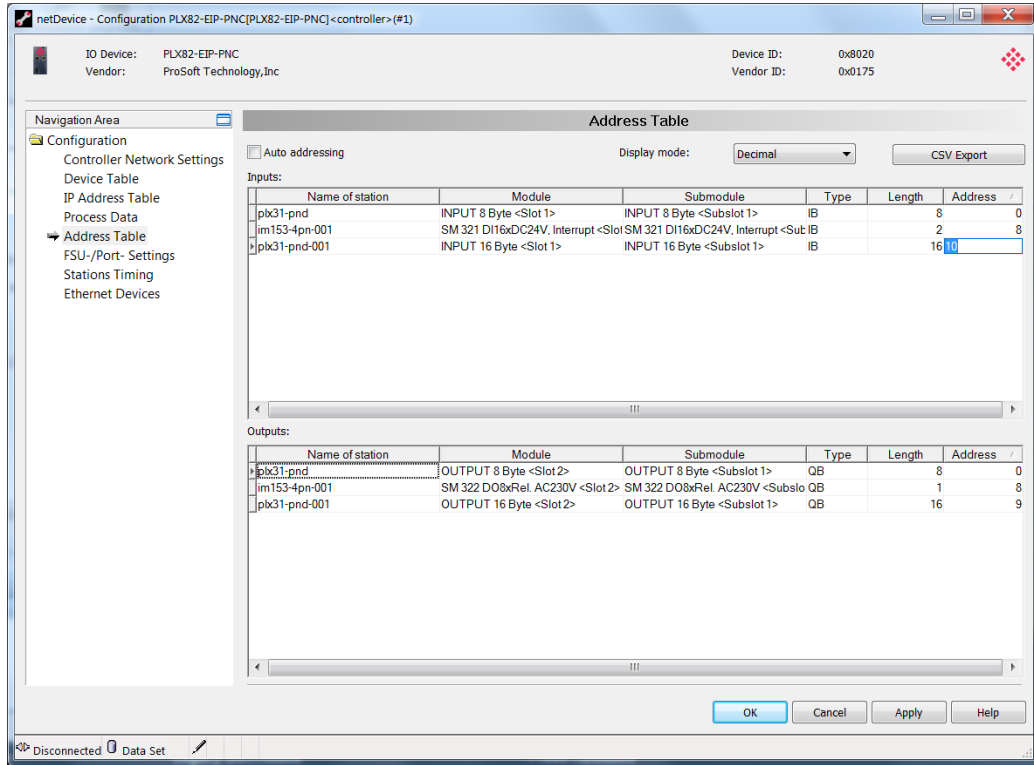

Parameter	Description
Name of Station	Symbolic name of the assigned slave device.
Module	Name of the module according to the GSD or GSDML file.
Submodule	Displays submodule information.
Type	Specifies the input data type or output data type (IB, QB, IW, or QW)
Length	Data length in bytes
Address	Output or input data offset addresses.

The configuration software reports an error if an address overlapping in the process data image was detected. If this occurs, correct the address for one of the two modules and enter an unused address.

4.4.6 FSU-/Port-Settings

The *Fast Start Up (FSU) Port Settings* pane is used to specify devices that must use a fast start up connection to establish the cyclic data exchange. Check with your device manufacturer to determine if your device must use FSU.

All existing connections from the controller to the devices are displayed, including all ports at each device.

The MAU Type indicates whether the device should establish the connection automatically or whether fixed parameters are to be used.

Note: If you enable FSU to establish a fast connection for a port, use only the MAU type "100BASETXFD". If using the AUTO setting, the Auto negotiation and Auto crossover effects will prevent establishing a fast Ethernet connection.

- 1 Select **CONFIGURATION > FSU-/PORT-SETTINGS** in the navigation area.

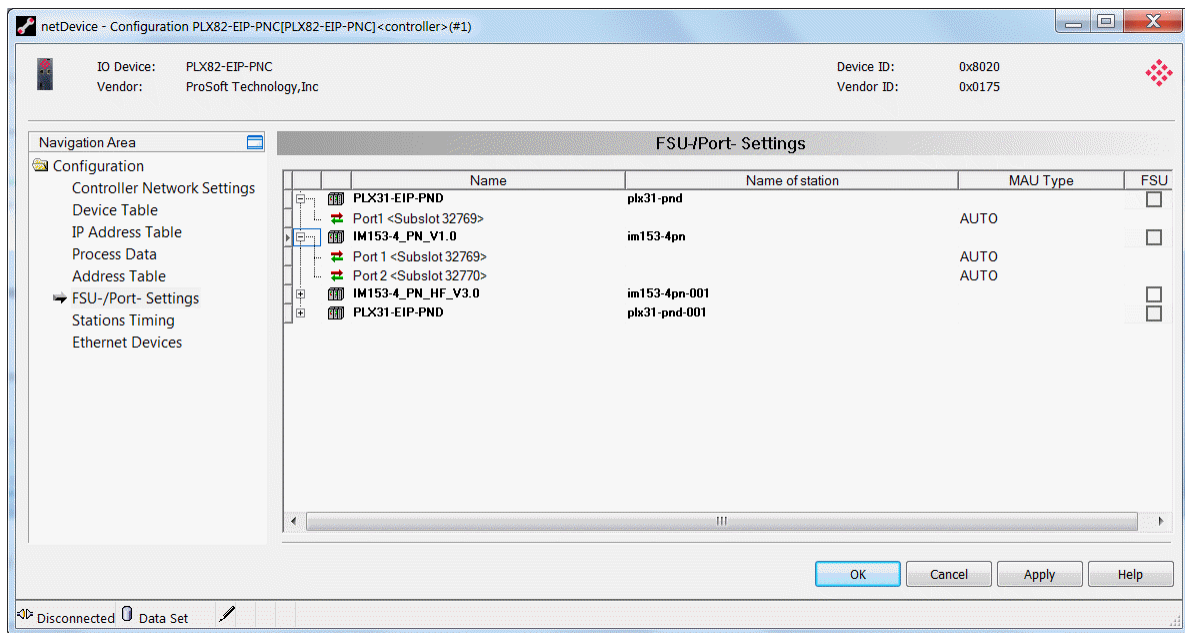

- 2 Check the **FSU** box for PROFINET devices that must use a fast startup (FSU) connection to establish cyclic data exchange.

Parameter	Description
Name	The symbolic name of the PROFINET slave device.
Name of Station	This is the network name of the slave device. The name of the device is set in the Device Table. The PNC uses the name of the station to identify the slave device and to establish communication. This name of the station here must match the name of the station set in the PROFINET I/O device.
MAU Type	The MAU type defines the physical settings (PHY) on the slave device. The MAU must be set separately for each port on the device. AUTO - Connections between devices are negotiated automatically. It may take 2-3 seconds for the physical connection to be established. 100BASETXFD - Connections between devices is fixed with 100 MBit/Full duplex. IMPORTANT FOR HARDWARE WIRING: <ul style="list-style-type: none"> ▪ Make wiring only between ports with the same port setting (MAU-type configuration). Otherwise, a connection cannot be established between the devices. ▪ Connect to ports that have different cross-over settings.
FSU	Checking this box indicates that the device is configured for fast start up connections to establish cyclic data exchange.

4.4.7 Stations Timing

The *Stations Timing* pane allows you to edit station timings.

- 1 Navigate to **CONFIGURATION > STATIONS TIMING**.
- 2 *Name of Station* - This list contains all devices associated with the PNC. Select the station from the list.

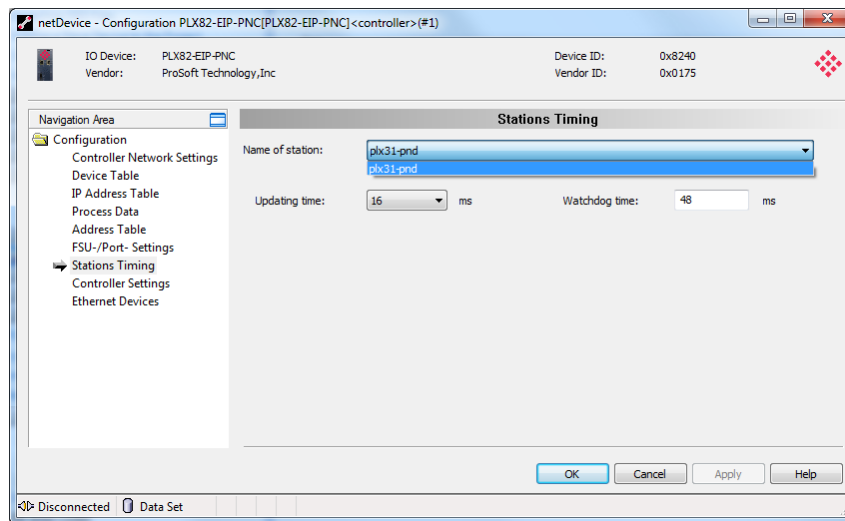

- 3 Set the *Update time* in milliseconds.
- 4 Set the *Watchdog time* in milliseconds.
- 5 Click **APPLY** to save your settings.
- 6 When complete, click **OK**.

4.4.8 Controller Settings

The *Controller Settings* pane allows you to control the behavior of the PNC controller.

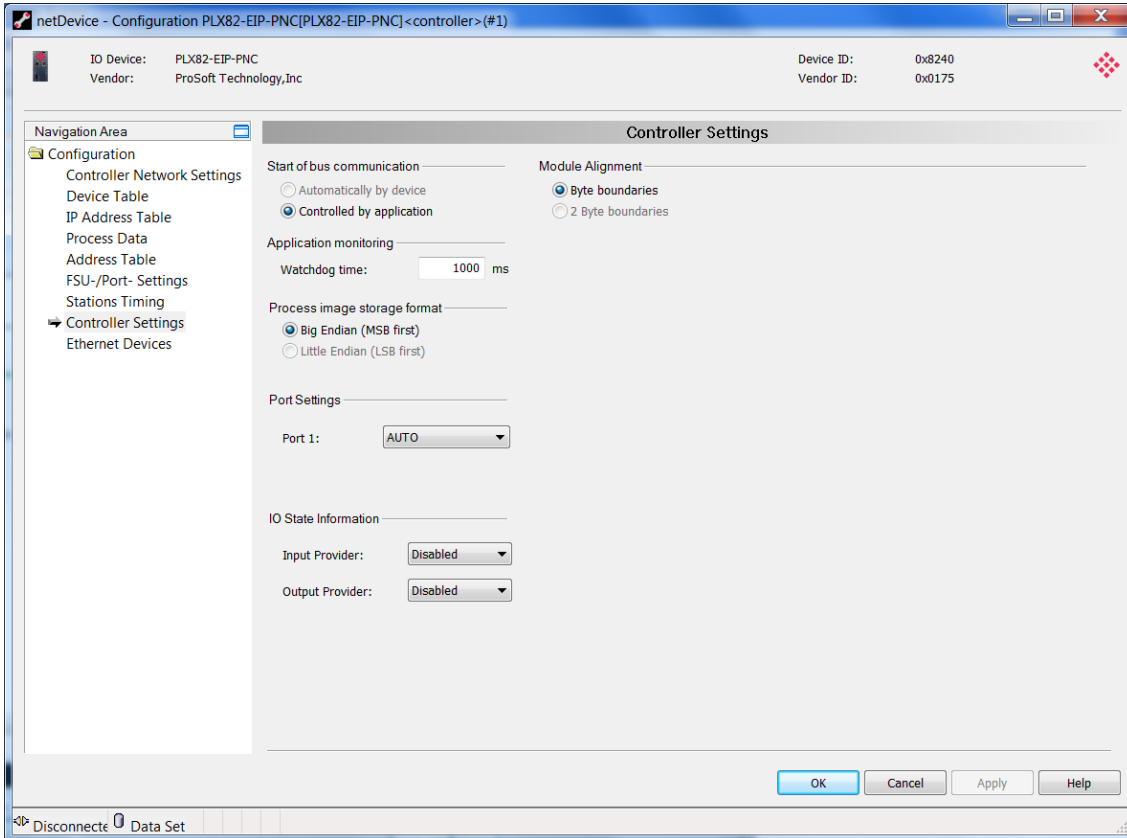

Parameter	Description								
Start of bus communication	<p>Automatically by device or Controlled by application.</p> <p>If Automatically by device, the PNC controller device starts with the data exchange on the bus after initialization has ended.</p> <p>If Controlled by application, the application program must activate data exchange on the bus.</p> <p>The default is typically set to Controlled by application.</p>								
Application monitoring	<p>Watchdog time is set per station in the Stations Timing window. This field displays the watchdog time in milliseconds. The Watchdog time determines the time in which the device watchdog must be re-triggered from the application program while the application program monitoring is activated.</p> <p>When the watchdog time value is equal to 0, the watchdog is deactivated and the application program monitoring is also deactivated.</p> <table border="1"> <thead> <tr> <th>Watchdog time</th> <th>Range of Value/Default Value</th> </tr> </thead> <tbody> <tr> <td>Permissible range of values</td> <td>20 ... 65535 ms</td> </tr> <tr> <td>Default</td> <td>1000 ms</td> </tr> <tr> <td>Deactivated</td> <td>0 ms</td> </tr> </tbody> </table>	Watchdog time	Range of Value/Default Value	Permissible range of values	20 ... 65535 ms	Default	1000 ms	Deactivated	0 ms
Watchdog time	Range of Value/Default Value								
Permissible range of values	20 ... 65535 ms								
Default	1000 ms								
Deactivated	0 ms								
Process image storage format	<p>Big Endian (Most Significant Byte first) Little Endian (Least Significant Byte first)</p>								
Port Settings	<p>Displays or selects Port 1 settings. This is used if Fast Start Up (FSU) is selected for PROFINET devices that use FSU connection to establish a cyclic data exchange.</p> <p>If FSU is check on a port, you must select 100BASETXFD. Otherwise, select AUTO.</p>								
IO State Information	<p>Input Provider - Disabled, Bit, Byte Output Provider - Disabled, Bit, Byte</p> <p>Allows you to configure the PROFINET Input/Output Object Provider State (IOPS). This allows the PNC application program to detect whether data received from a slave is valid or not and vice versa.</p> <p>Disabled - The PROFINET controller application cannot detect whether the data received from the PROFINET slaves are valid or declare its output data sent to the slaves are valid or invalid.</p> <p>Bit - IOPS is handled as a bit list. Each sub-module description is represented by a single bit. If set to 1, the data is valid. If set to 0, the data is invalid. Sub-modules with input and output data simultaneously have IOPS in input and output directions.</p> <p>Byte - In the dual-port memory (DPM) of the PNC, IOPS is handled as a byte array. Each sub-module description is represented as a byte. If the byte is set to 0x80, the data is valid. Otherwise, the data is considered invalid.</p> <p>In this mode, the entire IOPS byte is directly copied from/to the cyclic frame, providing the PNC's application program the possibility of accessing all bits of IOPS. Typically, only the first bit of the IOPS byte states whether the data is valid or invalid.</p>								
Module Alignment	<p>Byte boundaries 2 Byte boundaries</p> <p>Module Alignment defines the addressing mode of the process data image. The addresses (offsets) of the process data are always interpreted as byte addresses. The Module Alignment then defines the addressing mode.</p>								

4.4.9 Ethernet Devices

The *Ethernet Devices* pane provides a view of all slave devices on the network after performing a search. It also allows you to edit each device. The device name must match the *Name of Station* field.

- 1 Select the **ETHERNET DEVICES** icon.

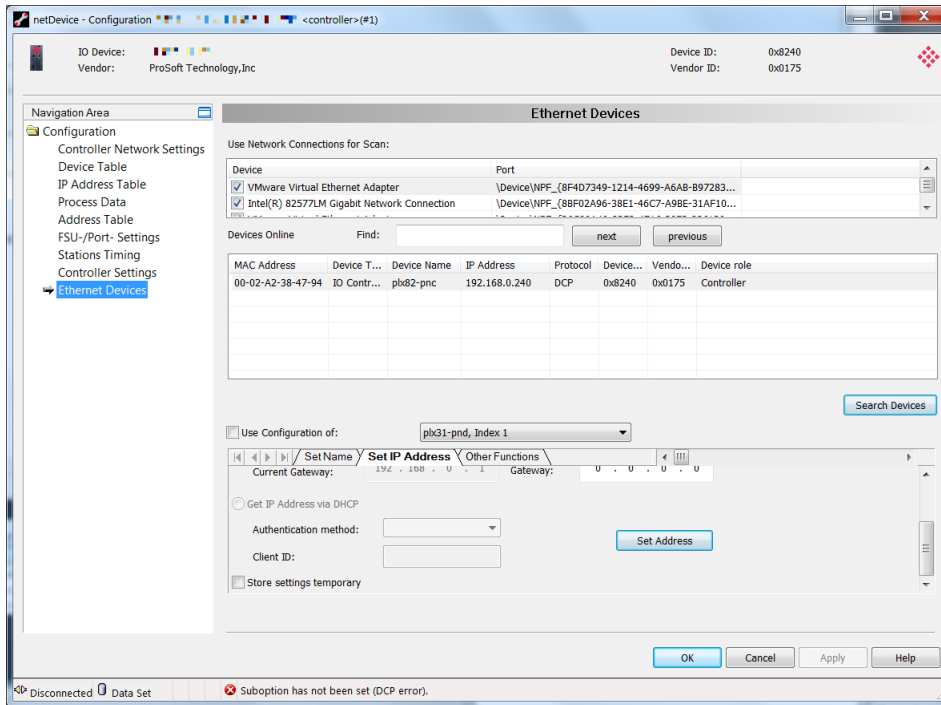

2 Click the **SEARCH DEVICES** button to start the search.

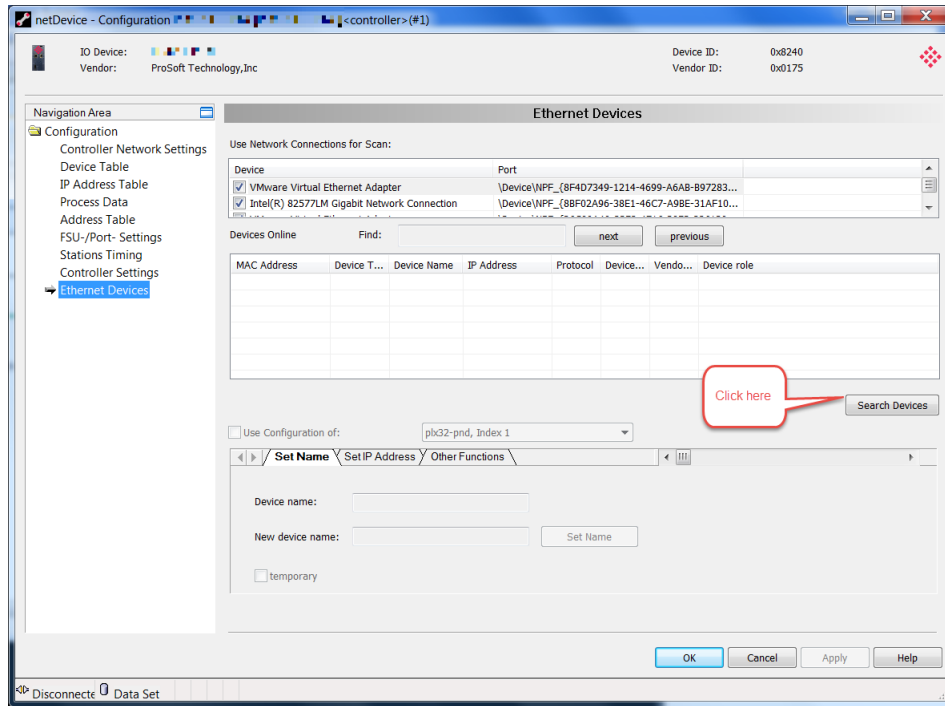

3 The current online devices appear in the grid.

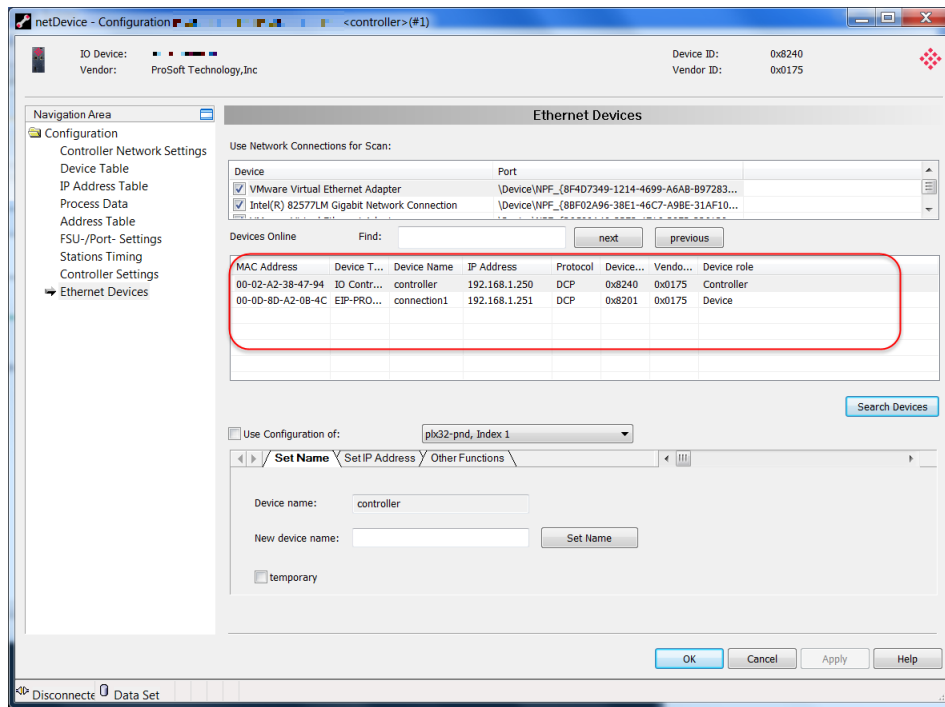

Parameter	Description
MAC Address	Unique address of the device set by the device manufacturer.
Device Type	Name given to the device that provides a description of the device.
Device Name	Name of the device as a character string defined by the manufacturer.
IP Address	IP address of the device that can be set in the IP Address Table pane. The IP address must be unique and must fit into the current network. The IP address of 0.0.0.0 indicates that no IP address has been set.
Protocol	Supported protocol of the device.
Device ID	Identification number of the device. This is fixed by the manufacturer.
Vendor ID	Identification number of the device vendor assigned by PROFIBUS.
Device Role	Description of the function that the device has on the network. For example, device, controller, multi-device, etc.

Creating New, or Using Existing Configuration Information

The lower area of the *Ethernet Devices* pane allows you to change information returned by the search.

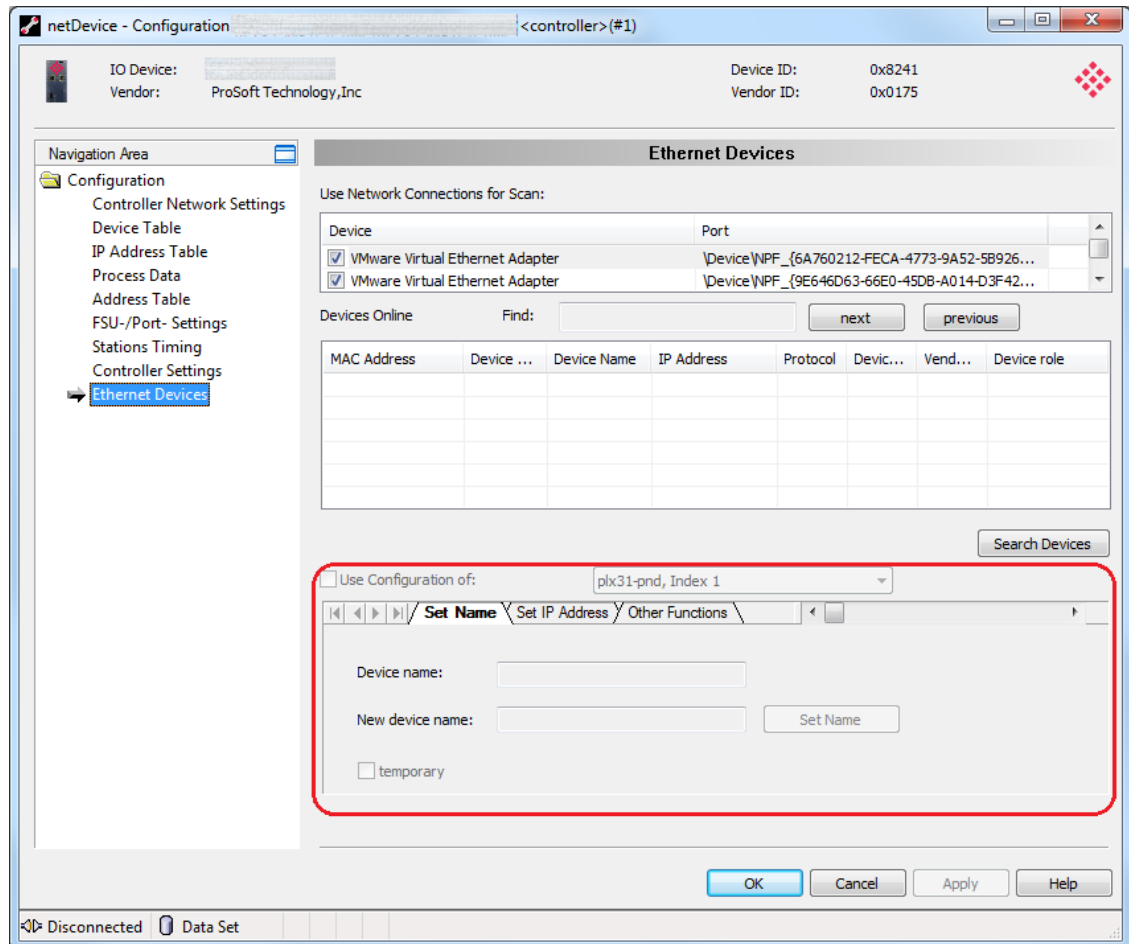

Note: If you are going to use a configuration from a different device, use the "Use Configuration of" section.

The current system allows you to change/set the device name and IP address. Highlight the device that you want to modify and click on the *Set Name*, *Set IP Address*, or *Other Functions* tabs to enter new information.

***Set Name (new configurations)**

Enter the new device name and click the **SET NAME** button. If you are changing the name of the PROFINET controller, the name must match the name specified in the *Controller Network Settings* page.

For example, if the *Device name* in the *Controller Network Settings* pane is 'controller'...

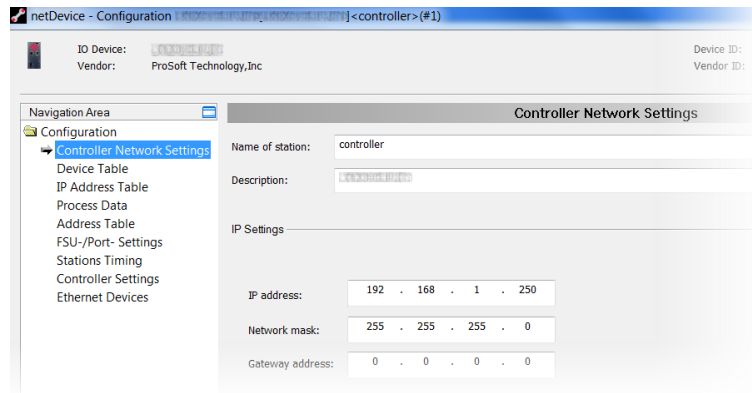

Enter a name in the *New Device Name* parameter and click the **SET NAME** button:

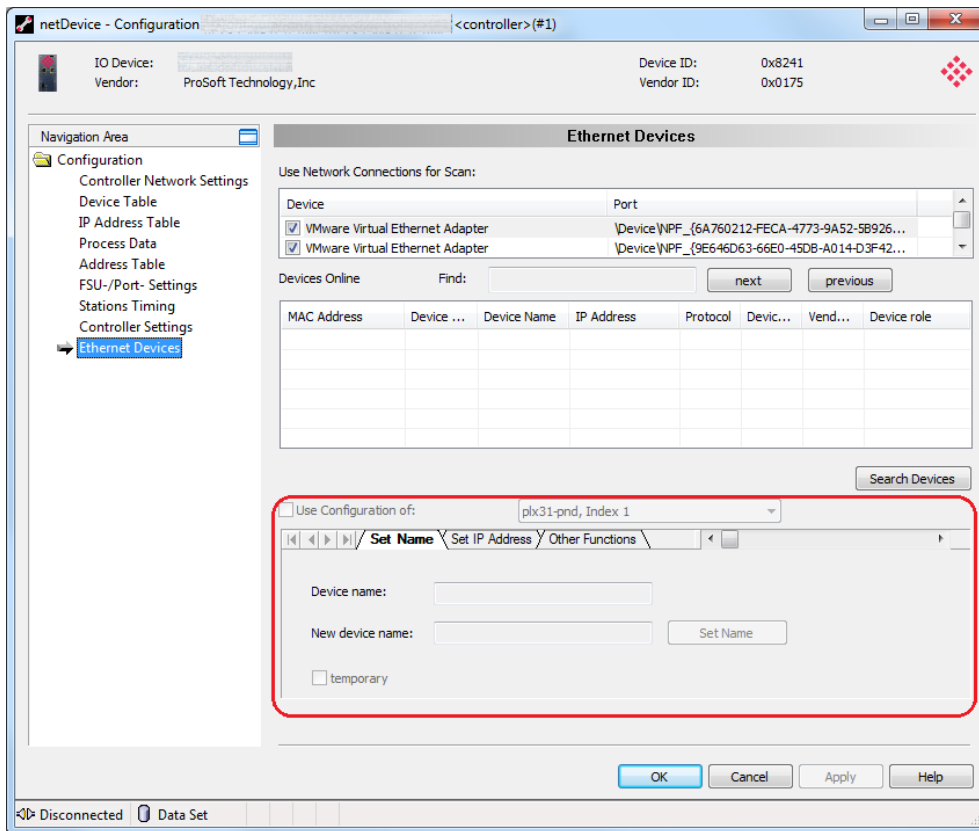

*Set IP Address (new configurations)

Enter the IP address, Subnet mask, and Gateway address of this device and then click the **SET ADDRESS** button.

You can also obtain an IP address via DHCP by checking the *Get IP Address via DHCP* radio button.

***Other Functions** - Signal or Reset the module to factory defaults.

- The **Signal** button causes the LED on the selected device to blink. This allows you to easily identify a specific device among other devices.
- The **Reset** to factory defaults button sets the device to back to factory defaults.

When complete, click **APPLY**, then **OK** to save changes.

Use Configuration of...

You can define whether the configuration for a device is created from scratch or use an existing configuration.

Creating a new configuration:

- 1 Uncheck the **USE CONFIGURATION OF** checkbox to create a new configuration, or check **USE CONFIGURATION OF** box if an existing configuration will be used.
- 2 Select the device whose configuration will be used for the selected device.

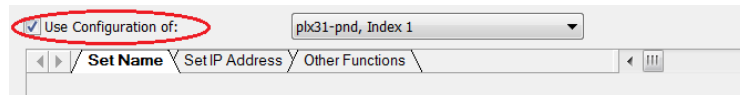

Setting a New Device Name

- 1 Uncheck the **USE CONFIGURATION OF** box.
- 2 Click the **SET NAME** tab.

For PROFINET I/O devices (controller or device)...

- 1 The current name is displayed in the *Device name* field.
- 2 Enter a new device name in the *New device name* field.

- If you are setting this device name as a temporary device name, check the temporary checkbox.

- If you are setting this device name as a permanent change, make sure that the temporary checkbox is unchecked.

- 3 Click the **SET NAME** button. The new device name is now used as the current device name.

4.4.10 Viewing Configured Device Information

Device Info

The *Device Info* pane displays manufacturer information about the device, which is defined in the GSDML file.

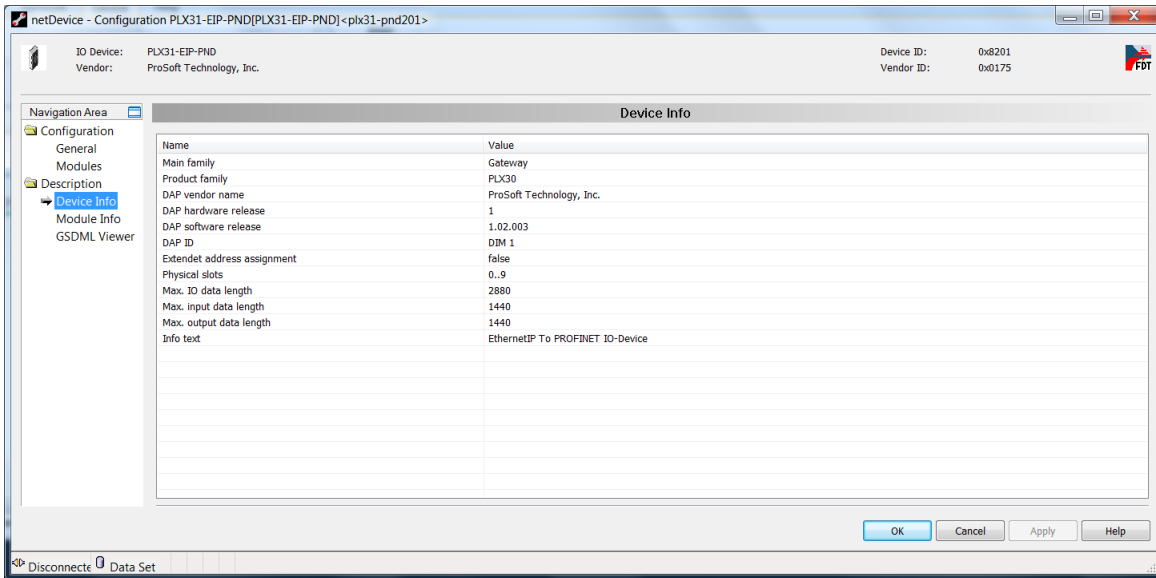

Name	Value
Main family	Attribute of the GSDML family element. It contains the assignment of the device to a function class. One of the following values are allowed: <ul style="list-style-type: none"> ▪ General Drives ▪ Switching Devices ▪ I/O ▪ Valves ▪ Controllers ▪ HMI ▪ Encoders ▪ NC/RC ▪ Gateway ▪ Programmable Logic Controllers ▪ Ident systems ▪ PROFIBUS PA Profile ▪ Network Components Sensor
Product family	Attribute of the GSDML family element. It contains the vendor-specific assignment of the device to a product family. In addition to the main family, a device can be assigned to a vendor-specific product family.
DAP vendor name	Attribute of the GSDML ModuleInfo/VendorName element. The VendorName element contains the name of the device vendor. The device access point (DAP) is a module of the GSDML to describe the device parameters specific device. The device access point object contains most of the device-related keywords.
DAP hardware release	Attribute of the GSDML ModuleInfo/HardwareRelease element. The HardwareRelease element contains the hardware release of the DAP.
DAP software release	Attribute of the GSDML ModuleInfo/SoftwareRelease element. The SoftwareRelease element contains the software release of the DAP.
Extended Address Assignment	Attribute of the GSDML DeviceAccessPointItem element. It depends on the protocol for the assignment of the IP addresses supported by the DAP. Default: "false" for Discovery and Configuration (DCP), "true" for Dynamic Host Configuration Protocol (DHCP).
Physical slots	Attribute of the GSDML DeviceAccessPointItem element. This list describes which slots are supported by the DAP. The slot number of the DAP itself shall be part of the list.
Max. I/O data length	Attribute of the GSDML DeviceAccessPointItem IOConfigData element. It contains the maximum length of the output and input data in octets. MaxDataLength shall not be less than the highest value of MaxInputLength or MaxOutputLength. It shall not be greater than the sum of MaxInputLength and MaxOutputLength. If the keyword is not provided, the maximum length is the sum of MaxInputLength and MaxOutputLength.
Max input data length	Attribute of the GSDML DeviceAccessPointItem IOConfigData element. It contains the maximum length of the data in octets which can be transferred from the I/O device to the I/O controller. This length is defined by the sum of the output data of all used submodules, the corresponding I/O producer status, and the I/O consumer status of the used input submodules.
Max output data length	Attribute of the GSDML DeviceAccessPointItem IOConfigData element. It contains the maximum length of the data in octets which can be transferred from the I/O controller to the I/O device. This length is defined by the sum of the output data of all used submodules, the corresponding I/O producer status, and the I/O consumer status of the used input submodules.
Info text	GSDML ModuleInfo/InfoText element. This element contains human readable additional text information about the device.

Module Info

The **SELECT MODULE** drop-down list of the *Module Info* pane displays all available modules described in the GSDML file.

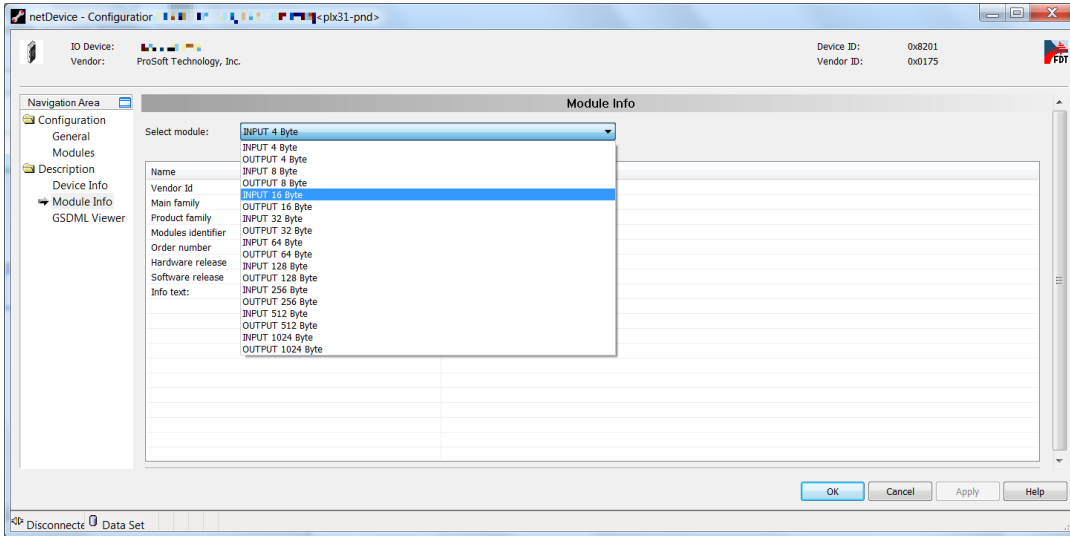

Name	Value
Vendor ID	Vendor Identification Number
Main family	Attribute of the GSDML family element. It contains the assignment of the device to a function class. One of the following values are allowed: <ul style="list-style-type: none"> ▪ General Drives ▪ Switching Devices ▪ I/O ▪ Valves ▪ Controllers ▪ HMI ▪ Encoders ▪ NC/RC ▪ Gateway ▪ Programmable Logic Controllers ▪ Ident Systems, ▪ PROFIBUS PA Profile ▪ Network Components ▪ Sensors
Product family	Attribute of the GSDML family element. It contains the vendor-specific assignment to a product family. In addition to the main family, a device can be assigned to a vendor-specific product family.
Modules identifier	Identification number of the module.
Order number	GSDML ModuleInfo/OrderNumber element. Contains the order number of the module.
Hardware release	GSDML ModuleInfo/HardwareRelease element. Contains the hardware release of the module.
Software release	GSDML ModuleInfo/SoftwareRelease element. Contains the software release of the module.
Info text	GSDML ModuleInfo/InfoText element. This element contains human-readable information about the module.

5 PROFINET Start Input and Output Byte Offsets

The *PNC* option in PCB allows you to set the PROFINET *Start Input Byte Offset* and *Start Output Byte Offset* values within PLX82-EIP-PNC internal memory. You can also use this area to configure floating point or other multi-register values.

To edit these values, double-click on the **PNC > PNC** icon to display the *Edit - PNC* dialog as shown:

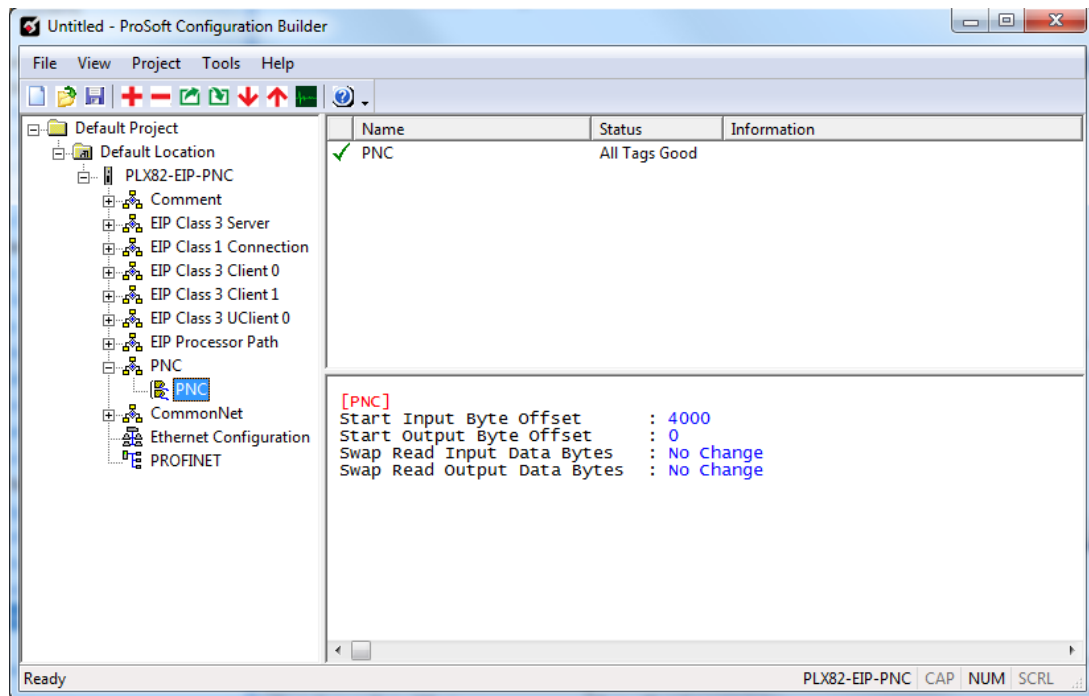

Parameter	Description								
Start Input Byte Offset	Byte offset for input data								
Start Output Byte Offset	Byte offset for output data								
Swap Read Input Data Bytes	<p>Use this parameter when dealing with floating-point or other multi-register values, as there is no standard method of storage of these data types in devices. This parameter can be set to order the register data received in an order useful by other applications.</p> <p>The following table defines the values and their associated operations:</p> <table data-bbox="602 491 1369 743"> <tr> <td data-bbox="602 491 797 548">0</td> <td data-bbox="802 491 1369 548">None. No change is made in the byte ordering.</td> </tr> <tr> <td data-bbox="602 554 797 585">1</td> <td data-bbox="802 554 1369 585">Words. The words are swapped.</td> </tr> <tr> <td data-bbox="602 592 797 648">2</td> <td data-bbox="802 592 1369 648">Words and Bytes. The words are swapped, then the bytes in each word are swapped.</td> </tr> <tr> <td data-bbox="602 655 797 743">3</td> <td data-bbox="802 655 1369 743">Bytes. The bytes in each word are swapped. The words should be swapped only when using an even number of words.</td> </tr> </table>	0	None. No change is made in the byte ordering.	1	Words. The words are swapped.	2	Words and Bytes. The words are swapped, then the bytes in each word are swapped.	3	Bytes. The bytes in each word are swapped. The words should be swapped only when using an even number of words.
0	None. No change is made in the byte ordering.								
1	Words. The words are swapped.								
2	Words and Bytes. The words are swapped, then the bytes in each word are swapped.								
3	Bytes. The bytes in each word are swapped. The words should be swapped only when using an even number of words.								
Swap Read Output Data Bytes	<p>Use this parameter when dealing with floating-point or other multi-register values, as there is no standard method of storage of these data types in devices. This parameter can be set to order the register data received in an order useful by other applications. The following table defines the values and their associated operations:</p> <table data-bbox="602 903 1369 1152"> <tr> <td data-bbox="602 903 797 959">0</td> <td data-bbox="802 903 1369 959">None. No change is made in the byte ordering.</td> </tr> <tr> <td data-bbox="602 966 797 997">1</td> <td data-bbox="802 966 1369 997">Words. The words are swapped.</td> </tr> <tr> <td data-bbox="602 1003 797 1060">2</td> <td data-bbox="802 1003 1369 1060">Words and Bytes. The words are swapped, then the bytes in each word are swapped.</td> </tr> <tr> <td data-bbox="602 1066 797 1152">3</td> <td data-bbox="802 1066 1369 1152">Bytes. The bytes in each word are swapped. The words should be swapped only when using an even number of words.</td> </tr> </table>	0	None. No change is made in the byte ordering.	1	Words. The words are swapped.	2	Words and Bytes. The words are swapped, then the bytes in each word are swapped.	3	Bytes. The bytes in each word are swapped. The words should be swapped only when using an even number of words.
0	None. No change is made in the byte ordering.								
1	Words. The words are swapped.								
2	Words and Bytes. The words are swapped, then the bytes in each word are swapped.								
3	Bytes. The bytes in each word are swapped. The words should be swapped only when using an even number of words.								

6 Acyclic Data

If you have a module that supports acyclic messaging and wish to use it, you must configure RSLogix 5000 to handle this. EIP requires a Class 3 function from the PLC.

Configure Message for Read

- 1 Click on **MAIN ROUTINE** from the *Controller Organizer*.
- 2 Expand the **PLX82.ACYCLIC.READ.REQUEST** controller tag.

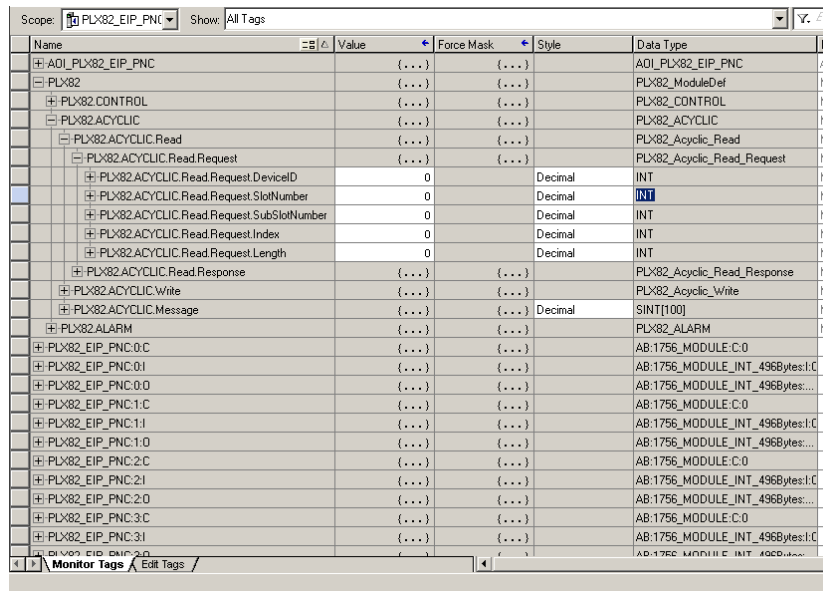

Controller Tag	Description
PLX82.ACYCLIC.Read.Request.DeviceID	You can get the device ID from the Device table described under "Viewing the Device Table" in this manual. The Device ID is list in the Index column of the table. Remember that devices in the table start with the first device as 0, regardless of what number is displayed with the device. The second device in the table represents 1, the next device 2, and so on.
PLX82.ACYCLIC.Read.Request.SlotNumber	Specify the slot number of the device. You can find this information in the Address table described in the section entitled "Viewing and Modifying the Address Table" in this manual.
PLX82.ACYCLIC.Read.Request.SubSlotNumber	Specify the sub-slot number of the device. You can find this information in the Address table described in the section entitled "Viewing and Modifying the Address Table" in this manual.
PLX82.ACYCLIC.Read.Request.Index	Enter the device index number. This should be available from the device manufacturer documentation.
PLX82.ACYCLIC.Read.Request.Length	Enter the number of bytes to read.

Read Response

- 1 Scroll up to **PLX82.Control** and expand it.

Name	Value	Force Mask	Style	Data Type
AD1_PLX82_EIP_PNC	(...)	(...)		AD1_PLX82_EIP_PNC
PLX82	(...)	(...)		PLX82_ModuleDef
PLX82.CONTROL	(...)	(...)		PLX82_CONTROL
PLX82.CONTROL.AcyclicRead	0		Decimal	BOOL
PLX82.CONTROL.AcyclicWrite	0		Decimal	BOOL
PLX82.ACYCLIC	(...)	(...)		PLX82_ACYCLIC
PLX82.ALARM	(...)	(...)		PLX82_ALARM
PLX82_EIP_PNC.0.C	(...)	(...)		AB:1756_MODULE:C:0
PLX82_EIP_PNC.0I	(...)	(...)		AB:1756_MODULE_INT_496Bytes:I:0
PLX82_EIP_PNC.0O	(...)	(...)		AB:1756_MODULE_INT_496Bytes:O:0
PLX82_EIP_PNC.1.C	(...)	(...)		AB:1756_MODULE:C:0
PLX82_EIP_PNC.1I	(...)	(...)		AB:1756_MODULE_INT_496Bytes:I:0
PLX82_EIP_PNC.1O	(...)	(...)		AB:1756_MODULE_INT_496Bytes:O:0
PLX82_EIP_PNC.2.C	(...)	(...)		AB:1756_MODULE:C:0
PLX82_EIP_PNC.2I	(...)	(...)		AB:1756_MODULE_INT_496Bytes:I:0
PLX82_EIP_PNC.2O	(...)	(...)		AB:1756_MODULE_INT_496Bytes:O:0
PLX82_EIP_PNC.3.C	(...)	(...)		AB:1756_MODULE:C:0
PLX82_EIP_PNC.3I	(...)	(...)		AB:1756_MODULE_INT_496Bytes:I:0
PLX82_EIP_PNC.3O	(...)	(...)		AB:1756_MODULE_INT_496Bytes:O:0
PLX82_EIP_PNC.4.C	(...)	(...)		AB:1756_MODULE:C:0
PLX82_EIP_PNC.4I	(...)	(...)		AB:1756_MODULE_INT_496Bytes:I:0
PLX82_EIP_PNC.4O	(...)	(...)		AB:1756_MODULE_INT_496Bytes:O:0
PLX82_EIP_PNC.5.C	(...)	(...)		AB:1756_MODULE:C:0
PLX82_EIP_PNC.5I	(...)	(...)		AB:1756_MODULE_INT_496Bytes:I:0
PLX82_EIP_PNC.5O	(...)	(...)		AB:1756_MODULE_INT_496Bytes:O:0
PLX82_EIP_PNC.6.C	(...)	(...)		AB:1756_MODULE:C:0

- 2 Enter the control bit in the **PLX82.CONTROL.AcyclicRead** field and click Enter.
- 3 The response is returned in the **PLX82-ACYCLIC.Read.Response** tags

Configure Message for Write and Response

- 1 Expand the **PLX82.ACYCLIC.WRITE.REQUEST** controller tag.
- 2 Write also contains the **PLX82.ACYCLIC.Write.Request.Length**. Here, you specify the length of the data to be returned. The recommended limit is 495 bytes.

Name	Value	Force Mask	Style	Data Type	Descriptio
PLX82.ACYCLIC.Read.Response.DeviceID	0		Decimal	INT	Main UDT
PLX82.ACYCLIC.Read.Response.SlotNumber	0		Decimal	INT	Main UDT
PLX82.ACYCLIC.Read.Response.SubSlotNumber	0		Decimal	INT	Main UDT
PLX82.ACYCLIC.Read.Response.Index	0		Decimal	INT	Main UDT
PLX82.ACYCLIC.Read.Response.DataLength	0		Decimal	INT	Main UDT
PLX82.ACYCLIC.Read.Response.StartingLocation	0		Decimal	INT	Main UDT
PLX82.ACYCLIC.Read.Response.Data	{...}	{...}	Decimal	SINT[1024]	Main UDT
PLX82.ACYCLIC.Write	{...}	{...}		PLX82_Acyclic_Write	Main UDT
PLX82.ACYCLIC.Write.Request	{...}	{...}		PLX82_Acyclic_Write_Request	Main UDT
PLX82.ACYCLIC.Write.Request.DeviceID	0		Decimal	INT	Main UDT
PLX82.ACYCLIC.Write.Request.SlotNumber	0		Decimal	INT	Main UDT
PLX82.ACYCLIC.Write.Request.SubSlotNumber	0		Decimal	INT	Main UDT
PLX82.ACYCLIC.Write.Request.Index	0		Decimal	INT	Main UDT
PLX82.ACYCLIC.Write.Request.Length	0		Decimal	INT	Main UDT
PLX82.ACYCLIC.Write.Request.Data	{...}	{...}	Decimal	SINT[512]	Main UDT
PLX82.ACYCLIC.Write.Response	{...}	{...}		PLX82_Acyclic_Write_Response	Main UDT
PLX82.ACYCLIC.Message	{...}	{...}	Decimal	SINT[100]	Main UDT
PLX82.ALARM	{...}	{...}		PLX82_ALARM	Main UDT
PLX82_EIP_PNC.0.C	{...}	{...}		AB:1756_MODULE:C:0	
PLX82_EIP_PNC.0.I	{...}	{...}		AB:1756_MODULE_INT_496Bytes:I:0	
PLX82_EIP_PNC.0.O	{...}	{...}		AB:1756_MODULE_INT_496Bytes:O:0	
PLX82_EIP_PNC.1.C	{...}	{...}		AB:1756_MODULE:C:0	
PLX82_EIP_PNC.1.I	{...}	{...}		AB:1756_MODULE_INT_496Bytes:I:0	
PLX82_EIP_PNC.1.O	{...}	{...}		AB:1756_MODULE_INT_496Bytes:O:0	
PLX82_EIP_PNC.2.C	{...}	{...}		AB:1756_MODULE:C:0	
PLX82_EIP_PNC.2.I	{...}	{...}		AB:1756_MODULE_INT_496Bytes:I:0	
PLX82_EIP_PNC.2.O	{...}	{...}		AB:1756_MODULE_INT_496Bytes:O:0	

Controller Tag	Description
PLX82.ACYCLIC.Write.Request.DeviceID	You can get the device ID from the Device table described under "Viewing the Device Table" in this manual. The Device ID is list in the Index column of the table. Remember that devices in the table start with the first device as 0, regardless of what number is displayed with the device. The second device in the table represents 1, the next device 2, and so on.
PLX82.ACYCLIC.Write.Request.SlotNumber	Specify the slot number of the device. You can find this information in the Address table described in the section entitled "Viewing and Modifying the Address Table" in this manual.
PLX82.ACYCLIC.Write.Request.SubSlotNumber	Specify the sub-slot number of the device. You can find this information in the Address table described in the section entitled "Viewing and Modifying the Address Table" in this manual.
PLX82.ACYCLIC.Write.Request.Index	Enter the device index number. This should be available fro the device manufacturer documentation.
PLX82.ACYCLIC.Write.Request.Length	495 bytes

- 3 The Write Results are displayed in the **PLX82.ACYCLIC.WRITE.RESPONSE** controller tag.

Important Note: The *PLX82.ACYCLIC.Read.Request.DeviceID*, and *PLX82.ACYCLIC.Write.Request.DeviceID*, and can be found in the PNC Device Table through ProSoft fdt Configuration Manager. However it is important to note that regardless of the index number listed in the Device Table, the first device in the list (for purposes of identification) is always 0. The Device Table indexes devices sequentially beginning at 1. However, since the Device table Index is also editable, the first number listed could be anything. Regardless, for setting the DeviceID, the first device will be 0, followed by 1, 2, 3, etc.

7 CommonNet Data Map

This is an optional section that allows you to move already in the PLX82-EIP-PNC's internal database to another location in its database and is not required for normal operation. This feature is primarily used to transfer status data from our normally inaccessible upper memory (address 4000 and higher) down into the accessible lower memory (0 to 3999) so that it may be transferred to one or more connected devices.

- 1 From PCB, navigate to **COMMONNET > DATA MAP**.

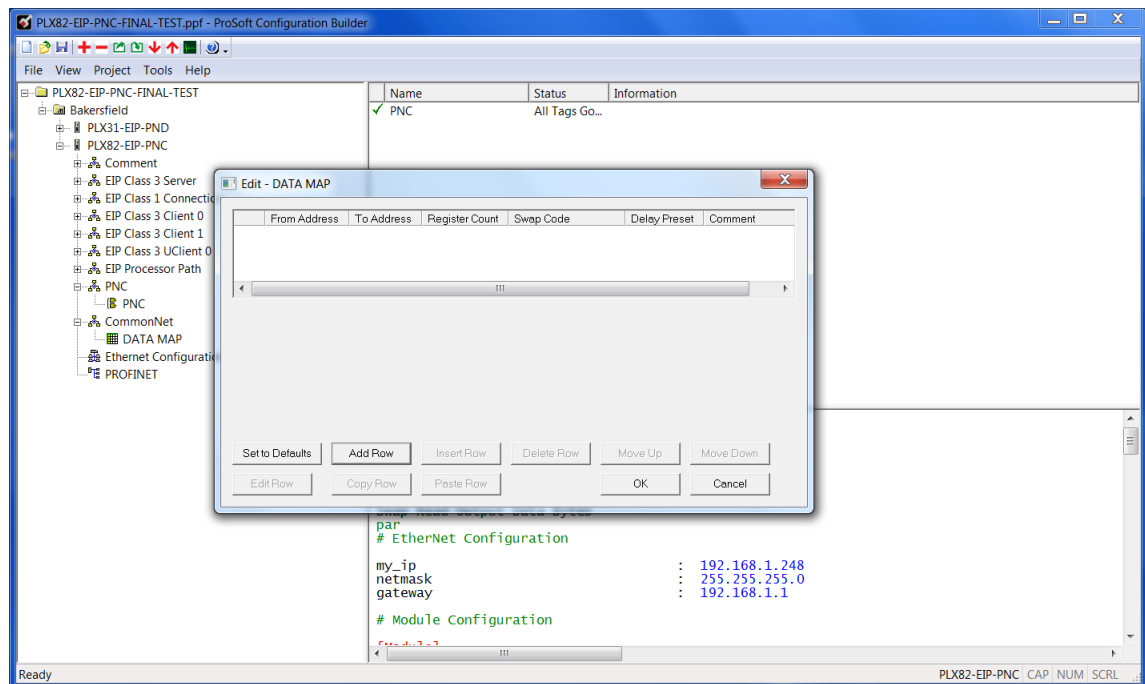

- 2 To set data mapping to default levels, click the **SET TO DEFAULTS** button.
- 3 To configure the data map, click on the **ADD ROW** button.

Parameter	Description										
From Address	0 to highest Status Data address. Specifies the beginning internal database register address for the copy operation. The address can be any valid address in the user data area or the status data area in the gateway.										
To Address	0 to 3999 Specifies the beginning destination register address for the copy operation. This address must always be within the user data area. Make sure you specify a destination address that does not overwrite data that is stored in memory by one of the communication protocols running on the gateway.										
Register Count	1 to 100 Specifies the number of registers to copy.										
Swap Code	No Change, Word Swap, Word & Byte Swap, Byte Swap You may need to swap the order of bytes in the registers during the copy process in order to change the alignment of bytes between different protocols. Use this parameter when dealing with floating-point or other multi-register values since there is no standard of storage of this data type in slave devices.										
	<table border="1"> <thead> <tr> <th>Swap Code</th> <th>Description</th> </tr> </thead> <tbody> <tr> <td>No Swap</td> <td>No change is made in the byte ordering (1234 = 1234)</td> </tr> <tr> <td>Word Swap</td> <td>The words are swapped (1234 = 3412)</td> </tr> <tr> <td>Word and Byte Swap</td> <td>The words are swapped, then the bytes in each word are swapped (1234 = 4321)</td> </tr> <tr> <td>Bytes</td> <td>The bytes in each word are swapped (1234 = 2143)</td> </tr> </tbody> </table>	Swap Code	Description	No Swap	No change is made in the byte ordering (1234 = 1234)	Word Swap	The words are swapped (1234 = 3412)	Word and Byte Swap	The words are swapped, then the bytes in each word are swapped (1234 = 4321)	Bytes	The bytes in each word are swapped (1234 = 2143)
Swap Code	Description										
No Swap	No change is made in the byte ordering (1234 = 1234)										
Word Swap	The words are swapped (1234 = 3412)										
Word and Byte Swap	The words are swapped, then the bytes in each word are swapped (1234 = 4321)										
Bytes	The bytes in each word are swapped (1234 = 2143)										
Delay Preset	<p>This parameter sets an interval for each <i>Data Map</i> copy operation. The value for the <i>Delay Preset</i> is not a fixed amount of time. It is the number of firmware scans that must transpire between copy operations.</p> <p>The firmware scan cycle can take a variable amount of time, depending on the level of activity of the protocol drivers running on the gateway and the level of activity on the gateway's communication ports. Each firmware scan can take from one to several milliseconds to complete. Therefore, <i>Data Map</i> copy operations cannot be expected to happen at regular intervals.</p> <p>If multiple copy operations (several rows in the <i>Data map</i> section) happen too frequently or all happen in the same update interval, they could delay the process scan of the gateway protocols, which could result in slow data updates or missed data on communication ports. To avoid these potential problems, set the <i>Delay Preset</i> to different values for each row in the <i>Data Map</i> section and set them to higher, rather than lower, numbers.</p> <p>For example, <i>Delay Preset</i> values below 1000 could cause a noticeable delay in data updates through the communication ports. Do not set all <i>Delay Presets</i> to the same value. Instead, use different values for each row in the <i>Data Map</i> such as 1000, 1001, and 1002 or any other different <i>Delay Preset</i> values you like. This prevents the copies from happening concurrently and prevents possible process scan delays.</p>										

8 Webpage

The PLX82-EIP-PNC webpage is accessible via web browser or through PCB via the built-in ProSoft Discovery Service.

To access the PLX82-EIP-PNC webpage, enter the PLX82-EIP-PNC's IP address into your browser.



Status

Module Name	Name of the device as character string defined by the manufacturer	PLX82-EIP-PNC
Ethernet Address (MAC)	The MAC address (MAC ID) is the unique (physical) Ethernet address of the device fixed by the manufacturer	Assigned MAC address
IP Address	IP address of the of the PLX82-EIP-PNC that can be set via the <i>ProSoft fdt Configuration Manager</i>	xxx.xxx.xxx.xxx
Product Revision	Product revision of the PLX82-EIP-PNC firmware	vx.xx.xxx x.x.xx.xx.#1
Firmware Version Date	Firmware Version Date	Month/Day/Year
Serial Number	Serial number of the PLX82-EIP-PNC	0 to 65535
Status	Current status of the module	Running, Communicating, Ready, Error
Uptime	Counts up to the time from the last Reset/Power On	Days, hours, minutes, seconds

Functions

Firmware Upgrade	Click to upgrade the firmware in the PLX82-EIP-PNC. Only do this if instructed to do so by ProSoft Technology Technical Support.
Set Date & Time	Click to set the date and time in the PLX82-EIP-PNC.
Reboot Module	Click to reboot the PLX82-EIP-PNC.
Technical Support	Click to be directed to ProSoft Technology Technical Support.
Homepage	Click to go to the PLX82-EIP-PNC's homepage.

Resources

ProSoft Technology	Click to be directed to the ProSoft Technology website.
PROFINET Technology	Click to be directed to the PROFINET website.

9 Diagnostics and Troubleshooting

In This Chapter

❖ LEDs.....	92
❖ PCB Diagnostics	94
❖ Network Diagnostics.....	106

There are three ways to troubleshoot the PLX82-EIP-PNC:

- Using the LEDs located on the front of the PLX82-EIP-PNC.
- Using the Diagnostics option within ProSoft Configuration Builder (PCB).
- Using the MBTCP port to run diagnostics on the network.

9.1 LEDs

All LEDs are found on the front of the module.



LED	State	Description
Pwr	OFF	Power is not connected to the power terminals or source is insufficient to properly power the gateway (200mA at 24 VDC is required)
	Solid GREEN	Power is connected to the power terminals. Verify that the other LEDs for operational and functional status come on briefly after power-up (check for burned-out LEDs).
Flt	OFF	Normal operation
	Solid RED	A critical error has occurred. Program executable has failed or has been user-terminated and is no longer running. Press Reset p/b or cycle power to clear error.
Cfg	OFF	Normal operation
	Solid AMBER	The unit is in configuration mode. Either a configuration error exists, or the configuration file is currently being downloaded or read. After power up, the configuration is read, and the unit implements the configuration values and initiates the hardware. This occurs during power cycle or after the Reset button is pressed.

LED	State	Description
Err	OFF	PROFINET is scanning configured slaves without error.
	Flashing Amber	PROFINET controller is in error (misconfiguration or missing slaves)
	Solid AMBER	PROFINET controller is not configured, or is incorrectly configured.
NS	Off	No power or no IP address
	Solid Red	Duplicate IP address
	Solid Green	Connected
	Flashing Red	Connection timeout
	Flashing Green	IP address obtained; no established connections
	Alternating Red and Green	Self-test
MS	Off	No power
	Solid Red	Major fault
	Solid Green	Device operational
	Flashing Red	Minor fault
	Flashing Green	Standby
	Alternating Red and Green	Self-test
Link/Act	OFF	No physical network connection is detected.
	Solid Green	Physical network connection detected. This LED must be ON solid for Ethernet communication to be possible.
100 Mbit (Port Speed)	Off	No activity on the port.
	Flashing Amber	The Ethernet port is actively transmitting or receiving data.
Link	Green	A connection exists
Rx/Tx	Yellow (Flashing)	The device sends/receives Ethernet frames.
SYS	Green	Operating system running
	Green/Yellow	Second stage boot loader is waiting for firmware.
	Yellow	Second stage boot loader missing. Contact Technical Support
	Off	Power supply for the device is missing or hardware is defective
SF	Red (with BF Red)	No valid Controller License
	Red (flashing cyclic at 2 Hz)	System Error: Invalid configuration, watchdog error, or internal error
	Off	No error
BF	Red	No Connection: No Link or together with SF Red: No Controller License
	Red (Flashing cyclic at 2 Hz)	Configuration fault: not all configured I/O devices are connected.
	Off	No error

9.2 PCB Diagnostics

- 1 From PCB, right-click on the **PLX82-EIP-PNC** icon and select **DIAGNOSTICS**.

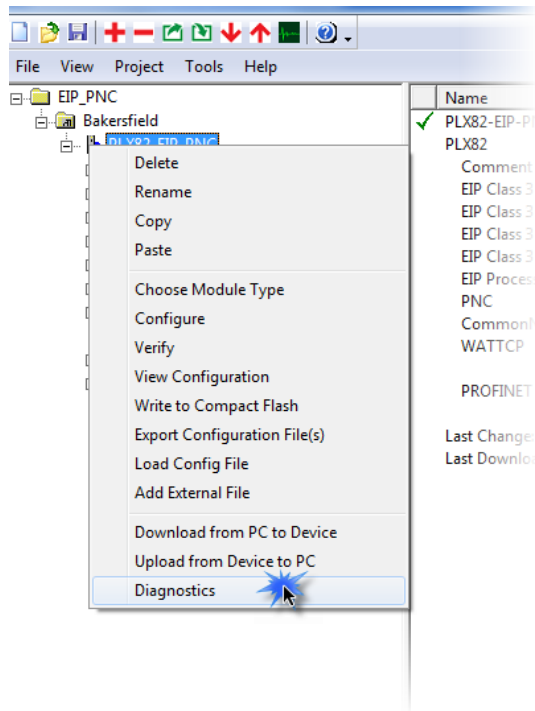

- 2 When the *Diagnostics* window opens, click the **SET UP CONNECTION** icon to browse for PLX82-EIP-PNC's IP address.

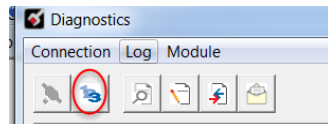

- 3 Enter the IP address of the PLX82-EIP-PNC. If you don't remember the IP address, click on the **BROWSE DEVICE(S)** button to display all devices on the network.

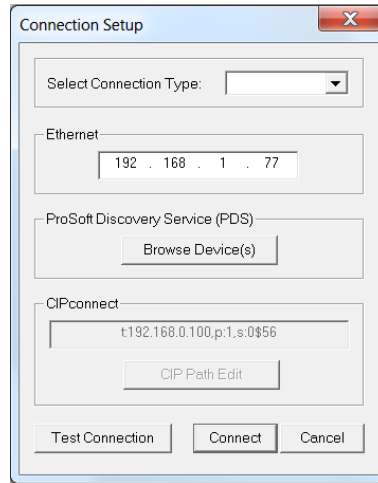

- 4 Click **TEST CONNECTION** to ensure that a connection can be established.
- 5 Click **CONNECT** to obtain diagnostic results. Click on the parameters within the navigation tree on the left pane of the window.

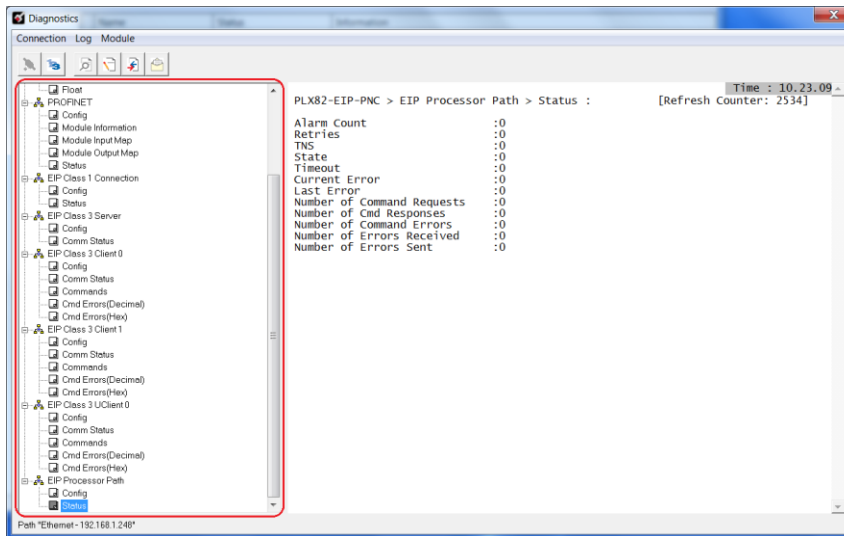

9.2.1 PCB Diagnostics Menu Options

This view provides diagnostic and status information.

PLX82-EIP-PNC > Module > Version

Displays the module's current version information as well as additional information such as IP address, free memory, etc.

```
PLX82-EIP-PNC > MODULE > Version : Time : 09.36.21  
[Refresh Counter: 1]  
  
PRODUCT NAME : PLX82-EIP-PNC  
PRODUCT NAME CODE : EPNC  
SOFTWARE REVISION LEVEL : 1.02.003  
OPERATING SYSTEM REVISION : 2.6.30.10  
RUN NUMBER : #1  
MY IP ADDRESS : 192.168.1.248  
MY ETHERNET ADDRESS (HEX) : 00:0D:8D:A2:5E:95  
PROGRAM SCAN COUNTER : 592096094  
SYSTEM FREE MEMORY : 44666880  
MODULE NAME : PLX82-EIP-PNC
```

PLX82-EIP-PNC > Module > Data Map

Displays the PLX82-EIP-PNC data map.

```
PLX82-EIP-PNC > MODULE > Data Map : Time : 09.39.01  
[Refresh Counter: 1]  
  
DATA MAP LIST : FROM ADDR TO ADDR REG COUNT SWAP CODE  
  
***** Scroll Up/Down *****
```

PLX82-EIP-PNC > PROFINET > Config

Displays the current PCB configuration settings.

```
PLX82-EIP-PNC > PROFINET > Config : Time : 09.43.21  
[Refresh Counter: 1]  
  
Start Input Byte Offset : 4000  
Start Output Byte Offset : 0  
Swap Read Input Data Bytes : No Swap  
Swap Read Output Data Bytes : No Swap  
Configuration Error : 0
```

PLX82-EIP-PNC > PROFINET > Module Information

Displays specific module information.

```
PLX82-EIP-PNC > PROFINET > Module Information : Time : 09.45.01  
[Refresh Counter: 1]  
  
Module Information :  
Module : PROFINET IO Controller  
Version : 2.7.11 build 0  
Device Number : 20002  
Serial Number : 9043110
```

PLX82-EIP-PNC > PROFINET > Module Input Map

Displays the starting input data address and the size of the data (bytes) being passed.

```

Time : 09.47.35
PLX82-EIP-PNC > PROFINET > Module Input Map : [Refresh Counter: 1]
Input Module 0 TO 0 : INPUT_START INPUT_COUNT (32)
:
Module 0 : 0 32

***** Scroll Up/Down *****
  
```

PLX82-EIP-PNC > PROFINET > Module Output Map

Displays the starting output data address and the size of the data (bytes) being passed.

```

Time : 09.50.08
PLX82-EIP-PNC > PROFINET > Module Output Map : [Refresh Counter: 1]
Output Module 0 TO 0 : OUTPUT_START OUTPUT_COUNT (32)
:
Module 0 : 0 32

***** Scroll Up/Down *****
  
```

PLX82-EIP-PNC > PROFINET > Status

Displays the current PROFINET status.

```

Time : 09.52.58
PLX82-EIP-PNC > PROFINET > Status : [Refresh Counter: 1]
Number of Input Messages : 63089
Input Errors Count : 0
Previous Input Errors Status : 0
Input Errors Status : 0
Number of Output Messages : 63088
Output Errors Count : 0
Previous Output Errors Status : 0
Output Errors Status : 0
Connection Count : 1
Communication Status : Connected
  
```

PLX82-EIP-PNC > EIP Class 1 Connection > Config

Displays EIP Class 1 connections.

```

Time : 09.56.35
PLX82-EIP-PNC > EIP Class 1 Connection > Config : [Refresh Counter: 1]
EIP Class 1 Connections :Input Addr Input Size Output Addr Output Size
Connection 1 : 2000 248 0 248
Connection 2 : 2250 248 250 248
Connection 3 : 2500 248 500 248
Connection 4 : 2750 248 750 248
Connection 5 : 3000 248 1000 248
Connection 6 : 3250 248 1250 248
Connection 7 : 3500 248 1500 248
Connection 8 : 3750 248 1750 248
  
```

PLX82-EIP-PNC > EIP Class 1 Connection > Status

Displays Class 1 connection status.

```
PLX82-EIP-PNC > EIP Class 1 Connection > Status : [Refresh Counter: 1] Time : 09.59.21
Configuration Error :0x0000
Number of EIP Class 1 (Implicit) Connections :0
```

PLX82-EIP-PNC > EIP Class 3 Server > Config

Displays Class 3 server parameters.

```
PLX82-EIP-PNC > EIP Class 3 Server > Config : [Refresh Counter: 1] Time : 10.13.35
First File :10
File Size :1000
```

PLX82-EIP-PNC > EIP Class 3 Server > Comm Status

Displays comm status information of the EIP Class 3 server.

```
PLX82-EIP-PNC > EIP Class 3 Server > Comm Status : [Refresh Counter: 1] Time : 10.18.17
Server 0: Port : 0 IP : 0.0.0.0 :
State :-1
Estab :0
Read :0
Write :0
Server 1: Port : 0 IP : 0.0.0.0 :
State :-1
Estab :0
Read :0
Write :0
Server 2: Port : 0 IP : 0.0.0.0 :
State :-1
Estab :0
Read :0
Write :0
Server 3: Port : 0 IP : 0.0.0.0 :
State :-1
Estab :0
Read :0
Write :0
Server 4: Port : 0 IP : 0.0.0.0 :
State :-1
Estab :0
Read :0
Write :0
```

PLX82-EIP-PNC > EIP Class 3 Client 0 > Config

Displays Class 3 Client 0 configuration.

```
PLX82-EIP-PNC > EIP Class 3 Client 0 > Config : [Refresh Counter: 1] Time : 10.42.01
Commands :0
Min Dly :50
Resp_TMO :1000
Retries :3
```

PLX82-EIP-PNC > EIP Class 3 Client 0 > Comm Status

Displays the communication status of the selected EIP Class 3 client.

```
Time : 10.45.21
PLX82-EIP-PNC > EIP Class 3 Client 0 > Comm Status : [Refresh Counter: 1]

Retries                :0
Cur Cmd               :0
TNS                   :0
State                 :0
Timeout               :0
Cfg Err               :0x0000
Cur Err              :0
Last Err              :0
Number of Command Requests :0
Number of Cmd Responses  :0
Number of Command Errors :0
Number of Requests     :0
Number of Responses    :0
Number of Errors Received :0
Number of Errors Sent   :0
```

PLX82-EIP-PNC > EIP Class 3 Client 0 > Commands

Displays the command list for the selected EIP Class 3 client.

```
Time : 10.48.48
PLX82-EIP-PNC > EIP Class 3 Client 0 > Commands : [Refresh Counter: 1]

COMMANDS 0 TO 9      : EN DBREG POLLINT COUNT SWAP NODE      SLOT
C0                   : 0 0 0 0 ILLEGAL FUNCTION 0
C1                   : 0 0 0 0 ILLEGAL FUNCTION 0
C2                   : 0 0 0 0 ILLEGAL FUNCTION 0
C3                   : 0 0 0 0 ILLEGAL FUNCTION 0
C4                   : 0 0 0 0 ILLEGAL FUNCTION 0
C5                   : 0 0 0 0 ILLEGAL FUNCTION 0
C6                   : 0 0 0 0 ILLEGAL FUNCTION 0
C7                   : 0 0 0 0 ILLEGAL FUNCTION 0
C8                   : 0 0 0 0 ILLEGAL FUNCTION 0
C9                   : 0 0 0 0 ILLEGAL FUNCTION 0
```

***** Scroll Up/Down *****

PLX82-EIP-PNC > EIP Class 3 Client 0 > Cmd Errors (Decimal)

Lists command errors in decimal format.

```
Time : 10.54.50
PLX82-EIP-PNC > EIP Class 3 Client 0 > Cmd Errors(Decimal) : [Refresh Counter: 1]

D0                   : 0 0 0 0 0 0 0 0
D10                  : 0 0 0 0 0 0 0 0
```

***** Scroll Up/Down *****

PLX82-EIP-PNC > EIP Class 3 Client 0 > Cmd Errors (Hex)

Lists command errors in hexadecimal format.

```
Time : 10.57.50
PLX82-EIP-PNC > EIP Class 3 Client 0 > Cmd Errors(Hex) : [Refresh Counter: 1]
H0 : 0000 0000 0000 0000 0000 0000 0000 0000
H10 : 0000 0000 0000 0000 0000 0000 0000 0000
***** Scroll Up/Down *****
```

PLX82-EIP-PNC > EIP Processor Path > Config

Displays the EIP Processor Path configuration.

```
Time : 11.00.06
PLX82-EIP-PNC > EIP Processor Path > Config : [Refresh Counter: 1]
Alarm IP Address : 192.168.0.59
Alarm Slot : -1
Alarm Tagname : Alarm
Acyclic IP Address : 192.168.0.59
Acyclic Slot : -1
Acyclic Tagname : Acyclic
```

PLX82-EIP-PNC > EIP Processor Path > Status

Displays the EIP Processor Path status.

Time : 11.02.09
 [Refresh Counter: 1]

```

PLX82-EIP-PNC > EIP Processor Path > Status :
PNC Respond Count           :0
PNC Alarm Respond Count     :0
PNC Acyclic Command Count   :0
Retries                     :0
TNS                         :0
State                       :0
Timeout                     :0
Current Error               :0
Last Error                  :0
Number of Command Requests  :0
Number of Cmd Responses     :0
Number of Command Errors    :0
Number of Errors Received   :0
Number of Errors Sent       :0
    
```

Parameter	Description
PNC Respond Count	Represents the total number of PROFINET responses saved in the queue.
PNC Alarm Respond Count	Represents the total number of PROFINET Alarm Responses saved in the queue.
PNC Acyclic Command Count	Represents the total number of PROFINET acyclic commands saved in the queue.
Retries	Number of messages sent but exceeded the 100ms timeout and had to be retried
TNS	Transaction Number. Increments each time a transaction such as an alarm or acyclic response occurs.
State	Displays the current command state: 0: Client Initialization 1: Session Creation 2: Wait for Session 3 Open for Session 4: Command Ready 5: Command Delay 6: Send Command 7: Wait for Command Response 8: Prepare Next Command 9: Verify Command 10: Close Connection 11: Close Session
Timeout	100ms. Amount of time before trying to reconnect to the socket to retry the send.
Current Error	Current error code number detected by the module.
Last Error	Previous error code detected by the module.
Number of Command Requests	This value is incremented each time a Command Request is issued by the client.
Number of Cmd Responses	This value is incremented each time a Command Response is received by the client.
Number of Command Errors	This value is incremented each time an error message is received from a remote unit or a local error is generated for a command.
Number of Errors Received	Represents the number of errors received from the PNC.
Number of Errors Sent	Represents the number of errors sent from the PNC.

9.2.2 PROFINET General Status Codes

Status Code	Description
0x00000000L	Operation successful
0xC000001L	Common error, detailed error information optionally present in the data area of the packet
0xC0000002L	Unexpected failure
0xC0000003L	Out of memory
0xC0000004L	Unknown command in packet received
0xC0000005L	Unknown destination in packet received
0xC0000006L	Unknown destination ID in packet received
0xC0000007L	Packet length is invalid
0xC0000008L	Invalid extension in packet received
0xC0000009L	Invalid parameter in packet found
0xC000000CL	Watchdog error occurred
0xC000000DL	List type is invalid
0xC000000EL	Handle is unknown
0xC000000FL	A packet index is not in the expected sequence
0xC0000010L	The amount of fragmented data contained in the packet sequence is too large
0xC0000011L	The packet done function has failed
0xC0000012L	A packet failed to send
0xC0000013L	Packet request from packet pool has failed
0xC0000014L	Release of a packet from the packet pool has failed
0xC0000015L	The get packet pool load function has failed.
0xC0000016L	The get queue load function failed
0xC0000017L	The waiting for a packet from queue failed
0xC0000018L	The posting of a packet has failed
0xC0000019L	The peek of a packet from queue has failed
0xC000001AL	Request already running
0xC000001BL	Creating a timer failed
0xC0000100L	General initialization fault
0xC0000101L	Database access failure
0xC0000102L	Controller parameter cannot activate at state operate
0xC0000103L	Slave parameter cannot activate at state operate
0xC0000200L	Watchdog time is out of range
0xC0000201L	Application is already registered
0xC0000202L	No application registered
0x0000F005L	Fragment accepted
0xC000F006L	Reset required

9.2.3 PROFINET Device Errors

Error Code	Description
D13 to D31	Unused, set to zero
D12	Inactive module present
D11	Module DiffBlock present
D10	Packet too small
D9	Diagnosis buffer overwritten
D8	Diagnosis buffer overflow
D7	Diagnosis - disappeared
D6	Diagnosis data present for I/O device
D5	IO - Device deactivated
D4	IO - Device parameter fault
D3	IO - Device invalid response
D2	IO - Device configuration fault
D1	IO - Device not ready
D0	IO - Device does not exist

9.2.4 Acyclic Read/Write Communication Status

Status Code	Description
0x00000000	Status OK
0xC00A0012	Insufficient memory for this request
0xC00A0014	This request cannot be served in current CMCTL state
0xC00A0018	Error while sending a packet to another task
0xC00A0040	The CMCTL protocol-machine restored from index invalid
0xC00A0041	The index of CMCTL protocol machine is invalid
0xC00C0030	Too many outstanding RPC-requests for this I/O device
0xC00C0031	Error while sending internal message to another task
0xC00C0032	The handle used for I/O device is wrong
0xC00C0051	The current bus state is OFF and no frames can be sent
0xC02E0100	Generic RPC error code. See Acyclic Read/Write PNIO Remote Procedure Call Status code for details.
0xC02E0200	Error while sending internal message to another task
0xC02E0201	Creating a TLR-Timer-packet in RPC task failed due to insufficient memory
0xC02E0605	The handle to RPC-client instance is invalid
0xC02E0606	The maximum amount of outstanding RPC-Requests for this RPC-Clients instance is reached
0xC02E0607	RPC-client instances can only to connect to an IO-Device if there are no outstanding RPC Requests. There is currently at least one RPC-Request outstanding
0xC02B0024	The message ID of the request is incorrect; out of sequence

9.2.5 Acyclic Read/Write PNIO Remote Procedure Call Status

Status Code	Description
0x00000000	Status OK
0xC02E0010	Initiating CLRPC - Client failed
0xC02E0011	Initiating CLRPC - Server failed
0xC02E0012	Initiating CLRPC - Endpoint Mapper failed
0xC02E0013	Creating message queue failed
0xC02E0014	Identifying Irv_EDD failed
0xC02E0015	Getting the MAC address failed
0xC02E0100	Generic RPC-error code. See Acyclic Read/Write Communication Status for details
0xC02E0101	There was not enough memory allocated to receive the entire I/O device's Connect Response PDU. Most likely, it contains a very large ModuleDiff-Block
0xC02E0102	The fatal error callback function is already registered
0xC02E0200	Error while sending an internal message to another task
0xC02E0201	Creating a TLR-Timer-packet in RPC task failed due to insufficient memory
0xC02E0202	The reference counter value is invalid
0xC02E0203	The port handle is invalid
0xC02E0204	The soft timer is already active (expected inactive)
0xC02E0300	The parameter "uiMaxReg" (maximum amount of RPC mapper registrations) is invalid
0xC02E0301	The requested endpoint mapper index is invalid
0xC02E0303	The state of endpoint mapper is invalid for this request
0xC02E0304	The endpoint mapper is waiting for close confirmation and therefore it's status is invalid for this request
0xC02E0305	The status of endpoint mapper is unknown
0xC02E0306	The status of endpoint mapper is not "Ready"
0xC02E0307	Invalid parameter
0xC02E0308	CLRPC_EPMap_Deregister_req() is not allowed because at least one RPC server is registered to this endpoint mapper
0xC02E0400	An error occurred during server initialization
0xC02E0401	The maximum number of registered RPC-Servers is exceeded or the maximum number of outstanding requests is exceeded
0xC02E0402	Creating TLR timer for RPC server failed
0xC02E0403	There is no RPC server registered that could be de-registered
0xC02E0405	The handle to endpoint mapper is invalid
0xC02E0406	The status of endpoint mapper is invalid
0xC02E0407	The handle to RPC server instance is invalid
0xC02E0408	There is at least one object register to the RPC server instance; CLRPC_ServerDeregister_req() cannot proceed
0xC02E0409	Invalid parameter "ulMaxRecv" in request packet
0xC02E040A	Invalid parameter "ulMaxSend" in request packet
0xC02E040B	Invalid RPC server element "ptElem". Internal RPC error

0xC02E040C	The RPC request was canceled
0xC02E040D	The state of RPC server is invalid for this request
0xC02E040E	The activity has already been initialized
0xC02E040F	The RPC server received in invalid (unexpected) response packet
0xC02E0501	The handle to the RPC server instance is invalid
0xC02E0502	The status of the RPC server is invalid
0xC02E0503	The handle of the RPC Object instance is invalid
0xC02E0600	One of the parameters "uiMaxReg" or "uiMaxReq" is invalid
0xC02E0601	The maximum number of parallel RPC client instances has been reached
0xC02E0602	Creating TLR timer for RPC client instance failed
0xC02E0604	The state of endpoint mapper is invalid for this request
0xC02E0605	The handle to the RPC client instance is invalid
0xC02E0606	The maximum amount of outstanding RPC requests for this RPC client instance has been reached
0xC02e0607	RPC client instances can only connect to an I/O device if there are no outstanding RPC requests. Currently, at least one RPC request is outstanding
0xC02E0608	The RPC client instance you tried to use is going to deregister right now. Aborting your request!
0xC02E0609	Invalid RPC client instance element "ptElem". Internal RPC error
0xC02E060A	The LONG timeout TLR timer for an outstanding RPC request hit. Used internally by RPC only
0xC02E060B	Invalid sequence number in RPC message receive by RPC client instance
0xC02E060C	Canceling a running request timeout out. This RPC client is no longer usable
0xC02E060D	The RPC client did not have a packet to return
0xC02E060E	The RPC client received a request with an unexpected flag value.
0xC02E060F	The request was aborted because the RPC client was unbound
0xC02E0610	The maximum resend number was reached by the activity.

9.3 Network Diagnostics

There may be instances where you want to look at diagnostic information on a particular network device. You can access device diagnostics through the MBTCP port of the PLX82-EIP-PNC.

- 1 From PCB, click on the **PROFINET** icon.

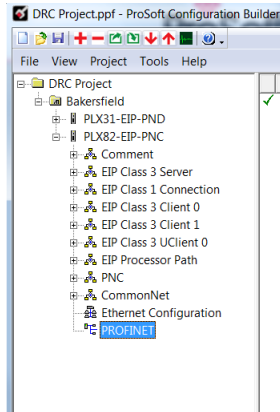

- 2 This launches the ProSoft fdt Configuration Manager application.

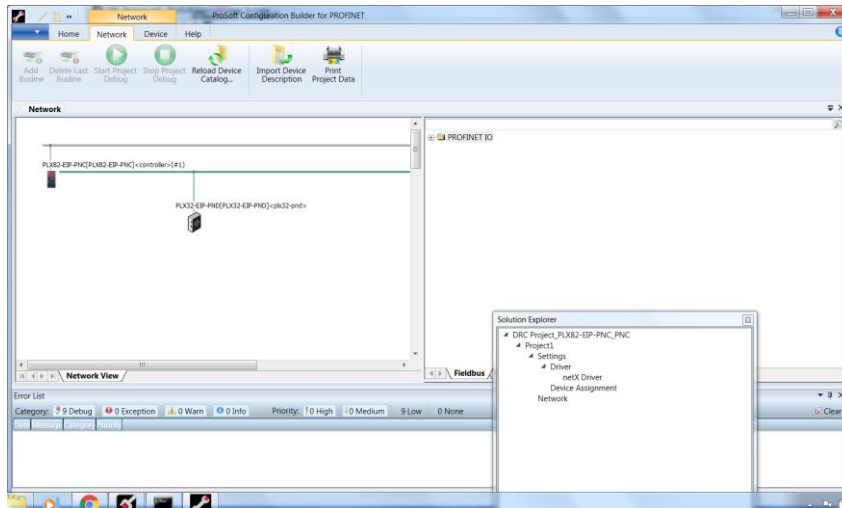

- 3 In the *Solution Explorer* pane, double-click on **NETX DRIVER**.

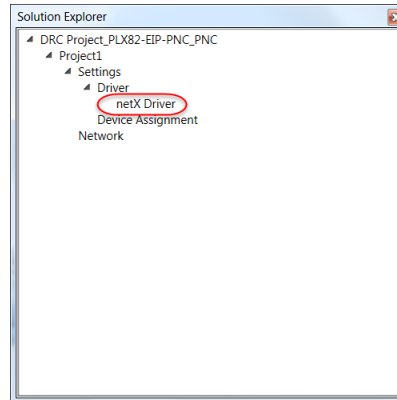

- 4 A *netX Driver* tab appears to the right of the *Network* tab. Click the **NETX DRIVER** tab to open the *TCP Connection* page.

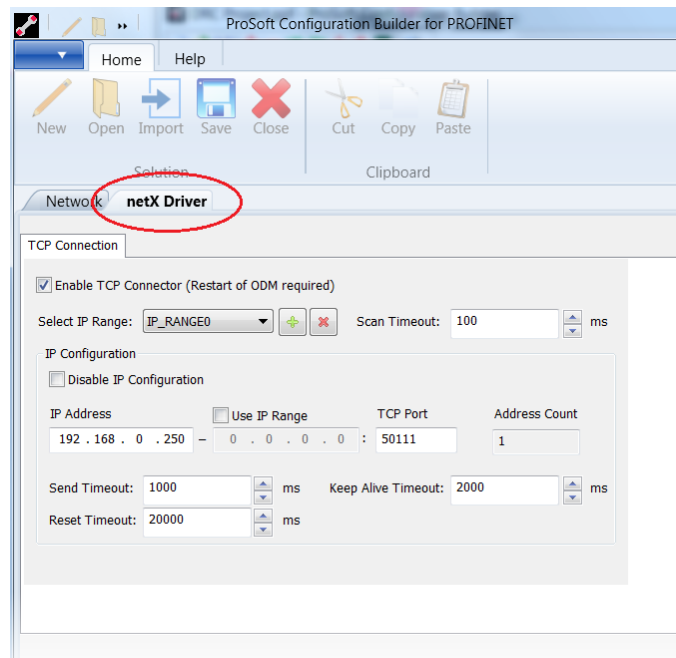

- 5 The netX Driver is used to connect *ProSoft fdt Configuration Manager* configuration software to the device via a TCP/IP connection.
- 6 Ensure that the *Enable TCP Connector* parameter is selected. With the *Enable TCP Connector* box checked, the netX Driver can communicate with other devices via the TCP/IP interface. If *Enable TCP Connector* is not set (checked), the ODM server must be started in order for the new settings to be valid.
- 7 Enter the IP address of the MBTCP port of the PLX82-EIP-PNC.
- 8 Click **SAVE**.

OR

- 1 Check the **USE IP RANGE** checkbox.
- 2 Enter a starting IP address and an ending IP address range.
- 3 Click the **SAVE** icon.

Parameter	Description
Enable TCP Connector (Restart of ODM required)	Checked: Communication between the software and the device via TCP/IP can occur. Unchecked: Communication between the software and the device via TCP/IP cannot occur. Note: <i>If the checkmark for this setting is set or removed, the ODM server must be restarted.</i>
Select IP Range	This allows existing IP ranges to be selected. Use the "+" symbol to add an additional IP range or the "x" symbol to remove an IP range.
Scan Timeout	Specifies how long to wait for a response that indicates session establishment. 10 to 10,000 ms. The default is 100 ms.
Disable IP Range	Checked: No connection Unchecked: the netX Driver tries to establish a connection using the configured TCP/IP interface.
IP Address (Left)	Enter the IP address of the device (when "Use IP Range" is not checked) Enter the start address of the IP scanning range if "Use IP Range" is checked.
Use IP Range	Checked: An IP address range is used.
IP Address (Right)	Enter the ending address of the IP scanning range (if "Use IP Range" is checked)
Address Count	Displays the scanning range address count, depending on the selected IP-start or IP-end address.
TCP Port	Identifies the endpoint of a logical connection or addresses a specific endpoint on the device or PC.
Send Timeout	Maximum time before the transfer of the transmission data is canceled when the send process fails. For example, the transfer buffer is full. 100 to 60,000 ms Default (TCP/IP) is 2000 ms.
Reset Timeout	Maximum time for a device reset, including the re-initialization of the physical interface used for the communication. 100 to 60,000 ms Default (TCP/IP) is 2000 ms
Keep Alive Timeout	The Keep-Alive mechanism is used to monitor whether the connection to the device is active. Connection errors are detected using a periodic heartbeat mechanism. This mechanism is initiated after the set time has elapsed if the communication has failed.
Restore	Resets all settings in the configuration dialog to the default values.
Save	Save all settings made in the configuration dialog for the selected connection type.
Save All	Save all settings made in the configuration dialog for all connection types.

- 1 From the *Solution Explorer* dialog box, double-click **DEVICE ASSIGNMENT**.

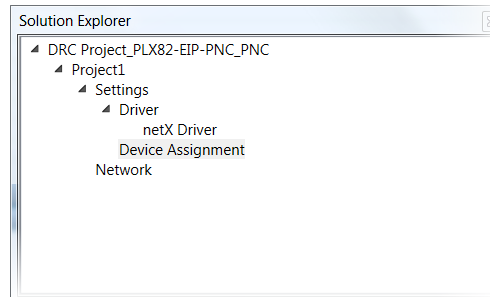

- 2 Click on the **DEVICE ASSIGNMENT** tab and then click **SCAN**. The system scans for all devices that can be connected to the ProSoft fdt Configuration Manager software.

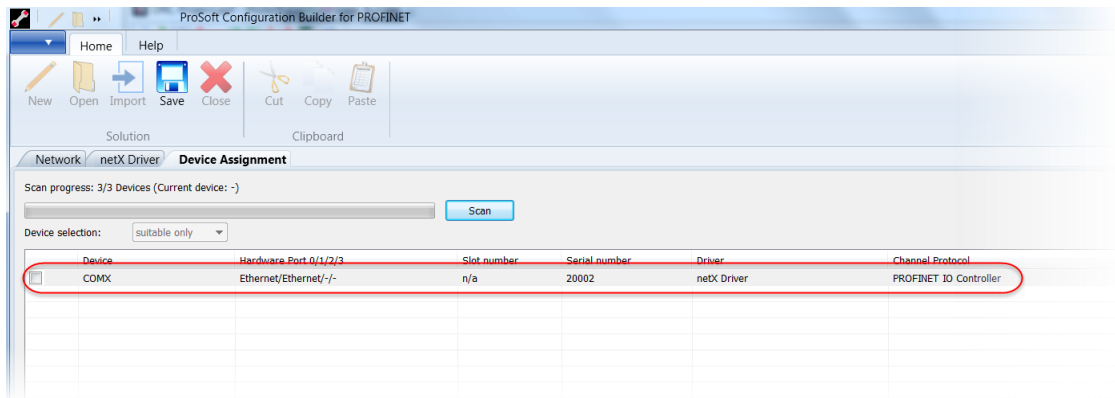

Parameter	Description
Device Selection	Select " <i>suitable only</i> " or " <i>all</i> " devices
Device	Device class of the PROFINET devices
Hardware Port 0/1/2/3	Indicates what hardware is assigned to a communication interface
Slot Number	Not applicable
Serial Number	Serial number of the device
Driver	Name of the driver
Channel Protocol	Displays the firmware loaded to a channel.
Access Path	Access path to different data to devices. Displays the IP address and port of the device. Also displays the channel number 0 to 3.

- 3 Select the appropriate device by clicking the checkbox. This is the MBTCP device within the PLX82-EIP-PNC.

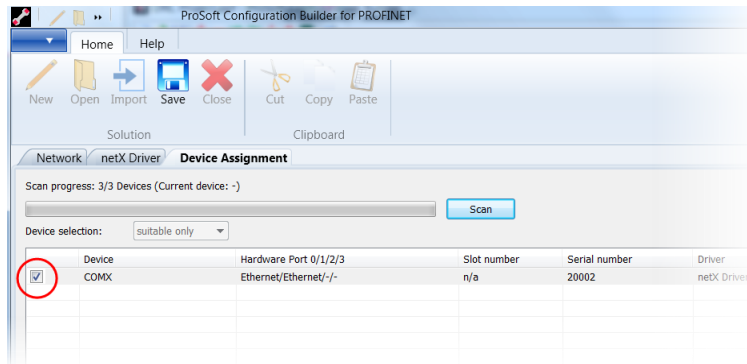

- 4 Click the **SAVE** icon.

9.3.1 Establishing a Diagnostic Connection

Once you have configured the *netx Driver* and *Device Assignments*, you can create a TCP connection between your PC and the PLX82-EIP-PNC.

- 1 From the ProSoft fdt Configuration Manager page, click the **NETWORK** tab.

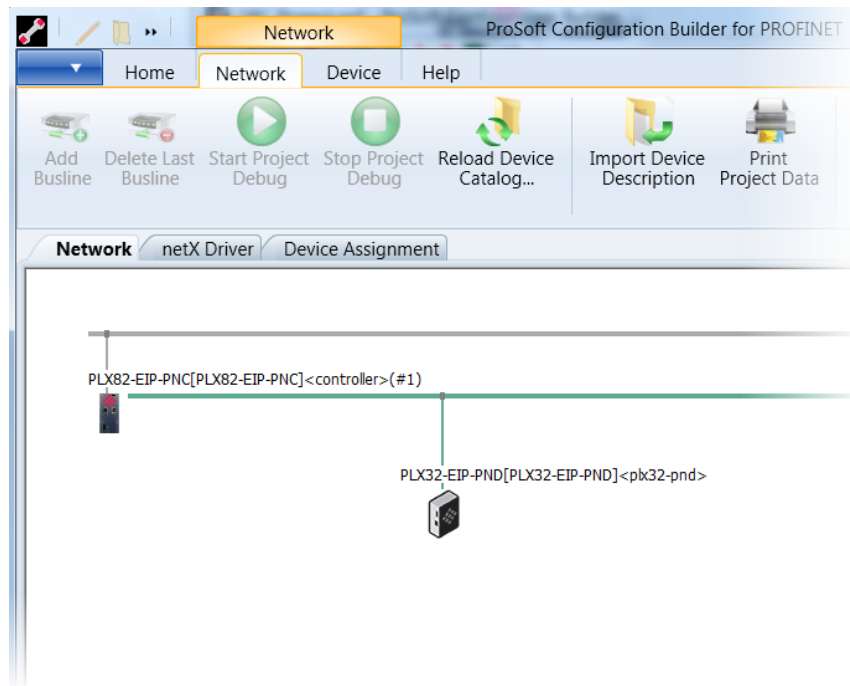

- 2 Right-click on the **PLX82-EIP-PNC** icon, and select **CONNECT**. You can also click on the **CONNECT** icon at the top of the page.

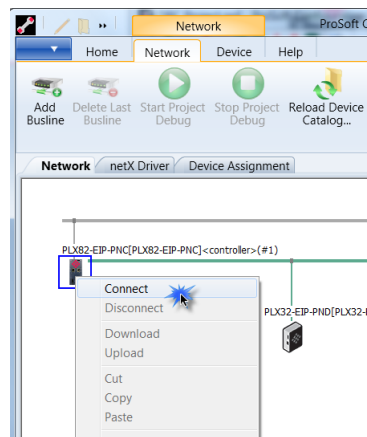

- 3 The module information located above the icon is highlighted in green once the connection is established.

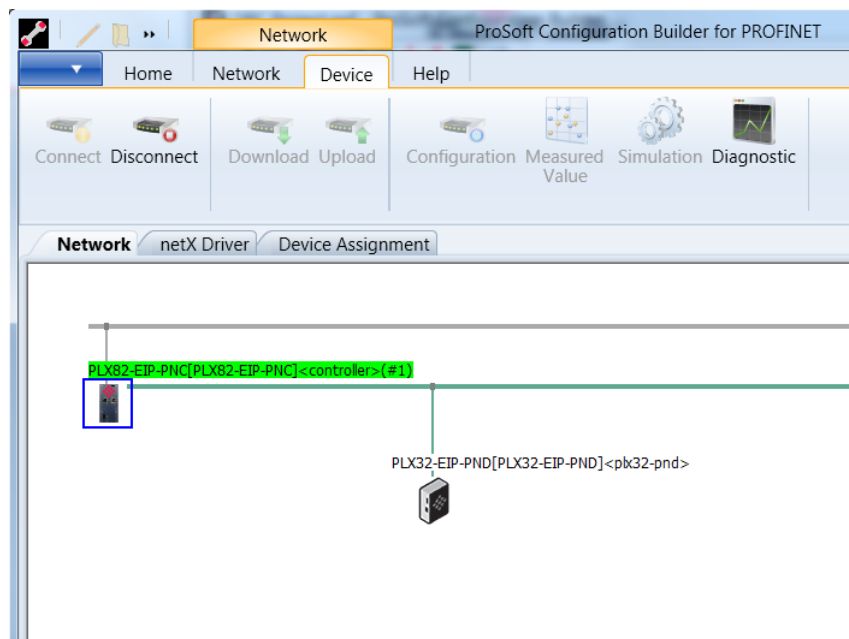

4 Right-click on the **PLX82-EIP-PNC** icon and select **DIAGNOSIS**.

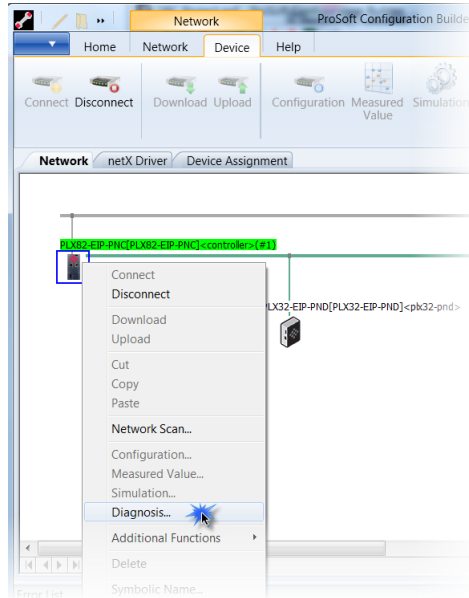

5 The *Diagnostic* pane opens with *General Diagnosis* information displayed.

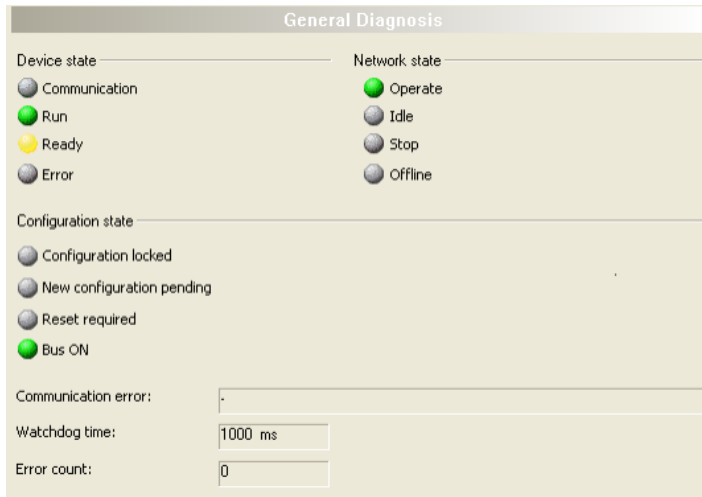

9.3.2 General Diagnosis

The *General Diagnosis* pane provides information on the device state as well as other general diagnostic parameters.

LED	Description	Color
Device State		
Communication	Indicates whether the PROFINET device executes during network communication.	Green - In communication state Gray - Not in communication state
Run	Indicates whether the PROFINET device has been configured correctly	Green - Configuration OK Gray - Incorrect configuration
Ready	Indicates whether the PROFINET device has been started correctly. The PROFINET device waits for a configuration.	Yellow - Device is Ready Gray - Device is not ready
Error	Indicates whether the PROFINET device recorded a device status error (see <i>Extended Diagnosis</i>)	Red - Error Gray - No Error
Network State		
Operate	Indicates whether the PROFINET device is in data exchange. In a cyclic data exchange, the input or output data is transmitted to the PROFINET device.	Green - In Operation state Gray - Not in Operation state
Idle	Indicates whether the PROFINET is in Idle state	Yellow - In Idle state Gray - Not in Idle state
Stop	Indicates whether the PROFINET device is in Stop state. There is no cyclic data exchange on the PROFINET network. The PROFINET device was stopped by the application program, or it changed the Stop state because of a bus error.	Red - In Stop State Gray - Not in Stopped state
Offline	The PROFINET device configuration is offline as long as it does not have a valid configuration.	Yellow - In Offline state Gray - Not in Offline state
Configuration State		
Configuration locked	Indicates whether the PROFINET device configuration is locked to avoid configuration data writeover.	Yellow - Configuration locked Gray - Configuration not locked
New Configuration pending	Indicates whether a new PROFINET device configuration is available.	Yellow - New configuration pending Gray - No new configuration pending
Reset Required	Indicates whether a firmware reset is required as a new PROFINET device has been loaded into the device	Yellow - Reset required Gray - No reset required
Bus On	Indicates whether the bus communication was started or stopped (i.e., whether the device is active on the bus or not bus communication to the device is possible and no response messages are sent	Green - Bus On Gray - Bus Off

Communication Error - Displays the name of the communication error. If the cause of the error is resolved, the value is set to zero again.

Watchdog Time - Displays the watchdog time in ms.

Error Count - This field holds the total number of errors detected since power-up. The protocol stack contains all sorts of errors in this field, regardless of whether they were network related or caused internally.

9.3.3 Master Diagnosis

The *Master Diagnosis* dialog provides the slave state, slave errors, and slaves configured active or in diagnostic mode.

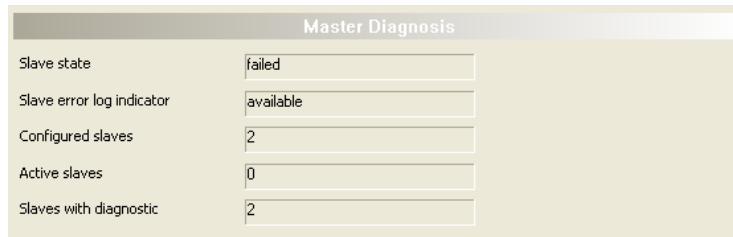

Parameter	Description
Slave state	Indicates whether the current slave state is OK. The slave state field indicates whether the Master is in cyclic data exchange to all configured slaves. In the event that there is at least one slave missing, or if the slave has a diagnostic request pending, the status is set to Failed. For protocols that support non-cyclic communication only, the slave state is set to OK as soon as a valid configuration is found. Values: Undefined, OK, Failed
Slave error log indicator	Indicates whether the Slave Error Log indicator is available. The Error Log Indicator field holds the number of entries in the internal error log. If all entries are read from the log, the field is set to zero. Values: Empty, Available
Configured slaves	Displays the number of configured slaves. Number of configured slaves on the network according to the slave list derived from the configuration database created by the configuration software. This list includes the slaves to which the master has to open a connection.
Active Slaves	Displays the number of active slaves. Number of slaves in data exchange mode. The list includes the slaves to which the master has successfully opened a connection.
Slaves with diagnostic	Displays the number of slaves with diagnostic. The number of slaves with diagnostic or errors.

9.3.4 Station Diagnosis

The *Station Diagnosis* dialog displays the current status of all slaves.

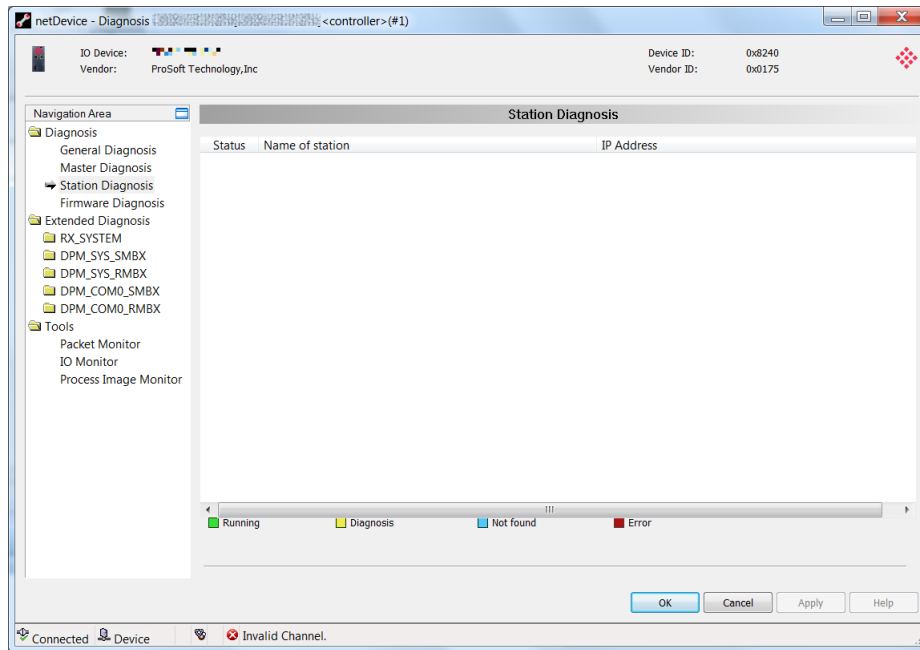

Parameter	Description
Status	Green - Running Yellow - Diagnosis state Blue - Not found Red - Error
Name of Station	Name of slave device
IP Address	IP Address of slave device

9.3.5 Firmware Diagnosis

The *Firmware Diagnosis* dialog displays task diagnosis information of the firmware.

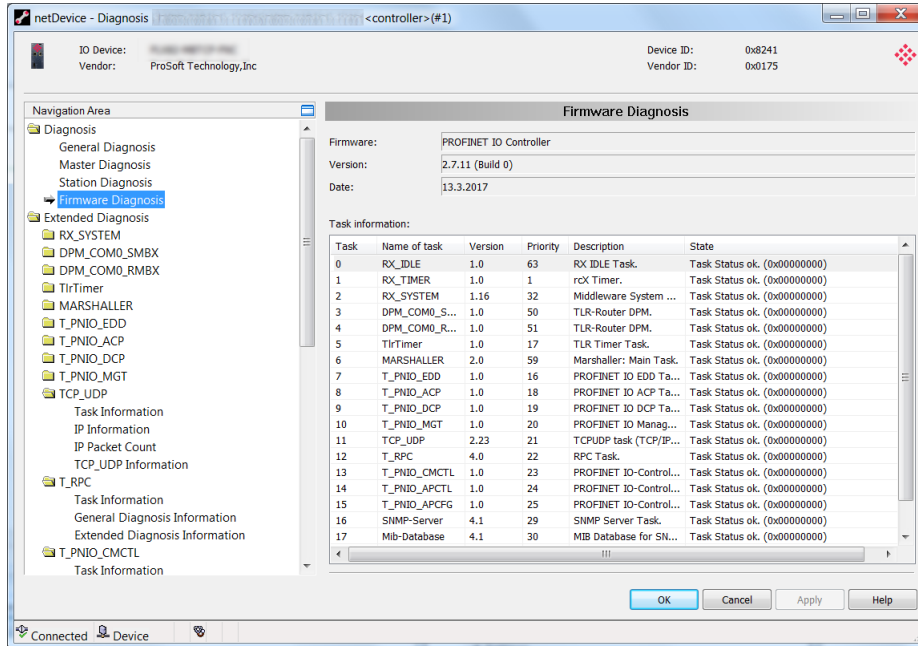

Firmware: Name of the most current firmware.

Version: This number represents the stack version, not the firmware version of the module. The firmware version of the module is shown on the module web service.

Date: Displays the date of the PROFINET stack version.

Parameter	Description
Task	Displays the task number.
Name of task	Displays the name of the actual task.
Version	Version of the task
Priority	Displays the priority of the task
Description	Displays the description of the task
Status	Status of the task

9.3.6 Extended Diagnosis

The *Extended Diagnosis* dialog contains a list of diagnosis structures such as online counter, states, and parameters. Access requires an online connection between the ProSoft fdt Configuration Manager and the PROFINET Controller.

Folder	Contains
RX_SYSTEM	Task Information
DPM_COM0_SMBX	Task Information
DPM_COM0_RMBX	Task Information
TirTimer	Task Information
MARSHALLER	Task Information
T_PNIO_EDD	Task Information General Diagnosis Info Extended Diagnosis Info XMAC Diagnosis Structure
T_PNIO_ACP	Task Information General Diagnosis Info Extended Diagnosis Info
T_PNIO_DCP	Task Information General Diagnosis Info Extended Diagnosis Info
T_PNIO_MGT	Task Information General Diagnosis Info Extended Diagnosis Info
TCP_UDP	Task Information IP Information IP Packet Count TCP_UDP Information
T_RPC	Task Information General Diagnosis Info Extended Diagnosis Info
T_PNIO_CMCTL	Task Information General Diagnostics Extended Diagnostics NRPM (Device NameResolution) results Connection Establishment results
T_PNIO_APCTL	Task Information General Diagnosis Info Extended Diagnosis Info
T_PNIO_APCFG	Task Information General Diagnosis Info Extended Diagnosis Info
SNMP Server	Task Information
Mib Database	Task Information
LLDP-Task	Task Information
Packet Router	Task Information

RX_SYSTEM > Task Information

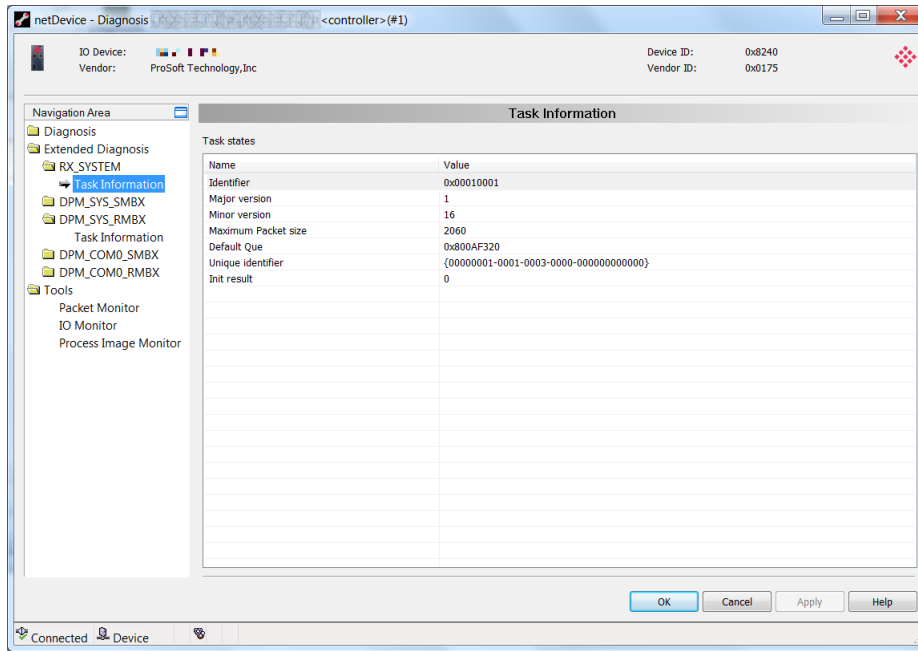

Parameter	Description
Identifier	Identification number of the task.
Major version	Task version, contains all incompatible changes.
Minor version	Task version, contains compatible changes.
Maximum packet size	Maximum packet size that the task sends.
Default queue	Queue handle accessible via DPM by mailbox
Unique Identifier	16 byte indicator used for task identification and its affiliation (e.g., to a stack)
Init result	Error Code, 0 = no error The description of error codes are available in the following sections.

General Diagnosis Information

General Diagnosis Information	
Task states	
Name	Value
Last TLR error code	Operation succeeded.
Last PNIO error code	0x00000000
TLR Error Counter (may count single error seve...	0
PNIO Error Counter (may count single error sev...	0
Active PM Counter	0
Send Packet Error Counter	0
Malloc Error Counter	0
ErrExternal (Received unsupported Requests)	0
ErrInternal (Received unsupported Confirmations)	0
Maximum Pool usage	0
Current Pool usage	0

Parameter	Description
Last TLR error code	Error code of the last internally occurred error.
Last PNIO error code	Error code of the last externally occurred error which has been reported by an I/O device.
TLR Error Counter	Counts the number of occurred TLR error codes.
PNIO Error Counter	Counts the number of occurred PNIO error codes.
Active PM Counter	Counter of the active protocol machines in the task.
Send Packet Error Counter	Counts how often a task sends a packet to another task and this fails.
Malloc Error Counter	Counts how often storage capacity is requested in the operating system and the operating cannot follow this demand.
ErrExternal	Counts how often an unknown request packet was received.
ErrInternal	Counts how often an unknown confirmation packet was received.
Maximum Pool Usage	Counts how many pool elements were used simultaneously (maximum).
Current pool usage	Counts the number of pool elements currently in use.

T PNIO EDD Extended Diagnosis Information

Extended Diagnosis Information	
Task states	
Name	Value
Cyclic Frames sent	0
Missing cyclic Frames counter (CPM)	0

Parameter	Description
Cyclic Frames sent	Counts cyclical frames that were sent.
Missing Cyclic Frames counter (CPM)	Counts the missing cyclical frames agreed on.

XMAC Diagnosis Structure

XMAC diagnosis structure	
Task states	
Name	Value
FramesTransmittedOk	0
SingleCollisionFrames	0
MultipleCollisionFrames	0
LateCollisions	0
LinkDownDuringTransmission	0
UtxUnderflowDuringTransmission	0
FramesReceivedOk	0
FrameCheckSequenceErrors	0
AlignmentErrors	0
FrameTooLongErrors	0
RuntFramesReceived	0
CollisionFragmentsReceived	0
FramesDroppedDueLowResource	0
FramesDroppedDueUrxOverflow	0

The values of the XMAC diagnosis structure are read every 2 seconds from the XMACs (hardware).

Parameter	Description	Value/Range of Values
FramesTransmittedOK	Number of the correctly received Ethernet frames	0 to 4,294,967,295
SingleCollisionFrames	Number of the frames involved in a collision.	0 to 4,294,967,295
MultipleCollisionFrames	Number of frames involved in several collisions	0 to 4,294,967,295
LateCollisions	Number of clashed frames after at least 512 bits of the frame have been transmitted	0 to 4,294,967,295
LinkDownDuringTransmission	Number of frames sent during a broken connection	0 to 4,294,967,295
UtxUnderflowDuringTransmission	Number of frames sent erroneously because of buffer underflow.	0 to 4,294,967,295
FramesReceivedOK	Number of correctly received frames	0 to 4,294,967,295
FrameCheckSequenceErrors	Number of corruptly received frames (FCS check failed)	0 to 4,294,967,295
AlignmentErrors	Number of frames received in which its length is not an even number of bytes	0 to 4,294,967,295
FrameTooLongErrors	Number of frames received in which its length exceeds the maximum permitted frame length	0 to 4,294,967,295
RuntFramesReceived	Number of frames received undamaged with a length of 42 to 63 bytes. (Under run of the minimum permitted frame length)	0 to 4,294,967,295
CollisionFragmentsReceived	Number of frames received corruptly with a length of 42 to 63 bytes. (FCS check failed)	0 to 4,294,967,295
FramesDroppedDueLowResource	Number of frames lost because of a memory deficiency	0 to 4,294,967,295
FramesDroppedDueUrxOverflow	Number of frames lost because of buffer underflow	0 to 4,294,967,295

T PNIO ACP Extended Diagnosis Information

Extended Diagnosis Information	
Task states	
Name	Value
Received unsupported Frames	0
Active Consumer Protocol Machines	0
Active Provider State Machines	0
Received high priority alarms	0
Received low priority alarms	0

Parameter	Description
Received unsupported frames	Frames which cannot be used by the consumer.
Active Consumer Protocol Machines	Number of state machines supervised by the cyclical communication consumer = receiver (supervises frames of the I/O devices received)
Active Provider State Machines	Number of state machines, the frames transmit to the devices
Received high priority alarms	Number of high priority alarms for PROFINET IO
Received low priority alarms	Number of low priority alarms for PROFINET IO

PNIO_DCP Extending Diagnosis Information

Extended Diagnosis Information	
Task states	
Name	Value
Active Application Timers Counter	0
Erroneous Frames received	0
Ident Request sent Counter	0
Ident Response received Counter	0
DCP Set Requests sentcounter	0
Positiv DCP Set Responses	0
Negativ DCP Set Responses	0
DCP Hello Requests Received	0
Hello reported to NRPM	0

The PNIO_DCP Extended Diagnosis information displays the counter reading of the four state machines from the PROFINET I/O DCP protocol.

- MCR - Multicast Receiver
- UCR - Unicast Receiver
- MCS - Multicast Sender
- UCS - Unicast Sender

Parameter	Description
Active Application Timers Counter	Software timer actually running in the task.
Erroneous Frames received	Counter for erroneous frames received.
Ident Request sent Counter	Counter for Ident Request send Counter
Ident Response received Counter	Counter for Ident Responses received
DCP Set Request sentcounter	Could for DCP Set Request sent
Positive DCP Set Responses	Counter for Positive DCP Set Responses
Negative DCP Set Responses	Counter for Negative DCP Set Responses
DCP Hello Requests Received	Counter for DCP Hello Requests received
Hello reported to NRPM	Counter for Hello reported to the NRPM state machine.

T PNIO_MGT Extended Diagnosis Information

Extended Diagnosis Information	
Task states	
Name	Value
Ident Requests Sent	0
Ident Responses received (Conflict)	0
Ident Responses received (Forbid)	0
Ident Responses received (Permit)	0
Identify Q Indications received (Multiple)	0
Identify Q Indications received (Forbid)	0
Identify Q Indications received (Permit)	0
NRPM Init Request Counter	0
NRPM Init Confirm Counter	0
NRPM Init Error Counter	0
Identify Q Indications received (Ident ALL)	0

Parameter	Description
Ident Requests Sent	PROFINET I/O specific service
Ident Responses received (Conflict)	Status of the internal status machines in the controller.
Ident Responses received (Forbid)	
Ident Responses received (Permit)	
Identify Q Indications received (Multiple)	Status of the internal status machines in the controller.
Identify Q Indications received (Forbid)	
Identify Q Indications received (Permit)	
NRPM Init Request Counter	Counter for special PROFINET I/O services
NRPM Init Confirmation Counter	Counter for special PROFINET I/O services
NRPM Init Error Counter	Counter for special PROFINET I/O services
Identify Q Indications received (Ident ALL)	Counter for special PROFINET I/O services

TCP UDP

IP Information

IP Information	
Task states	
Name	Value
Task State	1
Error Count	2
Last Error	0xC0000119
IP Address	0.0.0.0
Net Mask	0.0.0.0
Gateway	0.0.0.0

Parameter	Description
Task State	Actual state of the protocol process: 0 = Task not initialized 1 = Task is running 2 = Task initialized 3 = Initialization
Error Counter	Counter for errors
Last Error	Last error that occurred
IP Address	IP address of the slave device
Netmask	Network mask of the slave device
Gateway	Gateway address of the Slave device

IP Packet Counter

IP Packet Count	
Task states	
Name	Value
Packet Recv TCP	0
Packet Recv UDP	28631
Packet Recv ICMP	0
Packet Recv IP Header Err	0
Packet Recv ARP	8
Packet Recv Unknown	0

Parameter	Description
Packet Recv TCP	Counter for received TCP packets
Packet Recv UDP	Counter received for UDP packets
Packet Recv ICMP	Counter for received ICMP packets
Packet Recv IP Header Err	Counter for received IP packets with errors
Packet Recv ARP	Counter for received ARP packets
Packet Recv Unknown	Counter for received packets of an unknown type

TCP_UDP Information

TCP_UDP Information	
Task states	
Name	Value
Task State	1
Error Count	2
Last Error	0xC0080032

Parameter	Description
Task State	Actual state of the protocol process: 0 = Task not initialized 1 = Task is running 2 = Task initialized 3 = Initialization error
Error Count	Counter for errors
Last Error	Last error that occurred

T_RPC

Extended Diagnosis Information	
Task states	
Name	Value
PINGS sent	0
PINGS received	0
WORKINGS sent	0
WORKINGS received	0
NOCALLs sent	0
NOCALLs received	0
CANCELS sent	0
CANCELS received	0
REJECTs sent	0
REJECTs received	0
Requests sent	0
Requests received	0
Responses sent	0
Responses received	0
Fragments sent	0
Fragments received	0
Active Application Timers	0

The T_RPC Extended Diagnosis Information displays PROFINET I/O specific counters.

T_PNIO_CMCTL

Extended Diagnosis Information	
Task states	
Name	Value
Release Request Counter	0
Received RPC RequestsCounter	0
Sent RPC Requests Counter	0
Module Diff Block Counter	0
Connect Request Counter	0
NRPM Init Request Counter	0
Positive NRPM Init Response Counter	0
Negativ NRPM Init Response Counter	0
Get Device Information counter	0
Read Request counter	0
Positive Read Response Counter	0
Negativ Read Response Counter	0
Write Request counter	0
Positive Write Response Counter	0
Negativ Write Response Counter	0

The T_PNIO_CMCTL Extended Diagnostics Information displays PROFINET I/O specific counters.

T_PNIO_APCTL

Extended Diagnosis Information	
Task states	
Name	Value
Active Application Timers	0
Received Alarms	0
Received Diagnosis Alarms	0
Diagnosisentries read by Application	0
Alarms indicated to Application	0
Counter for packets that could not be ...	0
Flags	0x00000001

Parameter	Description
Active Application Timers	Number of active software timer.
Received Alarms	Alarms read by the application
Received Diagnosis Alarms	
Diagnosis entries read by application	
Alarms indicated by application	
Counter for packets that could not be sent to the application	Counts how often packets are sent from the firmware to the application and then fails
Flags	Cached status data

T_PNIO_APCFG

Extended Diagnosis Information	
Task states	
Name	Value
Overhead for database	0 Byte
Amount of configured IO-Devices	0
Amount of configured IOCRs	0
Amount of configured APIs	0
Amount of configured Modules	0
Amount of configured Submodules	0
Amount of configured SubmoduleDesc...	0
Amount of configured Data Records	0
Amount of active IO-Devices	0
Amount of configured InterfaceSubmo...	1
Amount of configured PortSubmoduleL...	1

The T_PNIO_APCFG Extended Diagnostics Information displays PROFINET I/O specific parameters.

9.3.7 Tools

The *Packet Monitor*, *I/O Monitor*, and *Process Image Monitor* tools are provided for testing and diagnostic functions. Access to the tools requires a connection between ProSoft fdt Configuration Manager and the PNC driver.

Packet Monitor

The *Packet Monitor* is used for testing and diagnostics. Data packets are self-contained blocks of a defined data length. The packets are used to communicate with the firmware and are exchanged between the application (configuration software) and the firmware in the device. Packets can be sent once or cyclically to the connected device controlled by the user and received packets can be displayed.

Data packets include a packet header and the sent data or may be comprised of a packet header and received data. The packet data can be evaluated by the receiver of the packet and contain the sender and receiver address, data length, ID number, status and error messages, and the command or response code.

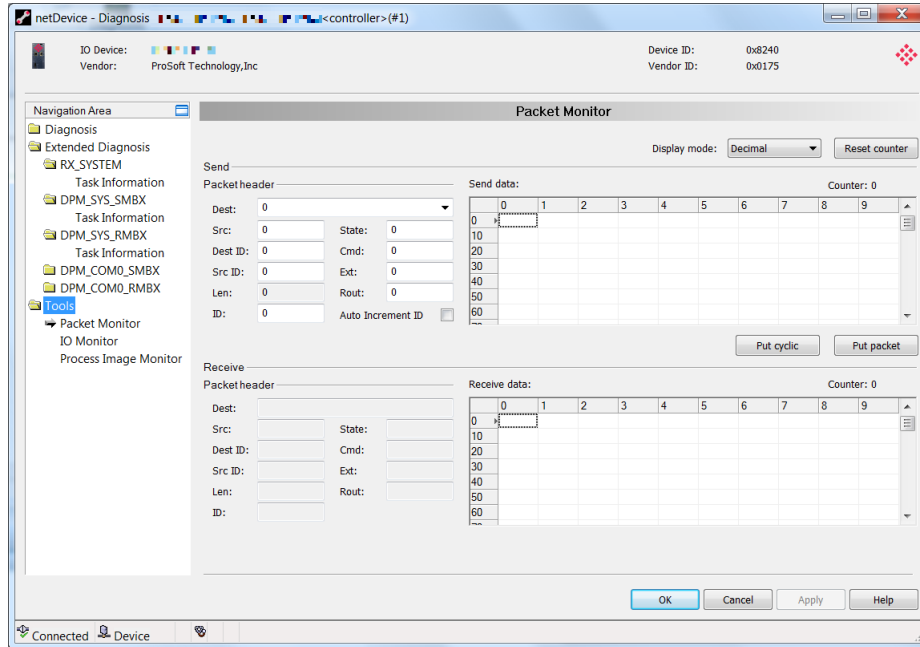

DISPLAY MODE switches the representation of data between decimal and hexadecimal. Use the **RESET** button to reset the packet counter.

Send Packet

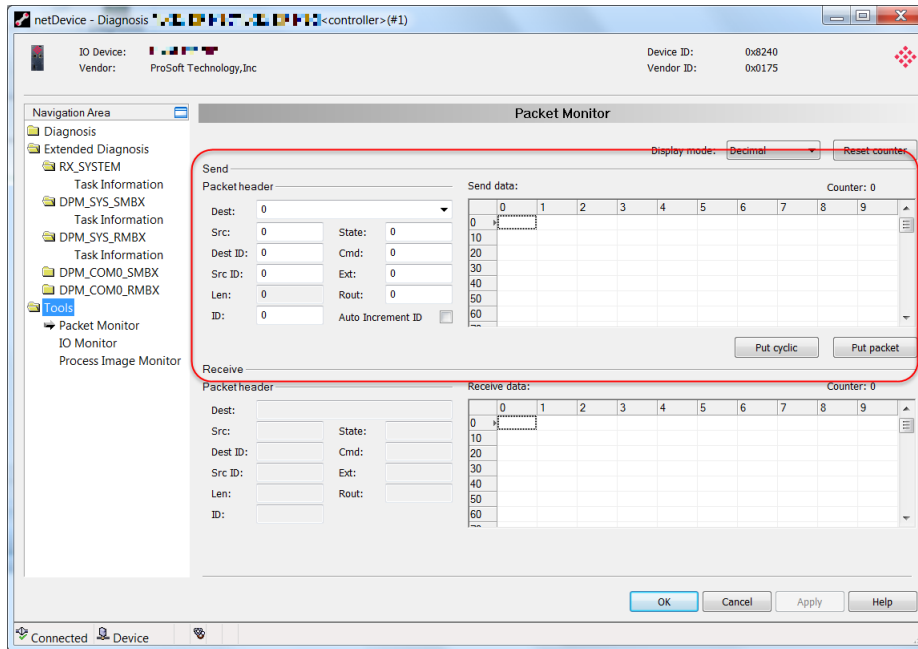

Packet Header

Packet elements of the send packet header are displayed. This information is transmitted from the application (configuration software) to the device.

Parameter	Value	Description
Dest	Destination Queue Handle	Contains the identifier of the receiver for the packet (destination tasks queue of the firmware).
Src	Source Queue Handle	Contains the identifier of the sender of the packet (sending task).
Dest ID	Destination Queue Reference	Contains an identifier for the receiver of unsolicited sent packets from the firmware to the application (configuration software).
Src ID	Source Queue Reference	Contains an identifier of the sender.
Len	Packet Data Length (in bytes)	Length of the send data.
State	Status/Error Code	Transmits status or error codes to the packet sender.
Cmd	Command/Response Code	Command or respond code.
Ext	Extension	Field for extensions.
Rout	Routing Information	Internal value of the firmware.
ID	Packet identification as unique number	Identifies identical data packets among each other.

- 1 Select the the receiver (destination task queue) from the **DEST** drop-down list box.

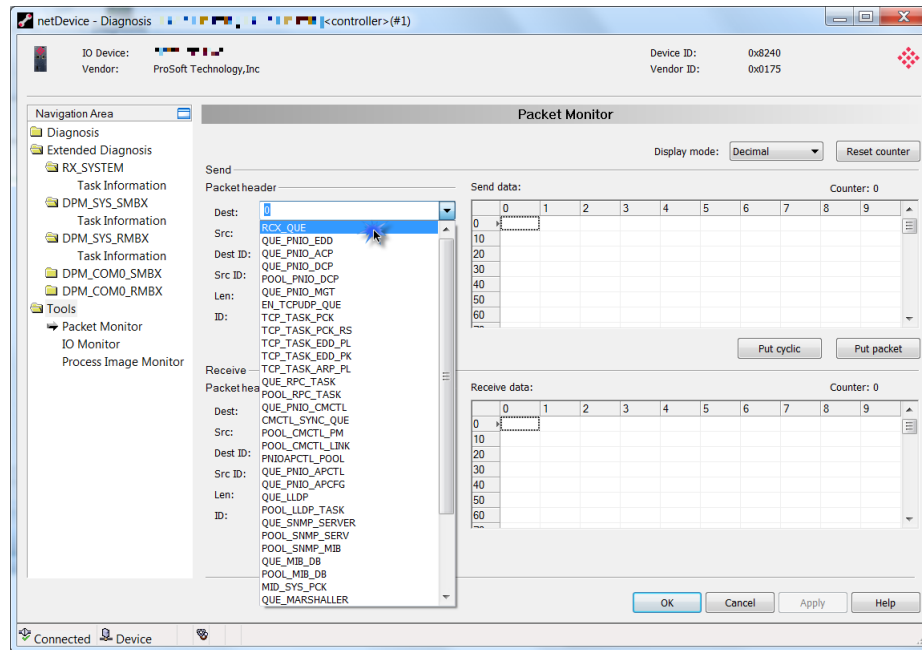

- 2 Enter the command in the *Cmd* field (request).

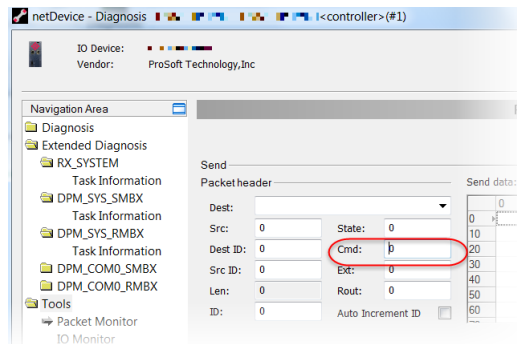

- 3 The **AUTO INCREMENT ID** checkbox specifies that the identifier should be incremented by one for each newly sent packet.

Send Data pane

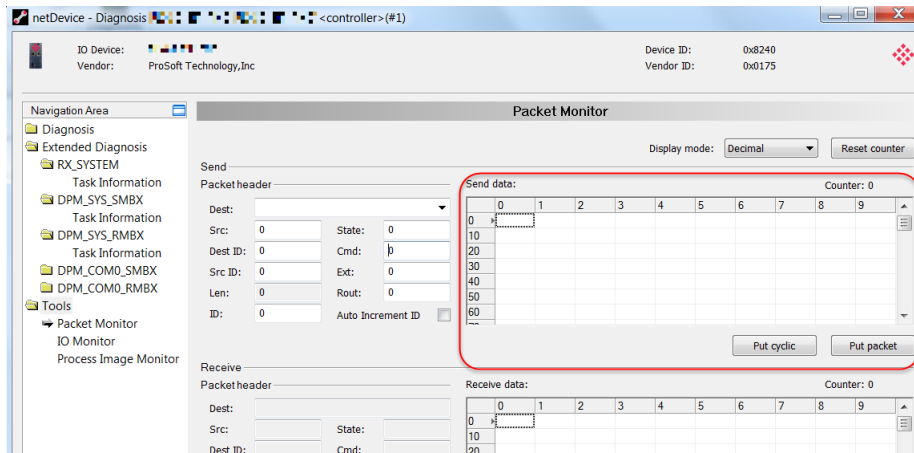

This area allows you to enter the send data of the packet that is transmitted from the application (configuration software) to the mailbox of the device. The description of the transmitted data depends on the command or response code.

- The **PUT CYCLIC** button specifies that the packet should be sent cyclic.
- The **PUT PACKET** button specifies that the packet should be sent once.

Receive Packet

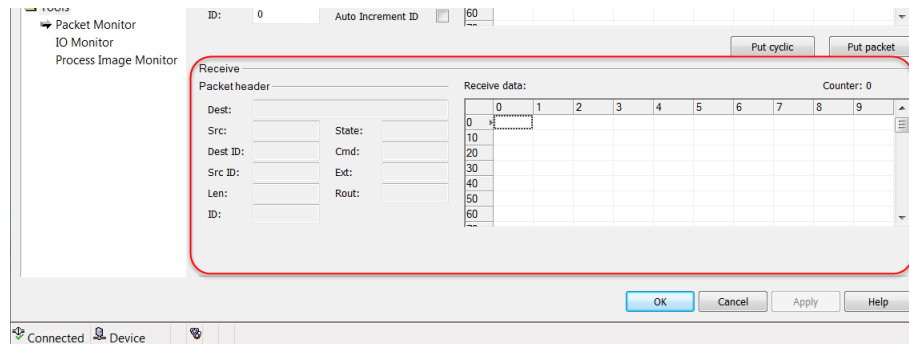

Packet Header

Packet elements of the receive packet header are displayed. This information is transmitted from the device to the application (configuration software).

Parameter	Value	Description
Dest	Destination Queue Handle	Contains the identifier of the receiver of the packet (destination task queue of the firmware).
Src	Source Queue Handle	Contains the identifier of the sender of the packet (sending tasking)
Dest ID	Destination Queue Reference	Contains an identifier for the receiver on unsolicited sent packets from the firmware to the application (configuration software).
Src ID	Source Queue Reference	Contains an identifier of the sender
Len	Packet Data Length (in bytes)	Length of the send respectively receive data.
ID	Packet Identification as Unique Number	Identifies identical data packets among each other.
State	Status/Error Code	Transmits status or error codes to the packet sender.
Cmd	Command/Response Code	Command or response code.
Ext	Extension	Field for extensions.
Rout	Routing information	Internal values of the firmware.

Receive Data pane

Displays the receiving data of the packet transmitted back from the device to the application (configuration software).

IO Monitor

The *I/O Monitor* is used for testing and diagnostic purposes. It provides a view of the process data image (in bytes) and allows the change of data easily.

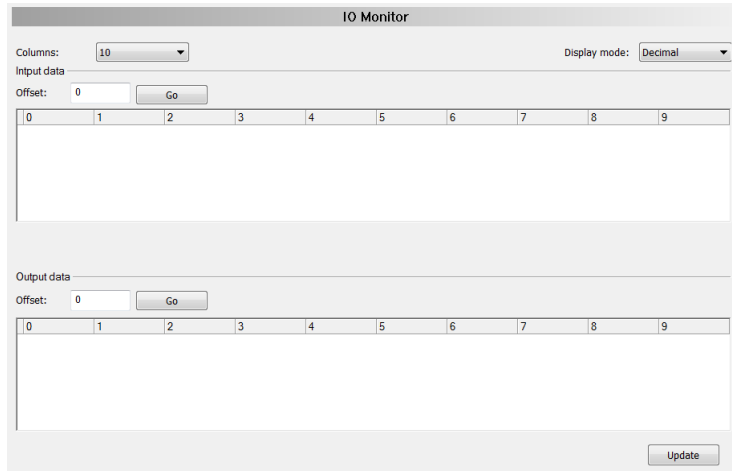

Warning: Only change and write output data if you know that it will not cause plant disturbances. All output data written by the I/O Monitor are transmitted at the bus and have an effect on subordinate drives, IO, etc.

- The **COLUMNS** drop-down list changes the number of columns.
- The **DISPLAY MODE** drop-down list allows you to switch the representation of the input and output data between decimal and hexadecimal.
- The **OFFSET / GO** parameters move the indication of the data to the entered offset value.

Enter the output value and click the **UPDATE** button.

Process Image Monitor

This monitor lists devices connected to the PNC controller, as well as configured modules or input or output signals of the devices. This allows you to view the fieldbus structure and the data structure of the device's input and output data transmitted on the bus. Signal data provided to the OPC server is also displayed here.

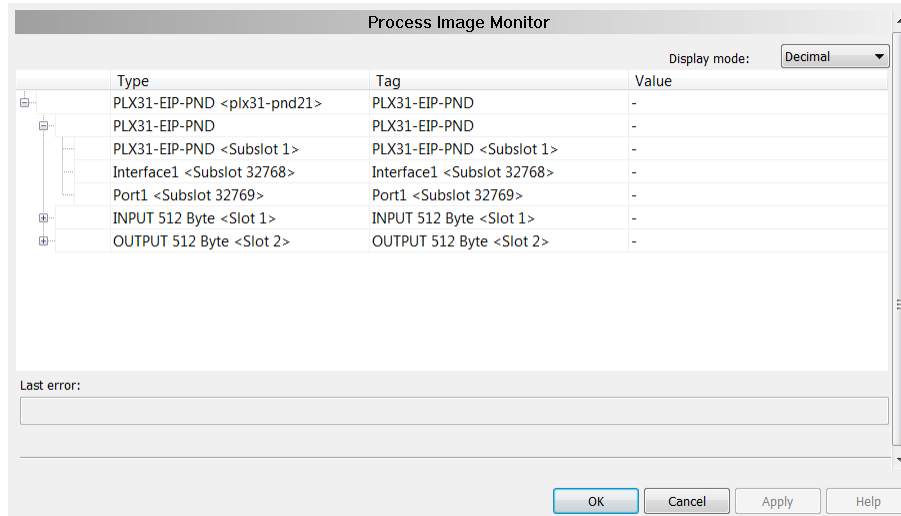

Parameter	Description
Display Mode	Allows you to display values in the Value column in decimal or hexadecimal mode.
	A tree structure is used to display the structure of the devices: Devices(1) Modules (2) Input Data (3) Output Data (4)
	Shown when the input and output data are not completely read and analyzed.
	Displayed when input and output data are not valid.
	Displayed when input and output data are valid.
Type	Device labeling in the hardware. Describes the module or input or output signals configured for the device.
Tag	Device name provided by the hardware (not changeable within PCB for PROFINET configuration software) or symbolic name for the modules configured for the device for input and output signals (changeable on the Configuration > Process Data page)
Value	Displays the valid input and output data values
Last Error	Last error to occur.

9.3.8 Viewing Alarm Information

PLX82.ALARMS

PLX82.ALARM.DeviceAlarms

PLX82.ALARM	{...}	{...}		PLX82_ALARM	Main UD ⁷
PLX82.ALARM.DeviceAlarms	{...}	{...}		PLX82_Device_Alarm[36]	Main UD ⁷
PLX82.ALARM.DeviceAlarms[0]	{...}	{...}		PLX82_Device_Alarm	Main UD ⁷
PLX82.ALARM.DeviceAlarms[0].Count	0		Decimal	INT	Main UD ⁷
PLX82.ALARM.DeviceAlarms[0].DeviceNumber	0		Decimal	INT	Main UD ⁷
PLX82.ALARM.DeviceAlarms[0].Slot	0		Decimal	INT	Main UD ⁷
PLX82.ALARM.DeviceAlarms[0].Subslot	0		Decimal	INT	Main UD ⁷
PLX82.ALARM.DeviceAlarms[0].Type	0		Decimal	INT	Main UD ⁷
PLX82.ALARM.DeviceAlarms[0].Priority	0		Decimal	INT	Main UD ⁷
PLX82.ALARM.DeviceAlarms[0].Specifier	0		Decimal	INT	Main UD ⁷
PLX82.ALARM.DeviceAlarms[0].DataSize	0		Decimal	INT	Main UD ⁷
PLX82.ALARM.DeviceAlarms[0].Data	{...}	{...}	Decimal	SINT[20]	Main UD ⁷
PLX82.ALARM.DeviceAlarms[1]	{...}	{...}		PLX82_Device_Alarm	Main UD ⁷
PLX82.ALARM.DeviceAlarms[2]	{...}	{...}		PLX82_Device_Alarm	Main UD ⁷
PLX82.ALARM.DeviceAlarms[3]	{...}	{...}		PLX82_Device_Alarm	Main UD ⁷
PLX82.ALARM.DeviceAlarms[4]	{...}	{...}		PLX82_Device_Alarm	Main UD ⁷

The Order of devices begins with 0 to 35. The information returned totals 1095 bytes (18 overhead + data).

PLX82.ALARM.LastAlarm

PLX82.ALARM	{...}	{...}		PLX82_ALARM	
PLX82.ALARM.DeviceAlarms	{...}	{...}		PLX82_Device_Alarm[36]	
PLX82.ALARM.LastAlarm	{...}	{...}		PLX82_Device_Alarm	
PLX82.ALARM.LastAlarm.Count	0		Decimal	INT	
PLX82.ALARM.LastAlarm.DeviceNumber	0		Decimal	INT	
PLX82.ALARM.LastAlarm.Slot	0		Decimal	INT	
PLX82.ALARM.LastAlarm.Subslot	0		Decimal	INT	
PLX82.ALARM.LastAlarm.Type	0		Decimal	INT	
PLX82.ALARM.LastAlarm.Priority	0		Decimal	INT	
PLX82.ALARM.LastAlarm.Specifier	0		Decimal	INT	
PLX82.ALARM.LastAlarm.DataSize	0		Decimal	INT	
PLX82.ALARM.LastAlarm.Data	{...}	{...}	Decimal	SINT[20]	
PLX82.ALARM.Message	{...}	{...}	Decimal	SINT[1400]	
PLX82.EIP_PNC.0.C	{...}	{...}		AB:1756_MODULE.C:0	
PLX82.EIP_PNC.0.I	{...}	{...}		AB:1756_MODULE.INT_496Byte	

PLX82.ALARM.Message

PLX82.ALARM.Message	{...}	{...}	Decimal	SINT[1400]	Main UD
PLX82.ALARM.Message[0]	0		Decimal	SINT	Main UD
PLX82.ALARM.Message[1]	0		Decimal	SINT	Main UD
PLX82.ALARM.Message[2]	0		Decimal	SINT	Main UD
PLX82.ALARM.Message[3]	0		Decimal	SINT	Main UD
PLX82.ALARM.Message[4]	0		Decimal	SINT	Main UD
PLX82.ALARM.Message[5]	0		Decimal	SINT	Main UD
PLX82.ALARM.Message[6]	0		Decimal	SINT	Main UD
PLX82.ALARM.Message[7]	0		Decimal	SINT	Main UD
PLX82.ALARM.Message[8]	0		Decimal	SINT	Main UD
PLX82.ALARM.Message[9]	0		Decimal	SINT	Main UD
PLX82.ALARM.Message[10]	0		Decimal	SINT	Main UD
PLX82.ALARM.Message[11]	0		Decimal	SINT	Main UD
PLX82.ALARM.Message[12]	0		Decimal	SINT	Main UD
PLX82.ALARM.Message[13]	0		Decimal	SINT	Main UD
PLX82.ALARM.Message[14]	0		Decimal	SINT	Main UD
PLX82.ALARM.Message[15]	0		Decimal	SINT	Main UD
PLX82.ALARM.Message[16]	0		Decimal	SINT	Main UD
PLX82.ALARM.Message[17]	0		Decimal	SINT	Main UD

9.3.9 EIP Status Data in Upper Memory

The EIP driver has an associated status data area located in the PLX82-EIP-PNC's upper memory. The Data Map functionality of the PLX82-EIP-PNC can be used to map this data into the normal user data range of the PLX82-EIP-PNC's database.

Note that all the status values are initialized to zero (0) at power-up, cold boot and during warm boot.

EIP Server Status Data

The following table lists the addresses in upper memory where the PLX82-EIP-PNC stores status data for each EIP server.

EIP Server	Address Range
0	8900 through 8915
1	8916 through 8931
2	8932 through 8947
3	8948 through 8963
4	8964 through 8979

The content of each server's status data area is structured the same. The following table describes the content of each register in the status data area.

Offset	Description
0 through 1	Connection State
2 through 3	Open Connection Count
4 through 5	Socket Read Count
6 through 7	Socket Write Count
8 through 15	Peer IP

EIP Client Status Data

The following table lists the addresses in upper memory the PLX82-EIP-PNC stores general error and status data for each EIP connected and unconnected client.

EIP Client	Address Range
Connected Client 0	7900 through 7909
Connected Client 1	8100 through 8109
Unconnected Client 0	12800 through 12809

The content of each client’s status data area is structured in the same way. The following table describes the content of each register in the status data area.

Offset	Description
0	Number of Command Requests
1	Number of Command Responses
2	Number of Command Errors
3	Number of Requests
4	Number of Responses
5	Number of Errors Sent
6	Number of Errors Received
7	Reserved
8	Current Error Code
9	Last Error Code

EIP Client Command List Error Data

The PLX82-EIP-PNC stores a status/error code in upper memory for each command in each EIP client’s command list. The following table lists the addresses in upper memory where the gateway stores the command list error data for each EIP client.

EIP Client	Address Range
Connected client 0	7910 through 8009
Connected client 1	8110 through 8209
Unconnected client 0	12810 through 12909

The first word in each client’s command list error data area contains the status/error code for the first command in the client’s command list. Each successive word in the command error list is associated with the next command in the list. Therefore, the size of the command list error data area depends on the number of commands defined.

The structure of the command list error data area (which is the same for all clients) is displayed in the following table.

Offset	Description
0	Command #1 Error Code
1	Command #2 Error Code
2	Command #3 Error Code
3	Command #4 Error Code
4	Command #5 Error Code
.	.
.	.
.	.
97	Command #98 Error Code
98	Command #99 Error Code
99	Command #100 Error Code

9.3.10 EIP Error Codes

The gateway stores error codes returned from the command list process in the command list error memory region. A word is allocated for each command in the memory area. The error codes are formatted in the word as follows: The least-significant byte of the word contains the extended status code and the most-significant byte contains the status code.

Use the error codes returned for each command in the list to determine the success or failure of the command. If the command fails, use the error code to determine the cause of failure.

Warning: The gateway specific error codes (not EtherNet/IP/PCCC compliant) are returned from within the gateway and never returned from an attached EtherNet/IP/PCCC slave device. These are error codes that are part of the EtherNet/IP/PCCC protocol or are extended codes unique to the PLX82-EIP-PNC. The most common errors for the EtherNet/IP/PCCC protocol are shown in this section.

Local STS Error Codes

Code (Int)	Code (Hex)	Description
0	0x0000	Success, no error
256	0x0100	DST node is out of buffer space
512	0x0200	Cannot guarantee delivery (Link Layer)
768	0x0300	Duplicate token holder detected
1024	0x0400	Local port is disconnected
1280	0x0500	Application layer timed out waiting for response
1536	0x0600	Duplicate node detected
1792	0x0700	Station is offline
2048	0x0800	Hardware fault

Remote STS Error Codes

Code (Int)	Code (Hex)	Description
0	0x0000	Success, no error
4096	0x1000	Illegal command or format
8192	0x2000	Host has a problem and will not communicate
12288	0x3000	Remote node host is missing, disconnected or shut down
16384	0x4000	Host could not complete function due to hardware fault
20480	0x5000	Addressing problem or memory protect rungs
24576	0x6000	Function not allowed due to command protection selection
26872	0x7000	Processor is in Program mode
-32768	0x8000	Compatibility mode file missing or communication zone problem
-28672	0x9000	Remote node cannot buffer command
-24576	0xA000	Wait ACK (1775-KA buffer full)
-20480	0xB000	Remote node problem due to download
-16384	0xC000	Wait ACK (1775-KA buffer full)
-12288	0xD000	Not used
-8192	0xE000	Not used
	0xF0nn	Error code in the EXT STS byte (nn contains EXT error code)

EXT STS Error Codes

Code (Int)	Code (Hex)	Description
-4096	0xF000	Not used
-4095	0xF001	A field has an illegal value
-4094	0xF002	Fewer levels specified in address than minimum for any address
-4093	0xF003	More levels specified in address than system supports
-4092	0xF004	Symbol not found
-4091	0xF005	Symbol is of improper format
-4090	0xF006	Address does not point to something usable
-4089	0xF007	File is wrong size
-4088	0xF008	Cannot complete request
-4087	0xF009	Data or file is too large
-4086	0xF00A	Transaction size plus word address is too large
-4085	0xF00B	Access denied, improper privilege
-4084	0xF00C	Condition cannot be generated - resource is not available
-4083	0xF00D	Condition already exists - resource is already available
-4082	0xF00E	Command cannot be executed
-4081	0xF00F	Histogram overflow
-4080	0xF010	No access
-4079	0xF011	Illegal data type
-4078	0xF012	Invalid parameter or invalid data
-4077	0xF013	Address reference exists to deleted area
-4076	0xF014	Command execution failure for unknown reason
-4075	0xF015	Data conversion error
-4074	0xF016	Scanner not able to communicate with 1771 rack adapter
-4073	0xF017	Type mismatch
-4072	0xF018	1171 Gateway response was not valid
-4071	0xF019	Duplicate label
-4070	0xF01A	File is open; another node owns it
-4069	0xF01B	Another node is the program owner
-4068	0xF01C	Reserved
-4067	0xF01D	Reserved
-4066	0xF01E	Data table element protection violation
-4065	0xF01F	Temporary internal problem

EIP Error Codes

Code (Int)	Code (Hex)	Description
-1	0xFFFF	CTS modem control line not set before transmit
-2	0xFFFE	Timeout while transmitting message
-10	0xFFFF6	Timeout waiting for DLE-ACK after request
-11	0xFFFF5	Timeout waiting for response after request
-12	0xFFFF4	Reply data does not match requested byte count
-20	0xFFEC	DLE-NAK received after request
-21	0xFFEB	DLE-NAK sent after response
-200	0xFF38	DLE-NAK received after request

TCP/IP Interface Error Codes

Error (Int)	Error (Hex)	Description
-33	0xFFDF	Failed to connect to target
-34	0xFFDE	Failed to register session with target (timeout)
-35	0xFFDD	Failed forward open response timeout
-36	0xFFDC	PCCC/Tag command response timeout
-37	0xFFDB	No TCP/IP connection error

Common Response Error Codes

Error (Int)	Error (Hex)	Description
-40	0xFFD8	Invalid response length
-41	0xFFD7	CPF item count not correct
-42	0xFFD6	CPF address field error
-43	0xFFD5	CPF packet tag invalid
-44	0xFFD4	CPF bad command code
-45	0xFFD3	CPF status error reported
-46	0xFFD2	CPF incorrect connection ID value returned
-47	0xFFD1	Context field not matched
-48	0xFFD0	Incorrect session handle returned
-49	0xFFCF	CPF not correct message number

Register Session Response Error Codes

Error (Int)	Error (Hex)	Description
-50	0xFFCE	Message length received not valid
-51	0xFFCD	Status error reported
-52	0xFFCC	Invalid version

Forward Open Response Error Codes

Error (Int)	Error (Hex)	Description
-55	0xFFC9	Message length received not valid
-56	0xFFC8	Status error reported

PCCC Response Error Codes

Error (Int)	Error (Hex)	Description
-61	0xFFC3	Message length received not valid
-62	0xFFC2	Status error reported
-63	0xFFC1	CPF bad command code
-64	0xFFC0	TNS in PCCC message not matched
-65	0xFFBF	Vendor ID in PCCC message not matched
-66	0xFFBE	Serial number in PCCC message not matched

10 Reference

In This Chapter

- ❖ EtherNet/IP Explicit Messaging Server Command Support..... 143
- ❖ Accessing the PLX82-EIP-PNC Internal Memory..... 144
- ❖ Specifications 145

10.1 EtherNet/IP Explicit Messaging Server Command Support

The following commands are supported:

Basic Command Set Functions

Command	Function	Definition	Supported in Server
0x00	N/A	Protected Write	X
0x01	N/A	Unprotected Read	X
0x02	N/A	Protected Bit Write	X
0x05	N/A	Unprotected Bit Write	X
0x08	N/A	Unprotected Write	X

PLC-5 Command Set Functions

Command	Function	Definition	Supported in Server
0x0F	0x00	Word Range Write (Binary Address)	X
0x0F	0x01	Word Range Read (Binary Address)	X
0x0F		Typed Range Read (Binary Address)	X
0x0F		Typed Range Write (Binary Address)	X
0x0F	0x26	Read-Modify-Write (Binary Address)	
0x0F	0x00	Word Range Write (ASCII Address)	X
0x0F	0x01	Word Range Read (ASCII Address)	X
0x0F	0x26	Read-Modify-Write (ASCII Address)	

SLC 500 Command Set Functions

Command	Function	Definition	Supported in Server
0x0F	0xA1	Protected Typed Logical Read with Two Address Fields	X
0x0F	0xA2	Protected Typed Logical Read With Three Address Fields	X
0x0F	0xA9	Protected Typed Logical Write With Two Address Fields	X
0x0F	0xAA	Protected Typed Logical Write with Three Address Fields	X
0x0F	0xAB	Protected Typed Logical Write With Mask (Three Address Fields)	

10.2 Accessing the PLX82-EIP-PNC Internal Memory

The following tables define the relationships of the gateway's internal database to the addresses required in the MSG instructions:

Data Type	Controller Tag Name	Length of Each Element in CIP Message	Array Range for 4000 Element Database
BOOL	BOOLData[]	1	0 to 63999
Bit Array	BITData[]	4	0 to 1999
SINT	SINTData[]	1	0 to 7999
INT	INT_Date[]	2	0 to 3999
DINT	DINTData[]	4	0 to 1999
REAL	REALData[]	4	0 to 1999

10.2.1 MSG Instruction Type - CIP

Database Address	CIP Integer	CIP Boolean	CIP Bit Array	CIP Byte	CIP DINT	CIP Real
0	Int_data[0]	BoolData[0]	BitAData[0]	SIntData[0]	DIntData[0]	RealData[0]
999	Int_data[999]	BoolData[15984]		SIntData[1998]		
1000	Int_data[1000]	BoolData[16000]	BitAData[500]	SIntData[2000]	DIntData[500]	RealData[500]
1999	Int_data[1999]	BoolData[31984]		SIntData[3998]		
2000	Int_data[2000]	BoolData[32000]	BitAData[1000]	SIntData[4000]	DIntData[1000]	RealData[1000]
2999	Int_data[2999]	BoolData[47984]		SIntData[5998]		
3000	Int_data[3000]	BoolData[48000]	BitAData[1500]	SIntData[6000]	DIntData[1500]	RealData[1500]
3999	Int_data[3999]	BoolData[63999]		SIntData[9998]		

10.2.2 MSG Instruction Type - PCCC

Database Address	File size 100	Database Address	File size 100
0	N10:0	0	N10:0
999	N19:99	999	N19:99
1000	N20:0	1000	N20:0
1999	N29:99	1999	N29:99
2000	N30:0	2000	N30:0

10.3 Specifications

10.3.1 Hardware Specifications

Specification	Description
Power supply	24 Vdc nominal 10 Vdc to 36 Vdc allowed Positive, Negative, GND terminals
Current load	24 Vdc nominal @ 400 mA 10 to 36 Vdc @ 610 mA maximum
Operating temperature	0°C to 50°C (32°F to 122°F)
Storage temperature	-10°C to 70°C (-14°F to 158°F)
Relative humidity	5% to 95% RH with no condensation
Shock	IEC60068-2-27; 15G @ 11ms, 3-axis (Operational) IEC60068-2-27; 30G @ 18ms, 3-axis (Non-operational)
Vibration	IEC 60068-2-27; 5G @ 10 Hz to 150 Hz
Dimensions (H x W x D)	5.52 x 2.06 x 4.37 in 14.01 x 5.24 x 11.09 cm
LED indicators	Configuration (CFG) and Error (ERR) status Power (PWR) and Hardware Fault (FLT) Network Status (NS) EtherNet/IP™ Class I or Class III Connection Status (EtherNet/IP only) Module Status (MS) Module Configuration Status (EtherNet/IP only) Ethernet communication port Link/Activity and 100mbit PROFINET - SYS, SF, BF
Ethernet Port	10/100Mbit RJ45 connector Electrical isolation 1500 Drams at 50 Hz to 60 Hz for 60 seconds, applied as specified in section 5.3.2 of IEEE 60950: 1991 Ethernet Broadcast Storm Resiliency = less than or equal to 5000 [ARM] frames-per-second and less than or equal to 5 minutes duration
Shipped with unit	2.5 mm screwdriver, J180 power connector, 5 foot straight- through Ethernet cable

10.3.2 EtherNet/IP (EIP) Specifications

The EIP server is an ODVA-certified EtherNet/IP implementation.

Specification	Description
Number of Class 3 server connections	5
Supported PLC types	PLC2, PLC5, SLC, CLX, CMLX
Class 3 Client connections	Connected - 2 Unconnected - 1
Number of Class 1 I/O connections	8
I/O connection sizes	248/248
Max RPI time	2 ms (1 connection) 8 ms (8 connections)
CIP services supported	0x4C - CIP Data Table Read 0x4D - CIP Data Table Write
Command List	Support for 100 commands per client, each configurable for command type, IP address, register to/from addressing, and word/bit count.
Command Sets	PLC-2/PLC-3/PLC5 Basic Command Set PLC-5 Binary Command Set SLC 500 Command Set

10.3.3 PROFINET (PNC) Specifications

Specification	Description
Driver Type	Class 1 RTC, Class 1 RTA
PROFINET I/O Data	3840 bytes IN, 3840 bytes OUT
Exchange Types	Cyclic Real Time (RT) and Acyclic Data
PROFINET Devices	Max: 36 Max data per device: 2440 bytes IN/OUT

11 Support, Service & Warranty

In This Chapter

❖ Contacting Technical Support	147
❖ Warranty Information	148

11.1 Contacting Technical Support

ProSoft Technology, Inc. is committed to providing the most efficient and effective support possible. Before calling, please gather the following information to assist in expediting this process:

- 1 Product Version Number
- 2 System architecture
- 3 Network details

If the issue is hardware related, we will also need information regarding:

- 1 Module configuration and associated ladder files, if any
- 2 Module operation and any unusual behavior
- 3 Configuration/Debug status information
- 4 LED patterns
- 5 Details about the serial, Ethernet or Fieldbus devices interfaced to the module, if any.

Note: For technical support calls within the United States, ProSoft's 24/7 after-hours phone support is available for urgent plant-down issues. Detailed contact information for all our worldwide locations is available on the following page.

Internet	Website: www.prosoft-technology.com E-mail address: support@prosoft-technology.com
Asia Pacific (location in Malaysia)	Tel: +603.7724.2080 E-mail: asiapc@prosoft-technology.com Languages spoken include: Chinese, English
Asia Pacific (location in China)	Tel: +86.21.5187.7337 x888 E-mail: asiapc@prosoft-technology.com Languages spoken include: Chinese, English
Europe (location in Toulouse, France)	Tel: +33 (0) 5.34.36.87.20 E-mail: support.EMEA@prosoft-technology.com Languages spoken include: French, English
Europe (location in Dubai, UAE)	Tel: +971-4-214-6911 E-mail: mea@prosoft-technology.com Languages spoken include: English, Hindi
North America (location in California)	Tel: +1.661.716.5100 E-mail: support@prosoft-technology.com Languages spoken include: English, Spanish
Latin America (Oficina Regional)	Tel: +1-281-2989109 E-Mail: latinam@prosoft-technology.com Languages spoken include: Spanish, English
Latin America (location in Puebla, Mexico)	Tel: +52-222-3-99-6565 E-mail: soporte@prosoft-technology.com Languages spoken include: Spanish
Brasil (location in Sao Paulo)	Tel: +55-11-5083-3776 E-mail: brasil@prosoft-technology.com Languages spoken include: Portuguese, English

11.2 Warranty Information

For complete details regarding ProSoft Technology's TERMS & CONDITIONS OF SALE, WARRANTY, SUPPORT, SERVICE AND RETURN MATERIAL AUTHORIZATION INSTRUCTIONS, please see the documents at:
www.prosoft-technology.com/legal

Documentation is subject to change without notice.

Index

A

Accessing the PLX-EIP-PNC Internal Memory • 144
Acyclic Data • 83
Acyclic Read/Write Communication Status • 103
Acyclic Read/Write PNIO Remote Procedure Call
Status • 104
Adding a Slave Device to the Project • 56
Adding an Ethernet Bridge • 30, 31
Adding the PLX-EIP-PNC • 33
Address Table • 65

C

Class 3 Client/UClient [x] Commands Basic • 48
Class 3 Client/UClient [x] Commands Controller Tag
Access • 47
Class 3 Client/UClient [x] Commands PLC5 ASCII • 46
Class 3 Client/UClient [x] Commands PLC5 Binary • 45
Class 3 Client/UClient [x] Commands SLC500 2
Address Fields • 43
Class 3 Client/UClient [x] Commands SLC500 3
Address Fields • 44
Common Response Error Codes • 140
CommonNet Data Map • 87
Configuring a Slave Device • 57
Configuring the EIP Processor Path • 49
Configuring the EtherNet/IP Driver • 29
Configuring the PROFINET Controller • 51
Connecting Power • 13
Contacting Technical Support • 147
Content Disclaimer • 2
Controller Network Settings • 60
Controller Settings • 70
Creating a New Project • 16
Creating New, or Using Existing Configuration
Information • 75
CSV Export • 66

D

Device Info • 78
Device Table • 61
Diagnostics and Troubleshooting • 91
Downloading the Configuration File to the PLX82-EIP-
PNC • 24
Downloading the RSLogix 5000 Project to the
Processor • 38

E

EIP Class 1 Connection • 40
EIP Class 3 Client/UClient [x] • 41
EIP Class 3 Client/UClient [x] Commands • 42

EIP Class 3 Client/UClient [x] Connection • 41
EIP Class 3 Server Connection • 39
EIP Client Command List Error Data • 136
EIP Client Status Data • 135
EIP Error Codes • 137, 140
EIP Server Status Data • 135
EIP Status Data in Upper Memory • 135
Establishing a Diagnostic Connection • 110
Ethernet Configuration • 22
Ethernet Devices • 72
EtherNet/IP (EIP) Specifications • 146
EtherNet/IP Explicit Messaging Server Command
Support • 143
Exporting a Project • 26
EXT STS Error Codes • 139
Extended Diagnosis • 117

F

Firmware Diagnosis • 116
Forward Open Response Error Codes • 141
FSU-/Port-Settings • 68

G

General Diagnosis • 113
General Diagnosis Information • 119
General Specifications - Modbus TCP/IP • 146

H

Hardware Specifications • 145
How to Contact Us • 2

I

Important Safety Information • 3
Importing GSD Files • 54
Importing the Ladder Rung • 36
IO Monitor • 132
IP Address Table • 63
IP Information • 123
IP Packet Counter • 123

L

LEDs • 92
Local STS Error Codes • 138

M

Manual Address Update • 66
Master Diagnosis • 114
Module Info • 80
Mounting the Gateway on a DIN-rail • 12
Mounting the PLX-EIP-PNC on a DIN-rail • 12
MSG Instruction Type - CIP • 144
MSG Instruction Type - PCCC • 145

N

Network Diagnostics • 106

P

Packet Monitor • 126
PCB Diagnostics • 94
PCB Diagnostics Menu Options • 96
PCCC Response Error Codes • 141
PLX82-EIP-PNC Overview • 9
PNIO_DCP Extending Diagnosis Information • 121
Process Data • 64
Process Image Monitor • 133
PROFINET (PNC) Specifications • 146
PROFINET Device Errors • 103
PROFINET General Status Codes • 102
PROFINET Start Input and Output Byte Offsets • 81
ProSoft Configuration Builder Software • 15

R

Reference • 143
Register Session Response Error Codes • 141
Remote STS Error Codes • 138
RSLogix 5000 • 30
RX_SYSTEM > Task Information • 118

S

Saving the Project • 23
Setting a Project Name • 18
Setting a Temporary IP Address • 19
Setting Jumpers • 12
Shipping Contents • 11
Specifications • 145
Specifications - Ethernet/IP • 146
Start Here • 9
Station Diagnosis • 115
Stations Timing • 69
Support, Service & Warranty • 147
System Requirements • 11

T

T_PNIO_ACP Extended Diagnosis Information • 121
T_PNIO_APCFG • 126
T_PNIO_APCTL • 125
T_PNIO_CMCTL • 125
T_PNIO_EDD Extended Diagnosis Information • 119
T_PNIO_MGT Extended Diagnosis Information • 122
T_RPC • 124
TCP/IP Interface Error Codes • 140
TCP_UDP • 123
TCP_UDP Information • 124
Tools • 126

U

Uploading a Configuration from the PLX82-EIP-PNC • 25
Use Configuration of... • 77

V

Verifying Slave Device Information • 59
Viewing Alarm Information • 134

Viewing Configured Device Information • 78

W

Warranty Information • 148
Webpage • 89
Writing the Project to Compact Flash • 27

X

XMAC Diagnosis Structure • 120

Y

Your Feedback Please • 2