

Connector PowerTOP® - Part no. 3859

- screw terminals
- with highly heat resistant contact carrier
- cable gland and external cable grip

Protection type	IP 67
Ampere	16A
Poles	3p
Voltage	110V
Hertz	50-60 Hz
Earth position	4h
Contact	nickel plated contacts, highly heat resistant contact carrier
Connection technology	Screw terminals

Std. Pack. 10 Qty.

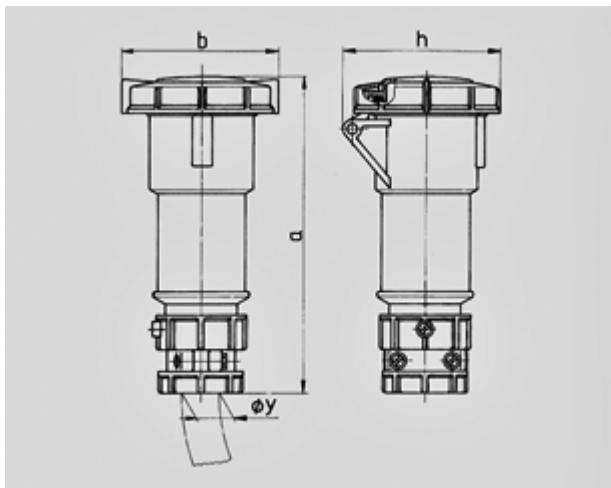

Drawing	Amp.	16			32		
		3	4	5	3	4	5
3 MB 48/3	Poles						
Dim. in mm	a	171	182	194	217	217	229
	b	78	85	96	103	103	110
	h	79	88	95	99	99	105
	y	19	19	22	24,5	24,5	28,5
Terminal for cond. cross		1	1	1	2,5	2,5	2,5
section (mm ²) min.-max.		-2,5	-2,5	-2,5	-6	-6	-6