

OMNIMATE Signal - series BL/SL 3.50 SL 3.50/04/180G 3.2SN OR BX

Weidmüller Interface GmbH & Co. KG
Klingenbergstraße 16
D-32758 Detmold
Germany
Fon: +49 5231 14-0
Fax: +49 5231 14-292083
www.weidmueller.com

Product image

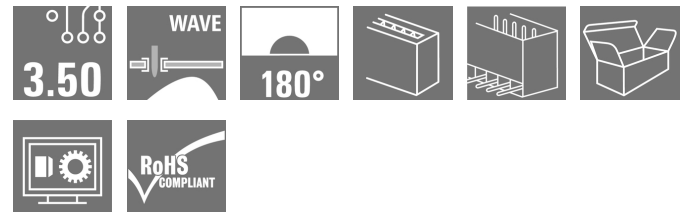
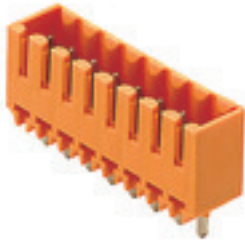

Similar to illustration

Pin headers for wave soldering in 3.50 mm pitch

- Plugging direction is parallel (90°), straight 180° or angled (135°) to the PCB
- Housing variant: screw flange (F)
- Packed in a cardboard box (BX)
- Pin header can be coded

General ordering data

| | |
|--------------|--|
| Type | SL 3.50/04/180G 3.2SN OR BX |
| Order No. | 1604490000 |
| Version | PCB plug-in connector, male header, closed side, THT solder connection, 3.50 mm, No. of poles: 4, 180°, Solder pin length (l): 3.2 mm, tinned, orange, Box |
| GTIN (EAN) | 4008190115852 |
| Qty. | 100 pc(s). |
| Product data | IEC: 320 V / 17 A UL: 300 V / 10 A |
| Packaging | Box |

**OMNIMATE Signal - series BL/SL 3.50
SL 3.50/04/180G 3.2SN OR BX**

Weidmüller Interface GmbH & Co. KG
Klingenbergstraße 16
D-32758 Detmold
Germany
Fon: +49 5231 14-0
Fax: +49 5231 14-292083
www.weidmueller.com

Technical data**Dimensions and weights**

| | | | |
|--------------------------|------------|-----------------|------------|
| Width | 15.4 mm | Width (inches) | 0.606 inch |
| Height | 14.3 mm | Height (inches) | 0.563 inch |
| Height of lowest version | 11.1 mm | Depth | 7.5 mm |
| Depth (inches) | 0.295 inch | Net weight | 1.052 g |

System specifications

| Product family | OMNIMATE Signal - series BL/SL 3.50 | Type of connection | Board connection |
|--|-------------------------------------|--|------------------------------|
| Mounting onto the PCB | THT solder connection | Pitch in mm (P) | 3.5 mm |
| Pitch in inches (P) | 0.138 inch | Outgoing elbow | 180° |
| No. of poles | 4 | Number of solder pins per pole | 1 |
| Solder pin length (l) | 3.2 mm | Solder pin length tolerance | +0.1 / -0.3 mm |
| Tolerance of solder pin position | ± 0.1 mm | Solder pin dimensions | d = 1.2 mm, Octagonal |
| Solder pin dimensions = d tolerance | 0 / -0.03 mm | Solder eyelet hole diameter (D) | 1.4 mm |
| Solder eyelet hole diameter tolerance (D)+ | 0,1 mm | L1 in mm | 10.5 mm |
| L1 in inches | 0.413 inch | Number of rows | 1 |
| Pin series quantity | 1 | Touch-safe protection acc. to DIN VDE 57 106 | Safe from back-of-hand touch |
| Touch-safe protection acc. to DIN VDE 0470 | IP 10 | Volume resistance | 6.00 mΩ |
| Can be coded | Yes | Plugging cycles | 25 |
| Plugging force/pole, max. | 10 N | Pulling force/pole, max. | 10 N |

Material data

| | | | |
|---------------------------------------|-------------------------|---------------------------------------|---------------------|
| Insulating material | PBT | Colour code | orange |
| Colour chart (similar) | RAL 2000 | Insulating material group | IIIa |
| CTI | ≥ 200 | Insulation strength | ≥ 10 ⁸ Ω |
| UL 94 flammability rating | V-0 | Contact material | CuSn |
| Contact surface | tinned | Layer structure of solder connection | 5-7 μm Sn glossy |
| Layer structure of plug contact | 5-7 undefined Sn glossy | Storage temperature, min. | -25 °C |
| Storage temperature, max. | 55 °C | Max. relative humidity during storage | 80 % |
| Operating temperature, min. | -50 °C | Operating temperature, max. | 100 °C |
| Temperature range, installation, min. | -30 °C | Temperature range, installation, max. | 100 °C |

Rated data acc. to IEC

| | | | |
|---|------------------------|---|-------------------|
| tested acc. to standard | IEC 60664-1, IEC 61984 | Rated current, min. no. of poles (Tu=20°C) | 17 A |
| Rated current, max. no. of poles (Tu=20°C) | 12 A | Rated current, min. no. of poles (Tu=40°C) | 14.5 A |
| Rated current, max. no. of poles (Tu=40°C) | 10 A | Rated voltage for surge voltage class / pollution degree II/2 | 320 V |
| Rated voltage for surge voltage class / pollution degree III/2 | 160 V | Rated voltage for surge voltage class / pollution degree III/3 | 160 V |
| Rated impulse voltage for surge voltage class/ pollution degree II/2 | 2.5 kV | Rated impulse voltage for surge voltage class/ pollution degree III/2 | 2.5 kV |
| Rated impulse voltage for surge voltage class/ contamination degree III/3 | 2.5 kV | Short-time withstand current resistance | 3 x 1s with 100 A |

Data sheet

**OMNIMATE Signal - series BL/SL 3.50
SL 3.50/04/180G 3.2SN OR BX**

Weidmüller Interface GmbH & Co. KG
Klingenbergstraße 16
D-32758 Detmold
Germany
Fon: +49 5231 14-0
Fax: +49 5231 14-292083
www.weidmueller.com

Technical data

Rated data acc. to CSA

| | | | |
|-----------------------------------|---|-----------------------------------|----------------|
| Institute (CSA) |  | Certificate No. (CSA) | 154685-1318353 |
| Rated voltage (Use group B / CSA) | 300 V | Rated voltage (Use group D / CSA) | 300 V |
| Rated current (Use group B / CSA) | 10 A | Rated current (Use group D / CSA) | 10 A |
| Reference to approval values | Specifications are maximum values, details - see approval certificate. | | |

Rated data acc. to UL 1059

| | | | |
|---------------------------------------|---|---------------------------------------|--------|
| Institute (UR) |  | Certificate No. (UR) | E60693 |
| Rated voltage (Use group B / UL 1059) | 300 V | Rated voltage (Use group D / UL 1059) | 300 V |
| Rated current (Use group B / UL 1059) | 10 A | Rated current (Use group D / UL 1059) | 10 A |
| Reference to approval values | Specifications are maximum values, details - see approval certificate. | | |

Packaging

| | | | |
|-----------|-------|------------|--------|
| Packaging | Box | VPE length | 39 mm |
| VPE width | 91 mm | VPE height | 101 mm |

Classifications

| | | | |
|------------|-------------|------------|-------------|
| ETIM 3.0 | EC001284 | ETIM 4.0 | EC002637 |
| ETIM 5.0 | EC002637 | ETIM 6.0 | EC002637 |
| UNSPSC | 30-21-18-10 | eClass 5.1 | 27-26-07-04 |
| eClass 6.2 | 27-26-07-04 | eClass 7.1 | 27-44-04-02 |
| eClass 8.1 | 27-44-04-02 | eClass 9.0 | 27-44-04-02 |
| eClass 9.1 | 27-44-04-02 | | |

Notes

| | |
|----------------|--|
| Notes | <ul style="list-style-type: none"> • Additional colours on request • Gold-plated contact surfaces on request • Rated current related to rated cross-section & min. No. of poles. • P on drawing = pitch • Rated data refer only to the component itself. Clearance and creepage distances to other components are to be designed in accordance with the relevant application standards. |
| IPC conformity | Conformity: The products are developed, manufactured and delivered according international recognized standards and norms and comply with the assured properties in the data sheet resp. fulfill decorative properties in accordance with IPC-A-610 "Class 2". Further claims on the products can be evaluated on request. |

Data sheet

**OMNIMATE Signal - series BL/SL 3.50
SL 3.50/04/180G 3.2SN OR BX**

Weidmüller Interface GmbH & Co. KG
Klingenbergstraße 16
D-32758 Detmold
Germany
Fon: +49 5231 14-0
Fax: +49 5231 14-292083
www.weidmueller.com

Technical data

Approvals

Approvals



ROHS

Conform

Downloads

Approval/Certificate/Document of
Conformity

[Declaration of the Manufacturer](#)

Brochure/Catalogue

- [FL DRIVES EN](#)
- [MB DEVICE MANUF. EN](#)
- [FL DRIVES DE](#)
- [CAT 2 PORTFOLIOGUIDE EN](#)
- [FL BUILDING SAFETY EN](#)
- [FL APPL LED LIGHTING EN](#)
- [FLIndustr.CONTROLS EN](#)
- [FL MACHINE SAFETY EN](#)
- [FL HEATING ELECTR EN](#)
- [FL APPL INVERTER EN](#)
- [FL_BASE_STATION_EN](#)
- [FL ELEVATOR EN](#)
- [FL POWER SUPPLY EN](#)
- [FL 72H SAMPLE SER EN](#)
- [PO OMNIMATE EN](#)

Engineering Data

[EPLAN, WSCAD, Zuken E3.S](#)

Engineering Data

[SL.zip](#)
[STEP](#)

**OMNIMATE Signal - series BL/SL 3.50
SL 3.50/04/180G 3.2SN OR BX**

Weidmüller Interface GmbH & Co. KG
 Klingenbergstraße 16
 D-32758 Detmold
 Germany
 Fon: +49 5231 14-0
 Fax: +49 5231 14-292083
 www.weidmueller.com

Drawings

Dimensional drawing

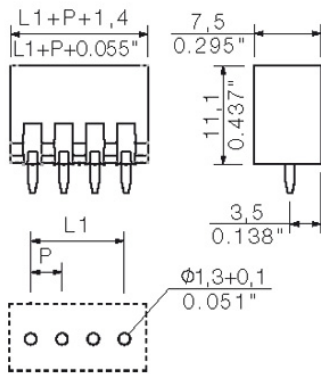

The reproduction, distribution and utilization of this document as well as the communication of its contents without explicit authorization is prohibited. Offenders will be held liable for the payment of damages. Weidmueller exclusively reserves the right to file for patents, utility models or designs.

© Weidmueller Interface GmbH & Co. KG

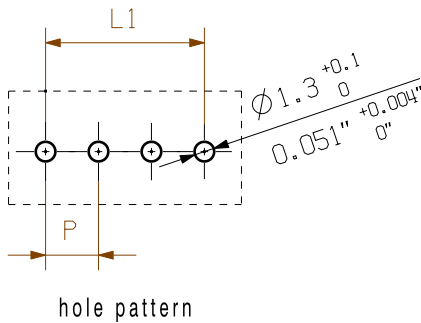
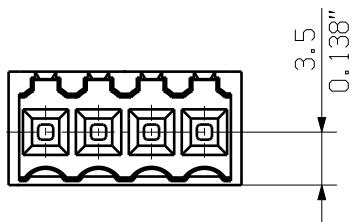
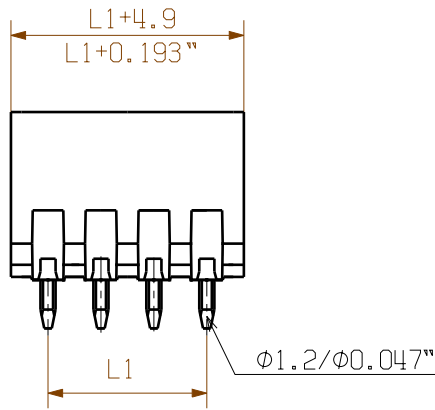

| | | | | |
|----|-------------|---------|-----------|---------------------|
| 24 | 80.5 | 3.171 | ±0.2 | |
| 23 | 77.0 | 3.033 | | |
| 22 | 73.5 | 2.895 | | |
| 21 | 70.0 | 2.757 | | |
| 20 | 66.5 | 2.619 | | |
| 19 | 63.0 | 2.481 | | |
| 18 | 59.5 | 2.343 | | |
| 17 | 56.0 | 2.205 | | |
| 16 | 52.5 | 2.067 | ±0.15 | |
| 15 | 49.0 | 1.929 | | |
| 14 | 45.5 | 1.791 | | |
| 13 | 42.0 | 1.654 | | |
| 12 | 38.5 | 1.516 | ±0.1 | |
| 11 | 35.0 | 1.378 | | |
| 10 | 31.5 | 1.240 | | |
| 9 | 28.0 | 1.102 | | |
| 8 | 24.5 | 0.965 | | |
| 7 | 21.0 | 0.827 | | |
| 6 | 17.5 | 0.689 | | |
| 5 | 14.0 | 0.551 | | |
| 4 | 10.5 | 0.413 | | |
| 3 | 7.00 | 0.276 | | |
| 2 | 3.50 | 0.138 | | |
| n | no of poles | L1 [mm] | L1 [inch] | Toleranz/ tolerance |

For the mounting of PCBs, it should be noted that the rated data given in the catalogue relates only to the connection elements. The necessary creepage and clearance paths must be observed in connection with the respective applicant in accordance with VDE 0110. The current-carrying capacity and pitch tolerance is to be determined according to DIN IEC 326 part 3 very fine.

Weidmueller connectors are tested to the DIN VDE 0627 standard, and are valid for its field of application. Provided that the connectors are used to the intended purpose, all requirements with respect to the occurring of electrical, mechanical, thermic and corrosive stress will be satisfied.

P = Raster / pitch
shown: SL 3.50/04/180G

General tolerance:
DIN ISO 2768-mK



90310/5
30.09.16 HELIS_MA 00

Modification

Weidmüller

Cat.no.:
4 19672 28

Drawing no. Issue no.
Sheet 02 of 03 sheets



Date Name

Drawn 04.09.2008 HELIS_MA

Responsible AMANN_A

Checked 18.10.2016 HELIS_MA

Approved LANG_T

SL 3.50/.. /180...
STIFTLISTE
MALE HEADER

Scale: 5:1

Supersedes: .

Product file: SL 3.50

7296

Recommended wave soldering profiles

Weidmüller Interface GmbH & Co. KG
 Klingenbergstraße 16
 D-32758 Detmold
 Germany
 Fon: +49 5231 14-0
 Fax: +49 5231 14-292083
 www.weidmueller.com

Single Wave:



Double Wave:



Wave soldering profiles

Wired connection elements should be processed in accordance with the DIN EN 61760-1 standard. We have included two recommendations for practical wave soldering profiles, with which Weidmüller PCB terminals and connectors are qualified.

When choosing a suitable profile for your application, the following factors also need to be considered:

- PCB thickness
- Proportion of Cu in the layers
- Single/double-sided assembly
- Product range
- Heating and cooling rates

The single and double wave profiles each indicate the recommended operating range, including the maximum soldering temperature of 260°C. In practice, the maximum soldering temperature is quite often well below the above maximum profile.