

FREQUENTLY ASKED QUESTIONS

Q: How do I know if the PESD is working?

A: Once PESDs are installed and verified by a qualified electrician and documented in the drawings and safety procedures, a task qualified person can identify the status of the device functionality from outside the cabinet. For example, if ANY of the LEDs are "ON" in a voltage indicator after throwing the disconnect switch to "OFF" this triggers additional tests and verification of the deenergized state by a qualified electrician.

Q: What is CAT III & CAT IV rating and why is it important for PESDs?

A: The CAT III & IV ratings defines the overvoltage installation categories that applies to low voltage systems of <1000Volts measuring and test equipment as defined in IEC 1010 and UL61010-1 standards. The rating of our voltage indicators allows their use as permanently mounted test equipment used in fixed installations such as switchgear, MCCs, bus and feeder in industrial plants and low voltage connections made to utility power.

Q: Do the R-3W series voltage indicators have internal short circuit protection?

A: Yes, the voltage indicator is protected by high impedance circuitry and recognized components that limit the power to 1.2watts @ 750 Volts AC. The following chart gives the phase to ground short circuit currents.

Voltage Indicator included Fault Current (PHASE-TO-GROUND SHORT)					
3- Phase Line-To-Line (VAC)	30	120	240	480	750
0 OHM Phase-To-Ground Current (µA)	28	108	219	455	730

Q: Do PESDs satisfy the NEC feeder tap rule?

A: Yes, the PESDs have a built-in high impedance between the feeder line connecting leads and the circuitry, hence it satisfies the NEC 10ft feeder tap rule without overcurrent protection.

Q: Why are the GND LEDs "ON" in my delta connected system with isolated ground?

A: On a balanced 3 Phase, Delta Configuration, the GND light will be off. If it is on, it is either because of an unbalanced system or voltage on the GND. Test the system to ensure balance, as little as 11% voltage imbalance will start to turn on the LEDs and will be fully illuminated by 15%. (Percentage is calculated by $(AV-UV)/AV$ where AV=Average Voltage and UV=Unbalanced Voltage. Check to ensure no voltage on ground. At as little as 15V, the GND lights will start to come on.)

Q: Do I need over current protection fuses with my voltage indicator?

A: Most voltage indicators installed are not fused because it created additional failure points. Some codes or company regulations will require fusing and the indicators will function without any problem.

Q: Do PESDs have an output relay to connect to my PLC or an alarm circuit?

A: No, PESDs do not have an output relay or auxiliary contacts. These devices are meant for verifying the presence and absence of voltage at the connected source only.

Q: Where should I use R-3F2 fiber optic voltage indicators?

A: Fiber optic voltage indicators are ideal for use in the dead front electrical cabinets where voltage in excess of 24 Volts is not allowed on to the door.

VOLTAGE INDICATORS

Illuminate whenever hazardous voltage is present in any individual phase



VOLTAGE INDICATOR FEATURES

- ▶ **Grace Voltage Indicators** are Permanent Electrical Safety Devices (PESDs) that visually represent presence of voltage with flashing or non-flashing redundant LED lights.
- ▶ Typically hardwired to the load side of disconnect, **Voltage Indicators** illuminate whenever hazardous voltage is present in any individual phase.
- ▶ **R-3W Series Voltage Indicators** are suitable for both AC and DC applications from 40-600VAC and 30-1000VDC is a one-size fits-all solution that detects 3-phase AC/DC voltage from 40-600VAC or 30-1000VDC
- ▶ Safely and productively validates zero energy presence and enhances compliance to OSHA & NFPA 70E/CSAZ462, when installed and verified by a qualified electrician and incorporated into the facility's electrical safety procedure.



OPERATION

Grace Voltage Indicators are self powered, UL listed, and permanently installed devices that visually represent presence of voltage with flashing or non-flashing, redundant LED lights. Typically hardwired to the load side of an electrical feeder or a disconnect switch, voltage indicators illuminate whenever hazardous voltage is present in any individual phase. Voltage indicators greatly assist task qualified personnel with enhanced productivity and reduced risk while performing mechanical and electrical LOTO tasks by verifying the release of stored electrical energy per Article 120.5(4) of NFPA 70E 2018

TECHNICAL SPECIFICATIONS

COMPONENT CODE	CAT III & IV RATED					R-3D2
	R-3W	R-3W-SR	R-3W2	R-3F2	R-3W-DC	
Voltage Indicator	Flashing LEDs	Non-Flashing LEDs	Flashing LEDs			Flashing/ Non-Flashing LEDs
Voltage Type	AC/DC				DC	AC/DC
Mounting Location	External (Door/Flange mounted)					External (Conduit Knockout)
Voltage to Door Required	Yes		No		Yes	
Lead Connections	3 Phase, 4 Wire				1 or 3 Phase, 3 Wire	3 Phase, 4 and 5 wire
Storage Temperature Range	-45°C to + 85°C				-45°C to +55°C	-45°C to + 85°C
Operational Temperature Range	-20°C to +55°C				-40°C to +55°C	-20°C to +55°C
Operational Voltage Range	40 - 600 VAC 50/60/400Hz, 30 - 1000VDC	35 - 600 VAC 50/60/400Hz, 30 - 1000VDC	40 - 600 VAC 50/60/400Hz, 30 - 1000VDC	20 - 600 VAC 50/60/400Hz, 20 - 1000VDC	20 - 600 VAC 50/60/400Hz, 15 - 1000VDC	20 - 600 VAC 50/60/400Hz, 15 - 1000VDC
Wiring Specifications	PVC Insulated with Nylon Jacket, 6ft, 18 AWG, 90°C @ 1000 Volts, UL-1452			PVC Insulated with nylon jacket, 8ft, 18 AWG 90°C @ 1000V, UL-1452	PVC Insulated with nylon jacket, (3) 8ft, 18 AWG 90°C @ 1000V, UL-1452	PVC Insulated with Nylon Jacket, 3ft, 12 AWG, 90°C @ 1000 Volts, UL-1452
Fiber Optic Length	N/A		Available in: 12", 24", 36", 48", and 72"		N/A	N/A
Installation	30mm Pushbutton Hole					3/4" or M20 conduit knockout
Certifications	cUL Listed (#E56847) Type 4, 4X, 12, 13		cUL Listed (#E334957) Type 4X, 12, 13 Class 1 Div 2 Group A, B, C & D, IP67, CE	cUL Listed (#E256847) Type 4, 4X, 12, 13 IP67	cUL Listed (#E56847) Type 4, 4X, 12, 13 Class 1 Div 2 Group A, B, C, & D, IP67, CE	cUL Listed (#E334957) Type 4X, 12, 13 CAT III, IV, Class 1 Div 2, IP67, CE

COMBINATION UNITS

Grace PESD® Combination Units take our voltage indicator and portal PESDs and couple them together with our custom labels. With SafeSide® Voltage indicator and portal connected to the same source, a task qualified worker or a qualified electrician can perform both presence and absence of voltage tests by using either a Non-Contact Voltage Detector (NCVD) pen or an adequately rated portable test instrument. Combination Units are available to order with custom procedure labels and NCVD pens.



LABELS



*These labels install around the R-3W Series Voltage Indicators. The labels are not UL approved.

Custom label variations available upon request. Please call 1-800-280-9517 for more information.

ACCESSORIES

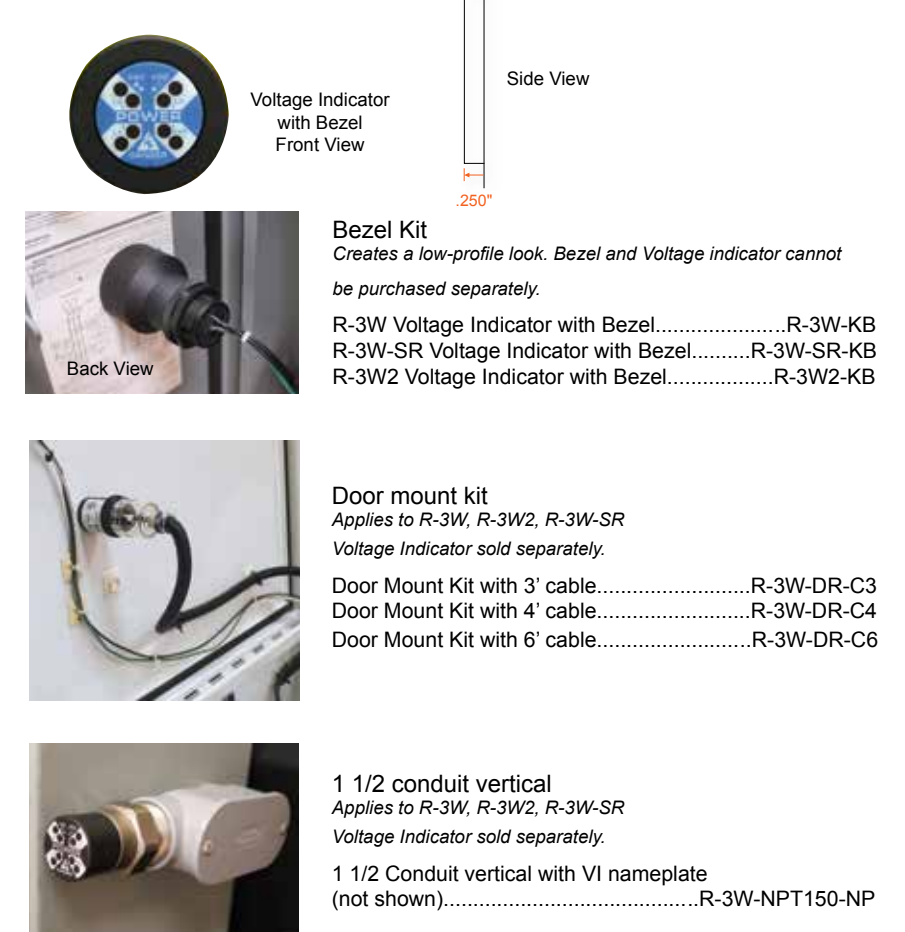

Bezel Kit
Creates a low-profile look. Bezel and Voltage indicator cannot be purchased separately.
R-3W Voltage Indicator with Bezel.....R-3W-KB
R-3W-SR Voltage Indicator with Bezel.....R-3W-SR-KB
R-3W2 Voltage Indicator with Bezel.....R-3W2-KB

Door mount kit
Applies to R-3W, R-3W2, R-3W-SR
Voltage Indicator sold separately.
Door Mount Kit with 3' cable.....R-3W-DR-C3
Door Mount Kit with 4' cable.....R-3W-DR-C4
Door Mount Kit with 6' cable.....R-3W-DR-C6

1 1/2 conduit vertical
Applies to R-3W, R-3W2, R-3W-SR
Voltage Indicator sold separately.
1 1/2 Conduit vertical with VI nameplate (not shown).....R-3W-NPT150-NP

FOR MORE INFORMATION VISIT PESD.COM OR CALL 1.800.280.9517

Warning: Verify an electrical conductor has been de-energized using an adequately rated test instrument before working on it. Follow appropriate Energy Control (Lockout/Tagout) procedures as per OSHA Subpart S.

© Grace Engineered Products, Inc. All rights reserved. Specifications are subject to change with/without notice.

R-3W SERIES DOOR CUTOUT FOR MOUNTING

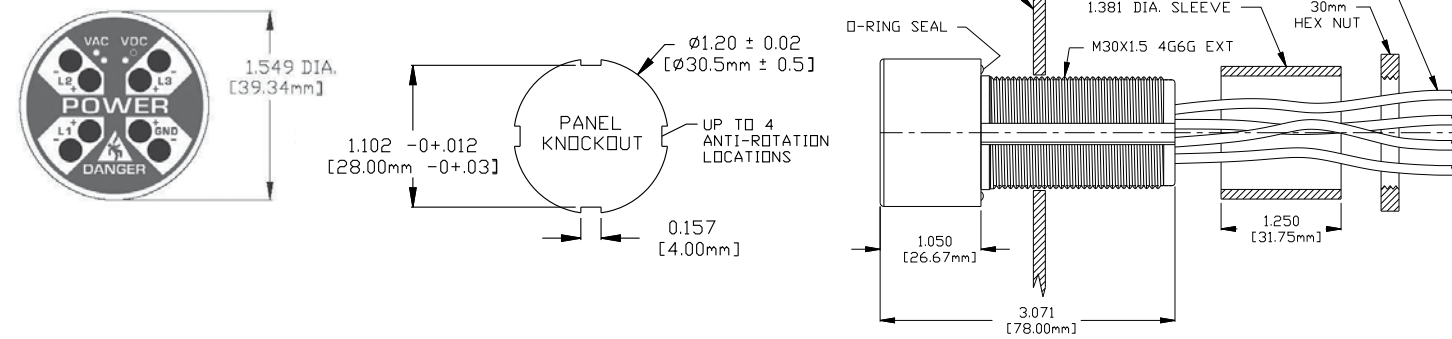

R-3W SERIES WIRING CONFIGURATIONS

AC APPLICATIONS

THREE PHASE DELTA, 3W + GND

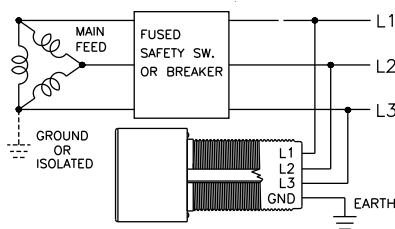

UNGROUNDED OR HIGH RESISTANCE GROUND WYE

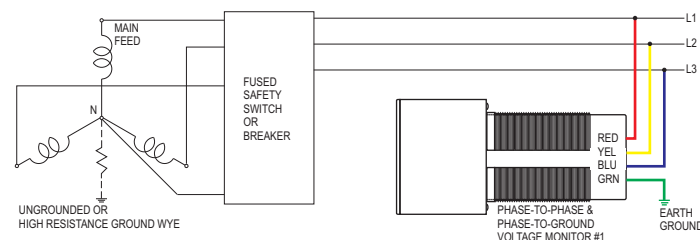

SINGLE PHASE, 3W + GND

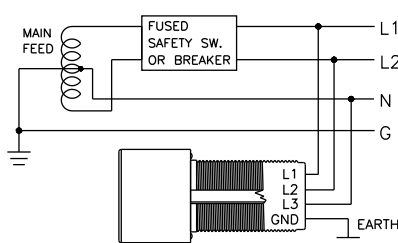

(L1-L3, GND) See Wire Identification Diagram

WIRE IDENTIFICATION

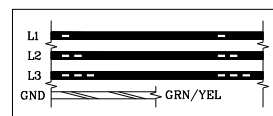

Applies to R-3W2 and R-3F2

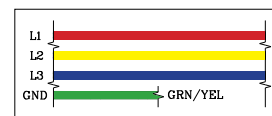

Applies to R-3W and R-3W-SR

Looking for a 5-wire option? Refer to the Flex-Mount Voltage Indicator datasheet for more information.

FOR MORE INFORMATION VISIT PESD.COM OR CALL 1.800.280.9517

Warning: Verify an electrical conductor has been de-energized using an adequately rated test instrument before working on it. Follow appropriate Energy Control (Lockout/Tagout) procedures as per OSHA Subpart S.

© Grace Engineered Products, Inc. All rights reserved. Specifications are subject to change with/without notice.



R-3W-DC WIRING CONFIGURATIONS

DC APPLICATIONS

DC SINGLE SOURCE, 2W + GND SAFETY APPLICATION

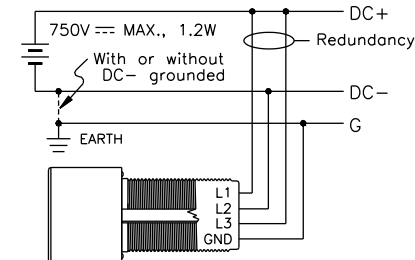

DC SPLIT SUPPLY 3W + GND

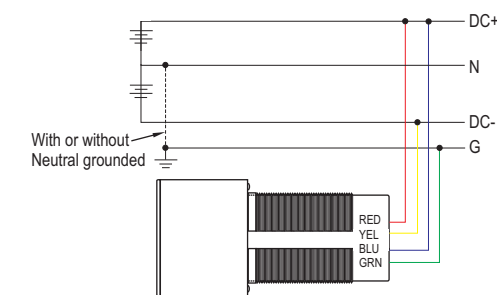

DC SINGLE SOURCE, 2W ONLY NON-SAFETY APPLICATION

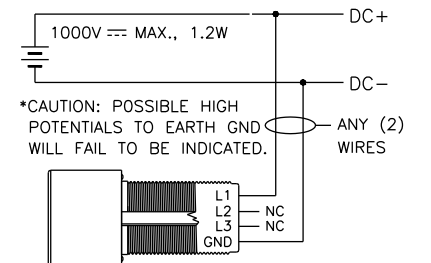

R-3W SERIES TRUTH TABLE

Condition	L1	L2	L3	GND
Color	Red	Red	Red	Red
Normal: Delta System with Isolated Ground	●	●	●	⊗
Normal with Ø to Ground Leakage	●	●	●	●
Ø Loss: L2 Open with Isolated Ground (Separately derived, standalone ground system)	●	⊗	●	●
Ø Unbal: Isolated Ground (Separately derived, standalone ground system)	●	●	●	●
Wye system with Grounded N (Not typically recommended for use with 4-Wire. Recommend using 5-Wire where applicable)				
L2 Loss: Wye System with Grounded N*	●	⊗	●	●
ØUnbal: Wye System with Grounded N*	●	●	●	●

On (illuminated)=● Off=⊗ Phase=Ø *Grounded N= N (Neutral) directly grounded or with resistance ground

FOR MORE INFORMATION VISIT PESD.COM OR CALL 1.800.280.9517

Warning: Verify an electrical conductor has been de-energized using an adequately rated test instrument before working on it. Follow appropriate Energy Control (Lockout/Tagout) procedures as per OSHA Subpart S.

© Grace Engineered Products, Inc. All rights reserved. Specifications are subject to change with/without notice.



R-3F2 MOUNTING DETAILS

Note: Vertical or side mount requires snap-in installation of respective mounting tabs (hardware included).

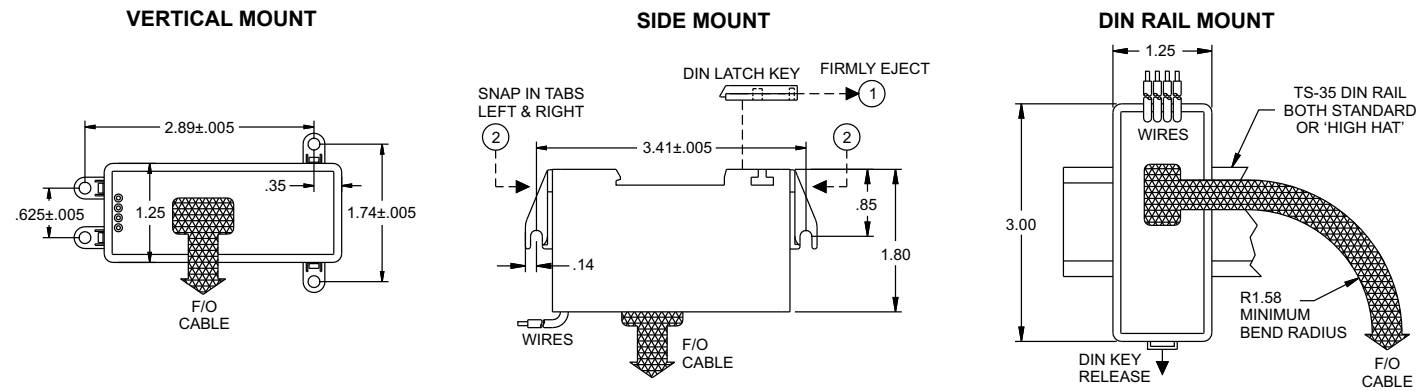

R-3F2 WIRING DETAILS

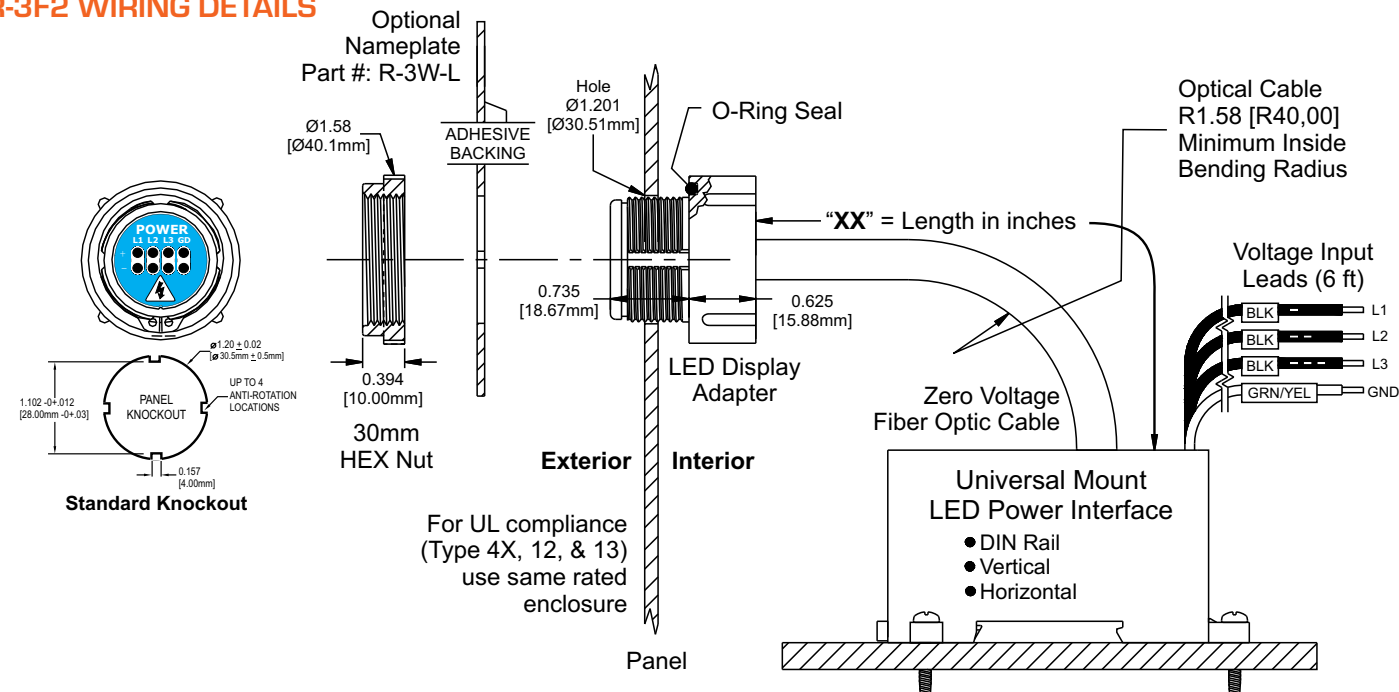

FOR MORE INFORMATION VISIT PESD.COM OR CALL 1.800.280.9517

Warning: Verify an electrical conductor has been de-energized using an adequately rated test instrument before working on it. Follow appropriate Energy Control (Lockout/Tagout) procedures as per OSHA Subpart S.

© Grace Engineered Products, Inc. All rights reserved. Specifications are subject to change with/without notice.



R-1V SERIES MEDIUM VOLTAGE INDICATOR



Medium Voltage Indicator assist the qualified personnel to visually verify the presence of voltage inside a MV cabinet. The indicator directly bolts on to the main busbar using a ½" ring style connector and uses capacitive coupling between the device and ground for completing the flashing circuit without a hardwired connection. The flash rate and the intensity of the indicator's LED is determined by the line voltage, distance to the adjoining phases, and distance of the ground plane. Flash rates of the indicators are optimized to alert at least once in every 3 seconds.*

Disclaimer: It is recommended that an installed medium voltage indicator flashes at least 20 times per minute. If the flash rate is less than 20 times per minute, do not use the product in this application.

R-1V SERIES MEDIUM VOLTAGE INDICATOR DETAILS

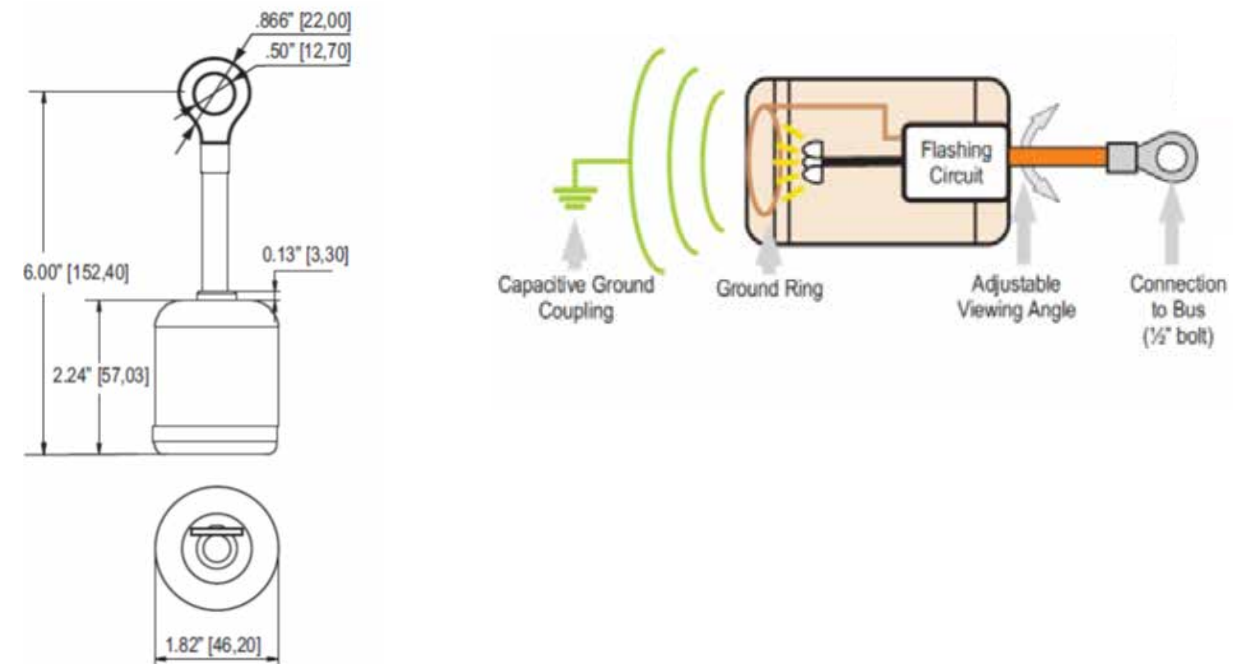

FOR MORE INFORMATION VISIT PESD.COM OR CALL 1.800.280.9517

Warning: Verify an electrical conductor has been de-energized using an adequately rated test instrument before working on it. Follow appropriate Energy Control (Lockout/Tagout) procedures as per OSHA Subpart S.

© Grace Engineered Products, Inc. All rights reserved. Specifications are subject to change with/without notice.

