

# MSR45E Safety Relay Expansion Module User Manual

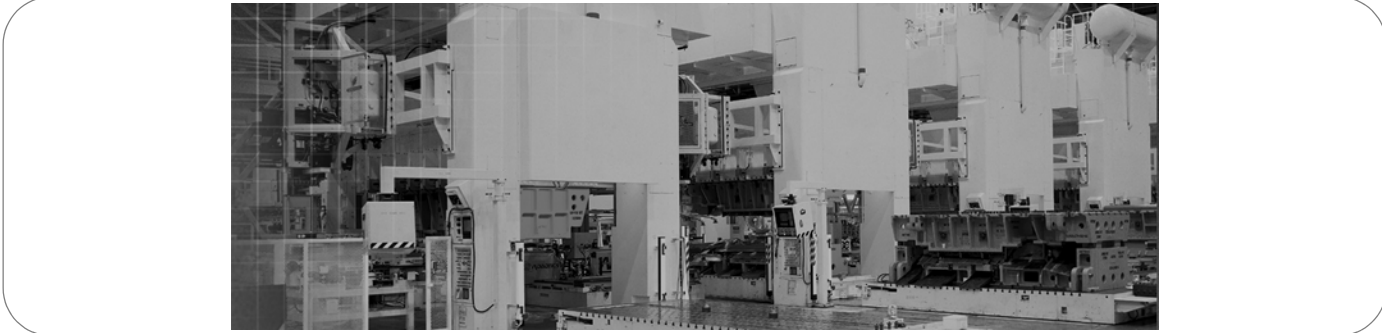

## Important User Information

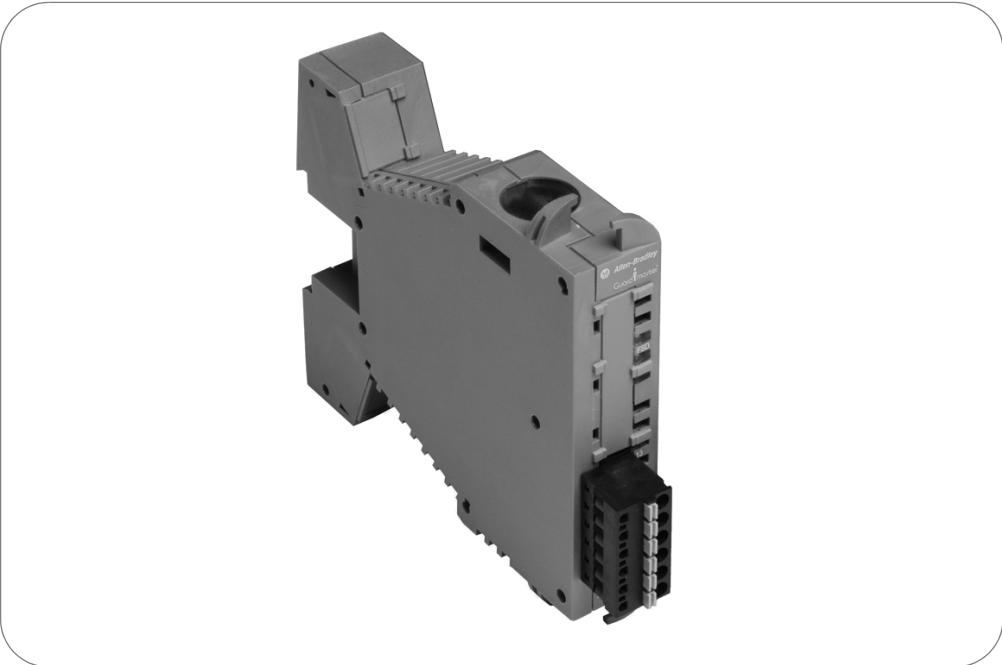



Because of the variety of uses for the products described in this publication, those responsible for the application and use of this control equipment must satisfy themselves that all necessary steps have been taken to assure that each application and use meets all performance and safety requirements, including any applicable laws, regulations, codes and standards.

The illustrations, charts, sample programs and layout examples shown in the guide are intended solely for purposes of example. Since there are many variables and requirements associated with any particular installation, Rockwell Automation does not assume responsibility or liability (to include intellectual property liability) for actual use based upon the examples shown in this publication.

Rockwell Automation publication SGI-1.1, Safety Guidelines for the Application, Installation and Maintenance of Solid-State Control (available from your local Rockwell Automation sales office), describes some important differences between solid-state equipment and electromechanical devices that should be taken into consideration when applying products such as those described in this publication.

Reproduction of the contents of this copyrighted publication, in whole or part, without written permission of Rockwell Automation, is prohibited.

Throughout this manual we use notes to make you aware of safety considerations:

<b>WARNING</b> 	Identifies information about practices or circumstances that can cause an explosion in a hazardous environment, which may lead to personal injury or death, property damage, or economic loss.
<b>IMPORTANT</b>	Identifies information that is critical for successful application and understanding of the product.
<b>ATTENTION</b> 	Identifies information about practices or circumstances that can lead to personal injury or death, property damage, or economic loss. Attentions help you identify a hazard, avoid a hazard, and recognize the consequences.
<b>SHOCK HAZARD</b> 	Labels may be on or inside the equipment (for example, drive or motor) to alert people that dangerous voltage may be present.
<b>BURN HAZARD</b> 	Labels may be on or inside the equipment (for example, drive or motor) to alert people that surfaces may reach dangerous temperatures.

It is recommended that you save this user manual for future use.

## Content

**Approvals and Conformity** ..... 1

**Introduction** ..... 1  
     Special features ..... 2

**Applications** ..... 2  
     Typical applications ..... 2  
     Application restrictions ..... 2

**Dimensions** ..... 2

**Terminal Configurations** ..... 2

**Connecting Hardware**..... 2

**LED display elements** ..... 2  
     MSR45E Expansion module ..... 2

**Selection tables** ..... 3

**Accessories / Components**..... 3

**Inspection and service** ..... 3  
     Inspections ..... 3  
     Decommissioning ..... 3

**Product labels**..... 3

**Technical Data**..... 4  
     Arc-limiting graph ..... 5

**Appendix** ..... 6

**EC Declaration of Conformity**..... 7

## Approvals and Conformity

The safety approval, performed by TÜV Rheinland is available on [www.ab.com](http://www.ab.com). The actual list of relevant safety data and applied standards is given in these documents.

### ATTENTION



MSR42, MSR41 or MSR45E units can only achieve their function as a safety controller module, if the instructions given in this instruction manual and the within mentioned documents are exactly followed, as well as consulting the valid laws and regulations at the time of installation. Should these instructions not be carefully followed, serious injury or death may occur. The installer or system integrator is responsible for a safe integration of this product. This instruction manual is to be used in conjunction with the MSR42, MSR41 and MSR45E module. It must be kept accessible together with the other machine documentation during its entire life cycle for all personnel responsible for assembly, installation, operation and maintenance.

## Introduction

The MSR4x is a family of compact safety modules. The main controlling module allows the connection and the control of the GuardShield Micro400 safety light curtain systems (Figure 1). Depending on the configuration, other safety components can also be connected and monitored simultaneously.

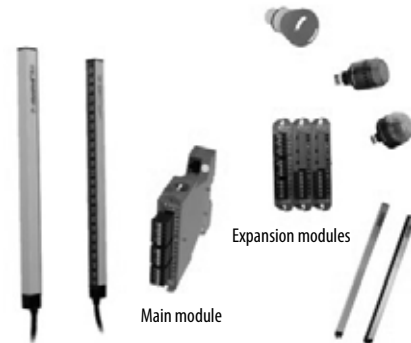

Figure 1: MSR42 controller with all safety components which can be connected (depending on individual configuration)

Both the MSR42 and MSR41 offer two safety PNP outputs. Additional safety relay expansion modules can be applied for applications, which require more outputs (MSR41 or 42) and/or dry contacts (MSR45e) to switch loads. Up to three expansion modules can be controlled and daisy chained to one main module.

In addition to the expansion relays, models are offered in special configurations which are described in the appendix at the end of this manual.

Note: The MSR45E safety relay expansion module is not a standalone safety relay module. It can only be used in conjunction with either an MSR41 or MSR42 control module.

**Special features**

The outstanding characteristics of the MSR42 and MSR41 controller:

- Category 4, PL e according EN ISO 13849-1
- Type 4 according EN 61496-1/-2
- SIL 3 according IEC 61508
- SIL CL 3 according EN 62061
- Short response times
- Up to 3 safety relay expansion modules per main module
- Adjustable stop delay time
- Different safety components suitable for connection (MSR42)

**Applications**

**Typical applications**

MSR42 and MSR41 controller modules are developed and conceived for typical applications like:

- Presses
- Robotic cells with automatic insertion
- Assembly lines
- Indexing tables
- Conveyor systems
- Automatic storage facilities

**Application restrictions**

All MSR4x modules are not intended for application in explosive (EX) or in radioactive environments.

**Dimensions**

The dimensions of the housing for MSR45E are illustrated in Figure 2.

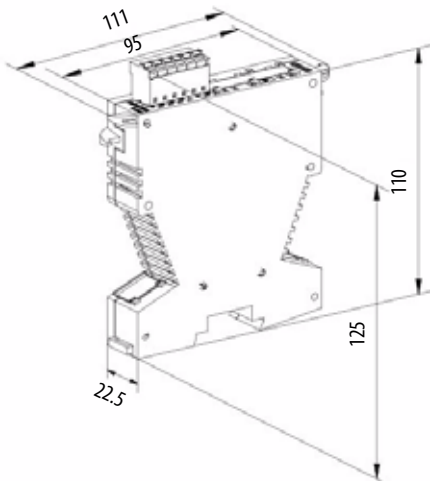

Figure 2: Expansion module dimensions are the same for main module

**Terminal Configurations**

The safety output contact configuration of the MSR45E.

Snap control & expansion housing module together. Use ribbon cable to electronically link devices.

Type of Expansion module	Schematic
MSR45E Safety Relay Expansion Cat.-No. 440-P4NANAS	

Figure 3: MSR45E Expansion module.

**Connecting Hardware**

**Main module + one Expansion module**



Figure 4: Ribbon Cable for one expansion module. (Cat. No 440R-ACAB1)



Figure 5: Ribbon cable for two expansion modules.

**LED display elements**

**MSR45E Expansion module**

Only two LED is integrated in the MSR45E expansion modules (FSD):

Color LED "FSD"	Status
Green	Corresponding contacts of module are closed (active)
Red	Corresponding contacts of module are opened (not active, NC contact)

Color LED "FSD"	Status
Off	No power at main module or no internal bus (e.g. no ribbon cable connection)

Table 1

## Selection tables

Cat. No.	Controller / Expansion modules
440R-P221AGS	MSR41 Micro400 controller
440R-P226AGS-NNR	MSR42 Light Curtain multifunction safety controller
440R-P4NANAS	MSR45E 2C, Standard Safety Relay Expansion Module

Table 2

## Accessories / Components







Cat. No.	Description
440R-ACABL1	Ribbon Cable – connects two modules 
440R-ACABL2	Ribbon Cable – connects three modules 
440R-ACABL3	Ribbon Cable – connects four modules 
440R-ATERM2P	Terminal Block Kit - MSR42 
440R-ATERM2C	Terminal Block Kit - MSR45E 
440R-ATERM1P	Terminal Block Kit – MSR41 

Table 3

## Inspection and service

The MSR45E modules have no serviceable components.

## Inspections

The MSR45E modules have to be tested periodically – in accordance with valid regulations - by qualified and trained personnel to discover prohibited manipulations or unauthorized modifications.

## Decommissioning

The MSR45E modules can only be removed, when the machine or the equipment is shut down completely and can no longer be operated without tools. If a controller has to be disposed, it can be simply dismantled. The separated materials can be recycled according to state of the art technology and corresponding regulations of the country it was used in.

## Product labels

All the necessary safety information can be found on the product labels, which can be found on every controller module (example):

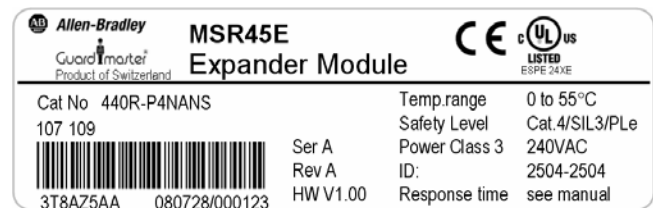

Figure 5: Product label MSR4E Expansion module

## Technical Data

General data	
Nominal working mode	Continuous process
Temperature range	Environment temp.: 0 ... +55°C Stock temp.: -25 ... +70°C
Enclosure rating according EN 60529	
Housing	IP20
Terminals	IP20
Conductor connection: 6-pin terminal strip	Wire cross section: max 2.5 mm <sup>2</sup> spring clamping technology min. 12 mm ferrule or wire length
Quick mounting	Top hat rail 35 mm (EN 50022)
Net weight	MSR45E: 150 g
Housing dimensions	111 x 22,5 x 125 mm (incl. plugs)
Housing material	Polyamide
Vibration according to EN60068-2-6	Amplitude: 0.35 mm Frequency: 10 ... 55 Hz
Shock resistant according to EN 60068-2-29	Acceleration: 100 ms <sup>-2</sup> Impulse length: 16 ms Number of shocks: 1'000 per direction
Installation position	No restrictions
Approvals	TÜV, CE, cULus

### Weight and packaging

Dispatch packaging	280 mm x 200 mm x 70 mm
Dispatch weight	Net weight + 220 g

### Relay Outputs of Expansion Modules

Max. number of expansion modules	3 per main module
Number of contacts	2NO, 3NO or 2NO1NC
Additional max. response time t(em) with U <sub>N</sub> protective mode	≤ 6 ms
Contact type	Relay, force guided (EN 50205)
Contact material	Ag <sub>2</sub> SnO <sub>2</sub> + 0.2 μm AU plated
Min. switching capacity	0.06 VA
Max. switching capacity	250 V(AC) 8A, [AC1] = 2'000 VA
Min. switching current	10 mA
Max. switching current	8 A
Max. switching voltage	2NO: AC 250V; DC 300V 3NO or 2NO1NC: AC 120V; DC 170V
Output nominal voltage	DC: see arc-limiting graph
2C:	
Continuous current I <sub>th</sub>	8 A (1 contact)
With simultaneous switching	
With 1 expansion-module	6 A (≥ 2 contacts)
With 2 or more exp.-modules	4 A (≥ 2 contacts)
Switching capacity acc. DC 13 (EN 60947-5-1, 0.1 Hz, 24 V)	MSR45E: 6 A DC / 24 V
Switching capacity acc. AC 15 (EN 60947-5-1, 0.1 Hz, 220 V)	2NO: 3A AC / 230V 3NO or 2NO1NC: 3A AC / 120V
Electronic lifespan according AC 15 at 2 A, 230 VAC	2C or 3C: 10 <sup>5</sup> operating cycles (EN 60947-5-1) see graphics below (arc limiting graph)
Allowed switching capacity	2C or 3C: Max. 900 switching / h
Mechanical lifespan	10 <sup>6</sup>

### Relay Outputs of Expansion Modules

Switch on delay after switching on the power supply	< 3 s
Switch off delay after switching off the power supply	< 40 ms

### Safety Related Parameter

Probability of a dangerous failure per hour PFH	6.0 E-9 1/h	MSR4x Main M. & MSR45e Ext & Micro400
	9.0 E-10 1/h	MSR4x Main M.
	3.0 E-10 1/h	MSR45E
	4.0 E-9 1/h	Micro400

## Arc-limiting graph

Characteristic curves for DC and AC applications (2C relay expansion module):

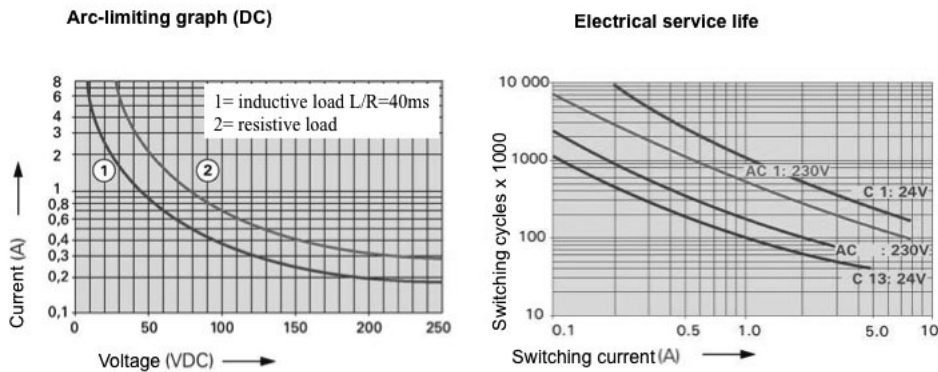

Figure 6: Arc-limiting graph and lifespan curve for MSR45E expansion modules (secure off switching, no standing arc, max. 1 operating cycle / s)

Characteristic curves for DC and AC applications (3C relay expansion module):

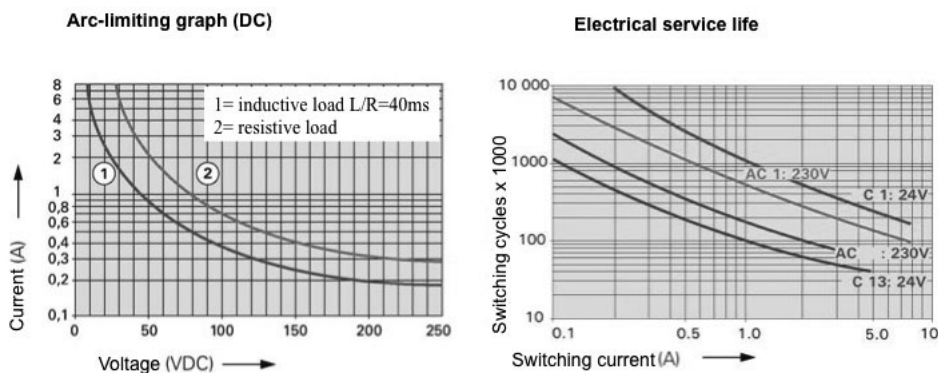

Figure 7: Arc-limiting graph and lifespan curve for MSR45E expansion modules (secure off switching, no standing arc, max. 1 operating cycle / s)

## Appendix

### Special MSR45E modules for existing customers.

#### Selection Table

Cat. No.	Controller / Expansion modules
445L-105938	MSR45E-3C 2NO1NC, special safety relay Expansion Module
445L-104860	MSR45E-3C 3NO, special safety relay Expansion Module

#### Terminal Configurations

Type of Expansion module	Schematic
MSR45E 3C 3NO Safety Relay Expansion Cat.-No. 445L-104860	
MSR45E 2NO1NC Safety Relay Expansion Cat.-No. 445L-105938  NC contacts are not safety contacts	

Figure 8: MSR45E Expansion modules.

<b>ATTENTION</b> 	<p>The normally-closed contacts (NC) of an expansion module may only be used for status feedback from the machine controller. They may not be used for any safety function. Any integration with a machine's safety circuit is not allowed.</p>
----------------------	---



**Rockwell  
Automation**

### EC Declaration of Conformity

<p>The undersigned, representing the manufacturer</p> <p><b>Rockwell Automation, Inc.</b> 2 Executive Dr. Chelmsford, MA 01824 USA</p>	<p>and the authorised representative established within the Community</p> <p><b>Rockwell Automation BV</b> Rivium 1e Straat, 23 2909 LE Capelle aan den IJssel Netherlands</p>
<p>Herewith declare that the Products: <b>MSR4x Safety Base / MSR4xE Expander Controller Modules</b></p>	
<p>Product identification (brand and catalogue number/part number):</p>	<p><b>Allen-Bradley 440R-P and 445L-1 Series</b> (reference the attached list of catalogue numbers)</p>
<p>Product Safety Function</p>	<p><b>The MSR4x safety base control devices and the MSR4xE extension modules can be used in applications up to Safety Category 4 (EN 954-1)/ SIL3/SIL CL3 (EN 61508 / EN 62061) and PL e (EN ISO 13849-1).</b></p>
<p>are in conformity with the essential requirements of the following EC Directive(s) when installed in accordance with the installation instructions contained in the product documentation:</p>	
2006/42/EC	Machinery Directive
2004/108/EC	EMC Directive
<p>and that the standards and/or technical specifications referenced below have been applied:</p>	
EN 61496-1:2004 + A1:2008	Safety of machinery – Electro-sensitive protective equipment – Part 1: General requirements and tests
IEC 61496-2:2006	Safety of machinery – Electro-sensitive protective equipment – Part 2: Particular requirements for equipment using active opto-electronic protective devices (AOPD's)
EN ISO 13849-1:2008	Safety of machinery – Safety-related parts of control systems – Part 1: General principles for design
EN 61508 Parts 1-7:1998-2000	Functional safety of electrical/electronic/programmable electronic safety-related systems
EN 954-1:1997	Safety of machinery – Safety related parts of control systems – Part 1: General principles for design
EN 50178:1997	Electronic equipment for use in power installations
EN 62061:2005	Safety of machinery – Functional safety of safety-related electrical, electronic and programmable electronic control systems
EN 60204-1:2006	Safety of machinery – Electrical equipment of machines – General requirements
EN 61000-6-4:2007	Electromagnetic compatibility (EMC) – Part 6-4: Generic standards – Emission standard for industrial environments (Class A)
EN 61000-6-2:2005	Electromagnetic Compatibility (EMC) – Part 6-2: Generic standards – Immunity for industrial environments
Manufacturer:	Authorised Representative in the Community:
<p><i>Daniel L. Nachtigall</i></p>	
<p><i>Viktor Schiffer</i></p>	
<b>Signature</b>	<b>Signature</b>
Name: Daniel L. Nachtigall	Name: Viktor Schiffer
Position: Supv – Product Certification Engineering	Position: Engineering Manager
Date: 01-Mar-2011	Date: 08-Mar-2011

<i>Catalogue number <sup>1</sup></i>	<i>Series <sup>2</sup></i>	<i>Description</i>
440R-P221AGS		<i>MSR41 base module</i>
440R-P226AGS-NNR		<i>MSR42 base module</i>
445L-104794-B***		<i>MSR42 base module customer configuration</i>
440R-P4NANS		<i>MSR45E expander module</i>
445L-1****		<i>MSR45E expander module customer configuration</i>

- 1) \*Denotes characters representing options that do not impact the standards or directives cited on this DoC
- 2) If no series number is given, then all series are covered

Technical Support / Technische Unterstützung / Assistance technique / Assistenza tecnica / Asistencia técnica

ENGLISH	Installation of this product must not take place until the installer has obtained a copy of the manufacturer's instructions in a language which he can understand. This instruction sheet is available in multiple languages at <a href="http://rockwellautomation.com/literature">http://rockwellautomation.com/literature</a> .
DEUTSCH	Dieses Produkt darf erst installiert werden, wenn der Installateur eine Kopie der Instruktionen des Herstellers in der Sprache eingeholt hat, die er versteht. Diese Instruktionen sind mehrsprachig erhältlich unter: <a href="http://rockwellautomation.com/literature">http://rockwellautomation.com/literature</a> .
FRANÇAIS	Ce produit ne peut être installé avant l'obtention d'un duplicata des instructions du fabricant dans une langue compréhensible. La fiche d'instructions est disponible en plusieurs langues depuis le lien <a href="http://rockwellautomation.com/literature">http://rockwellautomation.com/literature</a> .
ITALIANO	Non si deve procedere all'installazione di questo prodotto fin quando l'installatore non abbia ottenuto una copia delle istruzioni del produttore in una lingua che l'installatore possa capire. La presente scheda di istruzioni è disponibile in linguaggi multipli sul sito web <a href="http://rockwellautomation.com/literature">http://rockwellautomation.com/literature</a> .
ESPAÑOL	Absténgase de instalar este producto a menos que el instalador disponga de un ejemplar de las instrucciones del fabricante en un idioma que pueda comprender. En <a href="http://rockwellautomation.com/literature">http://rockwellautomation.com/literature</a> puede encontrar esta hoja de instrucciones en varios idiomas.
PORTUGUÊS	A instalação deste produto não pode ser efectuada até que o montador tenha obtido uma cópia das instruções do fabricante numa língua que ele compreenda. Essa folha de instruções está disponível em diversas línguas em <a href="http://rockwellautomation.com/literature">http://rockwellautomation.com/literature</a> .
POLSKI	Nie należy przeprowadzać instalacji tego produktu aż do otrzymania przez monter instrukcji producenta w języku, który on rozumie. Te karty z instrukcjami są dostępne w wielu językach na: <a href="http://rockwellautomation.com/literature">http://rockwellautomation.com/literature</a> .
ČESKY	Instalace tohoto výrobku nesmí proběhnout, dokud instalující osoba neobdrží pokyny výrobce v jazyce, kterému rozumí. Tyto pokyny jsou k dispozici v několika jazycích na <a href="http://rockwellautomation.com/literature">http://rockwellautomation.com/literature</a> .
SVENSKA	Denna produkt får inte installeras förrän installatören har skaffat ett exemplar av tillverkarens instruktioner på ett språk som han/hon förstår. Detta instruktionsblad finns på flera språk på <a href="http://rockwellautomation.com/literature">http://rockwellautomation.com/literature</a> .
NEDERLANDS	Het product mag pas worden geïnstalleerd wanneer de monteur beschikt over een exemplaar van de instructies van de fabrikant in een voor hem begrijpelijke taal. Dit instructieblad is in diverse talen verkrijgbaar op <a href="http://rockwellautomation.com/literature">http://rockwellautomation.com/literature</a> .
繁體中文	安裝者須取得其所通曉語言之產品說明書後方可進行本產品的安裝。各語言版本的產品說明書可透過以下連結獲取: <a href="http://rockwellautomation.com/literature">http://rockwellautomation.com/literature</a> 。
简体中文	安装者须取得其所通晓语言的产品说明书后方可进行本产品的安装。各语言版本的产品说明书可通过以下链接获取: <a href="http://rockwellautomation.com/literature">http://rockwellautomation.com/literature</a> 。
日本語	この製品の取付けは取付け者が理解できる言語で書かれたメーカーの取扱説明書を入手するまで行わないで下さい。この説明書は <a href="http://rockwellautomation.com/literature">http://rockwellautomation.com/literature</a> で複数の言語で提供されています
БЪЛГАРСКИ	Това устройство не трябва да се монтира, докато монтажника не разполага с инструкциите на производителя, на разбираем за него език. Инструкциите за монтаж ще намерите на различни езици в <a href="http://rockwellautomation.com/literature">http://rockwellautomation.com/literature</a> .
EESTI	Selle toote installatsioon ei tohi toimuda enne kui installeerija on omandanud koopia tootja instruksioonidega keeles mida ta ise valdab. Instruksioonid erinevates keeltes on saadaval siin: <a href="http://rockwellautomation.com/literature">http://rockwellautomation.com/literature</a> .
SUOMI	Tämä tuote voidaan asentaa vasta kun asentaja on hankkinut valmistajan ohjeet kielellä, jota hän ymmärtää. Erikieliset ohjeet ovat ladattavissa sivustolta <a href="http://rockwellautomation.com/literature">http://rockwellautomation.com/literature</a> .
ΕΛΛΗΝΙΚΑ	Εγκατάσταση του προϊόντος αυτού δεν πρέπει να γίνει πριν ο εγκαταστάτης προμηθευθεί αντίτυπο οδηγιών του κατασκευαστή σε γλώσσα που ο ίδιος καταλαβαίνει. Το εγχειρίδιο αυτό διατίθεται σε διάφορες γλώσσες στη διεύθυνση <a href="http://rockwellautomation.com/literature">http://rockwellautomation.com/literature</a> .
MAGYAR	Ez a termék csak akkor helyezhető üzembe, ha az üzembehelyezést végző személy rendelkezésére áll a gyártó használati utasítása az általa ismert nyelven. Az utasítás több nyelven megtalálható itt: <a href="http://rockwellautomation.com/literature">http://rockwellautomation.com/literature</a>
ÍSLENSKA	Uppsetning á þessari vöru má ekki eiga sér stað fyrr en sá sem annast uppsetninguna hefur fengið afrit af leiðbeiningum framleiðanda á því tungumáli sem hann þekkir. Leiðbeiningarþessi eru tilgætur á mörgum tungumálum og er hægt að ná í hann hér: <a href="http://rockwellautomation.com/literature">http://rockwellautomation.com/literature</a>
LATVIEŠU VALODA	Šī ražojuma uzstādīšanu nedrīkst veikt, pirms uzstādītājs nav saņēmis ražotāja instrukcijas tādā valodā ko viņš saprot. Šo instrukciju lapīnu var saņemt daudzās valodās no vietnes <a href="http://rockwellautomation.com/literature">http://rockwellautomation.com/literature</a>
LIETUVIŠKAI	Šito produkto įrengimas negali būti vykdomas tol, kol įrengėjas neturės gamintojo instrukcijų kopijos ta kalba, kurią jis supranta. Instrukciją galima rasti įvairiomis kalbomis tinklapyje <a href="http://rockwellautomation.com/literature">http://rockwellautomation.com/literature</a>
MALTI	L-installazzjoni ta' dan il-prodott mgħandux isir qabel ma l-installatur jakwista kopja tal-istruzzjonijiet tal-manifattur f'lingwa li tista' tiftiehem. Il-karta tal-istruzzjonijiet hija disponibbli f'hafna lingwi f' <a href="http://rockwellautomation.com/literature">http://rockwellautomation.com/literature</a> .
NORSK	Dette produktet må ikke installeres før installatøren har bruksanvisningen på et behersket språk. Dette instruksjonsarket kan fås i flere språk på <a href="http://rockwellautomation.com/literature">http://rockwellautomation.com/literature</a> .
ROMÂNĂ	Produsul nu trebuie să fie instalat până când cel care instalează produsul nu a obținut o copie a manualului de utilizare, în limba pe care o poate înțelege. Aceste instrucțiuni sunt valabile în mai multe limbi la adresa <a href="http://rockwellautomation.com/literature">http://rockwellautomation.com/literature</a> .
SLOVENSKY	Inštalácia tohto výrobku nesmie prebehnúť, dokiaľ inštalujúca osoba nedostane pokyny výrobcu v jazyku ktorému rozumie. Tieto pokyny sú k dispozícii v niekoľkých jazykoch na <a href="http://rockwellautomation.com/literature">http://rockwellautomation.com/literature</a> .
SLOVENŠČINA	Tega izdelka se ne sme nameščati, če si oseba, ki ga namešča, ni priskrbela izvoda proizvajalčevih navodil v jeziku, ki ga razume. Ta list z navodili v številnih jezikih je na razpolago na <a href="http://rockwellautomation.com/literature">http://rockwellautomation.com/literature</a> .
TÜRKÇE	Bu ürünün kurulmasını, ürünü kuracak kişinin üreticinin hazırladığı talimatların bir kopyasını, ki bu talimatlar bu kişinin anlayacağı bir dille olacaktır, elde edene kadar gerçekleştirilmesi gerekir. Bu talimatlar pek çok dilde şu web-sayfasında mevcuttur: <a href="http://rockwellautomation.com/literature">http://rockwellautomation.com/literature</a>

GuardShield is a trademark of Rockwell Automation, Inc.  
Guardmaster is a registered trademark of Rockwell Automation, Inc.

**[www.rockwellautomation.com](http://www.rockwellautomation.com)**

---

**Power, Control and Information Solutions Headquarters**

Americas: Rockwell Automation, 1201 South Second Street, Milwaukee, WI 53204 USA, Tel: (1) 414.382.2000, Fax: (1) 414.382.4444

Europe/Middle East/Africa: Rockwell Automation, Vorstlaan/Boulevard du Souverain 36, 1170 Brussels, Belgium, Tel: (32) 2 663 0600, Fax (32) 2 663 0640

Asia Pacific: Rockwell Automation, Level 14, Core F, Cyberport 3, 100 Cyberport Road, Hong Kong, Tel: (852) 2887 4788, Fax: (852) 2508 1846