

Bulletin 1609 Industrial Uninterruptible Power Supply

(Cat 1609-D)



ATTENTION: Please read and save these instructions. This manual contains important instructions for the Bulletin 1609 Uninterruptible Power Supply. Follow these instructions during the unpacking, installation and maintenance of the UPS. If you have a problem with the UPS, please refer to this manual and the User Manual trouble shooting section before calling Technical Services.

Contents for UPS Include:

- Installation Instruction
- 1609-D
- USB Cable
- CD
- 2 Battery Jumper Wires (inside the battery compartment)
- Battery Harness (inside the battery compartment)

Contents for 1609-EXBAT Include:

- Installation Instruction
- 1609-EXBAT
- Connector Cover
- 2 Screws
- 4 Battery Jumper Wires (inside the battery compartment)
- Battery Harness (inside the battery compartment)

Note: Batteries are not included with the UPS and 1609-EXBAT.

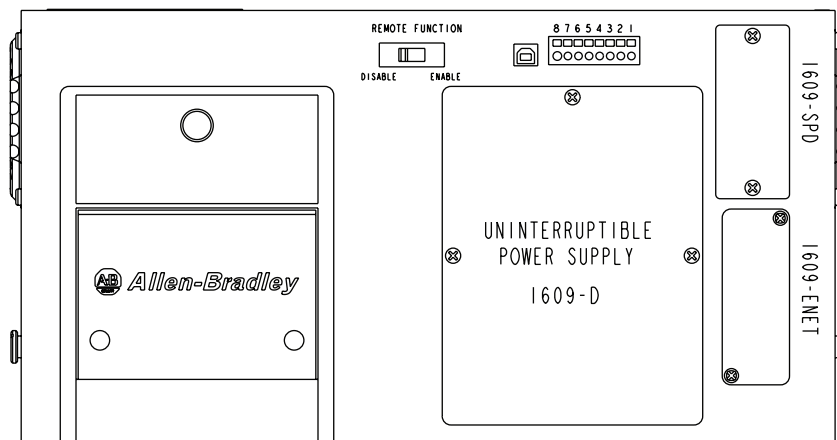

Additional Resources

1. Go to <http://www.rockwellautomation.com/literature>
2. Go to **Search**, select **Publication Number**.
3. Type the **Publication Number** in the search box and press enter.

1609-IN014 (1609-SPD Installation Instructions)

1609-IN015 (1609-ENET Installation Instructions)

1609-UM007 (1609 UPS Management Software User Manual)

1609-UM008 (1609 Network Management Card User Manual)

1609-UM009 (1609 UPS User Manual)

Install the 1609 UPS in the Appropriate Environment

Do not operate the UPS where there is excessive dust or the temperature or humidity is outside the specified limits. The maximum ambient temperature is 40 degree Celsius using the 1609-SBAT or 50 degree Celsius using the 1609-HBAT. The maximum humidity specification is 95% RH (Non-condensing).

Batteries Wiring and Installation Instruction for the UPS

Only use battery wires that have been provided with the UPS.



Warning: Do not service the 1609-SPD without disconnecting the power sources due to electric shock hazard for risk of severe injury or death.

1. To access the battery compartment remove the three screws and the battery door.

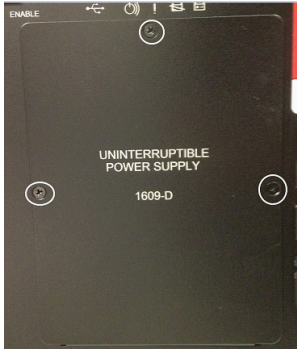

2. Remove the battery container, jumpers and wire harness from the battery compartment. Place the battery container and batteries onto a flat surface. Use the provided jumper wires to connect the batteries in series. Connect the positive terminal (red) of the battery to the negative terminal (black) of another battery. See photo below for details.

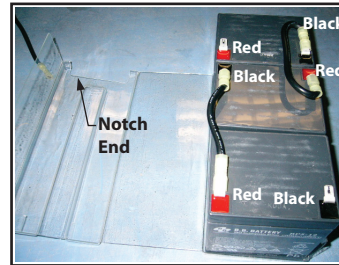

3. Connect the red wire of the harness to the positive terminal (top red) and the black wire of the harness to the negative terminal (bottom black). See photo below for details.

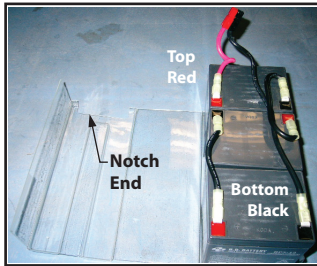

4. Fold the battery container and seal it with tape.

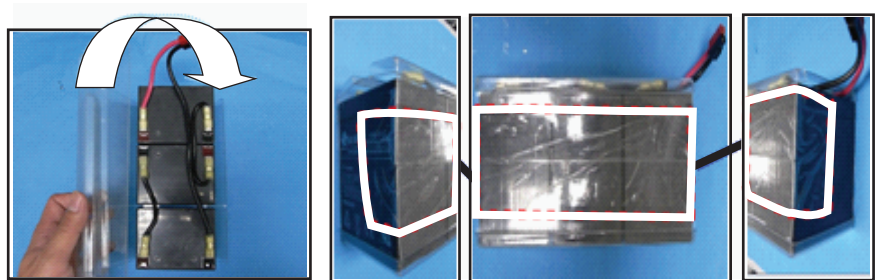

5. To connect the batteries to the UPS, insert the batteries into the battery compartment, open the white connector retainer and connect the two cables together as shown in the photo below.

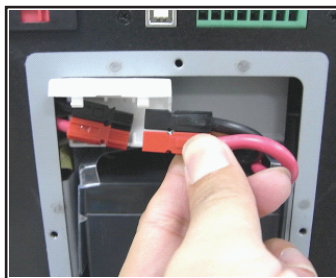

6. To complete the battery installation, close the white connector retainer and reattach the battery door with the three screws (torque of 8.7+/-1.7 lb-in).

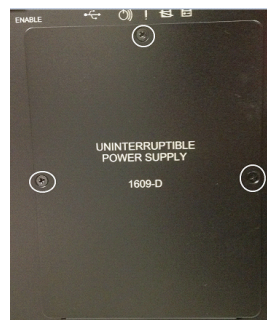

1609-EXBAT Batteries Wiring and Installation Instruction Only

Only use battery wires that have been provided with the 1609-EXBAT.



Warning: A disconnect switch shall be provided by others for DC output circuit. To reduce the risk of fire, connect only to a circuit provided with branch circuit overcurrent protection for 35 amperes rating in accordance with the National Electric Code, ANSI/NFPA 70"

Before connecting a battery pack to UPS, the emergent disconnecting device shall be provided between the UPS and battery pack.

1. To access the battery compartment remove the six screws and the battery door.

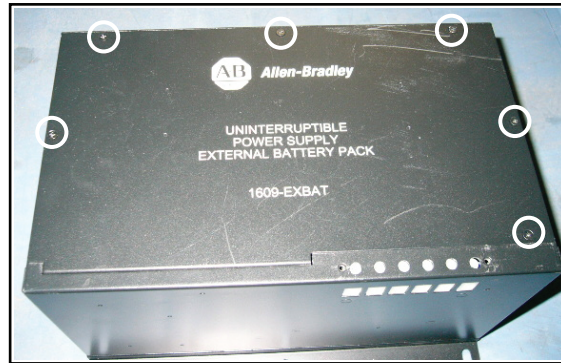

2. Remove the battery container, jumpers and wire harness from the battery compartment. Place the battery container and batteries onto a flat surface. Use the provided jumper wires to connect the batteries in series. Connect the positive terminal (red) of the battery to the negative terminal (black) of another battery. See photo below for details.

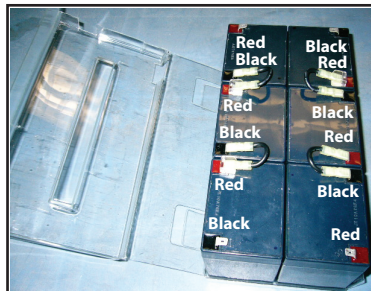

3. Connect the shorter set of red and black wires of the harness to the top terminals (red – to – red and black – to – black). Connect the longer set of red and black wires of the harness to the bottom terminals (red – to – red and black – to – black) and route the wires through the cut-out hole. See photo below for details.

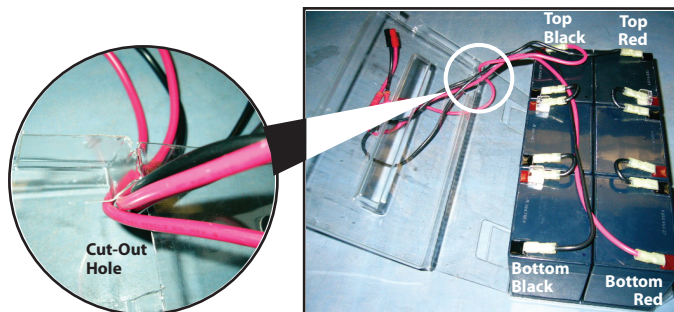

4. Fold the battery container and seal it with tape.

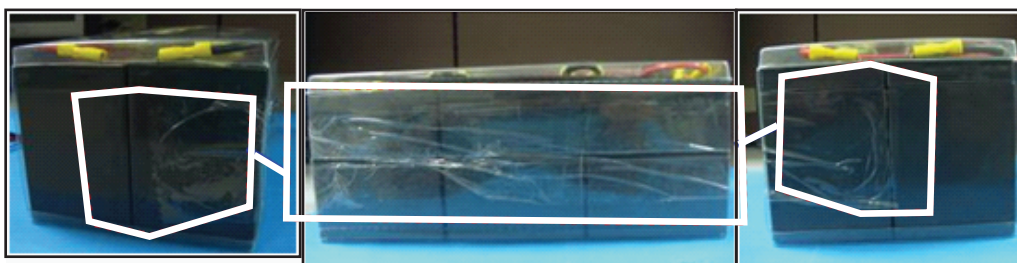

5. Insert the batteries into the battery compartment in the orientation as shown in the photo below.

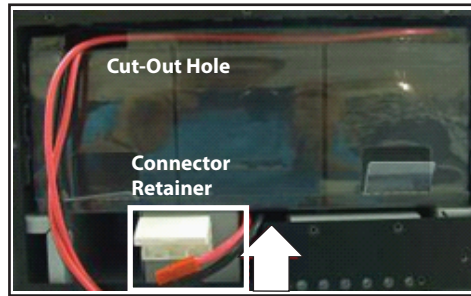

6. Open the white connector retainer and connect the two cables together as shown in the photo below.

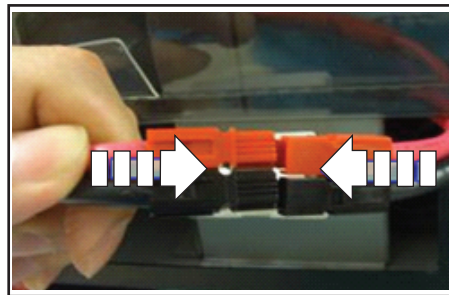

7. To complete the battery installation, insert the surplus wire harness into the free space, close the white connector retainer and reattach the battery door with the six screws (torque of 8.7+/-1.7 lb-in).

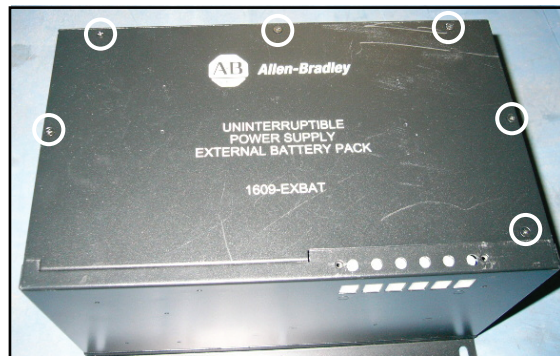

Mount the UPS

The UPS-D is designed to mount on the back of the panel or to the floor of the enclosure. The UPS mounts to a bracket assembly (1609-BRK) that allows it to mount to either the panel or floor (see Diagram 1 below).

Diagram 1

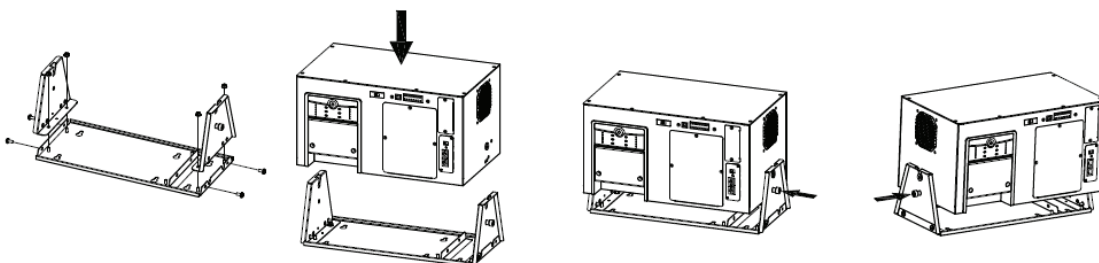

Hardwire UPS

Wiring of the UPS should be performed by a qualified electrician using the appropriate wire gauges.

Selection of Cables:

AC Main Input / Output Wiring for UPS:

Item	Specification
Wire size	14 AWG
Minimum temperature	75°C
Wire conductor material	Copper only
Tightening torque for terminals	4.4 lb-in

DC Input / Output Wiring for External Battery Cabinet:

Item	Specification
Wire size	10 AWG
Minimum temperature	75°C
Wire conductor material	Copper only
Tightening torque for terminals	12 lb-in



Warning: To reduce the risk of fire, connect only to a circuit provided with 20 amperes maximum branch circuit overcurrent protection in accordance with the National Electric Code, ANSI/NFPA 70.

A disconnect switch shall be provided by others for AC output circuit. To reduce the risk of fire, connect only to a circuit provided with branch circuit overcurrent protection for 20 amperes rating in accordance with the National Electric Code, ANSI/NFPA 70.

Connect Power and Equipment to the UPS



Warning: This UPS features Surge Protective Device (SPD) located on the front of the unit. Please disconnect all power sources before servicing due to Electric Shock Hazard for risk of severe injury or death.'

1. Connect the appropriate input power to the UPS's input (Line, Neutral and Ground) terminals (see Diagram 2).
2. Connect the specified equipment to the UPS's output (Line, Neutral and Ground) terminals (see Diagram 2).

Diagram 2 - System Wiring

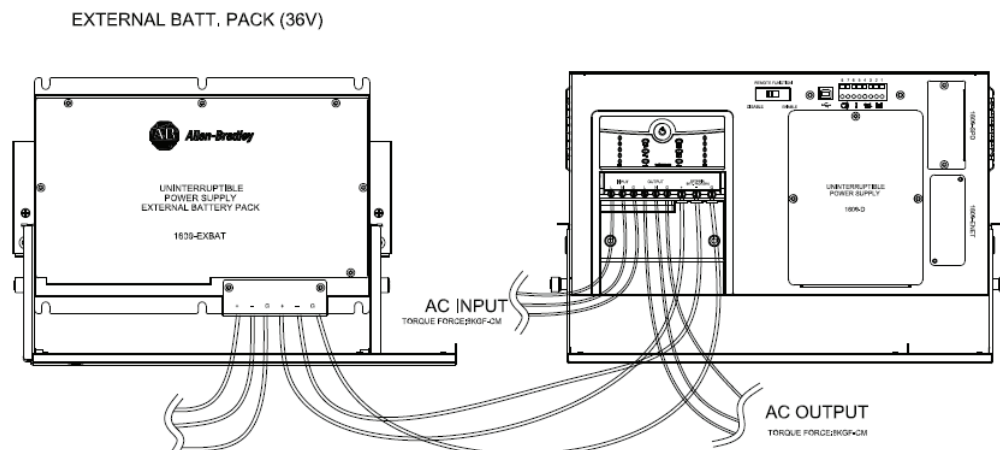

3. Connect any additional optional accessories (1609-ENET card).

Connect 1609-EXBAT to the UPS

The 1609-D can be used with the External Battery Unit (1609-EXBAT). The 1609-EXBAT is designed to mount to a heavy duty din-rail (see Diagram 3) or the optional mounting bracket assembly (1609-BRK) which will allow it to mount to either the panel or floor (see Diagram 4).

To install the 1609-EXBAT with the 1609-D UPS, connect the three 10 AWG wires from the 1609-EXBAT terminals to the 1609-D terminals marked as 'EXTERNAL BATT PACK (36V)' (see Diagram 2).

Dispose of used batteries according to the battery instructions.

Diagram 3 - Heavy Duty DIN Rail Mount

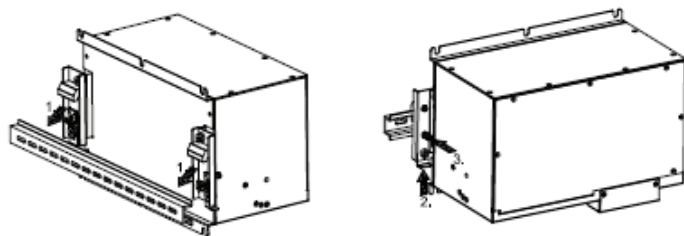
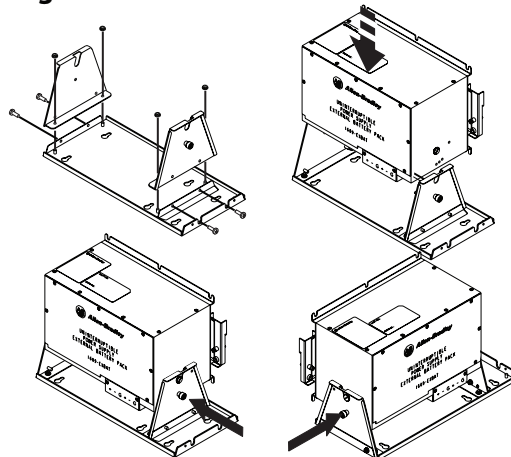

Diagram 4 - Panel or Floor Mount



Service Instructions

- a) Servicing of batteries should be performed or supervised by personnel knowledgeable of batteries and the required precautions. Keep unauthorized personnel away from the batteries.
- b) When replacing batteries, replace with the same number of the 1609 battery packs supplied by Rockwell Automation.



Warning: Do not dispose of battery or batteries in a fire. The battery may explode. Do not open or mutilate the battery or batteries. Released electrolyte is harmful to the skin and eyes. It may be toxic. A battery can present a risk of electrical shock and high short circuit current.

The following precautions should be observed when working on batteries:

- 1) Remove watches, rings, or other metal objects.
- 2) Use tools with insulated handles.
- 3) Do not lay tools or metal parts on top of batteries.
- 4) Determine if battery is inadvertently grounded. If inadvertently grounded, remove source from ground. Contact with any part of a grounded battery can result in electrical shock. The likelihood of such shock can be reduced if such grounds are removed during installation and maintenance.

Recommended Battery for use with the UPS and External Battery Cabinet

Rockwell Automation battery catalog numbers 1609-SBAT and 1609-HBAT consists of the battery manufacturers listed below:

Manufacturer	Type	Rating
B & B Battery (USA) INC. (MH19884)	HRL5.5 - 12	12 Vdc, 2.75 Ah
	BP 5-12	12 Vdc, 5.0 Ah
	HR5.5 - 12	12 Vdc, 2.75 Ah
	SHR7 - 12	12 Vdc, 3.375 Ah
GS Yuasa International Ltd. (MH12970)	NPH5 - 12	12 Vdc, 5.0 Ah
Shenzhen Center Power Tech. Co., Ltd. (MH25860)	CP1250	12 Vdc, 5.0 Ah
Shenzhen Ritar Power Co., Ltd. (MH28539)	RT1250	12 Vdc, 5.0 Ah
CSB Battery Co., Ltd. (MH14533)	HR1221W	12 Vdc, 5.25 Ah

Not for use in a computer room as defined in the Standard for the Protection of Electronic Computer/Data Processing Equipment, ANSI/NFPA 75.

Refer to NEC Table C.1 for North America market application. If using 3 x 10 AWG wires (excluding the wire type RHH), the suggested trade size for EMT is 1/2 inch and knockout hole diameter dimension of 22.2 mm.

Dispose of used batteries according to the battery instructions.

Dry I/O Contacts

There is one Remote Enable/Disable Switch connection and 3 Dry I/O Contacts available on the front of the UPS. Do not apply external power to the Remote Enable/Disable Switch; however, the 3 sets of Dry Contacts required external power supplies (Contacts Rating is 1A/24 Vdc). Each of the dry contacts is used to provide a remote status indication of the UPS, as follows:

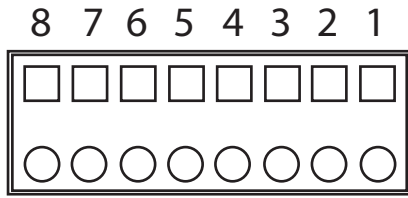

1 and 2 On Battery Contact (NO)

3 and 4 Low Battery Contact (NO)

5 and 6 Fault

(Indicates UPS has faulted see the User Manual trouble shooting section)

7 and 8 Remote Enable/Disable

(Closed for Output Enable, Open for Output Disable)

USB Communication Port

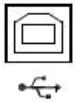

The UPS supports a USB communication port for the end user to connect with a computer. The user may monitor all the UPS status through the USB port if the 1609 UPS Management Software is installed in the computer. The software is stored in the CD and can be found in the accessory bag.

Manual or Remote Enable/Disable of UPS Output Selection

The 1609-D UPS output is designed to be manually or remotely Enabled or Disabled. User is required to enable or disable the remote function switch on the front panel.

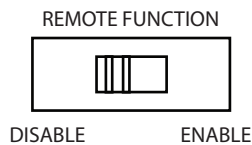

Selected 'DISABLE' for Manual Enable/Disable the UPS's Output.

Selected 'ENABLE' for Remote Enable/Disable the UPS's Output.

Manual Enable/Disable/Self-test

The Power Button on the front of the UPS is used to manually enable or disable the output of the 1609-D UPS.

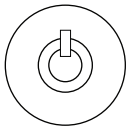

To enable the 1609-D UPS, press and hold the Power Button until one beep is heard.

To disable the 1609-D UPS, press and hold the Power Button until three beeps are heard then release immediately (takes approximately 3 seconds).

To perform a self-test, press and hold the Power Button until two beeps are heard then release immediately.

Remote Enable/Disable



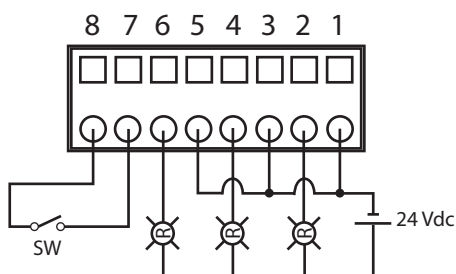



An external switch connected to the Dry I/O terminals 7 and 8 is required to remotely Enable or Disable the UPS output.



To enable the UPS, close the switch that is connected to the Dry I/O terminals 7 and 8.

To Disable the UPS, open the switch that is connected to the Dry I/O terminals 7 and 8.

Display LED indicators

Indicator LED	Indicator Title	Description
	On-Line	The UPS is supplying utility power to the connected equipment (see the User Manual trouble shooting section).
	AVR Trim	The UPS is compensating for a high utility voltage (see the User Manual trouble shooting section).
	AVR Boost	The UPS is compensating for a low utility voltage (see the User Manual trouble shooting section).
	On Battery	The UPS is supplying battery power to the connected equipment.
	Overload	The connected equipment is drawing more than the UPS power rating allows (see the User Manual trouble shooting section).
	Replace Battery / Battery Disconnected	The battery is disconnected or must be replaced (see the User Manual trouble shooting section).

Block Diagram

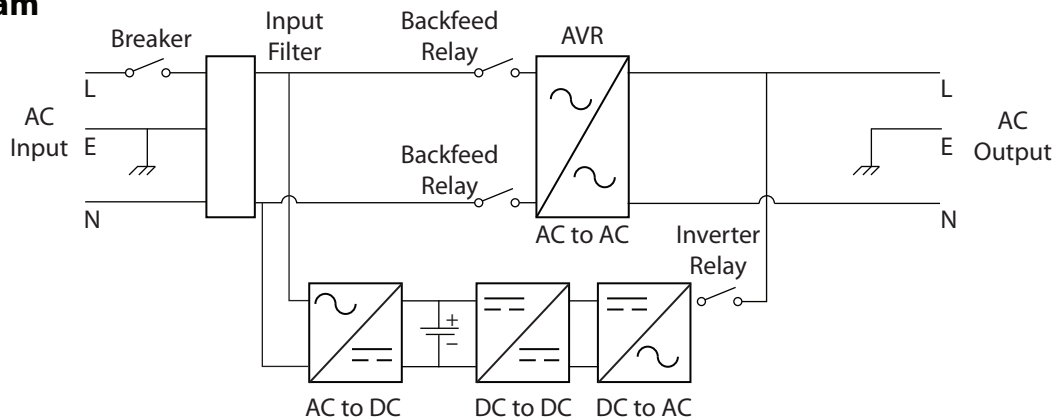

Service



ATTENTION: Always disconnect the battery(s) before shipping in compliance with U.S. Department of Transportation (DOT) and IATA regulations. The battery(s) may remain in the UPS.

If the UPS requires service do not return it to the dealer. Follow these steps:

1. Review the problems discussed in the troubleshooting section of the 1609 UPS User Manual to eliminate common problems.
2. If the problem persists, contact Rockwell Automation Customer Support at **440-646-5800**.
3. Pack the UPS in its original packaging.
 - Pack the UPS properly to avoid damage in transit. Never use Styrofoam beads for packaging.
 - Damage sustained in transit is not covered under warranty.

Allen-Bradley, Rockwell Software, and Rockwell Automation are trademarks of Rockwell Automation, Inc. Trademarks not belonging to Rockwell Automation are property of their respective companies.

www.rockwellautomation.com

Power, Control and Information Solutions Headquarters

Americas: Rockwell Automation, 1201 South Second Street, Milwaukee, WI 53204-2496 USA, Tel: (1) 414.382.2000, Fax: (1) 414.382.4444

Europe/Middle East/Africa: Rockwell Automation NV, Pegasus Park, De Kleetlaan 12a, 1831 Diegem, Belgium, Tel: (32) 2 663 0600, Fax: (32) 2 663 0640

Asia Pacific: Rockwell Automation, Level 14, Core F, Cyberport 3, 100 Cyberport Road, Hong Kong, Tel: (852) 2887 4788, Fax: (852) 2508 1846